

Hitachi Virtual Storage Platform G/F350, G/ F370, G/F700, G/F900

SVOS RF 8.3.1

REST API Reference Guide

This document describes how to use the Web API, which follows the principles of Representational State Transfer (REST), for getting information or changing the configuration of the following storage systems: Hitachi Virtual Storage Platform F350, F370, F700, F900 all-flash arrays and Hitachi Virtual Storage Platform G350, G370, G700, G900 storage systems.

© 2018, 2019 Hitachi, Ltd. All rights reserved.

No part of this publication may be reproduced or transmitted in any form or by any means, electronic or mechanical, including copying and recording, or stored in a database or retrieval system for commercial purposes without the express written permission of Hitachi, Ltd., or Hitachi Vantara Corporation (collectively "Hitachi"). Licensee may make copies of the Materials provided that any such copy is: (i) created as an essential step in utilization of the Software as licensed and is used in no other manner; or (ii) used for archival purposes. Licensee may not make any other copies of the Materials. "Materials" mean text, data, photographs, graphics, audio, video and documents.

Hitachi reserves the right to make changes to this Material at any time without notice and assumes no responsibility for its use. The Materials contain the most current information available at the time of publication.

Some of the features described in the Materials might not be currently available. Refer to the most recent product announcement for information about feature and product availability, or contact Hitachi Vantara Corporation at https://support.hitachivantara.com/en_us/contact-us.html.

Notice: Hitachi products and services can be ordered only under the terms and conditions of the applicable Hitachi agreements. The use of Hitachi products is governed by the terms of your agreements with Hitachi Vantara Corporation.

By using this software, you agree that you are responsible for:

1. Acquiring the relevant consents as may be required under local privacy laws or otherwise from authorized employees and other individuals; and
2. Verifying that your data continues to be held, retrieved, deleted, or otherwise processed in accordance with relevant laws.

Notice on Export Controls. The technical data and technology inherent in this Document may be subject to U.S. export control laws, including the U.S. Export Administration Act and its associated regulations, and may be subject to export or import regulations in other countries. Reader agrees to comply strictly with all such regulations and acknowledges that Reader has the responsibility to obtain licenses to export, re-export, or import the Document and any Compliant Products.

Hitachi and Lumada are trademarks or registered trademarks of Hitachi, Ltd., in the United States and other countries.

AIX, AS/400e, DB2, Domino, DS6000, DS8000, Enterprise Storage Server, eServer, FICON, FlashCopy, IBM, Lotus, MVS, OS/390, PowerPC, RS/6000, S/390, System z9, System z10, Tivoli, z/OS, z9, z10, z13, z/VM, and z/VSE are registered trademarks or trademarks of International Business Machines Corporation.

Active Directory, ActiveX, Bing, Excel, Hyper-V, Internet Explorer, the Internet Explorer logo, Microsoft, the Microsoft Corporate Logo, MS-DOS, Outlook, PowerPoint, SharePoint, Silverlight, SmartScreen, SQL Server, Visual Basic, Visual C++, Visual Studio, Windows, the Windows logo, Windows Azure, Windows PowerShell, Windows Server, the Windows start button, and Windows Vista are registered trademarks or trademarks of Microsoft Corporation. Microsoft product screen shots are reprinted with permission from Microsoft Corporation.

All other trademarks, service marks, and company names in this document or website are properties of their respective owners.

Copyright and license information for third-party and open source software used in Hitachi Vantara products can be found at <https://www.hitachivantara.com/en-us/company/legal.html>.

EXPORT CONTROLS - Licensee will comply fully with all applicable export laws and regulations of the United States and other countries, and Licensee shall not export, or allow the export or re-export of, the Software, API or Materials in violation of any such laws or regulations. By downloading or using the Software, API, or Materials, Licensee agrees to the foregoing and represents and warrants that Licensee is not located in, under the control of, or a national or resident of any embargoed or restricted country.

Contents

Preface.....	14
Intended audience.....	14
Product version.....	14
Document conventions.....	14
Conventions for storage capacity values.....	16
Accessing product documentation.....	17
Getting help.....	17
Comments.....	17
Chapter 1: Overview of the REST API.....	18
System configuration of the REST API	18
Requirements for SSL communications.....	19
Specifying the resource to be managed.....	20
Specifying an object ID.....	24
Supported HTTP methods.....	26
User authentication.....	27
Session management.....	29
Request headers.....	30
Response headers.....	34
HTTP status codes.....	34
Request and response formats.....	36
Query parameters.....	38
Data type.....	39
Output format.....	40
Data object.....	41
Job object.....	42
Error object.....	45
Request object.....	50
Action template object.....	50
Locking resources.....	51
Chapter 2: Common operations in the REST API.....	55
Getting the version information.....	55
Getting a list of storage systems.....	56
Getting information about a specific storage system.....	57

Getting a list of sessions.....	60
Getting information about a specific session.....	62
Generating sessions.....	64
Discarding sessions.....	66
Getting a list of job information.....	67
Getting job information.....	71
Locking a resource group.....	73
Unlocking a resource group.....	75

Chapter 3: User management and access control.....77

Overview of user management and access control.....	77
Workflow for user management and access control.....	78
Input rules for user IDs and passwords.....	79
Getting a list of resource groups.....	80
Getting information about a specific resource group.....	87
Creating a resource group.....	90
Adding a resource to a resource group.....	92
Removing a resource from a resource group.....	95
Deleting a resource group.....	99
Getting a list of user groups.....	100
Getting information about a specific user group.....	102
Creating a user group.....	104
Changing the user group settings.....	108
Assigning resource groups to a user group.....	111
Releasing resource groups assigned to a user group.....	113
Deleting a user group.....	115
Getting a list of users.....	116
Getting information about a specific user.....	118
Creating a user account.....	120
Changing the password of the user.....	122
Adding users to user groups.....	124
Removing users from user groups.....	126
Deleting a user account.....	128

Chapter 4: Parity group management..... 130

Overview of a parity group.....	130
Getting information about parity groups.....	131
Getting information about a specific parity group.....	135
Getting a list of drive information.....	138
Getting information about a specific drive.....	146
Creating a parity group.....	148
Changing the drive settings.....	152

Changing the accelerated compression setting of a parity group.....	153
Formatting a parity group.....	155
Deleting a parity group.....	157

Chapter 5: Volume allocation..... 159

Overview of volume allocation.....	159
Getting information about the capacity of a storage system.....	160
Getting information about the total efficiency of a storage system.....	163
Getting volume information.....	167
Getting information about a specific volume.....	193
Creating a volume.....	194
Formatting a volume.....	199
Expanding the capacity of a volume.....	202
Changing the volume settings.....	205
Changing the volume status.....	211
Shredding a volume.....	214
Reclaiming zero pages of a DP volume.....	217
Changing the MP blade assigned to a volume.....	219
Deleting a volume.....	221
Getting port information.....	223
Getting information about a specific port.....	231
Getting information about host groups or iSCSI targets.....	239
Getting information about a specific host group or iSCSI target.....	249
Getting a list of host modes and host mode options.....	252
Creating a host group or an iSCSI target.....	254
Changing the host group or iSCSI target settings.....	258
Deleting a host group or the iSCSI target.....	261
Getting WWN information.....	262
Getting information about a specific WWN.....	264
Registering a WWN for the host group.....	266
Setting the nickname for a WWN.....	268
Deleting the WWN from a host group.....	270
Getting iSCSI names.....	271
Getting information about a specific iSCSI name.....	274
Registering the iSCSI name for the iSCSI target.....	276
Setting the nickname for an iSCSI name.....	278
Deleting the iSCSI name from the iSCSI target.....	279
Getting information about CHAP users.....	281
Getting information about a specific CHAP user.....	283
Setting the CHAP user name for the iSCSI target.....	285
Setting a secret for the CHAP user.....	286
Deleting the CHAP user from the iSCSI target.....	288

Getting information about LU paths.....	290
Getting information about a specific LU path.....	294
Sending the ping command to a specified host.....	297
Setting the LU path	299
Setting the priority levels of ALUA paths.....	301
Deleting a LU path.....	303
Setting the command device.....	304
Getting a list of MP information.....	308
Releasing the host reservation status by specifying the LU path.....	309
Releasing the host reservation status by specifying a host group.....	311
Chapter 6: Pool management.....	313
Overview of a pool.....	313
Getting pool information.....	314
Getting information about a specific pool.....	345
Creating a pool.....	361
Changing pool settings.....	366
Expanding a pool.....	371
Shrinking a pool.....	373
Performing performance monitoring of a pool.....	376
Performing tier relocation.....	378
Restoring a pool.....	380
Initializing the capacity saving function for a pool.....	381
Deleting a pool.....	382
Chapter 7: Optimizing I/O performance.....	384
Overview of optimizing I/O performance.....	384
Getting information about CLPRs.....	385
Getting information about a specific CLPR.....	387
Creating a CLPR.....	389
Changing the settings of a CLPR.....	390
Deleting a CLPR.....	393
Assigning LDEVs to a CLPR.....	394
Assigning parity groups to a CLPR.....	396
Getting information about external parity groups.....	398
Getting information about a specific external parity group.....	400
Assigning external parity groups to a CLPR.....	403
Changing the MP blade assigned to an external parity group.....	404
Getting a list of Server Priority Manager information.....	406
Getting Server Priority Manager information by specifying a volume and the WWN or iSCSI name of an HBA.....	409

Setting Server Priority Manager information by specifying a volume and the WWN or iSCSI name of the HBA.....	411
Changing the Server Priority Manager information.....	414
Deleting Server Priority Manager information.....	417

Chapter 8: Managing ShadowImage pairs.....420

Overview of ShadowImage.....	420
Workflow for operating ShadowImage pairs.....	422
Pair status (ShadowImage).....	424
Getting a list of copy groups.....	426
Getting information about a specific copy group.....	428
Getting a list of ShadowImage pairs.....	432
Getting information about a specific ShadowImage pair.....	435
Creating a ShadowImage pair.....	438
Splitting ShadowImage pairs in units of copy groups.....	443
Splitting a ShadowImage pair.....	445
Resynchronizing ShadowImage pairs in units of copy groups.....	448
Resynchronizing a ShadowImage pair.....	451
Restoring ShadowImage pairs in units of copy groups.....	453
Restoring a ShadowImage pair.....	455
Deleting a copy group.....	458
Deleting a ShadowImage pair.....	460

Chapter 9: Managing Thin Image pairs.....462

Overview of Thin Image.....	462
Workflow for operating Thin Image pairs.....	465
Pair status (Thin Image).....	467
Getting information about Thin Image pairs in units of snapshot groups.....	470
Getting information about Thin Image pairs in a specified snapshot group....	474
Getting information about Thin Image pairs.....	479
Getting information about a specific Thin Image pair.....	485
Creating a Thin Image pair.....	489
Storing snapshot data in units of snapshot groups.....	493
Storing snapshot data.....	495
Resynchronizing Thin Image pair in units of snapshot groups and deleting snapshot data.....	496
Resynchronizing a Thin Image pair and deleting snapshot data.....	499
Restoring snapshot data in units of snapshot groups.....	501
Restoring snapshot data.....	503
Assigning a secondary volume to snapshot data.....	505
Unassigning the secondary volume for snapshot data.....	507
Deleting Thin Image pairs in units of snapshot groups.....	509

Deleting a Thin Image pair.....	510
Deleting Thin Image pairs by snapshot tree.....	512
Cloning pairs in a specified snapshot group.....	513
Cloning a Thin Image pair.....	515
Chapter 10: Configuring a remote copy environment.....	518
Workflow for configuring a remote copy environment.....	518
Registering and deleting information about remote storage systems.....	520
Overview of registering and deleting information about remote storage systems.....	520
Getting a list of remote storage systems.....	521
Getting information about a specific remote storage system.....	523
Registering information about remote storage systems.....	526
Deleting information about remote storage systems.....	528
Setting remote connections.....	530
Overview of the remote connection settings.....	530
Getting a list of remote connections.....	531
Getting information about a specific remote connection.....	536
Creating a remote connection.....	539
Changing the remote connection settings.....	542
Adding remote paths to a remote connection.....	545
Deleting a remote path from a remote connection.....	547
Deleting a remote connection.....	549
Getting information about iSCSI ports.....	551
Getting information about a specific iSCSI port.....	554
Registering an iSCSI port.....	556
Removing the registration of an iSCSI port.....	559
Setting journals.....	561
Getting journal information.....	561
Getting information about a specific journal.....	568
Creating a journal.....	570
The mirror journal status.....	572
Changing journal settings.....	573
Adding a journal volume.....	576
Deleting a journal volume from a journal.....	578
Changing the MP blade assigned to a journal.....	580
Deleting a journal.....	581
Chapter 11: Managing TrueCopy pairs or Universal Replicator pairs.....	583
Overview of TrueCopy and Universal Replicator.....	583
Workflow for operating TrueCopy pairs or Universal Replicator pairs.....	584

Flow of recovery operations to be performed when a failure occurs at the primary site of a Universal Replicator pair.....	586
Pair status (TrueCopy and Universal Replicator).....	589
Getting a list of remote copy groups	593
Getting information about a specific remote copy group.....	596
Getting information about a specific remote copy pair.....	606
Creating a TrueCopy pair or Universal Replicator pair.....	613
Splitting TrueCopy pairs or Universal Replicator pairs in units of copy groups.....	622
Splitting a TrueCopy pair or Universal Replicator pair.....	627
Resynchronizing TrueCopy pairs or Universal Replicator pairs in units of copy groups.....	632
Resynchronizing a TrueCopy pair or Universal Replicator pair.....	639
Deleting TrueCopy pairs or Universal Replicator pairs in units of copy groups.....	646
Deleting a TrueCopy pair or Universal Replicator pair.....	648
Enabling volumes at the secondary site to take over work in units of copy groups.....	650
Enabling volumes at the secondary site to take over work in units of copy pairs.....	654
Chapter 12: Managing global-active device pairs.....	658
Overview of global-active device.....	658
Workflow for operating global-active device pairs.....	659
Pair status (global-active device).....	661
Getting a list of remote copy groups.....	666
Getting information about a specific remote copy group.....	668
Getting information about a global-active device pair.....	678
Getting information about a specific remote copy pair.....	683
Creating a global-active device pair.....	690
Deleting global-active device pairs in units of copy groups.....	695
Deleting a global-active device pair.....	698
Suspending global-active device pairs in units of copy groups.....	700
Suspending a global-active device pair.....	704
Resynchronizing global-active device pairs in units of copy groups.....	707
Resynchronizing a global-active device pair.....	713
Chapter 13: Performing Volume Migration operations.....	720
Overview of Volume Migration.....	720
Workflow for performing Volume Migration.....	722
Pair status transitions (Volume Migration).....	725
Creating a pair to be used for Volume Migration.....	727
Performing migration for an entire copy group.....	729

Performing migration.....	731
Getting a list of copy groups (Volume Migration).....	733
Getting information about a specific copy group (Volume Migration).....	734
Getting a list of pairs (Volume Migration).....	739
Getting information about a specific pair (Volume Migration).....	741
Deleting a pair (Volume Migration).....	744
Deleting a copy group (Volume Migration).....	745
Canceling migration for an entire copy group.....	747
Canceling migration.....	749

Chapter 14: Performing Universal Volume Manager operations ... 752

Overview of Universal Volume Manager.....	752
Workflow for Universal Volume Manager.....	754
Getting information about an iSCSI target of a port on an external storage system.....	759
Registering an iSCSI name of an external storage system to a port on the local storage system.....	762
Getting the iSCSI name of an external storage system that is registered to a port on the local storage system.....	764
Performing a login test on an iSCSI target of an external storage system that is registered to a port on the local storage system.....	767
Getting a list of ports on an external storage system.....	769
Getting a list of LUs defined for a port on an external storage system.....	772
Mapping an external volume.....	775
Getting a list of external path groups.....	778
Getting information about a specific external path group.....	787
Adding an external path to an external path group.....	794
Removing an external path from an external path group.....	797
Unmapping an external volume.....	799
Disconnecting from an external volume.....	801
Deleting an iSCSI name of an external storage system that is registered to a port on the local storage system.....	802

Chapter 15: Initial settings for a storage system..... 805

Overview of the initial settings of a storage system.....	805
Getting the system date and time of a storage system.....	805
Getting a list of time zones that can be used in a storage system.....	808
Setting the system date and time of a storage system.....	809
Uploading the files required for initial configuration.....	814
Getting information about the transfer destinations of audit log files.....	817
Specifying the transfer destinations of audit log files.....	820
Sending test messages to the transfer destinations of audit log files.....	827
Getting SNMP settings.....	829

Specifying the SNMP error notification destinations.....	836
Sending a test SNMP trap.....	846
Getting information about the error notification email settings.....	847
Specifying settings for error notification emails.....	850
Adding a destination address for error notification emails.....	858
Deleting a destination address for error notification emails.....	860
Sending a test error notification email.....	862
Getting a list of license information.....	863
Getting information about a specific license.....	867
Installing software.....	869
Enabling or disabling a license.....	870
Removing software.....	872
Chapter 16: Encrypting data.....	874
Overview of data encryption.....	874
Workflow for operations related to data encryption.....	875
Getting information about the encryption environment settings.....	879
Changing the encryption environment settings.....	881
Getting the number of encryption keys.....	883
Getting information about a list of encryption keys.....	884
Getting a specific encryption key.....	888
Creating encryption keys.....	890
Deleting an encryption key.....	892
Backing up encryption keys.....	893
Restoring encryption keys.....	895
Chapter 17: Monitoring storage systems.....	898
Getting a list of alert information.....	898
Getting information about the hardware installed in a storage system.....	902
Chapter 18: Managing resources by using virtual storage machines.....	918
Overview of managing resources by using virtual storage machines.....	918
Workflow for managing resources by using virtual storage machines.....	919
Getting a list of virtual storage machines.....	920
Getting information about a specific virtual storage machine.....	922
Creating a virtual storage machine.....	924
Deleting a virtual storage machine.....	926
Getting information about virtual LDEVs.....	927
Setting a virtual LDEV number.....	938
Deleting a virtual LDEV number.....	940

Chapter 19: Sample coding.....	943
Overview of sample coding.....	943
Sample coding for volume allocation.....	952
Sample coding for ShadowImage pair operations.....	966
Sample coding for registering remote storage system information.....	978
Sample coding for TrueCopy pair operations.....	991
Sample coding for uploading files (specifying the transfer destinations of audit log files).....	1007
Sample coding for downloading a file (backing up encryption keys).....	1021
Sample coding for re-creating a parity group (data encryption).....	1026
Functions used in the sample coding.....	1037
Appendix A: Notes and restrictions.....	1046
Notes and restrictions.....	1046
 Index.....	 1052

Preface

This document provides information and instructions to help you use the REST API.

The REST API provides the Web API, which follows the principles of Representational State Transfer (REST), for getting information about storage systems or changing the configuration of storage systems.

Please read this document carefully to understand how to use the REST API, and keep a copy of this document for reference.

Intended audience

This document is intended for system administrators and authorized service providers who are involved in configuring and operating any of the following storage systems: Hitachi Virtual Storage Platform F350, F370, F700, F900; Hitachi Virtual Storage Platform G350, G370, G700, G900.

Readers of this document should be familiar with the following:

- Data processing, as well as RAID storage systems and their basic functions
- The relevant storage systems of the following: Hitachi Virtual Storage Platform F350, F370, F700, F900; Hitachi Virtual Storage Platform G350, G370, G700, G900.
- Writing programs that use the REST API

Product version

This document revision applies to the following microcode or firmware:

- VSP F350, F370, F700, F900: firmware 88-03-25 or later
- VSP G350, G370, G700, G900: firmware 88-03-25 or later



Document conventions

This document uses the following typographic conventions:

Convention	Description
Bold	<ul style="list-style-type: none"> Indicates text in a window, including window titles, menus, menu options, buttons, fields, and labels. Example: Click OK. Indicates emphasized words in list items.
<i>Italic</i>	<ul style="list-style-type: none"> Indicates a document title or emphasized words in text. Indicates a variable, which is a placeholder for actual text provided by the user or for output by the system. Example: <pre>pairdisplay -g group</pre> <p>(For exceptions to this convention for variables, see the entry for angle brackets.)</p>
Monospace	Indicates text that is displayed on screen or entered by the user. Example: <code>pairdisplay -g oradb</code>
< > angle brackets	Indicates variables in the following scenarios: <ul style="list-style-type: none"> Variables are not clearly separated from the surrounding text or from other variables. Example: <pre>Status-<report-name><file-version>.csv</pre> Variables in headings.
[] square brackets	Indicates optional values. Example: [a b] indicates that you can choose a, b, or nothing.
{ } braces	Indicates required or expected values. Example: { a b } indicates that you must choose either a or b.
vertical bar	Indicates that you have a choice between two or more options or arguments. Examples: [a b] indicates that you can choose a, b, or nothing. { a b } indicates that you must choose either a or b.

This document uses the following icons to draw attention to information:

Icon	Label	Description
	Note	Calls attention to important or additional information.

Icon	Label	Description
	Tip	Provides helpful information, guidelines, or suggestions for performing tasks more effectively.
	Caution	Warns the user of adverse conditions and/or consequences (for example, disruptive operations, data loss, or a system crash).
	WARNING	Warns the user of a hazardous situation which, if not avoided, could result in death or serious injury.

Conventions for storage capacity values

Physical storage capacity values (for example, disk drive capacity) are calculated based on the following values:

Physical capacity unit	Value
1 kilobyte (KB)	1,000 (10^3) bytes
1 megabyte (MB)	1,000 KB or $1,000^2$ bytes
1 gigabyte (GB)	1,000 MB or $1,000^3$ bytes
1 terabyte (TB)	1,000 GB or $1,000^4$ bytes
1 petabyte (PB)	1,000 TB or $1,000^5$ bytes
1 exabyte (EB)	1,000 PB or $1,000^6$ bytes

Logical capacity values (for example, logical device capacity, cache memory capacity) are calculated based on the following values:

Logical capacity unit	Value
1 block	512 bytes
1 cylinder	Mainframe: 870 KB Open-systems: <ul style="list-style-type: none"> ▪ OPEN-V: 960 KB ▪ Others: 720 KB
1 KB	$1,024 (2^{10})$ bytes

Logical capacity unit	Value
1 MB	1,024 KB or 1,024 ² bytes
1 GB	1,024 MB or 1,024 ³ bytes
1 TB	1,024 GB or 1,024 ⁴ bytes
1 PB	1,024 TB or 1,024 ⁵ bytes
1 EB	1,024 PB or 1,024 ⁶ bytes

Accessing product documentation

Product user documentation is available on Hitachi Vantara Support Connect: <https://knowledge.hitachivantara.com/Documents>. Check this site for the most current documentation, including important updates that may have been made after the release of the product.

Getting help

[Hitachi Vantara Support Connect](#) is the destination for technical support of products and solutions sold by Hitachi Vantara. To contact technical support, log on to Hitachi Vantara Support Connect for contact information: https://support.hitachivantara.com/en_us/contact-us.html.

[Hitachi Vantara Community](#) is a global online community for Hitachi Vantara customers, partners, independent software vendors, employees, and prospects. It is the destination to get answers, discover insights, and make connections. **Join the conversation today!** Go to community.hitachivantara.com, register, and complete your profile.

Comments

Please send us your comments on this document to doc.comments@hitachivantara.com. Include the document title and number, including the revision level (for example, -07), and refer to specific sections and paragraphs whenever possible. All comments become the property of Hitachi Vantara Corporation.

Thank you!

Chapter 1: Overview of the REST API

This chapter describes the system configuration for using the REST API, how to specify resources, the format of requests and responses, and descriptions of each object.

System configuration of the REST API

This section explains the basic system configuration for using the REST API.

The following shows the basic system configuration of the REST API.

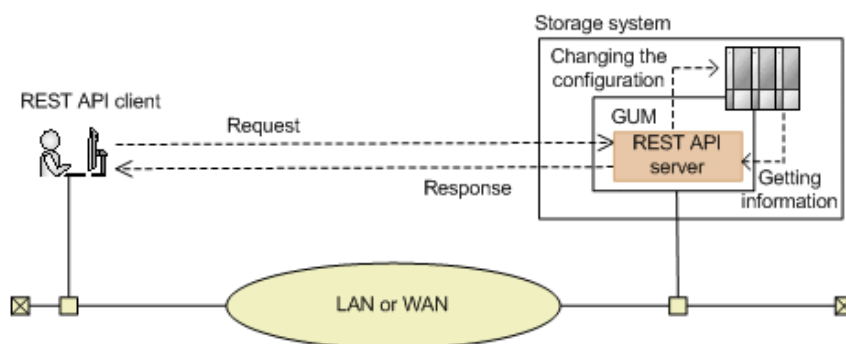

Storage system

By using the REST API, you can get information from the storage system or change the configuration of the storage system. The REST API can perform operations on the following storage systems:

- VSP F350, F370, F700, F900
- VSP G350, G370, G700, G900

GUM (Gateway for Unified Management)

This is the computer that has basic management functions for the storage system. You can manage storage system from an external device through communications with GUM.

GUM exists in each controller, CTL1 and CTL2.

REST API server

This is a component that acts as a server to receive REST API requests from REST API clients, issue orders to the storage system, and then return the execution results to the REST API clients.

The REST API server is included in the GUM of the storage system.

**Note:**

The REST API servers that are allocated on the GUM of CTL1 and CTL2 operate independently. Therefore, when a failure occurs in one GUM, the REST API server on the other GUM can be used to run the operation. However, the following information is not inherited by the REST API servers:

- Job information
- Remote storage system information

If necessary, register information about the remote storage systems to the other REST API server.

REST API clients

The REST API clients issue requests to the REST API server. The term "REST API client" refers to software or scripts that use the REST API.

With the REST API, you can run API requests other than those described in this manual, such as API requests that get information in a simple format and API requests that return responses at a high speed. For details about these API requests, see [Hitachi Vantara Knowledge](#).



Note: The REST API server internally links with the CCI of the GUM. The maximum number of CCI instances used by the REST API server is 1000, in the range from 1048 to 2047. If you use the CCI of the GUM for a purpose other than the REST API, use an instance number that is not in the range from 1048 to 2047.

Requirements for SSL communications

This section describes how to set up SSL communication for the REST API.

With the REST API, you can use SSL communication between the REST API clients and the REST API server.

For SSL communications between REST API clients and the REST API server, the server certificate for HTTPS installed in the GUM is used. By default, this server certificate is a self-signed certificate. For this reason, a communication error might occur depending on the client program. To resolve this issue, do one of the following:

- Change the certificate of the storage system to a server certificate trusted by a certificate authority, such as VeriSign.

For details on how to obtain a certificate signed by a certificate authority and how to update the certificate on the GUM, see the *System Administrator Guide*.

- Correct the client programs to avoid errors.

The approach taken to correct client programs to avoid errors varies by programming language.

For example, if the Requests library is used with Python, verification of the server certificate can be omitted if `verify=False` is specified when a request is issued.

**Note:**

TLS version 1.2 can be used for SSL communication between REST API clients and the REST API server.

The following encryption methods (cipher suites) can be used:

- ECDHE-RSA-AES256-GCM-SHA384
- ECDHE-RSA-AES128-GCM-SHA256
- AES256-GCM-SHA384
- AES256-SHA256
- AES128-GCM-SHA256
- AES128-SHA256

Specifying the resource to be managed

In REST API, domains are separated for each type of operation. The URL format differs for each domain. The domains used in REST API and the URL format are as follows:

Objects domain:

A domain for defining operations on each object subject to REST API operations, such as operations on storage system resources (for example, LDEVs or pools). Specify the URL in the following format:

```
protocol://host-name:port-number/ConfigurationManager/version/objects
```

Services domain:

A domain for defining the services provided by the REST API server. Services indicate batch operations for multiple objects, or operations for using or changing the configuration of the REST API server, such as locking or unlocking a resource group. Specify the URL in the following format:

```
protocol://host-name:port-number/ConfigurationManager/version/  
services
```

Configuration domain:

A domain for defining settings related to the REST API server, for example, collecting REST API version information. Specify the URL in the following format:

```
protocol://host-name:port-number/ConfigurationManager/configuration
```

Base URL:

```
protocol://host-name:port-number/ConfigurationManager
```

- Protocol: Specify `https` or `http`. We recommend specifying `https` for security.
- Host name: Specify the IP address of the GUM or a host name that can be resolved.
- Port number: Specify the port number to be used for communications with the REST API server. The default port number is `443` for SSL communications, and `80` for non-SSL communications. The port number can be omitted if the default port number is used for communications.
- Version: Specify the version of the REST API. Currently, only `v1` can be specified.

**Tip:**

You can also specify the URL in the same format used for the Configuration Manager REST API. Specify the URL in the following format:

- For the objects domain

```
protocol://host-name:port-number/ConfigurationManager/version/objects/storages/storage-device-ID
```

- For the services domain

```
protocol://host-name:port-number/ConfigurationManager/version/storage-device-ID/services
```

For the storage device ID, specify a 12-digit value consisting of the fixed value designated for the model of the storage system and the storage system's 6-digit serial number. The fixed value designated for the storage system model is as follows.

Storage system	Fixed value
VSP F370, F700, F900 VSP G370, G700, G900	886000
VSP F350 VSP G350	882000
VSP G130#	880000

#: This model is available only in select markets. Contact your local sales representative for availability.

- The following describes the URL formats supported by each domain.

For the objects domain:

URL formats (excluding the base URL)	HTTP method	Operations
<code>/v1/objects/storages</code>	GET	Obtain general information about the target storage system
<code>/v1/objects/storages/instance</code> You can also specify the URL in the following format: <code>/v1/objects/storages/storage-device-ID</code>	GET	Obtain detailed information about the target storage system
<code>/v1/objects/object-type</code> You can also specify the URL in the following format: <code>/v1/objects/storages/storage-device-ID/object-type</code>	GET	Obtain a list of multiple objects
<code>/v1/objects/object-type/object-ID</code> You can also specify the URL in the following format: <code>/v1/objects/storages/storage-device-ID/object-type/object-ID</code>	POST	Create new objects
	GET	Obtain an object
<code>/v1/objects/object-type/object-ID/object-ID</code> You can also specify the URL in the following format: <code>/v1/objects/storages/storage-device-ID/object-type/object-ID</code>	PATCH	Change an attribute of an object
	DELETE	Delete an object
<code>/v1/objects/object-type/object-ID/actions/action-name</code> You can also specify the URL in the following format: <code>/v1/objects/storages/storage-device-ID/object-type/object-ID/actions/action-name</code>	GET	Obtain the action template for an object

URL formats (excluding the base URL)	HTTP method	Operations
<pre>/v1/objects/object-type/object-ID/actions/action-name/invoke</pre> <p>You can also specify the URL in the following format:</p> <pre>/v1/objects/storages/storage-device-ID/object-type/object-ID/actions/action-name/invoke</pre>	POST	Run an action on an object

For the services domain:

URL formats (excluding the base URL)	HTTP method	Operations
<pre>/v1/services/service-name/actions/action-name/invoke</pre> <p>You can also specify the URL in the following format:</p> <pre>/v1/storage-device-ID/services/service-name/actions/action-name/invoke</pre>	POST	Run a specific action of the service

For the configuration domain:

URL formats (excluding the base URL)	HTTP method	Operations
<pre>configuration/version</pre>	GET	Obtain the version information of the REST API

The following is an example of a URL:

```
https://192.0.2.100/ConfigurationManager/v1/objects/ldevs
```

Specifying an object ID

An object ID is an ID that is used to uniquely identify a resource. An object ID is used when specifying a specific resource in a URL.

You can use the following two methods to specify an object ID:

- (Recommended) Run the GET operation to obtain the object ID from the execution result.

Example: When specifying the object ID of an LDEV

If the object type is `ldevs`, because the object ID of the LDEV is unique in the storage system, use the object ID obtained by running the GET operation without changing the ID. If the object ID of the LDEV is `100`, specify as follows:

```
ldevs/100
```

- Generate an object ID by using the character string that connects multiple attribute values with commas.

Example: When specifying the object ID of a host group

If the object type is `host-groups`, the object ID of the host group can be generated by connecting, with a comma, the attribute value of the port and the attribute value of the host group that belongs to the port. If the attribute value representing the port is `CL1-A`, and the attribute value representing the host group which belongs to the port is `200`, specify as follows:

```
host-groups/CL1-A,200
```

To generate an object ID by connecting multiple attribute values with commas, the attribute value must be encoded in accordance with the RFC3986 on the REST API client. After all attribute values are encoded, specify the character string that connects multiple attribute values with commas to be the object ID. Typical symbols which need encoding are shown below.

Pre-Encode	Post-Encode
! (exclamation mark)	%21
# (number sign)	%23
\$ (dollar sign)	%24
% (percent)	%25
& (ampersand)	%26
' (single quotation mark)	%27
((left parenthesis)	%28
) (right parenthesis)	%29
* (asterisk)	%2A
+ (plus sign)	%2B
, (comma)	%2C
: (colon)	%3A
; (semicolon)	%3B
= (equal sign)	%3D
? (question mark)	%3F
@ (at sign)	%40
[(left square bracket)	%5B
] (right square bracket)	%5D

Here is an example of specifying the object ID of the CHAP user from the following attribute values:

```
"portId": "CL1-A"
"hostGroupNumber": 234
"wayOfChapUser": "TAR"
"chapUserName": "pmd2g,user1"
```

After the comma contained in the value of `chapUserName` is encoded to `%2C`, the object ID of the CHAP user is the following character string, which connects the values with commas:

```
CL1-A,234,TAR,pmd2g%2Cuser1
```

**Note:**

- If the object ID is obtained by performing the GET operation, the REST API server returns an encoded value. To use the object ID obtained by performing the GET operation in a request of another operation, use the object ID without decoding it.
- If you want to create a new object or change an attribute, we recommend that you do not specify values that contain the reserved characters listed above.

Supported HTTP methods

HTTP defines methods, which are operations that can be performed on resources.

The REST API supports the following HTTP methods.

HTTP method	Description	Processing method
GET	This method gets object information. Alternatively, this method gets a list of objects. For example, this method can obtain a list of pools.	Synchronous
POST	<ul style="list-style-type: none"> ▪ This method creates new objects. For example, this method can create pools. ▪ This method can perform specific actions to objects. For example, this method can expand pools. 	Asynchronous However, the following APIs are performed in synchronous processing. <ul style="list-style-type: none"> ▪ Generating sessions ▪ Uploading the files required for initial configuration ▪ Getting information about an iSCSI target of a port on an external storage system ▪ Performing a login test on an iSCSI target of an external storage system that is registered to a port on the local storage system ▪ Backing up encryption keys
PATCH	This method changes the attributes or the state of an object.	Asynchronous

HTTP method	Description	Processing method
	For example, this method can change the pool threshold.	However, the following API is performed in synchronous processing. <ul style="list-style-type: none"> Setting the system date and time of a storage system
DELETE	This method deletes objects. For example, this method can delete pools.	Asynchronous However, the following APIs are performed in synchronous processing. <ul style="list-style-type: none"> Discarding sessions

The following explains the processing method for the REST API (synchronous processing and asynchronous processing):

- For synchronous processing, the processing results are returned in the response.
- For asynchronous processing, the operation on the resource is registered as a job. In addition, the job information and the HTTP status code 202, which indicates that the processing has been accepted, are returned in the response. Subsequently, the registered job runs asynchronously. If registration of a job fails, the HTTP status code 500 is returned.



Tip:

- If you specify `Completed` for the `Response-Job-Status` in the request header (even for asynchronous processing operations), a response will be returned only after the job is complete.
- For pair operations, you can use `Job-Mode-Wait-Configuration-Change` in the request header to specify the time when the job status changes to `Completed`. If you specify `NoWait` in the request header, the job status will change to `Completed` without waiting for data copying to finish.

User authentication

User authentication is required to operate the storage system. To perform user authentication, the Authorization header must be specified.

In the REST API, session-based user authentication is performed. A session is always generated first when a REST API client accesses the REST API server and starts an operation. In the request that generates a session, the user ID and password are used for authentication to access the storage system. After a session is created, specify session information for the Authorization header to perform authentication based on the session information.

Authentication by the user ID and password

When you create a session, specify authentication information in the following format in the Authorization header:

```
Authorization: Basic authentication-information
```

authentication-information

Specify a base64-encoded character string in which the user ID and password are concatenated with a colon (:). Use the user ID and password of a user account that can perform operations on storage system resources.

When using the REST API, you can use the following characters for the user ID and password.

Item	Number of characters	Specifiable characters
User ID	1 to 63 characters	<p>You can use the following characters.</p> <ul style="list-style-type: none"> Alphanumeric characters The following symbols: ! # \$ % & ' * + - . / = ? @ ^ _ ` { } ~
Password	6 to 63 characters	<p>You can use the following characters.</p> <ul style="list-style-type: none"> Alphanumeric characters ASCII symbols which can be keyed in except space: ! " # \$ % & ' () * + , - . / : ; < = > ? @ [\] ^ _ ` { } ~

The following is an example of the Authorization header where the user ID is `sample-user`, and the password is `sample-password`:

```
Authorization: Basic c2FtcGxllXVzZXI6c2FtcGxllXBhc3N3b3Jk
```

Authentication by sessions

Specify the token for the session in the following format in the Authorization header:

```
Authorization: Session token
```

Token

A token is authentication information that is returned after a session is created. This information is used to determine whether the request was issued from an authorized user.

Example of the Authorization header:

```
Authorization: Session 550e8400-e29b-41d4-a716-446655440000
```

Session management

In the REST API, a session is used to identify multiple requests as a series of operations to be performed by the same client. For example, if a user wants to use the same account to run two client programs in parallel, the user must generate a session for each client program. On the REST API server, each program is identified based on session information. In addition, when the REST API is used to exclusively lock the resources to be operated, the REST API controls the locks on a session basis.

A session is always generated when a REST API client accesses the REST API server and starts an operation on a storage system. After a session is generated, a session ID and token are returned to the client. In subsequent operations, specify the token for the Authorization header of each request, as authentication information. To terminate operations from a REST API client, discard sessions to prevent sessions that are no longer required from remaining on the server.

Generating a session

A REST API session is created when the user runs the API that generates a session. A user can generate multiple sessions. The maximum number of sessions that can be used is 64 per DKC.

After the session is generated, the following information is returned to the client as a response:

- Session ID

ID used for identifying a session on the REST API server. A session ID is used to check whether the session is valid or to discard the session. The user who created the session, or a user who belongs to the Administrator user group (built-in user group) can view the session ID.

- Token

Information that is used to identify the source that issues requests as a specific user. A token is used to decide whether the request is issued during the same session. Only the user who created the session can view the token.

Running an API request by using a session

To use a session to run an API request, specify a token for the Authorization header of the request as authorization credentials. The requests for which the same token is specified are handled as the operation during the same session. The following is an example of specifying the Authorization header with a token specified.

```
Authorization : Session d7b673af189048468c5af9bcf3b6666f
```

If a session goes unused for a certain period of time, it is automatically discarded (session timeout). The time that elapses until a session timeout is the time that has elapsed since the session was generated or the execution result of the request for which the session was specified was returned. The wait time during synchronous processing and the wait time for the response of an asynchronous processing API request are not included in that time. If a request that uses that session is issued during the time that elapses until a session timeout, the time is reset. The time until a session timeout is 300 seconds (5 minutes) by default. However, you can specify the time until a session timeout when a session is generated.

To prevent the session for an operation that is in progress from being discarded by a timeout, periodically issue a request that uses the session.



Tip:

If the information (such as the role and resource group) about the user who generated the session is changed while the session is being used, the changes are applied to the operation even while the session is being used. If the password of the user who generated the session is changed, the session might be discarded.

Discarding a session

If you no longer need to manage sessions after finishing a series of operations, discard the sessions. Sessions can be discarded only by the user who generated the sessions, or a user who belongs to the Administrator user group (built-in user group).

If you have locked the resources by specifying a session, the resources will be unlocked when the session is discarded.

Request headers

This section describes the request headers supported by the REST API.

Header	Category	Description	Specifiable value
Accept	Optional	Specifies the media type of the response.	*/* (json) Default value: */* (json)
Content-Type	Optional	Specifies the media type of the request body. If a request body is specified, the Content-Type header is specifiable. If a request body is not specified, this header is ignored even if specified.	application/json Default value: application/json

Header	Category	Description	Specifiable value
Content-Length	Optional	<p>Specifies the size of the request body.</p> <p>You can specify the Content-Length header when specifying a request body. This header is automatically assigned depending on the specifications of the client software.</p>	<p>Specify the header, in bytes.</p> <p>Default value: None</p>
Authorization	Required	<p>Specifies the authorization method and authorization credentials.</p> <p>You do not need to specify this header for the API function that gets version information or for the API function that gets a list of storage systems.</p>	<p>Specify the header in one of the following formats:</p> <ul style="list-style-type: none"> ▪ <i>Basic authorization-credentials</i> <p>For the authorization credentials, specify the user ID and password in a character string encoded by using Base64. Use the user ID and password of a user account that can perform operations on storage system resources.</p> <ul style="list-style-type: none"> ▪ For cases other than the above: <p><i>Session token</i></p> <p>When the session was generated:</p> <p>Specify a token that was obtained when the session was generated.</p> <p>Default value: None</p>

Header	Category	Description	Specifiable value
Remote- Authorization	Required (for the API for the object types on the right)	<p>Specifies the authorization credentials to be used when accessing the remote storage system. This header is used in the API for the following object types:</p> <ul style="list-style-type: none"> ▪ remote-mirror-copygroups ▪ remote-mirror-copypairs ▪ remote-storages 	<p>Specify the header in the following format:</p> <p><i>Session token</i></p> <p>Specify the token for the session that was generated in the remote storage system.#</p> <p>Default value: None</p>
Response-Max-Wait	Optional	<p>Specifies the maximum wait time until a response is returned when an API request for asynchronous processing is issued. A response is returned when the specified time elapses after the REST API server accepted the API request.</p> <p>If the processing finishes before the maximum wait time elapses, a response is returned at the time of completion.</p> <p>Factors such as network status and load of the REST API server can delay acceptance of a response, so the wait time might be longer than the specified maximum time. Take these factors into account when specifying the maximum wait time.</p>	<p>Integers between 0 and 1800</p> <p>Unit: Seconds</p> <p>Default value: None</p>

Header	Category	Description	Specifiable value
Response-Job-Status	Optional	Specifies the status of the job that is expected to return a response when an API request for asynchronous processing is issued. A response is returned when the job transits to the specified status or when the processing stops due to an error.	Specify the header in one of the following formats: <i>job-status;</i> or <i>job-status; Job-State=state-of-the-job</i> Default value: None
Job-Mode-Wait-Configuration-Change	Optional	Specifies when the job status is to be changed to <code>Completed</code> when an API request for asynchronous processing is issued in pair operations. Use this header for the API functions that meet the following conditions. <ul style="list-style-type: none"> ▪ The object type is one of the following: <ul style="list-style-type: none"> • <code>local-clone-copygroups</code> • <code>local-clone-copypairs</code> • <code>remote-mirror-copygroups</code> • <code>remote-mirror-copypairs</code> ▪ The HTTP method is either of the following: <ul style="list-style-type: none"> • <code>POST</code> • <code>PATCH</code> 	Specify either of the following values: <ul style="list-style-type: none"> ▪ <code>Wait</code>: Wait for data copying to finish, and then change the job status to <code>Completed</code>. ▪ <code>NoWait</code>: Change the job status to <code>Completed</code> without waiting for data copying to finish. <p>If you specify <code>NoWait</code>, data copying continues even after the job status changes to <code>Completed</code>. To check whether data copying has finished, check the status of the target resource.</p> <p>Default value: <code>Wait</code></p>

#: Specify at least 60 seconds for the timeout time of a session generated on the remote storage system. If you specify less than 60 seconds, the session on the remote storage system might time out, causing the execution of a request to fail.

If a header other than the above is specified, the specified header is ignored.

Response-Max-Wait and Response-Job-Status can be specified in combination. If both are specified, a response is returned when either condition is satisfied.

If neither Response-Max-Wait nor Response-Job-Status is specified, a response is returned immediately.

Response headers

This section describes the response headers returned by the REST API server.

Header	Description	Default
Content-Type	Indicates the media type of the response data.	<code>application/json; charset=UTF-8</code>
Content-Length	Indicates the size of the response data. If the size of the response data is large, instead of this header, <code>Transfer-Encoding: chunked</code> is returned, indicating that the response data has been divided and then transferred.	None
Transfer-Encoding	Indicates the encoding format used when the response data was transferred. When a large amount of response data is divided and then transferred, <code>chunked</code> is returned.	None
WWW-Authenticate	Indicates that authentication is required when the HTTP status code 401 is returned.	<ul style="list-style-type: none"> ▪ When a session is created: <code>Basic realm="Block storage"</code> ▪ For other cases: <code>Session realm="Block storage"</code>

HTTP status codes

The REST API uses the following standard HTTP status codes to indicate the processing results.

Status codes	Description
200	<p>Success</p> <p>The request has been processed properly. Even if the number of results obtained is 0 in a request to get information, this status code will be returned.</p>
202	<p>Accepted</p> <p>The request for asynchronous processing has been accepted.</p>
400	<p>Bad request</p> <p>The request header, the query parameter, or the request body is invalid.</p>
401	<p>Unauthorized</p> <p>The Authorization header is not specified in the request header. Alternatively, authentication using the information specified in the Authorization header has failed.</p>
403	<p>Forbidden</p> <p>You do not have the permission required to perform the operation.</p>
404	<p>Not found</p> <p>The resource specified by the URL is not found. Alternatively, you do not have read permission for the resource.</p>
405	<p>Method not allowed</p> <p>The specified method is not allowed for the resource specified by the URL.</p>
406	<p>Not acceptable</p> <p>The media type specified in the Accept header is not supported.</p>
409	<p>Conflict</p> <p>A request is made to change the status of the resource specified by the URL, in a way that the change might cause conflicts or be impossible.</p> <p>Example: A request is made to create one resource that has the same ID as another resource that has already been created.</p>
411	<p>Length Required</p> <p>The Content-Length header must be specified.</p>
412	<p>Precondition failed</p> <p>The conditions for running the API request are not met.</p>
415	<p>Unsupported media type</p>

Status codes	Description
	The media type specified in the Content-Type header is not supported.
417	Expectation Failed The specified Expect header is invalid, or the Expect header is not supported by the web server.
500	Server error An internal error has occurred in the REST API server or the storage system that is the operation target.
502	Proxy Error There is no response from the REST API server.
503	Service unavailable The request cannot be accepted, because the REST API server or the storage system is busy. If this status code is returned, run the request again.

API-specific information about status codes is explained in the sections on the specific APIs.



Note:

When REST API is used for a long period, the following response may be returned.

1. An HTML form response body is returned with the status code 500 for a several minutes.
2. When executing the API except discarding the sessions API, a blank response body is returned with the status code 200.

After that, the symptom described in 1. occurs.

In this case, execute the API again until an HTML format response is not returned with the status code 500.

Request and response formats

Use the JSON format to specify attribute values when creating or changing a resource. Also, use the JSON format for the results of resource information acquisition.

When creating or adding a resource by using the POST method, or when changing or editing a resource by using the PATCH method, specify resource attributes in JSON format. When you use the GET method to collect resource information, responses are returned in JSON format.

The supported character encoding is UTF-8.

Request format

- If you specified a null character for a string-type attribute, the value of the attribute is assumed to be null.
- If you specified a null character for an attribute whose type is not string, the attribute is assumed to be unspecified.
- You can use the following characters in attribute values:
Uppercase letters (A–Z), lowercase letters (a–z), numbers (0–9), commas (,), hyphens (-), periods (.), colons (:), at marks (@), and underscores (_)

Allowable characters vary for each API request. For details, refer to individual API command pages.



Note:

- If you specified a character string containing a comma, a colon, or an at mark, you must encode the symbol when generating the object ID. We recommend that you do not use these symbols. If you generate the object ID without encoding these symbols, the URL when an API request is issued might be incorrect and cause an error.
- You cannot specify a hyphen as the first character of the value.

- Do not include backslashes (\) or forward slashes (/) in URLs.
- If you specify an IP address, you cannot use an IPv4-mapped address.

Response format

- If the API processing succeeds, a response is returned in JSON format.
- If the processing fails, depending on the contents of the error, a response in HTML format, instead of JSON format, might be returned.

To resolve the error based on the HTTP status code in the program, check the value of Content-Type in the response header.

**Tip:**

The following example is used to describe how to read the error message that appears if the string specified in the request body contains a syntax error.

Request body:

```
{
  "parameters": {
    "status": blk
  }
}
```

Error message:

```
{
  "errorSource": "/ConfigurationManager/v1/objects/1devs/5/
actions/change-status/invoke",
  "message": "The format of the string or the content specified
in the request body is invalid. (details = Unexpected character
('b' (code 98)): expected a valid value (number, String, array,
object, 'true', 'false' or 'null')\n at [Source:
java.io.ByteArrayInputStream@10f607b; line: 3, column: 16])",
  "solution": "Check and, if necessary, revise the specified
request body so that the format and content are correct.",
  "messageId": "KART40046-E"
}
```

The location where the error occurred is output after `at` in the message details. This example indicates the error is in `line: 3, column: 16`.

In column 16 of line 3 in the request body, you can see that the `status` attribute, which should be specified as a string, is specified incorrectly.

Query parameters

If the GET method is used to obtain an object, query parameters can be specified to filter the execution results based on specific conditions.

Query parameters can be specified at the end of the URL in the following format:

```
?parameter=value
```

To specify multiple parameters, concatenate them by using ampersands (&). Multiple parameters are specified in the following example:

```
?parameter=value&parameter=value...
```

For details on parameters that can be specified for queries, see the section describing the specific API request.

Parameters are case sensitive. If you specify a parameter other than those that can be specified for each API, the invalid parameter is ignored, and only the valid parameters are used to filter the execution results.

If a parameter value contains a reserved character defined in RFC 3986, specify an encoded character string. For details about the reserved characters defined in RFC 3986, see the section describing how to specify an object ID.

If you specify an IP address for a parameter value, you cannot use an IPv4-mapped address.



Note:

When you obtain an object by specifying query parameters, if the storage management software or another REST API client is performing a configuration-change operation on the object, you might not be able to obtain the correct information. To obtain the correct information, be sure to obtain a lock before obtaining the object.

Data type

This section describes the data types that can be specified by using the REST API.

The following table shows the data types supported by the REST API and the corresponding JSON data types.

Data type	JSON type	Description
boolean	boolean	A type that represents <code>true</code> or <code>false</code> . Example : <code>true</code>
int	number	A type that represents a 32-bit signed integer. Example : <code>100</code>
long	number	A type that represents a 64-bit signed integer. Example : <code>1048576</code>
string	string	A type that represents a character string. Example : <code>"host_group_1"</code>
ISO8601string	string	A type that represents time in the ISO 8601 extended format (YYYY-MM-DDThh:mm:ssZ). The only time zone that you can specify is UTC. Example : <code>"2015-03-20T09:27:35Z"</code>

Data type	JSON type	Description
link	string	<p>A type that represents the path of a URL.</p> <p>The link type indicates a URL for a resource. For example, when a request for asynchronous processing is issued, a URL for the job object is returned by using the link type.</p> <p>The link type data is a character string of the URL from which the protocol, host name, and port number are excluded. If the URL is created based on the link type data, you must add the protocol, host name, and port number.</p> <p>Example :</p> <pre>"/ConfigurationManager/v1/objects/ldevs/100"</pre>

In addition to the preceding data types, the following JSON data types are also used:

- The object type

The character string, in which the attribute and value are connected with a colon (:), is enclosed in { and }. If more than one attribute-value pair exists, the pairs are separated by commas.
- The array type

The character string, in which multiple values are separated by commas, is enclosed in [and].

Output format

After an API request is issued, a response is returned based on the API processing method, the API processing type, and the execution result.

The following table shows the response output formats when the processing of the request is successful.

API processing method	API processing type	Status code of the execution result	Output format
Synchronous	GET (getting a single object)	200	See the description in the response message for each API function.

API processing method	API processing type	Status code of the execution result	Output format
processing	GET (getting multiple objects)	200	Data object
	GET (getting an action template)	200	Action template object
	Other than the preceding	200	See the description in the response message for each API function.
Asynchronous processing	All	202	Job object

If the processing of the request fails, an error object is returned as a response.

Data object

Data object is an object for returning the object list.

The following table shows the data object schema.

Attribute	Data type	Description
data	array	Object list

The following shows an example of a data object:

```
{
  "data": [
    {
      "parityGroupId": "5-2",
      "numOfLdevs": 3,
      "usedCapacityRate": 45,
      "availableVolumeCapacity": 4000,
      "raidLevel": "RAID5",
      "raidType": "2D+2D",
      "clprId": 0,
      "driveType": "DKR5C-J600SS"
    }
  ],
}
```

```

    {
      "parityGroupType",
      ...
    },
    ...
  ]
}

```

Job object

A job object represents job information that is returned when an API request for asynchronous processing is issued.

The following table explains the schema of a job object.

Attribute	Data type	Description
jobId	long	Job object ID.
self	link	URL used to access the job information.
userId	string	ID of the user who issued the API request that triggered registration of the job.
status	string	<p>Status of the job.</p> <p>The following values can be returned:</p> <ul style="list-style-type: none"> ▪ <code>Initializing</code>: The job is being initialized. ▪ <code>Running</code>: The job is running. ▪ <code>Completed</code>: Execution of the job is finished.
state	string	<p>State of the job.</p> <p>The following values can be returned:</p> <ul style="list-style-type: none"> ▪ <code>Queued</code>: The job has been queued. ▪ <code>Started</code>: The job has been started. ▪ <code>StorageAccepted</code>: The request was received by the storage system#. ▪ <code>Succeeded</code>: The job finished successfully. ▪ <code>Failed</code>: The job failed. ▪ <code>Unknown</code>: The state of the job is unknown.

Attribute	Data type	Description
createdTime	ISO8601string	Time when the job was created.
updatedTime	ISO8601string	Time when the state of the job was updated.
completedTime	ISO8601string	Time when the job ended.
request	Request Object	Object that retains information about the request.
affectedResources	link[]	<p>URL used to access the resource targeted by the operation.</p> <p>If one API request performs operations on multiple resources, the URLs of all those resources are returned. If a job failed, only the URLs of the resources for which processing is confirmed to have been completed are returned.</p> <p>If the resource is deleted successfully, the URL of the deleted resource is returned. A 404 error occurs if this URL is accessed. This confirms that the resource has been deleted successfully.</p> <p>The attribute affectedResources is also included in the API response that obtains job information. In this case, the URL used to access the resource targeted by the API command that triggered registration of the job is returned.</p>
error	Error Object	Object that retains error information.

#: The state `StorageAccepted` is returned only for a job that creates a remote copy pair.



Note:

A maximum of 3,000 instances of job information can be retained. If the number of instances of job information exceeds 3,000, the instances of the oldest "createdTime" are deleted first.

Example of a job object when the job execution starts:

```
{
  "jobId": 111111,
  "self": "/ConfigurationManager/v1/objects/jobs/111111",
  "userId": "user1",
  "status": "Running",
  "state": "Started",
  "createdTime": "2015-04-01T08:00:00Z",
  "updatedTime": "2015-04-01T08:05:00Z",
  "request": {
    "requestUrl": "/ConfigurationManager/v1/objects/ldevs",
```

```

    "requestMethod": "POST",
    "requestBody": "{\"ldevId\" : 112, \"poolId\" : 100, \"blockCapacity
\" : 1000}"
  }
}

```

Example of a job object when the job is finished successfully:

```

{
  "jobId": 222222,
  "self": "/ConfigurationManager/v1/objects/jobs/222222",
  "userId": "user1",
  "status": "Completed",
  "state": "Succeeded",
  "createdTime": "2015-04-01T08:00:00Z",
  "updatedTime": "2015-04-01T08:10:00Z",
  "completedTime": "2015-04-01T08:10:00Z",
  "request": {
    "requestUrl": "/ConfigurationManager/v1/objects/ldevs",
    "requestMethod": "POST",
    "requestBody": "{\"ldevId\" : 112, \"poolId\" : 100, \"blockCapacity
\" : 1000}"
  },
  "affectedResources": [
    "/ConfigurationManager/v1/objects/ldevs/112"
  ]
}

```

Example of a job object when the job failed:

```

{
  "jobId": 333333,
  "self": "/ConfigurationManager/v1/objects/jobs/333333",
  "userId": "user1",
  "status": "Completed",
  "state": "Failed",
  "createdTime": "2015-04-01T07:00:00Z",
  "updatedTime": "2015-04-01T07:01:00Z",
  "completedTime": "2015-04-01T07:01:00Z",
  "request": {
    "requestUrl": "/ConfigurationManager/v1/objects/ldevs",
    "requestMethod": "POST",
    "requestBody": "{\"ldevId\" : 112, \"poolId\" : 100, \"blockCapacity
\" : 1000}"
  },
  "error": {
    "errorSource": "/ConfigurationManager/v1/objects/ldevs",
    "messageId": "KART30000-E",
    "message": "An error occurred in the storage system. (message = The
state of the pool is incorrect.)",

```

```

    "cause": "An error occurred during execution of a CCI command.",
    "solution": "See the manual of the CCI and remove the cause of the
error.",
    "solutionType": "SEE_ERROR_DETAIL",
    "errorCode": {
        "SSB1": "2E10",
        "SSB2": "6014"
    },
    "detailCode": "30000E-2-2E10-6014"
}
}

```

Error object

An error object represents error information that is returned when the request processing fails.

If the API processing fails, an error object is returned as response data. The following explains the schema of an error object.

Attribute	Data type	Description
errorSource	link	URL where the error occurs
messageId#	string	Message ID
message	string	Content of the error message
cause	string	Cause of the error
solution	string	Solution to the error
solutionType	string	<p>Category of the solution to the error</p> <ul style="list-style-type: none"> ▪ <code>RETRY</code>: Error that can be resolved by retrying the request ▪ <code>SEE_ERROR_DETAIL</code>: Error that must be resolved by taking the action described in the error message <p>If <code>RETRY</code> is returned as the value of this attribute, retry the request that failed.</p> <p>You can check the details of the request by checking the value of <code>request</code> of the job object.</p>
errorCode	object	Error code from the storage system

Attribute	Data type	Description
		<p>A value is returned only if an error occurs in the storage system and thus one of the following error codes is issued.</p> <ul style="list-style-type: none">▪ The SSB1 code and SSB2 code of CCI▪ An error code of CCI <p>Storage system error codes are required for maintenance of the storage system.</p>
detailCode	string	<p>Detailed information about the error</p> <p>The information is displayed in the following format:</p> <p><i>nnnnnZ-TYPEoutput-format-for-each-TYPE</i></p>

Attribute	Data type	Description
		<p>Example:</p> <p>40097E-1-30000E-2-2EDA-00EE</p> <ul style="list-style-type: none"> ▪ <i>nnnnnZ</i> Displays the message ID of the REST API. <ul style="list-style-type: none"> • <i>nnnnn</i> Serial number of the message • <i>Z</i> Message type I : Information W : Warning E : Error ▪ <i>TYPE</i> Displays the type of the error. <ul style="list-style-type: none"> • 0: An error that occurred on the REST API server side • 1: An error that occurred on the REST API server on the remote storage system side (for remote copy) • 2 to 4: An error that occurred on the storage system side

Attribute	Data type	Description
		<ul style="list-style-type: none"> ▪ <i>output-format-for-each-TYPE</i> The output format varies depending on the value of <i>TYPE</i>. <ul style="list-style-type: none"> • When the value is 0: No information is output. • When the value is 1: The value of the <code>detailCode</code> attribute for the REST API server on the remote storage system side is displayed. • When the value is 2: Information about the CCI error is displayed in the following format: - <i>SSB1-code- SSB2-code</i> For details, see the CCI manual. • When the value is 3: An error code of CCI is displayed. For details, see the CCI manual. • When the value is 4: Information about an error that occurs in the GUM is displayed in the following format: - <i>part-code- error-code</i> For details, see the manual Hitachi Device Manager - Storage Navigator Messages.

#: The name of the attribute is sometimes returned as the `messageID`.

Example of an error object that might be returned if an error occurs in the REST API server:

```
{
  "errorSource": "/ConfigurationManager/v1/objects/ldevs",
  "messageId": "KART20008-E",
  "message": "Required parameters are not specified.",
  "solution": "Check parameters.",
  "solutionType": "SEE_ERROR_DETAIL",
  "detailCode": "20008E-0"
}
```

Example of an error object that might be returned if an error occurs in the storage system:

```
{
  "errorSource": "/ConfigurationManager/v1/objects/ldevs/16",
  "messageId": "KART30000-E",
  "message": "An error occurred in the storage system. (message = The state of the pool is incorrect.)",
  "cause": "An error occurred during execution of a CCI command.",
  "solution": "See the manual of the CCI and remove the cause of the error.",
  "solutionType": "SEE_ERROR_DETAIL",
  "errorCode": {
    "SSB1": "2E10",
    "SSB2": "6014"
  },
  "detailCode": "30000E-2-2E10-6014"
}
```

The following shows an output example of the `detailCode` attribute:

If an error occurs on the REST API server (message ID: KART40231-E)

```
"detailCode": "40231E-0"
```

If an error occurs on the REST API server on the remote storage system side (message ID: KART40097-E, value of the `detailCode` attribute for the REST API server on the remote storage system side: 30000E-2-2EDA-00EE)

```
"detailCode": "40097E-1-30000E-2-2EDA-00EE"
```

If an error occurs on the storage system side (message ID: KART30000-E, SSB1 code: 2EDA, SSB2 code: 00EE)

```
"detailCode": "30000E-2-2EDA-00EE"
```

If an error occurs on the storage system side (message ID: KART30000-E, CCI error code: EX_INVARG)

```
"detailCode": "30000E-3-EX_INVARG"
```

If an error occurs on the storage system side (message ID: KART30007-E, part code: 30762, error code: 204092)

```
"detailCode": "30007E-4-30762-204092"
```

Request object

Request objects are objects for retaining request information.

The following explains the schema of a request object.

Attribute	Data type	Description
requestUrl	link	URL requested by the API for asynchronous processing. If the character string of the URL exceeds 2,048 bytes, the character string will be truncated.
requestMethod	string	HTTP method requested by the API for asynchronous processing.
requestBody	string	Request body requested by the API for asynchronous processing. If the character string of the request body exceeds 1,024 bytes, the character string will be truncated.

Action template object

An action template object is a template of request bodies that are required to run actions. Get action template objects by using the GET method. Specify values in the template according to the action that you want to run. Specify the request body, and then run the action.

The following table shows the schema of the action template object.

Attribute	Data type	Description
parameters	object	Parameters required for the operation

The following shows the action template for expanding the volume capacity, as an example of an action template object:

```
{
  "parameters": {
    "additionalBlockCapacity": null
  }
}
```

In an action template, the attributes that must be specified to run an action are written beforehand. For the values, `null` or `[]` is set to indicate that the values are unspecified. Specify a value for these attributes. In the preceding example, the two attributes used to specify the amount of the capacity to be added to a volume are written.

In the following example, values are specified in the collected action template:

```
{
  "parameters": {
    "additionalBlockCapacity": 500
  }
}
```

In the request body, specify an action template in which unnecessary attribute lines have been deleted and attribute values have been set for the remaining necessary attribute lines, and then run the action.

Locking resources

If multiple REST API clients simultaneously attempt to perform operations on the same resource, unexpected configuration changes might be performed, with results other than those anticipated. In the REST API, the user can lock the resource group allocated to them so that other users cannot change the configurations of resources in the locked resource group.

The REST API controls locks on a session basis. All resources of the resource group allocated to the user who generated a session are locked. When the resource group allocated to you is locked by another user, you cannot obtain a lock for the resource group.

Only the session used for the request that locked a resource can run a configuration-change request for the locked resource. If one user account generated multiple sessions, a configuration-change request cannot be run if the specified session is different from the session used to lock the resource. (If the specified session is different, even if it is generated by the same user account, the session cannot run the configuration-change request.)

However, operations that do not change the configurations of the resources on the storage system, such as a change of a pair status and operations for the REST API server, can be run without being affected by exclusive control by locking. The following operations are not affected by locking:

- Generating or discarding a session
- Registering or deleting remote storage system information on the REST API server
- Changing the status of a copy pair or snapshot (split, resynchronize, and restore)
- Getting information

Note that, when you obtain information by specifying query parameters, you might not be able to obtain the correct information because the operation might be affected by configuration-change operations performed by other REST API clients or by the storage management software. To obtain the correct information, be sure to lock the relevant resources before performing the operation.

- Setting the system date and time of a storage system
- Uploading the files required for initial configuration

When a single user account uses multiple sessions, only one of the sessions can be used to lock resources.

When operations are complete and the resources no longer need to be locked, run the API command for unlocking the resource group. If the session used for locking is discarded, the locked resource group will be unlocked at the same time. If the session is discarded due to a session timeout, the locked resource group will also be unlocked at the same time.



Tip:

- A session timeout occurs even when an asynchronous processing API operation is being run. If you want to continue to lock the resources while an asynchronous processing API operation is being run, prevent a session timeout by taking a measure, such as periodically issuing the request that checks the job status.
- If you want to forcibly unlock resources because a REST API client unexpectedly continues to lock the resources or the token is lost, either wait until the session times out or forcibly discard the session by using a user who belongs to the Administrator user group (built-in user group).
- If the locked user information (such as the role and resource group) is changed while the resource is being locked, the changes are applied to operations after the resource is unlocked.

Operation flow for running API requests by using the lock functionality

The following table describes the operation flow for running API requests by locking resource groups.

Step	Operation	Item to be specified for the Authorization header
1	Generate a session.	User ID and password
2	Lock the resource group.	The token of the session generated in step 1
3	Perform operations on the locked resource.	The token of the session generated in step 1
4	Unlock the resource group.	The token of the session generated in step 1
5	Discard the session.	The token of the session generated in step 1

Operation flow for running API requests by using the lock functionality (for remote copy)

For copy operations between storage systems (remote copy), to perform operations to change configurations of a copy group or the resources in a copy group by locking the target resources, lock the resources of both the local and remote storage systems. To lock the both resources and perform operations on the locked resources, specify the token of the session of each storage system for the Authorization header and the Remote-Authorization header. Note that the Remote-Authorization header is used only for the API commands that are used for the following object types:

- remote-mirror-copygroups
- remote-mirror-copypairs
- remote-storages

The following table describes the operation flow for when the resources of both the local and remote storage systems are locked.

Step	Storage system on which operations are performed	Operation	Item to be specified for the Authorization header
1	Local storage system	Generate a session.	User ID and password for the local storage system
2	Remote storage system	Generate a session.	User ID and password for the remote storage system

Step	Storage system on which operations are performed	Operation	Item to be specified for the Authorization header
		Specify at least 60 seconds for the timeout time of a session generated on the remote storage system.	
3	Local storage system	Lock the resource group.	The token of the session generated in step 1
4	Remote storage system	Lock the resource group.	The token of the session generated in step 2
5	Local storage system	Perform operations on a copy group or the resources in a copy group.	The token of the session generated in step 1 Also, specify the token of the session generated in step 2 for the Remote-Authorization header.
6	Local storage system	Unlock the resource group.	The token of the session generated in step 1
7	Remote storage system	Unlock the resource group.	The token of the session generated in step 2
8	Local storage system	Discard the session.	The token of the session generated in step 1
9	Remote storage system	Discard the session.	The token of the session generated in step 2



Tip:

If creation of a remote copy pair is run, the initial copy processing for creating a pair on the storage system might take a long time. In this case, if resources are locked until the pair is created, other clients cannot use the resources of the resource group for a long time. Resources do not need to be locked by the REST API after the storage system accepts the request that creates a pair. Therefore, when you create a remote pair, we recommend that you unlock the resources after the job status is changed to "StorageAccepted".

Chapter 2: Common operations in the REST API

This chapter describes the common operations in the REST API, such as how to get information about jobs and generate sessions.

Getting the version information

The following request gets information about the version of the REST API.

Execution permission

No role is required to run this API request.

Request headers

This API request does not require authorization. Therefore, the Authorization header does not need to be specified.

Request line

```
GET base-URL/configuration/version
```

Request message

Object ID

None.

Query parameters

None.

Body

None.

Response message

Body

```
{
  "productName": "Configuration Manager REST API",
  "apiVersion": "1.14.0"
}
```

Attribute	Type	Description
productName	string	Name of the REST API
apiVersion	string	Version of the REST API

Status codes

For details on the status codes of the API, see the description on HTTP status codes.

Coding example

```
curl -v -H "Accept:application/json" -H "Content-Type:application/json" -X
GET https://192.0.2.100/ConfigurationManager/configuration/version
```

Getting a list of storage systems

The following request gets a list of the storage systems that can be operated from the REST API. You can check information about storage systems, such as the storage device ID and the serial number of the storage system.

Execution permission

No role is required to run this API request.

Request headers

This API request does not require authorization. Therefore, the Authorization header does not need to be specified.

Request line

```
GET base-URL/v1/objects/storages
```

Request message**Object ID**

None.

Query parameters

None.

Body

None.

Response message**Body**

```
{
  "data": [
    {
      "storageDeviceId": "886000123456",
      "model": "VSP G700",
      "serialNumber": 123456,
      "ctl1Ip": "192.0.2.100",
      "ctl2Ip": "192.0.2.101"
    }
  ]
}
```

Attribute	Type	Description
storageDeviceId	string	Storage device ID
model	string	Model name of the storage system
serialNumber	int	Serial number of the storage system
ctl1Ip	string	IP address of controller 1 of the storage system
ctl2Ip	string	IP address of controller 2 of the storage system

Status codes

For details on the status codes of the request for this operation, see the description on HTTP status codes.

Coding example

```
curl -v -H "Accept:application/json" -X GET https://192.0.2.100/
ConfigurationManager/v1/objects/storages
```

Getting information about a specific storage system

The following request gets information about the storage system for which an operation is to be performed.

Execution permission

Storage Administrator (View Only)

Request line

```
GET base-URL/v1/objects/storages/instance
```

Request message**Object ID**

Specify a value for `instance`. For objects that have only one instance, the value of `instance` is a fixed value (the object ID).

Query parameters

Attribute	Type	Filter Condition
detailInfoType	string	(Optional) Type of detailed information to be obtained <ul style="list-style-type: none"> ▪ version Additional detailed information about the microcode of the storage system, controller 1, and controller 2 is obtained.

Body

None.

Response message**Body**

```
{
  "storageDeviceId" : "886000123456",
  "model" : "VSP G700",
  "serialNumber" : 123456,
  "ctl1Ip": "192.0.10.10",
  "ctl2Ip": "192.0.10.11",
  "dkcMicroVersion" : "88-01-01/00",
  "communicationModes": [
    {
      "communicationMode": "lanConnectionMode"
    }
  ],
  "isSecure": true
}
```

Attribute	Type	Description
storageDeviceId	string	Storage device ID
model	string	Model name of the storage system
serialNumber	int	Serial number of the storage system
ctl1Ip	string	IP address of controller 1 of the storage system
ctl2Ip	string	IP address of controller 2 of the storage system
dkcMicroVersion	string	Microcode version of the storage system
communicationModes	object[]	<p>Array of communication modes</p> <p>The following attributes are output for the communication modes between the REST API server and the storage system:</p> <ul style="list-style-type: none"> communicationMode (string) Communication mode lanConnectionMode is displayed.
isSecure	boolean	<p>Whether the communication between the REST API server and the storage system is secure.</p> <p>The default value is <code>true</code>.</p>

You can obtain detailed information about the microcode of the storage system by executing the request with `version` specified for the `detailInfoType` query parameter.

```
{
  "storageDeviceId": "886000123456",
  "model": "VSP G900",
  "serialNumber": 123456,
  "ctl1Ip" : "192.0.10.10",
  "ctl2Ip" : "192.0.10.11",
  "dkcMicroVersion": "88-01-01/82",
  "detailDkcMicroVersion": "88-01-01-60/82",
  "ctl1MicroVersion" : "88-01-01/81",
  "ctl2MicroVersion" : "88-01-01/81",
  "communicationModes": [
    {
      "communicationMode": "lanConnectionMode"
    }
  ],
}
```

```
"isSecure": true
}
```

Attribute	Type	Description
detailDkcMicroVersion	string	Microcode version of the storage system Model identification information is included.
ctl1MicroVersion	string	GUM version of the controller 1 If a failure has occurred in the GUM of controller 1, this information is not obtained.
ctl2MicroVersion	string	GUM version of the controller 2 If a failure has occurred in the GUM of controller 2, this information is not obtained.

Status codes

For details on the status codes of the request for this operation, see the description on HTTP status codes.

Coding example

```
curl -v -H "Accept:application/json" -H "Authorization:Session
d7b673af189048468c5af9bcf3bbbb6f" -X GET https://192.0.2.100/
ConfigurationManager/v1/objects/storages/instance
```

Getting a list of sessions

The following request gets a list of valid sessions on the REST API server. Only a user who belongs to the Administrator user group (built-in user group) can perform this operation.

Execution permission

Administrator user group (built-in user group)

Request line

```
GET base-URL/v1/objects/sessions
```

Request message

Object ID

None.

Query parameters

None.

Body

None.

Response message**Body**

```
{
  "data": [
    {
      "sessionId": 8,
      "userId": "rest-user",
      "ipAddress": "192.0.2.100",
      "createdTime": "2015-09-14T01:02:24Z",
      "lastAccessedTime": "2015-09-14T01:02:24Z"
    },
    {
      "sessionId": 6,
      "userId": "api-user",
      "ipAddress": "192.0.2.100",
      "createdTime": "2015-09-14T00:59:58Z",
      "lastAccessedTime": "2015-09-14T00:59:58Z"
    },
    {
      "sessionId": 5,
      "userId": "admin-user",
      "ipAddress": "192.0.2.100",
      "createdTime": "2015-09-14T00:59:53Z",
      "lastAccessedTime": "2015-09-14T00:59:53Z"
    }
  ]
}
```

Attribute	Type	Description
sessionId	int	Session ID
userId	string	User ID that was used to generate the session
ipAddress	string	IP address of the REST API client that was used to generate the session

Attribute	Type	Description
		If the REST API client accesses the REST API server via another server, a character string consisting of the concatenated IP addresses of the client and of the server used to access the REST API server (the content of the X-Forwarded-For header received by the REST API server) will be output.
createdTime	ISO8601string	Time the session was generated
lastAccessedTime	ISO8601string	Time the session was last used

Status codes

For details on the status codes of the request for this operation, see the description on HTTP status codes.

Coding example

```
curl -v -H "Accept:application/json" -H "Content-Type:application/json" -H
"Authorization:Session d7b673af189048468c5af9bcf3b66b6f" -X GET https://
192.0.2.100/ConfigurationManager/v1/objects/sessions/
```

Getting information about a specific session

The following request gets information about a valid session on the REST API server by specifying a session ID. For the Authorization header of the request, specify the token of the session.

Execution permission

Storage Administrator (View Only)

Request line

```
GET base-URL/v1/objects/sessions/object-ID
```

Request message**Object ID**

Specify the value of `sessionId` that was obtained when the session was generated.

Attribute	Type	Description
sessionId	int	(Required) Session ID

Query parameters

None.

Body

None.

Response message**Body**

```
{
  "token": "97c13b8082444b36bc2103026205fa64",
  "sessionId": 9
}
```

Attribute	Type	Description
sessionId	int	Session ID
token	string	Token

Status codes

For details on the status codes of the request for this operation, see the description on HTTP status codes.

Coding example

```
curl -v -H "Accept:application/json" -H "Content-Type:application/json" -H
"Authorization:Session d7b673af189048468c5af9bcf3b6bb6f" -X GET https://
192.0.2.100/ConfigurationManager/v1/objects/sessions/9
```

Generating sessions

The following request generates sessions and manages the sessions on the REST API server. A maximum of 64 sessions can be generated for each disk controller. When the number of sessions exceeds the maximum number of sessions, the HTTP status code 503 is returned. In this case, wait a while and then run the request again.



Note: For remote copy, specify at least 60 seconds for the `aliveTime` attribute of the sessions generated on the remote storage system. If you specify less than 60 seconds, the session on the remote storage system might time out, causing the execution of a request to fail.

Execution permission

Storage Administrator (View Only)

Request line

```
POST base-URL/v1/objects/sessions
```

Request message

Object ID

None.

Query parameters

None.

Body

The following coding example specifies the time until a session timeout:

```
{
  "aliveTime": 5
}
```

Attribute	Type	Description
<code>aliveTime</code>	long	(Optional) Session timeout value (in seconds) Specify a value in the range from 1 to 300#. If this attribute is omitted, 300 is assumed.
<code>authenticationTimeout</code>	long	(Optional) Timeout value for authentication processing (in seconds) Specify this value if an external authentication server is being used to authenticate users.

Attribute	Type	Description
		Change the value according to the external authentication settings of the storage system. Specify a value in the range from 1 to 900. If this attribute is omitted, 120 is assumed.

#: There might be a delay of up to five seconds after the specified amount of time has elapsed, before the session times out.

Response message

Body

```
{
  "token": "d7b673af189048468c5af9bcf3b66b6f",
  "sessionId": 3
}
```

Attribute	Type	Description
sessionId	int	Session ID An ID that is used to manage sessions.
token	string	Token Information that is used to identify the source that issues requests as a specific user.

Status codes

For details on the status codes of the request for this operation, see the description on HTTP status codes.

Coding example

```
curl -v -H "Accept:application/json" -H "Content-Type:application/json" -u
rest-test:rest-api -X POST https://192.0.2.100/ConfigurationManager/v1/
objects/sessions/ -d ""
```

Discarding sessions

The following request discards the sessions that are no longer required. If a session is discarded, the lock obtained in that session is unlocked at the same time. For the Authorization header of the request, specify the token for a session to be discarded.

Execution permission

Storage Administrator (View Only)

Request line

```
DELETE base-URL/v1/objects/sessions/object-ID
```

Request message

Object ID

Specify the value of `sessionId` that was obtained when the session was generated. A user who belongs to the Administrator user group (built-in user group) can specify the value of `sessionId` that was obtained by the processing to get information about sessions.

Attribute	Type	Description
sessionId	int	(Required) Session ID

Query parameters

None.

Body

```
{
  "force": true
}
```

Attribute	Type	Description
force	boolean	<p>Specify whether to force discarding of the session generated by other users, in addition to the session you generated. Only a user who belongs to the Administrator user group (built-in user group) can specify this attribute.</p> <ul style="list-style-type: none"> ▪ <code>true</code>: Forces discarding of the session generated by other users, in addition to the session you generated. ▪ <code>false</code>: Forces discarding of only the session you generated. <p>If you omit this value, <code>false</code> is used.</p>

Response message**Body**

None.

Status codes

For details on the status codes of the request for this operation, see the description on HTTP status codes.

Coding example

```
curl -v -H "Accept:application/json" -H "Content-Type:application/json" -H
"Authorization:Session d7b673af189048468c5af9bcf3b66b6f" -X DELETE --data-
binary @./InputParameters.json https://192.0.2.100/ConfigurationManager/v1/
objects/sessions/1
```

Getting a list of job information

The following request gets a list of information about jobs that were submitted by the user from the REST API. Only a user who belongs to a user group with the Storage Administrator (System Resource Management) role can get information about all the registered jobs. Job information can be used to check APIs that were issued and to identify the cause of a problem in the storage system.

Execution permission

No role is required to run this API request. Only the users authenticated by the storage system can issue this API request.

Request lineGET *base-URL*/v1/objects/jobs**Request message****Object ID**

None.

Query parameters

If no query parameters are specified, the request gets information about 100 jobs that can be referenced by the user and were submitted after the other jobs.

Parameter	Type	Filter Condition
startCreatedTime	ISO8601 string	(Optional) Specify the submission start time of the jobs for which you want to get information. Specify the time in YYYY-MM-DDThh:mm:ssZ format. The request gets information about jobs that were submitted on and after the specified time.
endCreatedTime	ISO8601 string	(Optional) Specify the submission end time of the jobs for which you want to get information. Specify the time in YYYY-MM-DDThh:mm:ssZ format. The request gets information about jobs that were submitted before the specified time.
count	int	(Optional) Specify a number from 1 to 100 for the number of jobs for which you want to get information. The specified number is the maximum number of jobs for which information will be obtained. If this is omitted, 100 is assumed.

Parameter	Type	Filter Condition
status	string	<p>(Optional) Specify one of the following values for the status of the jobs for which information is to be obtained.</p> <ul style="list-style-type: none"> ▪ Initializing: The jobs are being initialized. If you also need to specify a value for "state", you must specify <code>Queued</code> for "state". ▪ Running: The jobs are running. If you also need to specify a value for "state", you must specify <code>Started</code> for "state". ▪ Completed: The jobs have been completed. If you also need to specify a value for "state", you must specify <code>Succeeded</code>, <code>Failed</code>, or <code>Unknown</code> for "state".
state	string	<p>(Optional) Specify one of the following values for the status (state) of the jobs for which information is to be obtained.</p> <ul style="list-style-type: none"> ▪ Queued: The jobs have been queued. ▪ Started: The jobs have been started. ▪ Succeeded: The jobs finished successfully. ▪ Failed: The jobs failed. ▪ Unknown: The state of the jobs is unknown.

The following example gets information about a maximum of 30 jobs that ended normally and were submitted after other jobs during the period from "2015/05/01 08:00:00" to "2015/05/31 23:59:59".

```
?startCreatedTime=2015-05-01T08:00:00Z&endCreatedTime=2015-05-31T23:59:59Z&count=30&state=Succeeded
```

Body

None.

Response message**Body**

```

{
  "data": [
    {
      "jobId": 2,
      "self": "/ConfigurationManager/v1/objects/jobs/2",
      "userId": "rest-test",
      "status": "Completed",
      "state": "Succeeded",
      "createdTime": "2015-09-14T02:08:13Z",
      "updatedTime": "2015-09-14T02:08:13Z",
      "completedTime": "2015-09-14T02:08:13Z",
      "request": {
        "requestUrl": "/ConfigurationManager/v1/services/resource-
group-service/actions/lock/invoke",
        "requestMethod": "POST",
        "requestBody": {
          "parameters": {
            "waitTime": null
          }
        }
      },
      "affectedResources": [
        "/ConfigurationManager/v1/objects/resource-groups"
      ]
    },
    {
      "jobId": 1,
      "self": "/ConfigurationManager/v1/objects/jobs/1",
      "userId": "rest-test",
      "status": "Completed",
      "state": "Failed",
      "createdTime": "2015-09-14T02:04:11Z",
      "updatedTime": "2015-09-14T02:04:12Z",
      "completedTime": "2015-09-14T02:04:12Z",
      "request": {
        "requestUrl": "/ConfigurationManager/v1/services/resource-
group-service/actions/lock/invoke",
        "requestMethod": "POST",
        "requestBody": {
          "parameters": {
            "waitTime": null
          }
        }
      },
      "error": {
        "errorSource": "/ConfigurationManager/v1/services/resource-

```

```

group-service/actions/lock/invoke",
  "message": "An error occurred in the storage system.
(message = Access denied with Lock/Unlock)",
  "cause": "An error occurred during execution of a CCI
command.",
  "solution": "See the manual of the CCI and remove the cause
of the error.",
  "solutionType": "SEE_ERROR_DETAIL",
  "messageId": "KART30000-E",
  "errorCode": {
    "errorCode": "EX_EACCES"
  }
}
]
}

```

Attribute	Type	Description
data	object[]	Job information (job objects) created by the user from the REST API. The maximum number of jobs for which you can get information at one time is 100.

For details on the job object schema, see the section explaining job objects.

Status codes

For details on the status codes of the request for this operation, see the description on HTTP status codes.

Coding example

```

curl -v -H "Accept:application/json" -H "Content-Type:application/json" -H
"Authorization:Session d7b673af189048468c5af9bcf3b66b6f" -X GET https://
192.0.2.100/ConfigurationManager/v1/objects/jobs

```

Getting job information

The following request gets, at a specific timing, information about a specified job that was submitted by the user from the asynchronous API. Only a user who belongs to a user group with the Storage Administrator (System Resource Management) role can also obtain information about jobs submitted by other users. The obtained information can be used to check the job status.

Execution permission

No role is required to run this API request. Only the users authenticated by the storage system can issue this API request.

Request line

```
GET base-URL/v1/objects/jobs/object-ID
```

Request message**Object ID**

Specify the `jobId` value obtained by getting information about the job list or the response message of the asynchronous API.

Attribute	Type	Description
jobId	long	(Required) Job object ID

Query parameters

None.

Body

None.

Response message**Body**

```
{
  "jobId": 3,
  "self": "/ConfigurationManager/v1/objects/jobs/3",
  "userId": "rest-test",
  "status": "Completed",
  "state": "Succeeded",
  "createdTime": "2015-09-14T02:08:13Z",
  "updatedTime": "2015-09-14T02:08:13Z",
  "completedTime": "2015-09-14T02:08:13Z",
  "request": {
    "requestUrl": "/ConfigurationManager/v1/services/resource-group-
service/actions/lock/invoke",
    "requestMethod": "POST",
    "requestBody": {
      "parameters": {
        "waitTime": null
      }
    }
  }
},
```



```
"affectedResources": [
  "/ConfigurationManager/v1/objects/resource-groups"
]
}
```

For details on the job object schema, see the description on job objects.

Status codes

The following table describes the meaning of the status code of the request for this operation. For details on other status codes, see the section explaining HTTP status codes.

Status codes	Message	Description
404	Not Found	<ul style="list-style-type: none"> There is no information corresponding to the specified job ID. The user who issued the API request is not the user who submitted the job corresponding to the specified job ID.

Coding example

```
curl -v -H "Accept:application/json" -H "Content-Type:application/json" -H
"Authorization:Session d7b673af189048468c5af9bcf3b6bb6f" -X GET https://
192.0.2.100/ConfigurationManager/v1/objects/jobs/3
```

Locking a resource group

The following request locks resources of a resource group allocated to the user who runs API requests, preventing other users from performing operations on the resources. Exclusive control by locking is performed on a session basis. To run requests on the locked resources, specify as the Authorization header the token of the session that was specified when the resources were locked.

Execution permission

Storage Administrator (View Only)

Request line

```
POST base-URL/v1/services/resource-group-service/actions/lock/invoke
```

Request message**Object ID**

None.

Query parameters

None.

Body

```
{
  "parameters": {
    "waitTime": 30
  }
}
```

Attribute	Type	Description
waitTime	int	The time that elapses before a lock timeout (in seconds) Specify a value from 0 to 7200 for the maximum wait time that elapses before a lock timeout occurs, for cases such as when the target resource is already locked by other sessions. If this value is omitted, 0 is specified.

Response message**Body**

A job object is returned. For details on attributes other than `affectedResources`, see the description on job objects.

Attribute	Description
affectedResources	URL of the resource group that obtained a lock

Status codes

For details on the status codes of the request for this operation, see the description on HTTP status codes.

Status code	Message	Description
503	Service unavailable	The operation cannot be performed because an API operation that locks or unlocks resources is being run by using the same session.

Coding example

```
curl -v -H "Accept:application/json" -H "Content-Type:application/json" -H "Authorization:Session d7b673af189048468c5af9bcf3b6bb6f" -X POST --data-binary @./InputParameters.json https://192.0.2.100/ConfigurationManager/v1/services/resource-group-service/actions/lock/invoke
```

Unlocking a resource group

The following request unlocks a resource group. For the Authorization header of the request for releasing the lock, specify the token of the session that got the lock.

Execution permission

Storage Administrator (View Only)

Request line

```
POST base-URL/v1/services/resource-group-service/actions/unlock/invoke
```

Request message

Object ID

None.

Query parameters

None.

Body

None.

Response message

Body

A job object is returned. For details on attributes other than `affectedResources`, see the section explaining job objects.

Attribute	Description
affectedResources	URL of the resource group that was unlocked

Status codes

For details on the status codes of the request for this operation, see the section explaining HTTP status codes.

Status code	Message	Description
503	Service unavailable	The operation cannot be performed because an API operation that locks or unlocks resources is being run by using the same session.

Coding example

```
curl -v -H "Accept:application/json" -H "Content-Type:application/json" -H
"Authorization:Session d7b673af189048468c5af9bcf3bbbb6f" -X POST https://
192.0.2.100/ConfigurationManager/v1/services/resource-group-service/
actions/unlock/invoke -d ""
```

Chapter 3: User management and access control

This chapter describes how to manage users and control access to storage system resources by using the REST API.

Overview of user management and access control

To perform operations on storage system resources, users must have the appropriate roles (execution permissions) and access permissions for the resources on which the operations are to be performed. Before using the REST API, users with the required roles and access permissions must be created.

For storage systems, resource groups and user groups are used to manage the roles and access permissions of users.

Resource group

Resource groups are used to classify and manage resources in the storage system. Only users who have access permissions for a resource group can perform operations on the resources (such as parity groups, LDEVs, and ports) that are added to that resource group.

User group

User groups are used to group users who have the same roles and access permissions for the resources in the storage system. To specify the operations that users in a user group can perform, assign a role to the user group. To specify the resources that the users in a user group can access, assign a resource group to the user group.

Role

Roles are execution permissions for resources. Roles are already set up, and the operations that users of each role can perform on resources are already defined. For details on the roles required to run a particular API request, see the description on that API request.

Users whose accounts were created by using the maintenance utility or Hitachi Device Manager - Storage Navigator can also execute REST API requests. If you want to use other storage management software to create user accounts that can execute REST API requests, specify the user IDs and passwords in accordance with the rules for the REST API.

If you are using Hitachi Device Manager - Storage Navigator, any users, user groups, and resource groups that were created by using the REST API can also be used from Hitachi Device Manager - Storage Navigator.

For details about user management and access control for storage systems, see the *System Administrator Guide*.



Note:

If a user uses the REST API to lock the resources of a storage system, operations on the users, user groups, or resource groups will no longer be able to be performed. In such a case, unlock the resources before performing these operations.

Workflow for user management and access control

This section describes the workflow for creating users who will perform operations on storage systems and for setting access permissions for the resources necessary for those operations.

When using the REST API to create a user, specify a user group to which the user will belong. Assign, in advance, resource groups and roles to the user group based on the types of resources on which the users in that user group can operate and the operation permissions of users in that user group.

The following figure shows the workflow for specifying user and access control settings. If you are using the meta_resource group or built-in user group, you do not need to configure the resource group or the user group.

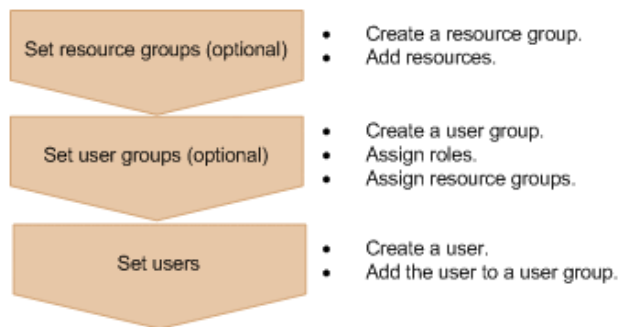

Set resource groups

Create a resource group, and then add resources such as parity groups, LDEVs, and ports. Group resources by business or organization into units for controlling access.

Set user groups

Create a user group. Assign resource groups and roles based on the types of resources on which the users in that user group can operate and the operation permissions of users in that user group.

Set users

Create a user. Specify the user group to which the user will belong, and then add the user to that user group. The user then can use the resources in the resource groups assigned to the user group according to the assigned roles.

Input rules for user IDs and passwords

When creating users who will perform operations on storage systems from the REST API, specify user IDs and passwords consisting of the characters described in the following table.

If you want to include symbols in a request body, be sure to escape the symbols as required for JSON format.

Item	Number of characters	Specifiable characters
User ID	1 to 63 characters	<p>You can use the following characters.</p> <ul style="list-style-type: none"> ▪ Alphanumeric characters ▪ The following symbols: ! # \$ % & ' * + - . / = ? @ ^ _ ` { } ~ <ul style="list-style-type: none"> • User IDs that contain forward slashes (/) cannot be used as object IDs. • User IDs that contain percent signs (%) or plus signs (+) cannot be used as object IDs for the following API requests: API request for adding users to user groups API request for removing users from user groups
Password	6 to 63 characters	<p>You can use the following characters.</p> <ul style="list-style-type: none"> ▪ Alphanumeric characters ▪ ASCII symbols which can be keyed in except space: ! # \$ % & ' () * + , - . / : ; < = > ? @ [\] ^ _ ` { } ~

**Note:**

- When creating a user account that will not be used for the REST API but will be used for other products such as Storage Navigator, you can use the number of characters in the `userId` and `userPassword` attributes of the API function for creating a user account, and in the `userPassword` attribute of the API function for changing the password of the user. Specify the user ID and password according to input restrictions (specifiable characters and the required number of characters) of the software for which the user account will be used. Note that, if you create an account for which the user ID or password does not adhere to the input restrictions in the preceding table, you will not be able to use the account to run the REST API.
 - The `userId` attribute: 1 to 256 characters
 - The `userPassword` attribute: 6 to 256 characters
- If you use Storage Navigator or another product to create a user account whose password includes a double quotation mark ("), you can use that user account to run the REST API. However, you cannot use the REST API to create a user account whose password includes a double quotation mark or to change a password to one that includes a double quotation mark.

Getting a list of resource groups

The following request gets information about resource groups registered in the storage system. You can also use a query parameter to get information about only certain resources of interest.

**Important:**

- For this API request and the API request for getting global-active device pair information, you can run a maximum of two concurrent API requests for each storage system. HTTP status code 503 will be returned for any unaccepted requests. In such cases, wait a while, and then run the applicable API requests again.
- To run this API request at the same time as one of the following API requests, see the notes on the number of concurrent executions of the applicable API request:
 - API request for getting volume information
 - API request for getting port information (when executed with `detailInfoType=logins` specified in the query)
 - API request for getting information about host groups or iSCSI targets
 - API request for getting a list of external path groups
 - API request for getting information about a specific external path group

Execution permission

Storage Administrator (View Only)

Request lineGET *base-URL/v1/objects/resource-groups***Request message****Object ID**

None.

Query parameters

To filter execution results:

Parameter	Type	Filter condition
lockStatus	string	(Optional) Lock status of the resource group <ul style="list-style-type: none"> ▪ Locked: Gets information about the locked resource groups ▪ Unlocked: Gets information about the unlocked resource groups

To get information about only certain types of resources in resource groups:

If you try to get information for a large number of resource groups, processing might take a long time. You can reduce the request processing time by using the following query parameter to get information about only certain resources of interest.

Parameter	Type	Filter condition
attributes	string	(Optional) Type of resource for which information is to be obtained Information will be obtained about only resources corresponding to the specified attributes. To specify multiple attributes, separate the attributes by using commas.

Parameter	Type	Filter condition
		<p>You can use this parameter in combination with the <code>lockStatus</code> parameter.</p> <ul style="list-style-type: none"> ▪ <code>ldevIds</code>: LDEV numbers ▪ <code>parityGroupIds</code>: Parity group numbers ▪ <code>externalParityGroupIds</code>: External parity group numbers ▪ <code>portIds</code>: Port numbers ▪ <code>hostGroupIds</code>: Object IDs of host groups or iSCSI targets <p>If this parameter is omitted, information will be obtained about all of the attributes listed above.</p> <p>Information about attributes other than those listed above will be obtained regardless of the specification of this parameter.</p>

The following are examples of how to specify these query parameters in various situations.

To get the LDEV numbers of locked resource groups:

```
?lockStatus=Locked&attributes=ldevIds
```

To get the port numbers, and the object IDs of host groups or iSCSI targets for all resource groups:

```
?attributes=portIds,hostGroupIds
```

Body

None.

Response message**Body**

The following is an example of output when a request is run to get information about all types of resource groups:

```
{
  "data": [
    {
      "resourceGroupId": 4,
      "resourceGroupName": "devResourceGroup",
      "lockStatus": "Locked",
      "lockOwner": "devUser",
      "lockHost": "host01",
      "virtualStorageId": 0,
      "ldevIds": [
        12,
        13
      ],
      "parityGroupIds": [
        "1-1",
        "1-2"
      ],
      "externalParityGroupIds": [
        "1-5",
        "1-6"
      ],
      "portIds": [
        "CL1-A",
        "CL1-B"
      ],
      "hostGroupIds": [
        "CL1-A,4",
        "CL1-A,5",
        "CL1-A,6"
      ]
    },
    {
      "resourceGroupId": 5,
      "resourceGroupName": "sales_group_resource",
      "lockStatus": "Unlocked",
      "virtualStorageId": 0,
      "ldevIds": [
        32,
        33
      ],
      "parityGroupIds": [
        "2-1",
        "2-2"
      ]
    }
  ]
}
```

```
],  
  "externalParityGroupIds": [  
    "1-7",  
    "1-8"  
  ],  
  "portIds": [  
    "CL3-A"  
  ],  
  "hostGroupIds": [  
    "CL3-A,1",  
    "CL3-A,2"  
  ]  
}  
]  
}
```

The following is an example of output when a request is run with the `attributes` query parameter specified, to get only information about port numbers and the object IDs of host groups or iSCSI targets:

```
{
  "data": [
    {
      "resourceGroupId": 4,
      "resourceGroupName": "devResourceGroup",
      "lockStatus": "Locked",
      "lockOwner": "devUser",
      "lockHost": "host01",
      "virtualStorageId": 0,
      "portIds": [
        "CL1-A",
        "CL1-B"
      ],
      "hostGroupIds": [
        "CL1-A,4",
        "CL1-A,5",
        "CL1-A,6"
      ]
    },
    {
      "resourceGroupId": 5,
      "resourceGroupName": "sales_group_resource",
      "lockStatus": "Unlocked",
      "virtualStorageId": 0,
      "portIds": [
        "CL3-A"
      ],
      "hostGroupIds": [
        "CL3-A,1",
        "CL3-A,2"
      ]
    }
  ]
}
```

Attribute	Type	Description
resourceGroupName	string	Resource group name
resourceGroupId	int	Resource group ID

Attribute	Type	Description
lockStatus	string	Lock status of the resource group <ul style="list-style-type: none"> Locked: The resource group is locked. Unlocked: The resource group is unlocked.
selfLock	boolean	Whether the session specified in the Authorization header locked the resource group <ul style="list-style-type: none"> true: The specified session locked the resource group false: Another session locked the resource group <p>This attribute is output if the resource group is locked by a session that was generated by the same user who runs the API.</p>
lockOwner	string	User ID that locked the resource group <p>This attribute is not output if the resource group is unlocked.</p>
lockHost	string	IP address or name of the host that locked the resource group <p>IP address or the host name of the GUM is output if the resource group has been locked by the REST API.</p> <p>This attribute is not output if the resource group is unlocked.</p>
lockSessionId	int	Session ID that locked the resource group <p>This attribute is output only when the resource group is locked and when a user who belongs to the Administrator user group (built-in user group) runs the API.</p>
virtualStorageId	int	ID of the virtual storage machine that corresponds to the resource group
ldevIds	int[]	LDEV number
parityGroupIds	string[]	Parity group number
externalParityGroupIds	string[]	External parity group number

Attribute	Type	Description
portIds	string[]	Port number
hostGroupIds	string[]	Object ID of the host group or iSCSI target

Status codes

For details on the status codes of the request for this operation, see the description on HTTP status codes.

Coding example

```
curl -v -H "Accept:application/json" -H "Content-Type:application/json" -H
"Authorization:Session d7b673af189048468c5af9bcf3bbbb6f" -X GET https://
192.0.2.100/ConfigurationManager/v1/objects/resource-groups
```

Getting information about a specific resource group

The following request gets information about the specified resource group. The obtained information can be used to check the lock status of a resource group, the user ID of the user who locked the resource group, or the name of the host that locked the resource group.

Execution permission

Storage Administrator (View Only)

Request line

```
GET base-URL/v1/objects/resource-groups/object-ID
```

Request message

Object ID

Specify the value of `resourceGroupId` that was obtained by the processing to get information about resource groups.

Attribute	Type	Description
resourceGroupid	int	(Required) Resource group ID

Attribute	Type	Description
		Specify a decimal (base 10) number in the range from 0 to 1023.

Query parameters

None.

Body

None.

Response message**Body**

```

{
  "resourceGroupId": 4,
  "resourceGroupName": "devResourceGroup",
  "lockStatus": "Locked",
  "lockOwner": "devUser",
  "lockHost": "host01",
  "virtualStorageId": 0,
  "ldevIds": [
    12,
    13
  ],
  "parityGroupIds": [
    "1-1",
    "1-2"
  ],
  "externalParityGroupIds": [
    "1-5",
    "1-6"
  ],
  "portIds": [
    "CL1-A",
    "CL1-B"
  ],
  "hostGroupIds": [
    "CL1-A,4",
    "CL1-A,5",
    "CL1-A,6"
  ]
}

```

Attribute	Type	Description
resourceGroupName	string	Resource group name
resourceGroupId	int	Resource group ID
lockStatus	string	Lock status of the resource group <ul style="list-style-type: none"> Locked: The resource group is locked. Unlocked: The resource group is unlocked.
selfLock	boolean	Whether the resource group was locked by the session specified in the Authorization header <ul style="list-style-type: none"> true: The specified session locked the resource group. false: Another session locked the resource group. <p>This attribute is output when the resource group is locked by a session that was generated by the same user who runs the API.</p>
lockOwner	string	User ID of the user who locked the resource group <p>This attribute is output only when the resource group is locked.</p>
lockHost	string	Name of the host that locked the resource group <p>If the resource group was locked by the REST API, the host name of the GUM is output.</p> <p>This attribute is output only when the resource group is locked.</p>
lockSessionId	int	Session ID of the session that locked the resource group <p>This attribute is output only when the resource group is locked and the API was run by one of the following users: the user who belongs to the Administrator user group (built-in user group).</p>
virtualStorageId	int	ID of the virtual storage machine that corresponds to the resource group
ldevIds	int[]	LDEV number
parityGroupIds	string[]	Parity group number

Attribute	Type	Description
externalParityGroupIds	string[]	External parity group number
portIds	string[]	Port number
hostGroupIds	string[]	Object ID of the host group or iSCSI target

Status codes

For details on the status codes of the request for this operation, see the description on HTTP status codes.

Coding example

```
curl -v -H "Accept:application/json" -H "Content-Type:application/json" -H
"Authorization:Session d7b673af189048468c5af9bcf3b6666f" -X GET https://
192.0.2.100/ConfigurationManager/v1/objects/resource-groups/4
```

Creating a resource group

The following request creates resource groups. To add a resource group to a virtual storage machine, you must also specify the `virtualStorageDeviceId` attribute.



Note:

If you locked any resources of the target storage system by using the REST API, you will not be able to use this API function. In such cases, unlock the resources before running the API function.

Execution permission

Security Administrator (View & Modify)

Request line

```
POST base-URL/v1/objects/resource-groups
```

Request message

Object ID

None.

Query parameters

None.

Body

```
{
  "resourceGroupName": "devResourceGroup",
  "virtualStorageId": "2"
}
```

Attribute	Type	Description
resourceGroupName	string	(Required) Resource group name Specify a name consisting of 1 to 32 characters.
virtualStorageDeviceId	string	(Optional) Storage device ID of the virtual storage machine This attribute cannot be specified at the same time as the <code>virtualStorageId</code> attribute. If this attribute is omitted, the default storage device ID (the same storage device ID as that of the target physical storage system) will be set.
virtualStorageId	int	(Optional) ID of the virtual storage machine that corresponds to the resource group Specify a decimal (base 10) number in the range from 0 to 7. This attribute cannot be specified at the same time as the <code>virtualStorageDeviceId</code> attribute. If this attribute is omitted, 0 will be set.

Response message**Body**

A job object is returned. For details on attributes other than `affectedResources`, see the description on job objects.

Attribute	Description
affectedResources	URL of the created resource group

Status codes

For details on the status codes of the request for this operation, see the description on HTTP status codes.

Coding example

```
curl -v -H "Accept:application/json" -H "Content-Type:application/json" -H
"Authorization:Session d7b673af189048468c5af9bcf3b666f" -X POST --data-
binary @./InputParameters.json https://192.0.2.100/ConfigurationManager/v1/
objects/resource-groups
```

Adding a resource to a resource group

The following request adding resources to resource groups.

**Note:**

If you locked any resources of the target storage system by using the REST API, you will not be able to use this API function. In such cases, unlock the resources before running the API function.

Execution permission

Security Administrator (View & Modify)

Request line

```
POST base-URL/v1/objects/resource-groups/object-ID/actions/add-resource/
invoke
```

Request message**Object ID**

Specify the value of `resourceGroupId` that was obtained by the processing to get information about resource groups.

Attribute	Type	Description
resourceGroupId	int	(Required) Resource group ID Specify a decimal (base 10) number in the range from 1 to 1023.

Query parameters

None.

Body

The following coding example shows how to specify an LDEV number:

```
{
  "parameters": {
    "ldevIds": [
      2,
      3
    ],
    "parityGroupIds": [
      "1-1",
      "1-2"
    ],
    "externalParityGroupIds": [
      "1-5",
      "1-6"
    ],
    "portIds": [
      "CL1-A",
      "CL1-B"
    ],
    "hostGroupIds": [
      "CL1-A,4",
      "CL1-A,5",
      "CL1-A,6"
    ]
  }
}
```

The following coding example shows how to specify a range of LDEV numbers:

```
{
  "parameters": {
    "startLdevId": 2,
    "endLdevId": 5,
    "parityGroupIds": [
      "1-1",
      "1-2"
    ],
    "externalParityGroupIds": [
      "1-5",
      "1-6"
    ],
    "portIds": [
      "CL1-A",
      "CL1-B"
    ],
    "hostGroupIds": [
      "CL1-A,4",

```

```

    "CL1-A,5",
    "CL1-A,6"
  ]
}
}

```

Attribute	Type	Description
parityGroupIds	string[]	(Optional) Parity group number
externalParityGroupIds	string[]	(Optional) External parity group number
portIds	string[]	(Optional) Port number
hostGroupIds	string[]	(Optional) Object ID of the host group or iSCSI target Specify the value of <code>hostGroupId</code> that was obtained by the processing to get information about host groups or iSCSI targets.
ldevIds	int[]	(Optional) LDEV number Specify a value in the range from 0 to 65279. If you specify this attribute, you cannot specify the <code>startLdevId</code> attribute or the <code>endLdevId</code> attribute.
startLdevId	int	(Optional) First LDEV number When specifying a range of LDEVs, specify a value in the range from 0 to 65278. If you specify this attribute, you must also specify the <code>endLdevId</code> attribute. If you specify the <code>ldevId</code> attribute, you cannot specify this attribute.
endLdevId	int	(Optional) Last LDEV number When specifying a range of LDEVs, specify a value in the range from 1 to 65279. If you specify this attribute, you must also specify the <code>startLdevId</code> attribute. If you specify the <code>ldevId</code> attribute, you cannot specify this attribute.

Response message

Body

A job object is returned. For details on attributes other than `affectedResources`, see the description on job objects.

Attribute	Description
<code>affectedResources</code>	URL of the resource group to which resources are added

Action template

```
GET base-URL/v1/objects/resource-groups/object-ID/actions/add-resource
```

Status codes

For details on the status codes of the request for this operation, see the description on HTTP status codes.

Coding example

To get an action template:

```
curl -v -H "Accept:application/json" -H "Content-Type:application/json" -H
"Authorization:Session d7b673af189048468c5af9bcf3bbbb6f" -X GET https://
192.0.2.100/ConfigurationManager/v1/objects/resource-groups/4/actions/add-
resource
```

To run the request after getting an action template:

```
curl -v -H "Accept:application/json" -H "Content-Type:application/json" -H
"Authorization:Session d7b673af189048468c5af9bcf3bbbb6f" --data-binary @./
InputParameters.json -X POST https://192.0.2.100/ConfigurationManager/v1/
objects/resource-groups/4/actions/add-resource/invoke
```

Removing a resource from a resource group

The following request removes resources that are no longer necessary from resource groups.



Note:

If you locked any resources of the target storage system by using the REST API, you will not be able to use this API function. In such cases, unlock the resources before running the API function.

Execution permission

Security Administrator (View & Modify)

Request line

```
POST base-URL/v1/objects/resource-groups/object-ID/actions/remove-resource/
invoke
```

Request message**Object ID**

Specify the value of `resourceGroupId` that was obtained by the processing to get information about resource groups.

Attribute	Type	Description
resourceGroupId	int	(Required) Resource group ID Specify a decimal (base 10) number in the range from 1 to 1023.

Query parameters

None.

Body

The following coding example shows how to specify an LDEV number:

```
{
  "parameters": {
    "ldevIds": [
      2,
      3
    ],
    "parityGroupIds": [
      "1-1",
      "1-2"
    ],
    "externalParityGroupIds": [
      "1-5",
      "1-6"
    ],
    "portIds": [
      "CL1-A",
      "CL1-B"
    ],
    "hostGroupIds": [
      "CL1-A,4",
```



```

    "CL1-A,5",
    "CL1-A,6"
  ]
}
}

```

The following coding example shows how to specify a range of LDEV numbers:

```

{
  "parameters": {
    "startLdevId": 2,
    "endLdevId": 5,
    "parityGroupIds": [
      "1-1",
      "1-2"
    ],
    "externalParityGroupIds": [
      "1-7",
      "1-8"
    ],
    "portIds": [
      "CL1-A",
      "CL1-B"
    ],
    "hostGroupIds": [
      "CL1-A,4",
      "CL1-A,5",
      "CL1-A,6"
    ]
  }
}
}

```

Attribute	Type	Description
parityGroupIds	string[]	(Optional) Parity group number
externalParityGroupIds	string[]	(Optional) External parity group number
portIds	string[]	(Optional) Port number
hostGroupIds	string[]	(Optional) Object ID of the host group or iSCSI target Specify the value of <code>hostGroupId</code> that was obtained by the processing to get information about host groups or iSCSI targets.

Attribute	Type	Description
ldevIds	int[]	(Optional) LDEV number Specify a value in the range from 0 to 65279. If you specify this attribute, you cannot specify the <code>startLdevId</code> attribute or the <code>endLdevId</code> attribute.
startLdevId	int	(Optional) First LDEV number When specifying a range of LDEVs, specify a value in the range from 0 to 65278. If you specify this attribute, you must also specify the <code>endLdevId</code> attribute. If you specify the <code>ldevId</code> attribute, you cannot specify this attribute.
endLdevId	int	(Optional) Last LDEV number When specifying a range of LDEVs, specify a value in the range from 1 to 65279. If you specify this attribute, you must also specify the <code>startLdevId</code> attribute. If you specify the <code>ldevId</code> attribute, you cannot specify this attribute.

Response message

Body

A job object is returned. For details on attributes other than `affectedResources`, see the description on job objects.

Attribute	Description
affectedResources	URL of the resource group from which resources were removed

Action template

```
GET base-URL/v1/objects/resource-groups/object-ID/actions/remove-resource
```

Status codes

For details on the status codes of the request for this operation, see the description on HTTP status codes.

Coding example

To get an action template:

```
curl -v -H "Accept:application/json" -H "Content-Type:application/json" -H
"Authorization:Session d7b673af189048468c5af9bcf3b6bb6f" -X GET https://
192.0.2.100/ConfigurationManager/v1/objects/resource-groups/4/actions/
remove-resource
```

To run the request after getting an action template:

```
curl -v -H "Accept:application/json" -H "Content-Type:application/json" -H
"Authorization:Session d7b673af189048468c5af9bcf3b6bb6f" --data-binary @./
InputParameters.json -X POST https://192.0.2.100/ConfigurationManager/v1/
objects/resource-groups/4/actions/remove-resource/invoke
```

Deleting a resource group

The following request deletes unnecessary resource groups.

**Note:**

If you locked any resources of the target storage system by using the REST API, you will not be able to use this API function. In such cases, unlock the resources before running the API function.

Execution permission

Security Administrator (View & Modify)

Request line

```
DELETE base-URL/v1/objects/resource-groups/object-ID
```

Request message**Object ID**

Specify the value of `resourceGroupId` that was obtained by the processing to get information about resource groups.

Attribute	Type	Description
resourceGroupID	int	(Required) Resource group ID Specify a decimal (base 10) number in the range from 1 to 1023.

Query parameters

None.

Body

None.

Response message**Body**

A job object is returned. For details on attributes other than `affectedResources`, see the description on job objects.

Attribute	Description
<code>affectedResources</code>	URL of the deleted resource group

Status codes

For details on the status codes of the request for this operation, see the description on HTTP status codes.

Coding example

```
curl -v -H "Accept:application/json" -H "Content-Type:application/json" -H
"Authorization:Session d7b673af189048468c5af9bcf3b66b6f" -X DELETE
https://192.0.2.100/ConfigurationManager/v1/objects/resource-groups/4
```

Getting a list of user groups

The following request gets a list of user groups registered in the target storage system.

Execution permission

Security Administrator (View Only)

Request line

```
GET base-URL/v1/objects/user-groups
```

Request message**Object ID**

None.

Query parameters

None.

Body

None.

Response message**Body**

```
{
  "data": [
    {
      "userGroupObjectId": "devGroup",
      "userGroupId": "devGroup",
      "roleNames": [
        "Audit Log Administrator (View & Modify)"
      ],
      "resourceGroupIds": [
        1,
        2,
        3
      ],
      "isBuiltIn": false,
      "hasAllResourceGroup": false
    },
    {
      "userGroupObjectId": "adminGroup",
      "userGroupId": "adminGroup",
      "roleNames": [
        "Audit Log Administrator (View & Modify)",
        "Security Administrator (View & Modify)",
        "Storage Administrator (Initial Configuration)",
        "Storage Administrator (Local Copy)",
        "Storage Administrator (Performance Management)",
        "Storage Administrator (Provisioning)",
        "Storage Administrator (Remote Copy)",
        "Storage Administrator (System Resource Management)"
      ],
      "isBuiltIn": false,
      "hasAllResourceGroup": true
    }
  ]
}
```

Attribute	Type	Description
userGroupObjectId	string	The object ID for a user group ID An encoded character string is output if the user group ID includes reserved characters defined in RFC3986.
userGroupId	string	The user group ID
roleNames	string[]	The role name assigned to the user group
resourceGroupIds	int[]	The IDs of the resource groups assigned to the user group
isBuiltIn	boolean	Information about whether the user group is a built-in user group. <ul style="list-style-type: none"> <code>true</code>: A built-in user group. <code>false</code>: A user group created by a user.
hasAllResourceGroup	boolean	Information about whether all the resource groups are assigned to the target. <ul style="list-style-type: none"> <code>true</code>: All the resource groups are assigned. <code>false</code>: The specified resource groups are assigned.

Status codes

For details on the status codes of the request for this operation, see the description on HTTP status codes.

Coding example

```
curl -v -H "Accept:application/json" -H "Content-Type:application/json" -H "Authorization:Session d7b673af189048468c5af9bcf3bbbb6f" -X GET https://192.0.2.100/ConfigurationManager/v1/objects/user-groups
```

Getting information about a specific user group

The following request gets information about the specified user group.

Execution permission

Security Administrator (View Only)

Request line

```
GET base-URL/v1/objects/user-groups/object-ID
```

Request message**Object ID**

Set the `userGroupObjectId` value obtained by getting the information about the user group.

Attribute	Type	Description
<code>userGroupObjectId</code>	string	(Required) The object ID for a user group ID The object ID is case sensitive.

Query parameters

None.

Body

None.

Response message**Body**

```
{
  "userGroupObjectId": "devGroup",
  "userGroupId": "devGroup",
  "roleNames": [
    "Security Administrator (View Only)"
  ],
  "resourceGroupIds": [
    1,
    2,
    3
  ],
  "isBuiltIn": false,
  "hasAllResourceGroup": false
}
```

Attribute	Type	Description
<code>userGroupObjectI d</code>	string	The object ID for a user group ID

Attribute	Type	Description
		An encoded character string is output if the user group ID includes reserved characters defined in RFC 3986.
userGroupId	string	The user group ID
roleNames	string[]	The role name assigned to the user group
resourceGroupIds	int[]	The IDs of the resource groups assigned to the user group
isBuiltIn	boolean	Information about whether the user group is a built-in user group. <ul style="list-style-type: none"> <code>true</code>: A built-in user group. <code>false</code>: A user group created by a user.
hasAllResourceGroup	boolean	Information about whether all the resource groups are assigned to the target. <ul style="list-style-type: none"> <code>true</code>: All the resource groups are assigned. <code>false</code>: The specified resource groups are assigned.

Status codes

For details on the status codes of the request for this operation, see the description on HTTP status codes.

Coding example

```
curl -v -H "Accept:application/json" -H "Content-Type:application/json" -H "Authorization:Session d7b673af189048468c5af9bcf3b6bb6f" -X GET https://192.0.2.100/ConfigurationManager/v1/objects/user-groups/devGroup
```

Creating a user group

The following request creates a user group and assigns an appropriate role and resource groups.

**Note:**

If you locked any resources of the target storage system by using the REST API, you will not be able to use this API function. In such cases, unlock the resources before running the API function.

Execution permission

Security Administrator (View & Modify)

Request line

POST *base-URL/v1/objects/user-groups*

Request message**Object ID**

None.

Query parameters

None.

Body

```
{
  "userGroupId": "devGroup",
  "roleNames": [
    "Storage Administrator (Provisioning)"
  ],
  "resourceGroupIds": [
    8,
    9
  ],
  "hasAllResourceGroup": false
}
```

Attribute	Type	Description
userGroupId	string	(Required) The user group ID Specify an ID consisting of 1 to 64 characters.
roleNames	string[]	(Required) The role name

Attribute	Type	Description
		<p>Specify one or more of the following role names. The role names are case sensitive. If you specify multiple role names, delimit the names by commas.</p> <ul style="list-style-type: none"> ▪ Audit Log Administrator (View & Modify)[#] ▪ Audit Log Administrator (View Only)[#] ▪ Security Administrator (View & Modify)[#] ▪ Security Administrator (View Only)[#] ▪ Storage Administrator (Initial Configuration) ▪ Storage Administrator (Local Copy) ▪ Storage Administrator (Performance Management) ▪ Storage Administrator (Provisioning) ▪ Storage Administrator (Remote Copy) ▪ Storage Administrator (System Resource Management) ▪ Storage Administrator (View Only) ▪ Support Personnel[#] ▪ User Maintenance[#] <p>[#]: If you specify this role, be sure to specify <code>true</code> for <code>hasAllResourceGroup</code>.</p>
resourceGroupIds	int[]	<p>(Optional) The resource group IDs</p> <p>Specify one or more decimal (base 10) numbers within the range of 0 to 1023. If you specify multiple IDs, delimit the IDs by commas. This cannot be specified if the <code>hasAllResourceGroup</code> attribute is <code>true</code>.</p>
hasAllResourceGroup	boolean	<p>(Required) Information about whether all the resource groups are assigned to the target.</p>

Attribute	Type	Description
		<p>If the roles specified for <code>roleNames</code> include any of the following roles, be sure to specify <code>true</code> for this attribute.</p> <ul style="list-style-type: none"> ▪ Audit Log Administrator (View & Modify) ▪ Audit Log Administrator (View Only) ▪ Security Administrator (View & Modify) ▪ Security Administrator (View Only) ▪ Support Personnel ▪ User Maintenance <p>If the roles specified for <code>roleNames</code> does not include any of these roles, be sure to specify <code>false</code> for this attribute.</p>

Response message

Body

A job object is returned. For details on attributes other than `affectedResources`, see the section explaining job objects.

Attribute	Description
<code>affectedResources</code>	URL of the created user group

Status codes

For details on the status codes of the request for this operation, see the description on HTTP status codes.

Coding example

```
curl -v -H "Accept:application/json" -H "Content-Type:application/json" -H
"Authorization:Session d7b673af189048468c5af9bcf3bbbb6f" -X POST --data-
binary @./InputParameters.json https://192.0.2.100/ConfigurationManager/v1/
objects/user-groups
```

Changing the user group settings

The following request sets a user group ID and a role of the specified user group.



Note:

If you locked any resources of the target storage system by using the REST API, you will not be able to use this API function. In such cases, unlock the resources before running the API function.

Execution permission

Security Administrator (View & Modify)

Request line

```
PATCH base-URL/v1/objects/user-groups/object-ID
```

Request message

Object ID

Set the `userGroupObjectId` value obtained by getting the information about the user group.

Attribute	Type	Description
<code>userGroupObjectId</code>	string	(Required) The object ID for a user group ID The object ID is case sensitive.

Query parameters

None.

Body

The following coding example shows how to change the user group ID:

```
{
  "userGroupId": "adminGroup"
}
```

The following coding example shows how to change a role:

```
{
  "roleNames": [
    "Storage Administrator (Provisioning)",
    "Storage Administrator (Local Copy)"
  ]
}
```

```
]
}
```

Only one attribute can be specified in one request.

Attribute	Type	Description
userGroupId	string	(Optional) The user group ID Specify an ID consisting of 1 to 64 characters.
hasAllResourceGroup	boolean	(Optional) Information about whether all the resource groups are assigned to the target. If the roles specified for <code>roleNames</code> include any of the following roles, be sure to specify <code>true</code> for this attribute. <ul style="list-style-type: none"> ▪ Audit Log Administrator (View & Modify) ▪ Audit Log Administrator (View Only) ▪ Security Administrator (View & Modify) ▪ Security Administrator (View Only) ▪ Support Personnel ▪ User Maintenance If the roles specified for <code>roleNames</code> does not include any of these roles, be sure to specify <code>false</code> for this attribute.
roleNames	string[]	(Optional) The role name Specify one or more of the following role names. The role names are case sensitive. If you specify multiple role names, delimit the names by commas. <ul style="list-style-type: none"> ▪ Audit Log Administrator (View & Modify)[#] ▪ Audit Log Administrator (View Only)[#] ▪ Security Administrator (View & Modify)[#] ▪ Security Administrator (View Only)[#]

Attribute	Type	Description
		<ul style="list-style-type: none"> ▪ Storage Administrator (Initial Configuration) ▪ Storage Administrator (Local Copy) ▪ Storage Administrator (Performance Management) ▪ Storage Administrator (Provisioning) ▪ Storage Administrator (Remote Copy) ▪ Storage Administrator (System Resource Management) ▪ Storage Administrator (View Only) ▪ Support Personnel[#] ▪ User Maintenance[#] <p>[#]: If you specify this role, be sure to specify <code>true</code> for <code>hasAllResourceGroup</code>.</p>

Response message

Body

A job object is returned. For details on attributes other than `affectedResources`, see the section explaining job objects.

Attribute	Description
<code>affectedResources</code>	URL of the user group on which settings are changed

Action template

None.

Status codes

For details on the status codes of the request for this operation, see the description on HTTP status codes.

Coding example

```
curl -v -H "Accept:application/json" -H "Content-Type:application/json" -H
"Authorization:Session d7b673af189048468c5af9bcf3b6bb6f" -X PATCH
https://192.0.2.100/ConfigurationManager/v1/objects/user-groups/devGroup
```

Assigning resource groups to a user group

The following request assigns resource groups to a created user group.

**Note:**

If you locked any resources of the target storage system by using the REST API, you will not be able to use this API function. In such cases, unlock the resources before running the API function.

Execution permission

Security Administrator (View & Modify)

Request line

```
POST base-URL/v1/objects/user-groups/object-ID/actions/add-resource-group/
invoke
```

Request message**Object ID**

Set the `userGroupObjectId` value obtained by getting the information about the user group.

Attribute	Type	Description
<code>userGroupObjectId</code>	string	(Required) The object ID for a user group ID The object ID is case sensitive.

Query parameters

None.

Body

```
{
  "parameters": {
    "resourceGroupIds": [
      1,
      2
    ]
  }
}
```

```

    ]
  }
}

```

Attribute	Type	Description
resourceGroupIds	int[]	(Required) The resource group IDs Specify one or more decimal (base 10) numbers within the range of 0 to 1023. If you specify multiple IDs, delimit the IDs by commas.

Response message

Body

A job object is returned. For details on attributes other than `affectedResources`, see the section explaining job objects.

Attribute	Description
affectedResources	URL of the user group to which resource groups are assigned

Action template

```
GET base-URL/v1/objects/user-groups/object-ID/actions/add-resource-group
```

Status codes

For details on the status codes of the request for this operation, see the description on HTTP status codes.

Coding example

To get an action template:

```
curl -v -H "Accept:application/json" -H "Content-Type:application/json" -H
"Authorization:Session d7b673af189048468c5af9bcf3b6bbb6f" -X GET https://
192.0.2.100/ConfigurationManager/v1/objects/user-groups/devGroup/actions/
add-resource-group
```

To run the request after getting an action template:

```
curl -v -H "Accept:application/json" -H "Content-Type:application/json" -H
"Authorization:Session d7b673af189048468c5af9bcf3b6bbb6f" --data-binary @./
```



```
InputParameters.json -X POST https://192.0.2.100/ConfigurationManager/v1/objects/user-groups/devGroup/actions/add-resource-group/invoke
```

Releasing resource groups assigned to a user group

The following request releases resource groups assigned to a user group.



Note:

If you locked any resources of the target storage system by using the REST API, you will not be able to use this API function. In such cases, unlock the resources before running the API function.

Execution permission

Security Administrator (View & Modify)

Request line

```
POST base-URL/v1/objects/user-groups/object-ID/actions/remove-resource-group/invoke
```

Request message

Object ID

Set the `userGroupObjectId` value obtained by getting information about the user group.

Attribute	Type	Description
<code>userGroupObjectId</code>	string	(Required) The object ID for a user group ID The object ID is case sensitive.

Query parameters

None.

Body

```
{
  "parameters": {
    "resourceGroupIds": [
      1,
      2
    ]
  }
}
```

```
}
}
```

Attribute	Type	Description
resourceGroupIds	int[]	(Required) The resource group IDs Specify one or more decimal (base 10) numbers within the range of 0 to 1023. If you specify multiple IDs, delimit the IDs by commas.

Response message

Body

A job object is returned. For details on attributes other than `affectedResources`, see the section explaining job objects.

Attribute	Description
affectedResources	URL of the user group where assignment of resource groups is released

Action template

```
GET base-URL/v1/objects/user-groups/object-ID/actions/remove-resource-group
```

Status codes

For details on the status codes of the request for this operation, see the description on HTTP status codes.

Coding example

To get an action template:

```
curl -v -H "Accept:application/json" -H "Content-Type:application/json" -H
"Authorization:Session d7b673af189048468c5af9bcf3b66b6f" -X GET https://
192.0.2.100/ConfigurationManager/v1/objects/user-groups/devGroup/actions/
remove-resource-group
```

To run the request after getting an action template:

```
curl -v -H "Accept:application/json" -H "Content-Type:application/json" -H
"Authorization:Session d7b673af189048468c5af9bcf3b66b6f" --data-binary @./
```

```
InputParameters.json -X POST https://192.0.2.100/ConfigurationManager/v1/objects/user-groups/devGroup/actions/remove-resource-group/invoke
```

Deleting a user group

The following request deletes an unneeded user group. The request cannot delete a user group if the user group is assigned to a user.



Note:

If you locked any resources of the target storage system by using the REST API, you will not be able to use this API function. In such cases, unlock the resources before running the API function.

Execution permission

Security Administrator (View & Modify)

Request line

```
DELETE base-URL/v1/objects/user-groups/object-ID
```

Request message

Object ID

Set the `userGroupObjectId` value obtained by getting the information about the user group.

Attribute	Type	Description
<code>userGroupObjectId</code>	string	(Required) The object ID for a user group ID The object ID is case sensitive.

Query parameters

None.

Body

None.

Response message

Body

A job object is returned. For details on attributes other than `affectedResources`, see the section explaining job objects.

Attribute	Description
affectedResources	URL of the deleted user group

Status codes

For details on the status codes of the request for this operation, see the description on HTTP status codes.

Coding example

```
curl -v -H "Accept:application/json" -H "Content-Type:application/json" -H
"Authorization:Session d7b673af189048468c5af9bcf3b66b6f" -X DELETE
https://192.0.2.100/ConfigurationManager/v1/objects/user-groups/devGroup
```

Getting a list of users

The following request gets a list of user information registered on the target storage system.

Execution permission

Security Administrator (View Only)

Request line

```
GET base-URL/v1/objects/users
```

Request message**Object ID**

None.

Query parameters

None.

Body

None.

Response message**Body**

```
{
  "data": [
```

```

{
  "userObjectId": "devUser",
  "userId": "devUser",
  "authentication": "local",
  "userGroupNames": [
    "Audit Log Administrator (View Only) User Group",
    "Storage Administrator (View & Modify) User Group"
  ],
  "isBuiltIn": false,
  "isAccountStatus": true
},
{
  "userObjectId": "adminUser",
  "userId": "adminUser",
  "authentication": "local",
  "userGroupNames": [
    "Administrator User Group"
  ],
  "isBuiltIn": false,
  "isAccountStatus": true
}
]
}

```

Attribute	Type	Description
userObjectId	string	Object ID of the user ID If the user ID contains a reserved character defined in RFC 3986, the encoded character string is output.
userId	string	User ID
userGroupNames	string[]	User group name
isBuiltIn	boolean	Whether the user account is built-in <ul style="list-style-type: none"> <code>true</code>: Indicates a built-in user account <code>false</code>: Indicates that the account is created by the user
isAccountStatus	boolean	Status of the user account <ul style="list-style-type: none"> <code>true</code>: The user account is valid <code>false</code>: The user account is invalid

Attribute	Type	Description
authentication	string	Set authentication <ul style="list-style-type: none"> local: Authorized by the storage system external: Authorized by the external authentication server

Status codes

For details on the status codes of the request for this operation, see the description on HTTP status codes.

Coding example

```
curl -v -H "Accept:application/json" -H "Content-Type:application/json" -H
"Authorization:Session d7b673af189048468c5af9bcf3b66b6f" -X GET https://
192.0.2.100/ConfigurationManager/v1/objects/users
```

Getting information about a specific user

The following request gets information about the specified user.

Execution permission

Security Administrator (View Only)

Request line

```
GET base-URL/v1/objects/users/object-ID
```

Request message

Object ID

Specify the `userObjectId` value obtained by getting information about the user.

Attribute	Type	Description
userObjectId	string	(Required) Object ID of the user ID The name is case sensitive.

Query parameters

None.

Body

None.

Response message**Body**

```
{
  "userObjectId": "devUser",
  "userId": "devUser",
  "authentication": "local",
  "userGroupNames": [
    "Audit Log Administrator (View Only) User Group",
    "Storage Administrator (View & Modify) User Group"
  ],
  "isBuiltIn": false,
  "isAccountStatus": true
}
```

Attribute	Type	Description
userObjectId	string	Object ID of the user ID If the user ID contains a reserved character defined in RFC 3986, the encoded character string is output.
userId	string	User ID
userGroupNames	string[]	User group name
isBuiltIn	boolean	Whether the user account is built-in <ul style="list-style-type: none"> <code>true</code>: Indicates a built-in user account <code>false</code>: Indicates that the account is created by the user
isAccountStatus	boolean	Status of the user account <ul style="list-style-type: none"> <code>true</code>: The user account is valid <code>false</code>: The user account is invalid

Attribute	Type	Description
authentication	string	Set authentication <ul style="list-style-type: none"> ▪ <code>local</code>: Authorized by the storage system ▪ <code>external</code>: Authorized by the external authentication server

Status codes

For details on the status codes of the request for this operation, see the description on HTTP status codes.

Coding example

```
curl -v -H "Accept:application/json" -H "Content-Type:application/json" -H
"Authorization:Session d7b673af189048468c5af9bcf3b66b6f" -X GET https://
192.0.2.100/ConfigurationManager/v1/objects/users/devUser
```

Creating a user account

The following request creates a user account and assigns the user to user groups where appropriate permissions are specified. User accounts created by using the REST API can be used in Hitachi Device Manager - Storage Navigator.



Note:

If you locked any resources of the target storage system by using the REST API, you will not be able to use this API function. In such cases, unlock the resources before running the API function.

Execution permission

Security Administrator (View & Modify)

Request line

```
POST base-URL/v1/objects/users
```

Request message

Object ID

None.

Query parameters

None.

Body

```
{
  "userId": "devUser",
  "authentication": "local",
  "userPassword": "devPassword",
  "userGroupNames": [
    "Audit Log Administrator (View Only) User Group",
    "Storage Administrator (View & Modify) User Group"
  ]
}
```

Attribute	Type	Description
userId	string	(Required) User ID For details about the number of characters that can be specified for user IDs and the characters that can be used, see the description about input rules for user IDs and passwords.
userPassword	string	(Optional) Password The password cannot be specified if the <code>authentication</code> attribute is <code>external</code> . For details about the number of characters that can be specified for passwords and the characters that can be used, see the description about input rules for user IDs and passwords.
userGroupNames	string[]	(Required) User group name Specify a name consisting of 1 to 64 characters. You can specify up to 8 group names.
authentication	string	(Required) Set authentication <ul style="list-style-type: none"> ▪ <code>local</code>: Authorized by the storage system ▪ <code>external</code>: Authorized by the external authentication server

Response message**Body**

A job object is returned. For details on attributes other than `affectedResources`, see the section explaining job objects.

Attribute	Description
affectedResources	URL of the created user

Status codes

For details on the status codes of the request for this operation, see the description on HTTP status codes.

Coding example

```
curl -v -H "Accept:application/json" -H "Content-Type:application/json" -H
"Authorization:Session d7b673af189048468c5af9bcf3b66b6f" -X POST --data-
binary @./InputParameters.json https://192.0.2.100/ConfigurationManager/v1/
objects/users/
```

Changing the password of the user

The following request changes the password of a user account that performs operations on the storage system resources. The password cannot be changed for the user who is authorized by the external authentication server.



Note:

If you locked any resources of the target storage system by using the REST API, you will not be able to use this API function. In such cases, unlock the resources before running the API function.

Execution permission

Security Administrator (View & Modify)

Request line

```
PATCH base-URL/v1/objects/users/object-ID
```

Request message

Object ID

Specify the `userObjectId` value obtained by getting information about the user.

Attribute	Type	Description
userObjectId	string	(Required) Object ID of the user ID

Attribute	Type	Description
		The name is case sensitive.

Query parameters

None.

Body

```
{
  "userPassword": "userPass"
}
```

Attribute	Type	Description
userPassword	string	(Required) New password For details about the number of characters that can be specified for passwords and the characters that can be used, see the description about input rules for user IDs and passwords.

Response message**Body**

A job object is returned. For details on attributes other than `affectedResources`, see the section explaining job objects.

Attribute	Description
affectedResources	URL of the user whose password was changed

Action template

None.

Status codes

For details on the status codes of the request for this operation, see the description on HTTP status codes.

Coding example

```
curl -v -H "Accept:application/json" -H "Content-Type:application/json" -H
"Authorization:Session d7b673af189048468c5af9bcf3b6bb6f" -X PATCH
https://192.0.2.100/ConfigurationManager/v1/objects/users/devUser
```

Adding users to user groups

To add a user to a user group, assign the user group to the user object.

**Note:**

If you locked any resources of the target storage system by using the REST API, you will not be able to use this API function. In such cases, unlock the resources before running the API function.

Execution permission

Security Administrator (View & Modify)

Request line

```
POST base-URL/v1/objects/users/object-ID/actions/add-user-group/invoke
```

Request message**Object ID**

Specify the `userObjectId` value obtained by getting information about the user.

Attribute	Type	Description
<code>userObjectId</code>	string	(Required) Object ID of the user ID The name is case sensitive.

Query parameters

None.

Body

```
{
  "parameters": {
    "userGroupNames": [
      "System User Group"
    ]
  }
}
```

Attribute	Type	Description
userGroupNames	string[]	(Required) User group name Specify a name consisting of 1 to 64 characters. One user can belong to a maximum of You can specify up to 8 user groups.

Response message

Body

A job object is returned. For details on attributes other than `affectedResources`, see the section explaining job objects.

Attribute	Description
affectedResources	URL of the user who was added to the user group

Action template

```
GET base-URL/v1/objects/users/object-ID/actions/add-user-group
```

Status codes

For details on the status codes of the request for this operation, see the description on HTTP status codes.

Coding example

To get an action template:

```
curl -v -H "Accept:application/json" -H "Content-Type:application/json" -H
"Authorization:Session d7b673af189048468c5af9bcf3b6bb6f" -X GET https://
192.0.2.100/ConfigurationManager/v1/objects/users/devUser/actions/add-user-
group
```

To run the request after getting an action template:

```
curl -v -H "Accept:application/json" -H "Content-Type:application/json" -H
"Authorization:Session d7b673af189048468c5af9bcf3b6bb6f" --data-binary @./
InputParameters.json -X POST https://192.0.2.100/ConfigurationManager/v1/
objects/users/devUser/actions/add-user-group/invoke
```

Removing users from user groups

To remove a user from a user group, specify the user group that is associated with that user, and then release that user group from the user object. If only one user group is associated with a particular user, the user cannot be removed from that user group.



Note:

If you locked any resources of the target storage system by using the REST API, you will not be able to use this API function. In such cases, unlock the resources before running the API function.

Execution permission

Security Administrator (View & Modify)

Request line

POST *base-URL/v1/objects/users/object-ID/actions/remove-user-group/invoke*

Request message

Object ID

Specify the `userObjectId` value obtained by getting information about the user.

Attribute	Type	Description
<code>userObjectId</code>	string	(Required) Object ID of the user ID The name is case sensitive.

Query parameters

None.

Body

```
{
  "parameters": {
    "userGroupNames": [
      "System User Group"
    ]
  }
}
```

Attribute	Type	Description
<code>userGroupNames</code>	string[]	(Required) User group name

Attribute	Type	Description
		Specify a name consisting of 1 to 64 characters. One user can belong to a maximum of You can specify up to 8 user groups.

Response message

Body

A job object is returned. For details on attributes other than `affectedResources`, see the section explaining job objects.

Attribute	Description
<code>affectedResources</code>	URL of the user who was removed from the user group

Action template

```
GET base-URL/v1/objects/users/object-ID/actions/remove-user-group
```

Status codes

For details on the status codes of the request for this operation, see the description on HTTP status codes.

Coding example

To get an action template:

```
curl -v -H "Accept:application/json" -H "Content-Type:application/json" -H
"Authorization:Session d7b673af189048468c5af9bcf3bbbb6f" -X GET https://
192.0.2.100/ConfigurationManager/v1/objects/users/devUser/actions/remove-
user-group
```

To run the request after getting an action template:

```
curl -v -H "Accept:application/json" -H "Content-Type:application/json" -H
"Authorization:Session d7b673af189048468c5af9bcf3bbbb6f" --data-binary @./
InputParameters.json -X POST https://192.0.2.100/ConfigurationManager/v1/
objects/users/devUser/actions/remove-user-group/invoke
```

Deleting a user account

The following request deletes unnecessary user accounts. Built-in user accounts of the storage system cannot be deleted.



Note:

If you locked any resources of the target storage system by using the REST API, you will not be able to use this API function. In such cases, unlock the resources before running the API function.

Execution permission

Security Administrator (View & Modify)

Request line

```
DELETE base-URL/v1/objects/users/object-ID
```

Request message

Object ID

Specify the `userObjectId` value obtained by getting information about the user.

Attribute	Type	Description
<code>userObjectId</code>	string	(Required) Object ID of the user ID The name is case sensitive.

Query parameters

None.

Body

None.

Response message

Body

A job object is returned. For details on attributes other than `affectedResources`, see the section explaining job objects.

Attribute	Description
<code>affectedResources</code>	URL of the deleted user account

Status codes

For details on the status codes of the request for this operation, see the description on [HTTP status codes](#).

Coding example

```
curl -v -H "Accept:application/json" -H "Content-Type:application/json" -H  
"Authorization:Session d7b673af189048468c5af9bcf3bbbb6f" -X DELETE  
https://192.0.2.100/ConfigurationManager/v1/objects/users/devUser
```

Chapter 4: Parity group management

This chapter describes how to manage parity groups by using the REST API.

Overview of a parity group

A parity group is a set of physical drives that configure a RAID in a storage system.

A logical storage area extracted from a parity group is used as an LDEV (basic volume). To create an LDEV to be used for operations such as volume allocation or pool creation, you need to create a parity group in advance.

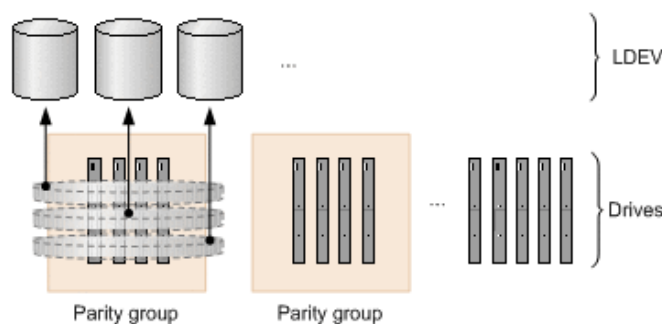

Parity group operations performed by the REST API are following:

- **Creating a parity group**

You can create a parity group when installing a new storage system or adding drives. You can configure a distributed parity group, or specify settings to encrypt a parity group or specify copy-back mode.
- **Changing the drive settings**

You can assign a specified drive as a spare drive, or release the assignment. The spare drive is used when a failure occurs in a drive that configures a parity group.
- **Changing the accelerated compression setting of a parity group**

You can enable or disable the accelerated compression setting for a parity group for which the accelerated compression function is supported.

- Formatting a parity group

You can format all volumes created from a parity group. When you create multiple volumes at the time a new storage system is installed or drives are added, you can collectively format the volumes.

- Deleting a parity group

You can delete a parity group. If the specified parity group is a parity group making up a distributed parity group, all concatenated parity groups are deleted.

For details on parity groups, see the *Provisioning Guide*.

Getting information about parity groups

The following request obtains information about all parity groups.

Execution permission

Storage Administrator (View Only)

Request line

```
GET base-URL/v1/objects/parity-groups
```

Request message

Object ID

None.

Query parameters

You can filter execution results by the specified condition and also collect additional detailed information about parity groups.

- When filtering execution results

Parameter	Type	Filtering condition
clprId	int	(Optional) CLPR number
driveTypeNa me	strin g	(Optional) Drive type You can specify the following values <ul style="list-style-type: none"> ▪ SAS ▪ SSD (MLC)

Parameter	Type	Filtering condition
		<ul style="list-style-type: none"> ▪ SSD (FMC) ▪ SSD (RI)
driveSpeed	int	(Optional) Drive rotation speed (rpm)

- When collecting additional detailed information

Parameter	Type	Description
detailInfoType	string	<p>(Optional) Type of information to be collected</p> <ul style="list-style-type: none"> ▪ FMC <p>For the parity groups whose drive type is SSD (FMC), add detailed information about accelerated compression.</p> <p>This parameter can be used together with the parameter for filtering execution results.</p>

Body

None.

Response message**Body**

```
{
  "data": [
    {
      "parityGroupId": "1-1",
      "numOfLdevs": 357,
      "usedCapacityRate": 13,
      "availableVolumeCapacity": 9410,
      "raidLevel": "RAID5",
      "raidType": "3D+1P",
      "clprId": 0,
      "driveType": "DKR2E-H4ROSS",
      "driveTypeName": "SAS",
      "driveSpeed": 7200,
      "totalCapacity": 10941,
      "physicalCapacity": 10941,
      "isAcceleratedCompressionEnabled": false
    },
    {
```

```

    "parityGroupId": "1-2",
    "numOfLdevs": 157,
    "usedCapacityRate": 36,
    "availableVolumeCapacity": 509,
    "raidLevel": "RAID5",
    "raidType": "3D+1P",
    "clprId": 0,
    "driveType": "DKR5C-K300SS",
    "driveTypeName": "SAS",
    "driveSpeed": 7200,
    "totalCapacity": 10941,
    "physicalCapacity": 10941,
    "isAcceleratedCompressionEnabled": false
  }
]
}

```

Attribute	Type	Description
parityGroupId	string	Parity group number
numOfLdevs	int	Number of assigned LDEVs
usedCapacityRate	int	Usage rate of the parity group
availableVolumeCapacity	long	Available capacity (GB) The amount of free space is output. If the capacity is below 1 GB, the value is truncated and 0 is output.
raidLevel	string	RAID level
raidType	string	RAID type
clprId	int	CLPR number
driveType	string	Code indicating the drive type of the drive belonging to the parity group
driveTypeName	string	Drive type of the drive belonging to the parity group
driveSpeed	int	Rotation speed (rpm) of the drive belonging to the parity group

Attribute	Type	Description
totalCapacity	long	Logical capacity of the parity group (GB) If the accelerated compression setting is enabled, the expanded capacity is output.
physicalCapacity	long	Physical capacity of the parity group (GB) For this attribute, 1 GB is equal to $1,024^3$ bytes. If the value of this attribute is less than 1 GB, 0 is displayed.
isAcceleratedCompressionEnabled	boolean	Value of the accelerated compression of the parity group <ul style="list-style-type: none"> ▪ <code>true</code>: Accelerated compression for the parity group is enabled. ▪ <code>false</code>: Accelerated compression for the parity group is disabled.

If you obtained detailed information about accelerated compression

When the drive type of the parity group is `SSD (FMC)`, if you specify `FMC` for the `detailInfoType` query parameter and then run the request, the following additional information is obtained.

Attribute	Type	Description
totalPhysicalCapacity	long	An invalid value is displayed.
isExpandedSpaceUsed	boolean	Whether LDEVs in parity groups use the expanded area <ul style="list-style-type: none"> ▪ <code>true</code>: LDEVs use the expanded area ▪ <code>false</code>: LDEVs use the physical area or are not implemented

Status codes

For details on the status codes of the request for this operation, see the description of HTTP status codes.

Coding example

```
curl -v -H "Accept:application/json" -H "Content-Type:application/json" -H
"Authorization:Session d7b673af189048468c5af9bcf3b6bb6f" -X GET https://
192.0.2.100/ConfigurationManager/v1/objects/parity-groups
```

Getting information about a specific parity group

The following request gets information about a specific parity group by specifying the parity group number. You can get detailed information about individual parity groups.

Execution permission

Storage Administrator (View Only)

Request line

```
GET base-URL/v1/objects/parity-groups/object-ID
```

Request message**Object ID**

Specify the `parityGroupId` value obtained by getting information about the parity group.

Attribute	Type	Description
parityGroupId	string	<p>(Required) Parity group number</p> <p>Specify concatenated parity groups in the same way as the above.</p> <p>If the concatenated parity groups are 1-3-1, 1-3-2, or 1-3-3, specify as follows:</p> <pre>"parityGroupId": "1-3"</pre>

Query parameters

None.

Body

None.

Response message**Body**

```
{
  "parityGroupId": "1-1",
  "numOfLdevs": 111,
  "usedCapacityRate": 35,
  "availableVolumeCapacity": 1551,
  "raidLevel": "RAID5",
  "raidType": "3D+1P",
  "clprId": 0,
  "driveType": "DKR5D-J900SS",
  "driveTypeName": "SAS",
  "driveSpeed": 10000,
  "isEncryptionEnabled": false,
  "totalCapacity": 2415,
  "physicalCapacity": 2415,
  "isAcceleratedCompressionEnabled": false,
  "spaces": [
    {
      "partitionNumber": 0,
      "ldevId": 3840,
      "status": "NML",
      "lbaLocation": "0x000000000000",
      "lbaSize": "0x000000200000"
    },
    {
      "partitionNumber": 1,
      "ldevId": 3841,
      "status": "NML",
      "lbaLocation": "0x000000200400",
      "lbaSize": "0x000000200000"
    },
    ...
  ]
}
```

Attribute	Type	Description
parityGroupId	string	Parity group number
numOfLdevs	int	Number of LDEVs in the parity group
usedCapacityRate	int	Usage rate of the parity group
availableVolumeCapacity	long	Available capacity (GB) The amount of free space is output. If the capacity is below 1 GB, the value is truncated and 0 is output.

Attribute	Type	Description
raidLevel	string	RAID level
raidType	string	RAID type
clprId	int	CLPR number
driveType	string	Code indicating the drive type of the drive belonging to the parity group is output.
driveTypeName	string	Drive type of the drive that belongs to the parity group
driveSpeed	int	Rotation speed (rpm) of the drive belonging to the parity group
isCopyBackModeEnabled	boolean	Value of the copy back mode setting of the parity group <ul style="list-style-type: none"> ▪ true: Copy back mode is enabled. ▪ false: Copy back mode is disabled.
isEncryptionEnabled	boolean	Value of the encryption setting of the parity group <ul style="list-style-type: none"> ▪ true: Encryption is enabled. ▪ false: Encryption is disabled.
totalCapacity	long	Logical capacity of the parity group (GB)
physicalCapacity	long	Physical capacity of the parity group (GB) For this attribute, 1 GB is equal to 1,024 ³ bytes. If the value of this attribute is less than 1 GB, 0 is displayed.
isAcceleratedCompressionEnabled	boolean	Value of the accelerated compression setting of the parity group <ul style="list-style-type: none"> ▪ true: Accelerated compression for the parity group is enabled. ▪ false: Accelerated compression for the parity group is disabled.

Attribute	Type	Description
spaces	object[]	<p>The following attributes related to free space and the LDEV defined in the parity group are output:</p> <ul style="list-style-type: none"> ▪ <code>partitionNumber</code> (long) Partition number of the partition created by partitioning the parity group ▪ <code>ldevId</code> (int) LDEV number ▪ <code>status</code> (string) LDEV status <ul style="list-style-type: none"> • <code>NML</code>: The LDEV is implemented, or the free space is determined. • <code>REG</code>: An LDEV is being created. • <code>DEL</code>: An LDEV is being deleted. ▪ <code>lbaLocation</code> (string) Starting location of the LBA of the partition in the parity group (in a multiple of 512 bytes) ▪ <code>lbaSize</code> (string) Size of the partition in the parity group (in a multiple of 512 bytes)

Status codes

For details on the status codes of the request for this operation, see the description on HTTP status codes.

Coding example

```
curl -v -H "Accept:application/json" -H "Content-Type:application/json" -H "Authorization:Session d7b673af189048468c5af9bcf3b6bb6f" -X GET https://192.0.2.100/ConfigurationManager/v1/objects/parity-groups/1-1
```

Getting a list of drive information

The request below gets a list of drive information.

Execution permission

Storage Administrator (View Only)

Request lineGET *base-URL/v1/objects/drives***Request message****Object ID**

None.

Query parameters

You can filter the execution results by specifying conditions and obtain additional detailed information about the drive.

- To filter the execution results:

Parameter	Type	Filter condition
parityGroupId	string	(Optional) The parity group number of the parity group to which the drive belongs
usageType	string	(Optional) Purpose for which the drive is used You can specify the following values as filter conditions: <ul style="list-style-type: none"> ▪ DATA: Data drive ▪ SPARE: Spare drive ▪ FREE: Unused drive
driveTypeName	string	(Optional) Drive type You can specify the following values as filter conditions: <ul style="list-style-type: none"> ▪ SAS ▪ SSD (MLC) ▪ SSD (FMC) ▪ SSD (RI) SSD (RI) can be specified only for VSP G350, G370, G700, G900 and VSP F350, F370, F700, F900 storage systems.
driveSpeed	int	(Optional) Drive rotation speed (rpm)
totalCapacity	long	(Optional) Physical capacity of the drive (GB)

Parameter	Type	Filter condition
		If the drive type is <code>SSD (FMD)</code> or <code>SSD (FMC)</code> , do not specify this parameter.

- To obtain additional detailed information:

Attribute	Type	Filter Condition
detailInfoType	string	<p>(Optional) Type of information to be collected</p> <ul style="list-style-type: none"> ▪ <code>usedEnduranceIndicator</code> If the drive type is <code>SSD (MLC)</code> or <code>SSD (FMC)</code>, additional detailed information about the drive's life expectancy is collected. ▪ <code>usageType</code> Additional detailed information about the usage of the drive is collected. <p>To specify multiple drive types, delimit them by using commas.</p> <p>You can use this parameter in combination with the query parameters that are used to filter the execution results.</p>

Body

None.

Response message**Body**

```
{
  "data": [
    {
      "driveLocationId": "0-0",
      "driveTypeName": "SAS",
      "driveSpeed": 10000,
      "totalCapacity": 600,
      "driveType": "DKR5D-J600SS",
      "usageType": "DATA",
      "status": "NML",

```

```

    "parityGroupId": "1-6",
    "serialNumber": "123456789012345678901"
  },
  {
    "driveLocationId": "0-1",
    "driveTypeName": "SAS",
    "driveSpeed": 10000,
    "totalCapacity": 600,
    "driveType": "DKR5D-J600SS",
    "usageType": "DATA",
    "status": "NML",
    "parityGroupId": "1-6",
    "serialNumber": "123456789012345678902"
  },
  {
    "driveLocationId": "0-2",
    "driveTypeName": "SAS",
    "driveSpeed": 10000,
    "totalCapacity": 600,
    "driveType": "DKR5D-J600SS",
    "usageType": "DATA",
    "status": "NML",
    "parityGroupId": "1-6",
    "serialNumber": "123456789012345678903"
  },
  {
    "driveLocationId": "0-3",
    "driveTypeName": "SAS",
    "driveSpeed": 10000,
    "totalCapacity": 600,
    "driveType": "DKR5D-J600SS",
    "usageType": "DATA",
    "status": "NML",
    "parityGroupId": "1-6",
    "serialNumber": "123456789012345678904"
  }
]
}

```

Attribute	Type	Description
driveLocationId	string	Drive location (location of the drive box)
driveTypeName	string	Drive type
driveSpeed	int	Drive rotation speed (rpm)

Attribute	Type	Description
totalCapacity	long	Drive capacity (GB) If the drive type is <i>SSD (FMD)</i> or <i>SSD (FMC)</i> , any value displayed for this attribute will be invalid.
driveType	string	Drive type code
usageType	string	Purpose for which the drive is used <ul style="list-style-type: none"> ▪ DATA: Data drive ▪ SPARE: Spare drive ▪ FREE: Unused drive
status	string	Status of the drive <ul style="list-style-type: none"> ▪ NML: Normal ▪ WAR: Part of the drive is blocked ▪ CPY: Copying is in progress ▪ CPI: Copying is incomplete ▪ RSV: The spare drive cannot be used ▪ FAI: The drive is blocked because of a failure ▪ BLK: The drive is blocked because maintenance is being performed ▪ Unknown: The status is unknown
parityGroupId	string	Parity group number This item is hidden when the drive does not belong to any parity group.
serialNumber	string	Serial number of the drive

The following is an example of the detailed information that can be output about the drive's life expectancy.

```
{
  "data": [
    {
      "driveLocationId": "4-0",
      "driveTypeName": "SSD (FMC)",
      "totalCapacity": 1600,

```

```

    "driveType": "NFHAE-Q1R6SS",
    "usageType": "DATA",
    "status": "NML",
    "parityGroupId": "3-1",
    "serialNumber": "12345670",
    "usedEnduranceIndicator": 0,
    "usedEnduranceIndicatorThreshold": 99,
    "usedEnduranceIndicatorWarningSIM": 95
  },
  {
    "driveLocationId": "4-1",
    "driveTypeName": "SSD(FMC)",
    "totalCapacity": 1600,
    "driveType": "NFHAE-Q1R6SS",
    "usageType": "DATA",
    "status": "NML",
    "parityGroupId": "3-1",
    "serialNumber": "12345671",
    "usedEnduranceIndicator": 0,
    "usedEnduranceIndicatorThreshold": 99,
    "usedEnduranceIndicatorWarningSIM": 95
  },
  {
    "driveLocationId": "4-2",
    "driveTypeName": "SSD(FMC)",
    "totalCapacity": 1600,
    "driveType": "NFHAE-Q1R6SS",
    "usageType": "DATA",
    "status": "NML",
    "parityGroupId": "3-1",
    "serialNumber": "12345672",
    "usedEnduranceIndicator": 0,
    "usedEnduranceIndicatorThreshold": 99,
    "usedEnduranceIndicatorWarningSIM": 95
  }
]
}

```

To obtain detailed information about the drive's life expectancy:

If the drive type is SSD (MLC) or SSD (FMC), you can obtain the following information by executing the request with `usedEnduranceIndicator` specified for the `detailInfoType` query parameter.

Attribute	Type	Description
<code>usedEnduranceIndicator</code>	int	Life expectancy of the drive (%)

Attribute	Type	Description
		A value in the range from 0 to 100 is displayed. A large value indicates that the drive is near the end of its life expectancy.
usedEnduranceIndicatorThreshold	int	Threshold value of the drive's life expectancy (%) If the value of the drive's life expectancy exceeds this value, data on the drive will be automatically copied to a spare drive.
usedEnduranceIndicatorWarningSIM	int	Threshold value of the warning SIM (%) If the value of the drive's life expectancy exceeds this value, error information (SIM) will be output.

The following is an example of the detailed information that can be output about the drive usage.

```
{
  "data": [
    {
      "driveLocationId": "0-0",
      "driveTypeName": "SAS",
      "driveSpeed": 10000,
      "totalCapacity": 600,
      "driveType": "DKS5H-J600SS",
      "usageType": "DATA",
      "detailUsageType": "DATA",
      "status": "NML",
      "parityGroupId": "1-1",
      "serialNumber": "12345670"
    },
    {
      "driveLocationId": "0-1",
      "driveTypeName": "SAS",
      "driveSpeed": 10000,
      "totalCapacity": 600,
      "driveType": "DKS5H-J600SS",
      "usageType": "DATA",
      "detailUsageType": "DATA",
      "status": "NML",
      "parityGroupId": "1-1",
      "serialNumber": "12345671"
    }
  ]
}
```



```

    },
    {
      "driveLocationId": "0-2",
      "driveTypeName": "SAS",
      "driveSpeed": 10000,
      "totalCapacity": 600,
      "driveType": "DKS5H-J600SS",
      "usageType": "DATA",
      "detailUsageType": "DATA",
      "status": "NML",
      "parityGroupId": "1-1",
      "serialNumber": "12345671"
    },
    {
      "driveLocationId": "0-3",
      "driveTypeName": "SAS",
      "driveSpeed": 10000,
      "totalCapacity": 600,
      "driveType": "DKS5H-J600SS",
      "usageType": "DATA",
      "detailUsageType": "DATA",
      "status": "NML",
      "parityGroupId": "1-1",
      "serialNumber": "12345671"
    }
  ]
}

```

To obtain detailed information about the drive usage:

You can obtain the following information by specifying `usageType` for the `detailInfoType` query parameter.

Attribute	Type	Description
detailUsageType	string	Details about the usage of the drive <ul style="list-style-type: none"> ▪ DATA: Data drive ▪ SPARE: Spare drive ▪ FREE: Unused drive ▪ SWAP: the drive that is swapped a spare drive for a data drive ▪ RESERVE: the unused drive that is swapped a data drive for a spare drive

Status codes

For details on the status codes of the request for this operation, see the description of HTTP status codes.

Coding example

```
curl -v -H "Accept:application/json" -H "Content-Type:application/json" -H
"Authorization:Session d7b673af189048468c5af9bcf3bbbb6f" -X GET https://
192.0.2.100/ConfigurationManager/v1/objects/drives
```

Getting information about a specific drive

The request below allows you to get information about a specific drive by specifying the drive location (the location of the drive box).

Execution permission

Storage Administrator (View Only)

Request line

```
GET base-URL/v1/objects/drives/object-ID
```

Request message**Object ID**

Specify the `driveLocationId` value obtained by getting information about the drive list.

Attribute	Type	Description
<code>driveLocationId</code>	string	(Required) Drive location (location of the drive box)

Query parameters

None.

Body

None.

Response message**Body**

```
{
  "driveLocationId": "0-0",
  "driveTypeName": "SAS",
  "driveSpeed": 10000,
  "totalCapacity": 600,
  "driveType": "DKR5D-J600SS",
  "usageType": "DATA",
  "status": "NML",
  "parityGroupId": "1-6",
  "serialNumber": "123456789012345678901"
}
```

Attribute	Type	Description
driveLocationId	string	Drive location
driveTypeName	string	Drive type
driveSpeed	int	Drive rotation speed (rpm)
totalCapacity	long	Drive capacity (GB) If the drive type is SSD (FMD) or SSD (FMC), any value displayed for this attribute will be invalid.
driveType	string	Drive type code
usageType	string	Purpose for which the drive is used <ul style="list-style-type: none"> ▪ DATA: Data drive ▪ SPARE: Spare drive ▪ FREE: Unused drive
status	string	Status of the drive <ul style="list-style-type: none"> ▪ NML: Normal ▪ WAR: Part of the drive is blocked ▪ CPY: Copying is in progress ▪ CPI: Copying is incomplete ▪ RSV: The spare drive cannot be used ▪ FAI: The drive is blocked because of a failure

Attribute	Type	Description
		<ul style="list-style-type: none"> BLK: The drive is blocked because maintenance is being performed Unknown: The status is unknown
parityGroupId	string	<p>The parity group number of the parity group to which the drive belongs</p> <p>This item is hidden when the drive does not belong to any parity group.</p>
serialNumber	string	Serial number of the drive

Status codes

For details on the status codes of the request for this operation, see the description of HTTP status codes.

Coding example

```
curl -v -H "Accept:application/json" -H "Content-Type:application/json" -H
"Authorization:Session d7b673af189048468c5af9bcf3bbbb6f" -X GET https://
192.0.2.100/ConfigurationManager/v1/objects/drives/0-0
```

Creating a parity group

The request below creates a parity group.

Execution permission

Storage Administrator (Provisioning)

Request line

```
POST base-URL/v1/objects/parity-groups
```

Request message

Object ID

None.

Query parameters

None.

Body

The following coding example creates a parity group:

```
{
  "parityGroupId": "2-10",
  "driveLocationIds": ["1-1", "1-2", "1-3", "1-4"],
  "raidType": "3D+1P",
  "isEncryptionEnabled": false,
  "isCopyBackModeEnabled": true,
  "isAcceleratedCompressionEnabled": true,
  "clprId": 1
}
```

The following coding example creates a distributed parity group by concatenating two parity groups:

```
{
  "concatenatedParityGroupIds": ["2-9", "2-10"],
  "driveLocationIds": ["1-1", "1-2", "1-3", "1-4", "1-5", "1-6", "1-7", "1-8"],
  "raidType": "2D+2D",
  "isEncryptionEnabled": false,
  "isCopyBackModeEnabled": true,
  "isAcceleratedCompressionEnabled": true,
  "clprId": 1
}
```

Attribute	Type	Description
parityGroupId	string	(Optional) Parity group number Specify the number in <i>gno-sgno</i> format. Be sure to specify the <code>parityGroupId</code> attribute or the <code>concatenatedParityGroupIds</code> attribute.
concatenatedParityGroupIds	string[]	(Optional) To configure a distributed parity group, specify the parity group numbers of concatenated parity groups. The concatenated parity groups will be created in the order in which the <code>driveLocationIds</code> attribute is specified.

Attribute	Type	Description
		Be sure to specify the <code>parityGroupId</code> attribute or the <code>concatenatedParityGroupIds</code> attribute.
<code>driveLocationIds</code>	<code>string[]</code>	(Required) Drive location Specify the locations of the drives to be used to create the parity group.
<code>raidType</code>	<code>string</code>	(Required) RAID type Specify one of the following values: <ul style="list-style-type: none"> ▪ <code>2D+2D</code> ▪ <code>3D+1P</code> ▪ <code>4D+1P</code> ▪ <code>6D+1P</code> ▪ <code>7D+1P</code> ▪ <code>6D+2P</code> ▪ <code>12D+2P</code> ▪ <code>14D+2P</code>
<code>isEncryptionEnabled</code>	<code>boolean</code>	(Optional) Specify whether to enable the encryption function for the parity group. <ul style="list-style-type: none"> ▪ <code>true</code>: Enable the encryption function. ▪ <code>false</code>: Disable the encryption function. You cannot specify <code>true</code> if you specify <code>true</code> for the <code>isAcceleratedCompressionEnabled</code> attribute. If you omit this item, <code>false</code> will be set.
<code>isCopyBackModeEnabled</code>	<code>boolean</code>	(Optional) Specify whether to enable copy back mode for the parity group. <ul style="list-style-type: none"> ▪ <code>true</code>: Enable copy back mode. ▪ <code>false</code>: Disable copy back mode. If you omit this item, <code>true</code> will be set.

Attribute	Type	Description
isAcceleratedCompressionEnabled	boolean	<p>(Optional) Specify whether to enable accelerated compression for the parity group.</p> <ul style="list-style-type: none"> ▪ <code>true</code>: Enable accelerated compression. ▪ <code>false</code>: Disable accelerated compression. <p>You cannot specify <code>true</code> if you specify <code>true</code> for the <code>isEncryptionEnabled</code> attribute.</p> <p>If you omit this item, <code>false</code> will be set.</p>
clprId	int	<p>(Optional) CLPR number</p> <p>Specify a CLPR number in the range from 0 to 31.</p> <p>If you omit this item, 0 will be set.</p>

Response message

Body

A job object is returned. For details on the attributes other than `affectedResources`, see the section explaining job objects.

Attribute	Description
<code>affectedResources</code>	URL of the created parity group

Status codes

The following table describes the meaning of the status code of the request for this operation. For details on other status codes, see the section explaining HTTP status codes.

Status codes	Message	Description
409	Conflict	The parity group is already created with the specified parity group number or the concatenated parity group number.

Coding example

```
curl -v -H "Accept:application/json" -H "Content-Type:application/json" -H
"Authorization:Session d7b673af189048468c5af9bcf3b66b6f" -X POST --data-
binary @./InputParameters.json https://192.0.2.100/ConfigurationManager/v1/
objects/parity-groups
```

Changing the drive settings

The request below configures a drive. You can use this request to assign a specified drive as a spare drive and to release the assignment of a specified drive.

Execution permission

Storage Administrator (Provisioning)

Request line

```
PATCH base-URL/v1/objects/drives/object-ID
```

Request message**Object ID**

Specify the `driveLocationId` value obtained by getting information about the drive list.

Attribute	Type	Description
<code>driveLocationId</code>	string	(Required) Drive location (location of the drive box)

Query parameters

None.

Body

```
{
  "isSpareEnabled": false
}
```

Attribute	Type	Description
isSpareEnabled	boolean	(Required) Spare drive setting <ul style="list-style-type: none"> ▪ <code>true</code>: Assigns the specified drive as a spare drive. ▪ <code>false</code>: Releases the assignment as a spare drive.

Response message

Body

A job object is returned. For details on the attributes other than `affectedResources`, see the section explaining job objects.

Attribute	Description
<code>affectedResources</code>	URL of the drive whose setting was changed

Status codes

For details on the status codes of the request for this operation, see the description of HTTP status codes.

Action template

None.

Coding example

```
curl -v -H "Accept:application/json" -H "Content-Type:application/json" -H "Authorization:Session d7b673af189048468c5af9bcf3bbbb6f" -X PATCH --data-binary @./InputParameters.json https://192.0.2.100/ConfigurationManager/v1/objects/drives/0-0
```

Changing the accelerated compression setting of a parity group

The request below enables or disables accelerated compression for a parity group. You can use this API request for parity groups for which accelerated compression is supported.

Execution permission

Storage Administrator (Provisioning)

Request line

```
PATCH base-URL/v1/objects/parity-groups/object-ID
```

Request message**Object ID**

Specify the `parityGroupId` value obtained by getting information about the parity group.

Attribute	Type	Description
<code>parityGroupId</code>	string	<p>(Required) Parity group number</p> <p>Specify concatenated parity groups in the same way as the above.</p> <p>If the concatenated parity groups are 1-3-1, 1-3-2, or 1-3-3, specify as follows:</p> <pre>"parityGroupId": "1-3"</pre>

Query information

None.

Body

```
{
  "isAcceleratedCompressionEnabled": true
}
```

Attribute	Type	Description
<code>isAcceleratedCompressionEnabled</code>	boolean	<p>(Required) Specify whether to enable accelerated compression for the parity group.</p> <ul style="list-style-type: none"> ▪ <code>true</code>: Enable accelerated compression. ▪ <code>false</code>: Disable accelerated compression.

Response message**Body**

A job object is returned. For details on the attributes other than `affectedResources`, see the section explaining job objects.

Attribute	Description
<code>affectedResources</code>	URL of the parity group whose setting was changed

Status codes

For details on the status codes of the request for this operation, see the description of HTTP status codes.

Coding example

```
curl -v -H "Accept:application/json" -H "Content-Type:application/json" -H
"Authorization:Session d7b673af189048468c5af9bcf3b666f" -X PATCH --data-
binary @./InputParameters.json https://192.0.2.100/ConfigurationManager/v1/
objects/parity-groups/1-7
```

Formatting a parity group

The request below formats all volumes created from a parity group.

Execution permission

Storage Administrator (Provisioning)

Request line

```
POST base-URL/v1/objects/parity-groups/object-ID/actions/format/invoke
```

Request message**Object ID**

Specify the `parityGroupId` value obtained by getting information about the parity group.

Attribute	Type	Description
<code>parityGroupId</code>	string	(Required) Parity group number

Attribute	Type	Description
		Specify concatenated parity groups in the same way as the above. If the concatenated parity groups are 1-3-1, 1-3-2, or 1-3-3, specify as follows: "parityGroupId": "1-3"

Query parameters

None.

Body

None.

Response message**Body**

A job object is returned. For details, see the section explaining job objects. This API function does not display the `affectedResources` attribute. Formatting is performed when the `state` attribute of the job object is `Succeeded`. To check whether the formatting of each volume is complete, use the following URL. For *parity-group-number*, specify the parity group number that was specified for the object ID.

```
GET base-URL/v1/objects/ldevs?parityGroupId=parity-group-number
```

Action template

None.

Status codes

For details on the status codes of the request for this operation, see the description of HTTP status codes.

Coding example

```
curl -v -H "Accept:application/json" -H "Content-Type:application/json" -H
"Authorization:Session d7b673af189048468c5af9bcf3b66b6f" -X POST https://
192.0.2.100/ConfigurationManager/v1/objects/parity-groups/1-7/actions/
format/invoke -d ""
```

Deleting a parity group

The request below deletes a parity group. If the specified parity group is concatenated with other parity groups, all of the concatenated parity groups are deleted.

Execution permission

Storage Administrator (Provisioning)

Request line

```
DELETE base-URL/v1/objects/parity-groups/object-ID
```

Request message

Object ID

Specify the `parityGroupId` value obtained by getting information about the parity group.

Attribute	Type	Description
parityGroupId	string	<p>(Required) Parity group number</p> <p>Specify concatenated parity groups in the same way as the above.</p> <p>If the concatenated parity groups are 1-3-1, 1-3-2, or 1-3-3, specify as follows:</p> <pre>"parityGroupId": "1-3"</pre>

Query parameters

None.

Body

None.

Response message

Body

A job object is returned. For details on the attributes other than `affectedResources`, see the section explaining job objects.

Attribute	Description
affectedResources	URL of the deleted parity group

Status codes

For details on the status codes of the request for this operation, see the description of HTTP status codes.

Coding example

```
curl -v -H "Accept:application/json" -H "Content-Type:application/json" -H  
"Authorization:Session d7b673af189048468c5af9bcf3bbbb6f" -X DELETE  
https://192.0.2.100/ConfigurationManager/v1/objects/parity-groups/1-1
```

Chapter 5: Volume allocation

This chapter describes how to allocate volumes to hosts by using the REST API.

Overview of volume allocation

Volume allocation means setting LU paths to allow the host to access volumes in the storage system.

In the REST API, allocate a volume by performing the following procedure:

1. Create a volume that meets the host requirements.

You can either use a volume that meets the requirements from an existing LDEV or create an LDEV from the parity group or pool.

When the host is connected to the external storage system by using Universal Volume Manager, you can create an external volume from an existing external parity group (external volume group).

2. Configure a port.

Configure a host group or an iSCSI target for the storage system port. Register information about the host that is to access the LDEV in the host group or the iSCSI target.

Specify the host mode and host mode options according to the host type.

3. Set the LU path.

Setting the LU path between the LDEV and the port's host group or iSCSI target enables access from the host to the LDEV.

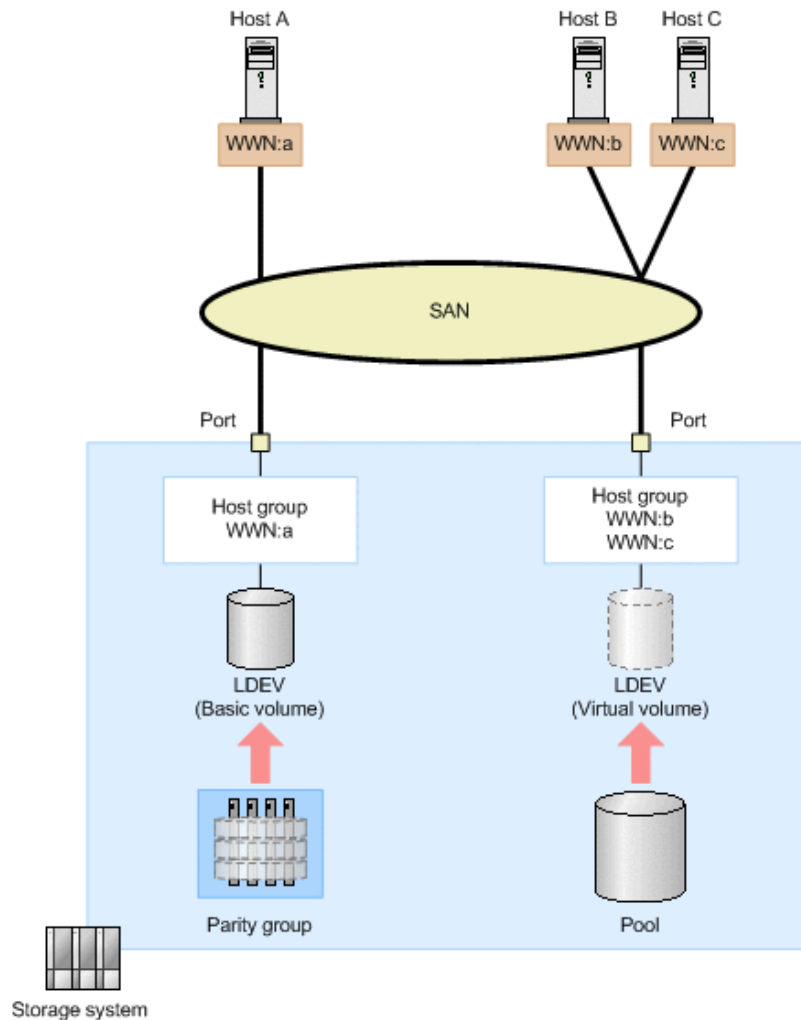

In the preceding figure, an LDEV is created from the parity group, and the LU path is set for the host group in which the WWN of host A is registered. In addition, another LDEV is created from the DP pool, and the LU path is set for the host group in which the WWNs of host B and host C are registered. By registering the WWNs of multiple hosts in the host group, you can apply the same settings for accessing the LDEV to the hosts at the same time.

For details about the requirements for creating volumes and how to specify settings for host groups or iSCSI targets, see the *Provisioning Guide*.

Getting information about the capacity of a storage system

The following request gets information about the total capacity and the size of free space of all parity groups configured in the target storage system.

**Important:**

The size of free space (`freeSpace`) and the total capacity (`totalCapacity`) do not include the size of areas where, because of boundary limitations, volumes cannot be created. For this reason, after certain operations, such as those to create or delete volumes, the total capacity value might change. For details about volume capacity, see the *Provisioning Guide* for the storage system.

Execution permission

Storage Administrator (View Only)

Request line

```
GET base-URL/v1/objects/total-capacities/instance
```

Request message**Object ID**

Specify a value for `instance`. For objects that have only one instance, the value of `instance` is a fixed value (the object ID).

Query parameters

None.

Body

None.

Response message**Body**

```
{
  "internal": {
    "freeSpace": 30405195264,
    "totalCapacity": 34921689272
  },
  "external": {
    "freeSpace": 0,
    "totalCapacity": 142606336
  },
  "total": {
    "freeSpace": 30405195264,
    "totalCapacity": 35064295608
  }
}
```

Attribute	Type	Description
internal	object	<p>An attribute related to the capacity of internal volumes is output.</p> <ul style="list-style-type: none"> <li data-bbox="695 348 932 380">▪ freeSpace (long) The amount of free space in which users can create volumes (KB) <li data-bbox="695 499 971 531">▪ totalCapacity (long) The sums of the total capacity and the size of free space of all volumes created by the user (KB)
external	object	<p>An attribute related to the capacity of external volumes is output.</p> <p>If no external volumes are connected, the value 0 is output.</p> <ul style="list-style-type: none"> <li data-bbox="695 827 932 858">▪ freeSpace (long) The amount of free space in which users can create volumes (KB) <li data-bbox="695 978 971 1010">▪ totalCapacity (long) The sums of the total capacity and the size of free space of all volumes created by the user (KB)
total	object	<p>An attribute related to the total capacity of internal volumes and external volumes is output.</p> <ul style="list-style-type: none"> <li data-bbox="695 1226 932 1257">▪ freeSpace (long) The amount of free space in which users can create volumes (KB) <li data-bbox="695 1377 971 1409">▪ totalCapacity (long) The sums of the total capacity and the size of free space of all volumes created by the user (KB)

Status codes

For details on the status codes of the request for this operation, see the description on HTTP status codes.

Coding example

```
curl -v -H "Accept:application/json" -H "Content-Type:application/json" -H
"Authorization:Session d7b673af189048468c5af9bcf3b6bb6f" -X GET https://
192.0.2.100/ConfigurationManager/v1/objects/total-capacities/instance
```

Getting information about the total efficiency of a storage system

Obtain information about the saving efficiency for consumption of capacity (total efficiency) achieved by using the functions for increasing the usage efficiency of a storage system such as the capacity saving function (dedupe and compression), the accelerated compression function, the creation of backup data by using snapshots, and the virtualization of capacity by using Dynamic Provisioning.

Execution permission

Storage Administrator (View Only)

Request line

```
GET base-URL/v1/objects/total-efficiencies/instance
```

Request message**Object ID**

Specify *instance*. If an object has only one instance, the value for *instance* is the fixed value that specifies the object ID.

Query parameters

None.

Body

None.

Response message**Body**

```
{
  "isCalculated" : true,
  "totalRatio" : "8.46",
  "compressionRatio" : "1.18",
  "snapshotRatio" : "97.21",
  "provisioningRate" : "85",
  "calculationStartTime" : "2016-07-31T16:55:07Z",
```

```

"calculationEndTime" : "2016-07-31T17:06:35Z",
"dedupeAndCompression" : {
  "totalRatio" : "1.47",
  "compressionRatio" : "1.08",
  "dedupeRatio" : "1.35",
  "reclaimRatio" : "1.00"
},
"acceleratedCompression" : {
  "totalRatio" : "1.11",
  "compressionRatio" : "1.10",
  "reclaimRatio" : "1.00"
}
}

```

Attribute	Type	Description
isCalculated	boolean	<p>Calculation status of the total efficiency</p> <p>This attribute indicates whether the total efficiency has been calculated.</p> <ul style="list-style-type: none"> <code>true</code>: The values have been calculated. <code>false</code>: The values have not been calculated. <p>Information about the other attributes will only be obtained if the value for this attribute is <code>true</code>.</p>
calculationStartTime	ISO8601string	<p>The date and time when the calculation of the total efficiency began (UTC)</p> <p>The local time of the storage system is displayed in YYYY-MM-DDThh:mm:ssZ format.</p>
calculationEndTime	ISO8601string	<p>The date and time when the calculation of the total efficiency ended (UTC)</p> <p>The local time of the storage system is displayed in YYYY-MM-DDThh:mm:ssZ format.</p>
totalRatio	string	<p>The total efficiency of the entire storage system[#]</p> <p>This does not include the size of metadata, garbage data, and other similar data generated by the storage system.</p> <p>If the volume for which the calculation is to be performed does not exist, a hyphen (-) indicating an invalid value is displayed.</p>

Attribute	Type	Description
		<p>If the calculation cannot be performed for the volume because the volume is blocked or some other reason, the value from the previous calculation is displayed.</p> <p>After a volume is created from a pool and before data is written to the volume, the maximum value (92233720368547758.07) is displayed.</p>
compressionRatio	string	<p>The efficiency of capacity saving performed by using the capacity saving function (dedupe and compression) or accelerated compression[#]</p> <p>This does not include the size of metadata, garbage data, and other similar data generated by the storage system.</p> <p>If the volume for which the calculation is to be performed does not exist, a hyphen (-) indicating an invalid value is displayed.</p> <p>If the calculation cannot be performed for the volume because the volume is blocked or some other reason, the value from the previous calculation is displayed.</p>
snapshotRatio	string	<p>The efficiency of capacity saving performed by using snapshots to back up data[#]</p> <p>This does not include the size of metadata, garbage data, and other similar data generated by the storage system.</p> <p>If the volume for which the calculation is to be performed does not exist, a hyphen (-) indicating an invalid value is displayed.</p> <p>If the calculation cannot be performed for the volume because the volume is blocked or some other reason, the value from the previous calculation is displayed.</p>
provisioningRate	string	<p>The percentage (%) of saving efficiency for consumption of capacity achieved by using Dynamic Provisioning to virtualize capacity</p> <p>This does not include the size of metadata, garbage data, and other similar data generated by the storage system.</p>

Attribute	Type	Description
		<p>If the volume for which the calculation is to be performed does not exist, a hyphen (-) indicating an invalid value is displayed.</p> <p>If the calculation cannot be performed for the volume because the volume is blocked or some other reason, the value from the previous calculation is displayed.</p>
dedupeAndCompression	object	<p>Attributes related to the efficiency of capacity saving performed by using the capacity saving function (dedupe and compression) are displayed.</p> <p>This does not include the size of metadata, garbage data, and other similar data generated by the storage system.</p> <p>If the volume for which the calculation is to be performed does not exist, a hyphen (-) indicating an invalid value is displayed.</p> <p>If the calculation cannot be performed for the volume because the volume is blocked or some other reason, the value from the previous calculation is displayed.</p> <ul style="list-style-type: none"> ▪ totalRatio (string) total efficiency of capacity saving performed by using the capacity saving function[#] ▪ compressionRatio (string) Efficiency of capacity saving performed by using compression[#] ▪ dedupeRatio (string) Efficiency of capacity saving performed by using deduplication (dedupe)[#] ▪ reclaimRatio (string) Efficiency of capacity saving performed by reclaiming the specified data pattern[#]
acceleratedCompression	object	Attributes related to the efficiency of capacity saving performed by using accelerated compression are displayed.

Attribute	Type	Description
		<p>This does not include the size of metadata, garbage data, and other similar data generated by the storage system.</p> <p>If the volume for which the calculation is to be performed does not exist, a hyphen (-) indicating an invalid value is displayed.</p> <p>If the calculation cannot be performed for the volume because the volume is blocked or some other reason, the value from the previous calculation is displayed.</p> <ul style="list-style-type: none"> ▪ totalRatio (string) Total efficiency of capacity saving performed by using accelerated compression[#] ▪ compressionRatio (string) Efficiency of capacity saving performed by using compression[#] ▪ reclaimRatio (string) Efficiency of capacity saving performed by reclaiming the specified data pattern[#]

[#]: This value represents the capacity before reduction as a ratio of the capacity after reduction, where the capacity after reduction is 1.

Status codes

For details on the status codes of the request for this operation, see the section explaining HTTP status codes.

Coding example

```
curl -v -H "Accept:application/json" -H "Content-Type:application/json" -H
"Authorization:Session d7b673af189048468c5af9bcf3b6bb6f" -X GET https://
192.0.2.100/ConfigurationManager/v1/objects/total-efficiencies/instance
```

Getting volume information

The following request obtains information about multiple LDEVs. You can get information about consecutive LDEVs by specifying the number of the first LDEV and the

number of LDEVs. You can also get information filtered by LDEV conditions (attributes) or resource group.

Execution permission

Storage Administrator (View Only)

Request line

```
GET base-URL/v1/objects/ldevs
```

Request message

Object ID

None.

Query parameters

You can filter the execution result by specifying conditions, or request additional detailed volume information.

- When filtering the execution result

You can obtain information about 100 LDEVs by default, and information about 16,384 LDEVs by specifying the `count` parameter. If information about more than 16,384 LDEVs is obtained by specifying the `ldevOption` parameter or the `poolId` parameter, use the `headLdevId` parameter to obtain information about 16,385 or more LDEVs.



Important:

For this API, the number of concurrent executions might be restricted due to the number of LDEVs to be obtained and the details of other processing to be executed at the same time. For details about restriction conditions, see the notes about the number of concurrent executions.

For details on query parameters that can be specified at the same time, see the following table showing the combinations of query parameters that can be specified.

Parameter	Type	Filter Condition
count	int	(Optional) Specify a value from 1 to 16384 for the number of LDEVs for which information is to be obtained. If this parameter is omitted, information about 100 LDEVs will be obtained.
headLdevId	int	(Optional) Specify the number of the LDEV from which processing to get information is to start.

Parameter	Type	Filter Condition
		<p>The request gets information about the LDEVs in the ascending order of LDEV numbers, starting with the specified LDEV number.</p> <p>If this parameter is omitted, 0 is assumed.</p>
ldevOption	string	<p>(Optional) LDEV conditions for getting information</p> <p>You can specify the following conditions:</p> <ul style="list-style-type: none"> ▪ <code>defined</code> Gets information about implemented LDEVs. ▪ <code>undefined</code> Gets information about LDEVs that are not implemented. ▪ <code>dpVolume</code> Gets information about DP volumes. ▪ <code>luMapped</code> Gets information about LDEVs for which LU paths are defined. ▪ <code>luUnmapped</code> Gets information about LDEVs for which LU paths are undefined. ▪ <code>externalVolume</code> Gets information about external volumes. <p>If this is omitted, information about all types of LDEVs will be obtained.</p>
poolId	int	<p>(Optional) Pool number</p> <p>Gets information about the LDEVs that are associated with the specified pool.</p>

Parameter	Type	Filter Condition
		<p>By using the <code>ldevOption</code> parameter when specifying conditions, the following information will be obtained:</p> <ul style="list-style-type: none"> ▪ If <code>dpVolume</code> is specified for the <code>ldevOption</code> parameter: Gets information about the DP volumes that are associated with the specified pool. ▪ If <code>luMapped</code> is specified for the <code>ldevOption</code> parameter: Gets information about LDEVs that are associated with the specified pool and that have one or more LU paths defined. ▪ If <code>luUnmapped</code> is specified for the <code>ldevOption</code> parameter: Gets information about LDEVs that are associated with the specified pool and that do not have one or more LU paths defined. <p>If you specify this parameter without specifying the <code>ldevOption</code> parameter, the processing gets information about the volumes that make up the pool (pool volumes).</p> <p>If <code>defined</code> or <code>undefined</code> is specified for the <code>ldevOption</code> parameter, you cannot specify this parameter.</p>
<code>resourceGroupId</code>	int	(Optional) ID of the resource group to which LDEVs for which information is to be obtained belong
<code>journalId</code>	int	(Optional) ID of the journal to which LDEVs for which information is to be obtained belong
<code>parityGroupId</code>	string	<p>(Optional) ID of the parity group to which LDEVs for which information is to be obtained belong</p> <p>Specify concatenated parity groups in the same way as the above.</p> <p>If the concatenated parity groups are 1-3-1, 1-3-2, or 1-3-3, specify as follows:</p> <pre>parityGroupId=1-3</pre>

The following table shows the combinations of query parameters that can be specified.

Parameter	count	head LdevId	Ldev Option	poolId	resourceGroup Id	journal Id	parity Group Id
count	--	Y	Y	Y	Y	Y	Y
head LdevId	Y	--	N	N	N	N	N
Ldev Option	Y	N	--	Y#	Y	N	N
poolId	Y	N	Y#	--	Y	N	N
resourceGroup Id	Y	N	Y	Y	--	Y	Y
journal Id	Y	N	N	N	Y	--	N
parity Group Id	Y	N	N	N	Y	N	--

#: If `defined`, `undefined`, or `externalVolume` is specified as the value of the `LdevOption` parameter, you cannot specify this parameter.

- When requesting additional detailed information

Parameter	Type	Description
<code>detailInfoType</code>	string	<p>(Optional) Type of detailed information to be obtained. You can use this parameter together with parameters that filter the execution results.</p> <p>The following values can be specified. To specify multiple values, separate the values by using commas.</p> <ul style="list-style-type: none"> ▪ <code>FMC</code> Adds detailed information about accelerated compression for the LDEVs that belong to parity groups with drive type <code>SSD (FMC)</code>. ▪ <code>externalVolume</code> Adds detailed information about external volumes.

Parameter	Type	Description
		<ul style="list-style-type: none"> ▪ <code>virtualSerialNumber</code> Adds detailed information about virtual storage machines. ▪ <code>savingInfo</code> Adds detailed information about the capacity saving function (dedupe and compression).

Query parameters can be specified as shown in the following examples.

- The following example retrieves information about 30 LDEVs from LDEV number 1234:

```
?headLdevId=1234&count=30
```

- The following example obtains information about 30 implemented LDEVs that belong to resource group number 5:

```
?ldevOption=defined&count=30&resourceGroupId=5
```

- The following example obtains information about 30 DP volumes that are associated with pool number 7, out of the LDEVs that belong to resource group number 5:

```
?ldevOption=dpVolume&pool=7&count=30&resourceGroupId=5
```

- The following example retrieves information about 30 LDEVs, for which detailed information about accelerated compression is added:

```
?detailInfoType=FMC&count=30
```

Body

None.

Response message

Body

For details on attributes to be obtained in the body of the response message, see the description of the API function for getting information about a specific volume.

```
{
  "data": [
    {
      "ldevId": 0,
      "clprId": 0,

```

```

"emulationType": "OPEN-V-CVS",
"byteFormatCapacity": "1.00 G",
"blockCapacity": 2097152,
"numOfPorts": 2,
"ports": [
  {
    "portId": "CL1-A",
    "hostGroupNumber": 0,
    "hostGroupName": "1A-G00",
    "lun": 1
  },
  {
    "portId": "CL2-A",
    "hostGroupNumber": 0,
    "hostGroupName": "2A-G00",
    "lun": 1
  }
],
"attributes": [
  "CVS",
  "HDP"
],
"label": "JH-26216_DP",
"status": "NML",
"mpBladeId": 2,
"ssid": "0012",
"poolId": 63,
"numOfUsedBlock": 86016,
"isFullAllocationEnabled": false,
"resourceGroupId": 0,
"dataReductionStatus": "ENABLED",
"dataReductionMode": "compression_deduplication",
"isAluaEnabled": false
},
{
  "ldevId": 1,
  "clprId": 0,
  "emulationType": "OPEN-V-CVS",
  "byteFormatCapacity": "1.00 G",
  "blockCapacity": 2097152,
  "numOfPorts": 2,
  "ports": [
    {
      "portId": "CL1-A",
      "hostGroupNumber": 0,
      "hostGroupName": "1A-G00",
      "lun": 2
    },
    {

```

```

    "portId": "CL2-A",
    "hostGroupNumber": 0,
    "hostGroupName": "2A-G00",
    "lun": 2
  }
],
"attributes": [
  "CVS",
  "HDP"
],
"label": "JH-26216_DP",
"status": "NML",
"mpBladeId": 0,
"ssid": "0012",
"poolId": 63,
"numOfUsedBlock": 0,
"isFullAllocationEnabled": false,
"resourceGroupId": 0,
"dataReductionStatus": "DISABLED",
"dataReductionMode": "disabled",
"isAluaEnabled": false
}
]
}

```

If the LDEV is not implemented:

Attribute	Type	Description
ldevId	int	LDEV number
virtualLdevId	int	Virtual LDEV number If the virtual LDEV number is not set, 65534 (FF:FE) is output. If the reserved attribute of global-active device is set, 65535 (FF:FF) is output.
emulationType	string	NOT DEFINED (a value that indicates the LDEV is not implemented) is output.
ssid	string	SSID This attribute is output only if an SSID has been set.
resourceGroupId	int	ID of the resource group to which LDEVs for which information is to be obtained belong

If the volume is an internal volume:

Attribute	Type	Description
ldevId	int	LDEV number
virtualLdevId	int	Virtual LDEV number If the virtual LDEV number is not set, 65534 (FF:FE) is output. If the reserved attribute of global-active device is set, 65535 (FF:FF) is output.
clprId	int	CLPR number
emulationType	string	The LDEV emulation type or the LDEV status information is output by using one of the following values: <ul style="list-style-type: none"> ▪ NOT_DEFINED: The LDEV is not implemented. ▪ DEFINING: The LDEV is being created. ▪ REMOVING: The LDEV is being removed.
byteFormatCapacity	string	Capacity of the LDEV The value is output to the second decimal place.
blockCapacity	long	Number of blocks of the LDEV
numOfPorts	int	Number of ports for which a path to the LDEV is defined
ports	object[]	For ports for which a path to the LDEV is defined the following attributes are output: <ul style="list-style-type: none"> ▪ portId (string) Port number ▪ hostGroupNumber (int) Host group number

Attribute	Type	Description
		<ul style="list-style-type: none"> ▪ hostGroupName (string) Host group name <p>This request can obtain host group names that are no more than 16 characters. To obtain a host group name that exceeds 16 characters, run the API function for getting information about the host group or the iSCSI target.</p> <ul style="list-style-type: none"> ▪ lun (int) LUN
composingPoolId	int	Pool ID of the pool that includes the LDEV
attributes	string[]	<p>LDEV attributes</p> <p>The following attributes are output:</p> <ul style="list-style-type: none"> ▪ CMD: Command device (except for command devices for mainframes) ▪ CLUN: Cache LUN (DCR) ▪ CVS: CVS volume ▪ ALUN: Volume Migration volume ▪ ELUN: External volume ▪ OLG: OpenLDEV Guard volume ▪ VVOL: Virtual volume ▪ HORC: Pair volume (P-VOL or S-VOL) for remote copy (TrueCopy, TrueCopy for Mainframe, Universal Replicator, Universal Replicator for Mainframe) ▪ MRCF: ShadowImage volume (P-VOL or S-VOL) ▪ HTI: Thin Image volume (P-VOL or S-VOL) ▪ JNL: Journal volume ▪ HDP: HDP volume or Dynamic Provisioning for Mainframe volume ▪ HDT: HDT volume ▪ POOL: Pool volume ▪ QRD: Quorum disk ▪ ENCD: Encrypted disk

Attribute	Type	Description
		<ul style="list-style-type: none"> ▪ SYSD: System disk ▪ TSE: HDP volume used for FCSE ▪ GAD: global-active device volume ▪ T10PI: Volume for which the T10 PI attribute is enabled ▪ RCMD: Remote command device
raidLevel	string	RAID level
raidType	string	Drive configuration
numOfParityGroups	int	Number of parity groups to which the LDEV belongs
parityGroupIds	string[]	Parity group to which the LDEV belongs
driveType	string	Code indicating the drive type of the drive belonging to the LDEV
driveByteFormatCapacity	string	Capacity of the HDD The value is output to the second decimal place.
driveBlockCapacity	long	Number of blocks of the HDD
label	string	Label of the LDEV
status	string	Status of the LDEV <ul style="list-style-type: none"> ▪ NML: The LDEV is in normal status. ▪ BLK: The LDEV is blocked. ▪ BSY: The LDEV status is being changed. ▪ Unknown: The LDEV status is unknown (not supported).
operationType	string	The operation in progress: <ul style="list-style-type: none"> ▪ FMT: Formatting is in progress. ▪ QFMT: Quick formatting is in progress. ▪ CCOPY: Collection copying is in progress. ▪ CACCS: Collection access is in progress. ▪ SHRD: Shredding is in progress. ▪ ZPD: Pages are being released.

Attribute	Type	Description
		<ul style="list-style-type: none"> ▪ SHRPL: Deletion from the pool is in progress. ▪ RLC: Pools are being reallocated. ▪ RBL: Pools are being rebalanced.
preparingOperationProgressRate	int	Progress of formatting or shredding For cases other than above, 100 is output.
mpBladeId	int	MP blade ID
ssid	string	SSID This attribute is output only if an SSID has been set.
resourceGroupId	int	ID of the resource group
isAluaEnabled	boolean	Whether the ALUA (Asymmetric Logical Unit Access) attribute is enabled: <ul style="list-style-type: none"> ▪ <code>true</code>: The ALUA attribute is enabled. ▪ <code>false</code>: The ALUA attribute is disabled.

If the volume is an external volume:

Attribute	Type	Description
ldevId	int	LDEV number
virtualLdevId	int	Virtual LDEV number If the virtual LDEV number is not set, 65534 (FF:FE) is output. If the reserved attribute of global-active device is set, 65535 (FF:FF) is output.
clprId	int	CLPR number
emulationType	string	The LDEV emulation type or the LDEV status information is output by using one of the following values: <ul style="list-style-type: none"> ▪ <code>NOT_DEFINED</code>: The LDEV is not implemented. ▪ <code>DEFINING</code>: The LDEV is being created. ▪ <code>REMOVING</code>: The LDEV is being removed.

Attribute	Type	Description
byteFormatCapacity	string	Capacity of the LDEV The value is output to the second decimal place.
blockCapacity	long	Number of blocks of the LDEV
numOfPorts	int	Number of ports for which a path to the LDEV is defined
ports	object[]	For ports for which a path to the LDEV is defined the following attributes are output: <ul style="list-style-type: none"> ▪ portId (string) Port number ▪ hostGroupNumber (int) Host group number ▪ hostGroupName (string) Host group name <p>This request can obtain host group names that are no more than 16 characters. To obtain a host group name that exceeds 16 characters, run the API function for getting information about the host group or the iSCSI target.</p> <ul style="list-style-type: none"> ▪ lun (int) LUN
composingPoolId	int	Pool ID of the pool that includes the LDEV
attributes	string[]	LDEV attributes The following attributes are output: <ul style="list-style-type: none"> ▪ CMD: Command device (except for command devices for mainframes) ▪ CLUN: Cache LUN (DCR) ▪ CVS: CVS volume ▪ ALUN: Volume Migration volumes ▪ ELUN: External volume ▪ OLG: OpenLDEV Guard volume ▪ VVOL: Virtual volume

Attribute	Type	Description
		<ul style="list-style-type: none"> ▪ HORC: Pair volume (P-VOL or S-VOL) for remote copy (TrueCopy, TrueCopy for Mainframe, Universal Replicator, Universal Replicator for Mainframe) ▪ MRCF: ShadowImage volume (P-VOL or S-VOL) ▪ HTI: Thin Image volume (P-VOL or S-VOL) ▪ JNL: Journal volume ▪ HDP: HDP volume or Dynamic Provisioning for Mainframe volume ▪ HDT: HDT volume ▪ POOL: Pool volume ▪ QRD: Quorum disk ▪ ENCD: Encrypted disk ▪ SYSD: System disk ▪ TSE: HDP volume used for FCSE ▪ GAD: global-active device volume ▪ MG: Volume used for data migration
label	string	Label of the LDEV
status	string	Status of the LDEV <ul style="list-style-type: none"> ▪ NML: The LDEV is in normal status. ▪ BLK: The LDEV is blocked. ▪ BSY: The LDEV status is being changed. ▪ Unknown: The LDEV status is unknown (not supported).
operationType	string	The operation in progress: <ul style="list-style-type: none"> ▪ FMT: Formatting is in progress. ▪ QFMT: Quick formatting is in progress. ▪ CCOPY: Collection copying is in progress. ▪ CACCS: Collection access is in progress. ▪ SHRD: Shredding is in progress. ▪ ZPD: Pages are being released. ▪ SHRPL: Deletion from the pool is in progress.

Attribute	Type	Description
		<ul style="list-style-type: none"> ▪ RLC: Pools are being reallocated. ▪ RBL: Pools are being rebalanced.
preparingOperationProgressRate	int	Progress of formatting or shredding For cases other than above, 100 is output.
mpBladeId	int	MP blade ID
ssid	string	SSID This attribute is output only if an SSID has been set.
resourceGroupId	int	ID of the resource group
externalVendorId	string	Vendor information in SCSI information for the external volume
externalProductId	string	Storage system that is connected using the external storage connection functionality of Universal Volume Manager
externalVolumeId	string	Device identification information in SCSI information for the external volume (output in hexadecimal number format)
externalVolumeIdString	string	Device identification information in SCSI information for the external volume (output in ASCII format)
numOfExternalPorts	int	Number of alternate paths
externalPorts	object[]	<p>For the defined alternate paths, the following attributes are output:</p> <ul style="list-style-type: none"> ▪ portId (string) Port number ▪ hostGroupNumber (int) This attribute is currently not in use. 0 is always displayed for this attribute. ▪ lun (int) LUN ▪ wwn (string) WWN
quorumDiskId	int	ID of the Quorum disk

Attribute	Type	Description
		This attribute is output only if the external volume is a Quorum disk of the global-active device.
quorumStorageSerialNumber	string	Device number of the Quorum disk This attribute is output only if the external volume is a Quorum disk of the global-active device.
quorumStorageTypeId	string	ID for identifying the Quorum disk device This attribute is output only if the external volume is a Quorum disk of the global-active device. R6: Universal Storage Platform V/VM R7: Virtual Storage Platform R8: VSP G1000, VSP G1500, VSP F1500 M7: HUS VM M8: VSP Gx00 models, VSP Fx00 models
isAluaEnabled	boolean	Whether the ALUA attribute is enabled: <ul style="list-style-type: none"> ▪ <code>true</code>: The ALUA attribute is enabled. ▪ <code>false</code>: The ALUA attribute is disabled.

If the volume is a virtual volume:

Attribute	Type	Description
ldevId	int	LDEV number
virtualLdevId	int	Virtual LDEV number If the virtual LDEV number is not set, 65534 (FF:FE) is output. If the reserved attribute of global-active device is set, 65535 (FF:FF) is output.
clprId	int	CLPR number

Attribute	Type	Description
emulationType	string	The LDEV emulation type or the LDEV status information is output by using one of the following values: <ul style="list-style-type: none"> NOT DEFINED: The LDEV is not implemented. DEFINING: The LDEV is being created. REMOVING: The LDEV is being removed.
byteFormatCapacity	string	Capacity of the LDEV The value is output to the second decimal place.
blockCapacity	long	Number of blocks of the LDEV
numOfPorts	int	Number of ports for which a path to the LDEV is defined
ports	object[]	For ports for which a path to the LDEV is defined the following attributes are output: <ul style="list-style-type: none"> portId (string) Port number hostGroupNumber (int) Host group number hostGroupName (string) Host group name <p>This request can obtain host group names that are no more than 16 characters. To obtain a host group name that exceeds 16 characters, run the API function for getting information about the host group or the iSCSI target.</p> <ul style="list-style-type: none"> lun (int) LUN
attributes	string[]	LDEV attributes The following attributes are output: <ul style="list-style-type: none"> CMD: Command device (except for command devices for mainframes) CLUN: Cache LUN (DCR) CVS: CVS volume

Attribute	Type	Description
		<ul style="list-style-type: none"> ▪ ALUN: Volume Migration volume ▪ ELUN: External volume ▪ OLG: OpenLDEV Guard volume ▪ VVOL: Virtual volume ▪ HORC: Pair volume (P-VOL or S-VOL) for remote copy (TrueCopy, TrueCopy for Mainframe , Universal Replicator, Universal Replicator for Mainframe) ▪ MRCF: ShadowImage volume (P-VOL or S-VOL) ▪ HTI: Thin Image volume (P-VOL or S-VOL) ▪ JNL: Journal volume ▪ HDP: HDP volume or Dynamic Provisioning for Mainframe volume ▪ HDT: HDT volume ▪ POOL: Pool volume ▪ QRD: Quorum disk ▪ ENCD: Encrypted disk ▪ SYSD: System disk ▪ TSE: HDP volume used for FCSE ▪ GAD: global-active device volume ▪ DSD: Deduplication system data volume (fingerprint) ▪ DS: Deduplication system data volume (data store) ▪ MG: Volume used for data migration
label	string	Label of the LDEV
status	string	Status of the LDEV <ul style="list-style-type: none"> ▪ NML: The LDEV is in normal status. ▪ BLK: The LDEV is blocked. ▪ BSY: The LDEV status is being changed. ▪ Unknown: The LDEV status is unknown (not supported).

Attribute	Type	Description
operationType	string	The operation in progress: <ul style="list-style-type: none"> FMT: Formatting is in progress. QFMT: Quick formatting is in progress. CCOPY: Collection copying is in progress. CACCS: Collection access is in progress. SHRD: Shredding is in progress. ZPD: Pages are being released. SHRPL: Deletion from the pool is in progress. RLC: Pools are being reallocated. RBL: Pools are being rebalanced.
preparingOperationProgress Rate	int	Progress of formatting or shredding For cases other than above, 100 is output.
mpBladeId	int	MP blade ID
ssid	string	SSID This attribute is output only if an SSID has been set.
poolId	int	ID of the pool with which the LDEV is associated <ul style="list-style-type: none"> For DP volumes: ID of the associated DP pool For virtual volumes for Thin Image: ID of the pool in which the snapshot data was created
numOfUsedBlock	long	Number of blocks used in the pool. This includes the number of blocks whose pages are reserved by the Full Allocation functionality.
resourceGroupId	int	ID of the resource group
snapshotPoolId	int	ID of the pool in which the snapshot data was created This attribute is output when the LDEV is both an S-VOL of a Thin Image pair and an HDP volume.

Attribute	Type	Description
isRelocationEnabled	boolean	Status of relocation <ul style="list-style-type: none"> ▪ <code>true</code>: Relocation is enabled. ▪ <code>false</code>: Relocation is stopped.
tierLevel	string	Tiering policy used for relocation <ul style="list-style-type: none"> ▪ <code>all</code>: All tiers are used for relocation (level 0) ▪ <code>1 to 5</code>: Relocation is performed by following the tiering policy (levels 1 to 5) ▪ <code>6 to 31</code>: Relocation is performed by following the tiering policy (custom policy)
usedCapacityPerTierLevel1	long	Capacity allocated to tier 1 (in MB)
usedCapacityPerTierLevel2	long	Capacity allocated to tier 2 (in MB)
usedCapacityPerTierLevel3	long	Capacity allocated to tier 3 (in MB)
tierLevelForNewPageAllocation	string	New page assignment tier <ul style="list-style-type: none"> ▪ <code>H</code>: The page is allocated to a higher-level tier (High) ▪ <code>M</code>: The page is allocated to a middle-level tier (Middle) ▪ <code>L</code>: The page is allocated to a lower-level tier (Low)
tier1AllocationRateMin	int	Minimum capacity of tier 1 of the set tiering policy
tier1AllocationRateMax	int	Maximum capacity of tier 1 of the set tiering policy
tier3AllocationRateMin	int	Minimum capacity of tier 3 of the set tiering policy
tier3AllocationRateMax	int	Maximum capacity of tier 3 of the set tiering policy
fullAllocationCapacity	long	Capacity for which pages are reserved by the Full Allocation functionality (in MB)

Attribute	Type	Description
isFullAllocationEnabled	boolean	Whether pages are reserved by the Full Allocation functionality <ul style="list-style-type: none"> ▪ <code>true</code>: The page reservation setting is enabled. ▪ <code>false</code>: The page reservation setting is disabled.
dataReductionMode	string	Setting of the capacity saving function (dedupe and compression) <ul style="list-style-type: none"> ▪ <code>compression</code>: The capacity saving function (compression) is enabled. ▪ <code>compression_deduplication</code>: The capacity saving function (compression and deduplication) is enabled. ▪ <code>disabled</code>: The capacity saving function (compression and deduplication) is disabled.
dataReductionStatus	string	Status of the capacity saving function <ul style="list-style-type: none"> ▪ <code>ENABLED</code>: The capacity saving function is enabled. ▪ <code>DISABLED</code>: The capacity saving function is disabled. ▪ <code>ENABLING</code>: The capacity saving function is being enabled. ▪ <code>REHYDRATING</code>: The capacity saving function is being disabled. ▪ <code>DELETING</code>: The volumes for which the capacity saving function is enabled are being deleted. ▪ <code>FAILED</code>: An attempt to enable the capacity saving function failed.
dataReductionProgressRate	int	Progress rate of the capacity saving function (%) This attribute is output when one of the following is output for the <code>dataReductionStatus</code> attribute. <code>ENABLING, REHYDRATING, DELETING</code>

Attribute	Type	Description
isAluaEnabled	boolean	Whether the ALUA attribute is enabled: <ul style="list-style-type: none"> ▪ <code>true</code>: The ALUA attribute is enabled. ▪ <code>false</code>: The ALUA attribute is disabled.

If the volume is a Thin Image P-VOL:

In addition to the attributes output if the volume is an internal volume, the following attribute is obtained.

Attribute	Type	Description
usedCapacityForSnapshot	long	Capacity used for snapshots in a Thin Image P-VOL (in MB) The snapshot capacity that is allocated from the pool and used as data is output. For the root volume of a snapshot tree, the snapshot capacity of the root volume is output.

If the drive type of the parity group to which the volumes belong is SSD (FMC):

Specify `FMC` for the `detailInfoType` query parameter, and then run the request to obtain additional detailed information for accelerated compression.

```
{
  "data": [
    {
      "ldevId": 280,
      ...
      "isExpandedSpaceUsed": true
    }
  ]
}
```

Attribute	Type	Description
isExpandedSpaceUsed	boolean	Indicates whether the LDEV uses the expanded area. <ul style="list-style-type: none"> ▪ <code>true</code>: The LDEV uses the expanded area. ▪ <code>false</code>: The LDEV uses the physical area.

If the volume is an external volume:

Specify `externalVolume` for the `detailInfoType` query parameter, and then run the request to obtain additional detailed information for the external volume.

Attribute	Type	Description
<code>externalStorageSerialNumber</code>	string	Serial number of the storage system that is connected using the external storage connection functionality of Universal Volume Manager

If you execute the request with `virtualSerialNumber` specified for the `detailInfoType` query parameter, the request also obtains detailed information about the virtual storage machines.

Attribute	Type	Description
<code>virtualSerialNumber</code>	string	Serial number of the virtual storage machine
<code>virtualModel</code>	string	Model name of the virtual storage machine

If you run the request with `savingInfo` specified for the `detailInfoType` query parameter, the request also obtains detailed information about the capacity saving function.

```
{
  "data": [
    {
      "ldevId": 12,
      ...
      "dataReductionTotalSavingRatio": "2.44",
      "isDataReductionTotalSavingBlockAvailable": true,
      "dataReductionTotalSavingBlock": 13878844,
      "dataReductionSavingBlockCompression": 12134812,
      "dataReductionSavingBlockDeduplication": 808078,
      "dataReductionSavingBlockReclaim": 1076144,
      "dataReductionSystemBlock": 140190,
      "dataReductionPreUsedBlock": 23489911,
      "dataReductionPoolBlock": 9611067
    }
  ]
}
```

Attribute	Type	Description
dataReductionTotalSavingRatio	string	<p>The ratio of volume capacity reduced by using the capacity reduction function</p> <p>The capacity before data reduction is displayed as a ratio of the capacity after data reduction, where the capacity after data reduction is assigned a value of 1.</p>
isDataReductionTotalSavingBlockAvailable	boolean	<p>Whether the size of the data can be reduced</p> <ul style="list-style-type: none"> ▪ <code>true</code> : The size of the data can be reduced. <p>If the value of this attribute is <code>true</code>, the size of the data that has been reduced is displayed for the <code>dataReductionTotalSavingBlock</code> attribute.</p> <ul style="list-style-type: none"> ▪ <code>false</code> : The size of the data cannot be reduced (for example, if the size of the data after data reduction is greater than the size of the data before data reduction).
dataReductionTotalSavingBlock	long	<p>Total number of blocks reduced by using the capacity saving function</p> <p>This value is displayed when the <code>isDataReductionTotalSavingBlockAvailable</code> attribute is set to <code>true</code>.</p> <p>This value includes the amount of zero data that was reduced and the volume of metadata and garbage data generated by the storage system.</p>
dataReductionSavingBlockCompression	long	<p>Number of blocks reduced by using the capacity saving function (compression)</p> <p>The value does not include the volume of metadata and garbage data generated by the storage system.</p>
dataReductionSavingBlockDeduplication	long	<p>Number of blocks reduced by using the capacity saving function (deduplication)</p> <p>The value does not include the volume of metadata and garbage data generated by the storage system.</p>
dataReductionSavingBlockReclaim	long	<p>Number of blocks reduced by using the capacity saving function (reclaiming of the specified data pattern)</p>

Attribute	Type	Description
		The value does not include the volume of metadata and garbage data generated by the storage system.
dataReductionSystemBlock	long	Total number of blocks of system data (metadata and garbage collection) used by the capacity saving function The value does not include the volume of metadata and garbage data in the deduplication system data volumes.
dataReductionPreUsedBlock	long	Number of blocks before data reduction
dataReductionPoolBlock	long	Number of blocks in the pool volume used by the volume

Status codes

For details on the status codes for the request of this operation, see the section explaining HTTP status codes.

Coding example

```
curl -v -H "Accept:application/json" -H "Content-Type:application/json" -H "Authorization:Session d7b673af189048468c5af9bcf3b66b6f" -X GET "https://192.0.2.100/ConfigurationManager/v1/objects/ldevs?headLdevId=0&count=2"
```

Notes about the number of concurrent executions

A maximum of two requests to get more than 2,048 LDEVs can be run at the same time for each storage system. The HTTP status code 503 is returned for the unaccepted request. In this case, wait a while, and then run the API request again.

For API requests that obtain 2,048 or fewer LDEVs, the number of concurrent executions might be restricted due to the details of other processing to be executed at the same time. The following processing affects the number of concurrent executions:

- Processing to get resource group information
- Processing to get multiple pieces of LDEV information
- Processing to get port information (when executed with `detailInfoType=logins` specified in the query)
- Processing to get information about host groups or iSCSI targets
- Processing to get global-active device pair information
- Processing to get a list of external path groups
- Processing to get information about a specific external path group

If the above processes are running, use the following as a reference for the maximum number of requests to obtain LDEV information that can be executed at the same time:

Details of the processing being executed	Maximum number of requests that can be executed at the same time
Processing to get LDEV information (number of LDEVs: 16,384) × 1	11
Processing to get port information (number of ports: 40) × 1	10
Processing to get LDEV information (number of LDEVs: 16,384) × 1 Processing to get resource group information × 1	8
Processing to get LDEV information (number of LDEVs: 16,384) × 1 Processing to get port information (number of ports: 1) × 1	7
Processing to get LDEV information (number of LDEVs: 16,384) × 1 Processing to get resource group information × 2	6
Processing to get LDEV information (number of LDEVs: 16,384) × 1 Processing to get information about host groups or iSCSI targets (number of ports: 80) × 2	6
Processing to get LDEV information (number of LDEVs: 16,384) × 1 Processing to get port information (number of ports: 20) × 1	5
Processing to get LDEV information (number of LDEVs: 16,384) × 2	3
Processing to get LDEV information (number of LDEVs: 16,384) × 1 Processing to get port information (number of ports: 40) × 1	2
Processing to get LDEV information (number of LDEVs: 16,384) × 2 Processing to get resource group information × 1	0 However, one request that obtains 1,024 or fewer LDEVs can be executed.

If you simultaneously execute the request to get global-active device pair information, the approximate maximum number of requests is the same as when you execute the request to get resource group information.

Getting information about a specific volume

The following request gets information about a specific LDEV by specifying the LDEV number.

Execution permission

Storage Administrator (View Only)

Request line

```
GET base-URL/v1/objects/ldevs/object-ID
```

Request message

Object ID

Specify the `ldevId` value obtained by getting information about volumes.

Attribute	Type	Description
<code>ldevId</code>	int	(Required) Specify the LDEV number with a decimal (base 10) number.

Query parameters

None.

Body

None.

Response message

Body

For details on attributes to be obtained, see the description of the API function for getting volume information.

```
{
  "ldevId": 1,
  "clprId": 0,
  "emulationType": "OPEN-V-CVS",
  "byteFormatCapacity": "1.00 G",
  "blockCapacity": 2097152,
```

```

"numOfPorts": 2,
"ports": [
  {
    "portId": "CL1-A",
    "hostGroupNumber": 0,
    "hostGroupName": "1A-G00",
    "lun": 1
  },
  {
    "portId": "CL2-A",
    "hostGroupNumber": 0,
    "hostGroupName": "2A-G00",
    "lun": 1
  }
],
"attributes": [
  "CVS",
  "HDP"
],
"label": "JH-26216_DP",
"status": "NML",
"mpBladeId": 2,
"ssid": "0012",
"poolId": 63,
"numOfUsedBlock": 86016,
"isFullAllocationEnabled": false,
"resourceGroupId": 0,
"dataReductionStatus": "ENABLED",
"dataReductionMode": "compression_deduplication",
"isAluaEnabled": false
}

```

Status codes

For details on the status codes of the request for this operation, see the section explaining HTTP status codes.

Coding example

```

curl -v -H "Accept:application/json" -H "Content-Type:application/json" -H
"Authorization:Session d7b673af189048468c5af9bcf3b6bb6f" -X GET https://
192.0.2.100/ConfigurationManager/v1/objects/ldevs/1

```

Creating a volume

The following request creates a volume by using the specified parity groups or pools. Specify a parity group for creating a basic volume, an external parity group (external

volume group) for creating the external volume, and a pool for creating a virtual volume (a DP volume or a virtual volume for Thin Image).

**Tip:**

If you want to simultaneously execute multiple requests for creating DP volumes, we recommend that you execute the corresponding jobs in parallel by specifying `true` for the `isParallelExecutionEnabled` attribute. If you do not specify this setting, the jobs will be executed sequentially, which takes more time than parallel execution.

Execution permission

Storage Administrator (Provisioning)

Request line

```
POST base-URL/v1/objects/ldevs
```

Request message**Object ID**

None.

Query parameters

None.

Body

The following coding example creates an LDEV (basic volume) by specifying the parity group:

```
{
  "ldevId": 0,
  "parityGroupId": "1-1",
  "byteFormatCapacity": "1G"
}
```

The following coding example creates an external volume by specifying an external parity group:

```
{
  "ldevId": 3,
  "externalParityGroupId": "1-1",
  "byteFormatCapacity": "1G"
}
```

The following coding example creates a DP volume for which the capacity saving function (dedupe and compression) is enabled by specifying a pool:

```
{
  "ldevId": 1,
  "poolId": 0,
  "byteFormatCapacity": "1G",
  "dataReductionMode": "compression_deduplication"
}
```

Attribute	Type	Description
ldevId	int	<p>(Optional) Specify an LDEV number that is not implemented with a decimal (base 10) number.</p> <p>This attribute cannot be specified at the same time as the <code>isParallelExecutionEnabled</code> attribute.</p> <p>If this attribute is omitted, the minimum LDEV number that is not implemented is assumed.</p>
isParallelExecutionEnabled	boolean	<p>(Optional) If you want to execute multiple requests at the same time, specify whether to execute the corresponding jobs in parallel.</p> <p>You can specify this attribute only when you are creating DP volumes.</p> <ul style="list-style-type: none"> ▪ <code>true</code>: Execute jobs in parallel. ▪ <code>false</code>: Do not execute jobs in parallel. (Execute jobs sequentially.) <p>If this attribute is omitted, the value <code>false</code> is assumed.</p> <p>If you specify the <code>ldevId</code> attribute, <code>parityGroupId</code> attribute, or <code>externalParityGroupId</code> attribute, you cannot specify this attribute.</p> <p>If you specify this attribute, an unused LDEV number is automatically assigned to the created LDEV.</p> <p>If there are LDEV numbers that cannot be used, exclude those numbers by using the <code>startLdevId</code> and <code>endLdevId</code> attributes.</p>
startLdevId	int	<p>(Optional) The first LDEV number in the range of LDEV numbers to be automatically assigned, if such a range is specified</p>

Attribute	Type	Description
		You can specify this attribute if the <code>isParallelExecutionEnabled</code> attribute is set to <code>true</code> . If you specify this attribute, you must also specify the <code>endLdevId</code> attribute. The value of this attribute must be smaller than that of the <code>endLdevId</code> attribute.
<code>endLdevId</code>	int	(Optional) The last LDEV number in the range of LDEV numbers to be automatically assigned, if such a range is specified You can specify this attribute if the <code>isParallelExecutionEnabled</code> attribute is set to <code>true</code> . If you specify this attribute, you must also specify the <code>startLdevId</code> attribute. The value of this attribute must be greater than that of the <code>startLdevId</code> attribute.
<code>parityGroupId</code>	string	(Optional) Parity group number Be sure to specify this attribute when creating an LDEV (basic volume). Specify concatenated parity groups in the same way as the above. If the concatenated parity groups are 1-3-1, 1-3-2, or 1-3-3, specify as follows: <pre>"parityGroupId": "1-3"</pre> If you specify the <code>isParallelExecutionEnabled</code> attribute, you cannot specify this attribute.
<code>externalParityGroupId</code>	string	(Optional) External parity group number Be sure to specify this attribute when creating an external volume. If you specify the <code>isParallelExecutionEnabled</code> attribute, you cannot specify this attribute.
<code>poolId</code>	int	(Optional) Pool number

Attribute	Type	Description
		<p>Be sure to specify this item when creating a virtual volume from a pool.</p> <ul style="list-style-type: none"> ▪ To create a DP volume: For the DP pool number, specify a decimal (base 10) number equal to or greater than 0. ▪ To create a virtual volume for Thin Image: Specify -1.
dataReductionMode	string	<p>(Optional) Whether to enable the capacity saving function (dedupe and compression)</p> <p>If you enable this attribute, a DP volume for which the capacity saving function (compression or deduplication) is enabled is created.</p> <p>The specifiable values are as follows:</p> <ul style="list-style-type: none"> ▪ <code>compression</code>: Enable the capacity saving function (compression) ▪ <code>compression_deduplication</code>: Enable the capacity saving function (compression and deduplication) ▪ <code>disabled</code>: Disable the capacity saving function (compression and deduplication) <p>The values are not case sensitive. If this attribute is omitted, <code>disabled</code> will be set.</p>
byteFormatCapacity	string	<p>(Optional) Capacity of the volume to be created, and the unit of the capacity.</p> <p>You must specify either this attribute or the <code>blockCapacity</code> attribute.</p> <p>The following units can be specified:</p> <ul style="list-style-type: none"> ▪ T or t ▪ G or g ▪ M or m ▪ K or k <p>To allocate all free space, specify "all".</p> <p>The following is an example of specifying a capacity of 1 GB:</p> <pre style="background-color: #f0f0f0; padding: 5px;">"byteFormatCapacity": "1G"</pre>

Attribute	Type	Description
blockCapacity	long	<p>(Optional) Capacity of the volume to be created in blocks (1 block = 512 bytes).</p> <p>You must specify either this attribute or the <code>byteFormatCapacity</code> attribute.</p> <p>The following is an example of specifying a capacity of 1 GB:</p> <pre>"blockCapacity":2097152</pre>

Response message

Body

A job object is returned. For details on attributes other than `affectedResources`, see the section explaining job objects.

Attribute	Description
affectedResources	URL of the created volume

Status codes

For details on the status codes of the request for this operation, see the description on HTTP status codes.

Coding example

```
curl -v -H "Accept:application/json" -H "Content-Type:application/json" -H
"Authorization:Session d7b673af189048468c5af9bcf3b66b6f" -X POST --data-
binary @./InputParameters.json https://192.0.2.100/ConfigurationManager/v1/
objects/ldevs
```

Formatting a volume

The following request formats an LDEV (basic volume) or DP volume.

Execution permission

Storage Administrator (Provisioning)

Request line

```
POST base-URL/v1/objects/ldevs/object-ID/actions/format/invoke
```

Request message**Object ID**

Specify the `ldevId` value obtained by getting information about volumes.

Attribute	Type	Description
<code>ldevId</code>	int	(Required) Specify the LDEV number with a decimal (base 10) number.

Query parameters

None.

Body

```
{
  "parameters": {
    "operationType": "FMT"
  }
}
```

Attribute	Type	Description
<code>operationType</code>	string	(Required) Format type. The specifiable types are as follows: FMT: Normal formatting QFMT: Quick formatting For a DP volume for which the capacity saving function (dedupe and compression) is enabled, you must specify FMT.

Response message**Body**

A job object is returned. For details on attributes other than `affectedResources`, see the section explaining job objects.

Attribute	Description
affectedResources	URL of the formatted volume

Action template

```
GET base-URL/v1/objects/ldevs/object-ID/actions/format
```

Status codes

The following table describes the meaning of the status code of the request for this operation. For details on other status codes, see the description on HTTP status codes.

Status code	Message	Description
412	Precondition Failed	<p>The specified action cannot run because the volume meets one of the following conditions:</p> <ul style="list-style-type: none"> ▪ The LDEV is used as a virtual volume of Thin Image. ▪ The LDEV is used as a Quorum disk. ▪ The LDEV is used as a system disk. ▪ The LDEV is used as a pool volume.

Coding example

To get an action template:

```
curl -v -H "Accept:application/json" -H "Content-Type:application/json" -H
"Authorization:Session d7b673af189048468c5af9bcf3b6bb6f" -X GET https://
192.0.2.100/ConfigurationManager/v1/objects/ldevs/1/actions/format
```

To run the request after getting an action template:

```
curl -v -H "Accept:application/json" -H "Content-Type:application/json" -H
"Authorization:Session d7b673af189048468c5af9bcf3b6bb6f" -X POST --data-
binary @./InputParameters.json https://192.0.2.100/ConfigurationManager/v1/
objects/ldevs/1/actions/format/invoke
```

When forcibly formatting the DP volume for which the capacity saving function (dedupe and compression) is enabled:



Note:

The formatting of deduplicated data might take some time. Be sure to take this into account when planning when to format such data. In addition, use the status of the target resource rather than the status of the job to check whether the data has been formatted.

When format the DP volume for which the capacity saving function (compression or deduplication) is enabled, in the request body, specify `FMT` for the `operationType` attribute, and `true` for the `isDataReductionForceFormat` attribute.

The following coding example forcibly formats the DP volume for which the capacity saving function (compression or deduplication) is enabled:

```
{
  "parameters": {
    "operationType": "FMT",
    "isDataReductionForceFormat": true
  }
}
```

Attribute	Type	Description
<code>isDataReductionForceFormat</code>	boolean	(Optional) Specify whether to forcibly format the DP volume for which the capacity saving function (compression or deduplication) is enabled. <ul style="list-style-type: none"> ▪ <code>true</code>: Format forcibly ▪ <code>false</code>: Do not format forcibly When the attribute is omitted, <code>false</code> is assumed.

Expanding the capacity of a volume

The following request expands the capacity of a DP volume.

Execution permission

Storage Administrator (Provisioning)

Request line

```
POST base-URL/v1/objects/ldevs/object-ID/actions/expand/invoke
```

Request message**Object ID**

Specify the `ldevId` value obtained by getting information about volumes.

Attribute	Type	Description
<code>ldevId</code>	int	(Required) Specify the LDEV number with a decimal (base 10) number.

Query parameters

None.

Body

When specifying in bytes:

```
{
  "parameters": {
    "additionalByteFormatCapacity": "1G"
  }
}
```

When specifying in blocks:

```
{
  "parameters": {
    "additionalBlockCapacity": 2097152
  }
}
```

Attribute	Type	Description
<code>additionalByteFormatCapacity</code>	string	<p>(Optional) The capacity to be added and its unit.</p> <p>You must specify either <code>additionalByteFormatCapacity</code> or <code>additionalBlockCapacity</code>.</p> <p>The specifiable units are as follows:</p> <ul style="list-style-type: none"> ▪ T or t ▪ G or g ▪ M or m ▪ K or k

Attribute	Type	Description
		The following is an example of specifying a capacity of 1 GB: <pre>"additionalByteFormatCapacity": "1G"</pre>
additionalBlockCapacity	long	(Optional) The capacity to be added in blocks (1 block = 512 bytes). You must specify either <code>additionalByteFormatCapacity</code> or <code>additionalBlockCapacity</code> . The following is an example of specifying a capacity of 1 GB: <pre>"additionalBlockCapacity": 2097152</pre>

Response message**Body**

A job object is returned. For details on attributes other than `affectedResources`, see the section explaining job objects.

Attribute	Description
affectedResources	URL of the expanded volume

Action template

```
GET base-URL/v1/objects/ldevs/object-ID/actions/expand
```

Status codes

The following table describes the meanings of the status codes of the request for this operation. For details on other status codes, see the description on HTTP status codes.

Status code	Message	Description
412	Precondition Failed	The specified LDEV is not a DP volume.

Coding example

To get an action template:

```
curl -v -H "Accept:application/json" -H "Content-Type:application/json" -H
"Authorization:Session d7b673af189048468c5af9bcf3bbbb6f" -X GET https://
192.0.2.100/ConfigurationManager/v1/objects/ldevs/1/actions/expand
```

To run the request after getting an action template:

```
curl -v -H "Accept:application/json" -H "Content-Type:application/json" -H
"Authorization:Session d7b673af189048468c5af9bcf3bbbb6f" -X POST --data-
binary @./InputParameters.json https://192.0.2.100/ConfigurationManager/v1/
objects/ldevs/1/actions/expand/invoke
```

Changing the volume settings

The following request sets the label for the specified volume, tier relocation of HDT volumes, and whether page reservations are enabled for DP volumes.

Execution permission

Storage Administrator (Provisioning)

Request line

```
PATCH base-URL/v1/objects/ldevs/object-ID
```

Request message**Object ID**

Specify the value of `ldevId` that was obtained by the processing to get information about volumes.

Attribute	Type	Description
<code>ldevId</code>	int	(Required) Specify the LDEV number with a decimal (base 10) number.

Query parameters

None.

Body

The following shows an example of code for changing the label for a volume:

```
{
  "label": "REST_API_10GVolume"
}
```

The following shows an example of code for setting tier relocation and the new page assignment tier:

```
{
  "isRelocationEnabled": true,
  "tierLevelForNewPageAllocation": "L"
}
```

The following shows an example of code for setting the tiering policy (already defined):

```
{
  "tieringPolicy": {
    "tierLevel": 2
  }
}
```

The following shows an example of code for setting the tiering policy (custom policy):

```
{
  "tieringPolicy": {
    "tierLevel": 23,
    "tier1AllocationRateMin": 20,
    "tier1AllocationRateMax": 40,
    "tier3AllocationRateMin": 10,
    "tier3AllocationRateMax": 40
  }
}
```

The following shows an example of code for enabling the page reservation setting:

```
{
  "isFullAllocationEnabled": true
}
```

The following shows an example of code for enabling the capacity saving function (dedupe and compression):

```
{
  "dataReductionMode": "compression_deduplication"
}
```

Attribute	Type	Description
label	string	<p>(Optional) Label to be set for the volume</p> <p>Specify a label consisting of 0 to 32 characters. You can use the following characters.</p> <ul style="list-style-type: none"> Alphanumeric characters The following symbols: ! # \$ % & ' () + , - . : = @ [] ^ _ ` { } ~ / \ <p>You can specify a hyphen as the first character of the value.</p> <ul style="list-style-type: none"> Spaces <p>The label cannot start or end with a space.</p>
dataReductionMode	string	<p>(Optional) Specify whether to enable the capacity saving function (dedupe and compression)</p> <p>If you enable this attribute, the capacity saving function (compression or deduplication) of the DP volume is enabled.</p> <p>The specifiable values are as follows:</p> <ul style="list-style-type: none"> <code>compression</code>: Enable the capacity saving function (compression) <code>compression_deduplication</code>: Enable the capacity saving function (compression and deduplication) <code>disabled</code>: Disable the capacity saving function (compression and deduplication)^{#1} <p>The values are not case sensitive.</p>

Attribute	Type	Description
isRelocationEnabled	boolean	<p>(Optional) Specify whether to enable the tier relocation setting for the HDT volume.</p> <ul style="list-style-type: none"> ▪ <code>true</code> : Enable the tier relocation. ▪ <code>false</code> : Disable the tier relocation.
tieringPolicy	object	<p>Specify the tiering policy to be assigned to the HDT volume.</p> <p>Specifying this attribute automatically enables tier relocations for the HDT volume.</p> <p>If you specify <code>false</code> for the <code>isRelocationEnabled</code> attribute, you cannot specify this attribute.</p> <ul style="list-style-type: none"> ▪ (Optional) tierLevel (int) Level of the tiering policy If you specify the tiering policy, you must specify this setting. Specify a value from 0 to 31. <ul style="list-style-type: none"> • 0: All tiers are used for relocations. • 1 to 5: Relocations are performed by following the tiering policy (levels 1 to 5). • 6 to 31: Relocations are performed by following the tiering policy (custom policy). <p>When an HDT volume is created, 0 is set.</p> <p>If you specify a custom policy of 6 to 31 for the <code>tierLevel</code> attribute, you can also specify the percentage of pages to be allocated to each tier.^{#2}</p> <p>There are four attributes for specifying the percentage. If you specify these attributes, you must specify all of them. Specify a value from 1 to 100.^{#3}</p>

Attribute	Type	Description
		<p>You can specify the following attributes:</p> <ul style="list-style-type: none"> ▪ (Optional) tier1AllocationRateMin (int) From among the total capacity of the pages to be allocated when tier relocation is performed, the minimum rate (%) of the capacity to be relocated to tier 1 ▪ (Optional) tier1AllocationRateMax (int) From among the total capacity of the pages to be allocated when tier relocation is performed, the maximum rate (%) of the capacity to be relocated to tier 1 ▪ (Optional) tier3AllocationRateMin (int) From among the total capacity of the pages to be allocated when tier relocation is performed, the minimum rate (%) of the capacity to be relocated to tier 3 ▪ (Optional) tier3AllocationRateMax (int) From among the total capacity of the pages to be allocated when tier relocation is performed, the maximum rate (%) of the capacity to be relocated to tier 3
tierLevelForNewPageAllocation	string	<p>(Optional) Specify which tier of the HDT pool will be prioritized when a new page is allocated.</p> <p>The type is not case sensitive.</p> <ul style="list-style-type: none"> ▪ H: Higher-level tier (High) ▪ M: Middle-level tier (Middle) ▪ L: Lower-level tier (Low) <p>When an HDT volume is created, M is set.</p>

Attribute	Type	Description
isFullAllocationEnabled	boolean	<p>(Optional) Specify whether to reserve pages of the pool associated with the DP volume by using the Full Allocation functionality.</p> <ul style="list-style-type: none"> ▪ <code>true</code>: Enable the page reservation setting. ▪ <code>false</code>: Disable the page reservation setting. <p>When a DP volume is created, <code>false</code> is set.</p>
isAluaEnabled	boolean	<p>(Optional) Specify whether to enable the ALUA attribute.</p> <p>You can specify this attribute for a volume used for a global-active device in a cross-path configuration (using a Fibre Channel connection).</p> <ul style="list-style-type: none"> ▪ <code>true</code>: Enable the ALUA attribute. ▪ <code>false</code>: Disable the ALUA attribute.

#1: If there is deduplication data in the volumes, the task to disable the capacity saving function might take up to several months. Be sure to take this into account when planning when to change the settings. In addition, use the status of the target resource rather than the status of the job to check whether the settings have been changed.

#2: If you do not specify the percentage, the values stored in the storage system are set.

#3: If you specify the value of each attribute, make sure that the value meets the following conditions:

- The value of the `tier1AllocationRateMin` attribute is equal to or less than the value of the `tier1AllocationRateMax` attribute.
- The value of the `tier3AllocationRateMin` attribute is equal to or less than the value of the `tier3AllocationRateMax` attribute.
- The sum of the values of the `tier1AllocationRateMin` and `tier3AllocationRateMin` attributes is equal to or less than 100.
- The difference between the values of the `tier1AllocationRateMax` and `tier1AllocationRateMin` attributes is a multiple of 10.
- The difference between the values of the `tier3AllocationRateMax` and `tier3AllocationRateMin` attributes is a multiple of 10.

Response message**Body**

A job object is returned. For details on attributes other than `affectedResources`, see the description on job objects.

Attribute	Description
<code>affectedResources</code>	URL of the volume whose settings were changed

Status codes

For details on the status codes of the request for this operation, see the description on HTTP status codes.

Coding example

```
curl -v -H "Accept:application/json" -H "Content-Type:application/json" -H
"Authorization:Session d7b673af189048468c5af9bcf3b666f" -X PATCH --data-
binary @./InputParameters.json https://192.0.2.100/ConfigurationManager/v1/
objects/ldevs/100
```

Changing the volume status

The following request changes the status of a volume. The volume status can be changed to blocked before a volume is shredded or returned to the normal status after shredding is stopped.

Execution permission

Storage Administrator (Provisioning)

Request line

```
POST base-URL/v1/objects/ldevs/object-ID/actions/change-status/invoke
```

Request message**Object ID**

Specify the value of `ldevId` that was obtained by the processing to get information about volumes.

Attribute	Type	Description
<code>ldevId</code>	int	(Required) Specify the LDEV number with a decimal (base 10) number.

Query parameters

None.

Body

The following is a coding example for changing the volume status to blocked:

```
{
  "parameters": {
    "status": "blk"
  }
}
```

Attribute	Type	Description
<code>status</code>	string	(Required) Volume status The specifiable values are as follows: <code>blk</code> : Change the status to blocked <code>nm1</code> : Change the status to normal

Response message**Body**

A job object is returned. For details on attributes other than `affectedResources`, see the section explaining job objects.

Attribute	Description
<code>affectedResources</code>	URL of the volume whose status was changed

Action template

```
GET base-URL/v1/objects/ldevs/object-ID/actions/change-status
```

Status codes

The following table describes the meaning of the status code of the request for this operation. For details on other status codes, see the description on HTTP status codes.

Status code	Message	Description
412	Precondition Failed	<p>The specified action cannot run because the volume meets one of the following conditions:</p> <ul style="list-style-type: none"> ▪ The LDEV is used as a Quorum disk. ▪ The LDEV is used as a system disk. ▪ The LDEV is used as a pool volume. ▪ The LDEV is used as a Volume Migration volume. ▪ The LDEV is used as a pair volume of a global-active device. ▪ The LDEV is used as a pair volume of ShadowImage. ▪ The LDEV is used as a pair volume of TrueCopy or Universal Replicator. ▪ The LDEV is used as a pair volume of Thin Image or Copy-on-Write Snapshot.

Coding example

To get an action template:

```
curl -v -H "Accept:application/json" -H "Content-Type:application/json" -H
"Authorization:Session d7b673af189048468c5af9bcf3b6bb6f" -X GET https://
192.0.2.100/ConfigurationManager/v1/objects/ldevs/100/actions/change-status
```

To run the request after getting an action template:

```
curl -v -H "Accept:application/json" -H "Content-Type:application/json" -H
"Authorization:Session d7b673af189048468c5af9bcf3b6bb6f" -X POST --data-
binary @./InputParameters.json https://192.0.2.100/ConfigurationManager/v1/
objects/ldevs/100/actions/change-status/invoke
```

Shredding a volume

The following request shreds an LDEV (basic volume) or DP volume. Overwrite the volume three times with dummy data. You can stop shredding before its completion. Change the status of the volume to be shredded to blocked. When shredding is complete, the status of the volume is automatically changed to normal. If you stopped shredding before completion, the status of the volume remains as blocked.

Notes when stopping shredding

If you make a request to stop shredding, all of the volumes that are currently being shredded are stopped.

Shredding might not stop even if you make a request to stop shredding. In such case, make the request according to the progress status of the shredding. The progress of the shredding can be checked from the value of the `preparingOperationProgressRate` attribute that is obtained from the information of the target volume.

- When the value of the attribute is 0, shredding has not started.

When the value is 0, shredding is not stopped even if a request is made.

Request the stopping of the shredding after the value is greater than or equal to 1.

- When a request for stopping shredding is made but the value of the attribute does not change to 100, shredding is not stopped.

In such case, make a request to stop the shredding again.

Execution permission

Storage Administrator (Provisioning)

Request line

```
POST base-URL/v1/objects/ldevs/object-ID/actions/shred/invoke
```

Request message

Object ID

Specify the value of `ldevId` that was obtained by the processing to get information about volumes.

Attribute	Type	Description
<code>ldevId</code>	int	(Required) Specify the LDEV number with a decimal (base 10) number.

Query parameters

None.

Body

The following is a coding example for performing shredding by specifying the dummy data pattern:

```
{
  "parameters": {
    "operationType": "start",
    "pattern": "F0F0F0"
  }
}
```

The following is a coding example for performing shredding without specifying the dummy data pattern:

```
{
  "parameters": {
    "operationType": "start"
  }
}
```

The following is a coding example for stopping shredding before completion:

```
{
  "parameters": {
    "operationType": "stop"
  }
}
```

Attribute	Type	Description
operationType	string	(Required) Run or stop shredding. The specifiable values are as follows: start: Run shredding stop: Stop shredding
pattern	string	(Optional) Dummy data pattern to be used for the second overwrite Specify a pattern consisting of 1 to 8 characters in a hexadecimal format. Specification example: 0F0F0F

Attribute	Type	Description
		If the value is not specified, the default pattern <code>FFFFFFFF</code> will be used.

Response message

Body

A job object is returned. For details on attributes other than `affectedResources`, see the section explaining job objects.

Attribute	Description
<code>affectedResources</code>	URL of the shredded volume

Action template

```
GET base-URL/v1/objects/ldevs/object-ID/actions/shred
```

Status codes

The following table describes the meaning of the status code of the request for this operation. For details on other status codes, see the description on HTTP status codes.

Status code	Message	Description
412	Precondition Failed	<p>The specified action cannot run because the volume meets one of the following conditions:</p> <ul style="list-style-type: none"> ▪ The LDEV status is normal or the status is being changed. ▪ The LDEV is used as a Quorum disk. ▪ The LDEV is used as a system disk. ▪ The LDEV is used as a pool volume. ▪ The LDEV is used as a deduplication system data volume (fingerprint). ▪ The LDEV is used as a journal volume. ▪ The LDEV is used as a pair volume of a global-active device. ▪ The LDEV is used as a pair volume of ShadowImage. ▪ The LDEV is used as a pair volume of TrueCopy or Universal Replicator. ▪ The LDEV is used as a pair volume of Thin Image or Copy-on-Write Snapshot.

Coding example

To get an action template:

```
curl -v -H "Accept:application/json" -H "Content-Type:application/json" -H
"Authorization:Session d7b673af189048468c5af9bcf3b66b6f" -X GET https://
192.0.2.100/ConfigurationManager/v1/objects/ldevs/100/actions/shred
```

To run the request after getting an action template:

```
curl -v -H "Accept:application/json" -H "Content-Type:application/json" -H
"Authorization:Session d7b673af189048468c5af9bcf3b66b6f" -X POST --data-
binary @./InputParameters.json https://192.0.2.100/ConfigurationManager/v1/
objects/ldevs/100/actions/shred/invoke
```

Reclaiming zero pages of a DP volume

The following request reclaims zero pages of a DP volume to release the pages. By releasing pages, you can increase the free capacity of a pool.

Execution permission

Storage Administrator (Provisioning)

Request linePOST *base-URL/v1/objects/ldevs/object-ID/actions/discard-zero-page/invoke***Request message****Object ID**

Specify the value of `ldevId` that was obtained by the processing to get information about volumes.

Attribute	Type	Description
ldevId	int	(Required) Specify the LDEV number with a decimal (base 10) number.

Query parameters

None.

Body

None.

Response message

A job object is returned. For details on attributes other than `affectedResources`, see the section explaining job objects.

Attribute	Description
affectedResources	URL of the volume for which zero pages were reclaimed

Action template

None.

Status codes

The following table explains the meanings of the status codes for this API. For details on other status codes, see the section explaining HTTP status codes.

Status code	Message	Description
412	Precondition Failed	<p>The specified action cannot run because the volume meets one of the following conditions:</p> <ul style="list-style-type: none"> ▪ The volume is not a DP volume. ▪ The volume is in the blocked status. ▪ The volume is used as a pair volume of one of the following copy types: <ul style="list-style-type: none"> • ShadowImage • TrueCopy • Universal Replicator • Thin Image • Copy-on-Write Snapshot ▪ The volume is used as a journal volume of Universal Replicator. ▪ The volume is used as a Volume Migration volume.

Coding example

```
curl -v -H "Accept:application/json" -H "Content-Type:application/json" -H
"Authorization:Session d7b673af189048468c5af9bcf3b66b6f" -X POST https://
192.0.2.100/ConfigurationManager/v1/objects/ldevs/1/actions/discard-zero-
page/invoke -d ""
```

Changing the MP blade assigned to a volume

The following request changes the MP blade assigned to a volume.



Note:

When changing the MP blade assigned to a volume, make sure to take into account the effect the change will have on I/O performance. For notes on changing the MP blade assigned to a volume, see the *Provisioning Guide* for the storage system.

Execution permission

Storage Administrator (System Resource Management)

Request line

POST *base-URL/v1/objects/ldevs/object-ID/actions/assign-mp-blade/invoke*

Request message**Object ID**

Specify the `ldevId` value obtained by getting volume information.

Attribute	Type	Description
<code>ldevId</code>	int	(Required) LDEV number

Query parameters

None.

Body

```
{
  "parameters": {
    "mpBladeId": 1
  }
}
```

Attribute	Type	Description
<code>mpBladeId</code>	int	(Required) MP blade number of the MP blade to be assigned to the volume

Response message**Body**

A job object is returned. For details about attributes other than `affectedResources`, see the description of job objects.

Attribute	Description
<code>affectedResources</code>	URL of the volume for which the MP blade number was changed

Action template

None.

Status codes

For details about the status codes of the request for this operation, see the description of the HTTP status codes.

Coding example

```
curl -v -H "Accept:application/json" -H "Content-Type:application/json" -H
"Authorization:Session d7b673af189048468c5af9bcf3b6666f" -X POST --data-
binary @./InputParameters.json https://192.0.2.100/ConfigurationManager/v1/
objects/ldevs/99/actions/assign-mp-blade/invoke
```

Deleting a volume

The following request deletes an LDEV (basic volume) or a virtual volume (a DP volume or a virtual volume for Thin Image).

Execution permission

Storage Administrator (Provisioning)

Request line

```
DELETE base-URL/v1/objects/ldevs/object-ID
```

Request message**Object ID**

Specify the `ldevId` value obtained by getting information about volumes.

Attribute	Type	Description
<code>ldevId</code>	int	(Required) Specify the LDEV number with a decimal (base 10) number.

Query parameters

None.

Body

None.

Response message**Body**

A job object is returned. For details on attributes other than `affectedResources`, see the section explaining job objects.

Attribute	Description
affectedResources	URL of the deleted volume

Status codes

For details on the status codes of the request for this operation, see the description on HTTP status codes.

Coding example

```
curl -v -H "Accept:application/json" -H "Content-Type:application/json" -H
"Authorization:Session d7b673af189048468c5af9bcf3b666f" -X DELETE
https://192.0.2.100/ConfigurationManager/v1/objects/ldevs/105
```

When forcibly deleting the DP volume for which the capacity saving function (dedupe and compression) is enabled

! **Important:** Deleting data on a DP volume for which the capacity saving function (compression or deduplication) is enabled takes time. Be sure to take this into account when planning when to delete such data. In addition, use the status of the target resource rather than the status of the job to check whether the volume has been deleted.

When deleting the DP volume for which the capacity saving function (compression or deduplication) is enabled, in the request body, specify `true` for the `isDataReductionDeleteForceExecute` attribute.

The following coding example forcibly deletes the DP volume for which the capacity saving function (compression or deduplication) is enabled:

```
{
  "isDataReductionDeleteForceExecute": true
}
```

Attribute	Type	Description
isDataReductionDeleteForceExecute	boolean	(Optional) Specify whether to forcibly delete the DP volume for which the capacity saving function (compression or deduplication) is enabled. <ul style="list-style-type: none"> ▪ <code>true</code>: Forcibly deletes ▪ <code>false</code>: Does not forcibly delete

Attribute	Type	Description
		When the attribute is omitted, <code>false</code> is assumed.

Getting port information

The following request obtains information about ports.



Important:

if you execute this API request with `detailInfoType=logins` specified, the number of API requests that can be executed concurrently might be restricted based on the number of installed ports or the types of other processing being executed at the same time. For details about these restrictions, see the notes on the number of concurrent executions.

Execution permission

Storage Administrator (View Only)

Request line

```
GET base-URL/v1/objects/ports
```

Request message

Object ID

None.

Query parameters

You can filter execution results by specifying conditions, or get additional detailed port information.

When filtering execution results:

Parameter	Type	Filter condition
portType	string	(Optional) Port type You can specify the following conditions: <ul style="list-style-type: none"> ▪ FIBRE ▪ SCSI ▪ ISCSI ▪ ENAS

Parameter	Type	Filter condition
		<ul style="list-style-type: none"> ▪ ESCON ▪ FICON <p>If this parameter is omitted, information about ports of all port types will be obtained.</p> <p>If you specify <code>portId</code>, you cannot specify this parameter.</p>
<code>portAttributes</code>	string	<p>(Optional) Port attribute</p> <p>You can specify the following conditions:</p> <ul style="list-style-type: none"> ▪ TAR: Target port (Fibre Target port) ▪ MCU: Initiator port (MCU Initiator port) ▪ RCU: RCU target port (RCU Target port) ▪ ELUN: External port (External Initiator port) <p>If this parameter is omitted, information about all port attributes will be obtained.</p> <p>Information about bidirectional ports will be obtained regardless of which value is specified for this parameter.</p> <p>If you specify <code>portId</code>, you cannot specify this parameter.</p>
<code>portId</code>	string	<p>(Optional) Port number</p> <p>If this parameter is omitted, information about all port numbers will be obtained. If you specify this parameter, be sure to specify the <code>detailInfoType</code> parameter.</p> <p>Note that the <code>portType</code> parameter and the <code>portAttributes</code> parameter cannot be specified at the same time.</p>

When collecting additional detailed information:

Parameter	Type	Description
<code>detailInfoType</code>	string	<p>(Optional) Type of detailed information to be obtained</p> <ul style="list-style-type: none"> ▪ <code>logins</code>: Information about logins to a port corresponding to the WWN of an HBA or iSCSI name <p>You can get this information if the port type is <code>FIBRE</code>, or <code>ISCSI</code>.</p>

Parameter	Type	Description
		You can use this parameter together with parameters that filter the execution results.

Body

None.

Response message**Body**

The following is an example of the output when information obtained about all ports:

```
{
  "data": [
    {
      "portId": "CL1-A",
      "portType": "FIBRE",
      "portAttributes": [
        "TAR",
        "MCU",
        "RCU",
        "ELUN"
      ],
      "portSpeed": "AUT",
      "loopId": "EF",
      "fabricMode": true,
      "portConnection": "PtoP",
      "lunSecuritySetting": true,
      "wwn": "50060e80124e3b00"
    },
    {
      "portId": "CL1-B",
      "portType": "ISCSI",
      "portAttributes": [
        "TAR",
        "MCU",
        "RCU",
        "ELUN"
      ],
      "portSpeed": "10G",
      "loopId": "00",
      "fabricMode": false,
      "lunSecuritySetting": true
    }
  ]
}
```

```
]
}
```

The following is an example of the output when information is obtained about ports by specifying the port type:

```
{
  "data": [
    {
      "portId": "CL1-B",
      "portType": "ISCSI",
      "portAttributes": [
        "TAR",
        "MCU",
        "RCU",
        "ELUN"
      ],
      "portSpeed": "10G",
      "loopId": "00",
      "fabricMode": false,
      "lunSecuritySetting": true
    }
  ]
}
```

Attribute	Type	Description
portId	string	Port number
portType	string	Port type One of the following values is output: FIBRE, SCSI, ISCSI, ENAS, ESCON, FICON
portAttributes	string[]	The value set for the port attribute <ul style="list-style-type: none"> ▪ TAR: Target port (Fibre Target port) ▪ MCU: Initiator port (MCU Initiator port) ▪ RCU: RCU target port (RCU Target port) ▪ ELUN: External port (External Initiator port) For a bidirectional port, all four attributes are output.
portSpeed	string	The value set for the transfer speed <ul style="list-style-type: none"> ▪ AUT (AUTO) ▪ <i>n</i>G (where <i>n</i> is a number)

Attribute	Type	Description
loopId	string	The value set for the port loop ID (AL_PA)
fabricMode	boolean	Fabric mode of the port <ul style="list-style-type: none"> true: Set. false: Not set.
portConnection	string	Topology setting for the port <ul style="list-style-type: none"> FCAL PtoP If the <code>portType</code> attribute is <code>ISCSI</code> , this information is not output.
lunSecuritySetting	boolean	LUN security setting for the port <ul style="list-style-type: none"> true: Set. false: Not set.
wwn	string	External WWN <p>If the <code>portType</code> attribute is <code>ISCSI</code>, this information is not output.</p>

The following is an example of the output when requesting additional detailed information:

```
{
  "data" : [
    {
      "portId" : "CL1-A",
      "portType" : "FIBRE",
      "portAttributes" : [ "TAR" ],
      "portSpeed" : "AUT",
      "loopId" : "EF",
      "fabricMode" : true,
      "portConnection" : "PtoP",
      "lunSecuritySetting" : true,
      "wwn" : "50060e8007274300",
      "logins" : [
        {
          "loginWwn" : "C0507603BF002C",
          "wwnNickName" : "-",
          "isLoggedIn" : false
        },
        {

```

```

        "loginWwn" : "C05076087D5A0012",
        "wwnNickName" : "ep22_10_0",
        "hostGroupId" : "CL1-A,9",
        "isLoggedIn" : true
    }
]
},
{
    "portId" : "CL1-B",
    "portType" : "ISCSI",
    "portAttributes" : [ "TAR" ],
    "portSpeed" : "10G",
    "loopId" : "00",
    "fabricMode" : false,
    "lunSecuritySetting" : true,
    "logins" : [
        {
            "loginIscsiName" : "iqn.1991-05.com.microsoft:hy0295",
            "iscsiNickName" : "hypoi0295",
            "hostGroupId" : "CL1-B,0",
            "iscsiTargetName" : "iqn.1994-
04.jp.co.hitachi:rsd.h8h.t.10011.1d000",
            "isLoggedIn" : false
        },
        {
            "loginIscsiName" : "iqn.1991-05.com.microsoft:hy0295",
            "iscsiNickName" : "hypoi0295",
            "hostGroupId" : "CL1-B,94",
            "iscsiTargetName" : "iqn.1994-
04.jp.co.hitachi:rsd.h8h.t.10011.1d05e",
            "isLoggedIn" : true
        }
    ]
}
]
}

```

You can also get the following information by executing the request with `logins` specified for `detailInfoType` in the query parameters.

Attribute	Type	Description
logins	object[]	Information about logins to a storage system port corresponding to the WWN of an HBA or iSCSI name

Attribute	Type	Description
		<p>For the WWN:</p> <ul style="list-style-type: none"> ▪ loginWwn (string) WWN of the HBA ▪ wwnNickName (string) WWN nickname ▪ hostGroupId (string) Object ID of the host group ▪ isLoggedIn (boolean) Login status of the host <ul style="list-style-type: none"> • true: Logged in • false: Not logged in <p>For iSCSI name:</p> <ul style="list-style-type: none"> ▪ loginIscsiName (string) iSCSI name of iSCSI initiator ▪ iscsiNickName (string) iSCSI nickname ▪ hostGroupId (string) Object ID of iSCSI target ▪ iscsiTargetName (string) iSCSI name of iSCSI target ▪ isLoggedIn (boolean) Login status of the host <ul style="list-style-type: none"> • true: Logged in • false: Not logged in

Status codes

For details on the status codes of the request for this operation, see the description on HTTP status codes.

Coding example

To obtain information about all ports:

```
curl -v -H "Accept:application/json" -H "Content-Type:application/json" -H
"Authorization:Session d7b673af189048468c5af9bcf3bbbb6f" -X GET https://
192.0.2.100/ConfigurationManager/v1/objects/ports
```

To obtain information about ports by specifying the port type:

```
curl -v -H "Accept:application/json" -H "Content-Type:application/json" -H
"Authorization:Session d7b673af189048468c5af9bcf3bbbb6f" -X GET https://
192.0.2.100/ConfigurationManager/v1/objects/ports?portType=ISCSI
```

To obtain information about ports by requesting additional detailed information:

```
curl -v -H "Accept:application/json" -H "Content-Type:application/json" -H
"Authorization:Session d7b673af189048468c5af9bcf3bbbb6f" -X GET https://
192.0.2.100/ConfigurationManager/v1/objects/ports?detailInfoType=logins
```

Notes on the number of concurrent executions

If you execute this API request with `detailInfoType=logins` specified, the number of concurrent executions might be restricted based on the number of installed ports or the other types of processing being executed at the same time.

The following types of processing affect the number of API requests that can be executed concurrently:

- Processing to get information about multiple LDEVs
- Processing to get a list of resource groups
- Processing to get information about host groups or iSCSI targets
- Processing to get information about global-active device pairs
- Processing to get a list of external path groups
- Processing to get information of a specified external path group

If any of these types of processing is running, refer to the following as a guide on the maximum number of requests to obtain port information that can be executed concurrently with `detailInfoType=logins` specified:

Processing being executed	Maximum number of requests that can be executed concurrently (expected number of resources that can be obtained)
None	2 (number of ports: 8)
None	1 (number of ports: 40)

Processing being executed	Maximum number of requests that can be executed concurrently (expected number of resources that can be obtained)
Processing to get LDEV information (number of LDEVs: 16,384) × 1	1 (number of ports: 40)
Processing to get LDEV information (number of LDEVs: 16,384) × 2	0 (number of ports: 40)
Processing to get information about host groups or iSCSI targets (number of ports: 40) × 2	1 (number of ports: 40)
Processing to get information about host groups or iSCSI targets (number of ports: 40) × 8	0 (number of ports: 40)
Processing to get a list of external path groups (number of paths in the target path groups:: 10,240) × 8	1 (number of ports: 40)
Processing to get a list of external path groups (number of paths in the target path groups:: 10,240) × 9	0 (number of ports: 40)
Processing to get LDEV information (number of LDEVs: 16,384) × 1 Processing to get resource group information × 1	1 (number of ports: 40)
Processing to get LDEV information (number of LDEVs: 16,384) × 1 Processing to get resource group information × 2	0 (number of ports: 40)

If you simultaneously execute the request to get global-active device pair information, the approximate maximum number of requests is the same as when you execute the request to get resource group information.

Getting information about a specific port

The following request gets information about a specific port by specifying the port number. You can use this API to get information about Fibre Channel port, or iSCSI port.

Execution permission

Storage Administrator (View Only)

Request line

```
GET base-URL/v1/objects/ports/object-ID
```

Request message**Object ID**

Specify the `portId` value obtained by getting information about the port.

Attribute	Type	Description
portId	string	(Required) Port number

Query parameters

None.

Body

None.

Response message**Body**

The following is an example of the output generated when getting Fibre Channel port information:

```
{
  "portId": "CL1-A",
  "portType": "FIBRE",
  "portAttributes": [
    "TAR",
    "MCU",
    "RCU",
    "ELUN"
  ],
  "portSpeed": "AUT",
  "loopId": "EF",
  "fabricMode": true,
  "portConnection": "PtoP",
  "lunSecuritySetting": true,
  "wwn": "50060e80124e3b00"
}
```

For a Fibre Channel port:

Attribute	Type	Description
portId	string	Port number
portType	string	Port type One of the following values is output: FIBRE, SCSI, ISCSI, ENAS, ESCON, FICON
portAttributes	string[]	The value set for the port attribute <ul style="list-style-type: none"> ▪ TAR: Target port (Fibre Target port) ▪ MCU: Initiator port (MCU Initiator port) ▪ RCU: RCU target port (RCU Target port) ▪ ELUN: External port (External Initiator port) For a bidirectional port, all four attributes are output.
portSpeed	string	The value set for the transfer speed <ul style="list-style-type: none"> ▪ AUT (AUTO) ▪ nG (where <i>n</i> is a number)
loopId	string	The value set for the port loop ID (AL_PA)
fabricMode	boolean	Fabric mode of the port <ul style="list-style-type: none"> ▪ true: Set. ▪ false: Not set.
portConnection	string	Topology setting for the port <ul style="list-style-type: none"> ▪ FCAL ▪ PtoP
lunSecuritySetting	boolean	LUN security setting for the port <ul style="list-style-type: none"> ▪ true: Set. ▪ false: Not set.
wwn	string	External WWN

Attribute	Type	Description
logins	object[]	<p>If there is a currently-connected WWN, the following attributes are output:</p> <ul style="list-style-type: none"> ▪ loginWwn (string) WWN of the host adapter that is logged in to the port ▪ wwnNickName (string) Reserved attribute <p>The version of this API is always displayed as a hyphen (-).</p>

The following is an example of the output generated when getting iSCSI port information.

```
{
  "portId" : "CL1-A",
  "portType" : "ISCSI",
  "portAttributes" : [ "TAR", "MCU", "RCU", "ELUN" ],
  "portSpeed" : "10G",
  "loopId" : "00",
  "fabricMode" : false,
  "lunSecuritySetting" : true,
  "tcpOption" : {
    "ipv6Mode" : false,
    "selectiveAckMode" : true,
    "delayedAckMode" : true,
    "isnsService" : false,
    "tagVlan" : false
  },
  "tcpMtu" : 1500,
  "iscsiWindowSize" : "64KB",
  "keepAliveTimer" : 60,
  "tcpPort" : "3260",
  "macAddress" : "00:1f:67:1f:14:1d",
  "ipv4Address" : "192.168.0.100",
  "ipv4Subnetmask" : "255.255.255.0",
  "ipv4GatewayAddress" : "0.0.0.0",
  "ipv6LinkLocalAddress" : {
    "status" : "INV",
    "addressingMode" : "AM",
    "address" : "fe80:/"
  },
  "ipv6GlobalAddress" : {
    "status" : "INV",
```

```

    "addressingMode" : "AM",
    "address" : "::"
  },
  "ipv6GatewayGlobalAddress" : {
    "status" : "INV",
    "address" : "::",
    "currentAddress" : "::"
  }
}

```

For an iSCSI port:

Attribute	Type	Description
portId	string	Port number
portType	string	Port type One of the following values is output: FIBRE, SCSI, ISCSI, ENAS, ESCON, FICON
portAttributes	string[]	The value set for the port attribute <ul style="list-style-type: none"> ▪ TAR: Target port (Fibre Target port) ▪ MCU: Initiator port (MCU Initiator port) ▪ RCU: RCU target port (RCU Target port) ▪ ELUN: External port (External Initiator port) For a bidirectional port, all four attributes are output.
portSpeed	string	The value set for the transfer speed <ul style="list-style-type: none"> ▪ AUT (AUTO) ▪ nG (where <i>n</i> is a number)
loopId	string	The value set for the port loop ID (AL_PA)
fabricMode	boolean	Fabric mode of the port <ul style="list-style-type: none"> ▪ true: Set. ▪ false: Not set.
lunSecuritySetting	boolean	LUN security setting for the port <ul style="list-style-type: none"> ▪ true: Set. ▪ false: Not set.

Attribute	Type	Description
logins	object[]	If there is a currently-connected iSCSI name, the following attributes are output: <ul style="list-style-type: none"> loginIscsiName (string) iSCSI name of the host adapter that is logged in to the port
vLanId	string	VLAN ID (in decimal number format)
tcpOption	object	The following attributes are output: <ul style="list-style-type: none"> ipv6Mode (boolean) IPv6 mode selectiveAckMode (boolean) Selective Ack mode delayedAckMode (boolean) Delayed Ack mode isnsService (boolean) iSNS service tagVlan (boolean) Tag VLAN
tcpMtu	int	Value of MTU for iSCSI communication
iscsiWindowSize	string	Value of Window Size for iSCSI communication
keepAliveTimer	int	Value of Keep Alive Timer for iSCSI communication
tcpPort	string	TCP port number for iSCSI communication
macAddress	string	MAC address of the port
ipv4Address	string	IPv4 address
ipv4Subnetmask	string	IPv4 subnet mask
ipv4GatewayAddress	string	IPv4 address of the gateway to be used for iSCSI communication

Attribute	Type	Description
ipv6LinkLocalAddress	object	<p>The following attributes are output:</p> <ul style="list-style-type: none"> ▪ status (string) <p>One of the following values that indicate the status of the IPv6 link local address is output:</p> <ul style="list-style-type: none"> • INV: Invalid • VAL: Valid • ACQ: Acquiring • DUP: Duplicated • Unknown: Undefined value ▪ addressingMode (string) <p>One of the following values that indicate the mode of the IPv6 link local address is output:</p> <ul style="list-style-type: none"> • AM: Auto mode • MM: Manual mode • Unknown: Undefined value ▪ address (string) <p>IPv6 link local address value</p>

Attribute	Type	Description
ipv6GlobalAddress	object	<p>The following attributes are output:</p> <ul style="list-style-type: none"> ▪ status (string) <p>One of the following values that indicate the status of the IPv6 global address is output:</p> <ul style="list-style-type: none"> • INV: Invalid • VAL: Valid • ACQ: Acquiring • DUP: Duplicated • Unknown: Undefined value ▪ addressingMode (string) <p>One of the following values that indicate the mode of the IPv6 global address is output:</p> <ul style="list-style-type: none"> • AM: Auto mode • MM: Manual mode • Unknown: Undefined value ▪ address (string) <p>IPv6 global address value</p>

Attribute	Type	Description
ipv6GatewayGlobalAddress	object	<p>The following attributes are output:</p> <ul style="list-style-type: none"> ▪ status (string) <ul style="list-style-type: none"> One of the following values that indicate the status of the IPv6 global address of the gateway to be used for iSCSI communication is output: • INV: Invalid • VAL: Valid • ACQ: Acquiring • DUP: Duplicated • Unknown: Undefined value ▪ address (string) <ul style="list-style-type: none"> IPv6 global address value of the gateway to be used for iSCSI communication ▪ currentAddress (string) <ul style="list-style-type: none"> IPv6 global current address value of the gateway to be used for iSCSI communication
isnsPort	string	TCP port number of the iSNS server
isnsAddress	string	Address of the iSNS server

Status codes

For details on the status codes of the request for this operation, see the description on HTTP status codes.

Coding example

```
curl -v -H "Accept:application/json" -H "Content-Type:application/json" -H
"Authorization:Session d7b673af189048468c5af9bcf3b6bb6f" -X GET https://
192.0.2.100/ConfigurationManager/v1/objects/ports/CL1-A
```

Getting information about host groups or iSCSI targets

The following request gets information about host groups or iSCSI targets of the port.

**Important:**

The number of concurrent executions of this API request might be limited depending on the number of ports for which information is to be obtained or depending on the other processing to be executed concurrently. For details on this limitation and the conditions under which the limitation applies, see the note on the number of concurrent executions.

Execution permission

Storage Administrator (View Only)

Request line

```
GET base-URL/v1/objects/host-groups
```

Request message**Object ID**

None.

Query parameters

You can specify conditions to filter the execution results and get information about host groups at high speeds.

- To filter the execution results

Parameter	Type	Filter Condition
portId	string	(Optional) Port number Only when this parameter is specified, the following attributes are also obtained: <ul style="list-style-type: none"> ▪ <code>iscsiName</code> ▪ <code>authenticationMode</code> ▪ <code>iscsiTargetDirection</code> ▪ <code>hostModeOptions</code>

Parameter	Type	Filter Condition
		If this parameter is omitted, information about all ports is obtained.
isUndefined	boolean	<p>(Optional) Specify whether to get information even about host group numbers for which no host group or iSCSI target has been created.</p> <ul style="list-style-type: none"> ▪ <code>true</code>: Gets information about host group numbers for which no host group or iSCSI target has been created. ▪ <code>false</code>: Does not get information about host group numbers for which no host group or iSCSI target has been created. <p>You cannot specify this parameter at the same time as the <code>hostGroupNumberList</code> parameter.</p> <p>If this parameter is omitted, <code>false</code> is assumed to be specified.</p>

- When collecting additional detailed information

Parameter	Type	Description
detailInfoType	string	<p>(Optional) Type of detailed information to be obtained</p> <ul style="list-style-type: none"> ▪ <code>resourceGroup</code> Gets information about resource groups of host groups or iSCSI targets. <p>If you specify this parameter, also specify the <code>portId</code> parameter.</p> <p>The following parameter settings cannot be specified together with the <code>detailInfoType</code> parameter: <code>true</code> specified for the <code>isSimpleMode</code> parameter.</p>

- To obtain only the attributes that fall under basic information
You can obtain information more quickly than if you were to obtain all attributes.

Parameter	Type	Description
isSimpleMode	boolean	<p>(Optional) Specify whether to obtain only the attributes that fall under basic information.</p> <ul style="list-style-type: none"> ▪ <code>true</code>: Obtain only the attributes that fall under basic information. ▪ <code>false</code>: Obtain all attributes. <p>If you specify the value <code>true</code> for this parameter, be sure to also specify the <code>portId</code> parameter.</p> <p>If this parameter is omitted, the value <code>false</code> is assumed.</p>
hostGroupNumberList	string	<p>(Optional) Target IDs of iSCSI targets</p> <p>Specify this parameter to get basic information about the specified iSCSI targets.</p> <p>If you specify this parameter, be sure to specify <code>true</code> for the <code>isSimpleMode</code> parameter.</p> <p>You cannot specify this parameter at the same time as the <code>isUndefined</code> parameter.</p> <p>To specify multiple IDs, delimit each ID by using a comma.</p>

Body

None.

Response message**Body**

The following coding example obtains only the attributes that fall under basic information:

```
{
  "data": [
    {
      "hostGroupId": "CL1-A,0",
      "portId": "CL1-A",
      "hostGroupNumber": 0,
      "hostGroupName": "hostA"
    }
  ]
}
```

```

    },
    {
      "hostGroupId": "CL1-B,0",
      "portId": "CL1-B",
      "hostGroupNumber": 0,
      "hostGroupName": "hostB"
    }
  ]
}

```

The following table describes the attributes that are obtained by a request that gets only attributes that fall under basic information:

Attribute	Type	Description
hostGroupId	string	Object ID for the host group or iSCSI target
portId	string	Port number
hostGroupNumber	int	Host group number of the port (for the iSCSI target, target ID)
hostGroupName	string	Host group name (for the iSCSI target, target ID) If you do not specify the <code>hostGroupNumberList</code> parameter, only the first 16 characters are obtained.
iscsiName	string	iSCSI name of the iSCSI target of the port This attribute is obtained only if you specify the <code>hostGroupNumberList</code> parameter.
authenticationMode	string	Authentication mode for the iSCSI target This attribute is obtained only if you specify the <code>hostGroupNumberList</code> parameter. <ul style="list-style-type: none"> ▪ CHAP: CHAP-authentication mode ▪ NONE: No-authentication mode ▪ BOTH: Both CHAP-authentication mode and no-authentication mode
iscsiTargetDirection	string	Direction of CHAP authentication for the iSCSI target

Attribute	Type	Description
		<p>This attribute is obtained only if you specify the <code>hostGroupNumberList</code> parameter.</p> <ul style="list-style-type: none"> ▪ S: One-way (The iSCSI target authenticates the iSCSI initiator.) ▪ D: Mutual (The iSCSI target and the iSCSI initiator authenticate each other.)

The following coding example obtains all attributes:

The following is an example of the output generated from the processing to get information about host groups or iSCSI targets of all ports:

```
{
  "data": [
    {
      "hostGroupId": "CL1-A,0",
      "portId": "CL1-A",
      "hostGroupNumber": 0,
      "hostGroupName": "hostA",
      "hostMode": "WIN",
      "hostModeOptions": [
        1,
        2
      ]
    },
    {
      "hostGroupId": "CL1-B,0",
      "portId": "CL1-B",
      "hostGroupNumber": 0,
      "hostGroupName": "hostB",
      "hostMode": "LINUX/IRIX"
    }
  ]
}
```

The following is an output example when information about the host group or the iSCSI target created for the specified port number is obtained:

```
{
  "data": [
    {
      "hostGroupId": "CL1-A,0",
      "portId": "CL1-A",
      "hostGroupNumber": 0,

```

```

    "hostGroupName": "hostA",
    "hostMode": "WIN",
    "hostModeOptions": [
      1,
      2
    ]
  },
  {
    "hostGroupId": "CL1-A,1",
    "portId": "CL1-A",
    "hostGroupNumber": 1,
    "hostGroupName": "hostB",
    "hostMode": "LINUX/IRIX"
  }
]
}

```

The following is an example of the output generated when information about resource groups is obtained:

In this example, information is also obtained about host group numbers for which no host group or iSCSI target has been created.

```

{
  "data": [
    {
      "hostGroupId": "CL1-A,0",
      "portId": "CL1-A",
      "hostGroupNumber": 0,
      "hostGroupName": "hostA",
      "hostMode": "WIN",
      "hostModeOptions": [
        1,
        2
      ],
      "resourceGroupId": 1,
      "isDefined": true
    },
    {
      "hostGroupId": "CL1-A,1",
      "portId": "CL1-A",
      "hostGroupNumber": 1,
      "hostGroupName": "-",
      "resourceGroupId": 2,
      "isDefined": false
    }
  ]
}

```

The following table describes the attributes that are obtained by a request that gets all attributes:

Attribute	Type	Description
hostGroupId	string	Object ID for the host group or iSCSI target
portId	string	Port number
hostGroupNumber	int	Host group number of the port (for the iSCSI target, target ID)
hostGroupName	string	Host group name (for the iSCSI target, target ID)
iscsiName	string	iSCSI name of the iSCSI target of the port This information is obtained only when the <code>portId</code> parameter is specified.
authenticationMode	string	Authentication mode for the iSCSI target This information is obtained only when the <code>portId</code> parameter is specified. <ul style="list-style-type: none"> ▪ CHAP: CHAP-authentication mode ▪ NONE: No-authentication mode ▪ BOTH: Both CHAP-authentication mode and no-authentication mode
iscsiTargetDirection	string	Direction of CHAP authentication for the iSCSI target This information is obtained only when the <code>portId</code> parameter is specified. <ul style="list-style-type: none"> ▪ S: One-way (The iSCSI target authenticates the iSCSI initiator.) ▪ D: Mutual (The iSCSI target and the iSCSI initiator authenticate each other.)
hostMode	string	Host mode for setting the host adapter of the host group This attribute is obtained if the host group name is defined. For details on the values to be obtained, see the description of the API function for changing the host group or iSCSI target settings.

Attribute	Type	Description
hostModeOptions	int[]	<p>Number of options for setting the host mode option of the host group</p> <p>This information is obtained only when the <code>portId</code> parameter is specified.</p> <p>This attribute is obtained if the host group name is defined.</p> <p>For details on the number to be obtained, see the <i>Provisioning Guide</i>.</p>
resourceGroupId	int	<p>ID of the resource group to which the host group or iSCSI target belongs</p> <p>This information is obtained only when <code>detailInfoType=resourceGroup</code> is specified for the query.</p>
isDefined	boolean	<p>Whether the host group or iSCSI target has been created</p> <p>This information is obtained only when <code>detailInfoType=resourceGroup</code> is specified for the query.</p> <ul style="list-style-type: none"> ▪ <code>true</code>: The host group or iSCSI target has been created. ▪ <code>false</code>: The host group or iSCSI target has not been created.

Status codes

For details on the status codes of the request for this operation, see the description on HTTP status codes.

Coding example

When getting information about host groups or iSCSI targets of all ports:

```
curl -v -H "Accept:application/json" -H "Content-Type:application/json" -H
"Authorization:Session d7b673af189048468c5af9bcf3b6bb6f" -X GET https://
192.0.2.100/ConfigurationManager/v1/objects/host-groups
```

When information about the host group or the iSCSI target created for the specified port number is obtained:

```
curl -v -H "Accept:application/json" -H "Content-Type:application/json" -H
"Authorization:Session d7b673af189048468c5af9bcf3b6bb6f" -X GET https://
192.0.2.100/ConfigurationManager/v1/objects/host-groups?portId=CL1-A
```

When obtaining information about resource groups:

In this example, information is also obtained about host group numbers for which no host group or iSCSI target has been created.

```
curl -v -H "Accept:application/json" -H "Content-Type:application/json" -H
"Authorization:Session d7b673af189048468c5af9bcf3b6bb6f" -X GET https://
192.0.2.100/ConfigurationManager/v1/objects/host-groups?portId=CL1-
A&isUndefined=true&detailInfoType=resourceGroup
```

Note on the number of concurrent executions

If `portId` is not specified as the query parameter, the number of concurrent executions of this API request might be limited depending on the number of ports for which information is to be obtained or depending on the other requests to be executed concurrently. The number of concurrent executions can be affected by the following:

- Processing to get a list of resource groups
- Processing to get information about multiple LDEVs
- Processing to get port information (when executed with `detailInfoType=logins` specified in the query)
- Processing to get information about global-active device pairs
- Processing to get a list of external path groups
- Processing to get information about a specific external path group

Refer to the information below to estimate the maximum number of concurrent requests for obtaining information about host groups and iSCSI targets if one or more of the above processing is in progress.

Processing in progress	Maximum number of requests that can be executed concurrently (expected number of resources that can be obtained)
Processing to get information about LDEVs (Number of LDEVs: 16,384) × 1	10 (Number of ports: 32)
Processing to get port information (Number of ports: 32) × 1	10 (Number of ports: 32)
Processing to get information about LDEVs (Number of LDEVs: 16,384) × 1	4 (Number of ports: 80)

Processing in progress	Maximum number of requests that can be executed concurrently (expected number of resources that can be obtained)
Processing to get information about LDEVs (Number of LDEVs: 16,384) × 1 Processing to get a list of resource groups × 1	3 (Number of ports: 64)
Processing to get LDEV information (Number of LDEVs: 16,384) × 1 Processing to get port information (Number of ports: 1) × 1	3 (Number of ports: 64)
Processing to get LDEV information (Number of LDEVs: 16,384) × 1 Processing to get port information (Number of ports: 64) × 1	1 (Number of ports: 64)
None	13 (Number of ports: 32)
None	6 (Number of ports: 80)

If the processing to obtain information about global-active device pairs is performed concurrently, the expected maximum number is the same as when the processing to obtain a list of resource groups is performed.

Getting information about a specific host group or iSCSI target

The following request gets information by specifying the host group number of the port or the target ID of the iSCSI target.

Execution permission

Storage Administrator (View Only)

Request line

```
GET base-URL/v1/objects/host-groups/object-ID
```

Request message**Object ID**

Specify the `hostGroupId` value obtained by getting information about the host groups or iSCSI targets. You can also specify the following attributes and connect them with commas:

```
portId,hostGroupNumber
```

Attribute	Type	Description
portId	string	(Required) Port number
hostGroupNumber	int	(Required) Host group number of the port (for the iSCSI target, target ID)

Query parameters

None.

Body

None.

Response message**Body**

The following is an example of the output generated when getting information by specifying the port number and the host group number:

```
{
  "hostGroupId": "CL1-A,0",
  "portId": "CL1-A",
  "hostGroupNumber": 0,
  "hostGroupName": "hostA",
  "hostMode": "WIN",
  "hostModeOptions": [
    1,
    2
  ]
}
```

For an iSCSI target, the following is an example of the output generated when getting information by specifying the port number and the target ID:

```
{
  "hostGroupId": "CL1-A,0",
  "portId": "CL1-A",
```

```

"hostGroupNumber": 0,
"hostGroupName": "hostA",
"iscsiName": "iqn.rest.example.of.iqn.host",
"authenticationMode": "CHAP",
"iscsiTargetDirection": "S",
"hostMode": "WIN",
"hostModeOptions": [
  1,
  2
]
}

```

Attribute	Type	Description
hostGroupId	string	Object ID for the host group or iSCSI target
portId	string	Port number
hostGroupNumber	int	Host group number of the port (for the iSCSI target, target ID)
hostGroupName	string	Host group name (for the iSCSI target, target ID)
iscsiName	string	iSCSI name of the iSCSI target of the port This information is obtained in the case of an iSCSI port.
authenticationMode	string	Authentication mode for the iSCSI target This information is obtained in the case of an iSCSI port. <ul style="list-style-type: none"> ▪ CHAP: CHAP-authentication mode ▪ NONE: No-authentication mode ▪ BOTH: Both CHAP-authentication mode and no-authentication mode
iscsiTargetDirection	string	Direction of CHAP authentication for the iSCSI target This information is obtained in the case of an iSCSI port. <ul style="list-style-type: none"> ▪ S: One-way (The iSCSI target authenticates the iSCSI initiator.) ▪ D: Mutual (The iSCSI target and the iSCSI initiator authenticate each other.)

Attribute	Type	Description
hostMode	string	Host mode for setting the host adapter of the host group For details on the values to be obtained, see the description of the API function for changing the host group or iSCSI target settings.
hostModeOptions	int[]	Number of options for setting the host mode option of the host group For details on the number to be obtained, see the <i>Provisioning Guide</i> .

Status codes

For details on the status codes of the request for this operation, see the description on HTTP status codes.

Coding example

```
curl -v -H "Accept:application/json" -H "Content-Type:application/json" -H "Authorization:Session d7b673af189048468c5af9bcf3b6bb6f" -X GET https://192.0.2.100/ConfigurationManager/v1/objects/host-groups/CL1-A,0
```

Getting a list of host modes and host mode options

The following request acquires a list of host modes and host mode options used for the storage system.

Execution permission

Storage Administrator (View Only)

Request line

```
GET base-URL/objects/supported-host-modes/instance
```

Request message**Object ID**

Specify *instance*.

If an object has only one instance, *instance* is the fixed value that specifies the object ID.

Query parameters

None.

Body

None.

Response message

Body

```
{
  "hostModes": [
    {
      "hostModeId": 0,
      "hostModeName": "Standard",
      "hostModeDisplay": "LINUX/IRIX"
    },
    {
      "hostModeId": 1,
      "hostModeName": "(Deprecated) VMware",
      "hostModeDisplay": "VMWARE"
    }
  ],
  "hostModeOptions": [
    {
      "hostModeOptionId": 2,
      "hostModeOptionDescription": "VERITAS Database Edition/
Advanced Cluster"
    },
    {
      "hostModeOptionId": 6,
      "hostModeOptionDescription": "TPRLO"
    }
  ]
}
```

Attribute	Type	Description
hostModes	object[]	<p>The following attributes related to the host mode are output:</p> <ul style="list-style-type: none"> hostModeId (int) Host mode number hostModeName (string) Identification name of the host mode hostModeDisplay (string) Host mode value Value to be used to specify the host mode
hostModeOptions	object[]	<p>The following attributes related to the host mode option are output:</p> <ul style="list-style-type: none"> hostModeOptionId (int) Host mode option number hostModeOptionDescription (string) Description of the host mode option

Status codes

For details on the status codes of the request for this operation, see the description of HTTP status codes.

Coding example

```
curl -v -H "Accept:application/json" -H "Content-Type:application/json" -H "Authorization:Session d7b673af189048468c5af9bcf3bbbb6f" -X GET https://192.0.2.100/ConfigurationManager/v1/objects/supported-host-modes/instance
```

Creating a host group or an iSCSI target

The following request creates a host group for the port. For an iSCSI port, this request creates the iSCSI target and the iSCSI name. The host mode and the host mode option can also be specified at the same time when the host group and the iSCSI target are created.

Execution permission

Storage Administrator (Provisioning)

Request line

```
POST base-URL/v1/objects/host-groups
```

Request message**Object ID**

None.

Query parameters

None.

Body

The following coding example creates a host group:

```
{
  "portId": "CL1-A",
  "hostGroupName": "My_REST_API_HOST",
  "hostModeOptions": [12,33],
  "hostMode": "AIX"
}
```

The following coding example creates an iSCSI target:

```
{
  "portId": "CL1-A",
  "hostGroupName": "My_REST_API_HOST",
  "iscsiName": "iqn.20150908iscsi"
}
```

Attribute	Type	Description
portId	string	(Required) Port number
hostGroupNumber	int	(Optional) Host group number Specify a decimal (base 10) number in the range from 0 to 254. If this attribute is omitted, a value is automatically set. For iSCSI ports, this number is called target ID.

Attribute	Type	Description
hostGroupName	string	<p>(Required) Host group name or iSCSI target name</p> <ul style="list-style-type: none"> ▪ To create a host group Specify a host group name consisting of 1 to 64 characters. ▪ To create an iSCSI target Specify the iSCSI target name consisting of 1 to 32 characters. For the iSCSI target, you cannot specify the default name of the iSCSI target whose ID is 0. <p>You cannot create host groups or iSCSI targets that have the same name for a single port.</p>
iscsiName	string	<p>(Optional) iSCSI name</p> <p>Specify this item when creating an iSCSI target. If this attribute is omitted, a value is automatically set.</p> <p>Specify this item in the iqn or eui format.</p> <ul style="list-style-type: none"> ▪ iqn format Specify a value in the range from 5 to 223. You can use the following characters: alphanumeric characters (lowercase), periods (.), hyphens (-), and colons (:) Specification example: <code>iqn.rest.example.of.iqn.form</code> ▪ eui format After "eui.", specify a hexadecimal number. Specify a value consisting of 20 characters. Specification example: <code>eui.0900ABDC32598D26</code>
hostMode	string	<p>(Optional) Host mode</p> <p>The specifiable values are as follows: HP-UX, SOLARIS, AIX, WIN, LINUX/IRIX, TRU64, OVMS, NETWARE, VMWARE, VMWARE_EX, WIN_EX</p> <p>If this attribute is omitted, LINUX/IRIX is set.</p>
hostModeOptions	int[]	<p>(Optional) Number of options for setting host mode options</p> <p>For the specifiable numbers, see the <i>Provisioning Guide</i>.</p>

Attribute	Type	Description
		When specifying more than one attribute, use a comma to separate the values. When specifying this attribute, make sure to also specify the <code>hostMode</code> attribute.
<code>isQuickCreating</code>	boolean	(Optional) When creating a host group by specifying <code>hostGroupNumber</code> , if you want to omit the process of checking whether the host group is created, specify <code>true</code> . If you specify <code>true</code> and a host group or iSCSI target already exists for the specified <code>hostGroupNumber</code> , the setting is overwritten. <ul style="list-style-type: none"> <code>true</code>: Does not check whether the host group has been created. <code>false</code>: Checks whether the host group has been created. If this attribute is omitted, <code>false</code> is assumed. If <code>hostGroupNumber</code> is not specified, this attribute is ignored.

Response message

Body

A job object is returned. For details on attributes other than `affectedResources`, see the section explaining job objects.

Attribute	Description
<code>affectedResources</code>	URL of the created host group or iSCSI target

Status codes

The following table describes the meaning of the status code of the request for this operation. For details on other status codes, see the section explaining HTTP status codes.

Status code	Message	Description
409	Conflict	A host group already exists for the specified host group number.

Coding example

```
curl -v -H "Accept:application/json" -H "Content-Type:application/json" -H
"Authorization:Session d7b673af189048468c5af9bcf3b66b6f" -X POST --data-
binary @./InputParameters.json https://192.0.2.100/ConfigurationManager/v1/
objects/host-groups
```

Changing the host group or iSCSI target settings

The following request sets the host mode or host mode option for a host group or an iSCSI target. For iSCSI targets, settings related to CHAP authentication can also be specified.

Execution permission

Storage Administrator (Provisioning)

Request line

```
PATCH base-URL/v1/objects/host-groups/object-ID
```

Request message**Object ID**

Specify the `hostGroupId` value obtained by getting information about the host group or the iSCSI target. You can also specify the following attributes and connect them with commas:

```
portId,hostGroupNumber
```

Attribute	Type	Description
portId	string	(Required) Port number
hostGroupNumber	int	(Required) Host group number (target ID for an iSCSI port)

Query parameters

None.

Body

When setting the host mode option of the host group:

```
{
  "hostMode": "WIN",
```

```
"hostModeOptions": [12,33]
}
```

When resetting the host mode option of the host group:

```
{
  "hostMode": "HP-UX",
  "hostModeOptions": [-1]
}
```

When setting the CHAP authentication mode and CHAP authentication direction for the iSCSI target:

```
{
  "hostMode": "WIN",
  "authenticationMode": "CHAP",
  "iscsiTargetDirection": "D"
}
```

Attribute	Type	Description
hostMode	string	(Required) Host mode The specifiable types are as follows: HP-UX, SOLARIS, AIX, WIN, LINUX/IRIX, TRU64, OVMS, NETWARE, VMWARE, VMWARE_EX, or WIN_EX
hostModeOptions	int[]	(Optional) Number of options for setting host mode options The values are updated (overwritten) by the specified values. When specifying values, specify all the numbers for the host mode options that you want to set. For details on the specifiable numbers, see the <i>Provisioning Guide</i> . To specify multiple option values, separate the values by commas. If you set -1, the set host mode option will be reset.
authenticationMode	string	(Optional) CHAP authentication mode for the iSCSI target

Attribute	Type	Description
		<p>The specifiable types are as follows:</p> <ul style="list-style-type: none"> ▪ CHAP: CHAP-authentication mode ▪ NONE: No-authentication mode ▪ BOTH: Both CHAP-authentication mode and no-authentication mode
iscsiTargetDirection	string	<p>(Optional) Direction of CHAP authentication for the iSCSI target</p> <p>The specifiable types are as follows:</p> <p>S: Unidirectional authentication mode (The iSCSI target authenticates the iSCSI initiator.)</p> <p>D: Bidirectional authentication mode (The iSCSI target and the iSCSI initiator authenticate each other.)</p>

Response message

Body

A job object is returned. For details on attributes other than `affectedResources`, see the section explaining job objects.

Attribute	Description
affectedResources	URL of the changed host group or iSCSI target

Action template

None.

Status codes

For details on the status codes of the request for this operation, see the description on HTTP status codes.

Coding example

```
curl -v -H "Accept:application/json" -H "Content-Type:application/json" -H "Authorization:Session d7b673af189048468c5af9bcf3b66b6f" -X PATCH --data-binary @./InputParameters.json https://192.0.2.100/ConfigurationManager/v1/objects/host-groups/CL1-A,0
```

Deleting a host group or the iSCSI target

The following request deletes the WWN and LUN settings of a host group or of a host registered in a host group. Alternatively, the request deletes the LUN setting and iSCSI name of an iSCSI target or of a host (iSCSI initiator) registered for the iSCSI target. If the host group number of the host group to be deleted (target ID for the iSCSI port) is 0, the settings for the host group or iSCSI target are returned to their default values.

Execution permission

Storage Administrator (Provisioning)

Request line

```
DELETE base-URL/v1/objects/host-groups/object-ID
```

Request message

Object ID

Specify the `hostGroupId` value obtained by getting information about the host group or the iSCSI target. You can also specify the following attributes and connect them with commas:

```
portId,hostGroupNumber
```

Attribute	Type	Description
portId	string	(Required) Port number
hostGroupNumber	int	(Required) Host group number (target ID for an iSCSI port)

Query parameters

None.

Body

None.

Response message

Body

A job object is returned. For details on attributes other than `affectedResources`, see the section explaining job objects.

Attribute	Description
affectedResources	URL of the deleted host group or iSCSI target

Status codes

For details on the status codes of the request for this operation, see the description on HTTP status codes.

Coding example

```
curl -v -H "Accept:application/json" -H "Content-Type:application/json" -H
"Authorization:Session d7b673af189048468c5af9bcf3b66b6f" -X DELETE
https://192.0.2.100/ConfigurationManager/v1/objects/host-groups/CL1-A,0
```

Getting WWN information

Specifying a port and host group, the following request gets the information about the WWN registered for the host group.

Execution permission

Storage Administrator (View Only)

Request line

```
GET base-URL/v1/objects/host-wwns
```

Request message

Object ID

None.

Query parameters

Parameter	Type	Filter Condition
portId	string	(Required) Port number
hostGroupNumber	int	(Optional) The host group number

Parameter	Type	Filter Condition
		You must specify one of the following parameters: this parameter, the <code>hostGroupName</code> parameter, or the <code>hostGroupNumberList</code> parameter.
<code>hostGroupName</code>	string	(Optional) The host group name You must specify one of the following parameters: this parameter, the <code>hostGroupNumber</code> parameter, or the <code>hostGroupNumberList</code> parameter.
<code>hostGroupNumberList</code>	string	(Optional) The host group number You can obtain information quickly by specifying this parameter. To specify multiple IDs, delimit each ID by using a comma. You must specify one of the following parameters: this parameter, the <code>hostGroupNumber</code> parameter, or the <code>hostGroupName</code> parameter.

Body

None.

Response message**Body**

```
{
  "data": [
    {
      "hostWwnId": "CL1-A,0,000000102cceccc9",
      "portId": "CL1-A",
      "hostGroupNumber": 0,
      "hostGroupName": "my@host999",
      "hostWwn": "000000102cceccc9",
      "wwnNickname": "Myhostwwnsecret"
    },
    {
      "hostWwnId": "CL1-A,0,1111111111111111",
      "portId": "CL1-A",
      "hostGroupNumber": 0,
      "hostGroupName": "my@host999",
      "hostWwn": "1111111111111111",
      "wwnNickname": "formyhost"
    }
  ]
}
```

```
]
}
```

Attribute	Type	Description
hostWwnId	string	Object ID for the WWN
portId	string	Port number
hostGroupNumber	int	Host group number of the port
hostGroupName	string	Host group name of the port
hostWwn	string	WWN of the host bus adapter registered for the host group
wwnNickname	string	WWN nickname

Status codes

For details on the status codes of the request for this operation, see the section explaining HTTP status codes.

Coding example

```
curl -v -H "Accept:application/json" -H "Content-Type:application/json" -H
"Authorization:Session d7b673af189048468c5af9bcf3bbbb6f" -X GET "https://
192.0.2.100/ConfigurationManager/v1/objects/host-wwns?portId=CL1-
A&hostGroupNumber=0"
```

Getting information about a specific WWN

The following request gets information about the specified WWN.

Execution permission

Storage Administrator (View Only)

Request line

```
GET base-URL/v1/objects/host-wwns/object-ID
```

Request message**Object ID**

Specify the `hostWwnId` value obtained by getting information about the WWN. You can also specify the following attributes and connect them with commas:

```
portId,hostGroupNumber,hostWwn
```

Attribute	Type	Description
portId	string	(Required) Port number
hostGroupNumber	int	(Required) The host group number
hostWwn	string	(Required) The WWN of the host bus adapter Specify the attribute without using colons (:).

Query parameters

None.

Body

None.

Response message**Body**

```
{
  "hostWwnId": "CL1-A,0,000000102ccec9",
  "portId": "CL1-A",
  "hostGroupNumber": 0,
  "hostGroupName": "my@host999",
  "hostWwn": "000000102ccec9",
  "wwnNickname": "Myhostwwnsecret"
}
```

Attribute	Type	Description
hostWwnId	string	Object ID for the WWN
portId	string	Port number

Attribute	Type	Description
hostGroupNumber	int	Host group number of the port
hostGroupName	string	Host group name of the port
hostWwn	string	WWN of the host bus adapter registered for the host group
wwnNickname	string	WWN nickname

Status codes

For details on the status codes of the request for this operation, see the description on HTTP status codes.

Coding example

```
curl -v -H "Accept:application/json" -H "Content-Type:application/json" -H
"Authorization:Session d7b673af189048468c5af9bcf3b6bb6f" -X GET https://
192.0.2.100/ConfigurationManager/v1/objects/host-wwns/CL1-A,0,
000000102ccec9
```

Registering a WWN for the host group

The following request registers the host bus adapter WWN for the host group of the specified port.

Execution permission

Storage Administrator (Provisioning)

Request line

```
POST base-URL/v1/objects/host-wwns
```

Request message

Object ID

None.

Query parameters

None.

Body

```
{
  "hostWwn": "210003e08b0256f9",
  "portId": "CL1-A",
  "hostGroupNumber": 5
}
```

Attribute	Type	Description
hostWwn	string	(Required) The WWN of the host bus adapter Specify a hexadecimal number consisting of 16 characters. You can specify the number by using colons (:) as separators.
portId	string	(Required) Port number
hostGroupNumber	int	(Required) The host group number

Response message**Body**

A job object is returned. For details on attributes other than `affectedResources`, see the section explaining job objects.

Attribute	Description
affectedResources	URL of the registered WWN

Status codes

For details on the status codes of the request for this operation, see the description on HTTP status codes.

Coding example

```
curl -v -H "Accept:application/json" -H "Content-Type:application/json" -H "Authorization:Session d7b673af189048468c5af9bcf3bbbb6f" -X POST --data-binary @./InputParameters.json https://192.0.2.100/ConfigurationManager/v1/objects/host-wnns
```

Setting the nickname for a WWN

The following request sets the nickname for a WWN registered in the host group. You can also delete the nickname that is already set.

Execution permission

Storage Administrator (Provisioning)

Request line

```
PATCH base-URL/v1/objects/host-wwns/object-ID
```

Request message

Object ID

Specify the value of `hostWwnId` that was obtained by the processing to get information about the WWN. You can also specify the following attributes and connect them with commas:

portId, hostGroupNumber, hostWwn

Attribute	Type	Description
portId	string	(Required) Port number
hostGroupNumber	int	(Required) Host group number of the port
hostWwn	string	(Required) WWN of the host bus adapter registered in the host group

Query parameters

None.

Body

When setting the nickname for the WWN:

```
{
  "wnNickname": "REST_API_Created"
}
```

When deleting the nickname from the WWN:

```
{
  "wwnNickname": ""
}
```

Attribute	Type	Description
wwnNickname	string	(Required) Specify a WWN nickname consisting of 1 to 64 characters. You cannot specify the nickname that is used for other WWN of the same port. To delete the nickname from the WWN, specify a null character string.

Response message

Body

A job object is returned. For details on attributes other than `affectedResources`, see the description on job objects.

Attribute	Description
affectedResources	URL of the WWN whose settings were changed

Action template

None.

Status codes

For details on the status codes of the request for this operation, see the description on HTTP status codes.

Coding example

```
curl -v -H "Accept:application/json" -H "Content-Type:application/json" -H "Authorization:Session d7b673af189048468c5af9bcf3b66b6f" -X PATCH --data-binary @./InputParameters.json https://192.0.2.100/ConfigurationManager/v1/objects/host-wwns/CL1-A,0,1212121212121212
```

Deleting the WWN from a host group

The following request deletes the WWN information registered for the host group of the specified port.

Execution permission

Storage Administrator (Provisioning)

Request line

```
DELETE base-URL/v1/objects/host-wwns/object-ID
```

Request message

Object ID

Specify the `hostWwnId` value obtained by getting information about the WWN. You can also specify the following attributes and connect them with commas:

```
portId, hostGroupNumber, hostWwn
```

Attribute	Type	Description
portId	string	(Required) Port number
hostGroupNumber	int	(Required) The host group number
hostWwn	string	(Required) The WWN of the host bus adapter Specify the attribute without using colons (:).

Query parameters

None.

Body

None.

Response message

Body

A job object is returned. For details on attributes other than `affectedResources`, see the section explaining job objects.

Attribute	Description
affectedResources	URL of the deleted WWN

Status codes

For details on the status codes of the request for this operation, see the description on HTTP status codes.

Coding example

```
curl -v -H "Accept:application/json" -H "Content-Type:application/json" -H
"Authorization:Session d7b673af189048468c5af9bcf3bbbb6f" -X DELETE
https://192.0.2.100/ConfigurationManager/v1/objects/host-wwns/CL1-A,5,
210003e08b0256f9
```

Getting iSCSI names

Specifying a port and iSCSI target, the following request gets the iSCSI name information registered for the iSCSI target.

Execution permission

Storage Administrator (View Only)

Request line

```
GET base-URL/v1/objects/host-iscsis
```

Request message

Object ID

None.

Query parameters

Parameter	Type	Filter Condition
portId	string	(Required) Port number
hostGroupNumber	int	(Optional) Target ID of the iSCSI target

Parameter	Type	Filter Condition
		You must specify one of the following parameters: this parameter, the <code>hostGroupName</code> parameter, or the <code>hostGroupNumberList</code> parameter.
<code>hostGroupName</code>	string	(Optional) Name of the iSCSI target You must specify one of the following parameters: this parameter, the <code>hostGroupNumber</code> parameter, or the <code>hostGroupNumberList</code> parameter.
<code>hostGroupNumberList</code>	string	(Optional) Target IDs of iSCSI targets You can obtain information quickly by specifying this parameter. To specify multiple IDs, delimit each ID by using a comma. You must specify one of the following parameters: this parameter, the <code>hostGroupNumber</code> parameter, or the <code>hostGroupName</code> parameter.
<code>displayHostGroupName</code>	boolean	(Optional) If you specify the <code>hostGroupNumberList</code> parameter, specify whether to get the names of the iSCSI targets (the values of the <code>hostGroupName</code> attribute). If you specify <code>false</code> , the processing will take shorter than if you were to specify <code>true</code> . <ul style="list-style-type: none"> ▪ <code>true</code>: Obtain the names of the iSCSI targets. ▪ <code>false</code>: Do not obtain the names of the iSCSI targets. If you specify this parameter but do not specify the <code>hostGroupNumberList</code> parameter, this parameter will be ignored. If this parameter is omitted, the value <code>true</code> is assumed.

Body

None.

Response message**Body**

```
{
  "data": [
    {
      "hostIscsiId": "CL1-D,1,iqn.1994-05.com.redhat%3A496799ba93",
      "portId": "CL1-D",
      "hostGroupNumber": 1,
      "hostGroupName": "1D-G00",
      "iscsiName": "iqn.1994-05.com.redhat:496799ba93",
      "iscsiNickname": "a_a"
    },
    {
      "hostIscsiId": "CL1-D,1,iqn.1994-05.com.redhat
%3Aa7526e46aac.target",
      "portId": "CL1-D",
      "hostGroupNumber": 1,
      "hostGroupName": "1D-G00",
      "iscsiName": "iqn.1994-05.com.redhat:a7526e46aac.target",
      "iscsiNickname": "a_a"
    }
  ]
}
```

Attribute	Type	Description
hostIscsiId	string	Object ID for the iSCSI name
portId	string	Port number
hostGroupNumber	int	Target ID of the iSCSI target
hostGroupName	string	Name of the iSCSI target This attribute will not be obtained if the <code>hostGroupNumberList</code> parameter is specified as a query parameter and <code>false</code> is specified for the <code>displayHostGroupName</code> parameter.
iscsiName	string	iSCSI name of the host bus adapter (iSCSI initiator) registered for the iSCSI target
iscsiNickname	string	iSCSI nickname

Status codes

For details on the status codes of the request for this operation, see the section explaining HTTP status codes.

Coding example

```
curl -v -H "Accept:application/json" -H "Content-Type:application/json" -H
"Authorization:Session d7b673af189048468c5af9bcf3bbbb6f" -X GET "https://
192.0.2.100/ConfigurationManager/v1/objects/host-iscsis?portId=CL1-
D&hostGroupNumber=1"
```

Getting information about a specific iSCSI name

If you specify a port, iSCSI target, and iSCSI name, the following request gets information about that specific iSCSI name.

Execution permission

Storage Administrator (View Only)

Request line

```
GET base-URL/v1/objects/host-iscsis/object-ID
```

Request message**Object ID**

Specify the `hostIscsiId` value obtained by getting the iSCSI name. You can also specify the following attributes and connect them with commas:

```
portId,hostGroupNumber,iscsiName
```

Attribute	Type	Description
portId	string	(Required) Port number
hostGroupNumber	int	(Required) Target ID of the iSCSI target
iscsiName	string	(Required) iSCSI name of the host bus adapter (iSCSI initiator)

Query parameters

None.

Body

None.

Response message**Body**

```
{
  "hostIscsiId": "CL1-D,1,iqn.1994-05.com.redhat%3A496799ba93",
  "portId": "CL1-D",
  "hostGroupNumber": 1,
  "hostGroupName": "1D-G00",
  "iscsiName": "iqn.1994-05.com.redhat:496799ba93",
  "iscsiNickname": "a_a"
}
```

Attribute	Type	Description
hostIscsiId	string	Object ID for the iSCSI name
portId	string	Port number
hostGroupNumber	int	Target ID of the iSCSI target
hostGroupName	string	Name of the iSCSI target
iscsiName	string	iSCSI name of the host bus adapter (iSCSI initiator) registered for the iSCSI target
iscsiNickname	string	iSCSI nickname

Status codes

For details on the status codes of the request for this operation, see the description on HTTP status codes.

Coding example

```
curl -v -H "Accept:application/json" -H "Content-Type:application/json" -H
"Authorization:Session d7b673af189048468c5af9bcf3b66b6f" -X GET https://
192.0.2.100/ConfigurationManager/v1/objects/host-iscsis/CL1-D,1,iqn.1994-
05.com.redhat%3A496799ba93
```

Registering the iSCSI name for the iSCSI target

For the iSCSI target of the specified port, the following request registers the iSCSI name of the host on the initiator side.

Execution permission

Storage Administrator (Provisioning)

Request line

```
POST base-URL/v1/objects/host-iscsis
```

Request message

Object ID

None.

Query parameters

None.

Body

```
{
  "portId": "CL1-D",
  "hostGroupNumber": 1,
  "iscsiName": "iqn.myrestapiiscsi20150907"
}
```

Attribute	Type	Description
iscsiName	string	(Required) iSCSI name of the host bus adapter (iSCSI initiator)

Attribute	Type	Description
		Specify this item in the iqn or eui format. <ul style="list-style-type: none"> ▪ iqn format <p>Specify a value in the range from 5 to 223. You can use the following characters:</p> <p>Alphanumeric characters (lowercase), periods (.), hyphens (-), and colons (:)</p> <p>Specification example: iqn.2014-04.jp.co.hitachi:xxx.h70.i.62510.1a.ffa</p> ▪ eui format <p>After "eui.", specify a hexadecimal number. Specify a value consisting of 20 characters.</p> <p>Specification example: eui.ABCDEF1234567890</p>
portId	string	(Required) Port number
hostGroupNumber	int	(Required) Target ID of the iSCSI target

Response message

Body

A job object is returned. For details on attributes other than `affectedResources`, see the section explaining job objects.

Attribute	Description
affectedResources	URL of the registered iSCSI name

Status codes

For details on the status codes of the request for this operation, see the description on HTTP status codes.

Coding example

```
curl -v -H "Accept:application/json" -H "Content-Type:application/json" -H
"Authorization:Session d7b673af189048468c5af9bcf3bbbbb6f" -X POST --data-
binary @./InputParameters.json https://192.0.2.100/ConfigurationManager/v1/
objects/host-iscsis
```

Setting the nickname for an iSCSI name

The following request sets the nickname for an iSCSI name registered for the iSCSI target. You can also delete the nickname that is already set.

Execution permission

Storage Administrator (Provisioning)

Request line

```
PATCH base-URL/v1/objects/host-iscsis/object-ID
```

Request message

Object ID

Specify the value of `hostIscsiId` that was obtained by the processing to get information about the iSCSI name. You can also specify the attributes and connect them with commas as follows:

portId, hostGroupNumber, iscsiName

Attribute	Type	Description
portId	string	(Required) Port number
hostGroupNumber	int	(Required) Target ID of the iSCSI target
iscsiName	string	(Required) iSCSI name of the host bus adapter (iSCSI initiator) registered for the iSCSI target

Query parameters

None.

Body

When setting the nickname for the iSCSI name

```
{
  "iscsiNickname": "REST_API_Testing"
}
```

When deleting the nickname from the iSCSI name:

```
{
  "iscsiNickname": ""
}
```

Attribute	Type	Description
iscsiNickname	string	(Required) Specify a nickname consisting of 1 to 32 characters for the iSCSI name of the host bus adapter. To delete the nickname from the iSCSI name, specify a null character string.

Response message

Body

A job object is returned. For details on attributes other than `affectedResources`, see the description on job objects.

Attribute	Description
affectedResources	URL of the iSCSI name whose settings were changed

Action template

None.

Status codes

For details on the status codes of the request for this operation, see the description on HTTP status codes.

Coding example

```
curl -v -H "Accept:application/json" -H "Content-Type:application/json" -H
"Authorization:Session d7b673af189048468c5af9bcf3b6bb6f" -X PATCH --data-
binary @./InputParameters.json https://192.0.2.100/ConfigurationManager/v1/
objects/host-iscsis/CL1-B,0,iqn.20150907
```

Deleting the iSCSI name from the iSCSI target

The following request deletes the iSCSI name of the host bus adapter (iSCSI initiator) from the iSCSI target of the specified port.

Execution permission

Storage Administrator (Provisioning)

Request lineDELETE *base-URL/v1/objects/host-iscsis/object-ID***Request message****Object ID**

Specify the `hostIscsiId` value obtained by getting the iSCSI name. You can also specify the following attributes and connect them with commas:

portId,hostGroupNumber,iscsiName

Attribute	Type	Description
portId	string	(Required) Port number
hostGroupNumber	int	(Required) Target ID of the iSCSI target
iscsiName	string	(Required) iSCSI name of the host bus adapter (iSCSI initiator)

Query parameters

None.

Body

None.

Response message**Body**

A job object is returned. For details on attributes other than `affectedResources`, see the section explaining job objects.

Attribute	Description
affectedResources	URL of the deleted iSCSI name

Status codes

For details on the status codes of the request for this operation, see the description on HTTP status codes.

Coding example

```
curl -v -H "Accept:application/json" -H "Content-Type:application/json" -H
"Authorization:Session d7b673af189048468c5af9bcf3bbbb6f" -X DELETE
https://192.0.2.100/ConfigurationManager/v1/objects/host-iscsis/CL1-D,1,
iqn.myrestapiiscsi20150907
```

Getting information about CHAP users

Using the specified port and iSCSI target, the following request gets the CHAP user information that is specified for the iSCSI target. Note that if the iSCSI target name or CHAP user name contains a single-byte space, the CHAP user name cannot be obtained.

Execution permission

Storage Administrator (View Only)

Request line

```
GET base-URL/v1/objects/chap-users
```

Request message**Object ID**

None.

Query parameters

Parameter	Type	Filter Condition
portId	string	(Required) Port number
hostGroupNumber	int	(Required) Target ID of the iSCSI target

Body

None.

Response message**Body**

```
{
  "data": [
    {
      "chapUserId": "CL1-D,0,INI,TESTing",
      "portId": "CL1-D",
      "hostGroupNumber": 0,
      "hostGroupName": "1D-G00",
      "chapUserName": "TESTing",
      "wayOfChapUser": "INI"
    },
    {
      "chapUserId": "CL1-D,0,TAR,mychap",
      "portId": "CL1-D",
      "hostGroupNumber": 0,
      "hostGroupName": "1D-G00",
      "chapUserName": "mychap",
      "wayOfChapUser": "TAR"
    }
  ]
}
```

Attribute	Type	Description
chapUserId	string	Object ID for the CHAP user
portId	string	Port number
hostGroupNumber	int	Target ID of the iSCSI target
hostGroupName	string	Name of the iSCSI target
chapUserName	string	CHAP user name
wayOfChapUser	string	Type of the CHAP user name <ul style="list-style-type: none"> ▪ TAR: The CHAP user name of the iSCSI target side ▪ INI: The CHAP user name of the host bus adapter (iSCSI initiator) side

Status codes

For details on the status codes of the request for this operation, see the description on HTTP status codes.

Coding example

```
curl -v -H "Accept:application/json" -H "Content-Type:application/json" -H
"Authorization:Session d7b673af189048468c5af9bcf3b66b6f" -X GET "https://
192.0.2.100/ConfigurationManager/v1/objects/chap-users?portId=CL1-
D&hostGroupNumber=0"
```

Getting information about a specific CHAP user

The following request gets information about the specified CHAP user. Note that if the iSCSI target name or CHAP user name contains a space, the CHAP user name cannot be obtained.

Execution permission

Storage Administrator (View Only)

Request line

```
GET base-URL/v1/objects/chap-users/object-ID
```

Request message**Object ID**

Specify the `chapUserId` value obtained by getting information about the CHAP user. You can also specify the following attributes and connect them with commas:

```
portId,hostGroupNumber,wayOfChapUser,chapUserName
```

Attribute	Type	Description
portId	string	(Required) Port number
hostGroupNumber	int	(Required) Target ID of the iSCSI target
wayOfChapUser	string	(Required) Type of the CHAP user name <ul style="list-style-type: none"> ▪ TAR: The CHAP user name of the iSCSI target side ▪ INI: The CHAP user name of the host bus adapter (iSCSI initiator) side
chapUserName	string	(Required) The CHAP user name

Query parameters

None.

Body

None.

Response message**Body**

```
{
  "chapUserId": "CL1-D,0,INI,mychap",
  "portId": "CL1-D",
  "hostGroupNumber": 0,
  "hostGroupName": "1D-G00",
  "chapUserName": "mychap",
  "wayOfChapUser": "INI"
}
```

Attribute	Type	Description
chapUserId	string	Object ID for the CHAP user
portId	string	Port number
hostGroupNumber	int	Target ID of the iSCSI target
hostGroupName	string	Name of the iSCSI target
chapUserName	string	CHAP user name
wayOfChapUser	string	Type of the CHAP user name <ul style="list-style-type: none"> ▪ TAR: The CHAP user name of the iSCSI target side ▪ INI: The CHAP user name of the host bus adapter (iSCSI initiator) side

Status codes

For details on the status codes of the request for this operation, see the description on HTTP status codes.

Coding example

```
curl -v -H "Accept:application/json" -H "Content-Type:application/json" -H
"Authorization:Session d7b673af189048468c5af9bcf3b6bb6f" -X GET https://
192.0.2.100/ConfigurationManager/v1/objects/chap-users/CL1-D,0,INI,mychap
```

Setting the CHAP user name for the iSCSI target

The following request sets the CHAP user name for the iSCSI target. Two types of CHAP user names can be set: the CHAP user name of the iSCSI target side and the CHAP user name of the host (iSCSI initiator) that connects to the iSCSI target.

Execution permission

Storage Administrator (Provisioning)

Request line

```
POST base-URL/v1/objects/chap-users
```

Request message**Object ID**

None.

Query parameters

None.

Body

The following coding example sets the CHAP user name for the iSCSI target side:

```
{
  "chapUserName": "MyRESTChapUser",
  "portId": "CL1-D",
  "hostGroupNumber": 1,
  "wayOfChapUser": "TAR"
}
```

Attribute	Type	Description
chapUserName	string	(Required) Specify a CHAP user name consisting of 1 to 223 characters.
portId	string	(Required) Port number

Attribute	Type	Description
hostGroupNumber	int	(Required) Target ID of the iSCSI target
wayOfChapUser	string	(Required) Type of the CHAP user name <ul style="list-style-type: none"> ▪ TAR: The CHAP user name of the iSCSI target side ▪ INI: The CHAP user name of the host bus adapter (iSCSI initiator) side

Response message

Body

A job object is returned. For details on attributes other than `affectedResources`, see the section explaining job objects.

Attribute	Description
affectedResources	URL of the created CHAP user name

Status codes

For details on the status codes of the request for this operation, see the description on HTTP status codes.

Coding example

```
curl -v -H "Accept:application/json" -H "Content-Type:application/json" -H
"Authorization:Session d7b673af189048468c5af9bcf3b66b6f" -X POST --data-
binary @./InputParameters.json https://192.0.2.100/ConfigurationManager/v1/
objects/chap-users
```

Setting a secret for the CHAP user

The following request sets a secret for the specified CHAP user. If a secret is already set for the specified CHAP user, the current secret is overwritten.

Execution permission

Storage Administrator (Provisioning)

Request line

```
PATCH base-URL/v1/objects/chap-users/object-ID
```

Request message**Object ID**

Specify the `chapUserId` value obtained by getting information about the CHAP user. You can also specify the following attributes and connect them with commas:

```
portId,hostGroupNumber,wayOfChapUser,chapUserName
```

Attribute	Type	Description
portId	string	(Required) Port number
hostGroupNumber	int	(Required) Target ID of the iSCSI target
wayOfChapUser	string	(Required) Type of the CHAP user name <ul style="list-style-type: none"> ▪ <code>TAR</code>: The CHAP user name of the iSCSI target side ▪ <code>INI</code>: The CHAP user name of the host bus adapter (iSCSI initiator) side
chapUserName	string	(Required) The CHAP user name

Query parameters

None.

Body

When setting the secret password for the CHAP user:

```
{
  "chapPassword": "TopSecretForMyChap"
}
```

When resetting the secret password of the CHAP user:

```
{
  "chapPassword": ""
}
```

Attribute	Type	Description
chapPassword	string	Specify a secret consisting of 12 to 32 characters for the specified CHAP user. If you specify a null character, the password is reset.

Response message**Body**

A job object is returned. For details on attributes other than `affectedResources`, see the section explaining job objects.

Attribute	Description
affectedResources	URL of the CHAP user name for which the secret was set

Action template

None.

Status codes

For details on the status codes of the request for this operation, see the description on HTTP status codes.

Coding example

```
curl -v -H "Accept:application/json" -H "Content-Type:application/json" -H
"Authorization:Session d7b673af189048468c5af9bcf3bbbb6f" -X PATCH --data-
binary @./InputParameters.json https://192.0.2.100/ConfigurationManager/v1/
objects/chap-users/CL1-D,1,TAR,MyRESTChapUser
```

Deleting the CHAP user from the iSCSI target

The following request deletes the CHAP user name specified for the iSCSI target.

Execution permission

Storage Administrator (Provisioning)

Request line

```
DELETE base-URL/v1/objects/chap-users/object-ID
```

Request message**Object ID**

Specify the `chapUserId` value obtained by getting information about the CHAP user. You can also specify the following attributes and connect them with commas:

```
portId, hostGroupNumber, wayOfChapUser, chapUserName
```

Attribute	Type	Description
portId	string	(Required) Port number
hostGroupNumber	int	(Required) Target ID of the iSCSI target
wayOfChapUser	string	(Required) Type of the CHAP user name <ul style="list-style-type: none"> ▪ <code>TAR</code>: The CHAP user name of the iSCSI target side ▪ <code>INI</code>: The CHAP user name of the host bus adapter (iSCSI initiator) side
chapUserName	string	(Required) The CHAP user name

Query parameters

None.

Body

None.

Response message**Body**

A job object is returned. For details on attributes other than `affectedResources`, see the section explaining job objects.

Attribute	Description
affectedResources	URL of the deleted CHAP user name

Status codes

For details on the status codes of the request for this operation, see the description on HTTP status codes.

Coding example

```
curl -v -H "Accept:application/json" -H "Content-Type:application/json" -H
"Authorization:Session d7b673af189048468c5af9bcf3b66b6f" -X DELETE
https://192.0.2.100/ConfigurationManager/v1/objects/chap-users/CL1-D,1,TAR,
MyRESTChapUser
```

Getting information about LU paths

The following request gets information about LU paths defined for the iSCSI target or the host group for the port.

Execution permission

Storage Administrator (View Only)

Request line

```
GET base-URL/v1/objects/luns
```

Request message**Object ID**

None.

Query parameters

Parameter	Type	Filter Condition
portId	string	(Required) Port number
hostGroupNumber	int	(Required) Host group number (for an iSCSI target, this is the target ID) You must specify either this parameter or the <code>hostGroupNumberList</code> parameter.
isBasicLunInformation	boolean	(Optional) Specify whether to get only basic information. <ul style="list-style-type: none"> ▪ <code>true</code>: Gets only basic information. (Does not get the host reservation status.) ▪ <code>false</code>: Gets all the items. If this parameter is omitted, <code>false</code> is assumed.

Parameter	Type	Filter Condition
lunOption	string	<p>(Optional) Specify the type of information you want to get.</p> <ul style="list-style-type: none"> ALUA: Gets information about ALUA settings. <p>If you specify both this parameter and the <code>hostGroupNumberList</code> parameter, this parameter will be ignored.</p>
hostGroupNumberList	string	<p>(Optional) Host group number (for an iSCSI target, this is the target ID)</p> <p>You can obtain information quickly by specifying this parameter. If you specify this parameter, the value of the <code>hostModeOptions</code> attribute is not obtained.</p> <p>To specify multiple IDs, delimit each ID by using a comma.</p> <p>You must specify either this parameter or the <code>hostGroupNumber</code> parameter.</p>

Body

None.

Response message**Body**

The following is an example of the output when only basic information is obtained:

```
{
  "data": [
    {
      "lunId": "CL1-A,1,1",
      "portId": "CL1-A",
      "hostGroupNumber": 1,
      "hostMode": "LINUX/IRIX",
      "lun": 1,
      "ldevId": 1,
      "isCommandDevice": false
    },
    {
      "lunId": "CL1-A,1,2",
      "portId": "CL1-A",
      "hostGroupNumber": 1,
```

```

    "hostMode": "LINUX/IRIX",
    "lun": 2,
    "ldevId": 2,
    "isCommandDevice": false
  }
]
}

```

The following is an example of the output generated when getting information about all items:

```

{
  "data": [
    {
      "lunId": "CL1-A,1,1",
      "portId": "CL1-A",
      "hostGroupNumber": 1,
      "hostMode": "LINUX/IRIX",
      "lun": 1,
      "ldevId": 1,
      "isCommandDevice": false,
      "luHostReserve": {
        "openSystem": false,
        "persistent": false,
        "pgrKey": false,
        "mainframe": false,
        "acaReserve": false
      }
    }
  ]
}

```

Attribute	Type	Description
lunId	string	Object ID for the LUN
portId	string	Port number
hostGroupNumber	int	Host group number of the port (for an iSCSI target, this is the target ID)
hostMode	string	Host mode for setting the host adapter of the host group For details on the values to be obtained, see the description of the API function for changing the host group or iSCSI target settings.
lun	int	LUN between the host group and the mapped LDEV

Attribute	Type	Description
ldevId	int	LDEV number
isCommandDevice	boolean	Gets information about whether the device is a command device.
luHostReserve	object	<p>Host reservation status of the LU</p> <p>When <code>false</code> is specified for <code>isBasicLunInformation</code> and the LU is in the reserved status, the following attributes are output:</p> <ul style="list-style-type: none"> ▪ <code>openSystem</code> (boolean) Indicates whether the LU is reserved for open systems. ▪ <code>persistent</code> (boolean) Indicates whether the LU is in the persistent reservation status. ▪ <code>pgrKey</code> (boolean) Indicates whether the LU is reserved by a PGR key. ▪ <code>mainframe</code> (boolean) Indicates whether the LU is reserved for mainframes. ▪ <code>acaReserve</code> (boolean) Indicates whether the LU is in the ACA reservation status.
hostModeOptions	int[]	<p>Number of options for setting the host mode option of the host group</p> <p>This attribute is not displayed if <code>hostGroupNumberList</code> is specified as a query parameter.</p> <p>For details on the number to be obtained, see the <i>Provisioning Guide</i>.</p>
isAluaEnabled	boolean	<p>Whether the ALUA attribute is enabled:</p> <p>This attribute is displayed only if you specified <code>ALUA</code> for <code>lunOption</code> in the query parameters.</p> <ul style="list-style-type: none"> ▪ <code>true</code>: The ALUA attribute is enabled. ▪ <code>false</code>: The ALUA attribute is disabled.
asymmetricAccessState	string	Priority level of the ALUA path

Attribute	Type	Description
		<p>This attribute is displayed only if you specified ALUA for lunOption in the query parameters.</p> <ul style="list-style-type: none"> ▪ Active/Optimized: Higher priority ▪ Active/Non-Optimized: Lower priority ▪ Not Supported: Not supported

Status codes

For details on the status codes of the request for this operation, see the description on HTTP status codes.

Coding example

When getting only basic information:

```
curl -v -H "Accept:application/json" -H "Content-Type:application/json" -H
"Authorization:Session d7b673af189048468c5af9bcf3bbbb6f" -X GET "https://
192.0.2.100/ConfigurationManager/v1/objects/luns?portId=CL1-
A&hostGroupNumber=1&isBasicLunInformation=true"
```

When getting information about all items:

```
curl -v -H "Accept:application/json" -H "Content-Type:application/json" -H
"Authorization:Session d7b673af189048468c5af9bcf3bbbb6f" -X GET "https://
192.0.2.100/ConfigurationManager/v1/objects/luns?portId=CL1-
A&hostGroupNumber=1"
```

Getting information about a specific LU path

The following request gets information about the specified LU path.

Execution permission

Storage Administrator (View Only)

Request line

```
GET base-URL/v1/objects/luns/object-ID
```

Request message**Object ID**

Specify the `lunId` value obtained by getting information about the LU path. You can also specify the following attributes and connect them with commas:

portId, hostGroupNumber, lun

Attribute	Type	Description
portId	string	(Required) Port number
hostGroupNumber	int	(Required) Host group number (target ID for an iSCSI port)
lun	int	(Required) LUN

Query parameters

None.

Body

None.

Response message**Body**

```
{
  "lunId": "CL1-A,1,1",
  "portId": "CL1-A",
  "hostGroupNumber": 1,
  "hostMode": "LINUX/IRIX",
  "lun": 1,
  "ldevId": 1,
  "isCommandDevice": false,
  "luHostReserve": {
    "openSystem": false,
    "persistent": false,
    "pgrKey": false,
    "mainframe": false,
    "acaReserve": false
  },
  "hostModeOptions": [
    2,
    6
  ]
}
```

Attribute	Type	Description
lunId	string	Object ID for the LUN
portId	string	Port number
hostGroupNumber	int	Host group number of the port (for an iSCSI target, this is the target ID)
hostMode	string	Host mode for setting the host adapter of the host group For details on the values to be obtained, see <i>Changing the host group or iSCSI target settings</i> .
lun	int	LUN between the host group and the mapped LDEV
ldevId	int	LDEV number
isCommandDevice	boolean	Information about whether the device is a command device is output.
luHostReserve	object	Host reservation status of the LU When <code>false</code> is specified for <code>isBasicLunInformation</code> and the LU is in the reserved status, the following attributes are output: <ul style="list-style-type: none"> ▪ <code>openSystem</code> (boolean) Indicates whether the LU is reserved for open systems. ▪ <code>persistent</code> (boolean) Indicates whether the LU is in the persistent reservation status. ▪ <code>pgrKey</code> (boolean) Indicates whether the LU is reserved by a PGR key. ▪ <code>mainframe</code> (boolean) Indicates whether the LU is reserved for mainframes. ▪ <code>acaReserve</code> (boolean) Indicates whether the LU is in the ACA reservation status.
hostModeOptions	int[]	Number of options for setting the host mode option of the host group For details on the number to be obtained, see the <i>Provisioning Guide</i> .

Status codes

For details on the status codes of the request for this operation, see the description on HTTP status codes.

Coding example

```
curl -v -H "Accept:application/json" -H "Content-Type:application/json" -H
"Authorization:Session d7b673af189048468c5af9bcf3bbbb6f" -X GET https://
192.0.2.100/ConfigurationManager/v1/objects/luns/CL1-A,1,1?
isBasicLunInformation=true
```

Sending the ping command to a specified host

The request below checks the connection status of a storage system and a host by sending the ping command from a specified iSCSI port on the storage system to the host.

Execution permission

Storage Administrator (View Only)

Request line

```
POST base-URL/v1/objects/ports/object-ID/actions/ping/invoke
```

Request message**Object ID**

Specify the `portId` value obtained by getting information about the port.

Attribute	Type	Description
portId	string	(Required) Port number

Query parameters

None.

Body

```
{
  "parameters" : {
    "ipAddress" : "192.168.0.100"
  }
}
```

Attribute	Type	Description
ipAddress	string	(Required) IP address of the target host You can specify an IPv4 address or IPv6 address.

Response message

Body

```
{
  "transmittedPackets": 5,
  "receivedPackets": 5
}
```

Attribute	Type	Description
transmittedPackets	int	Number of sent packets
receivedPackets	int	Number of received packets

Action template

None.

Status codes

The following table describes the meaning of the status code of the request for this operation. For details on other status codes, see the description on HTTP status codes.

Status code	Message	Description
503	Service unavailable	The port on the storage system is busy.

Coding example

```
curl -v -H "Accept:application/json" -H "Content-Type:application/json" -H
"Authorization:Session d7b673af189048468c5af9bcf3b6bb6f" -X POST --data-
binary @./InputParameters.json http://192.0.2.100/ConfigurationManager/v1/
objects/ports/CL1-A/actions/ping/invoke
```

Setting the LU path

The following request sets the LU path by mapping the LDEV with the LUN in the host group or in the iSCSI target of the specified port.

Execution permission

Storage Administrator (Provisioning)

Request line

```
POST base-URL/v1/objects/luns
```

Request message

Object ID

None.

Query parameters

None.

Body

The following coding example sets an LU path by specifying the LUN:

```
{
  "portIds": ["CL1-A","CL2-A"],
  "hostGroupNumber": 1,
  "ldevId": 64,
  "lun": 12
}
```

The following coding example sets an LU path without specifying the LUN:

```
{
  "portId": "CL1-A",
  "hostGroupNumber": 1,
  "ldevId": 64
}
```

Attribute	Type	Description
portId	string	(Optional) Port number Specify this attribute when setting the LU path for one port.

Attribute	Type	Description
		This attribute cannot be specified at the same time as the <code>portIds</code> attribute. You must specify either the <code>portId</code> attribute or the <code>portIds</code> attribute.
<code>portIds</code>	string[]	(Optional) Port number Specify this attribute when setting the LU paths for multiple ports at the same time. You can specify up to 6 port numbers. This attribute cannot be specified at the same time as the <code>portId</code> attribute. You must specify either the <code>portId</code> attribute or the <code>portIds</code> attribute.
<code>hostGroupNumber</code>	int	(Required) Host group number (target ID for an iSCSI port)
<code>lun</code>	int	(Optional) LUN If this attribute is omitted, a value is automatically set. You cannot specify the same LUN for multiple LDEVs.
<code>ldevId</code>	int	(Required) Specify the LDEV number with a decimal (base 10) number. An LDEV cannot be mapped to another LUN in the same host group.

For host groups for which host mode option 60 is enabled, if you specify `portId` but omit `lun`, automatic configuration of LUNs might fail. If this happens, try the operation again, but specify `portIds` instead of `portId`.

Response message

Body

A job object is returned. For details on attributes other than `affectedResources`, see the section explaining job objects.

Attribute	Description
<code>affectedResources</code>	URL of the created LU path

Status codes

For details on the status codes of the request for this operation, see the description on HTTP status codes.

Coding example

```
curl -v -H "Accept:application/json" -H "Content-Type:application/json" -H
"Authorization:Session d7b673af189048468c5af9bcf3bbbb6f" -X POST --data-
binary @./InputParameters.json https://192.0.2.100/ConfigurationManager/v1/
objects/luns
```

Setting the priority levels of ALUA paths

For a global-active device in a cross-path configuration (using a Fibre Channel connection), by enabling the ALUA attribute, you can set the priority levels of paths between a host and a storage system.

Execution permission

Storage Administrator (Provisioning)

Request line

```
POST base-URL/v1/services/lun-service/actions/change-asymmetric-access-
state/invoke
```

Request message**Object ID**

None.

Query parameters

None.

Body

```
{
  "parameters": {
    "portId" : "CL1-A",
    "hostGroupNumber" : 1,
    "asymmetricAccessState" : "Active/Optimized"
  }
}
```

Attribute	Type	Description
portId	string	(Required) Port number
hostGroupNumber	int	(Required) Host group number
asymmetricAccessState	string	(Required) Priority level of the ALUA path <ul style="list-style-type: none"> ▪ Active/Optimized: Higher priority ▪ Active/Non-Optimized: Lower priority

Response message

Body

A job object is returned. For details on attributes other than `affectedResources`, see the section explaining job objects.

Attribute	Description
affectedResources	URL for getting information about LU paths You can get information about the priority level of an ALUA path by specifying <code>lunOption=ALUA</code> in the query parameters of the API function for getting information about LU paths.

Action template

None.

Status codes

For details on the status codes of the request for this operation, see the description of HTTP status codes.

Coding example

```
curl -v -H "Accept:application/json" -H "Content-Type:application/json" -H
"Authorization:Session d7b673af189048468c5af9bcf3bbbb6f" -X POST --data-
binary @./InputParameters.json https://192.0.2.100/ConfigurationManager/v1/
services/lun-service/actions/change-asymmetric-access-state/invoke
```

Deleting a LU path

The following request deletes the LU path defined for the host group or iSCSI target of the specified port.

Execution permission

Storage Administrator (Provisioning)

Request line

```
DELETE base-URL/v1/objects/luns/object-ID
```

Request message

Object ID

Specify the `lunId` value obtained by getting information about the LU path. You can also specify the following attributes and connect them with commas:

```
portId, hostGroupNumber, lun
```

Attribute	Type	Description
portId	string	(Required) Port number
hostGroupNumber	int	(Required) Host group number (target ID for an iSCSI port)
lun	int	(Required) LUN

Query parameters

None.

Body

None.

Response message

Body

A job object is returned. For details on attributes other than `affectedResources`, see the section explaining job objects.

Attribute	Description
affectedResources	URL of the deleted LU path

Status codes

For details on the status codes of the request for this operation, see the description on HTTP status codes.

Coding example

```
curl -v -H "Accept:application/json" -H "Content-Type:application/json" -H
"Authorization:Session d7b673af189048468c5af9bcf3bbbb6f" -X DELETE
https://192.0.2.100/ConfigurationManager/v1/objects/luns/CL1-A,1,64
```

Setting the command device

The following request sets and releases the command device specified for the LDEV. The request also changes the attributes of the command device.



Note:

If you do not specify the `isSecurityEnabled` attribute, the `isUserAuthenticationEnabled` attribute, or the `isDeviceGroupDefinitionEnabled` attribute, the settings will be disabled after execution, even if the settings were enabled before execution. If you change a command device attribute, specify this item to prevent the setting from being unexpectedly disabled.

Execution permission

Storage Administrator (Provisioning)

Request line

```
POST base-URL/v1/objects/ldevs/object-ID/actions/set-as-command-device/
invoke
```

Request message**Object ID**

Specify the `ldevId` value obtained by getting information about volumes.

Attribute	Type	Description
<code>ldevId</code>	int	(Required) Specify the LDEV number with a decimal (base 10) number.

Query parameters

None.

Body

The following coding example sets the command device:

```
{
  "parameters": {
    "isCommandDevice": true
  }
}
```

The following coding example sets the command device, security, user authentication, and device group information authentication:

```
{
  "parameters": {
    "isCommandDevice": true,
    "isSecurityEnabled": true,
    "isUserAuthenticationEnabled": true,
    "isDeviceGroupDefinitionEnabled": true
  }
}
```

Attribute	Type	Description
isCommandDevice	boolean	(Required) Specify whether to set the specified LDEV for the command device. <ul style="list-style-type: none"> ▪ <code>true</code>: Enables the settings for the command device. ▪ <code>false</code>: Disables the settings for the command device.
isSecurityEnabled	boolean	(Optional) Specify whether to enable the security settings for the command device. <ul style="list-style-type: none"> ▪ <code>true</code>: Enables the security settings. ▪ <code>false</code>: Disables the security settings. If this value is omitted, <code>false</code> is assumed. Specify this item to prevent the setting from being unexpectedly disabled.
isUserAuthenticationEnabled	boolean	(Optional) Specify whether to enable the user authentication setting for the command device. <ul style="list-style-type: none"> ▪ <code>true</code>: Enables the user authentication setting. ▪ <code>false</code>: Disables the user authentication setting. If this value is omitted, <code>false</code> is assumed. Specify this item to prevent the setting from being unexpectedly disabled.
isDeviceGroupDefinitionEnabled	boolean	(Optional) Specify whether to enable the settings for device group information authentication for the command device. <ul style="list-style-type: none"> ▪ <code>true</code>: Enables the settings for device group information authentication. ▪ <code>false</code>: Disables the settings for device group information authentication. If this value is omitted, <code>false</code> is assumed. Specify this item to prevent the setting from being unexpectedly disabled.

Response message

Body

A job object is returned. For details on attributes other than `affectedResources`, see the section explaining job objects.

Attribute	Description
affectedResources	URL of the volume for which the command device attribute has been changed

Action template

```
GET base-URL/v1/objects/ldevs/object-ID/actions/set-as-command-device
```

Status codes

The following table describes the meanings of the status codes of the request for this operation. For details on other status codes, see the description on HTTP status codes.

Status code	Message	Description
412	Precondition Failed	<p>The LDEV status is inappropriate. The LDEV might be in one of the following statuses:</p> <ul style="list-style-type: none"> ▪ The LDEV is used as a virtual volume of Thin Image. ▪ The LDEV is used as a Quorum disk. ▪ The LDEV is used as a system disk. ▪ The LDEV is used as a deduplication system data volume (fingerprint). ▪ The LDEV is used as a pool volume. ▪ The LDEV is used as a Volume Migration volume.

Coding example

To get an action template:

```
curl -v -H "Accept:application/json" -H "Content-Type:application/json" -H "Authorization:Session d7b673af189048468c5af9bcf3bbbb6f" -X GET https://192.0.2.100/ConfigurationManager/v1/objects/ldevs/1/actions/set-as-command-device
```

To run the request after getting an action template:

```
curl -v -H "Accept:application/json" -H "Content-Type:application/json" -H "Authorization:Session d7b673af189048468c5af9bcf3bbbb6f" -X POST --data-binary @./InputParameters.json https://192.0.2.100/ConfigurationManager/v1/objects/ldevs/1/actions/set-as-command-device/invoke
```

Getting a list of MP information

The request below obtains a list of MP location information.

Execution permission

Storage Administrator (View Only)

Request line

```
GET base-URL/v1/objects/mps
```

Request message

Object ID

None.

Query parameters

None.

Body

None.

Response message

Body

```
{
  "data": [
    {
      "mpId": 0,
      "mpLocationId": "MP10-00",
      "mpUnitId": "MPU-10",
      "ctl": "ctl1"
    },
    {
      "mpId": 1,
      "mpLocationId": "MP10-01",
      "mpUnitId": "MPU-10",
      "ctl": "ctl1"
    },
    {
      "mpId": 4,
      "mpLocationId": "MP20-00",
      "mpUnitId": "MPU-20",
      "ctl": "ctl2"
    }
  ],
}
```

```

    {
      "mpId": 5,
      "mpLocationId": "MP20-01",
      "mpUnitId": "MPU-20",
      "ctl": "ctl2"
    }
  ]
}

```

Attribute	Type	Description
mpId	int	MP ID
mpLocationId	string	MP location number
mpUnitId	string	MP unit ID
ctl	string	Controller <ul style="list-style-type: none"> ▪ ctl1: Controller 1 ▪ ctl2: Controller 2

Status codes

For details on the status codes of the request for this operation, see the description of HTTP status codes.

Coding example

```

curl -v -H "Accept:application/json" -H "Content-Type:application/json" -H
"Authorization:Session d7b673af189048468c5af9bcf3b6bbb6f" -X GET https://
192.0.2.100/ConfigurationManager/v1/objects/mps

```

Releasing the host reservation status by specifying the LU path

The following request releases the host reservation status of the LU mapped to a specified LU path. Use this API in situations when the host reservation status on the LU could not be released when there is a failure due to a problem on the host side.

Execution permission

Storage Administrator (System Resource Management)

Request line

```
POST base-URL/v1/objects/luns/object-ID/actions/release-lu-host-reserve/
invoke
```

Request message**Object ID**

Specify the `lunId` value from the LU path information. You can also specify a combination of attribute values in the following format:

```
portId, hostGroupNumber, lun
```

Attribute	Type	Description
portId	string	(Required) Port number
hostGroupNumber	int	(Required) Host group number (target ID for an iSCSI port)
lun	int	(Required) LUN

Query parameters

None.

Body

None.

Response message**Body**

A job object is returned. For details on attributes other than `affectedResources`, see the section explaining job objects.

Attribute	Description
affectedResources	URL of the path of the LU whose host reservation status is to be released

Action template

None.

Status codes

For details on the status codes of the request for this operation, see the section explaining HTTP status codes.

Coding example

```
curl -v -H "Content-type:application/json" -H "Accept:application/json" -H
"Authorization:Session d7b673af189048468c5af9bcf3b6bb6f" -X POST https://
192.0.2.100/ConfigurationManager/v1/objects/luns/CL1-A,1,0/actions/release-
lu-host-reserve/invoke -d ""
```

Releasing the host reservation status by specifying a host group

The following request releases the host reservation status for all LUs mapped to the specified host group or iSCSI target. Use this API in situations such as when the host reservation status on LUs could not be released because of some reason, such as a failure.

Execution permission

Storage Administrator (System Resource Management)

Request line

```
POST base-URL/v1/objects/host-groups/object-ID/actions/release-lu-host-
reserves/invoke
```

Request message**Object ID**

Specify the `hostGroupId` value obtained by the processing to obtain information about host groups or about iSCSI targets. You can also specify a combination of attribute values in the following format:

```
portId,hostGroupNumber
```

Attribute	Type	Description
portId	string	(Required) Port number
hostGroupNumber	int	(Required) Host group number for the port (For an iSCSI target, this is the target ID.)

Query parameters

None.

Body

None.

Response message

Body

A job object is returned. See the description for the job object. `affectedResources` is not displayed for this API. To check whether the host reservation status has been released, use the following URL. For *port-number* and *host-group-number*, specify the port number and the host group number (or the target ID) specified for the object ID.

```
GET base-URL/v1/objects/luns?portId=port-number&hostGroupNumber=host-group-number
```

Action template

None.

Status codes

For details on the status codes of the request for this operation, see the section explaining HTTP status codes.

Coding example

```
curl -v -H "Content-type:application/json" -H "Accept:application/json" -H "Authorization:Session d7b673af189048468c5af9bcf3b6bb6f" -X POST https://192.0.2.100/ConfigurationManager/v1/objects/host-groups/CL1-A,1/actions/release-lu-host-reserves/invoke -d ""
```

Chapter 6: Pool management

This chapter describes how to manage pools by using the REST API.

Overview of a pool

A pool is a virtual area created by integrating multiple LDEVs. You can create virtual volumes from a pool, and then allocate or pair the volumes.

You can create a virtual volume that has a capacity larger than that of the physical drive, and expand or reduce the size of a virtual volume as necessary. By doing so, you can effectively use the resources of a storage system and reduce the workload of adding and configuring drives. In addition, data is decentralized and stored on multiple drives by integrating multiple physical volumes, thereby improving drive operation efficiency.

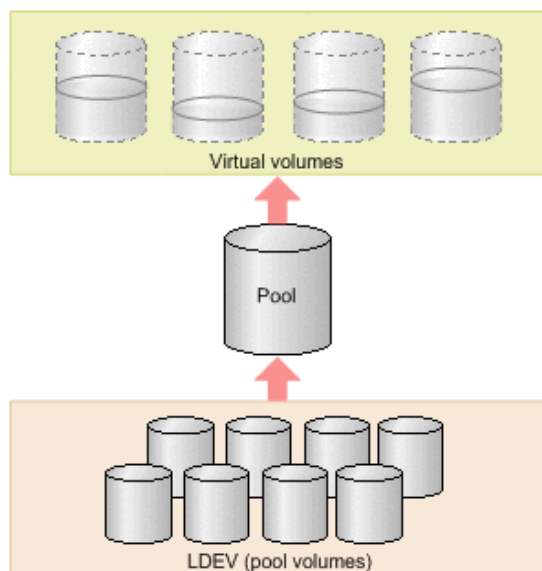

HDP pools, HDT pools, and Thin Image pools are created in the REST API. In this manual, HDP pools and HDT pools are referred to as DP pools when differentiation is unnecessary.

The following is a list of operations that can be performed for pools by using the REST API.

- **Create pools**
Create DP pools or Thin Image pools by specifying LDEVs. You can also set a threshold value for the pool usage rate to be used for issuing a warning when that value is exceeded. Use DP pools to create virtual volumes, and use Thin Image pools to store snapshot data. You can also store snapshot data in HDP pools.
- **Change pool settings**
Change the pool type from the HDP pool to the HDT pool, change the threshold usage rate of the DP pool or the Thin Image pool, or change the subscription of a virtual volume to DP pool capacity.
- **Expand pools**
Expand capacity by adding LDEVs to DP pools or Thin Image pools.
- **Shrink pools**
Reduce capacity by deleting the LDEVs that compose the DP pools or Thin Image pools.
- **Perform performance monitoring of HDT pools**
Start or stop monitoring of HDT pools at a specific timing so that HDT pool data is appropriately located.
- **Perform tier relocation for HDT pools**
Based on the performance monitoring information, relocate HDT pool data to an appropriate tier.
- **Restore pools**
Unblock DP pools or Thin Image pools that have recovered from a failure or other problem.
- **Delete pools**
Delete DP pools or Thin Image pools that are no longer necessary.
- **Get information about pools**
Get information about DP pools or Thin Image pools.

You create pools during the procedure to allocate volumes or create Thin Image pairs. Perform other operations on pools according to the status of the pools.

For details on HDP (Dynamic Provisioning) and HDT (Dynamic Tiering), see the *Provisioning Guide*.

Getting pool information

The following request gets information items such as the pool status, the pool usage rate, and the pool threshold.

Execution permission

Storage Administrator (View Only)

Request lineGET *base-URL/v1/objects/pools***Request message****Object ID**

None.

Query parameters

Query parameters can be specified to filter the execution results by the specified condition and also collect additional detailed information about pools.

- When filtering execution results

Parameter	Type	Filter Condition
poolType	string	(Optional) The type of pools about which information will be obtained. The specifiable types are as follows: <ul style="list-style-type: none"> ▪ DP: Information about DP pools is obtained. ▪ HTI: Information about Thin Image pools is obtained. If this parameter is omitted, information about all pools will be obtained.

- When collecting additional detailed information

Parameter	Type	Description
detailInfoType	string	(Optional) Type of detailed information to be obtained

Parameter	Type	Description
		<p>To specify multiple types, delimit the values by using commas.</p> <ul style="list-style-type: none"> ▪ <code>FMC</code> Detailed accelerated compression information of pools that consist of pool volumes belonging to the parity group of <code>SSD (FMC)</code> type drives is added. ▪ <code>tierPhysicalCapacity</code> Additional detailed information about the physical capacity of the HDT pools in each tier is obtained. The obtained information is added to the <code>tiers</code> attribute in the response body that is displayed. ▪ <code>efficiency</code> Additional detailed information is obtained about the saving efficiency for consumption of capacity (total efficiency) achieved by using the functions for increasing the usage efficiency of a pool (namely, the capacity saving function (dedupe and compression), the accelerated compression function, the creation of backup data by using snapshots, and the virtualization of capacity by using Dynamic Provisioning). ▪ <code>formattedCapacity</code> Additional detailed information is obtained about the size of the formatted capacity of the pool. <p>This parameter can be used in combination with the parameter to filter execution results.</p>

Body

None.

Response message**Body**

The following is an example of the output generated when getting HDP pool information:

```
{
  "data" : [ {
    "poolId" : 5,
```

```

"poolStatus" : "POLN",
"usedCapacityRate" : 1,
"usedPhysicalCapacityRate" : 1,
"snapshotCount" : 0,
"poolName" : "pool_5",
"availableVolumeCapacity" : 32042850,
"availablePhysicalVolumeCapacity" : 20006364,
"totalPoolCapacity" : 32066496,
"totalPhysicalCapacity" : 20009724,
"numOfLdevs" : 11,
"firstLdevId" : 2304,
"warningThreshold" : 70,
"depletionThreshold" : 80,
"virtualVolumeCapacityRate" : -1,
"isMainframe" : false,
"isShrinking" : false,
"locatedVolumeCount" : 13,
"totalLocatedCapacity" : 79951368,
"blockingMode" : "NB",
"totalReservedCapacity" : 0,
"reservedVolumeCount" : 0,
"poolType" : "HDP",
"duplicationLdevIds" : [ 65269, 65268, 65267, 65266, 65265,
65264, 65263, 65262 ],
"duplicationNumber" : 8,
"dataReductionAccelerateCompCapacity" : 206783585,
"dataReductionCapacity" : 205901472,
"dataReductionBeforeCapacity" : 210117216,
"dataReductionAccelerateCompRate" : 87,
"duplicationRate" : 42,
"compressionRate" : 44,
"dataReductionRate" : 97,
"dataReductionAccelerateCompIncludingSystemData" : {
  "isReductionCapacityAvailable" : true,
  "reductionCapacity" : 228372480,
  "isReductionRateAvailable" : true,
  "reductionRate" : 97
},
"dataReductionIncludingSystemData" : {
  "isReductionCapacityAvailable" : true,
  "reductionCapacity" : 186826752,
  "isReductionRateAvailable" : true,
  "reductionRate" : 79
},
"snapshotUsedCapacity" : 0,
"suspendSnapshot" : true,
"capacitiesExcludingSystemData" : {
  "usedVirtualVolumeCapacity" : 235253760,
  "compressedCapacity" : 0,

```

```

    "dedupedCapacity" : 101035296,
    "reclaimedCapacity" : 129142560,
    "systemDataCapacity" : 43351104,
    "preUsedCapacity" : 234393600,
    "preCompressedCapacity" : 0,
    "preDedupredCapacity" : 105247408
  }
} ]
}

```

For a DP pool:

Attribute	Type	Description
poolId	int	Object ID for the pool
poolName	string	Pool name
poolType	string	Pool type <ul style="list-style-type: none"> ▪ HDP: HDP pool ▪ HDT: HDT pool ▪ RT: active flash pool ▪ DM: Data Direct Mapping HDP pool
poolStatus	string	One of the following is output as the pool status: <ul style="list-style-type: none"> ▪ POLN: Normal (Pool Normal) ▪ POLF: The pool is in the overflow status exceeding the threshold. (Pool Full) ▪ POLS: The pool is in the overflow status exceeding the threshold and is suspended. (Pool Suspend) ▪ POLE: The pool is suspended in the failure status. (Pool failure) <p>If the pool status is POLE, pool information cannot be obtained.</p>
usedCapacityRate	int	Usage rate of logical capacity (%)
usedPhysicalCapacityRate	int	Usage rate of physical capacity (%)

Attribute	Type	Description
availableVolumeCapacity	long	Free logical capacity (MB)
availablePhysicalVolumeCapacity	long	Free physical capacity (MB) For this attribute, 1 MB is equal to 1,024 ² bytes.
totalPoolCapacity	long	Total logical capacity (MB)
totalPhysicalCapacity	long	Total physical capacity (MB) For this attribute, 1 MB is equal to 1,024 ² bytes.
numOfLdevs	int	Number of LDEVs in the pool
firstLdevId	int	The first LDEV number of the LDEVs in the pool
warningThreshold	int	The warning threshold set for the pool
depletionThreshold	int	The depletion threshold set for the pool
suspendSnapshot	boolean	Whether to suspend Thin Image pairs when the depletion threshold is exceeded <ul style="list-style-type: none"> ▪ <code>true</code>: Thin Image pairs are suspended when the depletion threshold is exceeded. ▪ <code>false</code>: Thin Image pairs are not suspended when the depletion threshold is exceeded.
virtualVolumeCapacityRate	int	-1 indicating the invalid value is output.
isShrinking	boolean	Whether the pool is shrinking is output. <ul style="list-style-type: none"> ▪ <code>true</code>: The pool is shrinking. ▪ <code>false</code>: The pool is not shrinking.
locatedVolumeCount	int	Total number of DP volumes mapped to the pool
totalLocatedCapacity	long	Total capacity of the DP volumes mapped to the pool (MB)

Attribute	Type	Description
		The value of this attribute does not include the control area.
snapshotCount	int	Total number of snapshot data items mapped to the pool
snapshotUsedCapacity	long	Total size of snapshot data mapped to the pool (MB)
blockingMode	string	<p>Setting the protection function for a virtual volume</p> <p>When the DP pool is full or when the DP pool volume is blocked, whether the read and write operations can be performed for the DP volume that uses the target DP pool is output.</p> <ul style="list-style-type: none"> ▪ PF: Pool Full If the DP pool is full, read and write operations are not possible. If the DP pool volume is blocked, read and write operations are possible. ▪ PB: Pool vol Blockade If the DP pool volume is blocked, read and write operations are not possible. If the DP pool is full, read and write operations are possible. ▪ FB: Full or Blockade If the DP pool is full or the DP pool volume is blocked, read and write operations are not possible. ▪ NB: No Blocking Even if the DP pool is full or the DP pool volume is blocked, read and write operations are possible for the target DP volume.

Attribute	Type	Description
totalReservedCapacity	long	<p>Total capacity of the reserved page (MB) of the DP volume that is related to the DP pool</p> <p>If the Full Allocation functionality is not supported by the configuration, this attribute is not output.</p>
reservedVolumeCount	int	<p>Number of volumes associated with the DP pool for which the page reservation setting is enabled</p> <p>If the Full Allocation functionality is not supported by the configuration, this attribute is not output.</p>
poolActionMode	string	<p>Execution mode for the pool</p> <ul style="list-style-type: none"> ▪ DEF: The mode in which the monitor is started or stopped by instructions from the REST API server, and the Tier range is specified by automatic calculation of the DKC. ▪ AUT: The mode in which the monitor is started or stopped at the specified time, and the Tier range is specified by automatic calculation of the DKC (specified by using Storage Navigator).
monitoringMode	string	<p>Performance monitoring execution mode (monitor mode)</p> <ul style="list-style-type: none"> ▪ PM: Period mode ▪ CM: Continuous mode

Attribute	Type	Description
tierOperationStatus	string	<p>Operation status of performance monitoring and tier relocation is output.</p> <ul style="list-style-type: none"> ▪ STP: Performance monitoring and tier relocation are both stopped. ▪ RLC: Performance monitoring is stopped and tier relocation is operating. ▪ MON: Performance monitoring is operating and tier relocation is stopped. ▪ RLM: Performance monitoring and tier relocation are both operating.
dat	string	<p>Status of monitor information</p> <ul style="list-style-type: none"> ▪ VAL: Valid ▪ INV: Invalid ▪ PND: Pending calculation
tiers	object[]	<p>The following attributes about HDT pool tiers are output for each tier.</p> <ul style="list-style-type: none"> ▪ tierNumber (int) Tier number ▪ tierLevelRange (string) Lower limit of the tier The value is output as the number of I/O operations per hour (IOPH). ▪ tierDeltaRange (string) Delta value for the tier The value is output as the number of I/O operations per hour (IOPH).

Attribute	Type	Description
		<ul style="list-style-type: none"> <li data-bbox="982 254 1417 590"> <p>▪ tierUsedPhysicalCapacity (long) Physical capacity used by the tier (MB) This information is displayed if <code>tierPhysicalCapacity</code> is specified for the <code>detailInfoType</code> query parameter when the request is executed.</p> <li data-bbox="982 611 1417 947"> <p>▪ tierTotalPhysicalCapacity (long) Total physical capacity of the tier (MB) This information is displayed if <code>tierPhysicalCapacity</code> is specified for the <code>detailInfoType</code> query parameter when the request is executed.</p> <li data-bbox="982 968 1417 1094"> <p>▪ tierUsedCapacity (long) Logical capacity used by the tier (MB)</p> <li data-bbox="982 1115 1417 1220"> <p>▪ tierTotalCapacity (long) Total logical capacity of the tier (MB)</p> <li data-bbox="982 1241 1417 1346"> <p>▪ tablespaceRate (int) Rate of free space to be used for new allocation</p> <li data-bbox="982 1367 1417 1451"> <p>▪ performanceRate (int) Performance utilization</p>

Attribute	Type	Description
		<ul style="list-style-type: none"> ▪ progressOfReplacing (int) Relocation progress rate The progress rate of the following tier relocation operation is output as a value from 0 to 99. <ul style="list-style-type: none"> • When the value of the <code>tierOperationStatus</code> attribute is <code>RLC</code> or <code>RLM</code>: Progress rate of relocation (being run). • When the value of the <code>tierOperationStatus</code> attribute is <code>STP</code> or <code>MON</code>: Progress rate of relocation (being suspended). <p>When tier relocation is not run or tier relocation is complete, 100 is output.</p> <ul style="list-style-type: none"> ▪ bufferSize (int) Buffer area rate for relocation
duplicationLdevIds	int[]	LDEV numbers of the deduplication system data volumes
duplicationNumber	int	Number of deduplication system data volumes
dataReductionAccelerateCompCapacity	long	<p>Size (in blocks) of data reduction through the capacity saving function (dedupe and compression) or the accelerated compression function</p> <p>The size of data after reduction does not include the size of metadata and garbage data generated by the storage system.</p>
dataReductionCapacity	long	Size (in blocks) of data reduction through the capacity saving function (compression and deduplication)

Attribute	Type	Description
		The size of data after reduction does not include the size of metadata and garbage data generated by the storage system.
dataReductionBeforeCapacity	long	Size (in blocks) of data before data reduction was performed by using the capacity saving function (compression and deduplication)
dataReductionAccelerateCompRate	int	<p>Percentage (%) of data on which data reduction has been performed by using the capacity saving function (compression and deduplication) or the accelerated compression function</p> <p>The size of data after reduction does not include the size of metadata and garbage data generated by the storage system.</p>
dataReductionRate	int	<p>Percentage (%) of data on which data reduction has been performed by using the capacity saving function (compression and deduplication)</p> <p>The size of data after reduction does not include the size of metadata and garbage data generated by the storage system.</p>
dataReductionAccelerateCompIncludingSystemData	object	The attributes related to the size of data reduced by using the capacity saving function (compression and deduplication) or the accelerated compression function are displayed.

Attribute	Type	Description
		<p>These attributes are calculated based on the size of the data (which includes, in addition to user data, metadata and garbage data generated by the storage system) after data reduction is performed.</p> <ul style="list-style-type: none"> ▪ <code>isReductionCapacityAvailable</code> (boolean) Whether the size of the data can be reduced <ul style="list-style-type: none"> • <code>true</code>: The size of the data can be reduced. If the value of this attribute is <code>true</code>, the size of the data that has been reduced is displayed for the <code>reductionCapacity</code> attribute. • <code>false</code>: The size of the data cannot be reduced (for example, if the size of the data after data reduction is greater than the size of the data before data reduction). ▪ <code>reductionCapacity</code> (long) Size (in blocks) of the data that was reduced This attribute is displayed when the value of the <code>isReductionCapacityAvailable</code> attribute is <code>true</code>.

Attribute	Type	Description
		<ul style="list-style-type: none"> <li data-bbox="982 254 1417 953"> <p>▪ <code>isReductionRateAvailable</code> (boolean)</p> <p>Whether the size of the data can be reduced</p> <ul style="list-style-type: none"> <li data-bbox="1023 422 1385 485">• <code>true</code>: The size of the data can be reduced. <p>If the value of this attribute is <code>true</code>, the percentage by which the size of the data has been reduced is displayed for the <code>reductionRate</code> attribute.</p> <ul style="list-style-type: none"> <li data-bbox="1023 747 1401 947">• <code>false</code>: The size of the data cannot be reduced (for example, if the size of the data after data reduction is greater than the size of the data before data reduction). <li data-bbox="982 1003 1417 1304"> <p>▪ <code>reductionRate</code> (int)</p> <p>Percentage (%) by which the size of the data has been reduced</p> <p>This attribute is displayed when the value of the <code>isReductionRateAvailable</code> attribute is <code>true</code>.</p>
<code>dataReductionIncludingSystemData</code>	object	The attributes related to the size of data reduced by using the capacity saving function (compression and deduplication) are displayed.

Attribute	Type	Description
		<p>These attributes are calculated based on the size of the data (which includes, in addition to user data, metadata and garbage data generated by the storage system) after data reduction is performed.</p> <ul style="list-style-type: none"> ▪ <code>isReductionCapacityAvailable</code> (boolean) <p>Whether the size of the data can be reduced</p> <ul style="list-style-type: none"> • <code>true</code>: The size of the data can be reduced. <p>If the value of this attribute is <code>true</code>, the size of the data that has been reduced is displayed for the <code>reductionCapacity</code> attribute.</p> <ul style="list-style-type: none"> • <code>false</code>: The size of the data cannot be reduced (for example, if the size of the data after data reduction is greater than the size of the data before data reduction). ▪ <code>reductionCapacity</code> (long) <p>Size (in blocks) of the data that was reduced</p> <p>This attribute is displayed when the value of the <code>isReductionCapacityAvailable</code> attribute is <code>true</code>.</p>

Attribute	Type	Description
		<ul style="list-style-type: none"> <li data-bbox="982 254 1417 951"> <p>▪ <code>isReductionRateAvailable</code> (boolean)</p> <p>Whether the size of the data can be reduced</p> <ul style="list-style-type: none"> <li data-bbox="1023 422 1385 485">• <code>true</code>: The size of the data can be reduced. <p>If the value of this attribute is <code>true</code>, the percentage by which the size of the data has been reduced is displayed for the <code>reductionRate</code> attribute.</p> <ul style="list-style-type: none"> <li data-bbox="1023 747 1401 951">• <code>false</code>: The size of the data cannot be reduced (for example, if the size of the data after data reduction is greater than the size of the data before data reduction). <li data-bbox="982 1003 1417 1304"> <p>▪ <code>reductionRate</code> (int)</p> <p>Percentage (%) by which the size of the data has been reduced</p> <p>This attribute is displayed when the value of the <code>isReductionRateAvailable</code> attribute is <code>true</code>.</p>

Attribute	Type	Description
capacitiesExcludingSystemData	object	<p>Attributes related to the capacity saving achieved by using the capacity saving function (dedupe and compression) are displayed.</p> <ul style="list-style-type: none"> <li data-bbox="982 415 1424 716"> <p>▪ usedVirtualVolumeCapacity (long)</p> <p>The capacity (in blocks) used by virtual volumes</p> <p>This does not include the capacity used by the system data volume for the dedupe function.</p> <li data-bbox="982 751 1424 1024"> <p>▪ compressedCapacity (long)</p> <p>The size (in blocks) of data reduced by using compression</p> <p>This does not include the size of metadata and garbage data generated by the storage system.</p> <li data-bbox="982 1060 1424 1360"> <p>▪ dedupedCapacity (long)</p> <p>The size (in blocks) of data reduced by using deduplication (dedupe)</p> <p>This does not include the size of metadata and garbage data generated by the storage system.</p> <li data-bbox="982 1396 1424 1696"> <p>▪ reclaimedCapacity (long)</p> <p>The size (in blocks) of data reduced by reclaiming the specified data pattern</p> <p>This does not include the size of metadata and garbage data generated by the storage system.</p>

Attribute	Type	Description
		<ul style="list-style-type: none"> <li data-bbox="982 254 1421 527">▪ <code>systemDataCapacity</code> (long) The size (in blocks) of system data reduced This includes the size of metadata and garbage data generated by the storage system. <li data-bbox="982 558 1421 705">▪ <code>preUsedCapacity</code> (long) The size (in blocks) of the data before data reduction was performed <li data-bbox="982 737 1421 884">▪ <code>preCompressedCapacity</code> (long) The size (in blocks) of the data before compression was performed <li data-bbox="982 915 1421 1041">▪ <code>preDedupredCapacity</code> (long) The size (in blocks) of the data before dedupe was performed
compressionRate	int	Percentage (%) of data on which data reduction has been performed by using the compression function or the accelerated compression function
duplicationRate	int	Percentage (%) of data on which data reduction has been performed by using the deduplication function
isMainframe	boolean	Displays a pool for the mainframe or the open system <ul style="list-style-type: none"> <li data-bbox="982 1528 1421 1598">▪ <code>true</code>: Pool for the mainframe volume <li data-bbox="982 1612 1421 1682">▪ <code>false</code>: Pool for the open volume

The following is an example of the output generated when getting Thin Image pool information:

```
{
  "data": [ {
    "poolId" : 35,
    "poolStatus" : "POLN",
    "usedCapacityRate" : 1,
    "usedPhysicalCapacityRate" : 1,
    "snapshotCount" : 2,
    "poolName" : "pool_35",
    "availableVolumeCapacity" : 46704,
    "availablePhysicalVolumeCapacity" : 46704,
    "totalPoolCapacity" : 46998,
    "totalPhysicalCapacity" : 46998,
    "numOfLdevs" : 1,
    "firstLdevId" : 18952,
    "warningThreshold" : 80,
    "virtualVolumeCapacityRate" : -1,
    "isMainframe" : false,
    "isShrinking" : false,
    "poolType" : "HTI",
    "capacitiesExcludingSystemData" : {
      "usedVirtualVolumeCapacity" : 602112
    }
  } ]
}
```

For a Thin Image pool:

Attribute	Type	Description
poolId	int	Object ID for the pool
poolName	string	Pool name
poolType	string	Pool type is output. HTI: Thin Image pool
poolStatus	string	One of the following is output as the pool status: <ul style="list-style-type: none"> ▪ POLN: Normal (Pool Normal) ▪ POLF: The pool is in the overflow status exceeding the threshold. (Pool Full)

Attribute	Type	Description
		<ul style="list-style-type: none"> ▪ <code>POLS</code>: The pool is in the overflow status exceeding the threshold and is suspended. (Pool Suspend) ▪ <code>POLE</code>: The pool is suspended in the failure status. (Pool failure) <p>If the pool status is <code>POLE</code>, pool information cannot be obtained.</p>
<code>usedCapacityRate</code>	int	Usage rate of logical capacity (%)
<code>usedPhysicalCapacityRate</code>	int	Usage rate of physical capacity (%)
<code>snapshotCount</code>	int	Number of volumes in the pool
<code>availableVolumeCapacity</code>	long	Free logical capacity (MB)
<code>availablePhysicalVolumeCapacity</code>	long	Free physical capacity (MB) For this attribute, 1 MB is equal to 1,024 ² bytes.
<code>totalPoolCapacity</code>	long	Total logical capacity (MB)
<code>totalPhysicalCapacity</code>	long	Total physical capacity (MB) For this attribute, 1 MB is equal to 1,024 ² bytes.
<code>numOfLdevs</code>	int	Number of LDEVs in the pool
<code>firstLdevId</code>	int	The first LDEV number of the LDEVs in the pool (Not the first number in ascending order)
<code>warningThreshold</code>	int	The warning threshold set for the pool
<code>virtualVolumeCapacityRate</code>	int	-1 indicating the invalid value is output.
<code>isShrinking</code>	boolean	Whether the pool is shrinking is output. <ul style="list-style-type: none"> ▪ <code>true</code>: The pool is shrinking. ▪ <code>false</code>: The pool is not shrinking.
<code>isMainframe</code>	boolean	Displays a pool for the mainframe or the open system <ul style="list-style-type: none"> ▪ <code>true</code>: Pool for the mainframe volume ▪ <code>false</code>: Pool for the open volume

Attribute	Type	Description
capacitiesExcludingSystemData	object	<p>Attributes related to the saving efficiency for consumption of capacity are displayed.</p> <ul style="list-style-type: none"> usedVirtualVolumeCapacity (long) The capacity (in blocks) used by virtual volumes This does not include the capacity used by the system data volume used for the dedupe function.

The following example shows the output when the detailed information for accelerated compression is obtained:

```
{
  "data" : [ {
    "poolId" : 40,
    "poolStatus" : "POLN",
    "usedCapacityRate" : 0,
    "usedPhysicalCapacityRate" : 0,
    "snapshotCount" : 0,
    "poolName" : "pool_40",
    "availableVolumeCapacity" : 46998,
    "availablePhysicalVolumeCapacity" : 46998,
    "usedPhysicalCapacity" : 0,
    "totalPoolCapacity" : 46998,
    "totalPhysicalCapacity" : 46998,
    "numOfLdevs" : 1,
    "firstLdevId" : 4095,
    "warningThreshold" : 70,
    "depletionThreshold" : 80,
    "virtualVolumeCapacityRate" : -1,
    "isMainframe" : false,
    "isShrinking" : false,
    "locatedVolumeCount" : 6,
    "totalLocatedCapacity" : 21672,
    "blockingMode" : "NB",
    "totalReservedCapacity" : 0,
    "reservedVolumeCount" : 0,
    "poolType" : "HDP",
    "duplicationNumber" : 0,
    "dataReductionAccelerateCompCapacity" : 0,
    "dataReductionCapacity" : 0,
    "dataReductionBeforeCapacity" : 0,
  } ]
}
```

```

"dataReductionAccelerateCompRate" : 0,
"duplicationRate" : 0,
"compressionRate" : 0,
"dataReductionRate" : 0,
"dataReductionAccelerateCompIncludingSystemData" : {
  "isReductionCapacityAvailable" : true,
  "reductionCapacity" : 0,
  "isReductionRateAvailable" : false
},
"dataReductionIncludingSystemData" : {
  "isReductionCapacityAvailable" : true,
  "reductionCapacity" : 0,
  "isReductionRateAvailable" : false
},
"snapshotUsedCapacity" : 0,
"suspendSnapshot" : true,
"availablePhysicalFMCPoolVolumesCapacity" : 46998,
"usedPhysicalFMCPoolVolumesCapacity" : 4590,
"availableFMCPoolVolumesCapacity" : 46998,
"usedFMCPoolVolumesCapacity" : 46998,
"fmcPoolVolumesCapacitySaving" : 42407,
"fmcPoolVolumesCapacitySavingRate" : 90,
"fmcPoolVolumesCapacityExpansionRate" : 100,
"usedFMCLogicalPoolVolumesCapacity" : 0,
"capacitiesExcludingSystemData" : {
  "usedVirtualVolumeCapacity" : 0,
  "compressedCapacity" : 0,
  "dedupedCapacity" : 0,
  "reclaimedCapacity" : 0,
  "systemDataCapacity" : 0,
  "preUsedCapacity" : 0,
  "preCompressedCapacity" : 0,
  "preDedupredCapacity" : 0
}
} ]
}

```

When the detailed information for accelerated compression is obtained:

When the drive type of the pool volumes that make up the pool is `SSD (FMC)`, if you specify `SSD (FMC)` for the `detailInfoType` query parameter and then run the request, the following additional information is obtained.

Attribute	Type	Description
usedPhysicalCapacity	long	Total physical capacity usage (MB)

Attribute	Type	Description
		When the pool contains pool volumes for which the accelerated compression function is enabled, the compressed data is included in the total usage.
availablePhysicalFMCPoolVolumesCapacity	long	Total physical capacity of pool volumes for which the accelerated compression function is enabled (MB) The total capacity of pool volumes for which the accelerated compression function is enabled and writing is reserved is output.
usedPhysicalFMCPoolVolumesCapacity	long	Physical capacity usage by pool volumes for which the accelerated compression function is enabled (MB) The used capacity by pool volumes for which the accelerated compression function is enabled after they are compressed is output.
usedFMCLogicalPoolVolumesCapacity	long	Logical capacity usage of pool volumes for which the accelerated compression function is enabled (MB) The used capacity by pool volumes for which the accelerated compression function is enabled after they are compressed is output.
availableFMCPoolVolumesCapacity	long	Total capacity of pool volumes for which the accelerated compression function is enabled (MB) From among the volumes that make up the pool, the total capacity of pool volumes for which the accelerated compression function is enabled is output.

Attribute	Type	Description
usedFMCPoolVolumesCapacity	long	<p>Capacity usage of pool volumes for which the accelerated compression function is enabled (MB)</p> <p>From among the volumes that make up the pool, the usage of the pool volumes for which the accelerated compression function is enabled is output.</p>
fmcPoolVolumesCapacitySaving	long	<p>Data reduction in capacity of pool volume for which the accelerated compression function is enabled (MB)</p> <p>From among volumes that make up the pool, the reduction in the capacity of pool volumes for which the accelerated compression function is enabled, obtained by data compression is output.</p>
fmcPoolVolumesCapacitySavingRate	int	<p>Reduction rate of capacity of pool volumes for which the accelerated compression function is enabled (%)</p> <p>With regard to the pool volumes for which the accelerated compression function is enabled from among the volumes that make up the pool, the percentage (%) that <code>fmcPoolVolumesCapacitySaving</code> occupies of <code>usedFMCPoolVolumesCapacity</code> is output.</p>
fmcPoolVolumesCapacityExpansionRate	int	<p>Capacity expansion rate of pool volumes for which the accelerated compression function is enabled (%)</p>

Attribute	Type	Description
		The percentage (%) that <code>availableFMCPoolVolumesCapacity</code> occupies of <code>availablePhysicalFMCPoolVolumesCapacity</code> is output.

The following example shows the output when detailed information is obtained about the total efficiency.

```
{
  "data" : [ {
    "poolId" : 32,
    "poolStatus" : "POLN",
    "usedCapacityRate" : 49,
    "usedPhysicalCapacityRate" : 49,
    "snapshotCount" : 0,
    "poolName" : "pool_32",
    "availableVolumeCapacity" : 8190,
    "availablePhysicalVolumeCapacity" : 8190,
    "totalPoolCapacity" : 16254,
    "totalPhysicalCapacity" : 16254,
    "numOfLdevs" : 1,
    "firstLdevId" : 2229,
    "warningThreshold" : 70,
    "depletionThreshold" : 80,
    "virtualVolumeCapacityRate" : -1,
    "isMainframe" : false,
    "isShrinking" : false,
    "locatedVolumeCount" : 11,
    "totalLocatedCapacity" : 67173456,
    "blockingMode" : "NB",
    "totalReservedCapacity" : 0,
    "reservedVolumeCount" : 0,
    "poolType" : "HDP",
    "duplicationLdevIds" : [ 49098, 49097, 49096, 49095, 49094,
49093, 49092, 49091 ],
    "duplicationNumber" : 8,
    "dataReductionAccelerateCompCapacity" : 17174250,
    "dataReductionCapacity" : 17174250,
    "dataReductionBeforeCapacity" : 17175552,
    "dataReductionAccelerateCompRate" : 89,
    "duplicationRate" : 5,
    "compressionRate" : 84,
    "dataReductionRate" : 99,
    "dataReductionAccelerateCompIncludingSystemData" : {
      "isReductionCapacityAvailable" : true,
      "reductionCapacity" : 2580480,
      "isReductionRateAvailable" : true,
      "reductionRate" : 13
    },
    "dataReductionIncludingSystemData" : {
      "isReductionCapacityAvailable" : true,
      "reductionCapacity" : 2580480,
      "isReductionRateAvailable" : true,
      "reductionRate" : 14
    }
  } ]
}
```

```

},
"snapshotUsedCapacity" : 0,
"suspendSnapshot" : true,
"efficiency" : {
  "isCalculated" : true,
  "totalRatio" : "112.52",
  "compressionRatio" : "17.07",
  "snapshotRatio" : "-",
  "provisioningRate" : "84",
  "calculationStartTime" : "2016-07-31T20:32:47Z",
  "calculationEndTime" : "2016-07-31T20:41:09Z",
  "dedupeAndCompression" : {
    "totalRatio" : "18.47",
    "compressionRatio" : "8.61",
    "dedupeRatio" : "2.03",
    "reclaimRatio" : "1.05"
  },
  "acceleratedCompression" : {
    "totalRatio" : "1.00",
    "compressionRatio" : "1.00",
    "reclaimRatio" : "1.00"
  }
},
"capacitiesExcludingSystemData" : {
  "usedVirtualVolumeCapacity" : 19095552,
  "compressedCapacity" : 15975441,
  "dedupedCapacity" : 1064681,
  "reclaimedCapacity" : 1021936,
  "systemDataCapacity" : 15481578,
  "preUsedCapacity" : 18063360,
  "preCompressedCapacity" : 17041424,
  "preDedupredCapacity" : 1064982
}
} ]
}

```

When detailed information is obtained about the total efficiency

If you run the request with `efficiency` specified for the query parameter `detailInfoType`, the following information is obtained.

Attribute	Type	Description
efficiency	object	Attributes related to the total efficiency are displayed. Calculated results for the period from <code>calculationStartTime</code> to <code>calculationEndTime</code> are obtained.

Attribute	Type	Description
		<p>Only When <code>true</code> is specified for the attribute <code>isCalculated</code>, other subordinate attributes are also obtained. If the pool volume for which the calculation is to be performed does not exist, a hyphen (-) indicating an invalid value is displayed for these attributes. If the calculation cannot be performed for the pool because the pool is blocked or some other reason, the value from the previous calculation is displayed.</p> <p>For the attributes that display the total efficiency or the efficiency of capacity saving, these results are displayed as a ratio of the size of data before reduction to the size of data after reduction, where the size of data after reduction is 1.</p> <ul style="list-style-type: none"> ▪ <code>isCalculated</code> (boolean) <ul style="list-style-type: none"> Calculation status of the total efficiency This attribute indicates whether the total efficiency has been calculated. <ul style="list-style-type: none"> • <code>true</code>: The values have been calculated. • <code>false</code>: The values have not been calculated. ▪ <code>calculationStartTime</code> (ISO8601string) <ul style="list-style-type: none"> The date and time when the calculation of the total efficiency began (UTC) Displayed in the following format: YYYY-MM-DDThh:mm:ssZ ▪ <code>calculationEndTime</code> (ISO8601string) <ul style="list-style-type: none"> The date and time when the calculation of the total efficiency ended (UTC) Displayed in the following format: YYYY-MM-DDThh:mm:ssZ ▪ <code>totalRatio</code> (string) <ul style="list-style-type: none"> The total efficiency of the entire pool This does not include the size of metadata, garbage data, and other similar data generated by the storage system. After a volume is created from pool and before data is written to the volume, the maximum value (92233720368547758.07) is displayed.

Attribute	Type	Description
		<ul style="list-style-type: none"> <li data-bbox="613 289 1414 541"> <p>▪ compressionRatio (string)</p> <p>The efficiency of capacity saving performed by using the capacity saving function (dedupe and compression) or accelerated compression</p> <p>This does not include the size of metadata, garbage data, and other similar data generated by the storage system.</p> <li data-bbox="613 562 1414 762"> <p>▪ snapshotRatio (string)</p> <p>The efficiency of capacity saving performed by using snapshots to back up data</p> <p>This does not include the size of metadata, garbage data, and other similar data generated by the storage system.</p> <li data-bbox="613 793 1414 1035"> <p>▪ provisioningRate (string)</p> <p>The percentage (%) of the saving efficiency for consumption of capacity achieved by using Dynamic Provisioning to virtualize capacity</p> <p>This does not include the size of metadata, garbage data, and other similar data generated by the storage system.</p>

Attribute	Type	Description
		<ul style="list-style-type: none"> ▪ dedupeAndCompression (object) <p>Attributes related to the efficiency of capacity saving performed by using the capacity saving function (dedupe and compression) are displayed.</p> <p>This does not include the size of metadata, garbage data, and other similar data generated by the storage system.</p> <ul style="list-style-type: none"> • totalRatio (string) <p>total efficiency of capacity saving performed by using the capacity saving function</p> • compressionRatio (string) <p>Efficiency of capacity saving performed by using compression</p> • dedupeRatio (string) <p>Efficiency of capacity saving performed by using deduplication (dedupe)</p> • reclaimRatio (string) <p>Efficiency of capacity saving performed by reclaiming the specified data pattern</p>

Attribute	Type	Description
		<ul style="list-style-type: none"> ▪ acceleratedCompression (object) Attributes related to the efficiency of capacity saving performed by using accelerated compression are displayed. This does not include the size of metadata, garbage data, and other similar data generated by the storage system. • totalRatio (string) total efficiency of capacity saving performed by using accelerated compression • compressionRatio (string) Efficiency of capacity saving performed by using compression • reclaimRatio (string) Efficiency of capacity saving performed by reclaiming the specified data pattern

When detailed information is obtained about the formatted capacity of the pool
If you run the request with `formattedCapacity` specified for the query parameter `detailInfoType`, the following information is obtained.

Attribute	Type	Description
<code>formattedCapacity</code>	long	The formatted capacity of the pool (MB) is displayed. If the information cannot be obtained, -1 is displayed, indicating an invalid value.

Status codes

For details on the status codes of the request for this operation, see the description on HTTP status codes.

Coding example

When getting information about all pools:

```
curl -v -H "Accept:application/json" -H "Content-Type:application/json" -H
"Authorization:Session d7b673af189048468c5af9bcf3b6bb6f" -X GET https://
192.0.2.100/ConfigurationManager/v1/objects/pools
```

When getting information about DP pools:

```
curl -v -H "Accept:application/json" -H "Content-Type:application/json" -H
"Authorization:Session d7b673af189048468c5af9bcf3b6bb6f" -X GET https://
192.0.2.100/ConfigurationManager/v1/objects/pools?poolType=DP
```

Getting information about a specific pool

The following request gets information about a specific pool by specifying the pool number.

Execution permission

Storage Administrator (View Only)

Request line

```
GET base-URL/v1/objects/pools/object-ID
```

Request message**Object ID**

Specify the `poolId` value obtained by getting information about the pools.

Attribute	Type	Description
poolId	int	(Required) Pool number

Query parameters

None.

Body

None.

Response message**Body**

The following is an example of the output generated when getting HDP pool information:

```
{
  "poolId": 0,
  "poolStatus": "POLN",
  "usedCapacityRate": 14,
  "usedPhysicalCapacityRate": 14,
  "snapshotCount": 0,
  "poolName": "testpool",
  "availableVolumeCapacity": 40320,
  "availablePhysicalVolumeCapacity": 40320,
  "totalPoolCapacity": 46998,
  "totalPhysicalCapacity": 46998,
  "numOfLdevs": 1,
  "firstLdevId": 1,
  "warningThreshold": 70,
  "depletionThreshold": 80,
  "virtualVolumeCapacityRate": -1,
  "isMainframe": false,
  "isShrinking": false,
  "locatedVolumeCount": 9,
  "totalLocatedCapacity": 67132128,
  "blockingMode": "NB",
  "totalReservedCapacity": 0,
  "reservedVolumeCount": 0,
  "poolType": "HDP",
  "duplicationLdevIds": [
    49151,
    49150,
    49149,
    49148,
    49147,
    49146,
    49145,
    49144
  ],
  "duplicationNumber": 8,
  "dataReductionAccelerateCompCapacity": 13072996,
  "dataReductionCapacity": 13072996,
  "dataReductionBeforeCapacity": 13074560,
  "dataReductionAccelerateCompRate": 92,
  "duplicationRate": 5,
  "compressionRate": 86,
  "dataReductionRate": 99,
  "dataReductionAccelerateCompIncludingSystemData": {
    "isReductionCapacityAvailable": true,

```

```

    "reductionCapacity": 430080,
    "isReductionRateAvailable": true,
    "reductionRate": 3
  },
  "dataReductionIncludingSystemData": {
    "isReductionCapacityAvailable": true,
    "reductionCapacity": 430080,
    "isReductionRateAvailable": true,
    "reductionRate": 3
  },
  "snapshotUsedCapacity": 0,
  "suspendSnapshot": true
}

```

For a DP pool:

Attribute	Type	Description
poolId	int	Pool number
poolName	string	Pool name
poolType	string	Pool type <ul style="list-style-type: none"> ▪ HDP: HDP pool ▪ HDT: HDT pool ▪ RT: active flash pool ▪ DM: Data Direct Mapping HDP pool
poolStatus	string	One of the following is output as the pool status: <ul style="list-style-type: none"> ▪ POLN: Normal (Pool Normal) ▪ POLF: The pool is in the overflow status exceeding the threshold. (Pool Full) ▪ POLS: The pool is in the overflow status exceeding the threshold and is suspended. (Pool Suspend) ▪ POLE: The pool is suspended in the failure status. (Pool failure) <p>If the pool status is POLE, pool information cannot be obtained.</p>

Attribute	Type	Description
usedCapacityRate	int	Usage rate of logical capacity (%)
usedPhysicalCapacityRate	int	Usage rate of physical capacity (%)
availableVolumeCapacity	long	Free logical capacity (MB)
availablePhysicalVolumeCapacity	long	Free physical capacity (MB) For this attribute, 1 MB is equal to 1,024 ² bytes.
totalPoolCapacity	long	Total logical capacity (MB)
totalPhysicalCapacity	long	Total physical capacity (MB) For this attribute, 1 MB is equal to 1,024 ² bytes.
numOfLdevs	int	Number of LDEVs in the pool
firstLdevId	int	The first LDEV number of the LDEVs in the pool
warningThreshold	int	The warning threshold set for the pool
depletionThreshold	int	The depletion threshold set for the pool
suspendSnapshot	boolean	Whether to suspend Thin Image pairs when the depletion threshold is exceeded <ul style="list-style-type: none"> ▪ <code>true</code>: Thin Image pairs are suspended when the depletion threshold is exceeded. ▪ <code>false</code>: Thin Image pairs are not suspended when the depletion threshold is exceeded.
virtualVolumeCapacityRate	int	-1 indicating the invalid value is output.
isShrinking	boolean	Whether the pool is shrinking is output. <ul style="list-style-type: none"> ▪ <code>true</code>: The pool is shrinking. ▪ <code>false</code>: The pool is not shrinking.

Attribute	Type	Description
locatedVolumeCount	int	Total number of DP volumes mapped to the pool
totalLocatedCapacity	long	Total capacity of the DP volumes mapped to the pool (MB) The value of this attribute does not include the control area.
snapshotCount	int	Total number of snapshot data items mapped to the pool
snapshotUsedCapacity	long	Total size of snapshot data mapped to the pool (MB)
blockingMode	string	<p>Setting the protection function for a virtual volume</p> <p>When the DP pool is full or when the DP pool volume is blocked, whether the read and write operations can be performed for the DP volume that uses the target DP pool is output.</p> <ul style="list-style-type: none"> ▪ PF: Pool Full If the DP pool is full, read and write operations are not possible. If the DP pool volume is blocked, read and write operations are possible. ▪ PB: Pool vol Blockade If the DP pool volume is blocked, read and write operations are not possible. If the DP pool is full, read and write operations are possible.

Attribute	Type	Description
		<ul style="list-style-type: none"> <li data-bbox="992 254 1416 443">▪ FB: Full or Blockade If the DP pool is full or the DP pool volume is blocked, read and write operations are not possible. <li data-bbox="992 457 1416 682">▪ NB: No Blocking Even if the DP pool is full or the DP pool volume is blocked, read and write operations are possible for the target DP volume.
totalReservedCapacity	long	<p data-bbox="992 701 1416 804">Total capacity of the reserved page (MB) of the DP volume that is related to the DP pool</p> <p data-bbox="992 821 1416 957">If the Full Allocation functionality is not supported by the configuration, this attribute is not output.</p>
reservedVolumeCount	int	<p data-bbox="992 984 1416 1121">Number of volumes associated with the DP pool for which the page reservation setting is enabled</p> <p data-bbox="992 1138 1416 1274">If the Full Allocation functionality is not supported by the configuration, this attribute is not output.</p>
poolActionMode	string	<p data-bbox="992 1299 1416 1331">Execution mode for the pool</p> <ul style="list-style-type: none"> <li data-bbox="992 1348 1416 1556">▪ DEF: The mode in which the monitor is started or stopped by instructions from the REST API server, and the Tier range is specified by automatic calculation of the DKC. <li data-bbox="992 1572 1416 1814">▪ AUT: The mode in which the monitor is started or stopped at the specified time, and the Tier range is specified by automatic calculation of the DKC (specified by using Storage Navigator).

Attribute	Type	Description
monitoringMode	string	Performance monitoring execution mode (monitor mode) <ul style="list-style-type: none"> ▪ PM: Period mode ▪ CM: Continuous mode
tierOperationStatus	string	Operation status of performance monitoring and tier relocation is output. <ul style="list-style-type: none"> ▪ STP: Performance monitoring and tier relocation are both stopped. ▪ RLC: Performance monitoring is stopped and tier relocation is operating. ▪ MON: Performance monitoring is operating and tier relocation is stopped. ▪ RLM: Performance monitoring and tier relocation are both operating.
dat	string	Status of monitor information <ul style="list-style-type: none"> ▪ VAL: Valid ▪ INV: Invalid ▪ PND: Pending calculation
tiers	object[]	The following attributes about HDT pool tiers are output for each tier. <ul style="list-style-type: none"> ▪ tierNumber (int) Tier number ▪ tierLevelRange (string) Lower limit of the tier The value is output as the number of I/O operations per hour (IOPH).

Attribute	Type	Description
		<ul style="list-style-type: none"> ▪ tierDeltaRange (string) Delta value for the tier The value is output as the number of I/O operations per hour (IOPH). ▪ tierUsedCapacity (long) Amount used by the tier (MB) ▪ tierTotalCapacity (long) Total capacity of the tier (MB) ▪ tablespaceRate (int) Rate of free space to be used for new allocation ▪ performanceRate (int) Performance utilization ▪ progressOfReplacing (int) Relocation progress rate The progress rate of the following tier relocation operation is output as a value from 0 to 99. <ul style="list-style-type: none"> • When the value of the <code>tierOperationStatus</code> attribute is <code>RLC</code> or <code>RLM</code>: Progress rate of relocation (being run). • When the value of the <code>tierOperationStatus</code> attribute is <code>STP</code> or <code>MON</code>: Progress rate of relocation (being suspended). When tier relocation is not run or tier relocation is complete, 100 is output. ▪ bufferRate (int) Buffer area rate for relocation

Attribute	Type	Description
duplicationLdevIds	int[]	LDEV numbers of the deduplication system data volumes
duplicationNumber	int	Number of deduplication system data volumes
dataReductionAccelerateCompCapacity	long	<p>Size (in blocks) of data reduction through the capacity saving function (dedupe and compression) or the accelerated compression function</p> <p>The size of data after reduction does not include the size of metadata and garbage data generated by the storage system.</p>
dataReductionCapacity	long	<p>Size (in blocks) of data reduction through the capacity saving function (compression and deduplication)</p> <p>The size of data after reduction does not include the size of metadata and garbage data generated by the storage system.</p>
dataReductionBeforeCapacity	long	Size (in blocks) of data before data reduction was performed by using the capacity saving function (compression and deduplication)
dataReductionAccelerateCompRate	int	<p>Percentage (%) of data on which data reduction has been performed by using the capacity saving function (compression and deduplication) or the accelerated compression function</p> <p>The size of data after reduction does not include the size of metadata and garbage data generated by the storage system.</p>
dataReductionRate	int	Percentage (%) of data on which data reduction has been performed by using the capacity saving function (compression and deduplication)

Attribute	Type	Description
		The size of data after reduction does not include the size of metadata and garbage data generated by the storage system.
dataReductionAccelerateComplncludingSystemData	object	The attributes related to the size of data reduced by using the capacity saving function (compression and deduplication) or the accelerated compression function are displayed.

Attribute	Type	Description
		<p>These attributes are calculated based on the size of the data (which includes, in addition to user data, metadata and garbage data generated by the storage system) after data reduction is performed.</p> <ul style="list-style-type: none"> ▪ <code>isReductionCapacityAvailable</code> (boolean) <p>Whether the size of the data can be reduced</p> <ul style="list-style-type: none"> • <code>true</code>: The size of the data can be reduced. <p>If the value of this attribute is <code>true</code>, the size of the data that has been reduced is displayed for the <code>reductionCapacity</code> attribute.</p> • <code>false</code>: The size of the data cannot be reduced (for example, if the size of the data after data reduction is greater than the size of the data before data reduction). ▪ <code>reductionCapacity</code> (long) <p>Size (in blocks) of the data that was reduced</p> <p>This attribute is displayed when the value of the <code>isReductionCapacityAvailable</code> attribute is <code>true</code>.</p>

Attribute	Type	Description
		<ul style="list-style-type: none"> <li data-bbox="992 254 1416 953"> <p>▪ <code>isReductionRateAvailable</code> (boolean)</p> <p>Whether the size of the data can be reduced</p> <ul style="list-style-type: none"> <li data-bbox="1029 422 1395 709">• <code>true</code>: The size of the data can be reduced. <li data-bbox="1029 506 1416 709">If the value of this attribute is <code>true</code>, the percentage by which the size of the data has been reduced is displayed for the <code>reductionRate</code> attribute. <li data-bbox="1029 747 1416 953">• <code>false</code>: The size of the data cannot be reduced (for example, if the size of the data after data reduction is greater than the size of the data before data reduction). <li data-bbox="992 1003 1416 1304"> <p>▪ <code>reductionRate</code> (int)</p> <p>Percentage (%) by which the size of the data has been reduced</p> <p>This attribute is displayed when the value of the <code>isReductionRateAvailable</code> attribute is <code>true</code>.</p>
<code>dataReductionIncludingSystemData</code>	object	<p>The attributes related to the size of data reduced by using the capacity saving function (compression and deduplication) are displayed.</p>

Attribute	Type	Description
		<p>These attributes are calculated based on the size of the data (which includes, in addition to user data, metadata and garbage data generated by the storage system) after data reduction is performed.</p> <ul style="list-style-type: none"> ▪ <code>isReductionCapacityAvailable</code> (boolean) <p>Whether the size of the data can be reduced</p> <ul style="list-style-type: none"> • <code>true</code>: The size of the data can be reduced. <p>If the value of this attribute is <code>true</code>, the size of the data that has been reduced is displayed for the <code>reductionCapacity</code> attribute.</p> • <code>false</code>: The size of the data cannot be reduced (for example, if the size of the data after data reduction is greater than the size of the data before data reduction). ▪ <code>reductionCapacity</code> (long) <p>Size (in blocks) of the data that was reduced</p> <p>This attribute is displayed when the value of the <code>isReductionCapacityAvailable</code> attribute is <code>true</code>.</p>

Attribute	Type	Description
		<ul style="list-style-type: none"> ▪ <code>isReductionRateAvailable</code> (boolean) Whether the size of the data can be reduced <ul style="list-style-type: none"> • <code>true</code>: The size of the data can be reduced. If the value of this attribute is <code>true</code>, the percentage by which the size of the data has been reduced is displayed for the <code>reductionRate</code> attribute. • <code>false</code>: The size of the data cannot be reduced (for example, if the size of the data after data reduction is greater than the size of the data before data reduction). ▪ <code>reductionRate</code> (int) Percentage (%) by which the size of the data has been reduced This attribute is displayed when the value of the <code>isReductionRateAvailable</code> attribute is <code>true</code>.
<code>compressionRate</code>	int	Percentage (%) of data on which data reduction has been performed by using the compression function or the accelerated compression function
<code>duplicationRate</code>	int	Percentage (%) of data on which data reduction has been performed by using the deduplication function

Attribute	Type	Description
isMainframe	boolean	Displays a pool for the mainframe or the open system <ul style="list-style-type: none"> ▪ true: Pool for the mainframe volume ▪ false: Pool for the open volume

The following is an example of the output generated when getting Thin Image pool information:

```
{
  "poolId": 3,
  "poolStatus": "POLN",
  "usedCapacityRate": 0,
  "usedPhysicalCapacityRate": 0,
  "snapshotCount": 0,
  "poolName": "pool_for_snapshot_data",
  "availableVolumeCapacity": 6006,
  "availablePhysicalVolumeCapacity": 6006,
  "totalPoolCapacity": 6006,
  "totalPhysicalCapacity": 6006,
  "numOfLdevs": 1,
  "firstLdevId": 1026,
  "warningThreshold": 80,
  "virtualVolumeCapacityRate": -1,
  "isMainframe": false,
  "isShrinking": false,
  "poolType": "HTI"
}
```

For a Thin Image pool:

Attribute	Type	Description
poolId	int	Pool number
poolName	string	Pool name
poolType	string	Pool type is output. HTI: Thin Image pool

Attribute	Type	Description
poolStatus	string	<p>One of the following is output as the pool status:</p> <ul style="list-style-type: none"> ▪ POLN: Normal (Pool Normal) ▪ POLF: The pool is in the overflow status exceeding the threshold. (Pool Full) ▪ POLS: The pool is in the overflow status exceeding the threshold and is suspended. (Pool Suspend) ▪ POLE: The pool is suspended in the failure status. (Pool failure) <p>If the pool status is POLE, pool information cannot be obtained.</p>
usedCapacityRate	int	Usage rate of logical capacity (%)
usedPhysicalCapacityRate	int	Usage rate of physical capacity (%)
snapshotCount	int	Number of volumes in the pool
availableVolumeCapacity	long	Free logical capacity (MB)
availablePhysicalVolumeCapacity	long	Free physical capacity (MB) For this attribute, 1 MB is equal to 1,024 ² bytes.
totalPoolCapacity	long	Total logical capacity (MB)
totalPhysicalCapacity	long	Total physical capacity (MB) For this attribute, 1 MB is equal to 1,024 ² bytes.
numOfLdevs	int	Number of LDEVs in the pool
firstLdevId	int	The first LDEV number of the LDEVs in the pool (Not the first number in ascending order)
warningThreshold	int	The warning threshold set for the pool
virtualVolumeCapacityRate	int	-1 indicating the invalid value is output.

Attribute	Type	Description
isShrinking	boolean	Whether the pool is shrinking is output. <ul style="list-style-type: none"> ▪ <code>true</code>: The pool is shrinking. ▪ <code>false</code>: The pool is not shrinking.
isMainframe	boolean	Displays a pool for the mainframe or the open system <ul style="list-style-type: none"> ▪ <code>true</code>: Pool for the mainframe volume ▪ <code>false</code>: Pool for the open volume

Status codes

For details on the status codes of the request for this operation, see the description on HTTP status codes.

Coding example

```
curl -v -H "Accept:application/json" -H "Content-Type:application/json" -H
"Authorization:Session d7b673af189048468c5af9bcf3b6bb6f" -X GET https://
192.0.2.100/ConfigurationManager/v1/objects/pools/18
```

Creating a pool

The following request creates pools by specifying the LDEV. In the REST API, you can create DP pools and Thin Image pools. You can specify LDEVs by specifying LDEV numbers or a range of consecutive LDEV numbers.



Tip: If you want to store snapshot data in an HDP pool instead of a Thin Image pool, specify `HDP` for the `poolType` attribute when you create the pool.

Execution permission

Storage Administrator (Provisioning)

Request line

```
POST base-URL/v1/objects/pools
```

Request message

Object ID

None.

Query parameters

None.

Body

The following coding example creates an HDP pool by specifying the LDEV number:

```
{
  "poolId": 76,
  "poolName": "pool_for_email_server",
  "ldevIds": [405],
  "poolType": "HDP"
}
```

The following coding example creates an HDP pool by specifying a range of consecutive LDEV numbers:

```
{
  "poolId": 76,
  "poolName": "pool_for_email_server",
  "startLdevId": 101,
  "endLdevId": 105,
  "poolType": "HDP"
}
```

When creating a DP pool:

Attribute	Type	Description
poolId	int	(Required) Specify the pool number with a decimal (base 10) number.
poolName	string	(Required) Pool name Specify a character string consisting of 1 to 32 characters.
poolType	string	(Required) Pool type The specifiable values are as follows: <ul style="list-style-type: none"> ▪ HDP: HDP pools ▪ HDT: HDT pools
ldevIds	int[]	(Optional) LDEV number Specify a decimal (base 10) number. Make sure to specify this attribute when specifying LDEV numbers.

Attribute	Type	Description
		You can specify up to 64 digits. This attribute cannot be specified along with the <code>startLdevId</code> and <code>endLdevId</code> attribute.
<code>startLdevId</code>	int	<p>(Optional) The first LDEV number in the range of consecutive LDEV numbers, if such a range is specified</p> <p>Make sure to specify this attribute when specifying a range of LDEV numbers.</p> <p>If you specify this attribute, be sure to also specify the <code>endLdevId</code> attribute. The value of this attribute must be smaller than that of <code>endLdevId</code>.</p> <p>Specify a number such that the range indicated by the <code>startLdevId</code> and <code>endLdevId</code> attributes consists of no more than 64 LDEVs.</p> <p>This attribute cannot be specified along with the <code>ldevIds</code> attribute.</p>
<code>endLdevId</code>	int	<p>(Optional) The last LDEV number in the range of consecutive LDEV numbers, if such a range is specified</p> <p>Make sure to specify this attribute when specifying a range of LDEV numbers.</p> <p>If you specify this attribute, be sure to also specify the <code>startLdevId</code> attribute. The value of this attribute must be greater than that of <code>startLdevId</code>.</p> <p>Specify a number such that the range indicated by the <code>startLdevId</code> and <code>endLdevId</code> attributes consists of no more than 64 LDEVs.</p> <p>This attribute cannot be specified along with the <code>ldevIds</code> attribute.</p>
<code>warningThreshold</code>	int	<p>(Optional) Warning threshold (%)</p> <p>Specify a value in the range from 1 to 100. Specify a value smaller than that of <code>depletionThreshold</code>. If this attribute is omitted, 70 is assumed.</p>
<code>depletionThreshold</code>	int	(Optional) Depletion threshold (%)

Attribute	Type	Description
		Specify a value in the range from 1 to 100. Specify a value greater than the value of <code>warningThreshold</code> . If this attribute is omitted, 80 is assumed.
<code>suspendSnapshot</code>	boolean	<p>(Optional) Specify whether to suspend Thin Image pairs when the depletion threshold is exceeded.</p> <p>You can specify this attribute if the pool to be created is an HDP pool for storing snapshot data.</p> <ul style="list-style-type: none"> <code>true</code>: Suspend Thin Image pairs when the depletion threshold is exceeded. <code>false</code>: Do not suspend Thin Image pairs when the depletion threshold is exceeded. <p>If you specify <code>HDP</code> for the <code>poolType</code> attribute and omit this attribute, <code>true</code> is assumed.</p>

The following coding example creates a Thin Image pool:

```
{
  "poolId":76,
  "poolName":"pool_for_snapshot_copy",
  "ldevIds":[405],
  "poolType": "HTI"
}
```

When creating a Thin Image pool:

Attribute	Type	Description
<code>poolId</code>	int	(Required) Specify the pool number with a decimal (base 10) number.
<code>poolName</code>	string	(Required) Pool name Specify a character string consisting of 1 to 32 characters.
<code>poolType</code>	string	(Required) Pool type <code>HTI</code> : Thin Image pools
<code>ldevIds</code>	int[]	(Optional) LDEV number Specify a decimal (base 10) number.

Attribute	Type	Description
		<p>Make sure to specify this attribute when specifying LDEV numbers.</p> <p>You can specify up to 64 digits. This attribute cannot be specified along with the <code>startLdevId</code> and <code>endLdevId</code> attribute.</p>
<code>startLdevId</code>	int	<p>(Optional) First LDEV number when specifying a range of consecutive LDEV numbers.</p> <p>Make sure to specify this attribute when specifying a range of LDEV numbers.</p> <p>If you specify this attribute, be sure to also specify the <code>endLdevId</code> attribute. The value of this attribute must be smaller than that of <code>endLdevId</code>.</p> <p>Specify a number such that the range indicated by the <code>startLdevId</code> and <code>endLdevId</code> attributes consists of no more than 64 LDEVs.</p> <p>This attribute cannot be specified along with the <code>ldevIds</code> attribute.</p>
<code>endLdevId</code>	int	<p>(Optional) Last LDEV number when specifying a range of consecutive LDEV numbers.</p> <p>Make sure to specify this attribute when specifying a range of LDEV numbers.</p> <p>If you specify this attribute, be sure to also specify the <code>startLdevId</code> attribute. The value of this attribute must be greater than that of <code>startLdevId</code>.</p> <p>Specify a number such that the range indicated by the <code>startLdevId</code> and <code>endLdevId</code> attributes consists of no more than 64 LDEVs.</p> <p>This attribute cannot be specified along with the <code>ldevIds</code> attribute.</p>
<code>warningThreshold</code>	int	<p>(Optional) Warning threshold (%)</p> <p>Specify a value in the range from 20 to 95. If this attribute is omitted, 80 is assumed.</p>

Response message

Body

A job object is returned. For details on attributes other than `affectedResources`, see the section explaining job objects.

Attribute	Description
affectedResources	URL of the created pool

Status codes

The following table describes the meaning of the status code of the request for this operation. For details on other status codes, see the description on HTTP status codes.

Status code	Message	Description
409	Conflict	A pool of the specified pool number has already been created.

Coding example

```
curl -v -H "Accept:application/json" -H "Content-Type:application/json" -H "Authorization:Session d7b673af189048468c5af9bcf3b66b6f" -X POST --data-binary @./InputParameters.json https://192.0.2.100/ConfigurationManager/v1/objects/pools
```

Changing pool settings

The following request changes the pool name, pool type, attributes related to an HDT pool tier, and other settings.

Execution permission

Storage Administrator (Provisioning)

Request line

```
PATCH base-URL/v1/objects/pools/object-ID
```

Request message**Object ID**

Specify the value of `poolId` that was obtained by the processing to get information about pools.

Attribute	Type	Description
<code>poolId</code>	int	(Required) Pool number

Query parameters

None.

Body

The following coding example changes the warning threshold and depletion threshold of a DP pool,:

```
{
  "warningThreshold": 75,
  "depletionThreshold": 85
}
```

The following coding example sets the attributes related to a specific tier of an HDT pool:

```
{
  "tier": {
    "tierNumber": 1,
    "tablespaceRate": 30,
    "bufferRate": 30
  }
}
```

Attribute	Type	Description
<code>poolName</code>	string	(Optional) Pool name Specify the pool name by using 1 to 32 characters.
<code>poolType</code>	string	(Optional) Changes the pool type

Attribute	Type	Description
		<p>You can specify the following values:</p> <ul style="list-style-type: none"> ▪ HDP: Changes to an HDP pool You cannot specify this value for pools for active flash. ▪ HDT: Changes to an HDT pool You cannot specify this value for HDP pools for which Thin Image pairs have been created. ▪ RT: Changes to a pool for active flash You cannot specify this value for HDP pools. <p>You cannot specify this attribute for Thin Image pools or for data direct mapping HDP pools.</p>
warningThreshold	int	<p>(Optional) New warning threshold (%)</p> <p>Depending on the pool type, specify the following values:</p> <ul style="list-style-type: none"> ▪ For DP pools: 1 to 100 Specify this attribute together with the <code>depletionThreshold</code> attribute. ▪ For Thin Image pools: 20 to 95 <p>You cannot specify this value for data direct mapping HDP pools.</p>
depletionThreshold	int	<p>(Optional) New depletion threshold (%)</p> <p>Specify a value in the range from 1 to 100.</p> <p>For DP pools, specify this attribute together with the <code>warningThreshold</code> attribute.</p> <p>You cannot specify this value for Thin Image pools or for data direct mapping HDP pools.</p>
suspendSnapshot	boolean	<p>(Optional) Whether to suspend Thin Image pairs when the depletion threshold is exceeded.</p>

Attribute	Type	Description
		<p>You can specify this attribute for HDP pools that contain snapshot data.</p> <ul style="list-style-type: none"> ▪ <code>true</code>: Suspend Thin Image pairs when the depletion threshold is exceeded. ▪ <code>false</code>: Do not suspend Thin Image pairs when the depletion threshold is exceeded.
blockingMode	string	<p>(Optional) Setting the protection function for a virtual volume</p> <p>If a DP pool is full or a DP pool volume is blocked, specify whether it is possible to perform read and write operations for a DP volume that uses the target DP pool.</p> <ul style="list-style-type: none"> ▪ <code>PF</code>: Pool Full <p>If the DP pool is full, read and write operations are not possible.</p> <p>If the DP pool volume is blocked, read and write operations are possible.</p> ▪ <code>PB</code>: Pool vol Blockade <p>If the DP pool volume is blocked, read and write operations are not possible.</p> <p>If the DP pool is full, read and write operations are possible.</p> ▪ <code>FB</code>: Full or Blockade <p>If the DP pool is full or the DP pool volume is blocked, read and write operations are not possible.</p> ▪ <code>NB</code>: No Blocking <p>Even if the DP pool is full or the DP pool volume is blocked, read and write operations are possible for the target DP volume.</p> <p>You cannot specify this value for Thin Image pools.</p>
tier	object	(Optional) HDT pool tier attribute

Attribute	Type	Description
		<ul style="list-style-type: none"> ▪ tierNumber (int) Tier number Specify a number from 1 to 3. This must be specified if you want to change the <code>tablespaceRate</code> attribute or the <code>bufferRate</code> attribute. ▪ tablespaceRate (int) Ratio of free space for new tiering (in percentage) Specify a value from 0 to 50. If you specify this attribute, you must also specify the <code>tierNumber</code> attribute. ▪ bufferRate (int) Ratio of buffer areas for reallocation (in percentage) Specify a value from 2 to 40. If you specify this attribute, you must also specify the <code>tierNumber</code> attribute.
monitoringMode	string	<p>(Optional) Execution mode for performance monitoring (monitor mode)</p> <p>If the pool type is HDT, the following values can be specified:</p> <ul style="list-style-type: none"> ▪ PM: Periodic mode (Period Mode) ▪ CM: Continuous mode (Continuous Mode)

Response message

Body

A job object is returned. For details on attributes other than `affectedResources`, see the description on job objects.

Attribute	Description
affectedResources	URL of the pool whose settings were changed

Action template

None.

Status codes

The following table describes the meanings of the status codes of the request for this operation. For details on the other status codes, see the description about HTTP status codes.

Status code	Message	Description
409	Conflict	The specified pool name already exists.

Coding example

```
curl -v -H "Accept:application/json" -H "Content-Type:application/json" -H
"Authorization:Session d7b673af189048468c5af9bcf3bbbb6f" -X PATCH --data-
binary @./InputParameters.json https://192.0.2.100/ConfigurationManager/v1/
objects/pools/88
```

Expanding a pool

To expand the capacity of a pool, the following request adds LDEVs to the pool.

Execution permission

Storage Administrator (Provisioning)

Request line

```
POST base-URL/v1/objects/pools/object-ID/actions/expand/invoke
```

Request message**Object ID**

Specify the `poolId` value obtained by getting information about pools.

Attribute	Type	Description
poolId	int	(Required) Pool number

Query parameters

None.

Body

```
{
  "parameters": {
    "ldevIds": [101,102]
  }
}
```

Attribute	Type	Description
ldevIds	int[]	(Optional) Specify the LDEV number with a decimal (base 10) number. You can specify up to 64 numbers. This attribute cannot be specified along with the startLdevId and endLdevId attribute.
startLdevId	int	(Optional) First LDEV number when specifying a range of consecutive LDEV numbers. If you specify this attribute, be sure to also specify the endLdevId attribute. The value of this attribute must be smaller than that of endLdevId. Specify a number such that the range indicated by the startLdevId and endLdevId attributes consists of no more than 64 LDEVs. This attribute cannot be specified along with the ldevIds attribute.
endLdevId	int	(Optional) Last LDEV number when specifying a range of consecutive LDEVs. If you specify this attribute, be sure to also specify the startLdevId attribute. The value of this attribute must be greater than that of startLdevId. Specify a number such that the range indicated by the startLdevId and endLdevId attributes consists of no more than 64 LDEVs. This attribute cannot be specified along with the ldevIds attribute.

Response message**Body**

A job object is returned. For details on attributes other than `affectedResources`, see the section explaining job objects.

Attribute	Description
affectedResources	URL of the expanded pool

Action template

```
GET base-URL/v1/objects/pools/object-ID/actions/expand
```

Status codes

For details on the status codes of the request for this operation, see the description on HTTP status codes.

Coding example

To get an action template:

```
curl -v -H "Accept:application/json" -H "Content-Type:application/json" -H
"Authorization:Session d7b673af189048468c5af9bcf3b6bb6f" -X GET https://
192.0.2.100/ConfigurationManager/v1/objects/pools/3/actions/expand
```

To run the request after getting an action template:

```
curl -v -H "Accept:application/json" -H "Content-Type:application/json" -H
"Authorization:Session d7b673af189048468c5af9bcf3b6bb6f" -X POST --data-
binary @./InputParameters.json https://192.0.2.100/ConfigurationManager/v1/
objects/pools/3/actions/expand/invoke
```

Shrinking a pool

The following request removes an LDEV from a pool to decrease the pool capacity. Note that you cannot remove all LDEVs from the pool.

Execution permission

Storage Administrator (Provisioning)

Request line

```
POST base-URL/v1/objects/pools/object-ID/actions/shrink/invoke
```

Request message**Object ID**

Specify the value of `poolId` that was obtained by the processing to get information about pools.

Attribute	Type	Description
<code>poolId</code>	int	(Required) Pool number

Query parameters

None.

Body

```
{
  "parameters": {
    "ldevIds": [101,102]
  }
}
```

Attribute	Type	Description
<code>ldevIds</code>	int[]	(Optional) Specify the LDEV number with a decimal (base 10) number. You can specify up to 64 numbers. This attribute cannot be specified along with the <code>startLdevId</code> and <code>endLdevId</code> attribute.
<code>startLdevId</code>	int	(Optional) First LDEV number when specifying a range of consecutive LDEV numbers. If you specify this attribute, be sure to also specify the <code>endLdevId</code> attribute. The value of this attribute must be smaller than that of <code>endLdevId</code> . Specify a number such that the range indicated by the <code>startLdevId</code> and <code>endLdevId</code> attributes consists of no more than 64 LDEVs. This attribute cannot be specified along with the <code>ldevIds</code> attribute.
<code>endLdevId</code>	int	(Optional) Last LDEV number when specifying a range of consecutive LDEVs. If you specify this attribute, be sure to also specify the <code>startLdevId</code> attribute. The value of this attribute must be greater than that of <code>startLdevId</code> .

Attribute	Type	Description
		Specify a number such that the range indicated by the startLdevId and endLdevId attributes consists of no more than 64 LDEVs. This attribute cannot be specified along with the ldevIds attribute.

Response message

Body

A job object is returned. For details on attributes other than `affectedResources`, see the description on job objects.

Attribute	Description
<code>affectedResources</code>	URL of the shrunk pool

Action template

```
GET base-URL/v1/objects/pools/object-ID/actions/shrink
```

Status codes

The following table describes the meaning of the status code of the request for this operation. For details on other status codes, see the description on HTTP status codes.

Status code	Message	Description
412	Precondition Failed	The specified action cannot be run on the specified pool because there is only one LDEV in the pool.

Coding example

To get an action template:

```
curl -v -H "Accept:application/json" -H "Content-Type:application/json" -H "Authorization:Session d7b673af189048468c5af9bcf3b6bb6f" -X GET https://192.0.2.100/ConfigurationManager/v1/objects/pools/3/actions/shrink
```

To run the request after getting an action template:

```
curl -v -H "Accept:application/json" -H "Content-Type:application/json" -H
"Authorization:Session d7b673af189048468c5af9bcf3b66b6f" -X POST --data-
binary @./InputParameters.json https://192.0.2.100/ConfigurationManager/v1/
objects/pools/3/actions/shrink/invoke
```

Performing performance monitoring of a pool

The following request starts or ends performance monitoring of an HDT pool. By performing performance monitoring, you can collect the I/O performance on each page of a pool as monitoring information to understand the characteristics of the I/O performance on each page allocated to an HDT volume. Perform performance monitoring before tier relocation.

Execution permission

Storage Administrator (Provisioning)

Request line

```
POST base-URL/v1/objects/pools/object-ID/actions/monitor/invoke
```

Request message

Object ID

Specify the `poolId` value obtained by getting information about pools.

Attribute	Type	Description
poolId	int	(Required) Pool number

Query parameters

None.

Body

```
{
  "parameters": {
    "operationType": "start"
  }
}
```

Attribute	Type	Description
operationType	string	(Required) Specify the operation of performance monitoring. <ul style="list-style-type: none"> ▪ <code>start</code>: Start performance monitoring. ▪ <code>stop</code>: End performance monitoring.

Response message

Body

A job object is returned. For details on attributes other than `affectedResources`, see the section explaining job objects.

Attribute	Description
affectedResources	URL of the pool for which performance monitoring was started or ended

Action template

```
GET base-URL/v1/objects/pools/object-ID/actions/monitor
```

Status codes

The following table explains the meanings of the status codes for this API. For details on other status codes, see the section explaining HTTP status codes.

Status code	Message	Description
412	Precondition Failed	The specified action cannot be run because the pool meets either of the following conditions: <ul style="list-style-type: none"> ▪ The pool is not an HDT pool. ▪ The execution mode for the pool is auto (AUT).

Coding example

To get an action template:

```
curl -v -H "Accept:application/json" -H "Content-Type:application/json" -H "Authorization:Session d7b673af189048468c5af9bcf3b6bb6f" -X GET https://192.0.2.100/ConfigurationManager/v1/objects/pools/3/actions/monitor
```

To run the API request after getting an action template:

```
curl -v -H "Accept:application/json" -H "Content-Type:application/json" -H
"Authorization:Session d7b673af189048468c5af9bcf3b6bb6f" -X POST --data-
binary @./InputParameters.json https://192.0.2.100/ConfigurationManager/v1/
objects/pools/3/actions/monitor/invoke
```

Performing tier relocation

The following request relocates HDT pool data (in units of pages) to an appropriate tier, based on the monitoring information collected by performance monitoring. Before performing tier relocation, perform performance monitoring in advance.

Execution permission

Storage Administrator (Provisioning)

Request line

```
POST base-URL/v1/objects/pools/object-ID/actions/relocate/invoke
```

Request message

Object ID

Specify the `poolId` value obtained by getting information about pools.

Attribute	Type	Description
poolId	int	(Required) Pool number

Query parameters

None.

Body

```
{
  "parameters": {
    "operationType": "start"
  }
}
```

Attribute	Type	Description
operationType	string	(Required) Specify the operation of tier relocation. <ul style="list-style-type: none"> ▪ <code>start</code>: Start tier relocation. ▪ <code>stop</code>: End tier relocation.

Response message

Body

A job object is returned. For details on attributes other than `affectedResources`, see the section explaining job objects.

Attribute	Description
affectedResources	URL of the pool for which tier relocation was started or ended

Action template

```
GET base-URL/v1/objects/pools/object-ID/actions/relocate
```

Status codes

The following table explains the meanings of the status codes for this API. For details on other status codes, see the section explaining HTTP status codes.

Status code	Message	Description
412	Precondition Failed	The specified action cannot be run because the pool meets either of the following conditions: <ul style="list-style-type: none"> ▪ The pool is not an HDT pool. ▪ The execution mode for the pool is auto (AUT).

Coding example

To get an action template:

```
curl -v -H "Accept:application/json" -H "Content-Type:application/json" -H
"Authorization:Session d7b673af189048468c5af9bcf3b6bb6f" -X GET https://
192.0.2.100/ConfigurationManager/v1/objects/pools/3/actions/relocate
```

To run the API request after getting an action template:

```
curl -v -H "Accept:application/json" -H "Content-Type:application/json" -H
"Authorization:Session d7b673af189048468c5af9bcf3b66b6f" -X POST --data-
binary @./InputParameters.json https://192.0.2.100/ConfigurationManager/v1/
objects/pools/3/actions/relocate/invoke
```

Restoring a pool

The following request unblocks a pool after recovery from a failure or other problems.

Execution permission

Storage Administrator (Provisioning)

Request line

```
POST base-URL/v1/objects/pools/object-ID/actions/recover/invoke
```

Request message

Object ID

Specify the `poolId` value obtained by getting information about pools.

Attribute	Type	Description
poolId	int	(Required) Pool number

Query parameters

None.

Body

None.

Response message

Body

A job object is returned. For details on attributes other than `affectedResources`, see the section explaining job objects.

Attribute	Description
affectedResources	URL of the recovered pool

Action template

None.

Status codes

The following table explains the meanings of the status codes for this API. For details on other status codes, see the section explaining HTTP status codes.

Status code	Message	Description
412	Precondition Failed	The specified action cannot be run because the pool meets either of the following conditions: <ul style="list-style-type: none"> The pool is not in the blocked status. The pool usage rate is 100%.

Coding example

```
curl -v -H "Accept:application/json" -H "Content-Type:application/json" -H
"Authorization:Session d7b673af189048468c5af9bcf3b6bb6f" -X POST https://
192.0.2.100/ConfigurationManager/v1/objects/pools/3/actions/recover/invoke
-d ""
```

Initializing the capacity saving function for a pool

The following request initializes, in a batch operation, the capacity saving function (dedupe and compression) for specified pools for which the deduplication function is enabled. This request formats all deduplication system data volumes and volumes for which the capacity saving function (deduplication) is enabled.



Note:

- After running this API function, if necessary, change the `status` attribute to the normal status for the volumes for which the capacity saving function (deduplication) is enabled.

Execution permission

Storage Administrator (Provisioning)

Request line

```
POST base-URL/v1/objects/pools/object-ID/actions/data-reduction-initialize/
invoke
```

Request message**Object ID**

Specify the `poolId` value obtained by getting information about the pools.

Attribute	Type	Description
<code>poolId</code>	<code>int</code>	(Required) Pool number

Query parameters

None.

Body

None.

Response message**Body**

A job object is returned. For details on attributes other than `affectedResources`, see the description of job objects.

Attribute	Description
<code>affectedResources</code>	URL of the pool to which the initialized volumes belong

Action template

None.

Status codes

For details on the status codes of the request for this operation, see the description on HTTP status codes.

Coding example

```
curl -v -H "Accept:application/json" -H "Content-Type:application/json" -H
"Authorization:Session d7b673af189048468c5af9bcf3b66b6f" -X POST https://
192.0.2.100/ConfigurationManager/v1/objects/pools/3/actions/data-reduction-
initialize/invoke -d ""
```

Deleting a pool

The following request deletes a pool by specifying the pool number.

Execution permission

Storage Administrator (Provisioning)

Request lineDELETE *base-URL/v1/objects/pools/object-ID***Request message****Object ID**Specify the `poolId` value obtained by getting information about pools.

Attribute	Type	Description
poolId	int	(Required) Pool number

Query parameters

None.

Body

None.

Response message**Body**A job object is returned. For details on attributes other than `affectedResources`, see the section explaining job objects.

Attribute	Description
affectedResources	URL of the deleted pool

Status codes

For details on the status codes of the request for this operation, see the description on HTTP status codes.

Coding example

```
curl -v -H "Accept:application/json" -H "Content-Type:application/json" -H
"Authorization:Session d7b673af189048468c5af9bcf3bbbb6f" -X DELETE
https://192.0.2.100/ConfigurationManager/v1/objects/pools/3
```

Chapter 7: Optimizing I/O performance

This chapter describes how the REST API can be used to optimize I/O performance between the host and the storage system by using the functions of Virtual Partition Manager and Server Priority Manager, or by changing the assignment of MP blade servers.

Overview of optimizing I/O performance

This section describes optimization of I/O performance between a host and a storage system.

To optimize I/O performance by using the REST API, use one the following methods:

- Use the Virtual Partition Manager function for dividing the cache to prevent a specific host from monopolizing use of too much cache capacity.
- Use the Server Priority Manager function to prioritize the I/O operations of hosts for which fast processing is required by restricting the I/O performance of lower-priority hosts.
- Assign specific MP blades to resources to distribute the workload of I/O operations.

Managing CLPRs

Use the Virtual Partition Manager function to divide the cache and allocate the resources that use the cache. By doing so, you can prevent a situation in which a specific host monopolizes use of too many cache memory areas and I/O performance deteriorates.

You can use the REST API to create or delete a CLPR, or assign resources.

For details about the CLPR function and notes on using CLPRs, see the manual for Virtual Partition Manager.

Using Server Priority Manager

To prevent performance degradation of high-priority hosts, you can use the Server Priority Manager function to restrict the number of times a lower-priority host can access a storage system and the amount of data a lower-priority host can transfer.

You can configure Server Priority Manager by specifying a port and the WWN of the HBA or by specifying a volume (LDEV) and the WWN or iSCSI name of the HBA. You cannot use both specification methods on the same storage system. If you are using the REST API, configure settings by specifying a volume and the WWN or iSCSI name of the HBA.

Use a product such as the Tuning Manager API to check the performance information of hosts for which Server Priority Manager information was set by specifying the volume and WWN or iSCSI name of the HBA in the REST API.

**Note:**

For storage systems for which the Server Priority Manager function is already being used from a product such as Storage Navigator, you cannot use the Server Priority Manager function from the REST API. To configure Server Priority Manager from the REST API, first delete all Server Priority Manager settings from products such as Storage Navigator.

Assigning MP blades

If you assign specific MP blades to each resource related to the input or output of data (resources such as LDEVs, external parity groups, and journals), those resources have exclusive use of the corresponding MP blades. In addition, if there are many write operations from hosts to a specific MP blade, you can distribute the I/O workload by assigning another MP blade to the resource that is placing a heavy load on the first MP blade.

You can use the REST API to change the MP blade assigned to an LDEV, an external parity group, or a journal. For details, see the descriptions of the API requests for changing the assignment of an MP blade in the following sections:

- For LDEVs: The section explaining the volume allocation
- For external parity groups: The section explaining the optimization of I/O performance
- For journals: The section explaining how to configure a remote copy environment

Getting information about CLPRs

Obtain a list of CLPRs. You can obtain information such as the cache capacity, cache usage rate, and resident cache capacity.

Execution permission

Storage Administrator (View Only)

Request line

```
GET base-URL/v1/objects/clprs
```

Request message**Object ID**

None.

Query parameters

None.

Body

None.

Response message**Body**

```

{
  "data": [
    {
      "clprId": 0,
      "clprName": "CLPR0",
      "cacheMemoryCapacity": 171776,
      "cacheMemoryUsedCapacity": 41055,
      "writePendingDataCapacity": 56,
      "sideFilesCapacity": 0,
      "cacheUsageRate": 24,
      "writePendingDataRate": 1,
      "sideFilesUsageRate": 0
    },
    {
      "clprId": 1,
      "clprName": "CLPR1",
      "cacheMemoryCapacity": 4096,
      "cacheMemoryUsedCapacity": 0,
      "writePendingDataCapacity": 0,
      "sideFilesCapacity": 0,
      "cacheUsageRate": 0,
      "writePendingDataRate": 0,
      "sideFilesUsageRate": 0
    },
    {
      "clprId": 2,
      "clprName": "CLPRDEV",
      "cacheMemoryCapacity": 12288,
      "cacheMemoryUsedCapacity": 0,
      "writePendingDataCapacity": 0,
      "sideFilesCapacity": 0,
      "cacheUsageRate": 0,
      "writePendingDataRate": 0,
      "sideFilesUsageRate": 0
    }
  ]
}

```

Attribute	Type	Description
clprId	int	CLPR ID
clprName	string	CLPR name
cacheMemoryCapacity	long	Cache size (MB)

Attribute	Type	Description
cacheMemoryUsedCapacity	long	Used cache size (MB)
writePendingDataCapacity	long	Amount of data waiting to be written (MB)
sideFilesCapacity	long	Size of side files (MB)
cacheUsageRate	int	Cache usage rate (%)
writePendingDataRate	int	Rate of data waiting to be written (%)
sideFilesUsageRate	int	Side file usage rate (%)

Status codes

For details on the status codes of the request for this operation, see the description of HTTP status codes.

Coding example

```
curl -v -H "Accept:application/json" -H "Content-Type:application/json" -H
"Authorization:Session d7b673af189048468c5af9bcf3b6bb6f" -X GET https://
192.0.2.100/ConfigurationManager/v1/objects/clprs
```

Getting information about a specific CLPR

Obtain information about a specific CLPR by specifying the CLPR ID. You can obtain information such as the cache capacity, cache usage rate, and resident cache capacity.

Execution permission

Storage Administrator (View Only)

Request line

```
GET base-URL/v1/objects/clprs/object-ID
```

Request message

Object ID

Specify the value of `clprId` that was obtained by the processing to get information about CLPRs.

Attribute	Type	Description
clprId	int	(Required) CLPR ID

Query parameters

None.

Body

None.

Response message**Body**

```
{
  "clprId": 2,
  "clprName": "CLPRGRP",
  "cacheMemoryCapacity": 12288,
  "cacheMemoryUsedCapacity": 0,
  "writePendingDataCapacity": 0,
  "sideFilesCapacity": 0,
  "cacheUsageRate": 0,
  "writePendingDataRate": 0,
  "sideFilesUsageRate": 0
}
```

Attribute	Type	Description
clprId	int	CLPR ID
clprName	string	CLPR name
cacheMemoryCapacity	long	Cache size (MB)
cacheMemoryUsedCapacity	long	Used cache size (MB)
writePendingDataCapacity	long	Amount of data waiting to be written (MB)
sideFilesCapacity	long	Size of side files (MB)
cacheUsageRate	int	Cache usage rate (%)
writePendingDataRate	int	Rate of data waiting to be written (%)
sideFilesUsageRate	int	Side file usage rate (%)

Status codes

For details on the status codes of the request for this operation, see the description of HTTP status codes.

Coding example

```
curl -v -H "Accept:application/json" -H "Content-Type:application/json" -H
"Authorization:Session d7b673af189048468c5af9bcf3b666f" -X GET https://
192.0.2.100/ConfigurationManager/v1/objects/clprs/2
```

Creating a CLPR

Create a CLPR.

**Note:**

If you locked any resources of the target storage system by using the REST API, you will not be able to use this API function. In such cases, unlock the resources before running the API function.

Execution permission

Storage Administrator (System Resource Management)

Request line

```
POST base-URL/v1/objects/clprs
```

Request message**Object ID**

None.

Query parameters

None.

Body

```
{
  "clprName" : "CLPRDEV",
  "cacheMemoryCapacity" : 12288
}
```

Attribute	Type	Description
clprName	string	(Required) CLPR name

Attribute	Type	Description
		Specify a name consisting of 1 to 16 characters. Specify a name that is unique among the CLPRs on the target storage system.
cacheMemoryCapacity	long	(Required) Total cache size of the CLPR (MB) Specify a multiple of 2048. For details on the size that can be specified for the cache, see the Virtual Partition Manager manual.

Response message

Body

A job object is returned. For details on attributes other than `affectedResources`, see the description of job objects.

Attribute	Description
affectedResources	URL of the created CLPR

Status codes

For details on the status codes of the request for this operation, see the description on HTTP status codes.

Coding example

```
curl -v -H "Accept:application/json" -H "Content-Type:application/json" -H
"Authorization:Session d7b673af189048468c5af9bcf3bbbb6f" -X POST --data-
binary @./InputParameters.json https://192.0.2.100/ConfigurationManager/v1/
objects/clprs
```

Changing the settings of a CLPR

Change the name, cache size, and other settings of a CLPR.

**Note:**

If you locked any resources of the target storage system by using the REST API, you will not be able to use this API function. In such cases, unlock the resources before running the API function.

Execution permission

Storage Administrator (System Resource Management)

Request line

```
PATCH base-URL/v1/objects/clprs/object-ID
```

Request message**Object ID**

Specify the value of `clprId` that was obtained by the processing to get information about CLPRs.

Attribute	Type	Description
clprId	int	(Required) CLPR ID

Query parameters

None.

Body

The following is a coding example for changing the name of a CLPR:

```
{
  "clprName" : "CLPRGRP"
}
```

The following is a coding example for changing the total cache size of a CLPR:

```
{
  "cacheMemoryCapacity" : 24576
}
```

The following is a coding example for changing the name and total cache size of a CLPR:

```
{
  "clprName" : "CLPRGRP",
```

```
"cacheMemoryCapacity" : 24576
}
```

Attribute	Type	Description
clprName	string	(Optional) CLPR name Specify a name consisting of 1 to 16 characters. Specify a name that is unique among the CLPRs on the target storage system.
cacheMemoryCapacity	long	(Optional) Total cache size of the CLPR (MB) Specify a multiple of 2048. For details on the size that can be specified for the cache, see the Virtual Partition Manager manual.

Response message

Body

A job object is returned. For details on attributes other than `affectedResources`, see the description of job objects.

Attribute	Description
affectedResources	URL of the CLPR whose settings were changed

Action template

None.

Status codes

For details on the status codes of the request for this operation, see the description on HTTP status codes.

Coding example

```
curl -v -H "Accept:application/json" -H "Content-Type:application/json" -H "Authorization:Session d7b673af189048468c5af9bcf3bbbb6f" -X PATCH --data-binary @./InputParameters.json https://192.0.2.100/ConfigurationManager/v1/objects/clprs/2
```

Deleting a CLPR

Delete a CLPR. Before deleting a CLPR, move any resources that are currently allocated to the CLPR to be deleted to other CLPRs.



Note:

If you locked any resources of the target storage system by using the REST API, you will not be able to use this API function. In such cases, unlock the resources before running the API function.

Execution permission

Storage Administrator (System Resource Management)

Request line

```
DELETE base-URL/v1/objects/clprs/object-ID
```

Request message

Object ID

Specify the value of `clprId` that was obtained by the processing to get information about CLPRs.

Attribute	Type	Description
clprId	int	(Required) CLPR ID

Query parameters

None.

Body

None.

Response message

Body

A job object is returned. For details on attributes other than `affectedResources`, see the description of job objects.

Attribute	Description
affectedResources	URL of the deleted CLPR

Status codes

For details on the status codes of the request for this operation, see the description on HTTP status codes.

Coding example

```
curl -v -H "Accept:application/json" -H "Content-Type:application/json" -H
"Authorization:Session d7b673af189048468c5af9bcf3bbbb6f" -X DELETE --data-
binary @./InputParameters.json https://192.0.2.100/ConfigurationManager/v1/
objects/clprs/3
```

Assigning LDEVs to a CLPR

The following request assigns LDEVs to a CLPR. You can use this API function to assign LDEVs to a created CLPR or to move an already assigned LDEV to a different CLPR.

Execution permission

Storage Administrator (System Resource Management)

Request line

```
POST base-URL/v1/objects/ldevs/object-ID/actions/assign-clpr/invoke
```

Request message**Object ID**

Specify the value of `ldevId` that was obtained by the processing to get information about volumes.

Attribute	Type	Description
<code>ldevId</code>	int	(Required) Specify the LDEV number as a decimal (base 10) number.

Query parameters

None.

Body

```
{
  "parameters": {
    "clprId": 2
  }
}
```

```
}
}
```

Attribute	Type	Description
clprId	int	(Required) CLPR ID of the CLPR to which the LDEV is to be assigned Specify a decimal (base 10) number in the range from 0 to 31.

Response message

Body

A job object is returned. For details on attributes other than `affectedResources`, see the description of job objects.

Attribute	Description
affectedResources	URL of the LDEV that was assigned to the CLPR

Action template

```
GET base-URL/v1/objects/ldevs/object-ID/actions/assign-clpr
```

Status codes

The following table describes the meanings of the status codes of the request for this operation. For details on other status codes, see the description of the HTTP status codes.

Status code	Message	Description
412	Precondition Failed	The specified action cannot be run, because the specified LDEV meets one of the following conditions: <ul style="list-style-type: none"> The specified LDEV is a basic volume. The specified LDEV is a journal volume. The specified LDEV is a Thin Image pool volume.

Coding example

To get an action template:

```
curl -v -H "Accept:application/json" -H "Content-Type:application/json" -H
"Authorization:Session d7b673af189048468c5af9bcf3bbbb6f" -X GET https://
192.0.2.100/ConfigurationManager/v1/objects/ldevs/100/actions/assign-clpr
```

To run the request after getting an action template:

```
curl -v -H "Accept:application/json" -H "Content-Type:application/json" -H
"Authorization:Session d7b673af189048468c5af9bcf3bbbb6f" -X POST --data-
binary @./InputParameters.json https://192.0.2.100/ConfigurationManager/v1/
objects/ldevs/100/actions/assign-clpr/invoke
```

Assigning parity groups to a CLPR

The following request assigns parity groups to a CLPR. You can use this API function to assign parity groups to a created CLPR or to move an already assigned parity group to a different CLPR.

Execution permission

Storage Administrator (System Resource Management)

Request line

```
POST base-URL/v1/objects/parity-groups/object-ID/actions/assign-clpr/invoke
```

Request message**Object ID**

Specify the value of `parityGroupId` that was obtained by the processing to get information about parity groups.

Attribute	Type	Description
parityGroupId	string	(Required) Parity group number Specify concatenated parity groups in the same way. For 1-3-1, 1-3-2, and 1-3-3 concatenated parity groups, specify as follows: "parityGroupId": "1-3"

Query parameters

None.

Body

```
{
  "parameters": {
    "clprId": 2
  }
}
```

Attribute	Type	Description
clprId	int	(Required) CLPR ID of the CLPR to which the parity group is to be assigned Specify a decimal (base 10) number in the range from 0 to 31.

Response message**Body**

A job object is returned. For details on attributes other than `affectedResources`, see the description of job objects.

Attribute	Description
affectedResources	URL of the parity group that was assigned to the CLPR

Action template

```
GET base-URL/v1/objects/parity-groups/object-ID/actions/assign-clpr
```

Status codes

For details on the status codes of the request for this operation, see the description of HTTP status codes.

Coding example

To get an action template:

```
curl -v -H "Accept:application/json" -H "Content-Type:application/json" -H "Authorization:Session d7b673af189048468c5af9bcf3b6bb6f" -X GET https://
```

```
192.0.2.100/ConfigurationManager/v1/objects/parity-groups/1-1/actions/assign-clpr
```

To run the request after getting an action template:

```
curl -v -H "Accept:application/json" -H "Content-Type:application/json" -H "Authorization:Session d7b673af189048468c5af9bcf3b66b6f" -X POST --data-binary @./InputParameters.json https://192.0.2.100/ConfigurationManager/v1/objects/parity-groups/1-1/actions/assign-clpr/invoke
```

Getting information about external parity groups

The following request gets a list of information about external parity groups. You can get the information such as the number of LDEVs allocated to external parity groups and the usage rate of external parity groups.

Execution permission

Storage Administrator (View Only)

Request line

```
GET base-URL/v1/objects/external-parity-groups
```

Request message

Object ID

None.

Query parameters

None.

Body

None.

Response message

Body

```
{
  "data": [
    {
      "externalParityGroupId": "1-1",
      "numOfLdevs": 1,
      "usedCapacityRate": 100,
      "availableVolumeCapacity": 0,
      "emulationType": "OPEN-V",
    }
  ]
}
```

```

    "clprId": 0,
    "externalProductId": "DF600F"
  },
  {
    "externalParityGroupId": "1-2",
    "numOfLdevs": 1,
    "usedCapacityRate": 100,
    "availableVolumeCapacity": 0,
    "emulationType": "OPEN-V",
    "clprId": 0,
    "externalProductId": "DF600F"
  }
]
}

```

Attribute	Type	Description
externalParityGroupId	string	External parity group number
numOfLdevs	int	Number of LDEVs allocated to the external parity group
usedCapacityRate	int	Usage rate of the external parity group
availableVolumeCapacity	long	Available capacity (free space) If the capacity is below 1 GB, the value is ignored and 0 is assumed.
emulationType	string	Emulation type of the external parity group
clprId	int	Number of CLPR to which the external parity group belongs
externalProductId	string	Storage system that is connected using the external storage connection functionality of Universal Volume Manager

Status codes

For details on the status codes of the request for this operation, see the description on HTTP status codes.

Coding example

```

curl -v -H "Accept:application/json" -H "Content-Type:application/json" -H
"Authorization:Session d7b673af189048468c5af9bcf3b6bb6f" -X GET https://
192.0.2.100/ConfigurationManager/v1/objects/external-parity-groups

```

Getting information about a specific external parity group

The following request gets information about a specific external parity group by specifying the external parity group number.

Execution permission

Storage Administrator (View Only)

Request line

```
GET base-URL/v1/objects/external-parity-groups/object-ID
```

Request message

Object ID

Specify the value of `externalParityGroupId` that was obtained by the processing to get information about the external parity group.

Attribute	Type	Description
externalParityGroupId	string	(Required) External parity group number

Query parameters

None.

Body

None.

Response message

Body

```
{
  "externalParityGroupId": "1-1",
  "numOfLdevs": 1,
  "usedCapacityRate": 100,
  "availableVolumeCapacity": 0,
  "emulationType": "OPEN-V",
  "clprId": 0,
  "externalProductId": "DF600F",
  "spaces": [
    {
      "partitionNumber": 0,
      "ldevId": 204,
      "status": "NML",

```



```

    "lbaLocation": "0x000000000000",
    "lbaSize": "0x000002800500"
  }
]
}

```

Attribute	Type	Description
externalParityGroupId	string	External parity group number
numOfLdevs	int	Number of LDEVs allocated to the external parity group
usedCapacityRate	int	Usage rate of the external parity group
availableVolumeCapacity	long	Available capacity (free space) If the capacity is below 1 GB, the value is ignored and 0 is assumed.
emulationType	string	Emulation type of the external parity group
clprId	int	Number of CLPR to which the external parity group belongs
externalProductId	string	Storage system that is connected using the external storage connection functionality of Universal Volume Manager

Attribute	Type	Description
spaces	objects[]	<p>For the free space and the LDEV defined in the specified external parity group, the following attributes are output:</p> <ul style="list-style-type: none"> ▪ partitionNumber (long) Number of a partition created as a result of partitioning of an external parity group ▪ ldevId (int) LDEV number ▪ status (string) LDEV status <ul style="list-style-type: none"> • NML: The LDEV is implemented, or the free space is determined. • REG: The LDEV is being created. • DEL: The LDEV is being deleted. ▪ lbaLocation (string) Starting location of the LBA of the partition in the external parity group (in a multiple of 512 bytes) ▪ lbaSize (string) Size of the partition in the external parity group (in a multiple of 512 bytes)

Status codes

For details on the status codes of the request for this operation, see the description on HTTP status codes.

Coding example

```
curl -v -H "Accept:application/json" -H "Content-Type:application/json" -H
"Authorization:Session d7b673af189048468c5af9bcf3b6bb6f" -X GET https://
192.0.2.100/ConfigurationManager/v1/objects/external-parity-groups/1-1
```

Assigning external parity groups to a CLPR

The following request assigns external parity groups to a CLPR. You can use this API function to assign external parity groups to a created CLPR or to move an already assigned external parity group to a different CLPR.

Execution permission

Storage Administrator (System Resource Management)

Request line

```
POST base-URL/v1/objects/external-parity-groups/object-ID/actions/assign-clpr/invoke
```

Request message

Object ID

Specify the value of `externalParityGroupId` that was obtained by the processing to get information about external parity groups.

Attribute	Type	Description
externalParityGroupId	string	(Required) External parity group number

Query parameters

None.

Body

```
{
  "parameters": {
    "clprId": 2
  }
}
```

Attribute	Type	Description
clprId	int	(Required) CLPR ID of the CLPR to which the external parity group is to be assigned Specify a decimal (base 10) number in the range from 0 to 31.

Response message**Body**

A job object is returned. For details on attributes other than `affectedResources`, see the description of job objects.

Attribute	Description
<code>affectedResources</code>	URL of the external parity group that was assigned to the CLPR

Action template

```
GET base-URL/v1/objects/external-parity-groups/object-ID/actions/assign-clpr
```

Status codes

For details on the status codes of the request for this operation, see the description of HTTP status codes.

Coding example

To get an action template:

```
curl -v -H "Accept:application/json" -H "Content-Type:application/json" -H
"Authorization:Session d7b673af189048468c5af9bcf3bbbb6f" -X GET https://
192.0.2.100/ConfigurationManager/v1/objects/external-parity-groups/1-1/
actions/assign-clpr
```

To run the request after getting an action template:

```
curl -v -H "Accept:application/json" -H "Content-Type:application/json" -H
"Authorization:Session d7b673af189048468c5af9bcf3bbbb6f" -X POST --data-
binary @./InputParameters.json https://192.0.2.100/ConfigurationManager/v1/
objects/external-parity-groups/1-1/actions/assign-clpr/invoke
```

Changing the MP blade assigned to an external parity group

The following request changes the MP blade assigned to an external parity group.

Execution permission

Storage Administrator (System Resource Management)

Request line

```
POST base-URL/v1/objects/external-parity-groups/object-ID/actions/assign-mp-blade/invoke
```

Request message**Object ID**

Specify the `externalParityGroupId` value obtained by getting information about the external parity group.

Attribute	Type	Description
<code>externalParityGroupId</code>	string	(Required) External parity group number

Query parameters

None.

Body

```
{
  "parameters": {
    "mpBladeId": 1
  }
}
```

Attribute	Type	Description
<code>mpBladeId</code>	int	(Required) The blade number of the MP blade to be assigned to the external parity group

Response message**Body**

A job object is returned. For details about attributes other than `affectedResources`, see the description of job objects.

Attribute	Description
<code>affectedResources</code>	URL of the external parity group for which the MP blade was changed

Attribute	Description
	To check changed setting values, execute the API request for getting information about the external path groups.

Action template

None.

Status codes

For details about the status codes of the request for this operation, see the description of the HTTP status codes.

Coding example

```
curl -v -H "Accept:application/json" -H "Content-Type:application/json" -H
"Authorization:Session d7b673af189048468c5af9bcf3b6bb6f" -X POST --data-
binary @./InputParameters.json https://192.0.2.100/ConfigurationManager/v1/
objects/external-parity-groups/3-1/actions/assign-mp-blade/invoke
```

Getting a list of Server Priority Manager information

The following request gets a list of Server Priority Manager information for which operations can be performed by using the REST API. You can check the Server Priority Manager information of hosts for which the LDEV numbers of volumes and the WWNs or iSCSI names of the HBAs have been set.

Execution permission

Storage Administrator (View Only)

Request line

```
GET base-URL/v1/objects/io-control-ldev-wwns-iscsis
```

Request message**Object ID**

None.

Query parameters

Parameter	Type	Filter Condition
ldevId	int	(Optional) Specify the LDEV number as a decimal (base 10) number.
hostWwn	string	(Optional) WWN of the HBA Specify a hexadecimal number consisting of 16 characters.
iscsiName	string	(Optional) iSCSI name of the HBA (iSCSI initiator) Specify the name in iqn format or eui format. <ul style="list-style-type: none"> ▪ iqn format Specify a value consisting of 5 to 223 characters. You can use the following characters: Alphanumeric characters, hyphens (-), periods (.), and colons (:) Specification example: iqn.rest.example.of.iqn.form ▪ eui format Specify eui. followed by a hexadecimal number. The specified value must consist of a total of 20 characters. Specification example: eui.0900ABDC32598D26

Body

None.

Response message**Body**

```
{
  "data" : [ {
    "ioControlLdevWwnIscsiId" : "0,210003e08b0256f9",
    "ldevId" : 0,
    "hostWwn" : "210003e08b0256f9",
    "priority" : "NonPrioritize",
    "upperLimitForIops" : 9999
  }, {
    "ioControlLdevWwnIscsiId" : "1,210003e08b0256f9",
    "ldevId" : 1,
    "hostWwn" : "210003e08b0256f9",
    "priority" : "NonPrioritize",
    "upperLimitForIops" : 9999
  }
]
```

```

}, {
  "ioControlLdevWwnIscsiId" : "2,iqn.myrestapiiscsi20150907",
  "ldevId" : 2,
  "iscsiName" : "iqn.myrestapiiscsi20150907",
  "priority" : "NonPrioritize",
  "upperLimitForTransferRate" : 30
}, {
  "ioControlLdevWwnIscsiId" : "3,iqn.myrestapiiscsi20150907",
  "ldevId" : 3,
  "iscsiName" : "iqn.myrestapiiscsi20150907",
  "priority" : "NonPrioritize",
  "upperLimitForTransferRate" : 30
} ]
}

```

Attribute	Type	Description
ioControlLdevWwnIscsiId	string	Object ID of the SPM information
ldevId	int	LDEV number
hostWwn	string	WWN of the HBA
iscsiName	string	iSCSI name of the HBA (iSCSI initiator)
priority	string	Prioritized or not prioritized The value of the SPM setting is output. <ul style="list-style-type: none"> ▪ Prioritize: Prioritized ▪ NonPrioritize: Not prioritized
upperLimitForIops	int	Upper limit on IOPS
upperLimitForTransferRate	int	Upper limit on the transfer rate (MBps)

Status codes

For details on the status codes of the request for this operation, see the description of HTTP status codes.

Coding example

```

curl -v -H "Accept:application/json" -H "Content-Type:application/json" -H
"Authorization:Session d7b673af189048468c5af9bcf3b6bb6f" -X GET https://
192.0.2.100/ConfigurationManager/v1/objects/io-control-ldev-wwns-iscsis/

```

Getting Server Priority Manager information by specifying a volume and the WWN or iSCSI name of an HBA

The following request allows you to get Server Priority Manager information by specifying the LDEV number of a volume and the WWN or iSCSI name of an HBA.

Execution permission

Storage Administrator (View Only)

Request line

```
GET base-URL/v1/objects/io-control-ldev-wwns-iscsis/object-ID
```

Request message

Object ID

Specify the value of `ioControlLdevWwnIscsiId` that was obtained by the processing to get the Server Priority Manager list. You can also specify the following attributes, delimited by commas:

For the WWN:

```
ldevId,hostWwn
```

For the iSCSI name:

```
ldevId,iscsiName
```

Attribute	Type	Description
<code>ldevId</code>	int	(Required) Specify the LDEV number as a decimal (base 10) number.
<code>hostWwn</code>	string	(Optional) WWN of the HBA Specify a hexadecimal number consisting of 16 characters. You must specify either the <code>hostWwn</code> attribute or the <code>iscsiName</code> attribute.
<code>iscsiName</code>	string	(Optional) iSCSI name of the iSCSI initiator

Attribute	Type	Description
		<p>Specify the name in iqn format or eui format.</p> <ul style="list-style-type: none"> iqn format Specify a value consisting of 5 to 223 characters. You can use the following characters: Alphanumeric characters, hyphens (-), periods (.), and colons (:) Specification example: <code>iqn.rest.example.of.iqn.form</code> eui format Specify eui. followed by a hexadecimal number. The specified value must consist of a total of 20 characters. Specification example: <code>eui.0900ABDC32598D26</code> <p>You must specify either the <code>hostWwn</code> attribute or the <code>iscsiName</code> attribute.</p>

Query parameters

None.

Body

None.

Response message

Body

```
{
  "ioControlLdevWwnIscsiId" : "0,210003e08b0256f9",
  "ldevId" : 0,
  "hostWwn" : "210003e08b0256f9",
  "priority" : "NonPrioritize",
  "upperLimitForTransferRate" : 30
}
```

Attribute	Type	Description
<code>ioControlLdevWwnIscsiId</code>	string	Object ID of the SPM information
<code>ldevId</code>	int	LDEV number
<code>hostWwn</code>	string	WWN of the HBA

Attribute	Type	Description
iscsiName	string	iSCSI name of the HBA (iSCSI initiator)
priority	string	Prioritized or not prioritized The value of the SPM setting is output. <ul style="list-style-type: none">▪ <code>Prioritize</code>: Prioritized▪ <code>NonPrioritize</code>: Not prioritized
upperLimitForIops	int	Upper limit on IOPS
upperLimitForTransferRate	int	Upper limit on the transfer rate (MBps)

Status codes

For details on the status codes of the request for this operation, see the description of HTTP status codes.

Coding example

```
curl -v -H "Accept:application/json" -H "Content-Type:application/json" -H "Authorization:Session d7b673af189048468c5af9bcf3b66b6f" -X GET https://192.0.2.100/ConfigurationManager/v1/objects/io-control-ldev-wwns-iscsis/0,210003e08b0256f9
```

Setting Server Priority Manager information by specifying a volume and the WWN or iSCSI name of the HBA

The following request sets, in Server Priority Manager, the upper limit on the transfer rate or IOPS of a low-priority host by specifying the LDEV number of the volume and the WWN or iSCSI name of the HBA.



Note:

If the number of volumes for which Server Priority Manager has been configured exceeds 4,096, the hosts of volumes configured after the 4,096th volume will have lower I/O response than the hosts of the first 4,096 volumes to be configured.

Make sure the number of volumes for which Server Priority Manager has been configured does not exceed 4,096.

Execution permission

Storage Administrator (System Resource Management)

Request line

```
POST base-URL/v1/objects/io-control-ldev-wwns-iscsis
```

Request message

Object ID

None.

Query parameters

None.

Body

The following coding example sets the upper limit on IOPS:

```
{
  "ldevId" : 0,
  "hostWwn" : "210003e08b0256f9",
  "upperLimitForIops" : 9999
}
```

The following coding example sets the upper limit on the transfer rate:

```
{
  "ldevId" : 0,
  "iscsiName" : "iqn.myrestapiiscsi20150907",
  "upperLimitForTransferRate" : 30
}
```

Attribute	Type	Description
ldevId	int	(Required) Specify the LDEV number as a decimal (base 10) number.
hostWwn	string	(Optional) WWN of the HBA Specify a hexadecimal number consisting of 16 characters. You must specify either the <code>hostWwn</code> attribute or the <code>iscsiName</code> attribute.
iscsiName	string	(Optional) iSCSI name of the HBA (iSCSI initiator)

Attribute	Type	Description
		<p>Specify the name in iqn format or eui format.</p> <ul style="list-style-type: none"> ▪ iqn format <p>Specify a value consisting of 5 to 223 characters. You can use the following characters:</p> <p>Alphanumeric characters, hyphens (-), periods (.), and colons (:)</p> <p>Specification example: iqn.rest.example.of.iqn.form</p> ▪ eui format <p>Specify eui. followed by a hexadecimal number. The specified value must consist of a total of 20 characters.</p> <p>Specification example: eui.0900ABDC32598D26</p> <p>You must specify either the <code>hostWwn</code> attribute or the <code>iscsiName</code> attribute.</p>
<code>upperLimitForIops</code>	int	<p>(Optional) Upper limit on the IOPS (IOPS)</p> <p>Specify a value in the range from 1 to 65535.</p> <p>You must specify either the <code>upperLimitForIops</code> attribute or the <code>upperLimitForTransferRate</code> attribute.</p>
<code>upperLimitForTransferRate</code>	int	<p>(Optional) Upper limit on the transfer rate (MBps)</p> <p>Specify a value in the range from 1 to 31.</p> <p>You must specify either the <code>upperLimitForIops</code> attribute or the <code>upperLimitForTransferRate</code> attribute.</p>

Response message

Body

A job object is returned. For details on attributes other than `affectedResources`, see the description of job objects.

Attribute	Description
affectedResources	URL of the specified SPM information

Status codes

For details on the status codes of the request for this operation, see the description of HTTP status codes.

Coding example

```
curl -v -H "Accept:application/json" -H "Content-Type:application/json" -H
"Authorization:Session d7b673af189048468c5af9bcf3b66b6f" -X POST --data-
binary @./InputParameters.json https://192.0.2.100/ConfigurationManager/v1/
objects/io-control-ldev-wwns-iscsi/
```

Changing the Server Priority Manager information

The following request changes the upper limit on the transfer rate or IOPS for hosts for which the LDEV number of a volume and the WWN or iSCSI name of the HBA are already specified in Server Priority Manager.

Execution permission

Storage Administrator (System Resource Management)

Request line

```
PATCH base-URL/v1/objects/io-control-ldev-wwns-iscsi/object-ID
```

Request message

Object ID

Specify the value of `ioControlLdevWwnIscsiId` that was obtained by the processing to get the Server Priority Manager list. You can also specify the following attributes, delimited by commas:

For the WWN:

```
ldevId,hostWwn
```

For the iSCSI name:

```
ldevId,iscsiName
```

Attribute	Type	Description
ldevId	int	(Required) Specify the LDEV number as a decimal (base 10) number.
hostWwn	string	(Optional) WWN of the HBA Specify a hexadecimal number consisting of 16 characters. You must specify either the <code>hostWwn</code> attribute or the <code>iscsiName</code> attribute.
iscsiName	string	(Optional) iSCSI name of the iSCSI initiator Specify the name in iqn format or eui format. <ul style="list-style-type: none"> ▪ iqn format Specify a value consisting of 5 to 223 characters. You can use the following characters: Alphanumeric characters, hyphens (-), periods (.), and colons (:) Specification example: <code>iqn.rest.example.of.iqn.form</code> ▪ eui format Specify eui. followed by a hexadecimal number. The specified value must consist of a total of 20 characters. Specification example: <code>eui.0900ABDC32598D26</code> You must specify either the <code>hostWwn</code> attribute or the <code>iscsiName</code> attribute.

Query parameters

None.

Body

The following coding example changes the upper limit on IOPS:

```
{
  "upperLimitForIops" : 9999
}
```

The following coding example changes the upper limit on the transfer rate:

```
{
  "upperLimitForTransferRate": 30
}
```

Attribute	Type	Description
upperLimitForIops	int	(Optional) Upper limit (IOPS) Specify a value in the range from 1 to 65535. You must specify either the <code>upperLimitForIops</code> attribute or the <code>upperLimitForTransferRate</code> attribute.
upperLimitForTransferRate	int	(Optional) Upper limit (transfer rate in MBps) Specify a value in the range from 1 to 31. You must specify either the <code>upperLimitForIops</code> attribute or the <code>upperLimitForTransferRate</code> attribute.

Response message

Body

A job object is returned. For details on attributes other than `affectedResources`, see the description of job objects.

Attribute	Description
<code>affectedResources</code>	URL of the changed SPM information

Action template

None.

Status codes

For details on the status codes of the request for this operation, see the description of HTTP status codes.

Coding example

```
curl -v -H "Accept:application/json" -H "Content-Type:application/json" -H
"Authorization:Session d7b673af189048468c5af9bcf3b66b6f" -X PATCH --data-
binary @./InputParameters.json https://192.0.2.100/ConfigurationManager/v1/
objects/io-control-ldev-wwns-isctis/0,210003e08b0256f9
```

Deleting Server Priority Manager information

The following request allows you to remove the currently set upper limit on the transfer rate or IOPS of a host by specifying the LDEV number of a volume and the WWN or iSCSI name of the HBA, to remove the host from the management targets of Server Priority Manager.

Execution permission

Storage Administrator (System Resource Management)

Request line

```
DELETE base-URL/v1/objects/io-control-ldev-wwns-iscsis/object-ID
```

Request message

Object ID

Specify the value of `ioControlLdevWwnIscsiId` that was obtained by the processing to get the Server Priority Manager list. You can also specify the following attributes, delimited by commas:

For the WWN:

```
ldevId,hostWwn
```

For the iSCSI name:

```
ldevId,iscsiName
```

Attribute	Type	Description
<code>ldevId</code>	int	(Required) Specify the LDEV number as a decimal (base 10) number.
<code>hostWwn</code>	string	(Optional) WWN of the HBA Specify a hexadecimal number consisting of 16 characters. You must specify either the <code>hostWwn</code> attribute or the <code>iscsiName</code> attribute.
<code>iscsiName</code>	string	(Optional) iSCSI name of the HBA (iSCSI initiator)

Attribute	Type	Description
		<p>Specify the name in iqn format or eui format.</p> <ul style="list-style-type: none"> iqn format <p>Specify a value consisting of 5 to 223 characters. You can use the following characters:</p> <p>Alphanumeric characters, hyphens (-), periods (.), and colons (:)</p> <p>Specification example: iqn.rest.example.of.iqn.form</p> <ul style="list-style-type: none"> eui format <p>Specify eui. followed by a hexadecimal number. The specified value must consist of a total of 20 characters.</p> <p>Specification example: eui.0900ABDC32598D26</p> <p>You must specify either the <code>hostWwn</code> attribute or the <code>iscsiName</code> attribute.</p>

Query parameters

None.

Body

None.

Response message**Body**

A job object is returned. For details on attributes other than `affectedResources`, see the description of job objects.

Attribute	Description
<code>affectedResources</code>	URL of the deleted SPM information

Status codes

For details on the status codes of the request for this operation, see the description of HTTP status codes.

Coding example

```
curl -v -H "Accept:application/json" -H "Content-Type:application/json" -H
"Authorization:Session d7b673af189048468c5af9bcf3bbbb6f" -X DELETE
```

```
https://192.0.2.100/ConfigurationManager/v1/objects/io-control-ldev-wwns-iscsis/0,210003e08b0256f9
```

Chapter 8: Managing ShadowImage pairs

This chapter describes how to perform operations on ShadowImage pairs by using the REST API.

Overview of ShadowImage

ShadowImage creates a copy of a data volume in the same storage system as the copy source.

You can create a ShadowImage pair or manage the pair status by issuing an API from a REST API client. You can also operate ShadowImage pairs in units of copy groups. In addition, if you define a consistency group, the pair statuses of all pairs in the group are transited at the same time.

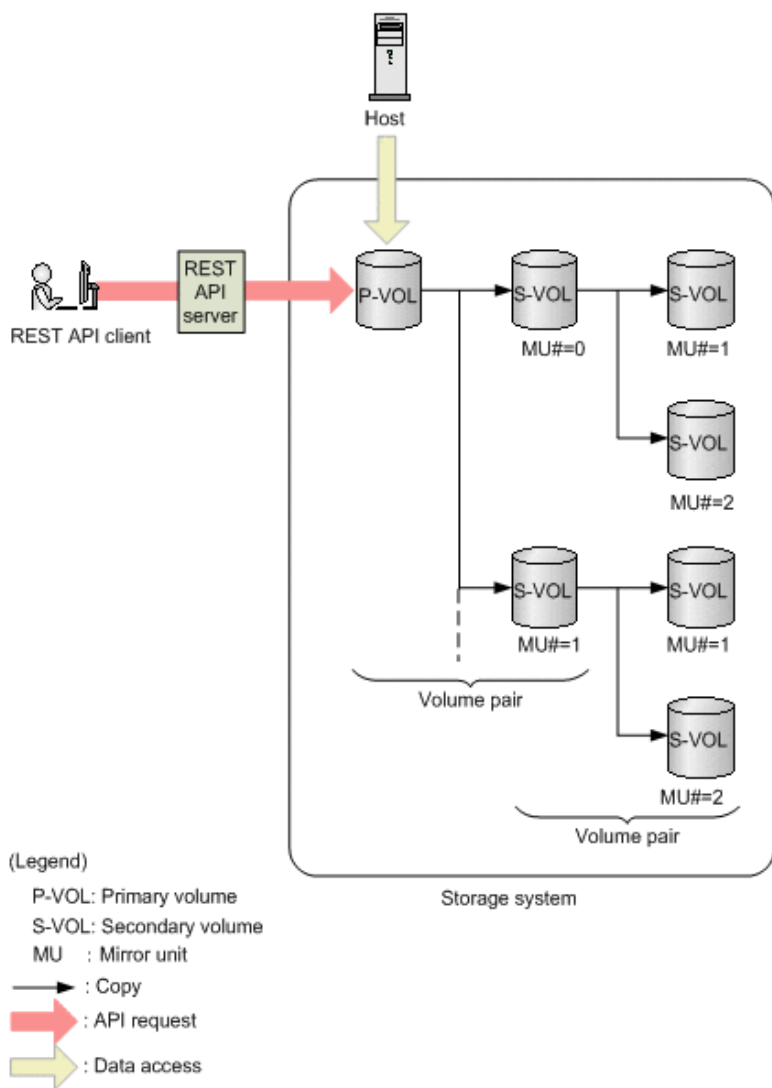

A ShadowImage pair consists of a primary volume (P-VOL) and a secondary volume (S-VOL). The primary volume can be paired with more than one secondary volume. Each secondary volume is managed according to the MU (mirror unit) number.

For details about ShadowImage, see the *Hitachi ShadowImage® User Guide*.

Workflow for operating ShadowImage pairs

The following shows the ShadowImage functions that can be run by the REST API:

- Getting information about copy groups

Obtains a list of copy groups registered in the target storage system. You can also obtain information about a specific copy group.

- Getting pair status and configuration information

Obtains a ShadowImage pair status and configuration information. You can check if a pair operation is complete. You can also obtain pair information in units of copy groups.

If the copy group in which the target ShadowImage pair is registered contains a ShadowImage pair that was created or deleted by using another REST API server or software other than the REST API, correct information about that pair might not be obtained. In such a case, update the information about the pairs to the most recent information before you obtain information.

- Creating a pair

Creates a new ShadowImage pair in a copy group of the target storage system. A copy group is a group made up of copy pairs. Each copy group consists of a device group made up of primary volumes, and a device group made up of secondary volumes. If the copy group is not already created, the copy group and its corresponding device groups are automatically created. You will be able to perform operations in units of copy groups by registering ShadowImage pairs in a copy group.

To create a pair in a new copy group:

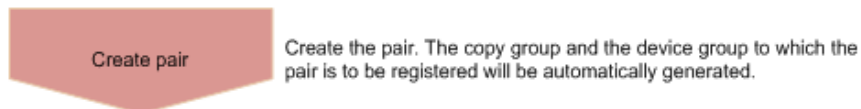

To create a pair in an existing copy group:

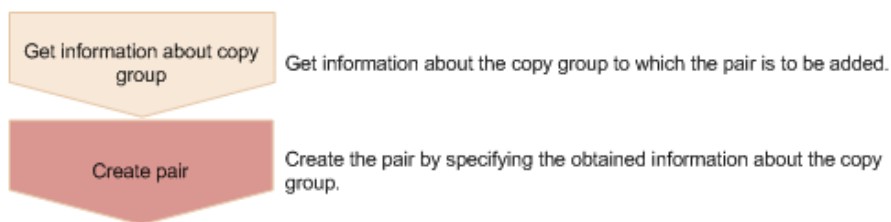

- Splitting a pair

Splits a ShadowImage pair and enables read and write access for a secondary volume. You can also split pairs in units of copy groups.

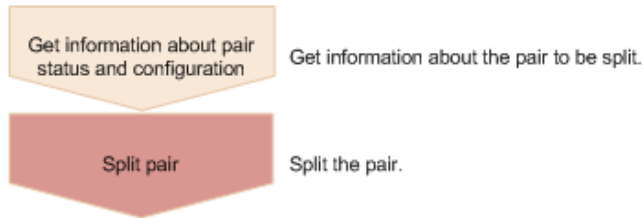

- Resynchronizing a pair

Resynchronizes a split ShadowImage pair based on the primary volume. Even during resynchronization, you can access the P-VOL. You can also resynchronize pairs in units of copy groups.

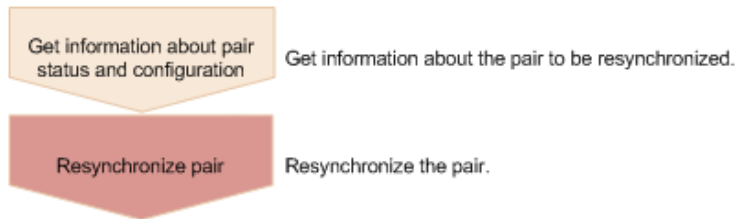

- Resynchronizing a pair by a restore

Resynchronizes a split ShadowImage pair based on a secondary volume. During resynchronization by a restore, you cannot access the P-VOL. You can also perform a restore in units of copy groups.

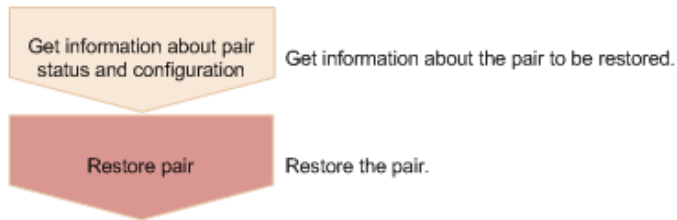

- Deleting a pair

Deletes a ShadowImage pair that is unnecessary. If you delete a pair, the pair is dissolved. The data in the primary volume and secondary volume remains unchanged. In addition, if you delete all the ShadowImage pairs in a copy group, the copy group and the device group included in the copy group are automatically deleted. You can also delete pairs in units of copy groups.

You can delete a pair at any time regardless of the pair status. However, if you delete a pair while the pair status is being changed, the pair might be deleted before its status is changed, and the request to change the pair status might time out.

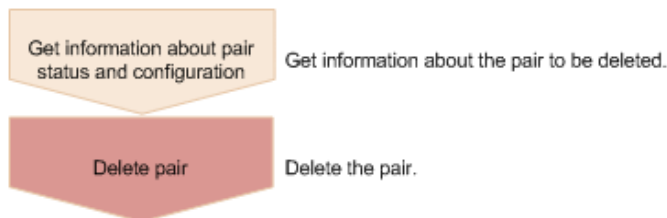



Specifying Job-Mode-Wait-Configuration-Change in the request header

During the creation, splitting, and resynchronizing of pairs, if multiple asynchronous processing requests are issued at the same time, jobs might get stuck and the job status might not change to `Completed` because data copying takes a long time. In such cases, specify `Job-Mode-Wait-Configuration-Change:NoWait` in the request header so that the job status changes to `Completed` without waiting for data copying to finish, and the next job starts. At this time, data copying continues even after job execution ends. To check whether data copying has finished, check the pair status of the target resource instead of the job status. For details about the pair status, see the description of the pair status transitions.

Pair status (ShadowImage)

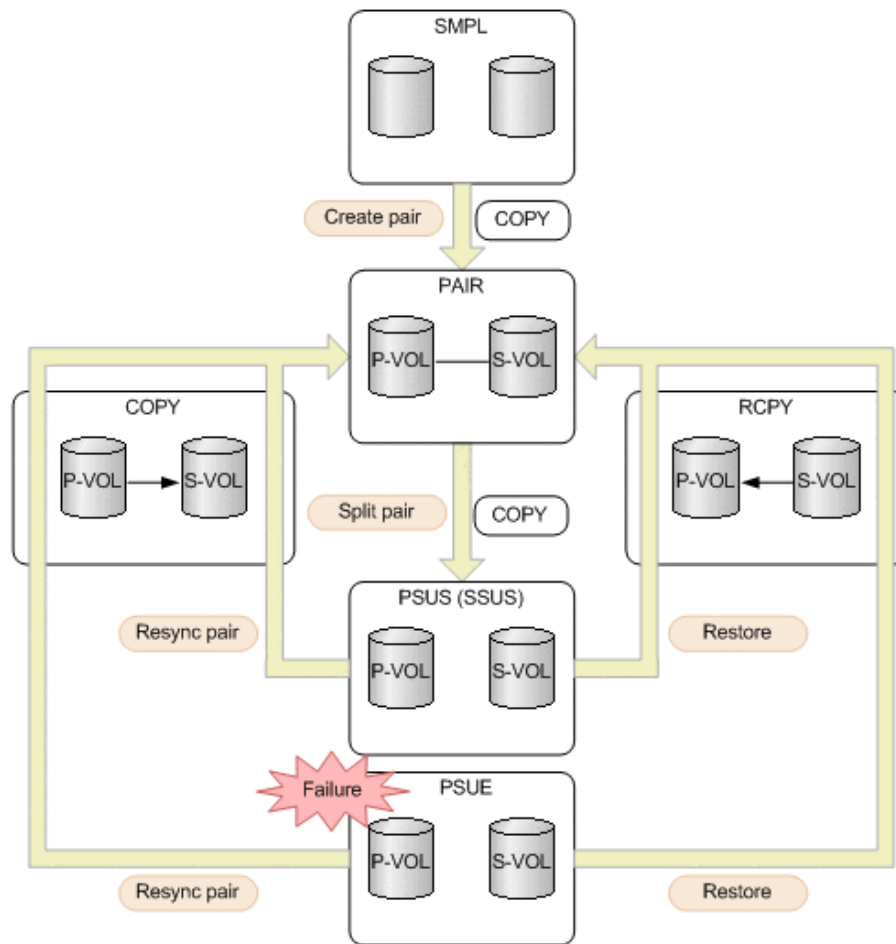
The following explains the operations and status transitions for pairs.



(Legend)
 P-VOL: Primary volume
 S-VOL: Secondary volume
 : Indicates a pair operation performed from the REST API
 : Indicates the pair status

Pair status	Description	Access to the P-VOL	Access to the S-VOL
SMPL	Unpaired volumes	-	-
COPY	The pair is being created. An initial copy or resynchronization is being performed.	R/W enabled	R enabled
PAIR	Paired volumes The initial copy is complete. The update data of the P-VOL will be asynchronously copied to the S-VOL.	R/W enabled	R enabled

Pair status	Description	Access to the P-VOL	Access to the S-VOL
PSUS	The pair is being split by operation. (This value is output for the P-VOL.)	R/W enabled	R/W enabled
SSUS	The pair is being split by operation. (This value is output for the S-VOL when the P-VOL is PSUS.)	R/W enabled	R/W enabled
PSUE	The pairing is suspended due to a failure. The P-VOL and the S-VOL are not synchronized.	R/W enabled	R enabled
RCPY	A restore operation is being performed. (Data is being copied from the S-VOL to the P-VOL.)	Not enabled	R enabled

If you delete a pair, the pair status changes to SMPL.



Note:

In the following cases, if you perform an operation on a pair, the request successfully returns a response, but the details specified in the request body are not actually applied:

- When you perform a pair splitting operation on a pair for which the status is PSUS or SSUS
- When you perform a pair resynchronization operation on a pair for which the status is COPY, PAIR, or RCPY

Getting a list of copy groups

The following request gets information about the copy groups containing ShadowImage pairs in the storage system.



Important:

If the copy group name or device group name contains spaces, the copy group information cannot be obtained.

Execution permission

Storage Administrator (View Only)

Request line

```
GET base-URL/v1/objects/local-clone-copygroups
```

Request message**Object ID**

None.

Query parameters

None.

Body

None.

Response message**Body**

```
{
  "data": [
    {
      "copyGroupName": "localCopyGroup1",
      "pvolDeviceGroupName": "localCopyGroup1P_",
      "svolDeviceGroupName": "localCopyGroup1S_",
      "localCloneCopygroupId": "localCopyGroup1,localCopyGroup1P_,
localCopyGroup1S_"
    },
    {
      "copyGroupName": "localCopyGroup2",
      "pvolDeviceGroupName": "localCopyGroupppvol",
      "svolDeviceGroupName": "localCopyGroupsvol",
      "localCloneCopygroupId": "localCopyGroup2,localCopyGroupppvol,
localCopyGroupsvol"
    }
  ]
}
```

Attribute	Type	Description
copyGroupName	string	Copy group name
pvolDeviceGroupName	string	Device group name for the P-VOL
svolDeviceGroupName	string	Device group name for the S-VOL
localCloneCopygroupId	string	Object ID of the copy group that contains a ShadowImage pair

Attribute	Type	Description
		<p>The following attributes are output, separated by commas:</p> <ul style="list-style-type: none"> ▪ copyGroupName ▪ pvolDeviceGroupName ▪ svolDeviceGroupName

Status codes

For details on the status codes of the request for this operation, see the section explaining HTTP status codes.

Coding example

```
curl -v -H "Accept: application/json" -H "Authorization:Session
d7b673af189048468c5af9bcf3bbbb6f" -X GET https://192.0.2.100/
ConfigurationManager/v1/objects/local-clone-copygroups
```

Getting information about a specific copy group

The following request gets information about the specified copy group. This request also gets information about ShadowImage pairs included in the copy group. The request can be used to check the pair status or get configuration information about the pairs.



Important:

- If the target copy group contains a ShadowImage pair that was created or deleted by using another REST API server or software other than the REST API, correct information about that pair might not be obtained. To obtain the most recent information about such pairs, use the API for obtaining a list of ShadowImage pairs.
- If the copy group name, device group name, or copy pair name contains spaces, the information cannot be obtained.

Execution permission

Storage Administrator (View Only)

Request line

```
GET base-URL/v1/objects/local-clone-copygroups/object-ID
```

Request message**Object ID**

Specify the `localCloneCopygroupId` value obtained by getting the list of copy groups. You can also specify the following attributes and connect them with commas:

```
copyGroupName,pvolDeviceGroupName,svolDeviceGroupName
```

Attribute	Type	Description
<code>copyGroupName</code>	string	(Required) Specify the copy group name. Value should not exceed 31 characters. The name is case sensitive.
<code>pvolDeviceGroupName</code>	string	(Required) Specifies the device group name for the P-VOL. Value should not exceed 31 characters. The name is case sensitive.
<code>svolDeviceGroupName</code>	string	(Required) Specifies the device group name for the S-VOL. Value should not exceed 31 characters. The name is case sensitive.

Query parameters

None.

Body

None.

Response message**Body**

```
{
  "localCloneCopygroupId" : "localCopyGroup1,localCopyGroup1P_,
localCopyGroup1S_",
  "copyGroupName" : "localCopyGroup1",
  "pvolDeviceGroupName" : "localCopyGroup1P_",
  "svolDeviceGroupName" : "localCopyGroup1S_",
  "copyPairs" : [ {
    "localCloneCopypairId" : "localCopyGroup1,localCopyGroup1P_,
localCopyGroup1S_,pair1",
    "copyGroupName" : "localCopyGroup1",
    "copyPairName" : "pair1",
    "replicationType" : "SI",
    "copyMode" : "NotSnapshot",
    "copyProgressRate" : 100,
    "pvolLdevId" : 10,
```

```

    "pvolStatus" : "PAIR",
    "svolLdevId" : 20,
    "svolStatus" : "PAIR",
    "pvolMuNumber" : 0
  }, {
    "localCloneCopypairId" : "localCopyGroup1,localCopyGroup1P_,
localCopyGroup1S_,pair2",
    "copyGroupName" : "localCopyGroup1",
    "copyPairName" : "pair2",
    "replicationType" : "SI",
    "copyMode" : "NotSnapshot",
    "copyProgressRate" : 100,
    "pvolLdevId" : 30,
    "pvolStatus" : "PAIR",
    "svolLdevId" : 40,
    "svolStatus" : "PAIR",
    "pvolMuNumber" : 0
  } ]
}

```

Attribute	Type	Description
copyGroupName	string	Copy group name
pvolDeviceGroupName	string	Device group name for the P-VOL
svolDeviceGroupName	string	Device group name for the S-VOL
localCloneCopygroupId	string	Object ID of the copy group that contains a ShadowImage pair The following attributes are output, separated by commas: <ul style="list-style-type: none"> ▪ copyGroupName ▪ pvolDeviceGroupName ▪ svolDeviceGroupName
copyPairs	object[]	The following attributes about the ShadowImage pairs included in the copy group: <ul style="list-style-type: none"> ▪ copyGroupName (string) Copy group name ▪ copyPairName (string) Copy pair name

Attribute	Type	Description
		<ul style="list-style-type: none"> <li data-bbox="813 254 1424 386">▪ replicationType (string) Pair type Outputs <code>SI</code> (ShadowImage). <li data-bbox="813 422 1424 554">▪ copyMode (string) Copy mode Outputs <code>NotSnapshot</code>. <li data-bbox="813 590 1424 751">▪ copyProgressRate (int) Copy progress rate (%) This attribute is not output if no information can be obtained. <li data-bbox="813 787 1424 869">▪ pvolLdevId (int) LDEV number of the P-VOL <li data-bbox="813 905 1424 987">▪ svolLdevId (int) LDEV number of the S-VOL <li data-bbox="813 1022 1424 1104">▪ pvolMuNumber (int) MU number of the P-VOL <li data-bbox="813 1140 1424 1388">▪ pvolStatus (string) Pair volume status of the P-VOL For details, see the section describing the pair status (ShadowImage). This attribute is not output if no information can be obtained. <li data-bbox="813 1423 1424 1671">▪ svolStatus (string) Pair volume status of the S-VOL For details, see the section describing the pair status (ShadowImage). This attribute is not output if no information can be obtained.

Attribute	Type	Description
		<ul style="list-style-type: none"> ▪ consistencyGroupId (int) Consistency group ID This attribute is not output if no consistency group consists. ▪ localCloneCopypairId (string) Object ID of the ShadowImage pair The following attributes are output, separated by commas: <ul style="list-style-type: none"> ▪ copyGroupName ▪ pvolDeviceGroupName ▪ svolDeviceGroupName ▪ copyPairName

Status codes

The following table describes the meaning of the status code of the request for this operation. For details on other status codes, see the section explaining HTTP status codes.

Status code	Message	Description
404	Not Found	No copy group can be obtained, or no pair was included in the copy group that was obtained.

Coding example

```
curl -v -H "Accept: application/json" -H "Authorization:Session
d7b673af189048468c5af9bcf3b66b6f" -X GET https://192.0.2.100/
ConfigurationManager/v1/objects/local-clone-copygroups/localCopyGroup1,
localCopyGroup1P_,localCopyGroup1S_
```

Getting a list of ShadowImage pairs

The following request obtains information about the ShadowImage pairs in a copy group specified by using query parameters. You can also update the pair information when you obtain information about ShadowImage pairs.

**Important:**

- If the target copy group contains a ShadowImage pair that was created or deleted by using another REST API server or software other than the REST API, information about that pair might not be obtained. To obtain the most recent information about such pairs, run the API with `refresh=true` specified for the query parameter. Note that such processing takes time because the information about the pairs in the specified copy group is updated, and then information is obtained.
- If the copy group name, device group name, or copy pair name contains spaces, the information cannot be obtained.

Execution permission

Storage Administrator (View Only)

Request lineGET *base-URL*/v1/objects/local-clone-copypairs**Request message****Object ID**

None.

Query parameters

Parameter	Type	Filter condition
localCloneCopyGroupId	string	(Required) Object ID of the copy group that contains a pair

Parameter	Type	Filter condition
		<p>Specify the <code>localCloneCopygroupId</code> value obtained by getting the list of copy groups. You can also specify the following attributes separated by a comma:</p> <p><i>copyGroupName, pvolDeviceGroupName, svolDeviceGroupName</i></p> <ul style="list-style-type: none"> ▪ <code>copyGroupName</code> (string) Copy group name Value should not exceed 31 characters. ▪ <code>pvolDeviceGroupName</code> (string) Device group name for the P-VOL Value should not exceed 31 characters. ▪ <code>svolDeviceGroupName</code> (string) Device group name for the S-VOL Value should not exceed 31 characters.
<code>refresh</code>	boolean	<p>(Optional) Whether to update the pair information to the most recent:</p> <ul style="list-style-type: none"> ▪ <code>true</code>: Pair information will be updated. ▪ <code>false</code>: Pair information will not be updated. <p>If you specify <code>true</code>, processing takes time because the information about the pairs in the specified copy group is updated and then information is obtained. If this parameter is omitted, <code>false</code> is assumed.</p>

Body

None.

Response message**Body**

Information about the pairs in the specified copy group is obtained in a list. For details about the response body, see the section describing the API for obtaining information about specific ShadowImage pairs.

Status codes

For details on the status codes of the request for this operation, see the section explaining HTTP status codes.

Coding example

```
curl -v -H "Accept: application/json" -H "Authorization:Session
d7b673af189048468c5af9bcf3bbbb6f" -X GET "https://192.0.2.100/
ConfigurationManager/v1/objects/local-clone-copypairs?
localCloneCopyGroupId=localCopyGroup1,localCopyGroup1P_,
localCopyGroup1S_&refresh=true"
```

Getting information about a specific ShadowImage pair

The following request gets information about the specified ShadowImage pair. This request can confirm whether a pair operation is finished based on the pair status, and can get configuration information such as the consistency group ID used when adding a pair.

**Important:**

- If the target ShadowImage pair was created or deleted by using another REST API server or software other than the REST API, correct information about that pair might not be obtained. To obtain the most recent information about the pairs, use the API for obtaining a list of ShadowImage pairs.
- If the copy group name, device group name, or copy pair name contains spaces, information cannot be obtained.

Execution permission

Storage Administrator (View Only)

Request line

```
GET base-URL/v1/objects/local-clone-copypairs/object-ID
```

Request message**Object ID**

Specify the `localCloneCopypairId` value obtained by getting the ShadowImage pair information. You can also specify the following attributes and connect them with commas:

```
copyGroupName, pvolDeviceGroupName, svolDeviceGroupName, copyPairName
```

Attribute	Type	Description
copyGroupName	string	(Required) Specify the copy group name. Value should not exceed 31 characters. The name is case sensitive.
pvolDeviceGroupName	string	(Required) Specify the P-VOL device group name. Value should not exceed 31 characters. The name is case sensitive.
svolDeviceGroupName	string	(Required) Specify the S-VOL device group name. Value should not exceed 31 characters. The name is case sensitive.
copyPairName	string	(Required) Specify the name of the copy pair. Value should not exceed 31 characters. The name is case sensitive.

Query parameters

None.

Body

None.

Response message**Body**

```
{
  "localCloneCopypairId" : "localCopyGroup1,localCopyGroup1P_,
localCopyGroup1S_,pair1",
  "copyGroupName" : "localCopyGroup1",
  "copyPairName" : "pair1",
  "replicationType" : "SI",
  "copyMode" : "NotSnapshot",
  "copyProgressRate" : 100,
  "pvolLdevId" : 10,
  "pvolStatus" : "PAIR",
  "svolLdevId" : 20,
  "svolStatus" : "PAIR",
  "pvolMuNumber" : 0
}
```

Attribute	Type	Description
copyGroupName	string	Copy group name
copyPairName	string	Copy pair name
replicationType	string	Pair type SI: ShadowImage
copyMode	string	Copy mode Outputs NotSnapshot.
copyProgressRate	int	Copy progress rate (%) This attribute is not output if no information can be obtained.
pvolLdevId	int	LDEV number of the P-VOL
svolLdevId	int	LDEV number of the S-VOL
pvolMuNumber	int	MU number of the P-VOL
pvolStatus	string	Pair volume status of the P-VOL For details, see the section describing the pair status (ShadowImage). This attribute is not output if no information can be obtained.
svolStatus	string	Pair volume status of the S-VOL For details, see the section describing the pair status (ShadowImage). This attribute is not output if no information can be obtained.
consistencyGroupId	int	Consistency group ID This attribute is not output if no consistency group consists.
localCloneCopypairId	string	Object ID of the ShadowImage pair

Attribute	Type	Description
		<p>The following attributes are output, separated by commas:</p> <ul style="list-style-type: none"> ▪ copyGroupName ▪ pvolDeviceGroupName ▪ svolDeviceGroupName ▪ copyPairName

Status codes

For details on the status codes of the request for this operation, see the section explaining HTTP status codes.

Coding example

```
curl -v -H "Accept: application/json" -H "Authorization:Session
d7b673af189048468c5af9bcf3bbbb6f" -X GET https://192.0.2.100/
ConfigurationManager/v1/objects/local-clone-copypairs/localCopyGroup1,
localCopyGroup1P_,localCopyGroup1S_,pair1
```

Creating a ShadowImage pair

The following request creates a ShadowImage pair in the target storage system. The ShadowImage pair is either added to a newly created copy group or to an existing copy group.



Tip: We recommend specifying `Job-Mode-Wait-Configuration-Change:NoWait` in the request header of this API function. For details, see the description of the flow of operations for the pairs.

Execution permission

Storage Administrator (Provisioning) and Storage Administrator (Local Copy)

Request line

```
POST base-URL/v1/objects/local-clone-copypairs
```

Request message

Object ID

None.

Query parameters

None.

Body

```
{
  "copyGroupName": "localCopyGroup1",
  "copyPairName": "pair1",
  "replicationType": "SI",
  "pvolLdevId": 10,
  "pvolMuNumber": 0,
  "svolLdevId": 20,
  "pvolDeviceGroupName": "localCopyGroup1P_",
  "svolDeviceGroupName": "localCopyGroup1S_",
  "isNewGroupCreation": true,
  "copyPace": 1,
  "isConsistencyGroup": true,
  "consistencyGroupId": 1,
  "quickMode": false,
  "autoSplit": false,
  "isDataReductionForceCopy": true
}
```

Attribute	Type	Description
copyGroupName	string	(Required) Specify the copy group name. Value should not exceed 29 characters. The name is case sensitive.
copyPairName	string	(Required) Specify the copy pair name. Value should not exceed 31 characters. The name is case sensitive.
replicationType	string	(Required) Specify <i>SI</i> (ShadowImage) as the pair type.
pvolLdevId	int	(Required) Specify the LDEV number of the P-VOL with a decimal (base 10) number.
svolLdevId	int	(Required) Specify the LDEV number of the S-VOL with a decimal (base 10) number.
pvolDeviceGroupName	string	(Optional) Specify the device group name for the P-VOL. Value should not exceed 31 characters. The name is case sensitive.

Attribute	Type	Description
		<p>Specify a device group name that differs from the device group name for the S-VOL. In addition, to add a ShadowImage pair to an existing copy group, specify the device group name for an existing P-VOL.</p> <p>If this value is omitted, <code>copyGroupNameP_</code> is assumed.</p>
svolDeviceGroupName	string	<p>(Optional) Specify the device group name for the S-VOL. Value should not exceed 31 characters. The name is case sensitive.</p> <p>Specify a device group name that differs from the device group name for the P-VOL. To add a ShadowImage pair to an existing copy group, specify the device group name for an existing S-VOL.</p> <p>If this value is omitted, <code>copyGroupNameS_</code> is assumed.</p>
isNewGroupCreation	boolean	<p>(Required) Depending on the value, this attribute specifies whether to add a ShadowImage pair to a newly created copy group or to an existing copy group.</p> <p>Make sure that the ShadowImage pair is not added to a copy group that includes Volume Migration pairs.</p> <ul style="list-style-type: none"> ▪ <code>true</code>: Adds the ShadowImage pair to a newly created copy group. ▪ <code>false</code>: Adds the ShadowImage pair to an existing copy group.
pvolMuNumber	int	<p>(Optional) Specify the MU number of the P-VOL.</p> <p>If you specify <code>true</code> for the <code>isNewGroupCreation</code> attribute, make sure to specify this attribute. If you specify <code>false</code> for the <code>isNewGroupCreation</code> attribute, you cannot specify this attribute.</p> <ul style="list-style-type: none"> ▪ If the S-VOL is in layer 1, specify a value in the range from 0 to 2. ▪ If the S-VOL is in layer 2, specify 1 or 2.

Attribute	Type	Description
copyPace	int	<p>(Optional) Specify a value in the range from 1 to 15 to be the copy speed. The larger the value, the higher the speed.</p> <p>If this value is omitted, 3 is assumed.</p>
isConsistencyGroup	boolean	<p>(Optional) Depending on the value, this attribute specifies whether to register the new pair in a consistency group. If a pair that is already registered in the consistency group exists in the copy group, you can register the new pair in the same consistency group.</p> <ul style="list-style-type: none"> ▪ <code>true</code>: Registers the pair in a consistency group. ▪ <code>false</code>: Does not register the pair in a consistency group. <p>When the value of the <code>autoSplit</code> attribute is <code>true</code>, you cannot specify <code>true</code> for this item.</p> <p>If this value is omitted, <code>false</code> is assumed.</p>
consistencyGroupId	int	<p>(Optional) To register the new pair in the consistency group, specify the consistency group ID (0 to 127). If a pair is already registered in a consistency group in a copy group, specify the ID of the consistency group to which the existing pair belongs.</p> <p>If you specify <code>true</code> for the <code>isConsistencyGroup</code> attribute and do not specify this attribute, a new consistency group ID is assigned.</p>
autoSplit	boolean	<p>(Optional) Depending on the value, this attribute specifies whether to split the pair automatically after the operation finishes.</p> <ul style="list-style-type: none"> ▪ <code>true</code>: Splits the pair after the operation finishes ▪ <code>false</code>: Does not split the pair after the operation finishes <p>When the value of the <code>isConsistencyGroup</code> attribute is <code>true</code>, you cannot specify <code>true</code> for this item.</p>

Attribute	Type	Description
		If this value is omitted, <code>false</code> is assumed.
<code>quickMode</code>	boolean	<p>(Optional) Specify whether to run in quick mode.</p> <ul style="list-style-type: none"> <code>true</code>: Performs execution in quick mode. <code>false</code>: Performs execution in normal mode. <p>You can specify <code>true</code> for this item only when the value of the <code>autoSplit</code> attribute is <code>true</code>.</p> <p>If this value is omitted, <code>false</code> is assumed.</p>
<code>isDataReductionForceCopy</code>	boolean	<p>(Optional) Specify whether to forcibly create a pair for the volume for which the capacity saving function (dedupe and compression) is enabled.</p> <ul style="list-style-type: none"> <code>true</code>: Forcibly create a pair[#] <code>false</code>: Do not forcibly create a pair <p>When the attribute is omitted, <code>false</code> is assumed.</p>

[#]: Copying data of the volume for which the capacity saving function (compression or deduplication) is enabled might take up to several months, depending on the amount of data. Be sure to take this into account when planning when to create such a pair.

Response message

Body

A job object is returned. For details on attributes other than `affectedResources`, see the section explaining job objects.

Attribute	Description
<code>affectedResources</code>	URL of the created ShadowImage pair

Status codes

For details on the status codes of the request for this operation, see the description on HTTP status codes.

Coding example

```
curl -v -H "Accept: application/json" -H "Content-Type: application/json" -
H "Authorization:Session d7b673af189048468c5af9bcf3b6bb6f" -X POST --data-
binary @./InputParameters.json https://192.0.2.100/ConfigurationManager/v1/
objects/local-clone-copypairs
```

Splitting ShadowImage pairs in units of copy groups

The following request splits the ShadowImage pairs included in the specified copy group. If the pair is split, data can be read from or written to the secondary volume.



Tip: We recommend specifying `Job-Mode-Wait-Configuration-Change:NoWait` in the request header of this API function. For details, see the description of the flow of operations for the pairs.



Note: The `forceSplit` attribute in the action template is unnecessary. When using the action template, remove this attribute before creating a request.

Execution permission

Storage Administrator (Local Copy)

Request line

```
POST base-URL/v1/objects/local-clone-copygroups/object-ID/actions/split/
invoke
```

Request message**Object ID**

Specify the `localCloneCopygroupId` value obtained by getting the list of copy groups. You can also specify the following attributes and connect them with commas:

```
copyGroupName, pvolDeviceGroupName, svolDeviceGroupName
```

Attribute	Type	Description
copyGroupName	string	(Required) Specify the copy group name. Value should not exceed 31 characters. The name is case sensitive.
pvolDeviceGroupName	string	(Required) Specify the P-VOL device group name. Value should not exceed 31 characters. The name is case sensitive.

Attribute	Type	Description
svolDeviceGroupName	string	(Required) Specify the S-VOL device group name. Value should not exceed 31 characters. The name is case sensitive.

Query parameters

None.

Body

```
{
  "parameters": {
    "quickMode": true,
    "copyPace": 10,
    "forceSuspend": false
  }
}
```

Attribute	Type	Description
quickMode	boolean	(Optional) Specify whether to run in quick mode. <ul style="list-style-type: none"> <code>true</code>: Performs execution in quick mode. <code>false</code>: Performs execution in normal mode. If this value is omitted, <code>false</code> is assumed.
copyPace	int	(Optional) Specify a value in the range from 1 to 15 to be the copy speed. The larger the value, the higher the speed. <p>If you specify <code>true</code> for the <code>forceSuspend</code> attribute, you cannot specify this attribute.</p>
forceSuspend	boolean	(Optional) Specify whether to force splitting of the pair. <ul style="list-style-type: none"> <code>true</code>: Forces splitting of the pair. <code>false</code>: Does not force splitting of the pair. If this value is omitted, <code>false</code> is assumed. <p>If you specify <code>true</code> for this attribute, you cannot specify the <code>copyPace</code> attribute.</p>

Response message**Body**

A job object is returned. For details on attributes other than `affectedResources`, see the section explaining job objects.

Attribute	Description
<code>affectedResources</code>	URL of the split copy group

Action template

```
GET base-URL/v1/objects/local-clone-copygroups/object-ID/actions/split
```

Status codes

The following table describes the meaning of the status code of the request for this operation. For details on other status codes, see the description on HTTP status codes.

Status code	Message	Description
412	Precondition Failed	The action template cannot be obtained, because the object is incorrect.

Coding example

To get an action template:

```
curl -v -H "Accept: application/json" -H "Authorization:Session d7b673af189048468c5af9bcf3bbbb6f" -X GET https://192.0.2.100/ConfigurationManager/v1/objects/local-clone-copygroups/localCopyGroup1,localCopyGroup1P_,localCopyGroup1S_/actions/split
```

To run the request after getting an action template:

```
curl -v -H "Accept: application/json" -H "Content-Type: application/json" -H "Authorization:Session d7b673af189048468c5af9bcf3bbbb6f" -X POST --data-binary @./InputParameters.json https://192.0.2.100/ConfigurationManager/v1/objects/local-clone-copygroups/localCopyGroup1,localCopyGroup1P_,localCopyGroup1S_/actions/split/invoke
```

Splitting a ShadowImage pair

The following request splits the specified ShadowImage pair. If the pair is split, data can be read from or written to the secondary volume.



Tip: We recommend specifying `Job-Mode-Wait-Configuration-Change:NoWait` in the request header of this API function. For details, see the description of the flow of operations for the pairs.



Note: The `forceSplit` attribute in the action template is unnecessary. When using the action template, remove this attribute before creating a request.

Execution permission

Storage Administrator (Local Copy)

Request line

```
POST base-URL/v1/objects/local-clone-coppairs/object-ID/actions/split/
invoke
```

Request message

Object ID

Specify the `localCloneCoppairId` value obtained by getting the ShadowImage pair information. You can also specify the following attributes and connect them with commas:

```
copyGroupName, pvolDeviceGroupName, svolDeviceGroupName, copyPairName
```

Attribute	Type	Description
<code>copyGroupName</code>	string	(Required) Specify the copy group name. Value should not exceed 31 characters. The name is case sensitive.
<code>pvolDeviceGroupName</code>	string	(Required) Specify the P-VOL device group name. Value should not exceed 31 characters. The name is case sensitive.
<code>svolDeviceGroupName</code>	string	(Required) Specify the S-VOL device group name. Value should not exceed 31 characters. The name is case sensitive.
<code>copyPairName</code>	string	(Required) Specify the name of the copy pair. Value should not exceed 31 characters. The name is case sensitive.

Query parameters

None.

Body

```
{
  "parameters": {
    "quickMode": true,
    "copyPace": 10,
    "forceSuspend": false
  }
}
```

Attribute	Type	Description
quickMode	boolean	(Optional) Specify whether to run in quick mode. <ul style="list-style-type: none"> <code>true</code>: Performs execution in quick mode. <code>false</code>: Performs execution in normal mode. If this value is omitted, <code>false</code> is assumed.
copyPace	int	(Optional) Specify a value in the range from 1 to 15 to be the copy speed. The larger the value, the higher the speed. If you specify <code>true</code> for the <code>forceSuspend</code> attribute, you cannot specify this attribute.
forceSuspend	boolean	(Optional) Specify whether to force splitting of the pair. <ul style="list-style-type: none"> <code>true</code>: Forces splitting of the pair. <code>false</code>: Does not force splitting of the pair. If this value is omitted, <code>false</code> is assumed. If you specify <code>true</code> for this attribute, you cannot specify the <code>copyPace</code> attribute.

Response message**Body**

A job object is returned. For details on attributes other than `affectedResources`, see the section explaining job objects.

Attribute	Description
<code>affectedResources</code>	URL of the split ShadowImage pair

Action template

```
GET base-URL/v1/objects/local-clone-coppairs/object-ID/actions/split
```

Status codes

The following table describes the meaning of the status code of the request for this operation. For details on other status codes, see the description on HTTP status codes.

Status code	Message	Description
412	Precondition Failed	The action template cannot be obtained, because the object is incorrect.

Coding example

To get an action template:

```
curl -v -H "Accept: application/json" -H "Authorization:Session
d7b673af189048468c5af9bcf3bbbb6f" -X GET https://192.0.2.100/
ConfigurationManager/v1/objects/local-clone-coppairs/localCopyGroup1,
localCopyGroup1P_,localCopyGroup1S_,pair1/actions/split
```

To run the request after getting an action template:

```
curl -v -H "Accept: application/json" -H "Content-Type: application/json" -
H "Authorization:Session d7b673af189048468c5af9bcf3bbbb6f" -X POST --data-
binary @./InputParameters.json https://192.0.2.100/ConfigurationManager/v1/
objects/local-clone-coppairs/localCopyGroup1,localCopyGroup1P_,
localCopyGroup1S_,pair1/actions/split/invoke
```

Resynchronizing ShadowImage pairs in units of copy groups

The following HTTP request resynchronizes ShadowImage pairs that were split in the specified copy group in the normal direction (from primary volumes to secondary volumes).



Tip: We recommend specifying `Job-Mode-Wait-Configuration-Change:NoWait` in the request header of this API function. For details, see the description of the flow of operations for the pairs.

Execution permission

Storage Administrator (Local Copy)

Request line

```
POST base-URL/v1/objects/local-clone-copygroups/object-ID/actions/resync/
invoke
```

Request message**Object ID**

Specify the `localCloneCopygroupId` value obtained by getting the list of copy groups. You can also specify the following attributes and connect them with commas:

```
copyGroupName, pvolDeviceGroupName, svolDeviceGroupName
```

Attribute	Type	Description
<code>copyGroupName</code>	string	(Required) Specify the copy group name. Value should not exceed 31 characters. The name is case sensitive.
<code>pvolDeviceGroupName</code>	string	(Required) Specify the P-VOL device group name. Value should not exceed 31 characters. The name is case sensitive.
<code>svolDeviceGroupName</code>	string	(Required) Specify the S-VOL device group name. Value should not exceed 31 characters. The name is case sensitive.

Query parameters

None.

Body

```
{
  "parameters": {
    "quickMode": true,
    "copyPace": 10
  }
}
```

Attribute	Type	Description
<code>quickMode</code>	boolean	(Optional) Specify whether to run in quick mode. <ul style="list-style-type: none"> ▪ <code>true</code>: Performs execution in quick mode. ▪ <code>false</code>: Performs execution in normal mode.

Attribute	Type	Description
		If this value is omitted, <code>false</code> is assumed.
<code>copyPace</code>	<code>int</code>	(Optional) Specify a value in the range from 1 to 15 to be the copy speed. The larger the value, the higher the speed.

Response message

Body

A job object is returned. For details on attributes other than `affectedResources`, see the section explaining job objects.

Attribute	Description
<code>affectedResources</code>	URL of the resynchronized copy group

Action template

```
GET base-URL/v1/objects/local-clone-copygroups/object-ID/actions/resync
```

Status codes

The following table describes the meaning of the status code of the request for this operation. For details on other status codes, see the description on HTTP status codes.

Status code	Message	Description
412	Precondition Failed	The action template cannot be obtained, because the object is incorrect.

Coding example

To get an action template:

```
curl -v -H "Accept: application/json" -H "Authorization:Session d7b673af189048468c5af9bcf3bbbb6f" -X GET https://192.0.2.100/ConfigurationManager/v1/objects/local-clone-copygroups/localCopyGroup1,localCopyGroup1P_,localCopyGroup1S_/actions/resync
```

To run the request after getting an action template:

```
curl -v -H "Accept: application/json" -H "Content-Type: application/json" -H "Authorization:Session d7b673af189048468c5af9bcf3bbbb6f" -X POST --data-binary @./InputParameters.json https://192.0.2.100/ConfigurationManager/v1/
```

```
objects/local-clone-copygroups/localCopyGroup1,localCopyGroup1P_,
localCopyGroup1S_/actions/resync/invoke
```

Resynchronizing a ShadowImage pair

The following HTTP request resynchronizes a split ShadowImage pair in the normal direction (from the primary volume to the secondary volume).



Tip: We recommend specifying `Job-Mode-Wait-Configuration-Change:NoWait` in the request header of this API function. For details, see the description of the flow of operations for the pairs.

Execution permission

Storage Administrator (Local Copy)

Request line

```
POST base-URL/v1/objects/local-clone-copypairs/object-ID/actions/resync/
invoke
```

Request message

Object ID

Specify the `localCloneCopypairId` value obtained by getting the ShadowImage pair information. You can also specify the following attributes and connect them with commas:

```
copyGroupName, pvolDeviceGroupName, svolDeviceGroupName, copyPairName
```

Attribute	Type	Description
<code>copyGroupName</code>	string	(Required) Specify the copy group name. Value should not exceed 31 characters. The name is case sensitive.
<code>pvolDeviceGroupName</code>	string	(Required) Specify the P-VOL device group name. Value should not exceed 31 characters. The name is case sensitive.
<code>svolDeviceGroupName</code>	string	(Required) Specify the S-VOL device group name. Value should not exceed 31 characters. The name is case sensitive.
<code>copyPairName</code>	string	(Required) Specify the name of the copy pair. Value should not exceed 31 characters. The name is case sensitive.

Query parameters

None.

Body

```
{
  "parameters": {
    "quickMode": true,
    "copyPace": 10
  }
}
```

Attribute	Type	Description
quickMode	boolean	(Optional) Specify whether to run in quick mode. <ul style="list-style-type: none"> ▪ <code>true</code>: Performs execution in quick mode. ▪ <code>false</code>: Performs execution in normal mode. If this value is omitted, <code>false</code> is assumed.
copyPace	int	(Optional) Specify a value in the range from 1 to 15 to be the copy speed. The larger the value, the higher the speed.

Response message**Body**

A job object is returned. For details on attributes other than `affectedResources`, see the section explaining job objects.

Attribute	Description
<code>affectedResources</code>	URL of the resynchronized ShadowImage pair

Action template

```
GET base-URL/v1/objects/local-clone-coppairs/object-ID/actions/resync
```

Status codes

The following table describes the meaning of the status code of the request for this operation. For details on other status codes, see the description on HTTP status codes.

Status code	Message	Description
412	Precondition Failed	The action template cannot be obtained, because the object is incorrect.

Coding example

To get an action template:

```
curl -v -H "Accept: application/json" -H "Authorization:Session
d7b673af189048468c5af9bcf3bbbb6f" -X GET https://192.0.2.100/
ConfigurationManager/v1/objects/local-clone-copypairs/localCopyGroup1,
localCopyGroup1P_,localCopyGroup1S_,pair1/actions/resync
```

To run the request after getting an action template:

```
curl -v -H "Accept: application/json" -H "Content-Type: application/json" -
H "Authorization:Session d7b673af189048468c5af9bcf3bbbb6f" -X POST --data-
binary @./InputParameters.json https://192.0.2.100/ConfigurationManager/v1/
objects/local-clone-copypairs/localCopyGroup1,localCopyGroup1P_,
localCopyGroup1S_,pair1/actions/resync/invoke
```

Restoring ShadowImage pairs in units of copy groups

The following HTTP request resynchronizes ShadowImage pairs that were split in the specified copy group in the reverse direction (from secondary volumes to the primary volumes).



Tip: We recommend specifying `Job-Mode-Wait-Configuration-Change:NoWait` in the request header of this API function. For details, see the description of the flow of operations for the pairs.

Execution permission

Storage Administrator (Local Copy)

Request line

```
POST base-URL/v1/objects/local-clone-copygroups/object-ID/actions/restore/
invoke
```

Request message**Object ID**

Specify the `localCloneCopygroupId` value obtained by getting the list of copy groups. You can also specify the following attributes and connect them with commas:

```
copyGroupName, pvolDeviceGroupName, svolDeviceGroupName
```

Attribute	Type	Description
copyGroupName	string	(Required) Specify the copy group name. Value should not exceed 31 characters. The name is case sensitive.
pvolDeviceGroupName	string	(Required) Specify the P-VOL device group name. Value should not exceed 31 characters. The name is case sensitive.
svolDeviceGroupName	string	(Required) Specify the S-VOL device group name. Value should not exceed 31 characters. The name is case sensitive.

Query parameters

None.

Body

```
{
  "parameters": {
    "quickMode": true,
    "copyPace": 10
  }
}
```

Attribute	Type	Description
quickMode	boolean	(Optional) Specify whether to run in quick mode. <ul style="list-style-type: none"> <code>true</code>: Performs execution in quick mode. <code>false</code>: Performs execution in normal mode. If this value is omitted, <code>false</code> is assumed.
copyPace	int	(Optional) Specify a value in the range from 1 to 15 to be the copy speed. The larger the value, the higher the speed.

Response message**Body**

A job object is returned. For details on attributes other than `affectedResources`, see the section explaining job objects.

Attribute	Description
<code>affectedResources</code>	URL of the restored copy group

Action template

```
GET base-URL/v1/objects/local-clone-copygroups/object-ID/actions/restore
```

Status codes

The following table describes the meaning of the status code of the request for this operation. For details on other status codes, see the description on HTTP status codes.

Status code	Message	Description
412	Precondition Failed	The action template cannot be obtained, because the object is incorrect.

Coding example

To get an action template:

```
curl -v -H "Accept: application/json" -H "Authorization:Session d7b673af189048468c5af9bcf3b666f" -X GET https://192.0.2.100/ConfigurationManager/v1/objects/local-clone-copygroups/localCopyGroup1,localCopyGroup1P_,localCopyGroup1S_/actions/restore
```

To run the request after getting an action template:

```
curl -v -H "Accept: application/json" -H "Content-Type: application/json" -H "Authorization:Session d7b673af189048468c5af9bcf3b666f" -X POST --data-binary @./InputParameters.json https://192.0.2.100/ConfigurationManager/v1/objects/local-clone-copygroups/localCopyGroup1,localCopyGroup1P_,localCopyGroup1S_/actions/restore/invoke
```

Restoring a ShadowImage pair

The following HTTP request resynchronizes a split ShadowImage pair in the reverse direction (from the secondary volume to the primary volume).



Tip: We recommend specifying `Job-Mode-Wait-Configuration-Change:NoWait` in the request header of this API function. For details, see the description of the flow of operations for the pairs.

Execution permission

Storage Administrator (Local Copy)

Request line

```
POST base-URL/v1/objects/local-clone-coppairs/object-ID/actions/restore/
invoke
```

Request message

Object ID

Specify the `localCloneCoppairId` value obtained by getting the ShadowImage pair information. You can also specify the following attributes and connect them with commas:

```
copyGroupName,pvolDeviceGroupName,svolDeviceGroupName,copyPairName
```

Attribute	Type	Description
<code>copyGroupName</code>	string	(Required) Specify the copy group name. Value should not exceed 31 characters. The name is case sensitive.
<code>pvolDeviceGroupName</code>	string	(Required) Specify the P-VOL device group name. Value should not exceed 31 characters. The name is case sensitive.
<code>svolDeviceGroupName</code>	string	(Required) Specify the S-VOL device group name. Value should not exceed 31 characters. The name is case sensitive.
<code>copyPairName</code>	string	(Required) Specify the name of the copy pair. Value should not exceed 31 characters. The name is case sensitive.

Query parameters

None.

Body

```
{
  "parameters": {
```



```

    "quickMode": true,
    "copyPace": 10
  }
}

```

Attribute	Type	Description
quickMode	boolean	(Optional) Specify whether to run in quick mode. <ul style="list-style-type: none"> ▪ <code>true</code>: Performs execution in quick mode. ▪ <code>false</code>: Performs execution in normal mode. If this value is omitted, <code>false</code> is assumed.
copyPace	int	(Optional) Specify a value in the range from 1 to 15 to be the copy speed. The larger the value, the higher the speed.

Response message

Body

A job object is returned. For details on attributes other than `affectedResources`, see the section explaining job objects.

Attribute	Description
<code>affectedResources</code>	URL of the restored ShadowImage pair

Action template

```
GET base-URL/v1/objects/local-clone-coppairs/object-ID/actions/restore
```

Status codes

The following table describes the meaning of the status code of the request for this operation. For details on other status codes, see the section explaining HTTP status codes.

Status code	Message	Description
412	Precondition Failed	The action template cannot be obtained, because the object is incorrect.

Coding example

To get an action template:

```
curl -v -H "Accept: application/json" -H "Authorization:Session
d7b673af189048468c5af9bcf3b6bb6f" -X GET https://192.0.2.100/
ConfigurationManager/v1/objects/local-clone-copypairs/localCopyGroup1,
localCopyGroup1P_,localCopyGroup1S_,pair1/actions/restore
```

To run the request after getting an action template:

```
curl -v -H "Accept: application/json" -H "Content-Type: application/json" -
H "Authorization:Session d7b673af189048468c5af9bcf3b6bb6f" -X POST --data-
binary @./InputParameters.json https://192.0.2.100/ConfigurationManager/v1/
objects/local-clone-copypairs/localCopyGroup1,localCopyGroup1P_,
localCopyGroup1S_,pair1/actions/restore/invoke
```

Deleting a copy group

The following request deletes ShadowImage pairs by using the specified copy group. When the pairs are all deleted, the device groups are also deleted.

Execution permission

Storage Administrator (Provisioning) and Storage Administrator (Local Copy)

Request line

```
DELETE base-URL/v1/objects/local-clone-copygroups/object-ID
```

Request message**Object ID**

Specify the `localCloneCopygroupId` value obtained by getting the list of copy groups. You can also specify the following attributes and connect them with commas:

```
copyGroupName,pvolDeviceGroupName,svolDeviceGroupName
```

Attribute	Type	Description
copyGroupName	string	(Required) Specify the copy group name. Value should not exceed 31 characters. The name is case sensitive.

Attribute	Type	Description
pvolDeviceGroupName	string	(Required) Specify the P-VOL device group name. Value should not exceed 31 characters. The name is case sensitive.
svolDeviceGroupName	string	(Required) Specify the S-VOL device group name. Value should not exceed 31 characters. The name is case sensitive.

Query parameters

None.

Body

None.

Response message**Body**

A job object is returned. For details on attributes other than `affectedResources`, see the section explaining job objects.

Attribute	Description
<code>affectedResources</code>	URL of the deleted copy group

Coding example

```
curl -v -H "Accept: application/json" -H "Content-Type: application/json" -H "Authorization:Session d7b673af189048468c5af9bcf3bbbb6f" -X DELETE --data-binary @./InputParameters.json https://192.0.2.100/ConfigurationManager/v1/objects/local-clone-copygroups/localCopyGroup1,localCopyGroup1P_,localCopyGroup1S_
```

When forcibly deleting a copy group

When a copy group cannot be deleted because the device group in a local storage system remains or because the configuration is not normal, you can forcibly delete the copy group by specifying the `forceDelete` attribute for the request body. The following shows a coding example of using the `forceDelete` attribute:

```
{
  "forceDelete" : true
}
```

Attribute	Type	Description
forceDelete	boolean	(Optional) Specify whether to delete the copy group forcibly. <ul style="list-style-type: none"> <code>true</code>: Forcibly delete the copy group. <code>false</code>: Do not forcibly delete the copy group. When the attribute is omitted, <code>false</code> is assumed.

Deleting a ShadowImage pair

The following request deletes the specified ShadowImage pair. If there is no ShadowImage pair in the copy group, the copy group and the device group that makes up of the copy group are also deleted.

Execution permission

Storage Administrator (Provisioning) and Storage Administrator (Local Copy)

Request line

```
DELETE base-URL/v1/objects/local-clone-copypairs/object-ID
```

Request message

Object ID

Specify the `localCloneCopypairId` value obtained by getting the ShadowImage pair information. You can also specify the following attributes and connect them with commas:

```
copyGroupName,pvolDeviceGroupName,svolDeviceGroupName,copyPairName
```

Attribute	Type	Description
copyGroupName	string	(Required) Specify the copy group name. Value should not exceed 31 characters. The name is case sensitive.
pvolDeviceGroupName	string	(Required) Specify the P-VOL device group name. Value should not exceed 31 characters. The name is case sensitive.
svolDeviceGroupName	string	(Required) Specify the S-VOL device group name. Value should not exceed 31 characters. The name is case sensitive.

Attribute	Type	Description
copyPairName	string	(Required) Specify the name of the copy pair. Value should not exceed 31 characters. The name is case sensitive.

Query parameters

None.

Body

None.

Response message**Body**

A job object is returned. For details on attributes other than affectedResources, see the section explaining job objects.

Attribute	Description
affectedResources	URL of the deleted ShadowImage pair

Status codes

For details on the status codes of the request for this operation, see the description on HTTP status codes.

Coding example

```
curl -v -H "Accept: application/json" -H "Authorization:Session
d7b673af189048468c5af9bcf3bbbb6f" -X DELETE https://192.0.2.100/
ConfigurationManager/v1/objects/local-clone-copypairs/localCopyGroup1,
localCopyGroup1P_,localCopyGroup1S_,pair1
```

Chapter 9: Managing Thin Image pairs

This chapter describes how to perform operations on Thin Image pairs by using the REST API.

Overview of Thin Image

Thin Image creates a copy of a primary volume in a storage system by storing only the differential data for the primary volume.

When updating the primary volume, Thin Image stores the differential data in a Thin Image pool or an HDP pool as snapshot data. If a failure occurs in the data in the storage system, the data can be restored by using the snapshot data. A REST API client issues an API to perform operations for Thin Image.

- When a Thin Image pair without a secondary volume is created:

If a problem occurs in the primary volume data, the primary volume can be restored by using the snapshot data. A secondary volume can be allocated later to the snapshot data when the secondary volume becomes necessary.

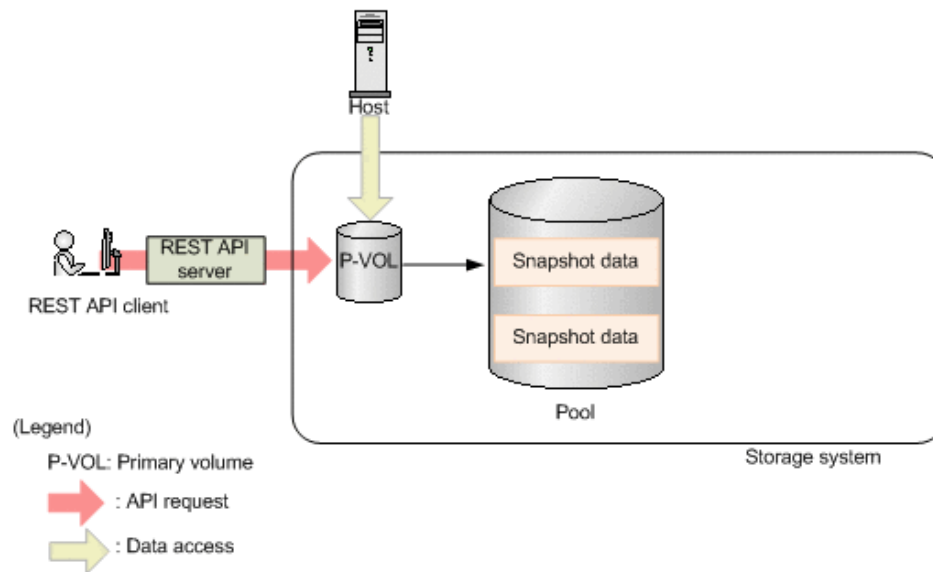

- When a Thin Image pair with a secondary volume is created:

The primary volume can be restored by using the snapshot data. In addition, a copy of the primary volume from when the snapshot data was stored can be viewed from the secondary volume. The following figure shows an example of obtaining a snapshot of a Thin Image pair.

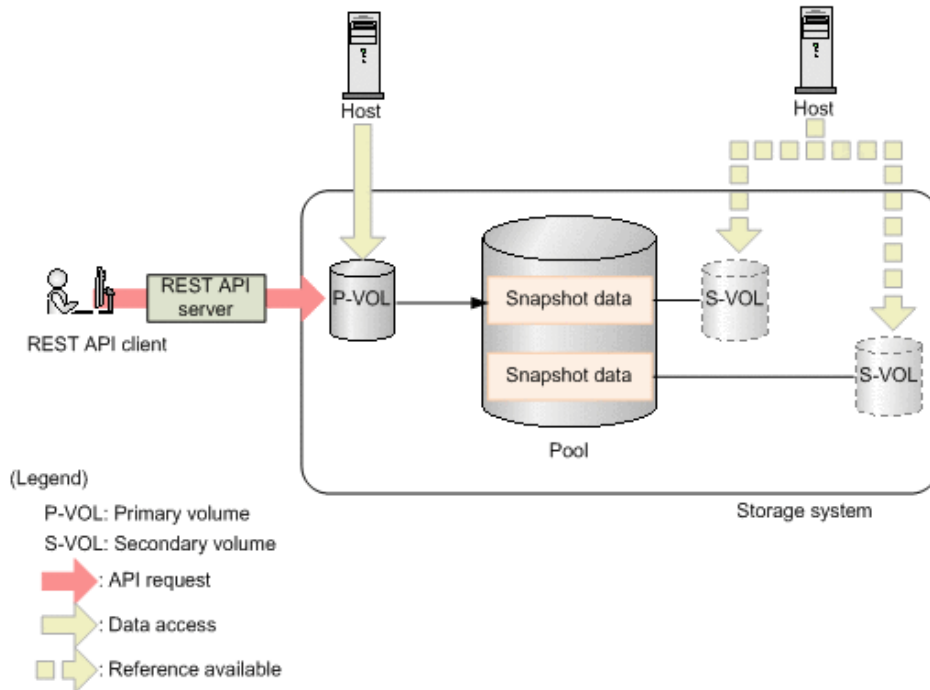

To store snapshot data, create a Thin Image pair where an LDEV or a DP volume is used as a primary volume, and a virtual volume for Thin Image or a DP volume is used as a secondary volume. If the created pair is registered to a snapshot group or a consistency group, processing can be performed by group. If a consistency group is defined, the snapshot data from when the storage system received a request can be stored for all the primary volumes in that consistency group.

You can create a cascade configuration by creating a Thin Image pair for another Thin Image pair. You can also create a clone of a Thin Image pair and use the created clone as DP volumes.

If you clone a Thin Image pair that has the clone attribute, the volume that was specified as the secondary volume can be used as a DP volume.

For details about Thin Image, see the *Hitachi Thin Image User Guide*.

Workflow for operating Thin Image pairs

The following shows the Thin Image functions that can be run by the REST API:

- Getting information about snapshot groups
Obtains a list of snapshot groups registered in the target storage system.
- Getting pair status and configuration information
Obtains a Thin Image pair status and configuration information. You can check if a pair operation is complete. You can also obtain pair information in units of snapshot groups.
- Creating a pair
Creates a new Thin Image pair in a snapshot group of the target storage system. If the snapshot group is not created, the snapshot group is automatically created. You will be able to perform operations in units of snapshot groups by creating Thin Image pairs in a snapshot group.

To create a pair in a new snapshot group:



To create a pair in an existing snapshot group:

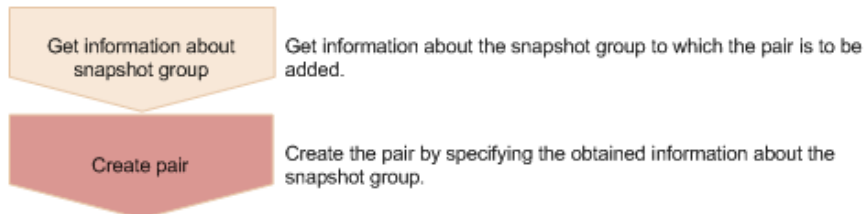

When creating a pair, you can specify whether the clone attribute can be set and whether a cascade configuration is possible.

- Storing snapshot data
Splits a Thin Image pair, and then stores snapshot data, after the primary volume is updated.

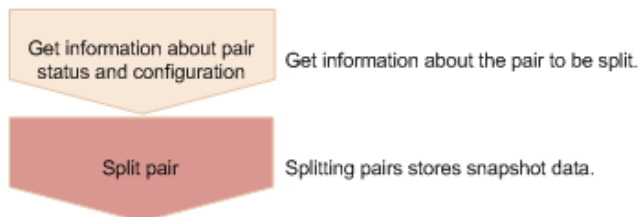

- Resynchronizing a pair

Deletes old snapshot data by resynchronizing a pair. You can perform pair resynchronization if the pair status is PSUS. When pair resynchronization is complete, new snapshot data can be automatically stored again.

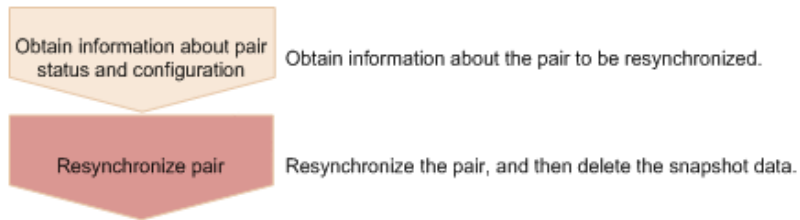

- Recovering a pair by a restore

If you restore a split Thin Image pair, data of the primary volume is restored to the data from when the snapshot data was stored. You can also perform a restore in units of snapshot groups. You can perform a restore if the pair status is PSUS.

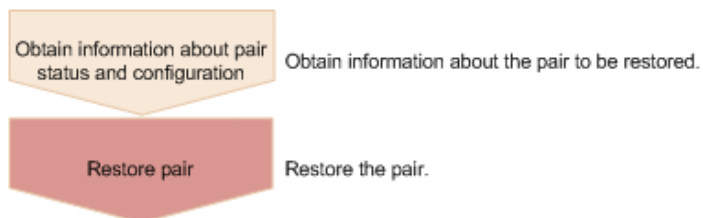

- Assigning a secondary volume to snapshot data

Assigns a secondary volume to the snapshot data of the specified Thin Image pair. Create in advance a virtual volume for Thin Image to be used as the secondary volume. If you assign a secondary volume, you can view the snapshots.

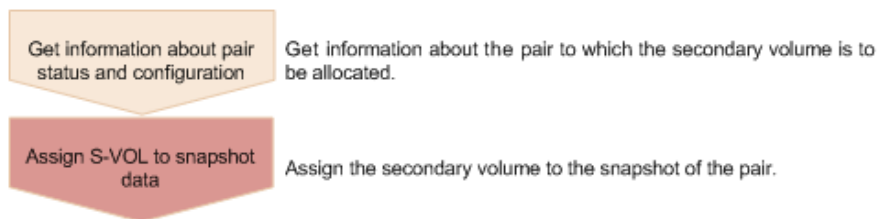

- Unallocating the secondary volume for snapshot data

Unallocates the secondary volume of the specified Thin Image pair.

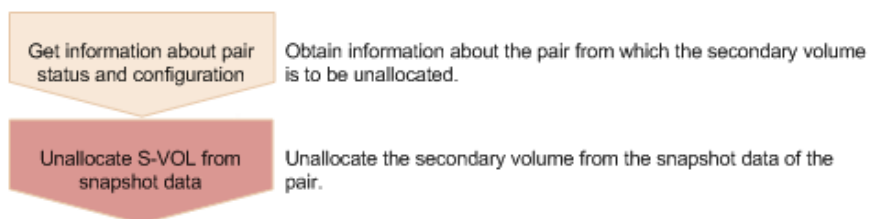

- Deleting a pair

Deletes a Thin Image pair that is unnecessary. If you delete a pair, the snapshot data is deleted from the Thin Image pool or the HDP pool. In addition, if the specified Thin Image pair is the last one in a snapshot group, the snapshot group is also deleted. You can also delete pairs in units of snapshot groups or snapshot trees.

You can delete a pair at any time regardless of the pair status. However, if you delete a pair while the pair status is being changed, the pair might be deleted before its status is changed, and the request to change the pair status might time out.

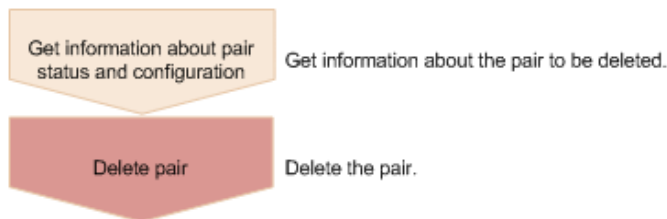

- Cloning

After all the data of the primary volume of a Thin Image pair that has the clone attribute is copied to the secondary volume, the pair is deleted.

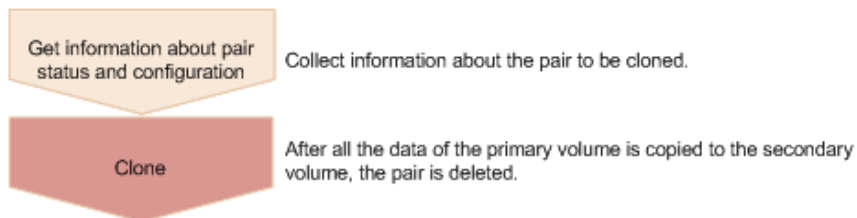

Pair status (Thin Image)

Pair status changes according to the pair operation.

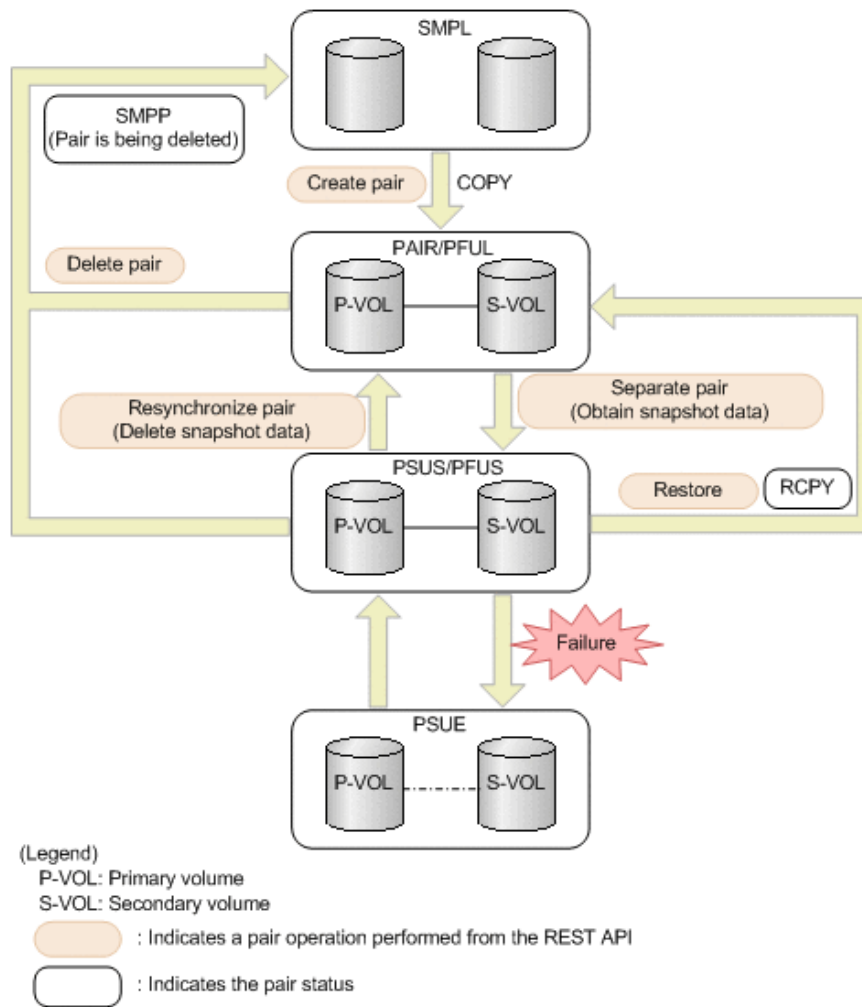

Pair status	Description	Access to the P-VOL	Access to the S-VOL
SMPL	Unpaired volumes	-	-
SMPP	A pair is being deleted	R/W enabled	R/W enabled
COPY	A pair is being created	R/W enabled	Not enabled
PAIR	Paired volumes	R/W enabled	Not enabled
PFUL	The volumes are paired, and the threshold of a Thin Image pool or an HDP pool is exceeded.	R/W enabled	Not enabled
PSUS	The pair has been split.	R/W enabled	R/W enabled

Pair status	Description	Access to the P-VOL	Access to the S-VOL
PFUS	The pair is split and the threshold of a Thin Image pool or an HDP pool is exceeded.	R/W enabled	R/W enabled
RCPY	A restore operation is being performed. (Data is being copied from the S-VOL to the P-VOL.)	R/W enabled	Not enabled
PSUE	The pairing is suspended.	R/W enabled	Not enabled

The following figure shows the pair status changes when cloning is performed.

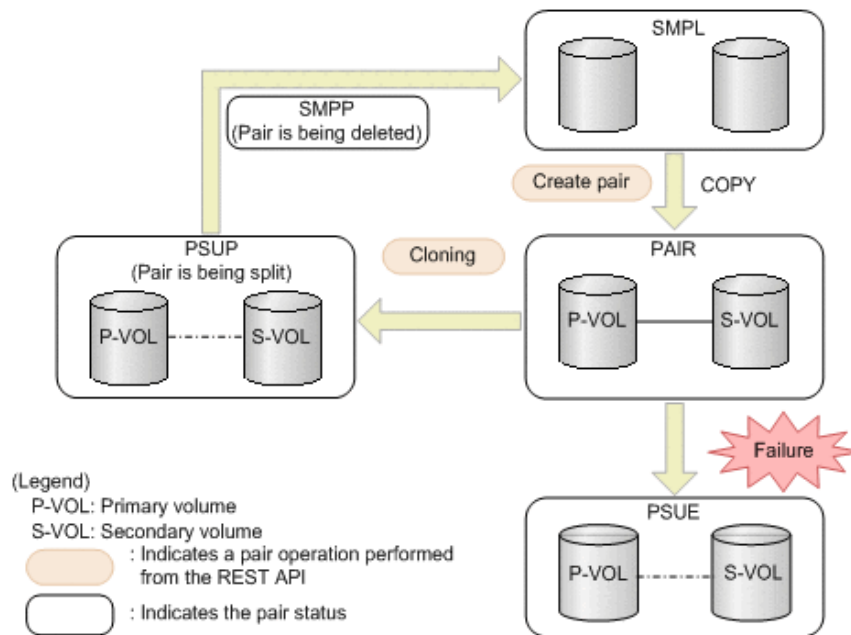

Pair status	Description	Access to the P-VOL	Access to the S-VOL
SMPL	Unpaired volumes	-	-
SMPP	A pair is being deleted	R/W enabled	R/W enabled
COPY	A pair is being created	R/W enabled	Not enabled
PAIR	Paired volumes	R/W enabled	Not enabled
PSUP	A pair is being split	R/W enabled	R/W enabled

Pair status	Description	Access to the P-VOL	Access to the S-VOL
PSUE	The pairing is suspended.	R/W enabled	Not enabled

Getting information about Thin Image pairs in units of snapshot groups

The following request gets a list of information about Thin Image pairs in units of snapshot groups. Use this information to check the information that is necessary for performing pair operations (for example, the pair status).

Execution permission

Storage Administrator (View Only)

Request line

```
GET base-URL/v1/objects/snapshot-groups
```

Request message

Object ID

None.

Query parameters

Parameter	Type	Filter Condition
snapshotGroupName	string	(Optional) Specify the name of the snapshot group that contains the Thin Image pairs. Specify a character string consisting of 1 to 32 characters. If this parameter is omitted, this request gets a list of snapshot groups.

Body

None.

Response message**Body**

The following is an example of the output generated when getting a list of snapshot groups:

```
{
  "data": [
    {
      "snapshotGroupName": "snapshotGroup",
      "snapshotGroupId": "snapshotGroup"
    },
    {
      "snapshotGroupName": "snapshotGroup2",
      "snapshotGroupId": "snapshotGroup2"
    }
  ]
}
```

Attribute	Type	Description
snapshotGroupName	string	Name of the snapshot group that contains the Thin Image pairs. If the name of the snapshot group contains spaces, information about that snapshot group is not output.
snapshotGroupId	string	Object ID of the snapshot group.

The following is an example of the output generated when getting information about multiple Thin Image pairs. The information is output in ascending order of the LDEV number and MU number of the primary volume.

```
{
  "data": [
    {
      "snapshotGroupName": "snapshotGroup",
      "primaryOrSecondary": "P-VOL",
      "status": "PSUS",
      "pvolLdevId": 100,
      "muNumber": 3,
      "svolLdevId": 101,
      "snapshotPoolId": 10,
      "concordanceRate": 100,
      "isConsistencyGroup": true,
      "isWrittenInSvol": false,
      "isClone": false,
    }
  ]
}
```

```

    "canCascade": false,
    "splitTime": "2015-03-20T09:27:35",
    "snapshotId": "100,3"
  },
  {
    "snapshotGroupName": "snapshotGroup",
    "primaryOrSecondary": "P-VOL",
    "status": "PSUS",
    "pvolLdevId": 100,
    "muNumber": 4,
    "snapshotPoolId": 10,
    "concordanceRate": 100,
    "isConsistencyGroup": true,
    "isWrittenInSvol": false,
    "isClone": false,
    "canCascade": false,
    "splitTime": "2015-03-20T09:27:35",
    "snapshotId": "100,4"
  }
]
}

```

Attribute	Type	Description
snapshotGroupName	string	Name of the snapshot group that contains the Thin Image pairs. If the name of the snapshot group contains spaces, information about pairs is not output.
primaryOrSecondary	string	Attribute of the LDEV
status	string	Pair status For details, see the section explaining on pair status (Thin Image).
pvolLdevId	int	LDEV number of P-VOL
muNumber	int	MU number of the P-VOL
svolLdevId	int	LDEV number of S-VOL
snapshotPoolId	int	ID of the pool in which the snapshot data is created
concordanceRate	int	Concordance rate for pairs

Attribute	Type	Description
		<p>This attribute is output when any of the following conditions are met:</p> <ul style="list-style-type: none"> ▪ The value of the <code>isClone</code> attribute is <code>false</code>, and the value of the <code>canCascade</code> attribute is also <code>false</code>. ▪ The value of the <code>isClone</code> attribute is <code>true</code>, and the value of the <code>status</code> attribute is not <code>COPY</code>, <code>RCPY</code>, <code>SMPP</code>, or <code>PSUP</code>. ▪ The value of the <code>canCascade</code> attribute is <code>true</code>, and the value of <code>status</code> attribute is not <code>COPY</code>, <code>RCPY</code>, <code>SMPP</code>, or <code>PSUP</code>.
progressRate	int	<p>Progress of the processing</p> <p>This attribute is output when either of the following conditions is met:</p> <ul style="list-style-type: none"> ▪ The value of the <code>isClone</code> attribute is <code>true</code>, and the value of the <code>status</code> attribute is <code>COPY</code>, <code>RCPY</code>, <code>SMPP</code>, or <code>PSUP</code>. ▪ The value of the <code>canCascade</code> attribute is <code>true</code>, and the value of the <code>status</code> attribute is <code>COPY</code>, <code>RCPY</code>, <code>SMPP</code>, or <code>PSUP</code>.
isConsistencyGroup	boolean	<p>Returns whether the pair was created in the consistency group mode (CTG mode).</p> <ul style="list-style-type: none"> ▪ <code>true</code>: The pair was created in the CTG mode. ▪ <code>false</code>: The pair was not created in the CTG mode.
isWrittenInSvol	boolean	<p>Returns whether data was written to the S-VOL from the host when the pair status was <code>PSUS</code>/<code>PFUS</code>.</p> <ul style="list-style-type: none"> ▪ <code>true</code>: Data was written to the S-VOL ▪ <code>false</code>: Data was not written to the S-VOL
isClone	boolean	<p>Returns whether the pair has the clone attribute.</p> <ul style="list-style-type: none"> ▪ <code>true</code>: The pair has the clone attribute. ▪ <code>false</code>: The pair does not have the clone attribute.

Attribute	Type	Description
canCascade	boolean	Returns whether the pair can be a cascaded pair. <ul style="list-style-type: none"> ▪ <code>true</code>: The pair can be a cascaded pair. ▪ <code>false</code>: The pair cannot be a cascaded pair.
splitTime	string	Time when snapshot data was created The local time of the storage system is returned in YYYY-MM-DDThh:mm:ss format.
snapshotId	string	Object ID of the Thin Image pair The following attributes are output, separated by commas: <ul style="list-style-type: none"> ▪ <code>pvolLdevId</code> ▪ <code>muNumber</code>

Status codes

For details on the status codes of the request for this operation, see the description on HTTP status codes.

Coding example

When a snapshot group is not specified:

```
curl -v -H "Accept: application/json" -H "Authorization:Session
d7b673af189048468c5af9bcf3bbbb6f" -X GET https://192.0.2.100/
ConfigurationManager/v1/objects/snapshot-groups
```

When a snapshot group is specified:

```
curl -v -H "Accept: application/json" -H "Authorization:Session
d7b673af189048468c5af9bcf3bbbb6f" -X GET https://192.0.2.100/
ConfigurationManager/v1/objects/snapshot-groups?
snapshotGroupName=snapshotGroup
```

Getting information about Thin Image pairs in a specified snapshot group

The following request gets information about Thin Image pairs in units of snapshot groups. Use this information to check the information that is necessary for performing pair operations (for example, the pair status).

Execution permission

Storage Administrator (View Only)

Request lineGET *base-URL/v1/objects/snapshot-groups/object-ID***Request message****Object ID**

Specify the `snapshotGroupId` value obtained by getting information about the snapshot groups.

Attribute	Type	Description
snapshotGroupId	string	(Required) Object ID of the snapshot group. Specify a character string consisting of 1 to 32 characters. The name is case sensitive.

Query parameters

None.

Body

None.

Response message**Body**

```
{
  "snapshotGroupName" : "snapshotGroup",
  "snapshotGroupId" : "snapshotGroup",
  "snapshots" : [ {
    "snapshotGroupName": "snapshotGroup",
    "primaryOrSecondary": "P-VOL",
    "status": "PSUS",
    "pvolLdevId": 100,
    "muNumber": 3,
    "svolLdevId": 101,
    "snapshotPoolId": 10,
    "concordanceRate": 100,
    "isConsistencyGroup": true,
    "isWrittenInSvol": false,
    "isClone": false,
    "canCascade": false,
    "splitTime": "2015-03-20T09:27:35",
```

```

    "snapshotId": "100,3"
  }, {
    "snapshotGroupName": "snapshotGroup",
    "primaryOrSecondary": "P-VOL",
    "status": "PSUS",
    "pvolLdevId": 100,
    "muNumber": 4,
    "snapshotPoolId": 10,
    "concordanceRate": 100,
    "isConsistencyGroup": true,
    "isWrittenInSvol": false,
    "isClone": false,
    "canCascade": false,
    "splitTime": "2015-03-20T09:27:35",
    "snapshotId": "100,4"
  } ]
}

```

Attribute	Type	Description
snapshotGroupName	string	Name of the snapshot group that contains the Thin Image pairs. If the name of the snapshot group contains spaces, information about pairs is not output.
snapshotGroupId	string	Object ID of the snapshot group
snapshots	object[]	Outputs the following attributes related to Thin Image pairs contained in the snapshot group. <ul style="list-style-type: none"> ▪ snapshotGroupName (string) Name of the snapshot group ▪ primaryOrSecondary (string) Attribute of the LDEV ▪ status (string) Pair status For details, see the section explaining on pair status (Thin Image). ▪ pvolLdevId (int) LDEV number of P-VOL ▪ muNumber (int) MU number of the P-VOL

Attribute	Type	Description
		<ul style="list-style-type: none"> <li data-bbox="792 254 1424 331">▪ svolLdevId (int) LDEV number of S-VOL <li data-bbox="792 352 1424 464">▪ snapshotPoolId (int) ID of the pool in which the snapshot data is created <li data-bbox="792 485 1424 653">▪ concordanceRate (int) Concordance rate for pairs This attribute is output when any of the following conditions are met: <ul style="list-style-type: none"> <li data-bbox="829 674 1424 772">• The value of the <code>isClone</code> attribute is <code>false</code>, and the value of the <code>canCascade</code> attribute is also <code>false</code>. <li data-bbox="829 793 1424 892">• The value of the <code>isClone</code> attribute is <code>true</code>, and the value of the <code>status</code> attribute is not <code>COPY</code>, <code>RCPY</code>, <code>SMPP</code>, or <code>PSUP</code>. <li data-bbox="829 913 1424 1012">• The value of the <code>canCascade</code> attribute is <code>true</code>, and the value of <code>status</code> attribute is not <code>COPY</code>, <code>RCPY</code>, <code>SMPP</code>, or <code>PSUP</code>. <li data-bbox="792 1033 1424 1451">▪ progressRate (int) Progress of the processing This attribute is output when either of the following conditions is met: <ul style="list-style-type: none"> <li data-bbox="829 1222 1424 1320">▪ The value of the <code>isClone</code> attribute is <code>true</code>, and the value of the <code>status</code> attribute is <code>COPY</code>, <code>RCPY</code>, <code>SMPP</code>, or <code>PSUP</code>. <li data-bbox="829 1341 1424 1440">▪ The value of the <code>canCascade</code> attribute is <code>true</code>, and the value of the <code>status</code> attribute is <code>COPY</code>, <code>RCPY</code>, <code>SMPP</code>, or <code>PSUP</code>. <li data-bbox="792 1472 1424 1751">▪ isConsistencyGroup (boolean) Returns whether the pair was created in the consistency group mode (CTG mode). <ul style="list-style-type: none"> <li data-bbox="829 1604 1424 1661">▪ <code>true</code>: The pair was created in the CTG mode. <li data-bbox="829 1682 1424 1738">▪ <code>false</code>: The pair was not created in the CTG mode.

Attribute	Type	Description
		<ul style="list-style-type: none"> <li data-bbox="792 254 1424 401"> ▪ isWrittenInSvol (boolean) Returns whether data was written to the S-VOL from the host when the pair status was <code>PSUS/</code> <code>PFUS</code>. <ul style="list-style-type: none"> <li data-bbox="829 426 1317 453">▪ <code>true</code>: Data was written to the S-VOL <li data-bbox="829 478 1382 506">▪ <code>false</code>: Data was not written to the S-VOL <li data-bbox="792 531 1424 779"> ▪ isClone (boolean) Returns whether the pair has the clone attribute. <ul style="list-style-type: none"> <li data-bbox="829 663 1341 690">▪ <code>true</code>: The pair has the clone attribute. <li data-bbox="829 716 1365 779">▪ <code>false</code>: The pair does not have the clone attribute. <li data-bbox="792 804 1424 1020"> ▪ canCascade (boolean) Returns whether the pair can be a cascaded pair. <ul style="list-style-type: none"> <li data-bbox="829 940 1341 968">▪ <code>true</code>: The pair can be a cascaded pair. <li data-bbox="829 993 1398 1020">▪ <code>false</code>: The pair cannot be a cascaded pair. <li data-bbox="792 1045 1424 1205"> ▪ splitTime (string) Time when snapshot data was created The local time of the storage system is returned in YYYY-MM-DDThh:mm:ss format. <li data-bbox="792 1230 1424 1493"> ▪ snapshotId (string) Object ID of the Thin Image pair The following attributes are output, separated by commas: <ul style="list-style-type: none"> <li data-bbox="829 1413 1024 1440">▪ <code>pvolLdevId</code> <li data-bbox="829 1465 992 1493">▪ <code>muNumber</code>

Status codes

For details on the status codes of the request for this operation, see the description on HTTP status codes.

Coding example

```
curl -v -H "Accept: application/json" -H "Authorization:Session
d7b673af189048468c5af9bcf3bbbbb6f" -X GET https://192.0.2.100/
ConfigurationManager/v1/objects/snapshot-groups/snapshotGroup
```

Getting information about Thin Image pairs

The following request gets a list of information about Thin Image pairs. Use this information to check the information that is necessary for performing pair operations (for example, the pair status).

Execution permission

Storage Administrator (View Only)

Request line

```
GET base-URL/v1/objects/snapshots
```

Request message**Object ID**

None.

Query parameters

Parameter	Type	Filter Condition
snapshotGroupName	string	(Optional) Specify the name of the snapshot group that contains the Thin Image pairs. Specify a character string consisting of 1 to 32 characters.
pvolLdevId	int	(Optional) Specify the LDEV number of the P-VOL of the Thin Image pair. Specify a decimal (base 10) number equal to or greater than 0.
svolLdevId	int	(Optional) Specify the LDEV number of the S-VOL of the Thin Image pair. If the S-VOL exists, specify a decimal (base 10) number equal to or greater than 0.
muNumber	int	(Optional) Specify the MU number of the P-VOL of the Thin Image pair.

Parameter	Type	Filter Condition
		Specify a value in the range from 0 to 1023.

The following shows how to specify parameters:

- The LDEV number of the P-VOL and the snapshot group name
- The LDEV number and the MU number of the P-VOL
- Only the LDEV number of the P-VOL
- If the secondary volume exists, only the LDEV number of the S-VOL

If no parameters are specified, an error occurs.

Body

None.

Response message

Body

If information about multiple Thin Image pairs is obtained, the information is output in ascending order of the LDEV number and MU number of the primary volume.

The following is an output example of Thin Image pair information obtained by specifying the LDEV number of the primary volume and the snapshot group name:

```
{
  "data": [
    {
      "snapshotGroupName": "snapshotGroup",
      "primaryOrSecondary": "P-VOL",
      "status": "PSUS",
      "pvolLdevId": 100,
      "muNumber": 3,
      "svolLdevId": 101,
      "snapshotPoolId": 10,
      "concordanceRate": 100,
      "isConsistencyGroup": true,
      "isWrittenInSvol": false,
      "isClone": false,
      "canCascade": false,
      "splitTime": "2015-03-20T09:27:35",
      "snapshotId": "100,3"
    },
    {
      "snapshotGroupName": "snapshotGroup",
      "primaryOrSecondary": "P-VOL",
```



```

    "status": "PSUS",
    "pvolLdevId": 100,
    "muNumber": 4,
    "snapshotPoolId": 10,
    "concordanceRate": 100,
    "isConsistencyGroup": true,
    "isWrittenInSvol": false,
    "isClone": false,
    "canCascade": false,
    "splitTime": "2015-03-20T09:27:35",
    "snapshotId": "100,4"
  }
]
}

```

The following is an output example of Thin Image pair information obtained by specifying the LDEV number and the MU number of the primary volume:

```

{
  "data": [
    {
      "snapshotGroupName": "snapshotGroup",
      "primaryOrSecondary": "P-VOL",
      "status": "PSUS",
      "pvolLdevId": 100,
      "muNumber": 3,
      "svolLdevId": 101,
      "snapshotPoolId": 10,
      "concordanceRate": 100,
      "isConsistencyGroup": true,
      "isWrittenInSvol": false,
      "isClone": false,
      "canCascade": false,
      "splitTime": "2015-03-20T09:27:35",
      "snapshotId": "100,3"
    }
  ]
}

```

The following is an output example of Thin Image pair information obtained by specifying the LDEV number of the primary volume:

```

{
  "data": [
    {
      "snapshotGroupName": "snapshotGroup",
      "primaryOrSecondary": "P-VOL",
      "status": "PSUS",
      "pvolLdevId": 100,

```

```

    "muNumber": 3,
    "svolLdevId": 101,
    "snapshotPoolId": 10,
    "concordanceRate": 100,
    "isConsistencyGroup": true,
    "isWrittenInSvol": false,
    "isClone": false,
    "canCascade": false,
    "splitTime": "2015-03-20T09:27:35",
    "snapshotId": "100,3"
  },
  {
    "snapshotGroupName": "snapshotGroup",
    "primaryOrSecondary": "P-VOL",
    "status": "PSUS",
    "pvolLdevId": 100,
    "muNumber": 4,
    "snapshotPoolId": 10,
    "concordanceRate": 100,
    "isConsistencyGroup": true,
    "isWrittenInSvol": false,
    "isClone": false,
    "canCascade": false,
    "splitTime": "2015-03-20T09:27:35",
    "snapshotId": "100,4"
  }
]
}

```

The following is an output example of Thin Image pair information obtained by specifying the LDEV number of the secondary volume:

```

{
  "data": [
    {
      "snapshotGroupName": "snapshotGroup",
      "primaryOrSecondary": "P-VOL",
      "status": "PSUS",
      "pvolLdevId": 100,
      "muNumber": 3,
      "svolLdevId": 101,
      "snapshotPoolId": 10,
      "concordanceRate": 100,
      "isConsistencyGroup": true,
      "isWrittenInSvol": false,
      "isClone": false,
      "canCascade": false,
      "splitTime": "2015-03-20T09:27:35",
      "snapshotId": "100,3"
    }
  ]
}

```

```

    }
  ]
}

```

Attribute	Type	Description
snapshotGroupName	string	Name of the snapshot group that contains the Thin Image pairs. If the name of the snapshot group contains spaces, information about pairs is not output.
primaryOrSecondary	string	Attribute of the LDEV
status	string	Pair status For details, see the section explaining on pair status (Thin Image).
pvolLdevId	int	LDEV number of P-VOL
muNumber	int	MU number of the P-VOL
svolLdevId	int	LDEV number of S-VOL
snapshotPoolId	int	ID of the pool in which the snapshot data is created
concordanceRate	int	Concordance rate for pairs This attribute is output when any of the following conditions are met: <ul style="list-style-type: none"> The value of the <code>isClone</code> attribute is <code>false</code>, and the value of the <code>canCascade</code> attribute is also <code>false</code>. The value of the <code>isClone</code> attribute is <code>true</code>, and the value of the <code>status</code> attribute is not <code>COPY</code>, <code>RCPY</code>, <code>SMPP</code>, or <code>PSUP</code>. The value of the <code>canCascade</code> attribute is <code>true</code>, and the value of <code>status</code> attribute is not <code>COPY</code>, <code>RCPY</code>, <code>SMPP</code>, or <code>PSUP</code>.
progressRate	int	Progress of the processing

Attribute	Type	Description
		<p>This attribute is output when either of the following conditions is met:</p> <ul style="list-style-type: none"> The value of the <code>isClone</code> attribute is <code>true</code>, and the value of the <code>status</code> attribute is <code>COPY</code>, <code>RCPY</code>, <code>SMPP</code>, or <code>PSUP</code>. The value of the <code>canCascade</code> attribute is <code>true</code>, and the value of the <code>status</code> attribute is <code>COPY</code>, <code>RCPY</code>, <code>SMPP</code>, or <code>PSUP</code>.
<code>isConsistencyGroup</code>	boolean	<p>Returns whether the pair was created in the consistency group mode (CTG mode).</p> <ul style="list-style-type: none"> <code>true</code>: The pair was created in the CTG mode. <code>false</code>: The pair was not created in the CTG mode.
<code>isWrittenInSvol</code>	boolean	<p>Returns whether data was written to the S-VOL from the host when the pair status was <code>PSUS/PFUS</code>.</p> <ul style="list-style-type: none"> <code>true</code>: Data was written to the S-VOL <code>false</code>: Data was not written to the S-VOL
<code>isClone</code>	boolean	<p>Returns whether the pair has the clone attribute.</p> <ul style="list-style-type: none"> <code>true</code>: The pair has the clone attribute. <code>false</code>: The pair does not have the clone attribute.
<code>canCascade</code>	boolean	<p>Returns whether the pair can be a cascaded pair.</p> <ul style="list-style-type: none"> <code>true</code>: The pair can be a cascaded pair. <code>false</code>: The pair cannot be a cascaded pair.
<code>splitTime</code>	string	<p>Time when snapshot data was created</p> <p>The local time of the storage system is returned in YYYY-MM-DDThh:mm:ss format.</p>
<code>snapshotId</code>	string	<p>Object ID of the Thin Image pair</p> <p>The following attributes are output, separated by commas:</p> <ul style="list-style-type: none"> <code>pvolldevId</code> <code>muNumber</code>

Status codes

For details on the status codes of the request for this operation, see the description on HTTP status codes.

Coding example

When the LDEV number of the P-VOL and the snapshot group name are specified:

```
curl -v -H "Accept: application/json" -H "Authorization:Session
d7b673af189048468c5af9bcf3bbbb6f" -X GET "https://192.0.2.100/
ConfigurationManager/v1/objects/snapshots?
pvolLdevId=100&snapshotGroupName=snapshotGroup"
```

When the LDEV number and the MU number of the P-VOL are specified:

```
curl -v -H "Accept: application/json" -H "Authorization:Session
d7b673af189048468c5af9bcf3bbbb6f" -X GET "https://192.0.2.100/
ConfigurationManager/v1/objects/snapshots?pvolLdevId=100&muNumber=3"
```

When only the LDEV number of the P-VOL is specified:

```
curl -v -H "Accept: application/json" -H "Authorization:Session
d7b673af189048468c5af9bcf3bbbb6f" -X GET https://192.0.2.100/
ConfigurationManager/v1/objects/snapshots?pvolLdevId=100
```

If the secondary volume exists, when only the LDEV number of the S-VOL is specified:

```
curl -v -H "Accept: application/json" -H "Authorization:Session
d7b673af189048468c5af9bcf3bbbb6f" -X GET https://192.0.2.100/
ConfigurationManager/v1/objects/snapshots?svolLdevId=101
```

Getting information about a specific Thin Image pair

The following request gets information about the specified Thin Image pair. Use this information to check the information that is necessary for performing pair operations (for example, the pair status).

Execution permission

Storage Administrator (View Only)

Request line

```
GET base-URL/v1/objects/snapshots/object-ID
```

Request message**Object ID**

Specify the `snapshotId` value obtained by getting information about Thin Image pairs. You can also specify the following attributes and connect them with commas:

```
pvolLdevId,muNumber
```

Attribute	Type	Description
<code>pvolLdevId</code>	int	(Required) Specify the LDEV number of the P-VOL of the Thin Image pair. Specify a decimal (base 10) number equal to or greater than 0.
<code>muNumber</code>	int	(Required) Specify the MU number of the P-VOL of the Thin Image pair. Specify a value in the range from 0 to 1023.

Query parameters

None.

Body

None.

Response message**Body**

```
{
  "snapshotGroupName": "snapshotGroup",
  "primaryOrSecondary": "P-VOL",
  "status": "PSUS",
  "pvolLdevId": 100,
  "muNumber": 3,
  "svolLdevId": 101,
  "snapshotPoolId": 10,
  "concordanceRate": 100,
  "isConsistencyGroup": true,
  "isWrittenInSvol": false,
  "isClone": false,
  "canCascade": false,
  "splitTime": "2015-03-20T09:27:35",
  "snapshotId": "100,3"
}
```

Attribute	Type	Description
snapshotGroupName	string	Name of the snapshot group that contains the Thin Image pairs. If the name of the snapshot group contains spaces, information about pairs is not output.
primaryOrSecondary	string	Attribute of the LDEV
status	string	Pair status For details, see the section explaining on pair status (Thin Image).
pvolLdevId	int	LDEV number of P-VOL
muNumber	int	MU number of the P-VOL
svolLdevId	int	LDEV number of S-VOL
snapshotPoolId	int	ID of the pool in which the snapshot data is created
concordanceRate	int	Concordance rate for pairs This attribute is output when any of the following conditions are met: <ul style="list-style-type: none"> The value of the <code>isClone</code> attribute is <code>false</code>, and the value of the <code>canCascade</code> attribute is also <code>false</code>. The value of the <code>isClone</code> attribute is <code>true</code>, and the value of the <code>status</code> attribute is not <code>COPY</code>, <code>RCPY</code>, <code>SMPP</code>, or <code>PSUP</code>. The value of the <code>canCascade</code> attribute is <code>true</code>, and the value of <code>status</code> attribute is not <code>COPY</code>, <code>RCPY</code>, <code>SMPP</code>, or <code>PSUP</code>.
progressRate	int	Progress of the processing This attribute is output when either of the following conditions is met: <ul style="list-style-type: none"> The value of the <code>isClone</code> attribute is <code>true</code>, and the value of the <code>status</code> attribute is <code>COPY</code>, <code>RCPY</code>, <code>SMPP</code>, or <code>PSUP</code>. The value of the <code>canCascade</code> attribute is <code>true</code>, and the value of the <code>status</code> attribute is <code>COPY</code>, <code>RCPY</code>, <code>SMPP</code>, or <code>PSUP</code>.

Attribute	Type	Description
isConsistencyGroup	boolean	Returns whether the pair was created in the consistency group mode (CTG mode). <ul style="list-style-type: none"> ▪ <code>true</code>: The pair was created in the CTG mode. ▪ <code>false</code>: The pair was not created in the CTG mode.
isWrittenInSvol	boolean	Returns whether data was written to the S-VOL from the host when the pair status was <code>PSUS/PFUS</code> . <ul style="list-style-type: none"> ▪ <code>true</code>: Data was written to the S-VOL ▪ <code>false</code>: Data was not written to the S-VOL
isClone	boolean	Returns whether the pair has the clone attribute. <ul style="list-style-type: none"> ▪ <code>true</code>: The pair has the clone attribute. ▪ <code>false</code>: The pair does not have the clone attribute.
canCascade	boolean	Returns whether the pair can be a cascaded pair. <ul style="list-style-type: none"> ▪ <code>true</code>: The pair can be a cascaded pair. ▪ <code>false</code>: The pair cannot be a cascaded pair.
splitTime	string	Time when snapshot data was created The local time of the storage system is returned in YYYY-MM-DDThh:mm:ss format.
snapshotId	string	Object ID of the Thin Image pair The following attributes are output, separated by commas: <ul style="list-style-type: none"> ▪ <code>pvolLdevId</code> ▪ <code>muNumber</code>

Status codes

For details on the status codes of the request for this operation, see the description on HTTP status codes.

Coding example

```
curl -v -H "Accept: application/json" -H "Authorization:Session
d7b673af189048468c5af9bcf3bbbb6f" -X GET https://192.0.2.100/
ConfigurationManager/v1/objects/snapshots/100,3
```

Creating a Thin Image pair

The following request creates a Thin Image pair in the specified snapshot group. After the pair is created, you can get snapshot data or clone the pair.

Execution permission

Storage Administrator (Local Copy)

Request line

```
POST base-URL/v1/objects/snapshots
```

Request message

Object ID

None.

Query parameters

None.

Body

The following is an example of coding used for creating a Thin Image pair.

If the secondary volume does not exist :

```
{
  "snapshotGroupName": "snapshotGroup",
  "snapshotPoolId": 13,
  "pvolLdevId": 100,
  "isConsistencyGroup": true,
  "autoSplit": true,
  "isDataReductionForceCopy": true
}
```

If the secondary volume exists:

```
{
  "snapshotGroupName": "snapshotGroup",
  "snapshotPoolId": 13,
  "pvolLdevId": 100,
  "svolLdevId": 101,
  "isConsistencyGroup": true,
  "autoSplit": true,
  "isDataReductionForceCopy": true
}
```

Attribute	Type	Description
snapshotGroupName	string	<p>(Required) Specify the name of the snapshot group for which the Thin Image pair is to be created.</p> <p>Specify a character string consisting of 1 to 32 characters. The name is case sensitive. If you specify a new group name, a snapshot group is also created at the same time.</p>
snapshotPoolId	int	<p>(Required) Specify the ID of the pool in which snapshot data is to be created.</p> <p>Specify the ID of a Thin Image pool or an HDP pool by using a decimal (base 10) number equal to or greater than 0.</p>
pvolLdevId	int	<p>(Required) Specify the LDEV number of the P-VOL of the Thin Image pair to be created.</p> <p>Specify a decimal (base 10) number equal to or greater than 0.</p>
svolLdevId	int	<p>(Optional) Specify the LDEV number of the S-VOL of the Thin Image pair to be created.</p> <p>This item is required when <code>true</code> is specified for the <code>isClone</code> attribute.</p> <p>If you specified <code>true</code> for the <code>isClone</code> attribute or the <code>canCascade</code> attribute, specify the LDEV number of the DP volume.</p> <p>Specify a decimal (base 10) number equal to or greater than 0.</p> <p>If you do not specify this item, a Thin Image pair that does not have the S-VOL will be created.</p>
isConsistencyGroup	boolean	<p>(Optional) Regarding the snapshot group for which the Thin Image pair is to be created, specify whether the snapshot group is to be created in the consistency group mode (CTG mode).</p> <ul style="list-style-type: none"> ▪ <code>true</code>: Creates the snapshot group in the CTG mode. ▪ <code>false</code>: Does not create the snapshot group in the CTG mode.

Attribute	Type	Description
		If you do not specify this item, <i>false</i> will be set.
autoSplit	boolean	<p>(Optional) Specify whether the Thin Image pair is to be split after it is created.</p> <ul style="list-style-type: none"> ▪ <i>true</i>: Splits the pair. ▪ <i>false</i>: Does not split the pair. <p>If you specify <i>true</i>, the pair is split and snapshot data is stored.</p> <p>If you specify <i>true</i> for this attribute, you cannot specify <i>true</i> for the <i>isClone</i> attribute.</p> <p>If you do not specify this item, <i>false</i> will be set.</p>
canCascade	boolean	<p>(Optional) Specify whether the pair can be cascaded.</p> <ul style="list-style-type: none"> ▪ <i>true</i>: The pair can be cascaded. ▪ <i>false</i>: The pair cannot be cascaded. <p>If you specify <i>true</i> for the <i>isClone</i> attribute, also specify <i>true</i> for this attribute.</p> <p>If you do not specify this item, the same value as for the <i>isClone</i> attribute will be set.</p>
isClone	boolean	<p>(Optional) Specify whether to create a pair that has the clone attribute specified.</p> <ul style="list-style-type: none"> ▪ <i>true</i>: Creates a pair that has the clone attribute specified. ▪ <i>false</i>: Creates a pair that does not have the clone attribute specified. <p>If you specify <i>true</i> for this attribute, do not specify the <i>autoSplit</i> attribute.</p> <p>If you specify <i>true</i> for this attribute, specify <i>true</i> for the <i>canCascade</i> attribute.</p> <p>If you do not specify this item, <i>false</i> will be set.</p>
clonesAutomation	boolean	(Optional) Specify whether the pair is to be cloned after the pair is created.

Attribute	Type	Description
		<p>You can specify this item when <code>true</code> is specified for the <code>isClone</code> attribute.</p> <ul style="list-style-type: none"> ▪ <code>true</code>: Clones the pair. ▪ <code>false</code>: Does not clone the pair. <p>If you do not specify this item, <code>false</code> will be set.</p>
copySpeed	string	<p>(Optional) Specify the copy speed at which the created pair is to be cloned.</p> <p>You can specify this item when <code>true</code> is specified for both the <code>isClone</code> attribute and the <code>clonesAutomation</code> attribute.</p> <ul style="list-style-type: none"> ▪ <code>slower</code>: Low speed ▪ <code>medium</code>: Medium speed ▪ <code>faster</code>: High speed <p>This item is not case sensitive.</p> <p>If you do not specify this item, <code>medium</code> will be set.</p>
isDataReductionForceCopy	boolean	<p>(Optional) Specify whether to forcibly create a pair for the volume for which the capacity saving function (dedupe and compression) is enabled.</p> <ul style="list-style-type: none"> ▪ <code>true</code>: Forcibly create a pair for data reduplication volumes.# ▪ <code>false</code>: Do not forcibly create a pair for data reduplication volumes. <p>When the attribute is omitted, <code>false</code> is assumed.</p>

#: Copying data of the volume for which the capacity saving function (compression or deduplication) is enabled might take up to several months, depending on the amount of data. Be sure to take this into account when planning when to create such a pair. In addition, if `false` is specified for the `autoSplit` attribute, use the status of the target resource rather than the status of the job to check whether the pair has been created.

Response message**Body**

A job object is returned. For details on attributes other than `affectedResources`, see the section explaining job objects.

Attribute	Description
<code>affectedResources</code>	URL of the created Thin Image pair

Status codes

For details on the status codes of the request for this operation, see the description on HTTP status codes.

Coding example

```
curl -v -H "Accept: application/json" -H "Content-Type: application/json" -H "Authorization:Session d7b673af189048468c5af9bcf3b66b6f" -X POST --data-binary @./InputParameters.json https://192.0.2.100/ConfigurationManager/v1/objects/snapshots
```

Storing snapshot data in units of snapshot groups

The following request splits the Thin Image pairs in the specified snapshot group. You can split all pairs in that snapshot group and store snapshot data in a batch operation.

Execution permission

Storage Administrator (Local Copy)

Request line

```
POST base-URL/v1/objects/snapshot-groups/object-ID/actions/split/invoke
```

Request message**Object ID**

Specify the `snapshotGroupId` value obtained by getting information about the snapshot groups.

Attribute	Type	Description
<code>snapshotGroupId</code>	string	(Required) Object ID of the snapshot group to which the Thin Image pairs to be split belong.

Attribute	Type	Description
		Specify a character string consisting of 1 to 32 characters. The name is case sensitive.

Query parameters

None.

Body

None.

Response message**Body**

A job object is returned. For details on attributes other than `affectedResources`, see the section explaining job objects.

Attribute	Description
<code>affectedResources</code>	URL of the split snapshot group

Action template

```
GET base-URL/v1/objects/snapshot-groups/object-ID/actions/split
```

Status codes

The following table describes the meaning of the status code of the request for this operation. For details on other status codes, see the description on HTTP status codes.

Status codes	Message	Description
412	Precondition Failed	This object indicates that the following actions cannot run: actions specified when pairs are split in units of snapshot groups.

Coding example

To get an action template:

```
curl -v -H "Accept: application/json" -H "Authorization:Session d7b673af189048468c5af9bcf3bbbbb6f" -X GET https://192.0.2.100/ConfigurationManager/v1/objects/snapshot-groups/snapshotGroup/actions/split
```

To run the request after getting an action template:

```
curl -v -H "Content-type: application/json" -H "Accept: application/json" -H "Authorization:Session d7b673af189048468c5af9bcf3b6bb6f" -X POST https://192.0.2.100/ConfigurationManager/v1/objects/snapshot-groups/snapshotGroup/actions/split/invoke -d ""
```

Storing snapshot data

The following request splits the specified Thin Image pair. When the pair is split, snapshot data at the time of the split is stored.

Execution permission

Storage Administrator (Local Copy)

Request line

```
POST base-URL/v1/objects/snapshots/object-ID/actions/split/invoke
```

Request message

Object ID

Specify the `snapshotId` value obtained by getting information about Thin Image pairs. You can also specify the following attributes and connect them with commas:

```
pvolLdevId,muNumber
```

Attribute	Type	Description
<code>pvolLdevId</code>	int	(Required) Specify the LDEV number of the P-VOL of the Thin Image pair to be split. Specify a decimal (base 10) number equal to or greater than 0.
<code>muNumber</code>	int	(Required) Specify the MU number of the P-VOL of the Thin Image pair to be split. Specify a value in the range from 0 to 1023.

Query parameters

None.

Body

None.

Response message**Body**

A job object is returned. For details on attributes other than `affectedResources`, see the section explaining job objects.

Attribute	Description
<code>affectedResources</code>	URL of the split Thin Image pair

Action template

```
GET base-URL/v1/objects/snapshots/object-ID/actions/split
```

Status codes

The following table describes the meaning of the status code of the request for this operation. For details on other status codes, see the description on HTTP status codes.

Status codes	Message	Description
412	Precondition Failed	This object indicates that the following actions cannot run: actions specified when pairs are split.

Coding example

To get an action template:

```
curl -v -H "Accept: application/json" -H "Authorization:Session d7b673af189048468c5af9bcf3bbbb6f" -X GET https://192.0.2.100/ConfigurationManager/v1/objects/snapshots/100,3/actions/split
```

To run the request after getting an action template:

```
curl -v -H "Content-type: application/json" -H "Accept: application/json" -H "Authorization:Session d7b673af189048468c5af9bcf3bbbb6f" -X POST https://192.0.2.100/ConfigurationManager/v1/objects/snapshots/100,3/actions/split/invoke -d ""
```

Resynchronizing Thin Image pair in units of snapshot groups and deleting snapshot data

The following request resynchronizes the Thin Image pairs in the specified snapshot group. When pairs are resynchronized, all snapshot data will be deleted. You can store new snapshot data by specifying the setting to split the resynchronized pair.

Execution permission

Storage Administrator (Local Copy)

Request linePOST *base-URL/v1/objects/snapshot-groups/object-ID/actions/resync/invoke***Request message****Object ID**

Specify the `snapshotGroupId` value obtained by getting information about the snapshot groups.

Attribute	Type	Description
<code>snapshotGroupId</code>	string	(Required) Object ID of the snapshot group to which the Thin Image pairs to be resynchronized belong. Specify a character string consisting of 1 to 32 characters. The name is case sensitive.

Query parameters

None.

Body

```
{
  "parameters": {
    "autoSplit": false
  }
}
```

Attribute	Type	Description
<code>autoSplit</code>	boolean	(Optional) After resynchronization of the Thin Image pairs is complete, specify whether to split the pairs. <ul style="list-style-type: none"> <code>true</code>: Splits the pair. <code>false</code>: Does not split the pair. If you specify <code>true</code> , the pairs are split in units of snapshot groups and snapshot data is stored. If you do not specify this item, <code>false</code> will be set.

Response message**Body**

A job object is returned. For details on attributes other than `affectedResources`, see the section explaining job objects.

Attribute	Description
<code>affectedResources</code>	URL of the resynchronized snapshot group

Action template

```
GET base-URL/v1/objects/snapshot-groups/object-ID/actions/resync
```

Status codes

The following table describes the meaning of the status code of the request for this operation. For details on other status codes, see the description on HTTP status codes.

Status codes	Message	Description
412	Precondition Failed	This object indicates that the following actions cannot run: actions specified during the resynchronization of pairs in units of snapshot groups.

Coding example

To get an action template:

```
curl -v -H "Accept: application/json" -H "Authorization:Session d7b673af189048468c5af9bcf3bbbbb6f" -X GET https://192.0.2.100/ConfigurationManager/v1/objects/snapshot-groups/snapshotGroup/actions/resync
```

To run the request after getting an action template:

```
curl -v -H "Accept: application/json" -H "Content-Type: application/json" -H "Authorization:Session d7b673af189048468c5af9bcf3bbbbb6f" -X POST --data-binary @./InputParameters.json https://192.0.2.100/ConfigurationManager/v1/objects/snapshot-groups/snapshotGroup/actions/resync/invoke
```

Resynchronizing a Thin Image pair and deleting snapshot data

The following request uses the specified snapshot data to resynchronize a Thin Image pair. When the pair is resynchronized, all snapshot data will be deleted. You can store new snapshot data by specifying the setting to split the resynchronized pair.

Execution permission

Storage Administrator (Local Copy)

Request line

```
POST base-URL/v1/objects/snapshots/object-ID/actions/resync/invoke
```

Request message

Object ID

Specify the `snapshotId` value obtained by getting information about Thin Image pairs. You can also specify the following attributes and connect them with commas:

```
pvolLdevId,muNumber
```

Attribute	Type	Description
pvolLdevId	int	(Required) LDEV number of the P-VOL of the Thin Image pair to be resynchronized. Specify a decimal (base 10) number equal to or greater than 0.
muNumber	int	(Required) MU number of the P-VOL of the Thin Image pair to be resynchronized. Specify a value in the range from 0 to 1023.

Query parameters

None.

Body

```
{
  "parameters": {
    "autoSplit": false
  }
}
```

```
}
}
```

Attribute	Type	Description
autoSplit	boolean	(Optional) After resynchronization of the Thin Image pairs is complete, specify whether to split the pairs. <ul style="list-style-type: none"> ▪ <code>true</code>: Splits the pair. ▪ <code>false</code>: Does not split the pair. If you specify <code>true</code> , the pair is split and snapshot data is stored. If you do not specify this item, <code>false</code> will be set.

Response message

Body

A job object is returned. For details on attributes other than `affectedResources`, see the section explaining job objects.

Attribute	Description
<code>affectedResources</code>	URL of the resynchronized Thin Image pairs

Action template

```
GET base-URL/v1/objects/snapshots/object-ID/actions/resync
```

Status codes

The following table describes the meaning of the status code of the request for this operation. For details on other status codes, see the description on HTTP status codes.

Status codes	Message	Description
412	Precondition Failed	This object indicates that the following actions cannot run: actions specified during pair resynchronization.

Coding example

To get an action template:

```
curl -v -H "Accept: application/json" -H "Authorization:Session
d7b673af189048468c5af9bcf3b666f" -X GET https://192.0.2.100/
ConfigurationManager/v1/objects/snapshots/100,3/actions/resync
```

To run the request after getting an action template:

```
curl -v -H "Accept: application/json" -H "Content-Type: application/json" -
H "Authorization:Session d7b673af189048468c5af9bcf3b666f" -X POST --data-
binary @./InputParameters.json https://192.0.2.100/ConfigurationManager/v1/
objects/snapshots/100,3/actions/resync/invoke
```

Restoring snapshot data in units of snapshot groups

The following request restores the Thin Image pairs contained in the specified snapshot group. When the pairs are restored, the snapshot data for the primary volume is overwritten in units of the specified snapshot group.

Execution permission

Storage Administrator (Local Copy)

Request line

```
POST base-URL/v1/objects/snapshot-groups/object-ID/actions/restore/invoke
```

Request message**Object ID**

Specify the `snapshotGroupId` value obtained by getting information about the snapshot groups.

Attribute	Type	Description
snapshotGroupID	string	(Required) Object ID of the snapshot group to which the Thin Image pairs to be restored belong. Specify a character string consisting of 1 to 32 characters. The name is case sensitive.

Query parameters

None.

Body

```
{
  "parameters": {
    "autoSplit": false
  }
}
```

Attribute	Type	Description
autoSplit	boolean	(Optional) After the restore of the Thin Image pairs is complete, specify whether to split the pairs. <ul style="list-style-type: none"> ▪ <code>true</code>: Splits the pair. ▪ <code>false</code>: Does not split the pair. If you specify <code>true</code> , the pairs are split in units of snapshot groups and snapshot data is stored. If you do not specify this item, <code>false</code> will be set.

Response message**Body**

A job object is returned. For details on attributes other than `affectedResources`, see the section explaining job objects.

Attribute	Description
affectedResources	URL of the restored snapshot group

Action template

```
GET base-URL/v1/objects/snapshot-groups/object-ID/actions/restore
```

Status codes

The following table describes the meaning of the status code of the request for this operation. For details on other status codes, see the description on HTTP status codes.

Status codes	Message	Description
412	Precondition Failed	This object indicates that the following actions cannot run: actions specified during a restore of pairs in units of snapshot groups.

Coding example

To get an action template:

```
curl -v -H "Accept: application/json" -H "Authorization:Session
d7b673af189048468c5af9bcf3bbbb6f" -X GET https://192.0.2.100/
ConfigurationManager/v1/objects/snapshot-groups/snapshotGroup/actions/
restore
```

To run the request after getting an action template:

```
curl -v -H "Accept: application/json" -H "Content-Type: application/json" -
H "Authorization:Session d7b673af189048468c5af9bcf3bbbb6f" -X POST --data-
binary @./InputParameters.json https://192.0.2.100/ConfigurationManager/v1/
objects/snapshot-groups/snapshotGroup/actions/restore/invoke
```

Restoring snapshot data

The following request restores a Thin Image pair by using the specified snapshot data. When the pair is restored, the data of the snapshot specified for the primary volume is overwritten.

Execution permission

Storage Administrator (Local Copy)

Request line

```
POST base-URL/v1/objects/snapshots/object-ID/actions/restore/invoke
```

Request message**Object ID**

Specify the `snapshotId` value obtained by getting information about Thin Image pairs. You can also specify the following attributes and connect them with commas:

```
pvollDevId,muNumber
```

Attribute	Type	Description
pvollDevId	int	(Required) LDEV number of the P-VOL of the Thin Image pair to be restored Specify a decimal (base 10) number equal to or greater than 0.

Attribute	Type	Description
muNumber	int	(Required) MU number of the P-VOL of the Thin Image pair to be restored Specify a value in the range from 0 to 1023.

Query parameters

None.

Body

```
{
  "parameters": {
    "autoSplit": false
  }
}
```

Attribute	Type	Description
autoSplit	boolean	(Optional) After a restore of the Thin Image pairs is complete, specify whether to split the pairs. <ul style="list-style-type: none"> ▪ <code>true</code>: Splits the pair. ▪ <code>false</code>: Does not split the pair. If you specify <code>true</code> , the pair is split and snapshot data is stored. If you do not specify this item, <code>false</code> will be set.

Response message**Body**

A job object is returned. For details on attributes other than `affectedResources`, see the section explaining job objects.

Attribute	Description
affectedResources	URL of the restored Thin Image pair

Action template

```
GET base-URL/v1/objects/snapshots/object-ID/actions/restore
```

Status codes

The following table describes the meaning of the status code of the request for this operation. For details on other status codes, see the description on HTTP status codes.

Status codes	Message	Description
412	Precondition Failed	This object indicates that the following actions cannot run: actions specified during a restore of pairs.

Coding example

To get an action template:

```
curl -v -H "Accept: application/json" -H "Authorization:Session d7b673af189048468c5af9bcf3bbbb6f" -X GET https://192.0.2.100/ConfigurationManager/v1/objects/snapshots/100,3/actions/restore
```

To run the request after getting an action template:

```
curl -v -H "Accept: application/json" -H "Content-Type: application/json" -H "Authorization:Session d7b673af189048468c5af9bcf3bbbb6f" -X POST --data-binary @./InputParameters.json https://192.0.2.100/ConfigurationManager/v1/objects/snapshots/100,3/actions/restore/invoke
```

Assigning a secondary volume to snapshot data

The following request assigns a secondary volume to snapshot data of a Thin Image pair.

Execution permission

Storage Administrator (Local Copy)

Request line

```
POST base-URL/v1/objects/snapshots/object-ID/actions/assign-volume/invoke
```

Request message**Object ID**

Specify the `snapshotId` value obtained by getting information about Thin Image pairs. You can also specify the following attributes and connect them with commas:

```
pvolLdevId,muNumber
```

Attribute	Type	Description
pvolLdevId	int	(Required) LDEV number of the P-VOL of a Thin Image pair that has snapshot data Specify a decimal (base 10) number equal to or greater than 0.
muNumber	int	(Required) MU number of the P-VOL of a Thin Image pair that has snapshot data Specify a value in the range from 0 to 1023.

Query parameters

None.

Body

```
{
  "parameters": {
    "svolLdevId": 101
  }
}
```

Attribute	Type	Description
svolLdevId	int	(Required) LDEV number of the S-VOL to be assigned to the snapshot data Specify a decimal (base 10) number equal to or greater than 0. For the S-VOL, specify a virtual volume for Thin Image that was created beforehand.

Response message**Body**

A job object is returned. For details on attributes other than `affectedResources`, see the section explaining job objects.

Attribute	Description
affectedResources	URL of the Thin Image pair whose S-VOL was assigned

Action template

```
GET base-URL/v1/objects/snapshots/object-ID/actions/assign-volume
```

Status codes

The following table describes the meaning of the status code of the request for this operation. For details on other status codes, see the description on HTTP status codes.

Status codes	Message	Description
412	Precondition Failed	This object indicates that the following actions cannot run: actions specified during S-VOL assignment.

Coding example

To get an action template:

```
curl -v -H "Accept: application/json" -H "Authorization:Session d7b673af189048468c5af9bcf3bbbbb6f" -X GET https://192.0.2.100/ConfigurationManager/v1/objects/snapshots/100,3/actions/assign-volume
```

To run the request after getting an action template:

```
curl -v -H "Accept: application/json" -H "Content-Type: application/json" -H "Authorization:Session d7b673af189048468c5af9bcf3bbbbb6f" -X POST --data-binary @./InputParameters.json https://192.0.2.100/ConfigurationManager/v1/objects/snapshots/100,3/actions/assign-volume/invoke
```

Unassigning the secondary volume for snapshot data

The following request unassigns the secondary volume for the snapshot data of Thin Image pairs.

Execution permission

Storage Administrator (Local Copy)

Request line

```
POST base-URL/v1/objects/snapshots/object-ID/actions/unassign-volume/invoke
```

Request message**Object ID**

Specify the `snapshotId` value obtained by getting information about Thin Image pairs. You can also specify the following attributes and connect them with commas:

```
pvolLdevId, muNumber
```

Attribute	Type	Description
<code>pvolLdevId</code>	int	(Required) LDEV number of the P-VOL of a Thin Image pair that has snapshot data Specify a decimal (base 10) number equal to or greater than 0.
<code>muNumber</code>	int	(Required) MU number of the P-VOL of a Thin Image pair that has snapshot data Specify a value in the range from 0 to 1023.

Query parameters

None.

Body

None.

Response message**Body**

A job object is returned. For details on attributes other than `affectedResources`, see the section explaining job objects.

Attribute	Description
<code>affectedResources</code>	URL of the Thin Image pair whose S-VOL was unassigned

Action template

```
GET base-URL/v1/objects/snapshots/object-ID/actions/unassign-volume
```

Status codes

The following table describes the meaning of the status code of the request for this operation. For details on other status codes, see the description on HTTP status codes.

Status codes	Message	Description
412	Precondition Failed	This object indicates that the following actions cannot run: actions specified when an S-VOL is unassigned.

Coding example

To get an action template:

You can check whether the secondary volume of a Thin Image pair that has a specified object ID can be unassigned.

```
curl -v -H "Accept: application/json" -H "Authorization:Session d7b673af189048468c5af9bcf3bbbbb6f" -X GET https://192.0.2.100/ConfigurationManager/v1/objects/snapshots/100,3/actions/unassign-volume
```

To run the request after getting an action template:

```
curl -v -H "Content-type: application/json" -H "Accept: application/json" -H "Authorization:Session d7b673af189048468c5af9bcf3bbbbb6f" -X POST https://192.0.2.100/ConfigurationManager/v1/objects/snapshots/100,3/actions/unassign-volume/invoke -d ""
```

Deleting Thin Image pairs in units of snapshot groups

The following request deletes the Thin Image pairs contained in the specified snapshot group. When the pairs are deleted, all snapshot data is also deleted.

Execution permission

Storage Administrator (Local Copy)

Request line

```
DELETE base-URL/v1/objects/snapshot-groups/object-ID
```

Request message

Object ID

Specify the `snapshotGroupId` value obtained by getting information about the snapshot groups.

Attribute	Type	Description
snapshotGroupId	string	(Required) Object ID of the snapshot group to which the Thin Image pairs to be deleted belong. Specify a character string consisting of 1 to 32 characters. The name is case sensitive.

Query parameters

None.

Body

None.

Response message**Body**

A job object is returned. For details on attributes other than `affectedResources`, see the section explaining job objects.

Attribute	Description
affectedResources	URL of the deleted snapshot group

Status codes

For details on the status codes of the request for this operation, see the description on HTTP status codes.

Coding example

```
curl -v -H "Accept: application/json" -H "Authorization:Session
d7b673af189048468c5af9bcf3bbbb6f" -X DELETE https://192.0.2.100/
ConfigurationManager/v1/objects/snapshot-groups/snapshotGroup
```

Deleting a Thin Image pair

The following request deletes the specified Thin Image pair. When the pair is deleted, the snapshot data is also deleted.

Execution permission

Storage Administrator (Local Copy)

Request line

```
DELETE base-URL/v1/objects/snapshots/object-ID
```

Request message**Object ID**

Specify the `snapshotId` value obtained by getting information about a Thin Image pair. You can also specify the following attributes and connect them with commas:

```
pvolLdevId,muNumber
```

Attribute	Type	Description
<code>pvolLdevId</code>	int	(Required) Specify the LDEV number of the P-VOL of the Thin Image pair to be deleted. Specify a decimal (base 10) number equal to or greater than 0.
<code>muNumber</code>	int	(Required) Specify the MU number of the P-VOL of the Thin Image pair to be deleted. Specify a value in the range from 0 to 1023.

Query parameters

None.

Body

None.

Response message**Body**

A job object is returned. For details on attributes other than `affectedResources`, see the section explaining job objects.

Attribute	Description
<code>affectedResources</code>	URL of the deleted Thin Image pair

Status codes

For details on the status codes of the request for this operation, see the description on HTTP status codes.

Coding example

```
curl -v -H "Accept: application/json" -H "Authorization:Session
d7b673af189048468c5af9bcf3bb6f" -X DELETE https://192.0.2.100/
ConfigurationManager/v1/objects/snapshots/100,3
```

Deleting Thin Image pairs by snapshot tree

Forcibly delete all Thin Image pairs in the snapshot tree where the cascade attribute for the pair is enabled. When the pairs are deleted, the snapshot data will also be deleted. Before running this API, we recommend that you check information about the pairs within the snapshot tree to confirm that all pairs within the snapshot tree have been deleted.

**Tip:**

If you use a configuration in which multiple snapshot trees are connected through pairs whose clone attribute is enabled, specify the root volume of the top snapshot tree first and run the API request. This action does not delete pairs in the snapshot trees under the secondary volumes of pairs whose clone attribute is enabled, but changes the statuses of pairs in those snapshot trees to `PSUE`.

Then, specify the root volume of the snapshot tree under the secondary volume, and run the API request.

Execution permission

Storage Administrator (Local Copy)

Request line

```
POST base-URL/v1/services/snapshot-tree/actions/delete/invoke
```

Request message**Object ID**

None.

Query parameters

None.

Body

```
{
  "parameters": {
    "ldevId": 1
  }
}
```



```
}
}
```

Attribute	Type	Description
ldevId	int	(Required) LDEV number of the root volume

Response message

Body

A job object is returned. For details on attributes other than `affectedResources`, see the section that explains job objects.

Attribute	Description
<code>affectedResources</code>	<p>URL of the root volume</p> <p>By referring to the <code>attributes</code> attribute value, confirm that this is no longer a Thin Image volume.</p> <p>To verify that all pairs within the snapshot tree have been deleted, obtain the pair statuses and volume attributes based on the pair information you confirmed in advance.</p>

Action template

None.

Status codes

For details about the status codes issued in response to requests for this operation, see the description of HTTP status codes.

Code example

```
curl -v -H "Accept:application/json" -H "Content-Type:application/json" -H
"Authorization:Session d7b673af189048468c5af9bcf3b6f" -X POST --data-
binary @./InputParameters.json https://192.0.2.100/ConfigurationManager/v1/
services/snapshot-tree/actions/delete/invoke
```

Cloning pairs in a specified snapshot group

The following request clones the Thin Image pairs in a specified snapshot group. You can use this request to clone all of the pairs in a snapshot group in a batch operation.

Execution permission

Storage Administrator (Local Copy)

Request linePOST *base-URL/v1/objects/snapshot-groups/object-ID/actions/clone/invoke***Request message****Object ID**

Specify the `snapshotGroupId` value obtained by getting information about the snapshot groups.

Attribute	Type	Description
<code>snapshotGroupId</code>	string	(Required) Object ID of the snapshot group to which the Thin Image pairs to be cloned belong Specify a character string consisting of 1 to 32 characters. The name is case sensitive.

Query parameters

None.

Body

```
{
  "parameters": {
    "copySpeed": "medium"
  }
}
```

Attribute	Type	Description
<code>copySpeed</code>	string	(Optional) Specify the copy speed. You can specify the following values: <ul style="list-style-type: none"> ▪ <code>slower</code>: Low speed ▪ <code>medium</code>: Medium speed ▪ <code>faster</code>: High speed This item is not case sensitive. If you do not specify this item, <code>medium</code> will be set.

Response message**Body**

A job object is returned. For details on attributes other than `affectedResources`, see the section explaining job objects.

Attribute	Description
<code>affectedResources</code>	URL of the snapshot group that was cloned

Action template

```
GET base-URL/v1/objects/snapshot-groups/object-ID/actions/clone
```

Status codes

The following table describes the meaning of the status code of the request for this operation. For details on other status codes, see the description on HTTP status codes.

Status codes	Message	Description
412	Precondition Failed	This indicates that the specified snapshot group cannot be cloned.

Coding example

To get an action template:

```
curl -v -H "Accept: application/json" -H "Authorization:Session
d7b673af189048468c5af9bcf3b6bb6f" -X GET https://192.0.2.100/
ConfigurationManager/v1/objects/snapshot-groups/snapshotGroup/actions/clone
```

To run the request after getting an action template:

```
curl -v -H "Accept: application/json" -H "Authorization:Session
d7b673af189048468c5af9bcf3b6bb6f" --data-binary @./InputParameters.json -X
POST https://192.0.2.100/ConfigurationManager/v1/objects/snapshot-groups/
snapshotGroup/actions/clone/invoke
```

Cloning a Thin Image pair

The following request clones the specified Thin Image pair.

Execution permission

Storage Administrator (Local Copy)

Request line

```
POST base-URL/v1/objects/snapshots/object-ID/actions/clone/invoke
```

Request message**Object ID**

Specify the `snapshotId` value obtained by getting information about Thin Image pairs. You can also specify the following attributes and connect them with commas:

```
pvolLdevId,muNumber
```

Attribute	Type	Description
<code>pvolLdevId</code>	int	(Required) LDEV number of the P-VOL of the Thin Image pair to be cloned Specify a decimal (base 10) number equal to or greater than 0.
<code>muNumber</code>	int	(Required) MU number of the P-VOL of the Thin Image pair to be cloned Specify a value in the range from 0 to 1023.

Query parameters

None.

Body

```
{
  "parameters": {
    "copySpeed": "medium"
  }
}
```

Attribute	Type	Description
<code>copySpeed</code>	string	(Optional) Specify the copy speed. You can specify the following values: <ul style="list-style-type: none"> ▪ <code>slower</code>: Low speed ▪ <code>medium</code>: Medium speed ▪ <code>faster</code>: High speed This item is not case sensitive.

Attribute	Type	Description
		If you do not specify this item, <code>medium</code> will be set.

Response message

Body

A job object is returned. For details on attributes other than `affectedResources`, see the section explaining job objects.

Attribute	Description
<code>affectedResources</code>	URL of the Thin Image pair that was cloned

Action template

```
GET base-URL/v1/objects/snapshots/object-ID/actions/clone
```

Status codes

The following table describes the meaning of the status code of the request for this operation. For details on other status codes, see the description on HTTP status codes.

Status codes	Message	Description
412	Precondition Failed	This indicates that the specified pair cannot be cloned.

Coding example

To get an action template:

```
curl -v -H "Accept: application/json" -H "Authorization:Session
d7b673af189048468c5af9bcf3bbbbb6f" -X GET https://192.0.2.100/
ConfigurationManager/v1/objects/snapshots/100,3/actions/clone
```

To run the request after getting an action template:

```
curl -v -H "Accept: application/json" -H "Authorization:Session
d7b673af189048468c5af9bcf3bbbbb6f" --data-binary @./InputParameters.json -X
POST https://192.0.2.100/ConfigurationManager/v1/objects/snapshots/100,3/
actions/clone/invoke
```

Chapter 10: Configuring a remote copy environment

This chapter describes how to configure a remote copy environment by using the REST API.



Workflow for configuring a remote copy environment

The following describes the workflow for configuring an environment required to use TrueCopy, Universal Replicator, or global-active device (GAD).

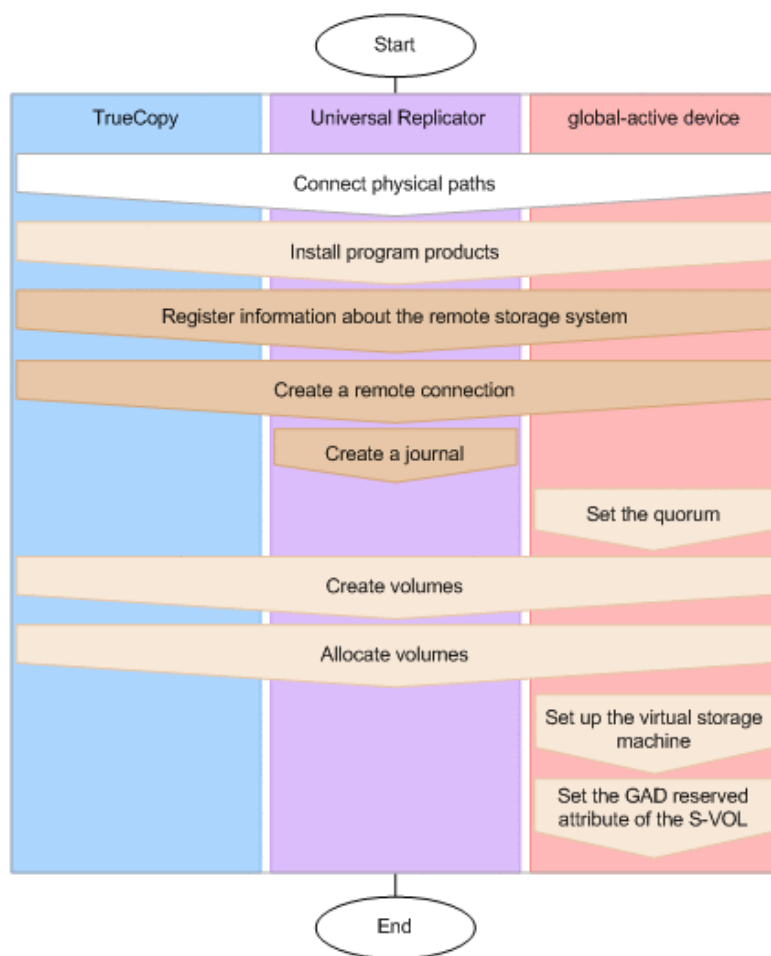
The following figure shows the workflow for configuring an environment.



Legend:

-  : Operation that can be performed by using the REST API
-  : Operation that can be performed by using the REST API and is described in this chapter
-  : Other operation

Connecting physical paths

Use cables to connect between hardware objects according to the configuration required for the operation, such as between the host and the storage system, and between the primary site and the secondary site.

Installing software products

Install software products that are required for remote copy operations.

Registering information about the remote storage system

For remote connections, register information about the remote storage system for the REST API server of the local storage system, and information about the local storage system for the REST API server of the remote storage system.

Alternatively, you can register information about the remote storage system only.

Creating a remote connection

Create a remote connection by specifying a remote path. If you use an iSCSI port, register in advance the information about the iSCSI port of the remote storage system for the iSCSI port of the local storage system.

Creating a journal

Create a journal by specifying a journal volume.

Setting the quorum

Specify settings related to the quorum.

You can perform this operation by using Platform REST API (Simple). For details, see the relevant descriptions on the [Hitachi Vantara Knowledge](#).

Creating volumes

Create volumes to be used for a pair.

Allocating volumes

Set LU paths so that the host can access the volumes in the storage system.

Setting up the virtual storage machine

Create a virtual storage machine in the storage system, and then specify the required settings.

Setting the GAD reserved attribute of S-VOL

For the virtual LDEV number of S-VOL, set the global-active device reserved attribute number.

For details on configuring a remote copy environment, see the manual of each software product or *System Administrator Guide*.

Registering and deleting information about remote storage systems

This section describes how to register and delete information about remote storage systems by using the REST API.

Overview of registering and deleting information about remote storage systems

For remote copy, by registering in advance the information about storage systems that are remotely connected to the REST API server, you no longer need to specify the remotely-connected storage system information when the remote copy operation is performed.

Register the following storage system information: model name of the remotely-connected storage system, and the controller IP address and communication mode. The information about the remote storage system will be registered to the REST API server of the local storage system while the information about the local storage system will be registered to the REST API server of the remote storage system.

You can use the following API commands for registering and deleting the information about remote storage systems:

- Registering information about remote storage systems to the REST API server
- Deleting information about remote storage systems from the REST API server
- Obtaining information about remote storage systems registered on the REST API server

Getting a list of remote storage systems

The following request gets a list of information about the storage systems registered on the REST API server.

Execution permission

Storage Administrator (View Only)

Request line

```
GET base-URL/v1/objects/remote-storages
```

Request message

Object ID

None.

Query parameters

None.

Body

None.

Response message

Body

```
{
  "data": [
    {
      "storageDeviceId": "886000123456",
      "dkcType": "Local",
      "restServerIp": "192.0.2.100",
      "restServerPort": 443,
    }
  ]
}
```

```

    "model": "VSP G900",
    "serialNumber": 123456,
    "ctl1Ip": "192.0.10.10",
    "ctl2Ip": "192.0.10.11",
    "communicationModes": [
      {
        "communicationMode": "lanConnectionMode"
      }
    ]
  },
  {
    "storageDeviceId": "886000123457",
    "dkcType": "Remote",
    "restServerIp": "192.0.2.101",
    "restServerPort": 443,
    "model": "VSP G900",
    "serialNumber": 123457,
    "ctl1Ip": "192.0.10.20",
    "ctl2Ip": "192.0.10.21",
    "communicationModes": [
      {
        "communicationMode": "lanConnectionMode"
      }
    ]
  }
]
}

```

Attribute	Type	Description
storageDeviceId	string	Storage device ID
dkcType	string	Type of storage system <ul style="list-style-type: none"> Local: Local storage system (The storage system where the REST API server that received the request exists.) Remote: Remote storage system (The storage system registered on the REST API server of the local storage system.)
restServerIp	string	IP address used by the REST API server of the remote storage system
restServerPort	int	Port number used for SSL communication by the REST API server of the remote storage system
model	string	Model name of the storage system

Attribute	Type	Description
serialNumber	int	Serial number of the storage system
ctl1Ip	string	IP address of controller board 1
ctl2Ip	string	IP address of controller board 2
communicationModes	object[]	<p>The following attributes related to the communication mode between the REST API server and the storage system are output:</p> <p>If multiple communication modes are output, the mode that is output at the top will be prioritized in communication.</p> <ul style="list-style-type: none"> ▪ communicationMode (string) Communication mode <ul style="list-style-type: none"> ▪ proxyMode ▪ lanConnectionMode ▪ proxies (object[]) <p>The following attributes about the relay server are output:</p> <ul style="list-style-type: none"> ▪ proxyIp (string) IP address ▪ proxyPort (int) Port number

Status codes

For details on the status codes of the request for this operation, see the description on HTTP status codes.

Coding example

```
curl -v -H "Accept: application/json" -H "Authorization:Session
d7b673af189048468c5af9bcf3bbbbb6f" -X GET https://192.0.2.100/
ConfigurationManager/v1/objects/remote-storages
```

Getting information about a specific remote storage system

The following request gets information about a specific remote storage system registered on the REST API server.

Execution permission

Storage Administrator (View Only)

Request lineGET *base-URL/v1/objects/remote-storages/object-ID***Request message****Object ID**

Specify the `storageDeviceId` value obtained by getting information about the storage systems.

Attribute	Type	Description
<code>storageDeviceId</code>	string	(Required) Storage device ID

Query parameters

None.

Body

None.

Response message**Body**

```
{
  "storageDeviceId": "886000123456",
  "dkcType": "Local",
  "restServerIp": "192.0.2.100",
  "restServerPort": 443,
  "model": "VSP G900",
  "serialNumber": 123456,
  "ctl1Ip": "192.0.10.10",
  "ctl2Ip": "192.0.10.11",
  "communicationModes": [
    {
      "communicationMode": "lanConnectionMode"
    }
  ]
}
```

Attribute	Type	Description
storageDeviceId	string	Storage device ID
dkcType	string	Type of storage system <ul style="list-style-type: none"> ▪ Local: Local storage system (The storage system where the REST API server that received the request exists.) ▪ Remote: Remote storage system (The storage system registered on the REST API server of the local storage system.)
restServerIp	string	IP address used by the REST API server of the remote storage system
restServerPort	int	Port number used for SSL communication by the REST API server of the remote storage system
model	string	Model name of the storage system
serialNumber	int	Serial number of the storage system
ctl1Ip	string	IP address of controller board 1
ctl2Ip	string	IP address of controller board 2
communicationModes	object[]	The following attributes related to the communication mode between the REST API server and the storage system are output:

Attribute	Type	Description
		<p>If multiple communication modes are output, the mode that is output at the top will be prioritized in communication.</p> <ul style="list-style-type: none"> ▪ communicationMode (string) Communication mode <ul style="list-style-type: none"> ▪ proxyMode ▪ lanConnectionMode ▪ proxies (object[]) The following attributes about the relay server are output: <ul style="list-style-type: none"> ▪ proxyIp (string) IP address ▪ proxyPort (int) Port number

Status codes

For details on the status codes of the request for this operation, see the description on HTTP status codes.

Coding example

```
curl -v -H "Accept: application/json" -H "Authorization:Session
d7b673af189048468c5af9bcf3bbbbb6f" -X GET https://192.0.2.100/
ConfigurationManager/v1/objects/remote-storages/886000123456
```

Registering information about remote storage systems

The following request registers information about the remote storage system on the REST API server of the local storage system, and information about the local storage system on the REST API server of the remote storage system. Alternatively, you can register information about the remote storage system only.

Execution permission

Storage Administrator (Initial Configuration)

Request linePOST *base-URL*/v1/objects/remote-storages**Request message****Object ID**

None.

Query parameters

None.

Body

```
{
  "storageDeviceId": "886000123457",
  "restServerIp": "192.0.2.101",
  "restServerPort": 443,
  "isMutualDiscovery": true
}
```

Attribute	Type	Description
storageDeviceId	string	(Required) Storage device ID of the remote storage system
restServerIp	string	(Required) IP address used by the REST API server of the remote storage system You can specify an IPv4 address, IPv6 address, or a host name.
restServerPort	int	(Required) Port number used for SSL communication by the REST API server of the remote storage system
isMutualDiscovery	boolean	(Optional) Specify whether to perform a mutual registration operation. You can specify whether to register information about the local storage system on the REST API server of the remote storage system. <ul style="list-style-type: none"> ▪ <code>true</code>: Perform a mutual registration operation. ▪ <code>false</code>: Do not perform a mutual registration operation. If this value is omitted, <code>true</code> is specified.

Response message**Body**

A job object is returned. For details on attributes other than `affectedResources`, see the section explaining job objects.

Attribute	Description
<code>affectedResources</code>	URL of the registered remote storage system

Status codes

For details on the status codes of the request for this operation, see the description on HTTP status codes.

Coding example

```
curl -v -H "Accept:application/json" -H "Content-Type:application/json" -H
"Remote-Authorization:Session 10399a1ffce3489b9c3a823017462396" -H
"Authorization:Session d7b673af189048468c5af9bcf3b6bb6f" -X POST --data-
binary @./InputParameters.json https://192.0.2.100/ConfigurationManager/v1/
objects/remote-storages
```

Deleting information about remote storage systems

The following request deletes information about the remote storage system that is registered on the REST API server of the local storage system and information about the local storage system that is registered on the REST API server of the remote storage system. Alternatively, you can delete the information that is registered in the local storage system only. To change information about storage systems registered on the REST API server, delete the information about the storage systems, and then register information again.

Execution permission

Storage Administrator (Initial Configuration)

Request line

```
DELETE base-URL/v1/objects/remote-storages/object-ID
```

Request message**Object ID**

Specify the `storageDeviceId` value obtained by getting information about the storage systems.

Attribute	Type	Description
<code>storageDeviceId</code>	string	(Required) Storage device ID

Query parameters

None.

Body

```
{
  "isMutualDeletion": true
}
```

Attribute	Type	Description
<code>isMutualDeletion</code>	boolean	<p>(Optional) Specify whether to perform a mutual deletion operation.</p> <p>You can specify whether to delete information about the local storage system registered on the REST API server of the remote storage system.</p> <ul style="list-style-type: none"> ▪ <code>true</code>: Perform a mutual deletion operation. ▪ <code>false</code>: Do not perform a mutual deletion operation. <p>If this value is omitted, <code>true</code> is specified.</p>

Response message**Body**

A job object is returned. For details on attributes other than `affectedResources`, see the section explaining job objects.

Attribute	Description
<code>affectedResources</code>	URL of the deleted storage system

Status codes

For details on the status codes of the request for this operation, see the description on HTTP status codes.

Coding example

```
curl -v -H "Accept:application/json" -H "Content-Type:application/json" -H
"Remote-Authorization:Session 10399a1ffce3489b9c3a823017462396" -H
"Authorization:Session d7b673af189048468c5af9bcf3b66b6f" -X DELETE --data-
binary @./InputParameters.json https://192.0.2.100/ConfigurationManager/v1/
objects/remote-storages/886000123457
```

Setting remote connections

This section describes how to specify settings of remote connections used for remote copy operations by using the REST API.

Overview of the remote connection settings

Remote connections are used to connect storage systems used in remote copy operations for TrueCopy, Universal Replicator, and global-active device.

In this manual, the storage system that receives requests from the REST API clients is called a local storage system, and the storage system that is remotely connected to the local storage system is called a remote storage system.

The following figure shows an example of a remote connection:

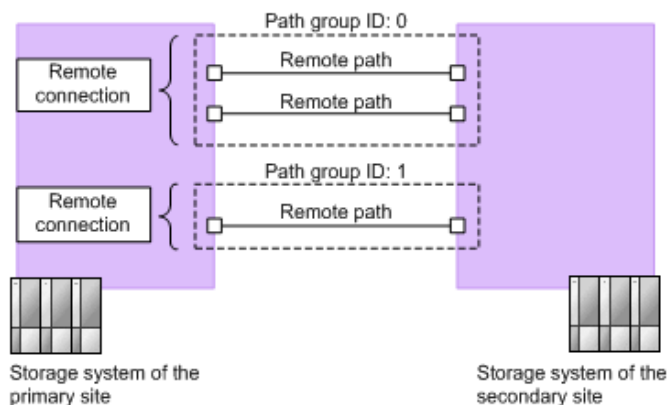

Remote path

A logical path that connects storage systems on the primary site and the secondary site is called a remote path.

A combination of port numbers that a logical path consists of is defined as a remote path.

Remote connections

A remote connection consists of a group of remote paths that connect the storage system on the primary site (MCU) and the storage system on the secondary site (RCU).

A remote connection consists of one or more remote paths, and a unique path group ID is assigned to each remote connection for management.

To set a remote connection by using the copy direction from the remote storage system to the local storage system, specify settings from a REST API client of the remote storage system.

The following is a list of operations that can be performed for remote connections by using the REST API.

- Create remote connections
- Change remote connection settings
- Add remote paths to remote connections
- Delete remote paths from remote connections
- Delete remote connections
- Get information about remote connections

To create a remote path for an iSCSI port, register in advance information about the iSCSI port of the remote storage system to the iSCSI port of the local storage system.

The following is a list of operations that can be performed for iSCSI ports by using the REST API.

- Register iSCSI ports
- Delete iSCSI ports
- Get information about iSCSI ports

Getting a list of remote connections

The following request gets a list of remote connections.

Execution permission

Storage Administrator (View Only)

Request line

```
GET base-URL/v1/objects/remotepath-groups
```

Request message**Object ID**

None.

Query parameters

None.

Body

None.

Response message**Body**

The following is an example of the output when information about the remote storage system is not registered on the REST API server:

```
{
  "data": [
    {
      "remotepathGroupId": "492015,M8,0",
      "remoteSerialNumber": "492015",
      "remoteStorageTypeId": "M8",
      "pathGroupId": 0,
      "cuType": "REMOTE",
      "portType": "FIBRE",
      "cuStatus": "NML",
      "minNumOfPaths": 1,
      "numOfPaths": 1,
      "timeoutValueForRemoteIOInSeconds": 15,
      "roundTripTimeInMilliseconds": 1
    }
  ]
}
```

The following is an example of the output when information about the remote storage system is registered on the REST API server:

```
{
  "data": [
    {
      "remotepathGroupId": "492015,M8,0",
      "remoteStorageDeviceId": "886000492015",
      "remoteSerialNumber": "492015",
      "remoteStorageModel": "VSP G900",
      "remoteStorageTypeId": "M8",
      "pathGroupId": 0,
      "cuType": "REMOTE",
      "portType": "FIBRE",
    }
  ]
}
```

```

    "cuStatus": "NML",
    "minNumOfPaths": 1,
    "numOfPaths": 1,
    "timeoutValueForRemoteIOInSeconds": 15,
    "roundTripTimeInMilliseconds": 1
  }
]
}

```

Attribute	Type	Description
remotepathGroupId	string	Object ID for the remote connection
remoteStorageDeviceId	string	Storage device ID of the remote storage system This attribute is output when information about the remote storage system is registered on the REST API server.
remoteSerialNumber	string	Serial number of the remote storage system
remoteStorageModel	string	Model type of the remote storage system This attribute is output when information about the remote storage system is registered on the REST API server.
remoteStorageTypeId	string	ID that indicates the model of the remote storage system <ul style="list-style-type: none"> ▪ R8: VSP G1000, VSP G1500, or VSP F1500 ▪ M8: VSP G350, G370, G700, G900, VSP F350, F370, F700, F900
pathGroupId	int	Path group ID If the connection setting for the remote path is CU specific, this information is not output.
localCuNumber	string	CU number of the local storage system (MCU) This item is hidden when the value of the connection setting of the remote path is CU Free or when the value of the <code>cuType</code> attribute is LOCAL.

Attribute	Type	Description
remoteCuNumber	string	CU number of the remote storage system (RCU) This item is hidden when the value of the connection setting of the remote path is CU Free or when the value of the <code>cuType</code> attribute is <code>LOCAL</code> .
portType	string	Port type of the remote path <ul style="list-style-type: none"> ▪ <code>FIBRE</code>: All the ports are Fibre Channel ports ▪ <code>ESCON</code>: All the ports are ESCON ports ▪ <code>ISCSI</code>: All the ports are iSCSI ports ▪ <code>MIXED</code>: Multiple port types from among these three types This item is hidden when the value of the <code>cuType</code> attribute is <code>LOCAL</code> .
cuType	string	CU type <ul style="list-style-type: none"> ▪ <code>REMOTE</code>: If a remote path is set from the local storage system to the remote storage system ▪ <code>LOCAL</code>: If a remote path is set from the remote storage system to the local storage system
cuStatus	string	CU status <ul style="list-style-type: none"> ▪ <code>NML</code>: Normal ▪ <code>WAR</code>: Warning ▪ <code>ERR</code>: Failing ▪ <code>Unknown</code>: Unknown. This is output if the <code>cuType</code> attribute is <code>LOCAL</code>.
minNumOfPaths	int	Minimum number of paths If the <code>cuType</code> attribute is <code>LOCAL</code> , this information is not output.
numOfPaths	int	Number of set remote paths If the <code>cuType</code> attribute is <code>LOCAL</code> , this information is not output.

Attribute	Type	Description
incidentMode	string	<p>Incident mode for sending incidents to the RCU host</p> <ul style="list-style-type: none"> MR: Incidents are sent to the MCU host and the RCU host. RO: Incidents are sent to the RCU host only. <p>This item is hidden when the value of the connection setting of the remote path is CU Free or when the value of the <code>cuType</code> attribute is <code>LOCAL</code>.</p>
isFreezeOptionEnabled	boolean	<p>Value of the FREEZE option</p> <ul style="list-style-type: none"> <code>false</code>: The FREEZE option is disabled. <code>true</code>: The FREEZE option is enabled. <p>This item is hidden when the value of the connection setting of the remote path is CU Free or when the value of the <code>cuType</code> attribute is <code>LOCAL</code>.</p>
timeoutValueForRemoteIOInSeconds	int	<p>RIO timeout value (in seconds) for RIO (Remote IO) setting between the local storage system and the remote storage system</p> <p>If the <code>cuType</code> attribute is <code>LOCAL</code>, this information is not output.</p>
roundTripTimeInMilliseconds	int	<p>The round-trip time value (in milliseconds) between the local storage system and the remote storage system</p> <p>If the <code>cuType</code> attribute is <code>LOCAL</code>, this information is not output.</p>

Status codes

For details on the status codes of the request for this operation, see the description on HTTP status codes.

Coding example

```
curl -v -H "Accept:application/json" -H "Content-Type:application/json" -H
"Authorization:Session d7b673af189048468c5af9bcf3bbbb6f" -X GET https://
192.0.2.100/ConfigurationManager/v1/objects/remotepath-groups
```

Getting information about a specific remote connection

The following request gets information about a specific remote connection. You can get information about a remote connection when the value of the connection setting of the remote path is CU Free.

Execution permission

Storage Administrator (View Only)

Request line

```
GET base-URL/v1/objects/remotepath-groups/object-ID
```

Request message

Object ID

Specify the value of `remotepathGroupId` that was obtained by the processing to get information about the remote connection. You can also specify the attributes and connect them with commas as follows:

```
remoteSerialNumber, remoteStorageTypeId, pathGroupId
```

Attribute	Type	Description
remoteSerialNumber	string	(Required) Serial number of the remote storage system
remoteStorageTypeId	string	(Required) ID that indicates the model of the remote storage system You can specify the following values: <ul style="list-style-type: none"> M8: VSP G350, G370, G700, G900, VSP F350, F370, F700, F900
pathGroupId	int	(Required) Path group ID

Query parameters

None.

Body

None.

Response message**Body**

The following is an example of the output when information about the remote storage system is not registered on the REST API server:

```
{
  "remotepathGroupId": "492015,M8,255",
  "remoteSerialNumber": "492015",
  "remoteStorageTypeId": "M8",
  "pathGroupId": 255,
  "remotePaths": [
    {
      "cuType": "REMOTE",
      "portType": "ISCSI",
      "pathNumber": 0,
      "localPortId": "CL3-B",
      "remotePortId": "CL2-C",
      "pathStatus": "ERR_03"
    }
  ]
}
```

The following is an example of the output when information about the remote storage system is not registered on the REST API server:

```
{
  "remotepathGroupId": "492015,M8,255",
  "remoteSerialNumber": "492015",
  "remoteStorageTypeId": "M8",
  "pathGroupId": 255,
  "remotePaths": [
    {
      "cuType": "REMOTE",
      "portType": "ISCSI",
      "pathNumber": 0,
      "localPortId": "CL3-B",
      "remotePortId": "CL2-C",
      "pathStatus": "ERR_03"
    }
  ]
}
```

Attribute	Type	Description
remotepathGroupId	string	Object ID for the remote connection
remoteStorageDeviceId	string	Storage device ID of the remote storage system

Attribute	Type	Description
		This attribute is output when information about the remote storage system is registered on the REST API server.
remoteSerialNumber	string	Serial number of the remote storage system
remoteStorageModel	string	Model type of the remote storage system This attribute is output when information about the remote storage system is registered on the REST API server.
remoteStorageTypeId	string	ID that indicates the model of the remote storage system <ul style="list-style-type: none"> ▪ M8: VSP G350, G370, G700, G900, VSP F350, F370, F700, F900
pathGroupId	int	Path group ID
remotePaths	objects[]	The following attributes are output for each remote path: <ul style="list-style-type: none"> ▪ cuType (string) CU type <ul style="list-style-type: none"> • REMOTE: If a remote path is set from the local storage system to the remote storage system • LOCAL: If a remote path is set from the remote storage system to the local storage system ▪ portType (string) Port type of the remote path <ul style="list-style-type: none"> • FIBRE: Fibre Channel port • ESCON: ESCON port • ISCSI: iSCSI port ▪ pathNumber (int) Path number ▪ localPortId (string) Port number of the local storage system (MCU)

Attribute	Type	Description
		<ul style="list-style-type: none"> ▪ remotePortId (string) Port number of the remote storage system (RCU) ▪ pathStatus (string) The path status <ul style="list-style-type: none"> • NML_01: Normal • ERR_02: Initialization failed • ERR_03: Communication timeout • ERR_04: Logical blockade • ERR_05: Resource Shortage • ERR_06: Serial Number Mismatch • ERR_10: Invalid Port • ERR_80: RCU Port Number Mismatch • ERR_81: RCU Port Type Mismatch • ERR_82: Communication Failed • IN_PRG: The path is being created or deleted.

Status codes

For details on the status codes of the request for this operation, see the description on HTTP status codes.

Coding example

```
curl -v -H "Accept:application/json" -H "Content-Type:application/json" -H
"Authorization:Session d7b673af189048468c5af9bcf3bbbb6f" -X GET https://
192.0.2.100/ConfigurationManager/v1/objects/remotepath-groups/492015,M8,255
```

Creating a remote connection

The following request creates a remote connection, and then adds a remote path. By using this request, you can create a CU Free remote connection. You can specify the serial number and the series name of the remote storage system to create a remote connection. Alternatively, you can specify the storage device ID of the remote storage system to create a remote connection. To add a remote path for an iSCSI port, register in advance the iSCSI port of the remote storage system to the iSCSI port of the local storage system.

Execution permission

Storage Administrator (Remote Copy)

Request linePOST *base-URL/v1/objects/remotepath-groups***Request message****Object ID**

None.

Query parameters

None.

Body

The following is a coding example for creating a remote connection by specifying the serial number and the series name of the remote storage system:

```
{
  "remoteSerialNumber": "492015",
  "remoteStorageTypeId": "M8",
  "pathGroupId": 255,
  "localPortId": "CL3-B",
  "remotePortId": "CL2-C"
}
```

Attribute	Type	Description
remoteSerialNumber	string	(Required) Serial number of the remote storage system
remoteStorageTypeId	string	(Required) ID that indicates the model of the remote storage system You can specify the following values: <ul style="list-style-type: none"> M8: VSP G350, G370, G700, G900, VSP F350, F370, F700, F900
pathGroupId	int	(Required) Path group ID Specify a decimal (base 10) number in the range from 0 to 255.
localPortId	string	(Required) Port number of the local storage system

Attribute	Type	Description
remotePortId	string	(Required) Port number of the remote storage system

The following is a coding example for creating a remote connection by specifying the storage device ID of the remote storage system:

```
{
  "remoteStorageDeviceId": "886000410011",
  "pathGroupId": 255,
  "localPortId": "CL3-B",
  "remotePortId": "CL2-C"
}
```

Attribute	Type	Description
remoteStorageDeviceId	string	(Required) Storage device ID of the remote storage system
pathGroupId	int	(Required) Path group ID Specify a decimal (base 10) number in the range from 0 to 255.
localPortId	string	(Required) Port number of the local storage system
remotePortId	string	(Required) Port number of the remote storage system

Response message

Body

A job object is returned. For details on attributes other than `affectedResources`, see the section explaining job objects.

Attribute	Description
affectedResources	URL of the registered remote connection

Status codes

The following table describes the meaning of the status code of the request for this operation. For details on other status codes, see the section explaining HTTP status codes.

Status code	Message	Description
409	Conflict	A remote connection has already been created with the specified path group ID.

Coding example

```
curl -v -H "Accept:application/json" -H "Content-Type:application/json" -H
"Authorization:Session d7b673af189048468c5af9bcf3b6bb6f" -X POST --data-
binary @./InputParameters.json https://192.0.2.100/ConfigurationManager/v1/
objects/remotepath-groups
```

Changing the remote connection settings

The following request changes the remote connection settings such as the minimum number of paths, communication timeout value, and the return response time. You can change the remote connection settings when the value of the connection setting of the remote path is CU Free.

Execution permission

Storage Administrator (Remote Copy)

Request line

```
PATCH base-URL/v1/objects/remotepath-groups/object-ID
```

Request message**Object ID**

Specify the value of `remotepathGroupId` that was obtained by the processing to get information about the remote connection. You can also specify the attributes and connect them with commas as follows:

```
remoteSerialNumber,remoteStorageTypeId,pathGroupId
```

Attribute	Type	Description
remoteSerialNumber	string	(Required) Serial number of the remote storage system
remoteStorageTypeId	string	(Required) ID that indicates the model of the remote storage system You can specify the following values: <ul style="list-style-type: none"> ▪ M8: VSP G350, G370, G700, G900, VSP F350, F370, F700, F900
pathGroupId	int	(Required) Path group ID

Query parameters

None.

Body

```
{
  "minNumOfPaths": 1,
  "timeoutValueForRemoteIOInSeconds": 15,
  "roundTripTimeInMilliseconds": 1
}
```

Attribute	Type	Description
minNumOfPaths	int	Minimum number of remote paths Specify a value in the range from 1 to 8. This value is set to 1 by default when a remote connection is created. Specify a value that is no more than the number of remote paths registered in the remote connection.
timeoutValueForRemoteIOInSeconds	int	RIO timeout value (in seconds) for RIO (Remote IO) setting between the local storage system and the remote storage system Specify a value in the range from 10 to 100.

Attribute	Type	Description
		This value is set to 15 by default when a remote connection is created.
roundTripTimeInMilliseconds	int	The round-trip time value (in milliseconds) between the local storage system and the remote storage system Specify a value in the range from 1 to 500. Default: 1 This value is set to 1 by default when a remote connection is created.

Response message

Body

A job object is returned. For details on attributes other than `affectedResources`, see the section explaining job objects.

Attribute	Description
affectedResources	URL of the changed remote connection

Status codes

The following table describes the meaning of the status code of the request for this operation. For details on other status codes, see the section explaining HTTP status codes.

Status code	Message	Description
400	Bad Request	Values smaller or greater than the specifiable values exist in the specified values.

Coding example

```
curl -v -H "Accept:application/json" -H "Content-Type:application/json" -H "Authorization:Session d7b673af189048468c5af9bcf3b6bb6f" -X PATCH --data-
```



```
binary @./InputParameters.json https://192.0.2.100/ConfigurationManager/v1/objects/remotepath-groups/492015,M8,255
```

Adding remote paths to a remote connection

The following request adds a remote path to the existing remote connection. You can add a remote path when the value of the connection setting of the remote path is CU Free. To add a remote path for an iSCSI port, register in advance the iSCSI port of the remote storage system to the iSCSI port of the local storage system.

Execution permission

Storage Administrator (Remote Copy)

Request line

```
POST base-URL/v1/objects/remotepath-groups/object-ID/actions/add-remotepath/invoke
```

Request message

Object ID

Specify the value of `remotepathGroupId` that was obtained by the processing to get information about the remote connection. You can also specify the attributes and connect them with commas as follows:

```
remoteSerialNumber,remoteStorageTypeId,pathGroupId
```

Attribute	Type	Description
remoteSerialNumber	string	(Required) Serial number of the remote storage system
remoteStorageTypeId	string	(Required) ID that indicates the model of the remote storage system You can specify the following values: <ul style="list-style-type: none"> M8: VSP G350, G370, G700, G900, VSP F350, F370, F700, F900
pathGroupId	int	(Required) Path group ID

Query parameters

None.

Body

```
{
  "parameters": {
    "localPortId": "CL1-A",
    "remotePortId": "CL1-2"
  }
}
```

Attribute	Type	Description
localPortId	string	(Required) Port number of the local storage system
remotePortId	string	(Required) Port number of the remote storage system

Response message**Body**

A job object is returned. For details on attributes other than `affectedResources`, see the section explaining job objects.

Attribute	Description
affectedResources	URL of the remote path that was added to the remote connection

Action template

```
GET base-URL/v1/objects/remotepath-groups/object-ID/actions/add-remotepath
```

Status codes

The following table describes the meaning of the status code of the request for this operation. For details on other status codes, see the section explaining HTTP status codes.

Status code	Message	Description
412	Precondition Failed	The number of the remote paths already registered to the target remote connection is eight, which is the maximum number of remote paths that can be registered.

Coding example

To get an action template:

```
curl -v -H "Accept:application/json" -H "Content-Type:application/json" -H
"Authorization:Session d7b673af189048468c5af9bcf3b66b6f" -X GET https://
192.0.2.100/ConfigurationManager/v1/objects/remotepath-groups/492015,M8,
255/actions/add-remotepath
```

To run the request after getting an action template:

```
curl -v -H "Accept:application/json" -H "Content-Type:application/json" -H
"Authorization:Session d7b673af189048468c5af9bcf3b66b6f" -X POST --data-
binary @./InputParameters.json https://192.0.2.100/ConfigurationManager/v1/
objects/remotepath-groups/492015,M8,255/actions/add-remotepath/invoke
```

Deleting a remote path from a remote connection

The following request deletes a specified remote path from a remote connection. You can delete a remote path when the value of the connection setting of the remote path is CU Free. If the specified path is an iSCSI remote path and is not registered to other remote connections, the remote storage system's iSCSI port information that is registered to the iSCSI port on the local storage system is deleted at the same time the iSCSI remote path is deleted.

Execution permission

Storage Administrator (Remote Copy)

Request line

```
POST base-URL/v1/objects/remotepath-groups/object-ID/actions/remove-
remotepath/invoke
```

Request message**Object ID**

Specify the value of `remotepathGroupId` that was obtained by the processing to get information about the remote connection. You can also specify the attributes and connect them with commas as follows:

```
remoteSerialNumber,remoteStorageTypeId,pathGroupId
```

Attribute	Type	Description
remoteSerialNumber	string	(Required) Serial number of the remote storage system

Attribute	Type	Description
remoteStorageTypeId	string	(Required) ID that indicates the model of the remote storage system You can specify the following values: <ul style="list-style-type: none"> ▪ M8: VSP G350, G370, G700, G900, VSP F350, F370, F700, F900
pathGroupId	int	(Required) Path group ID

Query parameters

None.

Body

```
{
  "parameters": {
    "localPortId": "CL1-A",
    "remotePortId": "CL1-2"
  }
}
```

Attribute	Type	Description
localPortId	string	(Required) Port number of the local storage system
remotePortId	string	(Required) Port number of the remote storage system

Response message**Body**

A job object is returned. For details on attributes other than `affectedResources`, see the section explaining job objects.

Attribute	Description
affectedResources	URL of the remote path removed from the remote connection

Action template

```
GET base-URL/v1/objects/remotepath-groups/object-ID/actions/remove-remotepath
```

Status codes

The following table describes the meaning of the status code of the request for this operation. For details on other status codes, see the section explaining HTTP status codes.

Status code	Message	Description
412	Precondition Failed	Only one remote path or the minimum number of remote paths is set for the target remote connection.

Coding example

To get an action template

```
curl -v -H "Accept:application/json" -H "Content-Type:application/json" -H "Authorization:Session d7b673af189048468c5af9bcf3bbbb6f" -X GET https://192.0.2.100/ConfigurationManager/v1/objects/remotepath-groups/492015,M8,255/actions/remove-remotepath
```

To run the request after getting an action template:

```
curl -v -H "Accept:application/json" -H "Content-Type:application/json" -H "Authorization:Session d7b673af189048468c5af9bcf3bbbb6f" -X POST --data-binary @./InputParameters.json https://192.0.2.100/ConfigurationManager/v1/objects/remotepath-groups/492015,M8,255/actions/remove-remotepath/invoke
```

Deleting a remote connection

The following request deletes a specified remote connection. You can delete a remote connection when the value of the connection setting of the remote path is CU Free. When a remote connection is deleted, all remote paths registered to the remote connection to be deleted will also be deleted. If an iSCSI remote path is included in the remote connection to be deleted and is not registered to other remote connections, the remote storage system's iSCSI port information that is registered to the iSCSI port on the local storage system is deleted at the same time the iSCSI remote path is deleted.

Execution permission

Storage Administrator (Remote Copy)

Request line

```
DELETE base-URL/v1/objects/remotepath-groups/object-ID
```

Request message**Object ID**

Specify the value of `remotepathGroupId` that was obtained by the processing to get information about the remote connection. You can also specify the attributes and connect them with commas as follows:

```
remoteSerialNumber,remoteStorageTypeId,pathGroupId
```

Attribute	Type	Description
remoteSerialNumber	string	(Required) Serial number of the remote storage system
remoteStorageTypeId	string	(Required) ID that indicates the model of the remote storage system You can specify the following values: <ul style="list-style-type: none"> ▪ M8: VSP G350, G370, G700, G900 or VSP F350, F370, F700, F900
pathGroupId	int	(Required) Path group ID

Query parameters

None.

Body

None.

Response message**Body**

A job object is returned. For details on attributes other than `affectedResources`, see the section explaining job objects.

Attribute	Description
affectedResources	URL of the deleted remote connection

Status codes

For details on the status codes of the request for this operation, see the description on HTTP status codes.

Coding example

```
curl -v -H "Accept:application/json" -H "Content-Type:application/json" -H
"Authorization:Session d7b673af189048468c5af9bcf3bbbb6f" -X DELETE
https://192.0.2.100/ConfigurationManager/v1/objects/remotepath-groups/
492015,M8,255
```

Getting information about iSCSI ports

The following request gets information about iSCSI ports of the registered remote storage system.

Execution permission

Storage Administrator (View Only)

Request line

```
GET base-URL/v1/objects/remote-iscsi-ports
```

Request message**Object ID**

None.

Query parameters

None.

Body

None.

Response message**Body**

The following is an example of the output when information about the remote storage system is not registered on the REST API server:

```
{
  "data": [
    {
      "remoteIscsiPortId": "CL1-B,410012,M8,CL2-D",
      "localPortId": "CL1-B",
      "remoteSerialNumber": "410012",
      "remoteStorageTypeId": "M8",
```

```

    "remotePortId": "CL2-D",
    "remoteIpAddress": "192.168.116.29",
    "remoteTcpPort": 3260
  },
  {
    "remoteIscsiPortId": "CL3-B,410012,M8,CL2-D",
    "localPortId": "CL3-B",
    "remoteSerialNumber": "410012",
    "remoteStorageTypeId": "M8",
    "remotePortId": "CL2-D",
    "remoteIpAddress": "192.168.116.29",
    "remoteTcpPort": 3260
  }
]
}

```

The following is an example of the output when information about the remote storage system is registered on the REST API server:

```

{
  "data": [
    {
      "remoteIscsiPortId": "CL1-B,410012,M8,CL2-D",
      "localPortId": "CL1-B",
      "remoteStorageDeviceId": "886000410012",
      "remoteSerialNumber": "410012",
      "remoteStorageModel": "VSP G900",
      "remoteStorageTypeId": "M8",
      "remotePortId": "CL2-D",
      "remoteIpAddress": "192.168.116.29",
      "remoteTcpPort": 3260
    },
    {
      "remoteIscsiPortId": "CL3-B,410012,M8,CL2-D",
      "localPortId": "CL3-B",
      "remoteStorageDeviceId": "886000410012",
      "remoteSerialNumber": "410012",
      "remoteStorageModel": "VSP G900",
      "remoteStorageTypeId": "M8",
      "remotePortId": "CL2-D",
      "remoteIpAddress": "192.168.116.29",
      "remoteTcpPort": 3260
    }
  ]
}

```

Attribute	Type	Description
remoteIscsiPortId	string	Object ID for the iSCSI port
localPortId	string	Port number of the local storage system
remoteStorageDeviceId	string	Storage device ID of the remote storage system This attribute is output when information about the remote storage system is registered on the REST API server.
remoteSerialNumber	string	Serial number of the remote storage system
remoteStorageModel	string	Model type of the remote storage system This attribute is output when information about the remote storage system is registered on the REST API server.
remoteStorageTypeId	string	ID that indicates the model of the remote storage system <ul style="list-style-type: none"> ▪ R8: VSP G1000, VSP G1500, or VSP F1500 ▪ M8: VSP G350, G370, G700, G900 or VSP F350, F370, F700, F900
remotePortId	string	Port number of the remote storage system
remoteIpAddress	string	IP address of the remote storage system
remoteTcpPort	int	TCP port number of the remote storage system

Status codes

For details on the status codes of the request for this operation, see the description on HTTP status codes.

Coding example

```
curl -v -H "Accept:application/json" -H "Content-Type:application/json" -H
"Authorization:Session d7b673af189048468c5af9bcf3b66b6f" -X GET https://
192.0.2.100/ConfigurationManager/v1/objects/remote-iscsi-ports
```

Getting information about a specific iSCSI port

If you specify a port, the following request gets information about that iSCSI port of the remote storage system.

Execution permission

Storage Administrator (View Only)

Request line

```
GET base-URL/v1/objects/remote-iscsi-ports/object-ID
```

Request message

Object ID

Specify the value of `remoteIscsiPortId` that was obtained by the processing to get information about the port. You can also specify the attributes and connect them with commas as follows:

```
localPortId,remoteSerialNumber,remoteStorageTypeId,remotePortId
```

Attribute	Type	Description
localPortId	string	(Required) Port number of the local storage system
remoteSerialNumber	string	(Required) Serial number of the remote storage system
remoteStorageTypeId	string	(Required) ID that indicates the model of the remote storage system You can specify the following values: <ul style="list-style-type: none"> M8: VSP G350, G370, G700, G900 or VSP F350, F370, F700, F900
remotePortId	string	(Required) Port number of the remote storage system

Query parameters

None.

Body

None.

Response message**Body**

The following is an example of the output when information about the remote storage system is not registered on the REST API server:

```
{
  "remoteIscsiPortId": "CL1-B,410012,M8,CL2-D",
  "localPortId": "CL1-B",
  "remoteSerialNumber": "410012",
  "remoteStorageTypeId": "M8",
  "remotePortId": "CL2-D",
  "remoteIpAddress": "192.168.116.29",
  "remoteTcpPort": 3260
}
```

The following is an example of the output when information about the remote storage system is registered on the REST API server:

```
{
  "remoteIscsiPortId": "CL1-B,410012,M8,CL2-D",
  "localPortId": "CL1-B",
  "remoteStorageDeviceId": "886000410012",
  "remoteSerialNumber": "410012",
  "remoteStorageModel": "VSP G900",
  "remoteStorageTypeId": "M8",
  "remotePortId": "CL2-D",
  "remoteIpAddress": "192.168.116.29",
  "remoteTcpPort": 3260
}
```

Attribute	Type	Description
remoteIscsiPortId	string	Object ID for the iSCSI port
localPortId	string	Port number of the local storage system
remoteStorageDeviceId	string	Storage device ID of the remote storage system This attribute is output when information about the remote storage system is registered on the REST API server.
remoteSerialNumber	string	Serial number of the remote storage system
remoteStorageModel	string	Model type of the remote storage system

Attribute	Type	Description
		This attribute is output when information about the remote storage system is registered on the REST API server.
remoteStorageTypeId	string	ID that indicates the model of the remote storage system <ul style="list-style-type: none"> M8: VSP G350, G370, G700, G900 or VSP F350, F370, F700, F900
remotePortId	string	Port number of the remote storage system
remoteIpAddress	string	IP address of the remote storage system
remoteTcpPort	int	TCP port number of the remote storage system

Status codes

For details on the status codes of the request for this operation, see the description on HTTP status codes.

Coding example

```
curl -v -H "Accept:application/json" -H "Content-Type:application/json" -H "Authorization:Session d7b673af189048468c5af9bcf3b66b6f" -X GET https://192.0.2.100/ConfigurationManager/v1/objects/remote-iscsi-ports/CL1-B,410012,M8,CL2-D
```

Registering an iSCSI port

The following request registers the iSCSI port of the remote storage system to the iSCSI port of the local storage system. You can specify the serial number and the series name of the remote storage system to register an iSCSI port. Alternatively, you can specify the storage device ID of the remote storage system to register an iSCSI port. Perform this operation before adding a remote path to a remote connection.

Execution permission

Storage Administrator (Remote Copy)

Request line

```
POST base-URL/v1/objects/remote-iscsi-ports
```

Request message**Object ID**

None.

Query parameters

None.

Body

The following is a coding example for registering an iSCSI port by specifying the serial number, series name, and the TCP port number of the remote storage system:

```
{
  "localPortId": "CL1-B",
  "remoteSerialNumber": "492015",
  "remoteStorageTypeId": "M8",
  "remotePortId": "CL2-D",
  "remoteIpAddress": "192.168.116.29",
  "remoteTcpPort": 3260
}
```

The following is a coding example for registering an iSCSI port by specifying the serial number and the series name of the remote storage system, without specifying the TCP port number:

```
{
  "localPortId": "CL1-B",
  "remoteSerialNumber": "492015",
  "remoteStorageTypeId": "M8",
  "remotePortId": "CL2-D",
  "remoteIpAddress": "192.168.116.29"
}
```

When registering an iSCSI port by specifying the serial number and the series name of the remote storage system:

Attribute	Type	Description
localPortId	string	(Required) Port number of the local storage system
remoteSerialNumber	string	(Required) Serial number of the remote storage system
remoteStorageTypeId	string	(Required) ID that indicates the model of the remote storage system

Attribute	Type	Description
		You can specify the following values: <ul style="list-style-type: none"> M8: VSP G350, G370, G700, G900 or VSP F350, F370, F700, F900
remotePortId	string	(Required) Port number of the remote storage system
remoteIpAddress	string	(Required) IP address of the remote storage system You can specify an IPv4 or IPv6 address.
remoteTcpPort	int	(Optional) TCP port number If this attribute is not specified, the TCP port number for the iSCSI target of the local storage system will be set to the TCP port number of the remote storage system.

The following is a coding example for registering an iSCSI port by specifying the storage device ID and the TCP port number of the remote storage system:

```
{
  "localPortId": "CL1-B",
  "remoteStorageDeviceId": "886000492015",
  "remotePortId": "CL2-D",
  "remoteIpAddress": "192.168.116.29"
}
```

When registering the iSCSI port by specifying the storage device ID of the remote storage system:

Attribute	Type	Description
localPortId	string	(Required) Port number of the local storage system
remoteStorageDeviceId	string	(Required) Storage device ID of the remote storage system
remotePortId	string	(Required) Port number of the remote storage system
remoteIpAddress	string	(Required) IP address of the remote storage system You can specify an IPv4 or IPv6 address.
remoteTcpPort	int	(Optional) TCP port number

Attribute	Type	Description
		If this attribute is not specified, the TCP port number for the iSCSI target of the local storage system will be set to the TCP port number of the remote storage system.

Response message

Body

A job object is returned. For details on attributes other than `affectedResources`, see the section explaining job objects.

Attribute	Description
<code>affectedResources</code>	URL of the iSCSI port of the remote storage system that was registered to the iSCSI port of the local storage system

Status codes

For details on the status codes of the request for this operation, see the description on HTTP status codes.

Coding example

```
curl -v -H "Accept:application/json" -H "Content-Type:application/json" -H
"Authorization:Session d7b673af189048468c5af9bcf3b66b6f" -X POST --data-
binary @./InputParameters.json https://192.0.2.100/ConfigurationManager/v1/
objects/remote-iscsi-ports
```

Removing the registration of an iSCSI port

The following request deletes information about the iSCSI port of the remote storage system that is registered to the iSCSI port of the local storage system. If this iSCSI port is registered in a remote connection, you cannot delete the information.

Execution permission

Storage Administrator (Remote Copy)

Request line

```
DELETE base-URL/v1/objects/remote-iscsi-ports/object-ID
```

Request message**Object ID**

Specify the value of `remoteIscsiPortId` that was obtained by the processing to get information about the port. You can also specify the attributes and connect them with commas as follows:

```
localPortId,remoteSerialNumber,remoteStorageTypeId,remotePortId
```

Attribute	Type	Description
<code>localPortId</code>	string	(Required) Port number of the local storage system
<code>remoteSerialNumber</code>	string	(Required) Serial number of the remote storage system
<code>remoteStorageTypeId</code>	string	(Required) ID that indicates the model of the remote storage system You can specify the following values: <ul style="list-style-type: none"> ▪ M8: VSP G350, G370, G700, G900 or VSP F350, F370, F700, F900
<code>remotePortId</code>	string	(Required) Port number of the remote storage system

Query parameters

None.

Body

None.

Response message**Body**

A job object is returned. For details on attributes other than `affectedResources`, see the section explaining job objects.

Attribute	Description
<code>affectedResources</code>	URL of the deleted iSCSI port

Status codes

For details on the status codes of the request for this operation, see the description on HTTP status codes.

Coding example

```
curl -v -H "Accept:application/json" -H "Content-Type:application/json" -H
"Authorization:Session d7b673af189048468c5af9bcf3b6666f" -X DELETE
https://192.0.2.100/ConfigurationManager/v1/objects/remote-iscsi-ports/CL1-
B,410012,M8,CL2-D
```

Setting journals

This section describes how to specify settings of journals to be used in Universal Replicator by using the REST API.

Getting journal information

The following request gets a list of information about a journal.

Execution permission

Storage Administrator (View Only)

Request line

```
GET base-URL/v1/objects/journals
```

Request message**Object ID**

None.

Query parameters

Parameter	Type	Filter Condition
journalInfo	string	(Required) Type of information to be obtained The specifiable values are as follows: <ul style="list-style-type: none"> ▪ basic: Basic journal information ▪ timer: Journal time information ▪ detail: Detailed journal information

Body

None.

Response message**Body**

The following is an example of the output when basic journal information is obtained:

```
{
  "data": [
    {
      "journalId": 0,
      "muNumber": 1,
      "consistencyGroupId": 5,
      "journalStatus": "PJSF",
      "numOfActivePaths": 1,
      "usageRate": 0,
      "qMarker": "575cc653",
      "qCount": 0,
      "byteFormatCapacity": "1.88 G",
      "blockCapacity": 3956736,
      "numOfLdevs": 1,
      "firstLdevId": 513
    }
  ]
}
```

Attribute	Type	Description
journalId	int	Journal ID
muNumber	int	MU (mirror unit) number
consistencyGroupId	int	Consistency group identifier
journalStatus	string	Journal volume status For details, see the section explaining the mirror journal statuses.
numOfActivePaths	int	Number of active link paths
usageRate	int	Usage rate of the journal volume

Attribute	Type	Description
qMarker	string	If the obtained journal is the master journal, the last sequential number (Q-marker) when the journal volume received the write data is output. If the obtained journal is the restore journal, the last sequential number (Q-marker) that is written in the cache is output.
qCount	long	Number of qMarker remaining in the master journal volume
byteFormatCapacity	string	Capacity of the journal volume The value is output to the second decimal place.
blockCapacity	long	Number of blocks of the journal volume
numOfLdevs	int	Number of LDEVs configuring the journal volume
firstLdevId	int	LDEV number of the first LDEV assigned to the journal

The following is an example of the output when journal time information is obtained:

```
{
  "data": [
    {
      "journalId": 0,
      "muNumber": 1,
      "consistencyGroupId": 5,
      "journalStatus": "PJSF",
      "numOfActivePaths": 1,
      "usageRate": 0,
      "qMarker": "575cc653",
      "qCount": 0,
      "byteFormatCapacity": "1.88 G",
      "blockCapacity": 3956736,
      "dataOverflowWatchInSeconds": 60,
      "pathBlockadeWatchInMinutes": 5,
      "activePathWatchTimerSettingInSeconds": 40
    }
  ]
}
```

Attribute	Type	Description
journalId	int	Journal ID
muNumber	int	MU (mirror unit) number
consistencyGroupId	int	Consistency group identifier
journalStatus	string	Journal volume status For details, see the section explaining the mirror journal statuses.
numOfActivePaths	int	Number of active link paths
usageRate	int	Usage rate of the journal volume
qMarker	string	If the obtained journal is the master journal, the last sequential number (Q-marker) when the journal volume received the write data is output. If the obtained journal is the restore journal, the last sequential number (Q-marker) that is written in the cache is output.
qCount	long	Number of <code>qMarker</code> remaining in the master journal volume
byteFormatCapacity	string	Capacity of the journal volume The value is output to the second decimal place.
blockCapacity	long	Number of blocks of the journal volume
dataOverflowWatchInSeconds	int	Data Overflow Watch timer setting (in seconds) per the Journal
pathBlockadeWatchInMinutes	int	Path Blockade Watch timer setting (in minutes) per the Journal
activePathWatchTimerSettingInSeconds	int	Active Path Watch timer setting (in seconds) to detect any link failures

The following is an example of the output when detailed journal information is obtained:

```
{
  "data": [
```

```

{
  "journalId": 0,
  "isMainframe": false,
  "isCacheModeEnabled": true,
  "isInflowControlEnabled": true,
  "dataOverflowWatchInSeconds": 60,
  "copySpeed": 256,
  "isDataCopying": true,
  "mpBladeId": 0,
  "mirrorUnits": [
    {
      "muNumber": 0,
      "consistencyGroupId": 0,
      "journalStatus": "SMPL",
      "pathBlockadeWatchInMinutes": 5,
      "copyPace": "L"
    },
    {
      "muNumber": 1,
      "consistencyGroupId": 5,
      "journalStatus": "PJSE",
      "pathBlockadeWatchInMinutes": 5,
      "copyPace": "L"
    },
    {
      "muNumber": 2,
      "consistencyGroupId": 0,
      "journalStatus": "SMPL",
      "pathBlockadeWatchInMinutes": 5,
      "copyPace": "L"
    },
    {
      "muNumber": 3,
      "consistencyGroupId": 0,
      "journalStatus": "SMPL",
      "pathBlockadeWatchInMinutes": 5,
      "copyPace": "L"
    }
  ]
}

```

Attribute	Type	Description
journalId	int	Journal ID

Attribute	Type	Description
isMainframe	boolean	Indicates whether the journal is used for mainframe systems or open systems <ul style="list-style-type: none"> <code>true</code>: The journal is used for mainframe systems <code>false</code>: The journal is used for open systems
mfTimerType	string	Timer type for mainframe systems <ul style="list-style-type: none"> <code>LOCAL</code>: A local timer is used. <code>SYSTEM</code>: A system timer is used. <code>none</code>: A system timer is used (when the copy direction is the reverse).
isCacheModeEnabled	boolean	Indicates whether the cache mode setting is enabled <ul style="list-style-type: none"> <code>true</code>: The cache mode setting is enabled. <code>false</code>: The cache mode setting is disabled.
isInflowControlEnabled	boolean	Indicates whether an inflow of update I/O to the journal volume is limited <ul style="list-style-type: none"> <code>true</code>: Inflow is limited. <code>false</code>: Inflow is unlimited.
dataOverflowWatchInSeconds	int	Data Overflow Watch timer setting (in seconds) per the Journal
copySpeed	int	Transfer speed (in Mbps)
isDataCopying	boolean	Copy mode "true" or "false" under failure of the delta resync: <ul style="list-style-type: none"> <code>true</code>: copying ALL data <code>false</code>: No copying
mpBladeId	int	MP blade ID

Attribute	Type	Description
mirrorUnits	object[]	<p>The following attributes are output for each mirror:</p> <ul style="list-style-type: none"> ▪ muNumber (int) MU (mirror unit) number ▪ consistencyGroupId (int) Consistency group ID ▪ journalStatus (string) The journal status For details, see the section explaining the mirror journal statuses. ▪ pathBlockadeWatchInMinutes (int) Path Blockade Watch timer setting (in minutes) per the Journal ▪ copyPace (string) Copy speed <ul style="list-style-type: none"> • L: Low speed • M: Medium speed • H: High speed

Status codes

For details on the status codes of the request for this operation, see the description on HTTP status codes.

Coding example

To get basic journal information:

```
curl -v -H "Accept:application/json" -H "Content-Type:application/json" -H
"Authorization:Session d7b673af189048468c5af9bcf3b6bb6f" -X GET https://
192.0.2.100/ConfigurationManager/v1/objects/journals?journalInfo=basic
```

To get journal time information:

```
curl -v -H "Accept:application/json" -H "Content-Type:application/json" -H
"Authorization:Session d7b673af189048468c5af9bcf3b6bb6f" -X GET https://
192.0.2.100/ConfigurationManager/v1/objects/journals?journalInfo=timer
```

To get detailed journal information:

```
curl -v -H "Accept:application/json" -H "Content-Type:application/json" -H
"Authorization:Session d7b673af189048468c5af9bcf3b6bb6f" -X GET https://
192.0.2.100/ConfigurationManager/v1/objects/journals?journalInfo=detail
```

Getting information about a specific journal

The following request gets basic information about the specified journal. To get journal time information or detailed journal information, run the API function for getting a list of journals.



Note: If the specified journal is used in a 3DC configuration and multiple MUs are set for the journal, information about only one MU can be acquired for the API. In this situation, run the API function for getting a list of journals to get the information about the target journal ID.

Execution permission

Storage Administrator (View Only)

Request line

```
GET base-URL/v1/objects/journals/object-ID
```

Request message

Object ID

Specify the `journalId` value obtained by getting information about the journal.

Attribute	Type	Description
journalId	int	(Required) Journal ID

Query parameters

None.

Body

None.

Response message

Body

```
{
  "journalId": 0,
  "muNumber": 1,
```



```

"consistencyGroupId": 5,
"journalStatus": "PJSF",
"numOfActivePaths": 1,
"usageRate": 0,
"qMarker": "575cc653",
"qCount": 0,
"byteFormatCapacity": "1.88 G",
"blockCapacity": 3956736,
"numOfLdevs": 1,
"firstLdevId": 513
}

```

Attribute	Type	Description
journalId	int	Journal ID
muNumber	int	MU (mirror unit) number
consistencyGroupId	int	Consistency group identifier
journalStatus	string	Journal volume status For details, see the section explaining the mirror journal statuses.
numOfActivePaths	int	Number of active link paths
usageRate	int	Usage rate of the journal volume
qMarker	string	If the obtained journal is the master journal, the last sequential number (Q-marker) when the journal volume received the write data is output. If the obtained journal is the restore journal, the last sequential number (Q-marker) that is written in the cache is output.
qCount	long	Number of <code>qMarker</code> remaining in the master journal volume
byteFormatCapacity	string	Capacity of the journal volume The value is output to the second decimal place.
blockCapacity	long	Number of blocks of the journal volume
numOfLdevs	int	Number of LDEVs configuring the journal volume
firstLdevId	int	LDEV number of the first LDEV assigned to the journal

Status codes

For details on the status codes of the request for this operation, see the description on HTTP status codes.

Coding example

```
curl -v -H "Accept:application/json" -H "Content-Type:application/json" -H
"Authorization:Session d7b673af189048468c5af9bcf3bbbb6f" -X GET https://
192.0.2.100/ConfigurationManager/v1/objects/journals/0
```

Creating a journal

The following request creates a journal and then adds a journal volume. Specify a DP volume for a journal volume to be added.

Execution permission

Storage Administrator (Remote Copy)

Request line

```
POST base-URL/v1/objects/journals
```

Request message**Object ID**

None.

Query parameters

None.

Body

The following is a coding example for creating a journal by specifying the LDEV number:

```
{
  "journalId": 33,
  "ldevIds": [101,102]
}
```

When creating a journal by specifying the LDEV number

Attribute	Type	Description
journalId	int	(Required) Specify the journal ID.

Attribute	Type	Description
		Specify a decimal (base 10) number in the range from 0 to 255.
ldevIds	int[]	(Required) Specify the LDEV number with a decimal (base 10) number. You can specify up to 2 numbers.

The following is a coding example for creating a journal by specifying a range of consecutive LDEV numbers:

```
{
  "journalId": 33,
  "startLdevId": 101,
  "endLdevId": 102
}
```

When creating a journal by specifying a range of consecutive LDEV numbers

Attribute	Type	Description
journalId	int	(Required) Specify the journal ID with a decimal (base 10) number.
startLdevId	int	(Required) Specify the first LDEV number by using a decimal (base 10) number. The value of this attribute must be smaller than that of endLdevId.
endLdevId	int	(Required) Specify the last LDEV number by using a decimal (base 10) number. The value of this attribute must be greater than that of startLdevId. Specify a number such that the range indicated by the startLdevId and endLdevId attributes consists of no more than 2 LDEVs.

Response message

Body

A job object is returned. For details on attributes other than `affectedResources`, see the description on job objects.

Attribute	Description
affectedResources	URL of the created journal

Status codes

The following table describes the meaning of the status code of the request for this operation. For details on other status codes, see the description on HTTP status codes.

Status code	Message	Description
409	Conflict	A journal that has the specified journal ID already exists.

Coding example

```
curl -v -H "Accept:application/json" -H "Content-Type:application/json" -H "Authorization:Session d7b673af189048468c5af9bcf3b6bb6f" -X POST --data-binary @./InputParameters.json https://192.0.2.100/ConfigurationManager/v1/objects/journals
```

The mirror journal status

The following table describes the mirror journal statuses for Universal Replicator.

Status	Description
SMPL	The mirror is not used.
P(S)JNN	The master journal (restore journal) is normal.
P(S)JSN	The master journal (restore journal) is in normal split status.
P(S)JNF	The master journal (restore journal) is full.
P(S)JSF	The master journal (restore journal) is full and split.
P(S)JSE	The master journal (restore journal) is split due to an error (including link errors).
P(S)JNS	The master journal (restore journal) is in normal split status (for the 3DC multi-target configuration that uses delta resync).
P(S)JES	The master journal (restore journal) is split due to an error (for the 3DC multi-target configuration that uses delta resync).

Changing journal settings

The following request changes the journal settings, such as Data Overflow Watch and the transfer speed.



Note:

If a user uses the REST API to lock the resources of a target storage system, any request that includes a change to the transfer speed (the `copySpeed` attribute) cannot run. In such a case, unlock the resources before performing the operation.

Execution permission

Storage Administrator (Remote Copy)

Request line

```
PATCH base-URL/v1/objects/journals/object-ID
```

Request message

Object ID

Specify the value of `journalId` that was obtained by the processing to get information about journals.

Attribute	Type	Description
<code>journalId</code>	int	(Required) Journal ID

Query parameters

None.

Body

The following is a coding example for changing the following settings: Data Overflow Watch, cache mode, and transfer speed:

```
{
  "dataOverflowWatchInSeconds": 60,
  "isCacheModeEnabled": true,
  "copySpeed": 100
}
```

The following is a coding example for changing the following settings: mirror copy speed and Path Blockade Watch Time for the mirror:

```
{
  "mirrorUnit": {
```

```

    "muNumber": 0,
    "copyPace": "M",
    "pathBlockadeWatchInMinutes": 10
  }
}

```

The following is a coding example for changing the following settings: Data Overflow Watch, cache mode, transfer speed, copy speed per mirror, and Path Blockade Watch Time for the mirror:

```

{
  "dataOverflowWatchInSeconds": 60,
  "isCacheModeEnabled": true,
  "copySpeed": 100,
  "mirrorUnit": {
    "muNumber": 0,
    "copyPace": "M",
    "pathBlockadeWatchInMinutes": 10
  }
}

```

Attribute	Type	Description
dataOverflowWatchInSeconds	int	(Optional) Data Overflow Watch (in seconds) This value is set to 60 by default when a journal is created. If 0 is specified, control on inflow of update I/O to the journal volume will be disabled.
isCacheModeEnabled	boolean	(Optional) Specify whether to enable the cache mode setting. <ul style="list-style-type: none"> ▪ <code>true</code>: The cache mode setting is enabled. ▪ <code>false</code>: Disable the cache mode setting. This value is set to <code>true</code> by default when a journal is created.
copySpeed	int	(Optional) Transfer speed (in Mbps) Specify the transfer speed for data transfer. You can specify one of the following values: 3, 10, 100, or 256 This value is set to 256 by default when a journal is created.

Attribute	Type	Description
mirrorUnit	object	<p>Specify the following attributes for each mirror:</p> <ul style="list-style-type: none"> ▪ (Optional) muNumber (int) MU (mirror unit) number Specify this attribute together with either the <code>copyPace</code> attribute or the <code>pathBlockadeWatchInMinutes</code> attribute. ▪ (Optional) copyPace (string) Copy speed The type is not case sensitive. <ul style="list-style-type: none"> • L: Low speed • M: Medium speed • H: High speed This value is set to L by default when a journal is created. ▪ (Optional) pathBlockadeWatchInMinutes (int) Path Blockade Watch Time (in minutes) Specify a value in the range from 0 to 60. This value is set to 5 by default when a journal is created. If 0 is specified, Path Blockade Watch will be disabled.

Response message

Body

A job object is returned. For details on attributes other than `affectedResources`, see the description on job objects.

Attribute	Description
affectedResources	URL of the changed journal

Attribute	Description
	You can use detailed journal information to check changed setting values. You can obtain detailed information by specifying <code>journalInfo=detail</code> for the query parameter of the API for getting a list of journals.

Status codes

For details on the status codes of the request for this operation, see the description on HTTP status codes.

Coding example

```
curl -v -H "Accept:application/json" -H "Content-Type:application/json" -H
"Authorization:Session d7b673af189048468c5af9bcf3bbbb6f" -X PATCH --data-
binary @./InputParameters.json https://192.0.2.100/ConfigurationManager/v1/
objects/journals/100
```

Adding a journal volume

The following request adds a journal volume to a journal to expand the journal. Specify a DP volume for a journal volume to be added.

Execution permission

Storage Administrator (Remote Copy)

Request line

```
POST base-URL/v1/objects/journals/object-ID/actions/expand/invoke
```

Request message

Object ID

Specify the value of `journalId` that was obtained by the processing to get information about journals.

Attribute	Type	Description
<code>journalId</code>	int	(Required) Journal ID

Query parameters

None.

Body

```
{
  "parameters": {
    "ldevIds": [101]
  }
}
```

Attribute	Type	Description
ldevIds	int[]	(Required) Specify the LDEV number with a decimal (base 10) number. You can specify only one LDEV.

Response message**Body**

A job object is returned. For details on attributes other than `affectedResources`, see the description on job objects.

Attribute	Description
affectedResources	URL of the journal to which a volume was added

Action template

```
GET base-URL/v1/objects/journals/object-ID/actions/expand
```

Status codes

The following table describes the meaning of the status code of the request for this operation. For details on other status codes, see the description on HTTP status codes.

Status code	Message	Description
412	Precondition Failed	The number of journal volumes that are registered to the target volume is already at the maximum.

Coding example

To get an action template:

```
curl -v -H "Accept:application/json" -H "Content-Type:application/json" -H
"Authorization:Session d7b673af189048468c5af9bcf3b6bb6f" -X GET https://
192.0.2.100/ConfigurationManager/v1/objects/journals/3/actions/expand
```

To run the request after getting an action template:

```
curl -v -H "Accept:application/json" -H "Content-Type:application/json" -H
"Authorization:Session d7b673af189048468c5af9bcf3b6bb6f" -X POST --data-
binary @./InputParameters.json https://192.0.2.100/ConfigurationManager/v1/
objects/journals/3/actions/expand/invoke
```

Deleting a journal volume from a journal

The following request deletes the specified journal volume from a journal to shrink the journal.

Execution permission

Storage Administrator (Remote Copy)

Request line

```
POST base-URL/v1/objects/journals/object-ID/actions/shrink/invoke
```

Request message**Object ID**

Specify the value of `journalId` that was obtained by the processing to get information about journals.

Attribute	Type	Description
journalId	int	(Required) Journal ID

Query parameters

None.

Body

```
{
  "parameters": {
    "ldevIds": [101]
  }
}
```

```
}
}
```

Attribute	Type	Description
ldevIds	int[]	(Required) Specify the LDEV number with a decimal (base 10) number. You can specify only one LDEV.

Response message

Body

A job object is returned. For details on attributes other than `affectedResources`, see the description on job objects.

Attribute	Description
affectedResources	URL of the journal from which a volume was deleted

Action template

```
GET base-URL/v1/objects/journals/object-ID/actions/shrink
```

Status codes

The following table describes the meaning of the status code of the request for this operation. For details on other status codes, see the description on HTTP status codes.

Status code	Message	Description
412	Precondition Failed	Only one journal volume exists in the target journal, or pairs are created and the status of the journal volume is normal.

Coding example

To get an action template:

```
curl -v -H "Accept:application/json" -H "Content-Type:application/json" -H
"Authorization:Session d7b673af189048468c5af9bcf3b6bb6f" -X GET https://
192.0.2.100/ConfigurationManager/v1/objects/journals/3/actions/shrink
```

To run the request after getting an action template:

```
curl -v -H "Accept:application/json" -H "Content-Type:application/json" -H
"Authorization:Session d7b673af189048468c5af9bcf3b6bb6f" -X POST --data-
binary @./InputParameters.json https://192.0.2.100/ConfigurationManager/v1/
objects/journals/3/actions/shrink/invoke
```

Changing the MP blade assigned to a journal

The following request changes the MP blade assigned to a journal.

Execution permission

Storage Administrator (System Resource Management)

Request line

```
POST base-URL/v1/objects/journals/object-ID/actions/assign-mp-blade/invoke
```

Request message**Object ID**

Specify the `journalId` value obtained by getting journal information.

Attribute	Type	Description
journalId	int	(Required) Journal ID

Query parameters

None.

Body

```
{
  "parameters": {
    "mpBladeId": 1
  }
}
```

Attribute	Type	Description
mpBladeId	int	(Required) The blade number of the MP blade to be assigned to the journal

Response message

Body

A job object is returned. For details about attributes other than `affectedResources`, see the description of job objects.

Attribute	Description
<code>affectedResources</code>	URL of the journal for which the MP blade was changed You can use detailed journal information to check changed setting values. You can obtain detailed information by specifying <code>journalInfo=detail</code> for the query parameter of the API for getting a list of journals.

Action template

None.

Status codes

For details about the status codes of the request for this operation, see the description of the HTTP status codes.

Coding example

```
curl -v -H "Accept:application/json" -H "Content-Type:application/json" -H "Authorization:Session d7b673af189048468c5af9bcf3b66b6f" -X POST --data-binary @./InputParameters.json https://192.0.2.100/ConfigurationManager/v1/objects/journals/3/actions/assign-mp-blade/invoke
```

Deleting a journal

The following request deletes a journal. A DP volume registered as a journal volume is not deleted. However, the DP volume can no longer be used as a journal.

Execution permission

Storage Administrator (Remote Copy)

Request line

```
DELETE base-URL/v1/objects/journals/object-ID
```

Request message**Object ID**

Specify the value of `journalId` that was obtained by the processing to get information about journals.

Attribute	Type	Description
journalId	int	(Required) Journal ID

Query parameters

None.

Body

None.

Response message**Body**

A job object is returned. For details on attributes other than `affectedResources`, see the description on job objects.

Attribute	Description
affectedResources	URL of the deleted journal

Status codes

For details on the status codes of the request for this operation, see the description on HTTP status codes.

Coding example

```
curl -v -H "Accept:application/json" -H "Content-Type:application/json" -H
"Authorization:Session d7b673af189048468c5af9bcf3b66b6f" -X DELETE
https://192.0.2.100/ConfigurationManager/v1/objects/journals/30
```

Chapter 11: Managing TrueCopy pairs or Universal Replicator pairs

This chapter describes how to perform operations on TrueCopy pairs or Universal Replicator pairs by using the REST API.

Overview of TrueCopy and Universal Replicator

TrueCopy and Universal Replicator create a copy of a data volume between storage systems. You can create a pair or manage the pair status by issuing an API operation from a REST API client.

TrueCopy

By synchronizing with the data of the local storage system, TrueCopy copies the data to the remote storage system. Therefore, if the volumes of the local storage system (primary volumes) and the volumes of the remote storage system (secondary volumes) are in the PAIR status, the data is consistent.

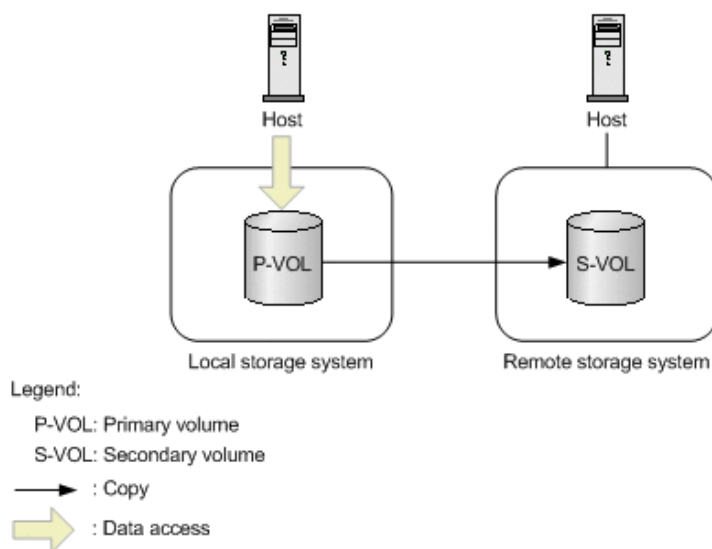

A pair consists of a primary volume and a secondary volume. You can perform operations on pairs in units of copy groups. A copy group is a group made up of copy pairs. Each copy group consists of a device group made up of primary volumes, and a device group made up of secondary volumes.

For details on TrueCopy, see the *Hitachi TrueCopy® User Guide*.

Universal Replicator

Universal Replicator asynchronously copies the data of the local storage system to the data of the remote storage system. The updated data (journal data) is stored in the master journal volume, and is copied to the data of the secondary volumes via the restore journal volume.

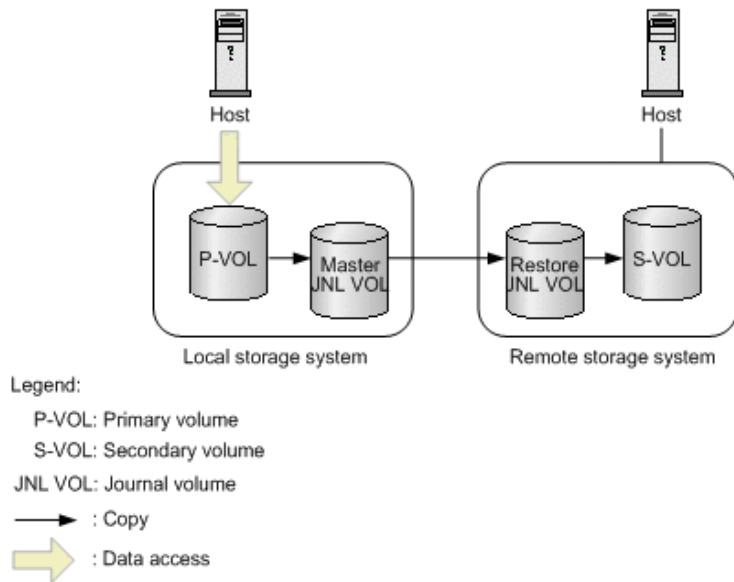

For Universal Replicator, the primary volumes and the master journal volume are called the master journal, and the secondary volumes and the restore journal volume are called the restore journal. Perform operations on pairs in units of mirrors (copy groups) that are the correspondence relationship between the master journal and the restore journal. A mirror (copy group) is a group made up of copy pairs. Each mirror (copy group) consists of a device group made up of primary volumes, and a device group made up of secondary volumes.

For details on Universal Replicator, see the *Hitachi Universal Replicator User Guide*.

Workflow for operating TrueCopy pairs or Universal Replicator pairs

The following figure shows the workflow for performing TrueCopy or Universal Replicator operations.

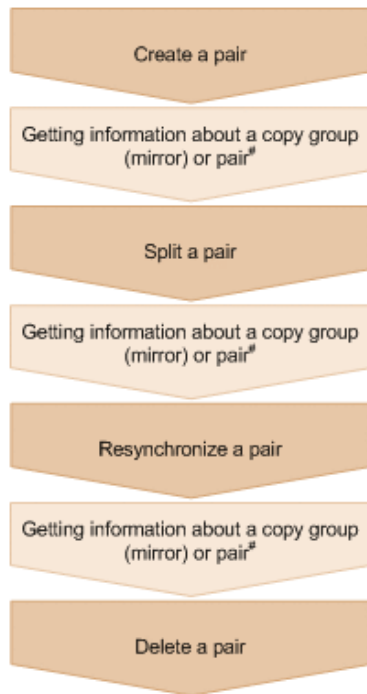

#: Optional operations



Important:

If you perform operations on or get information about TrueCopy or Universal Replicator pairs, specify Remote-Authorization for the request header.

Creating a pair

Create a pair, and then copy all of the data in the P-VOL to the S-VOL. The pair is synchronized. Create a pair in a new copy pair (mirror), or add a pair to an existing copy group.

Getting information about a copy group (mirror) or pair

For TrueCopy, you can perform operations on the pair in units of copy groups or pairs. For Universal Replicator, perform operations on the pair in units of copy groups (mirrors).

Splitting a pair

Split the pair to suspend data copy.

Resynchronizing a pair

Copy the differential data to resynchronize the pair.



Note: Resynchronization can be performed in units of copy groups or pairs. For TrueCopy, if you want to register pairs to a consistency group during resynchronization, perform resynchronization in units of copy groups. Do not perform resynchronization in units of pairs.

Deleting a pair

Dissolve the pair status of the volumes.

Specifying Job-Mode-Wait-Configuration-Change in the request header

During the creation, splitting, and resynchronizing of pairs, if multiple asynchronous processing requests are issued at the same time, jobs might get stuck and the job status might not change to `Completed` because data copying takes a long time. In such cases, specify `Job-Mode-Wait-Configuration-Change:NoWait` in the request header so that the job status changes to `Completed` without waiting for data copying to finish, and the next job starts. At this time, data copying continues even after job execution ends. To check whether data copying has finished, check the pair status of the target resource instead of the job status. For details about the pair status, see the description of the pair status transitions.

Flow of recovery operations to be performed when a failure occurs at the primary site of a Universal Replicator pair

If a failure occurs at the primary site of a Universal Replicator pair, you can use the REST API to perform a failover to the secondary site, in order to ensure continuous operation. After the recovery of the primary site is complete, you can return the pair to the state it was in before the failure occurred by switching operations back to the primary site from the secondary site.

The operations for recovering the Universal Replicator pair can be divided into three general phases:

1. Perform a failover to switch operations over to the secondary site.
2. Copy data from the secondary site to the primary site.
3. Return the pair relationship between the primary site and the secondary site to the state it was in before the failure occurred.

The following explains the flow of operations in each phase.

Performing a failover to switch over business operations to the secondary site

After a failure is detected at the primary site, switch the roles of the primary volume and the secondary volume of the Universal Replicator pair, so that data can be written to the secondary volume, and business operations can continue at the secondary site.



Note: If a failure has occurred at the primary site, pair information of the primary site cannot be obtained. Therefore, to identify the volume at the secondary site to which business operations are to be switched over, you need to know in advance which storage system makes up a pair together with the primary volume of the Universal Replicator pair at the primary site.

The following figure shows the flow of operations:

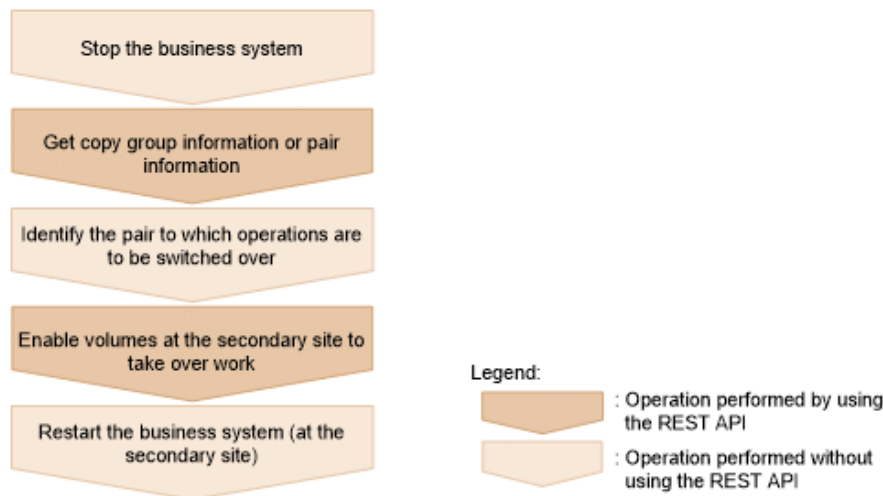

Stop the business system

When a failure is detected at the primary site, stop the business system, and make sure that there is no I/O to or from the hosts.

Get copy group information or pair information

Get a list of the copy groups on the storage system of the secondary site. Then, based on this information, get copy pair information for the secondary site. When executing these API requests, you need to specify remote storage system information for the query parameter or object ID. In this situation, specify NotSpecified.

Identify the pair to which business operations are to be switched over

Based on the pair information for the secondary site, identify the pair to which business operations are to be switched over.

Switch over business operations to a volume at the secondary site

Specify the pair or copy group, and then switch the roles of the primary volume and the secondary volume. Data can now be written to the secondary volume.



Note: When `auto` is specified as the takeover execution mode, the storage systems at the secondary site automatically try to resynchronize with the storage systems at the primary site. If the resynchronization succeeds, you do not need to split and then resynchronize the pair by performing the following flow of operations (the flow of operations for copying data from the secondary site to the primary site). To check whether the resynchronization was successful, get pair information.

Restart the business system (at the secondary site)

Restart the operations of the business system at the secondary site.

Copying data from the secondary site to the primary site

After recovery is complete for the primary site, apply the data that was written to the secondary site during the failure to the primary site. The following figure shows the flow of operations:

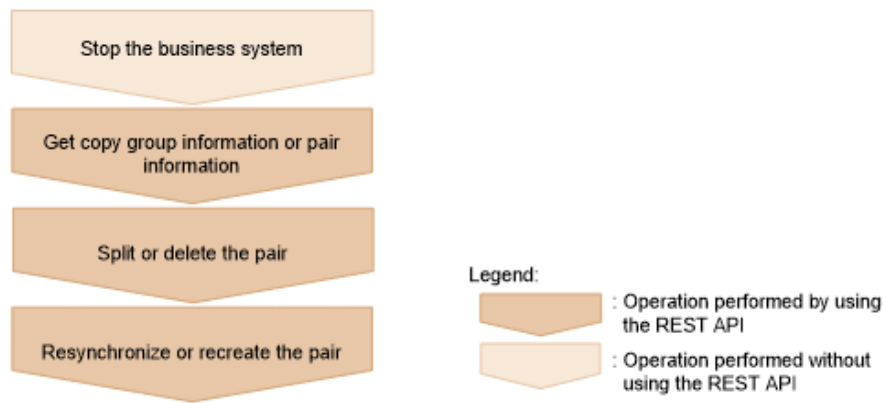

Stop the business system

Stop the business system, and make sure that there is no I/O to or from the hosts.

Get copy group information or pair information

Get copy pair information based on the copy group information, and then check the pair status.

Split or delete the pair

Perform one of the following operations if necessary, according to the pair status:

- If the pair status of the S-VOL is SSWS, split the pair.
- If the pair status of the P-VOL or the S-VOL is SMPL, delete the pair.

Resynchronize or re-create the pair

Perform one of the following operations if necessary, according to the pair status:

- If the pair status of the S-VOL is SSWS, resynchronize the pair at the secondary site (the S-VOL). At this time, specify `true` for `doSwapSvol`.
- If the pair status of both the primary site and the secondary site is SMPL, create a pair by specifying the P-VOL for the secondary site.

Returning the pair relationship between the primary site and the secondary site to the state it was in before the failure

When all pair statuses are PAIR and all data on the secondary site is applied to the primary site, normal operation can be restarted at the primary site. The following figure shows the flow of operations:

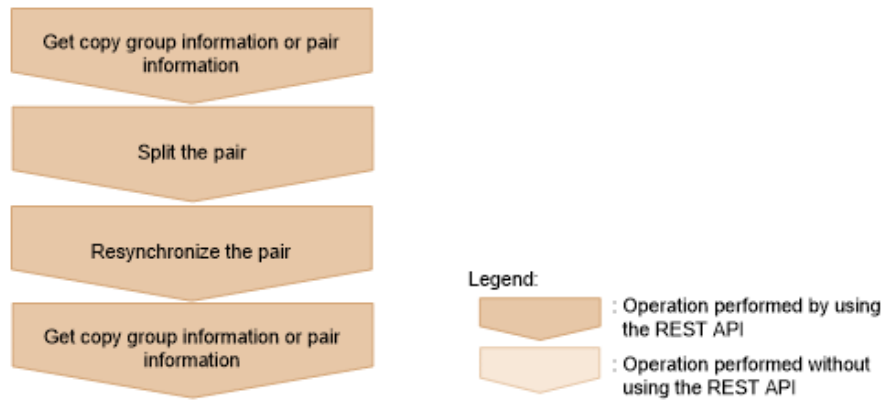

Get copy group information or pair information

Get pair information based on copy group information, and make sure that the status of the target pair is `PAIR`.

Split the pair

Split the pair.

Resynchronize the pair

Resynchronize the pair at the primary site (P-VOL). Specify `true` for `doSwapSvol`.

Get copy group information or pair information

Get pair information based on copy group information, and make sure that the status of the target pair is `PAIR`.

The pair relationship between the primary site and the secondary site and the copy direction are returned to the state they were in before the failure, and the business system can now be restarted.



Pair status (TrueCopy and Universal Replicator)

This section explains the operations and status transition for TrueCopy pairs and Universal Replicator pairs.

Pair status for TrueCopy pairs

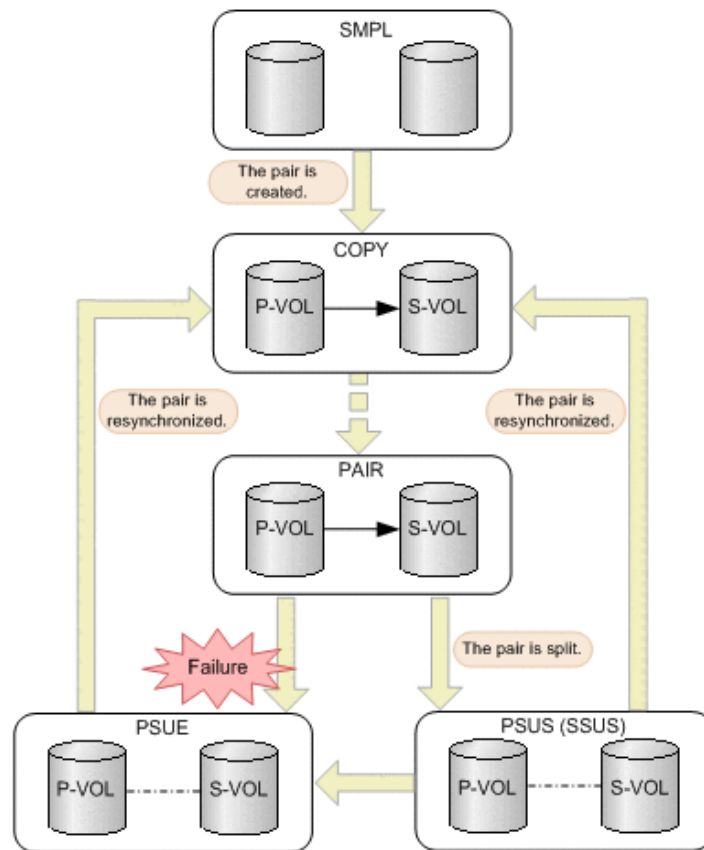
The following explains the operations and status transitions for TrueCopy pairs.



Legend:
 P-VOL: Primary volume
 S-VOL: Secondary volume
 : Indicates an operation for the pair by the REST API.
 : Indicates the status of the pair.

Pair status	Description	Access to the P-VOL	Access to the S-VOL
SMPL	Unpaired volumes	--	--
COPY	A pair is being created. An initial copy or resynchronization is being performed.	R/W enabled	R enabled
PAIR	Paired volumes The initial copy finished, and the pair volumes are synchronized.	R/W enabled	R enabled
PSUS	The pair is split by operation, or deleted from the storage system on the secondary site. (This value is output for the P-VOL.)	R/W enabled	R/W enabled

Pair status	Description	Access to the P-VOL	Access to the S-VOL
			#1
SSUS	The pair is split by operation, or deleted from the storage system on the secondary site. (This value is output for the S-VOL.)	R/W enabled	R/W enabled #1
PSUE	The pair is split due to a failure.	R/W enabled #2	R enabled
SSWS	The P-VOL and S-VOL are switched, and the S-VOL is writable.	R enabled	R/W enabled

#1: When you split a pair, you can specify whether to permit read-write or read-only.

#2: When the fence level of the P-VOL is DATA (S-VOL data), read-only is permitted.

If you delete a pair, the pair status changes to SMPL.

Pair status for Universal Replicator pairs

The following explains the operations and status transitions for Universal Replicator pairs.

Universal Replicator pairs have specific pair statuses because Universal Replicator pairs use the journal volume to asynchronously copy data.

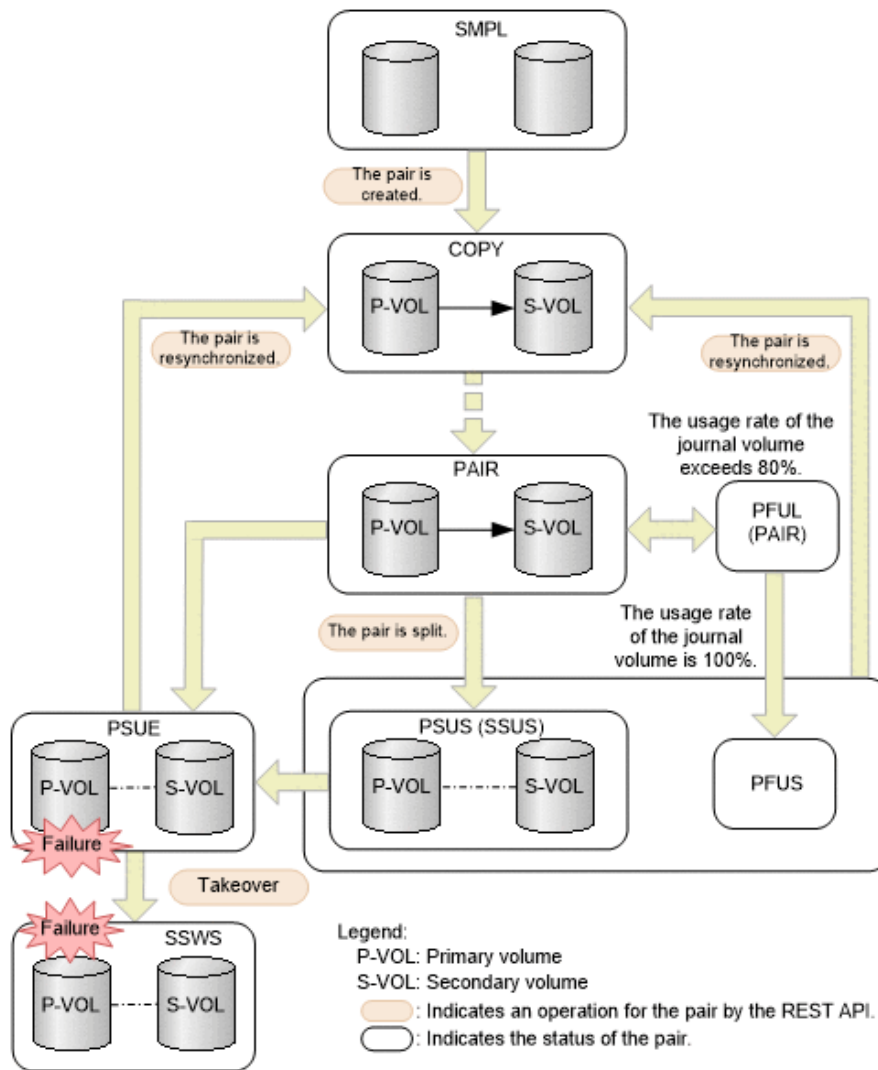

Pair status	Description	Access to the P-VOL	Access to the S-VOL
SMPL	Unpaired volumes	--	--
COPY	A pair is being created. An initial copy or resynchronization is being performed.	R/W enabled	R enabled
PAIR	Paired volumes The initial copy is finished, and the pair volumes are synchronized.	R/W enabled	R enabled
PSUS	The pair is split by operation, or deleted from the storage system on the secondary site. (This value is output for the P-VOL.)	R/W enabled	R/W enabled

Pair status	Description	Access to the P-VOL	Access to the S-VOL
			#
SSUS	The pair is split by operation, or deleted from the storage system on the secondary site. (This value is output for the S-VOL.)	R/W enabled	R/W enabled #
PSUE	The pair is split due to a failure.	R/W enabled	R enabled
SSWS	The P-VOL and S-VOL are switched, and the S-VOL is writable.	R enabled	R/W enabled
PFUL	The amount of the data in the journal volume exceeds the threshold (80%). The pair is not split, and data continues to be copied.	R/W enabled	R enabled
PFUS	The amount of the data in the journal volume reaches 100%, and the pair is split. You must review the configurations of remote paths and the journal volume.	R/W enabled	R enabled #

#: This is determined by the secondary volume's access mode that is specified to split the pair. (Default: Read is enabled.)

If you delete a pair, the pair status changes to SMPL.



Note:

In the following cases, if you perform an operation on a pair, the request successfully returns a response, but the details specified in the request body are not actually applied:

- When you perform a pair splitting operation on a pair for which the status is PSUS or SSUS
- When you perform a pair resynchronization operation on a pair for which the status is COPY or PAIR

Getting a list of remote copy groups

The following request gets a list of all the remote copy groups in which the remote copy pairs (TrueCopy, Universal Replicator, and global-active device) of the target storage system are registered. If the device group name or copy group name contains spaces, copy group information cannot be obtained.

Execution permission

Storage Administrator (View Only)

Request lineGET *base-URL*/v1/objects/remote-mirror-copygroups**Request message****Object ID**

None.

Query parameters

Parameter	Type	Filter Condition
remoteStorageDeviceId	string	(Required) Storage device ID of the remote storage system If a failure occurs in a remote storage system and you then specify <code>NotSpecified</code> , only the information about the local storage system is obtained. In this situation (when a failure occurs and you specify <code>NotSpecified</code>), you do not need to specify the <code>Remote-Authorization</code> header.

Body

None.

Response message**Body**

```
{
  "data" : [ {
    "remoteMirrorCopyGroupId" : "886000123789,remoteCopyGroup1,
remoteCopyGroup1S_,remoteCopyGroup1P_",
    "copyGroupName" : "remoteCopyGroup1",
    "muNumber" : 0,
    "remoteStorageDeviceId" : "886000123789",
    "localDeviceGroupName" : "remoteCopyGroup1S_",
    "remoteDeviceGroupName" : "remoteCopyGroup1P_"
  }, {
    "remoteMirrorCopyGroupId" : "886000123789,remoteCopyGroup2,
remoteCopyGroup2P_,remoteCopyGroup2S_",
    "copyGroupName" : "remoteCopyGroup2",
```

```

    "muNumber" : 0,
    "remoteStorageDeviceId" : "886000123789",
    "localDeviceGroupName" : "remoteCopyGroup2P_",
    "remoteDeviceGroupName" : "remoteCopyGroup2S_"
  }, {
    "remoteMirrorCopyGroupId" : "886000123789,remoteCopyGroup3,
remoteCopyGroup3P_,remoteCopyGroup3S_",
    "copyGroupName" : "remoteCopyGroup3",
    "muNumber" : 0,
    "remoteStorageDeviceId" : "886000123789",
    "localDeviceGroupName" : "remoteCopyGroup3P_",
    "remoteDeviceGroupName" : "remoteCopyGroup3S_"
  } ]
}

```

Attribute	Type	Description
remoteStorageDeviceId	string	Storage device ID of the remote storage system If you specify <code>NotSpecified</code> for <code>remoteStorageDeviceId</code> , <code>NotSpecified</code> is output.
copyGroupName	string	Copy group name
localDeviceGroupName	string	Device group name in the local storage system
remoteDeviceGroupName	string	Device group name in the remote storage system If you specify <code>NotSpecified</code> for <code>remoteStorageDeviceId</code> , <code>NotSpecified</code> is output.
muNumber	int	MU (mirror unit) number If the MU number cannot be obtained, information is not output.
remoteMirrorCopyGroupId	string	Object ID of the remote copy group The following attributes are output, separated by commas: <ul style="list-style-type: none"> ▪ remoteStorageDeviceId ▪ copyGroupName ▪ localDeviceGroupName ▪ remoteDeviceGroupName

Status codes

For details on the status codes of the request for this operation, see the description on HTTP status codes.

Coding example

```
curl -v -H "Accept: application/json" -H "Remote-Authorization:Session
10399a1ffce3489b9c3a823017462396" -H "Authorization:Session
d7b673af189048468c5af9bcf3bbbbb6f" -X GET https://192.0.2.100/
ConfigurationManager/v1/objects/remote-mirror-copygroups?
remoteStorageDeviceId=886000123789
```

Getting information about a specific remote copy group

The following request gets information about the specified copy group. This request also gets information about the pairs (TrueCopy, Universal Replicator, or global-active device) included in the copy group. If the copy group name or copy pair name contains spaces, pair information cannot be obtained.

Execution permission

Storage Administrator (View Only)

Request line

```
GET base-URL/v1/objects/remote-mirror-copygroups/object-ID
```

Request message**Object ID**

Specify the value of `remoteMirrorCopyGroupId` that was obtained by the processing to get information about the remote copy group. You can also specify the attributes and connect them with commas as follows:

```
remoteStorageDeviceId, copyGroupName, localDeviceGroupName,
remoteDeviceGroupName
```

Attribute	Type	Description
remoteStorageDeviceId	string	(Required) Storage device ID of the remote storage system# Specify a decimal (base 10) number equal to or greater than 0.

Attribute	Type	Description
copyGroupName	string	(Required) Copy group name Specify a character string consisting of 1 to 31 characters. The name is case sensitive.
localDeviceGroupName	string	(Required) Device group name in the local storage system Specify a character string consisting of 1 to 31 characters. The name is case sensitive.
remoteDeviceGroupName	string	(Required) Device group name in the remote storage system# Specify a character string consisting of 1 to 31 characters. The name is case sensitive.

#: If you specify `NotSpecified` in cases such as when a failure occurs in a remote storage system, only information about the local storage system can be acquired. If you specify `NotSpecified`, copy pair information about attributes of volumes that belong to the remote storage system will not be output. In this case, you do not need to specify the `Remote-Authorization` header.

Query parameters

None.

Body

None.

Response message

Body

The following is an example of the output when information about TrueCopy pairs is obtained:

```
{
  "remoteMirrorCopyGroupId" : "886000123789,remoteCopyGroup1,
remoteCopyGroup1P_,remoteCopyGroup1S_",
  "copyGroupName" : "remoteCopyGroup1",
  "copyPairs" : [ {
    "copyGroupName" : "remoteCopyGroup1",
    "copyPairName" : "pair1",
    "replicationType" : "TC",
    "remoteMirrorCopyPairId" : "886000123789,remoteCopyGroup1,
remoteCopyGroup1P_,remoteCopyGroup1S_,pair1",
    "pvolLdevId" : 2108,
    "svolLdevId" : 1581,
```

```

    "fenceLevel" : "DATA",
    "pvolStatus" : "PAIR",
    "svolStatus" : "PAIR",
    "consistencyGroupId": 5,
    "pvolStorageDeviceId" : "886000123456",
    "svolStorageDeviceId" : "886000123789"
  }, {
    "copyGroupName" : "remoteCopyGroup1",
    "copyPairName" : "pair2",
    "replicationType" : "TC",
    "remoteMirrorCopyPairId" : "886000123789,remoteCopyGroup1,
remoteCopyGroup1P_,remoteCopyGroup1S_,pair2",
    "pvolLdevId" : 2109,
    "svolLdevId" : 1582,
    "fenceLevel" : "DATA",
    "pvolStatus" : "PSUS",
    "svolStatus" : "SMPL",
    "consistencyGroupId": 5,
    "pvolStorageDeviceId" : "886000123456",
    "svolStorageDeviceId" : "886000123789"
  } ],
  "remoteStorageDeviceId" : "886000123789",
  "localDeviceGroupName" : "remoteCopyGroup1P_",
  "remoteDeviceGroupName" : "remoteCopyGroup1S_"
}

```

The following is an example of the output when information about Universal Replicator pairs is obtained:

```

{
  "remoteMirrorCopyGroupId" : "886000123789,remoteCopyGroup2,
remoteCopyGroup2P_,remoteCopyGroup2S_",
  "copyGroupName" : "remoteCopyGroup2",
  "copyPairs" : [ {
    "copyGroupName" : "remoteCopyGroup2",
    "copyPairName" : "pair1",
    "replicationType" : "UR",
    "remoteMirrorCopyPairId" : "886000123789,remoteCopyGroup2,
remoteCopyGroup2P_,remoteCopyGroup2S_,pair1",
    "consistencyGroupId" : 10,
    "pvolLdevId" : 1569,
    "pvolJournalId" : 13,
    "svolLdevId" : 2835,
    "svolJournalId" : 36,
    "fenceLevel" : "ASYNC",
    "pvolStatus" : "PAIR",
    "svolStatus" : "PAIR",
    "pvolStorageDeviceId" : "886000123456",
    "svolStorageDeviceId" : "886000123789"
  } ]
}

```

```

    } ],
    "remoteStorageDeviceId" : "886000123789",
    "localDeviceGroupName" : "remoteCopyGroup2P_",
    "remoteDeviceGroupName" : "remoteCopyGroup2S_"
  }

```

The following is an example of the output when information about global-active device pairs is obtained:

```

{
  "remoteMirrorCopyGroupId" : "886000123789,remoteCopyGroup3,
remoteCopyGroup3P_,remoteCopyGroup3S_",
  "copyGroupName" : "remoteCopyGroup3",
  "copyPairs" : [ {
    "copyGroupName" : "remoteCopyGroup3",
    "copyPairName" : "pair1",
    "replicationType" : "GAD",
    "remoteMirrorCopyPairId" : "886000123789,remoteCopyGroup3,
remoteCopyGroup3P_,remoteCopyGroup3S_,pair1",
    "quorumDiskId" : 14,
    "pvolLdevId" : 1580,
    "svolLdevId" : 2128,
    "fenceLevel" : "NEVER",
    "pvolStatus" : "PAIR",
    "svolStatus" : "PAIR",
    "pvolIOMode" : "L/M",
    "svolIOMode" : "L/M",
    "pvolStorageDeviceId" : "886000123456",
    "svolStorageDeviceId" : "886000123789"
  } ],
  "remoteStorageDeviceId" : "886000123789",
  "localDeviceGroupName" : "remoteCopyGroup3P_",
  "remoteDeviceGroupName" : "remoteCopyGroup3S_"
}

```

Attribute	Type	Description
remoteStorageDeviceId	string	Storage device ID of the remote storage system If you specify a value that includes NotSpecified for the object ID, NotSpecified is output.
copyGroupName	string	Copy group name
localDeviceGroupName	string	Device group name in the local storage system

Attribute	Type	Description
remoteDeviceGroupName	string	Device group name in the remote storage system If you specify a value that includes <code>NotSpecified</code> for the object ID, <code>NotSpecified</code> is output.
remoteMirrorCopyGroupId	string	Object ID of the remote copy group The following attributes are output, separated by commas: <ul style="list-style-type: none"> ▪ <code>remoteStorageDeviceId</code> ▪ <code>copyGroupName</code> ▪ <code>localDeviceGroupName</code> ▪ <code>remoteDeviceGroupName</code>

Attribute	Type	Description
copyPairs	object[]	The detailed information about the copy pair is output.

Attribute	Type	Description
		<ul style="list-style-type: none"> ▪ copyGroupName (string) Copy group name ▪ copyPairName (string) Copy pair name ▪ replicationType (string) Pair type <ul style="list-style-type: none"> ▪ TC: TrueCopy ▪ UR: Universal Replicator ▪ GAD: global-active device <p>If the pair status is <code>SMPL</code>, information is not output.</p> ▪ pvolLdevId (int) LDEV number of P-VOL If you specify a value that includes <code>NotSpecified</code> for the object ID, this attribute is output only if the P-VOL is a volume in the local storage system. ▪ svolLdevId (int) LDEV number of S-VOL If you specify a value that includes <code>NotSpecified</code> for the object ID, this attribute is output only if the S-VOL is a volume in the local storage system. ▪ fenceLevel (string) Fence level <ul style="list-style-type: none"> ▪ DATA: S-VOL data ▪ STATUS: S-VOL status ▪ NEVER: None ▪ ASYNC: Asynchronous <p>If the fence level cannot be obtained, information is not output.</p> ▪ pvolJournalId (int) Journal ID of the P-VOL If you specify a value that includes <code>NotSpecified</code> for the object ID, this

Attribute	Type	Description
		<p>attribute is output only if the P-VOL is a volume in the local storage system.</p> <p>A value from 0 to 255 is output only in the case of UR. If the pair status is <i>SMPL</i>, information is not output.</p> <ul style="list-style-type: none"> ▪ <i>svolJournalId</i> (int) Journal ID of the S-VOL If you specify a value that includes <i>NotSpecified</i> for the object ID, this attribute is output only if the S-VOL is a volume in the local storage system. <p>A value from 0 to 255 is output only in the case of UR. If the pair status is <i>SMPL</i>, information is not output.</p> <ul style="list-style-type: none"> ▪ <i>quorumDiskId</i> (int) ID of the Quorum disk A value from 0 to 31 is output only in the case of GAD. If the pair status is <i>SMPL</i>, information is not output. ▪ <i>pvolStatus</i> (string) Pair status of the P-VOL If you specify a value that includes <i>NotSpecified</i> for the object ID, this attribute is output only if the P-VOL is a volume in the local storage system. For details, see the section explaining on pair status (TrueCopy and Universal Replicator) or pair status (global-active device). If the pair status cannot be obtained, information is not output. ▪ <i>svolStatus</i> (string) Pair status of the S-VOL If you specify a value that includes <i>NotSpecified</i> for the object ID, this attribute is output only if the S-VOL is a volume in the local storage system.

Attribute	Type	Description
		<p>For details, see the section explaining on pair status (TrueCopy and Universal Replicator) or pair status (global-active device).</p> <p>If the pair status cannot be obtained, information is not output.</p> <ul style="list-style-type: none"> ▪ consistencyGroupld (int) Consistency group ID If no consistency group consists, information is not output. ▪ pvollIOMode (string) I/O mode of the P-VOL <ul style="list-style-type: none"> ▪ L/M: Mirror (RL) ▪ L/L: Local ▪ B/B: Block <p>Information is output only in the case of GAD. If the pair status is <i>SMPL</i>, information is not output.</p> <p>If you specify a value that includes <i>NotSpecified</i> for the object ID, this attribute is output only if the P-VOL is a volume in the local storage system.</p> ▪ svollIOMode (string) I/O mode of the S-VOL <ul style="list-style-type: none"> ▪ L/M: Mirror (RL) ▪ L/L: Local ▪ B/B: Block <p>Information is output only in the case of GAD. If the pair status is <i>SMPL</i>, information is not output.</p> <p>If you specify a value that includes <i>NotSpecified</i> for the object ID, this attribute is output only if the S-VOL is a volume in the local storage system.</p> ▪ pvolStorageDeviceId (string) Storage device ID of the storage system on the P-VOL

Attribute	Type	Description
		<p>If you specify a value that includes <code>NotSpecified</code> for the object ID, this attribute is output only if the P-VOL is a volume in the local storage system.</p> <ul style="list-style-type: none"> ▪ <code>svolStorageDeviceId</code> (string) Storage device ID of the storage system on the S-VOL <p>If you specify a value that includes <code>NotSpecified</code> for the object ID, this attribute is output only if the S-VOL is a volume in the local storage system.</p> <ul style="list-style-type: none"> ▪ <code>copyProgressRate</code> (int) Copy progress rate Information is output only when the pair status of the P-VOL is <code>COPY</code> (a pair is being created or resynchronized). This attribute is not output if you specify a value that includes <code>NotSpecified</code> for the object ID. ▪ <code>remoteMirrorCopyPairId</code> (string) Object ID of the remote copy pair[#] The following attributes are output, separated by commas: <ul style="list-style-type: none"> ▪ <code>remoteStorageDeviceId</code> ▪ <code>copyGroupName</code> ▪ <code>localDeviceGroupName</code> ▪ <code>remoteDeviceGroupName</code> ▪ <code>copyPairName</code>

[#]: We recommend that you save the object ID information you obtain in case a failure occurs. When you need to perform a takeover to recover the system, you can use the saved information to identify the pair that you need to work on, even if you cannot get information about the failed storage system.

Status codes

For details on the status codes of the request for this operation, see the description on HTTP status codes.

Coding example

For TrueCopy:

```
curl -v -H "Accept: application/json" -H "Remote-Authorization:Session
10399a1ffce3489b9c3a823017462396" -H "Authorization:Session
d7b673af189048468c5af9bcf3bbbb6f" -X GET https://192.0.2.100/
ConfigurationManager/v1/objects/remote-mirror-copygroups/886000123789,
remoteCopyGroup1,remoteCopyGroup1P_,remoteCopyGroup1S_
```

For Universal Replicator:

```
curl -v -H "Accept: application/json" -H "Remote-Authorization:Session
10399a1ffce3489b9c3a823017462396" -H "Authorization:Session
d7b673af189048468c5af9bcf3bbbb6f" -X GET https://192.0.2.100/
ConfigurationManager/v1/objects/remote-mirror-copygroups/886000123789,
remoteCopyGroup2,remoteCopyGroup2P_,remoteCopyGroup2S_
```

For global-active device:

```
curl -v -H "Accept: application/json" -H "Remote-Authorization:Session
10399a1ffce3489b9c3a823017462396" -H "Authorization:Session
d7b673af189048468c5af9bcf3bbbb6f" -X GET https://192.0.2.100/
ConfigurationManager/v1/objects/remote-mirror-copygroups/886000123789,
remoteCopyGroup3,remoteCopyGroup3P_,remoteCopyGroup3S_
```

Getting information about a specific remote copy pair

The following request gets information about the specified copy pair (TrueCopy, Universal Replicator, or global-active device). Use this information to get the information that is necessary for performing pair operations (for example, the pair status). If the copy group name or copy pair name contains spaces, pair information cannot be obtained.

Execution permission

Storage Administrator (View Only)

Request line

```
GET base-URL/v1/objects/remote-mirror-coppairs/object-ID
```

Request message**Object ID**

Specify the value of `remoteMirrorCopyPairId` that was obtained by the processing to get information about the remote copy group. You can also specify the attributes and connect them with commas as follows:

```
remoteStorageDeviceId, copyGroupName, localDeviceGroupName,
remoteDeviceGroupName, copyPairName
```

Attribute	Type	Description
remoteStorageDeviceId	string	(Required) Storage device ID of the remote storage system # Specify a decimal (base 10) number equal to or greater than 0.
copyGroupName	string	(Required) Copy group name Specify a character string consisting of 1 to 31 characters. The name is case sensitive.
localDeviceGroupName	string	(Required) Device group name in the local storage system Specify a character string consisting of 1 to 31 characters. The name is case sensitive.
remoteDeviceGroupName	string	(Required) Device group name in the remote storage system # Specify a character string consisting of 1 to 31 characters. The name is case sensitive.
copyPairName	string	(Required) Copy pair name Specify a name consisting of 1 to 31 characters. The name is case sensitive.

#: If you specify `NotSpecified` in cases such as when a failure occurs in a remote storage system, only information about the local storage system can be acquired. If you specify `NotSpecified`, copy pair information about attributes of volumes that belong to the remote storage system will not be output. In this case, you do not need to specify the `Remote-Authorization` header.

Query parameters

None.

Body

None.

Response message**Body**

The following is an example of the output when information about TrueCopy pairs is obtained:

```
{
  "copyGroupName" : "remoteCopyGroup1",
  "copyPairName" : "pair1",
  "replicationType" : "TC",
  "remoteMirrorCopyPairId" : "886000123789,remoteCopyGroup1,
remoteCopyGroup1P_,remoteCopyGroup1S_,pair1",
  "pvolLdevId" : 2108,
  "svolLdevId" : 1581,
  "fenceLevel" : "DATA",
  "pvolStatus" : "PAIR",
  "svolStatus" : "PAIR",
  "pvolStorageDeviceId" : "886000123456",
  "svolStorageDeviceId" : "886000123789"
}
```

The following is an example of the output when information about Universal Replicator pairs is obtained:

```
{
  "copyGroupName" : "remoteCopyGroup2",
  "copyPairName" : "pair1",
  "replicationType" : "UR",
  "remoteMirrorCopyPairId" : "886000123789,remoteCopyGroup2,
remoteCopyGroup2P_,remoteCopyGroup2S_,pair1",
  "consistencyGroupId" : 10,
  "pvolLdevId" : 1569,
  "pvolJournalId" : 13,
  "svolLdevId" : 2835,
  "svolJournalId" : 36,
  "fenceLevel" : "ASYNC",
  "pvolStatus" : "PAIR",
  "svolStatus" : "PAIR",
  "pvolStorageDeviceId" : "886000123456",
  "svolStorageDeviceId" : "886000123789"
}
```

The following is an example of the output when information about global-active device pairs is obtained:

```
{
  "copyGroupName" : "remoteCopyGroup3",
  "copyPairName" : "pair1",
  "replicationType" : "GAD",
}
```



```

    "remoteMirrorCopyPairId" : "886000123789,remoteCopyGroup3,
remoteCopyGroup3P_,remoteCopyGroup3S_,pair1",
    "quorumDiskId" : 14,
    "pvolLdevId" : 1580,
    "svolLdevId" : 2128,
    "fenceLevel" : "NEVER",
    "pvolStatus" : "PAIR",
    "svolStatus" : "PAIR",
    "pvolIOMode" : "L/M",
    "svolIOMode" : "L/M",
    "pvolStorageDeviceId" : "886000123456",
    "svolStorageDeviceId" : "886000123789"
}

```

Attribute	Type	Description
copyGroupName	string	Copy group name
copyPairName	string	Copy pair name
replicationType	string	Pair type <ul style="list-style-type: none"> ▪ TC: TrueCopy ▪ UR: Universal Replicator ▪ GAD: global-active device If the pair status is <code>SMPL</code> , information is not output.
pvolLdevId	int	LDEV number of P-VOL If you specify a value that includes <code>NotSpecified</code> for the object ID, this attribute is output only if the P-VOL is a volume in the local storage system.
svolLdevId	int	LDEV number of S-VOL If you specify a value that includes <code>NotSpecified</code> for the object ID, this attribute is output only if the S-VOL is a volume in the local storage system.
fenceLevel	string	Fence level <ul style="list-style-type: none"> ▪ DATA: S-VOL data ▪ STATUS: S-VOL status ▪ NEVER: None ▪ ASYNC: Asynchronous

Attribute	Type	Description
		If the fence level cannot be obtained, information is not output.
pvolJournalId	int	Journal ID of the P-VOL A value from 0 to 255 is output only in the case of UR. If the pair status is <i>SMPL</i> , information is not output. If you specify a value that includes <i>NotSpecified</i> for the object ID, this attribute is output only if the P-VOL is a volume in the local storage system.
svolJournalId	int	Journal ID of the S-VOL A value from 0 to 255 is output only in the case of UR. If the pair status is <i>SMPL</i> , information is not output. If you specify a value that includes <i>NotSpecified</i> for the object ID, this attribute is output only if the S-VOL is a volume in the local storage system.
quorumDiskId	int	ID of the Quorum disk A value from 0 to 31 is output only in the case of GAD. If the pair status is <i>SMPL</i> , information is not output.
pvolStatus	string	Pair status of the P-VOL For details, see the section explaining on pair status (TrueCopy and Universal Replicator) or pair status (global-active device). If the pair status cannot be obtained, information is not output. If you specify a value that includes <i>NotSpecified</i> for the object ID, this attribute is output only if the P-VOL is a volume in the local storage system.
svolStatus	string	Pair status of the S-VOL For details, see the section explaining on pair status (TrueCopy and Universal Replicator) or pair status (global-active device). If the pair status cannot be obtained, information is not output.

Attribute	Type	Description
		If you specify a value that includes <code>NotSpecified</code> for the object ID, this attribute is output only if the S-VOL is a volume in the local storage system.
<code>consistencyGroupid</code>	int	Consistency group ID If no consistency group consists, information is not output.
<code>pvollIOMode</code>	string	I/O mode of the P-VOL <ul style="list-style-type: none"> ▪ L/M: Mirror (RL) ▪ L/L: Local ▪ B/B: Block Information is output only in the case of GAD. If the pair status is <code>SMPL</code> , information is not output. If you specify a value that includes <code>NotSpecified</code> for the object ID, this attribute is output only if the P-VOL is a volume in the local storage system.
<code>svollIOMode</code>	string	I/O mode of the S-VOL <ul style="list-style-type: none"> ▪ L/M: Mirror (RL) ▪ L/L: Local ▪ B/B: Block Information is output only in the case of GAD. If the pair status is <code>SMPL</code> , information is not output. If you specify a value that includes <code>NotSpecified</code> for the object ID, this attribute is output only if the S-VOL is a volume in the local storage system.
<code>pvolStorageDeviceid</code>	string	Storage device ID of the storage system on the P-VOL If you specify a value that includes <code>NotSpecified</code> for the object ID, this attribute is output only if the P-VOL is a volume in the local storage system.
<code>svolStorageDeviceid</code>	string	Storage device ID of the storage system on the S-VOL If you specify a value that includes <code>NotSpecified</code> for the object ID, this attribute is output only if the S-VOL is a volume in the local storage system.
<code>copyProgressRate</code>	int	Copy progress rate

Attribute	Type	Description
		Information is output only when the pair status of the P-VOL is <code>COPY</code> (a pair is being created or resynchronized). This attribute is not output if you specify a value that includes <code>NotSpecified</code> for the object ID.
<code>remoteMirrorCopyPairId</code>	string	Object ID of the remote copy pair# The following attributes are output, separated by commas: <ul style="list-style-type: none"> ▪ <code>remoteStorageDeviceId</code> ▪ <code>copyGroupName</code> ▪ <code>localDeviceGroupName</code> ▪ <code>remoteDeviceGroupName</code> ▪ <code>copyPairName</code>

#: We recommend that you save the object ID information you obtain in case a failure occurs. When you need to perform a takeover to recover the system, you can use the saved information to identify the pair that you need to work on, even if you cannot get information about the failed storage system.

Status codes

For details on the status codes of the request for this operation, see the description on HTTP status codes.

Coding example

For TrueCopy:

```
curl -v -H "Accept: application/json" -H "Remote-Authorization:Session
10399a1ffce3489b9c3a823017462396" -H "Authorization:Session
d7b673af189048468c5af9bcf3b66b6f" -X GET https://192.0.2.100/
ConfigurationManager/v1/objects/remote-mirror-copypairs/886000123789,
remoteCopyGroup1,remoteCopyGroup1P_,remoteCopyGroup1S_,pair1
```

For Universal Replicator:

```
curl -v -H "Accept: application/json" -H "Remote-Authorization:Session
10399a1ffce3489b9c3a823017462396" -H "Authorization:Session
d7b673af189048468c5af9bcf3b66b6f" -X GET https://192.0.2.100/
ConfigurationManager/v1/objects/remote-mirror-copypairs/886000123789,
remoteCopyGroup2,remoteCopyGroup2P_,remoteCopyGroup2S_,pair1
```

For global-active device:

```
curl -v -H "Accept: application/json" -H "Remote-Authorization:Session
10399a1ffce3489b9c3a823017462396" -H "Authorization:Session
d7b673af189048468c5af9bcf3bbbbb6f" -X GET https://192.0.2.100/
ConfigurationManager/v1/objects/remote-mirror-copypairs/886000123789,
remoteCopyGroup3,remoteCopyGroup3P_,remoteCopyGroup3S_,pair1
```

Creating a TrueCopy pair or Universal Replicator pair

The following request creates a TrueCopy pair or a Universal Replicator pair in the storage systems of the primary and secondary sites. The TrueCopy pair or the Universal Replicator pair is either added to a new copy group or to an existing copy group. If you create a copy group, also create a device group. First create a pair in the storage system of the primary site. Before creating a pair, lock the resources or make sure that the resources have not been locked by another user.



Tip: We recommend specifying `Job-Mode-Wait-Configuration-Change:NoWait` in the request header of this API function. For details, see the description of the flow of operations for the pairs.

Execution permission

Storage Administrator (Provisioning) and Storage Administrator (Remote Copy)

Request line

```
POST base-URL/v1/objects/remote-mirror-copypairs
```

Request message

Object ID

None.

Query parameters

None.

Body

The following are coding examples for creating a TrueCopy pair.

When creating a new copy group and adding a pair to the copy group:

```
{
  "copyGroupName": "remoteCopyGroup1",
  "copyPairName": "pair1",
  "replicationType": "TC",
  "remoteStorageDeviceId": "886000123789",
  "pvolldevId": 2108,
```

```

"svolLdevId": 1581,
"localDeviceGroupName": "remoteCopyGroup1P_",
"remoteDeviceGroupName": "remoteCopyGroup1S_",
"isNewGroupCreation": true,
"fenceLevel": "DATA",
"isConsistencyGroup": true,
"consistencyGroupId": 5,
"copyPace": 10,
"pathGroupId": 3,
"doInitialCopy": true,
"isDataReductionForceCopy": true
}

```

When adding a pair to an existing copy group:

```

{
"copyGroupName": "remoteCopyGroup1",
"copyPairName": "pair2",
"replicationType": "TC",
"remoteStorageDeviceId": "886000123789",
"pvolldevId": 2109,
"svolldevId": 1582,
"localDeviceGroupName": "remoteCopyGroup1P_",
"remoteDeviceGroupName": "remoteCopyGroup1S_",
"isNewGroupCreation": false,
"fenceLevel": "DATA",
"isConsistencyGroup": true,
"consistencyGroupId": 5,
"copyPace": 10,
"doInitialCopy": true,
"isDataReductionForceCopy": false
}

```

The following table describes attributes for a TrueCopy pair.

Attribute	Type	Description
copyGroupName	string	(Required) Specify a copy group name consisting of 1 to 29 characters. The name is case sensitive. Set a unique name that is the same for the storage systems on both the local and remote sides.
copyPairName	string	(Required) Specify a copy pair name consisting of 1 to 31 characters. The name is case sensitive.

Attribute	Type	Description
		Set a unique name that is the same for the storage systems in the copy group.
replicationType	string	(Required) Specify the pair type. TC: TrueCopy
remoteStorageDeviceId	string	(Required) Specify the storage device ID of the remote storage system in which the pair is to be created.
pvolLdevId	int	(Required) Specify the LDEV number of the P-VOL with a decimal (base 10) number.
svolLdevId	int	(Required) Specify the LDEV number of the S-VOL with a decimal (base 10) number.
pathGroupId	int	(Optional) Specify the path group ID by using a decimal (base 10) number in the range from 0 to 255. If you omit this value or specify 0, the lowest path group ID in the specified path group is used.
localDeviceGroupName	string	(Optional) Specify the device group name in the local storage system by using 1 to 31 characters. The name is case sensitive. If you add the pair to an existing copy group, specify the same device group name as that of the existing local storage system. If this value is omitted, <i>copyGroupNameP_</i> is set. The name needs to be unique in the local storage system.
remoteDeviceGroupName	string	(Optional) Specify the device group name in the remote storage system by using 1 to 31 characters. The name is case sensitive. If you add the pair to an existing copy group, specify the same device group name as that of the existing remote storage system. If this value is omitted, <i>copyGroupNameS_</i> is set. The name needs to be unique in the remote storage system.

Attribute	Type	Description
isNewGroupCreation	boolean	<p>(Required) Depending on the value, this attribute specifies whether to add the pair to a newly created copy group or to an existing copy group.</p> <ul style="list-style-type: none"> ▪ <code>true</code>: Adds the pair to a newly created copy group. ▪ <code>false</code>: Adds the pair to an existing copy group.
isConsistencyGroup	boolean	<p>(Optional) Depending on the value, this attribute specifies whether to register the new pair in a consistency group.</p> <ul style="list-style-type: none"> ▪ <code>true</code>: Registers the pair in a consistency group. ▪ <code>false</code>: Does not register the pair in a consistency group. <p>If you add the pair to an existing copy group, specify the same value as that of the existing copy pair. If a copy group includes both pairs that are registered in a consistency group and pairs that are not registered in a consistency group, pair operations by consistency group cannot be correctly performed. If this value is omitted, <code>false</code> is set.</p>
consistencyGroupId	int	<p>(Optional) Specify the consistency group ID by using a decimal (base 10) number in the range from 0 to 255.</p> <p>If you omit this value when registering the new pair in a consistency group, the value of the consistency group ID is automatically assigned.</p> <p>If you add the pair to an existing copy group, specify the same value as that of the existing copy pair. If a copy group includes a pair whose consistency group ID differs, pair operations by consistency group cannot be correctly performed.</p> <p>When specifying this attribute, make sure to specify <code>true</code> for the <code>isConsistencyGroup</code> attribute.</p>
fenceLevel	string	(Required) Fence level

Attribute	Type	Description
		The specifiable values are as follows: <ul style="list-style-type: none"> DATA: S-VOL data STATUS: S-VOL status NEVER: None
copyPace	int	(Optional) Copy speed Specify a decimal (base 10) number in the range from 1 to 15 for the size of tracks to be copied. The larger the value you specify, the faster the copy speed. If this value is omitted, 3 is assumed.
doInitialCopy	boolean	(Optional) Specify whether to perform initial copy when creating a pair. <ul style="list-style-type: none"> true: Performs initial copy. false: Does not perform initial copy. If this value is omitted, true is assumed.
isDataReductionForceCopy	boolean	(Optional) Specify whether to forcibly create a pair for the volume for which the capacity saving function (dedupe and compression) is enabled. <ul style="list-style-type: none"> true: Forcibly create a pair # false: Do not forcibly create a pair When the attribute is omitted, false is assumed.

#: Copying data of the volume for which the capacity saving function (compression or deduplication) is enabled might take up to several months, depending on the amount of data. Be sure to take this into account when planning when to create such a pair.

The following are coding examples for creating a Universal Replicator pair.

When creating a new copy group and adding a pair to the copy group:

```
{
  "copyGroupName": "remoteCopyGroup2",
  "copyPairName": "pair1",
  "replicationType": "UR",
  "remoteStorageDeviceId": "886000123789",
  "pvolLdevId": 1569,
```

```

"svolLdevId": 2835,
"pvolJournalId": 13,
"svolJournalId": 36,
"localDeviceGroupName": "remoteCopyGroup2P_",
"remoteDeviceGroupName": "remoteCopyGroup2S_",
"isNewGroupCreation": true,
"fenceLevel": "ASYNC",
"muNumber": 0,
"consistencyGroupId": 10,
"doInitialCopy": true,
"doDeltaResyncSuspend": false,
"isDataReductionForceCopy": true
}

```

When adding a pair to an existing copy group:

```

{
"copyGroupName": "remoteCopyGroup2",
"copyPairName": "pair2",
"replicationType": "UR",
"remoteStorageDeviceId": "886000123789",
"pvolLdevId": 1570,
"svolLdevId": 2836,
"localDeviceGroupName": "remoteCopyGroup2P_",
"remoteDeviceGroupName": "remoteCopyGroup2S_",
"isNewGroupCreation": false,
"fenceLevel": "ASYNC",
"consistencyGroupId": 10,
"doInitialCopy": true,
"doDeltaResyncSuspend": false,
"isDataReductionForceCopy": false
}

```

The following table describes attributes for a Universal Replicator pair.

Attribute	Type	Description
copyGroupName	string	(Required) Specify a copy group name consisting of 1 to 29 characters. The name is case sensitive. Set a unique name that is the same for the storage systems on both the local and remote sides.
copyPairName	string	(Required) Specify a copy pair name consisting of 1 to 31 characters. The name is case sensitive.

Attribute	Type	Description
		Set a unique name that is the same for the storage systems in the copy group.
replicationType	string	(Required) Specify the pair type. UR: Universal Replicator
remoteStorageDeviceId	string	(Required) Specify the storage device ID of the remote storage system in which the pair is to be created.
pvolLdevId	int	(Required) Specify the LDEV number of the P-VOL with a decimal (base 10) number.
svolLdevId	int	(Required) Specify the LDEV number of the S-VOL with a decimal (base 10) number.
pathGroupId	int	(Optional) Specify the path group ID by using a decimal (base 10) number in the range from 0 to 255. If you omit this value or specify 0, the lowest path group ID in the specified path group is used.
localDeviceGroupName	string	(Optional) Specify the device group name of the local storage system by using 1 to 31 characters. The name is case sensitive. If you add the pair to an existing copy group, specify the same device group name as that of the existing local storage system. If this value is omitted, <i>copyGroupNameP_</i> is set. The name needs to be unique in the local storage system.
remoteDeviceGroupName	string	(Optional) Specify the device group name of the remote storage system by using 1 to 31 characters. The name is case sensitive. If you add the pair to an existing copy group, specify the same device group name as that of the existing remote storage system. If this value is omitted, <i>copyGroupNameS_</i> is set. The name needs to be unique in the remote storage system.

Attribute	Type	Description
isNewGroupCreation	boolean	<p>(Required) Depending on the value, this attribute specifies whether to add the pair to a newly created copy group or to an existing copy group.</p> <ul style="list-style-type: none"> ▪ <code>true</code>: Adds the pair to a newly created copy group. ▪ <code>false</code>: Adds the pair to an existing copy group.
muNumber	int	<p>(Required) Specify the MU (mirror unit) number by using a number from 0 to 3.</p> <p>This value is used by the P-VOL and the S-VOL. You can specify this attribute only if you add the pair to a newly created copy group.</p>
pvolJournalId	int	<p>(Required) Specify the journal ID of the P-VOL by using a decimal (base 10) number in the range from 0 to 255.</p> <p>Make sure to specify this attribute if you add the pair to a newly created copy group.</p>
svolJournalId	int	<p>(Required) Specify the journal ID of the S-VOL by using a decimal (base 10) number in the range from 0 to 255.</p> <p>Make sure to specify this attribute if you add the pair to a newly created copy group.</p>
consistencyGroupId	int	<p>(Optional) Specify the consistency group ID by using a decimal (base 10) number in the range from 0 to 255.</p> <p>If you omit this value when adding the pair to a newly created copy group, the value of the consistency group ID is automatically assigned.</p> <p>If you add the pair to an existing copy group, specify the same value as that of the existing copy pair. If a copy group includes a pair whose consistency group ID differs, pair operations by consistency group cannot be correctly performed.</p>
fenceLevel	string	<p>(Optional) Fence level</p> <p><code>ASync</code> is automatically set.</p>

Attribute	Type	Description
doInitialCopy	boolean	(Optional) Specify whether to perform initial copy when creating a pair. <ul style="list-style-type: none"> ▪ <code>true</code>: Performs initial copy. ▪ <code>false</code>: Does not perform initial copy. If this value is omitted, <code>true</code> is assumed.
isDataReductionForceCopy	boolean	(Optional) Specify whether to forcibly create a pair for the volume for which the capacity saving function (dedupe and compression) is enabled. <ul style="list-style-type: none"> ▪ <code>true</code>: Forcibly create a pair # ▪ <code>false</code>: Do not forcibly create a pair When the attribute is omitted, <code>false</code> is assumed.
doDeltaResyncSuspend	boolean	(Optional) For the 3DC multi-target configuration, specify whether to use delta resync between the storage systems of the secondary sites. <ul style="list-style-type: none"> ▪ <code>true</code>: Uses delta resync. ▪ <code>false</code>: Does not use delta resync. If <code>true</code> is specified, a journal volume of the Universal Replicator pair to be used for delta resync will be created in the initial status without initial copy performed. If this value is omitted, <code>false</code> is set.

#: Copying data of the volume for which the capacity saving function (compression or deduplication) is enabled might take up to several months, depending on the amount of data. Be sure to take this into account when planning when to create such a pair.

Response message**Body**

A job object is returned. For details on attributes other than `affectedResources`, see the section explaining job objects.

Attribute	Description
<code>affectedResources</code>	URL of the created TrueCopy pairs or Universal Replicator pairs

Status codes

For details on the status codes of the request for this operation, see the description on HTTP status codes.

Coding example

```
curl -v -H "Accept: application/json" -H "Remote-Authorization:Session
10399a1ffce3489b9c3a823017462396" -H "Content-Type: application/json" -H
"Authorization:Session d7b673af189048468c5af9bcf3bbbb6f" -X POST --data-
binary @./InputParameters.json https://192.0.2.100/ConfigurationManager/v1/
objects/remote-mirror-copypairs
```

Splitting TrueCopy pairs or Universal Replicator pairs in units of copy groups

The following request splits TrueCopy pairs or Universal Replicator pairs by using the specified copy group. If the pairs are split, data copy from the primary volume to the secondary volume will be suspended. Do not simultaneously perform other operations on the copy group or the pairs in that copy group on which a pair split operation is performed.



Tip: We recommend specifying `Job-Mode-Wait-Configuration-Change:NoWait` in the request header of this API function. For details, see the description of the flow of operations for the pairs.

Execution permission

Storage Administrator (Remote Copy)

Request line

```
POST base-URL/v1/objects/remote-mirror-copygroups/object-ID/actions/split/
invoke
```

Request message**Object ID**

Specify the value of `remoteMirrorCopyGroupId` that was obtained by the processing to get information about the remote copy group. You can also specify the attributes and connect them with commas as follows:

```
remoteStorageDeviceId, copyGroupName, localDeviceGroupName,
remoteDeviceGroupName
```

Attribute	Type	Description
<code>remoteStorageDeviceId</code>	string	(Required) Storage device ID of the remote storage system
<code>copyGroupName</code>	string	(Required) Copy group name Specify a name consisting of 1 to 31 characters. The name is case sensitive.
<code>localDeviceGroupName</code>	string	(Required) Device group name in the local storage system Specify a name consisting of 1 to 31 characters. The name is case sensitive.
<code>remoteDeviceGroupName</code>	string	(Required) Device group name in the remote storage system Specify a name consisting of 1 to 31 characters. The name is case sensitive.

Query parameters

None.

Body

The following is a coding example for simply splitting pairs:

```
{
  "parameters": {
    "replicationType": "TC"
  }
}
```

The following is a coding example for splitting pairs by specifying the S-VOL, and forcibly changing the status of the pairs of the S-VOL to SSWS:

```
{
  "parameters": {
    "replicationType": "UR",
    "svolOperationMode": "SSWS"
  }
}
```

The following is a TrueCopy coding example for splitting pairs and prohibiting write operations for the P-VOL:

```
{
  "parameters": {
    "replicationType": "TC",
    "doPvolWriteProtect": true
  }
}
```

The following is a Universal Replicator coding example for splitting pairs and forcibly stopping operations on a journal volume:

```
{
  "parameters": {
    "replicationType": "UR",
    "doDataSuspend": true
  }
}
```

Attribute	Type	Description
replicationType	string	(Required) Specify the pair type. <ul style="list-style-type: none"> ▪ TC: TrueCopy ▪ UR: Universal Replicator
svolAccessMode	string	(Optional) Specify the access mode for the S-VOL after pairs are split. <ul style="list-style-type: none"> ▪ r: Read only ▪ rw: Read and write If the value is not specified, r will be set.

Attribute	Type	Description
		<p>If you specify this attribute, you cannot specify the <code>svolOperationMode</code> attribute. In the case of TC, you cannot specify <code>true</code> for the <code>doPvolWriteProtect</code> attribute. In the case of UR, you cannot specify <code>true</code> for the <code>doDataSuspend</code> attribute.</p>
<code>svolOperationMode</code>	string	<p>(Optional) Specify this attribute to forcibly change the status of the pairs of the S-VOL in cases such as if a failure occurs in the storage system of the primary site. Issue a request from the storage system of the secondary site.</p> <ul style="list-style-type: none"> ▪ <code>SSWS</code>: Change to SSWS mode. ▪ <code>PSUS</code>: Change to PSUS (PSUE or PSUS) mode. <p>If you specify this attribute, you cannot specify the <code>svolAccessMode</code> attribute. In the case of TC, you cannot specify <code>true</code> for the <code>doPvolWriteProtect</code> attribute. In the case of UR, you cannot specify <code>true</code> for the <code>doDataSuspend</code> attribute.</p>
<code>doPvolWriteProtect</code>	boolean	<p>(Optional) In the case of TC, specify whether to forcibly disable write operations for the P-VOL. Issue a request from the storage system of the secondary site.</p> <ul style="list-style-type: none"> ▪ <code>true</code>: Disable write operations for P-VOL. ▪ <code>false</code>: Do not disable write operations for P-VOL. <p>If the value is not specified, <code>false</code> will be set.</p> <p>If you specify <code>true</code> for this attribute, you cannot specify the <code>svolAccessMode</code> and <code>svolOperationMode</code> attributes.</p>
<code>doDataSuspend</code>	boolean	<p>(Optional) In the case of UR, specify whether to forcibly stop operations on a journal when the amount of access to the journal increases. Issue a request from the storage system of the primary site.</p> <ul style="list-style-type: none"> ▪ <code>true</code>: Forcibly stop operations on the journal. <p>Data is not copied to the group on the S-VOL. The data of the master journal volume and the restore journal volume is deleted.</p> <ul style="list-style-type: none"> ▪ <code>false</code>: Do not forcibly stop operations on the journal. <p>If the value is not specified, <code>false</code> will be set.</p>

Attribute	Type	Description
		If you specify <code>true</code> for this attribute, you cannot specify the <code>svolOperationMode</code> attribute. However, you can specify only <code>rw</code> for the <code>svolAccessMode</code> attribute.

Response message

Body

A job object is returned. For details on attributes other than `affectedResources`, see the section explaining job objects.

Attribute	Description
<code>affectedResources</code>	URL of the copy group of the split TrueCopy pairs or Universal Replicator pairs

Action template

```
GET base-URL/v1/objects/remote-mirror-copygroups/object-ID/actions/split
```

This action template returns only the specifiable attributes, depending on the following: the type of the pairs of the copy group specified for the object ID, and whether the volume in the copy group of the local storage system is the primary volume or the secondary volume.

Status codes

The following table describes the meaning of the status code of the request for this operation. For details on other status codes, see the section explaining HTTP status codes.

Status code	Message	Description
412	Precondition Failed	This status code indicates that operations on the pairs of the specified copy group cannot be performed.

Coding example

To get an action template:

When the storage system of the P-VOL is specified:

```
curl -v -H "Accept: application/json" -H "Remote-Authorization:Session
10399a1ffce3489b9c3a823017462396" -H "Authorization:Session
d7b673af189048468c5af9bcf3b6bb6f" -X GET https://192.0.2.100/
ConfigurationManager/v1/objects/remote-mirror-copygroups/886000123789,
remoteCopyGroup,remoteCopyGroupP_,remoteCopyGroupS_/actions/split
```

When the storage system of the S-VOL is specified:

```
curl -v -H "Accept: application/json" -H "Remote-Authorization:Session
10399a1ffce3489b9c3a823017462396" -H "Authorization:Session
d7b673af189048468c5af9bcf3b6bb6f" -X GET https://192.0.2.100/
ConfigurationManager/v1/objects/remote-mirror-copygroups/886000123456,
remoteCopyGroup,remoteCopyGroupS_,remoteCopyGroupP_/actions/split
```

To run the request after getting an action template:

When the storage system of the P-VOL is specified:

```
curl -v -H "Accept: application/json" -H "Remote-Authorization:Session
10399a1ffce3489b9c3a823017462396" -H "Content-Type: application/json" -H
"Authorization:Session d7b673af189048468c5af9bcf3b6bb6f" -X POST --data-
binary @./InputParameters.json https://192.0.2.100/ConfigurationManager/v1/
objects/remote-mirror-copygroups/886000123789,remoteCopyGroup,
remoteCopyGroupP_,remoteCopyGroupS_/actions/split/invoke
```

When the storage system of the S-VOL is specified:

```
curl -v -H "Accept: application/json" -H "Remote-Authorization:Session
10399a1ffce3489b9c3a823017462396" -H "Content-Type: application/json" -H
"Authorization:Session d7b673af189048468c5af9bcf3b6bb6f" -X POST --data-
binary @./InputParameters.json https://192.0.2.100/ConfigurationManager/v1/
objects/remote-mirror-copygroups/886000123456,remoteCopyGroup,
remoteCopyGroupS_,remoteCopyGroupP_/actions/split/invoke
```

Splitting a TrueCopy pair or Universal Replicator pair

The following request splits the specified TrueCopy pair or Universal Replicator pair. If the pairs are split, data copy from the primary volume to the secondary volume will be suspended. Do not simultaneously perform other operations on the copy group or the pairs in that copy group on which a pair split operation is performed.



Tip: We recommend specifying `Job-Mode-Wait-Configuration-Change:NoWait` in the request header of this API function. For details, see the description of the flow of operations for the pairs.

Execution permission

Storage Administrator (Remote Copy)

Request line

```
POST base-URL/v1/objects/remote-mirror-copypairs/object-ID/actions/split/
invoke
```

Request message**Object ID**

Specify the value of `remoteMirrorCopyPairId` that was obtained by the processing to get information about the remote copy pair. You can also specify the attributes and connect them with commas as follows:

```
remoteStorageDeviceId, copyGroupName, localDeviceGroupName,
remoteDeviceGroupName, copyPairName
```

Attribute	Type	Description
<code>remoteStorageDeviceId</code>	string	(Required) Storage device ID of the remote storage system
<code>copyGroupName</code>	string	(Required) Copy group name Specify a name consisting of 1 to 31 characters. The name is case sensitive.
<code>localDeviceGroupName</code>	string	(Required) Device group name in the local storage system Specify a name consisting of 1 to 31 characters. The name is case sensitive.
<code>remoteDeviceGroupName</code>	string	(Required) Device group name of the remote storage system Specify a name consisting of 1 to 31 characters. The name is case sensitive.
<code>copyPairName</code>	string	(Required) Copy pair name Specify a name consisting of 1 to 31 characters. The name is case sensitive.

Query parameters

None.

Body

The following is a coding example for simply splitting pairs:

```
{
  "parameters": {
    "replicationType": "UR"
  }
}
```

The following is a coding example for splitting a pair and permitting write operations for the S-VOL:

```
{
  "parameters": {
    "replicationType": "TC",
    "svolAccessMode": "rw"
  }
}
```

The following is a coding example for splitting a pair by specifying the S-VOL, and forcibly changing the status of the pair of the S-VOL:

```
{
  "parameters": {
    "replicationType": "TC",
    "svolOperationMode": "PSUS"
  }
}
```

Attribute	Type	Description
replicationType	string	(Required) Specify the pair type. <ul style="list-style-type: none"> ▪ TC: TrueCopy ▪ UR: Universal Replicator
svolAccessMode	string	(Optional) Specify the access mode for the S-VOL after pairs are split. <ul style="list-style-type: none"> ▪ r: Read only ▪ rw: Read and write If the value is not specified, r will be set.

Attribute	Type	Description
		If you specify this attribute, you cannot specify the <code>svolOperationMode</code> attribute. In the case of TC, you cannot specify <code>true</code> for the <code>doPvolWriteProtect</code> attribute. In the case of UR, you cannot specify <code>true</code> for the <code>doDataSuspend</code> attribute.
svolOperationMode	string	<p>(Optional) Specify this attribute to forcibly change the status of the pairs of the S-VOL in cases such as if a failure occurs in the storage system of the primary site. Issue a request from the storage system of the secondary site.</p> <ul style="list-style-type: none"> ▪ <code>SSWS</code>: Change to SSWS mode. ▪ <code>PSUS</code>: Change to PSUS (PSUE or PSUS) mode. <p>If you specify this attribute, you cannot specify the <code>svolAccessMode</code> attribute. In the case of TC, you cannot specify <code>true</code> for the <code>doPvolWriteProtect</code> attribute. In the case of UR, you cannot specify <code>true</code> for the <code>doDataSuspend</code> attribute.</p>
doPvolWriteProtect	boolean	<p>(Optional) In the case of TC, specify whether to forcibly disable write operations for the P-VOL. Issue a request from the storage system of the secondary site.</p> <ul style="list-style-type: none"> ▪ <code>true</code>: Disable write operations for P-VOL. ▪ <code>false</code>: Do not disable write operations for P-VOL. <p>If the value is not specified, <code>false</code> will be set.</p> <p>If you specify <code>true</code> for this attribute, you cannot specify the <code>svolAccessMode</code> and <code>svolOperationMode</code> attributes.</p>
doDataSuspend	boolean	<p>(Optional) In the case of UR, specify whether to forcibly stop operations on a journal when the amount of access to the journal increases. Issue a request from the storage system of the primary site.</p> <ul style="list-style-type: none"> ▪ <code>true</code>: Forcibly stop operations on the journal. <p>Data is not copied to the S-VOL. The data of the master journal volume and the restore journal volume is deleted.</p> <ul style="list-style-type: none"> ▪ <code>false</code>: Do not forcibly stop operations on the journal. <p>If the value is not specified, <code>false</code> will be set.</p>

Attribute	Type	Description
		If you specify <code>true</code> for this attribute, you cannot specify the <code>svolOperationMode</code> attribute. However, you can specify only <code>rw</code> for the <code>svolAccessMode</code> attribute.

Response message

Body

A job object is returned. For details on attributes other than `affectedResources`, see the section explaining job objects.

Attribute	Description
<code>affectedResources</code>	URL of the split TrueCopy pairs or Universal Replicator pairs

Action template

```
GET base-URL/v1/objects/remote-mirror-coppairs/object-ID/actions/split
```

This action template returns only the specifiable attributes, depending on the following: the type of the pair specified for the object ID, and whether the volume in the local storage system is the primary volume or the secondary volume.

Status codes

The following table describes the meaning of the status code of the request for this operation. For details on other status codes, see the section explaining HTTP status codes.

Status code	Message	Description
412	Precondition Failed	This status code indicates that operations on the specified pair cannot be performed.

Coding example

To get an action template:

When the storage system of the P-VOL is specified:

```
curl -v -H "Accept: application/json" -H "Remote-Authorization:Session
10399a1ffce3489b9c3a823017462396" -H "Authorization:Session
d7b673af189048468c5af9bcf3bbbb6f" -X GET https://192.0.2.100/
```

```
ConfigurationManager/v1/objects/remote-mirror-copypairs/886000123789,  
remoteCopyGroup,remoteCopyGroupP_,remoteCopyGroupS_,pair1/actions/split
```

When the storage system of the S-VOL is specified:

```
curl -v -H "Accept: application/json" -H "Remote-Authorization:Session  
10399a1ffce3489b9c3a823017462396" -H "Authorization:Session  
d7b673af189048468c5af9bcf3bbbbb6f" -X GET https://192.0.2.100/  
ConfigurationManager/v1/objects/remote-mirror-copypairs/886000123456,  
remoteCopyGroup,remoteCopyGroupS_,remoteCopyGroupP_,pair1/actions/split
```

To run the request after getting an action template:

When the storage system of the P-VOL is specified:

```
curl -v -H "Accept: application/json" -H "Remote-Authorization:Session  
10399a1ffce3489b9c3a823017462396" -H "Content-Type: application/json" -H  
"Authorization:Session d7b673af189048468c5af9bcf3bbbbb6f" -X POST --data-  
binary @./InputParameters.json https://192.0.2.100/ConfigurationManager/v1/  
objects/remote-mirror-copypairs/886000123789,remoteCopyGroup,  
remoteCopyGroupP_,remoteCopyGroupS_,pair1/actions/split/invoke
```

When the storage system of the S-VOL is specified:

```
curl -v -H "Accept: application/json" -H "Remote-Authorization:Session  
10399a1ffce3489b9c3a823017462396" -H "Content-Type: application/json" -H  
"Authorization:Session d7b673af189048468c5af9bcf3bbbbb6f" -X POST --data-  
binary @./InputParameters.json https://192.0.2.100/ConfigurationManager/v1/  
objects/remote-mirror-copypairs/886000123456,remoteCopyGroup,  
remoteCopyGroupS_,remoteCopyGroupP_,pair1/actions/split/invoke
```

Resynchronizing TrueCopy pairs or Universal Replicator pairs in units of copy groups

The following request resynchronizes TrueCopy pairs or Universal Replicator pairs by using the specified copy group. If the pairs are resynchronized, the differential data that was accumulated after the pairs were split is copied, by copy group, from the primary volume to the secondary volume, so that the data is consistent between the two volumes. Do not simultaneously perform other operations on the copy group or the pairs in that copy group on which a pair resynchronization operation is performed.



Tip: We recommend specifying `Job-Mode-Wait-Configuration-Change:NoWait` in the request header of this API function. For details, see the description of the flow of operations for the pairs.

**Note:**

To register TrueCopy pairs in a consistency group when performing a pair resynchronization operation, the number of pairs in the target copy group must be 1,000 or less. If the number of pairs exceeds 1,000, delete all pairs in the copy group, and then register pairs in a consistency group when you re-create the pairs. Alternatively, delete some pairs so that the number of pairs decreases to 1,000 or less, perform a pair resynchronization operation, and then register the pairs in a consistency group when you re-create the pairs that you deleted.

Execution permission

Storage Administrator (Remote Copy)

Request line

```
POST base-URL/v1/objects/remote-mirror-copygroups/object-ID/actions/resync/
invoke
```

Request message**Object ID**

Specify the value of `remoteMirrorCopyGroupId` that was obtained by the processing to get information about the remote copy group. You can also specify the attributes and connect them with commas as follows:

```
remoteStorageDeviceId, copyGroupName, localDeviceGroupName,
remoteDeviceGroupName
```

Attribute	Type	Description
<code>remoteStorageDeviceId</code>	string	(Required) Storage device ID of the remote storage system
<code>copyGroupName</code>	string	(Required) Copy group name Specify a name consisting of 1 to 31 characters. The name is case sensitive.
<code>localDeviceGroupName</code>	string	(Required) Device group name in the local storage system Specify a name consisting of 1 to 31 characters. The name is case sensitive.
<code>remoteDeviceGroupName</code>	string	(Required) Device group name in the remote storage system

Attribute	Type	Description
		Specify a name consisting of 1 to 31 characters. The name is case sensitive.

Query parameters

None.

Body

The following is a coding example for simply resynchronizing pairs:

```
{
  "parameters": {
    "replicationType": "TC"
  }
}
```

The following is a coding example for resynchronizing pairs by specifying the MU (mirror unit) number of the copy group to be failed back:

```
{
  "parameters": {
    "replicationType": "UR",
    "doFailback": true,
    "failbackMuNumber": 1
  }
}
```

The following is a coding example for reversing and resynchronizing pairs by specifying the P-VOL:

```
{
  "parameters": {
    "replicationType": "UR",
    "doSwapPvol": true
  }
}
```

The following is a TrueCopy coding example for newly registering the specified copy group in a consistency group and resynchronizing pairs:

```
{
  "parameters": {
    "replicationType": "TC",
    "fenceLevel": "STATUS",
  }
}
```

```

    "isConsistencyGroup": true,
    "consistencyGroupId": 123
  }
}

```

Attribute	Type	Description
replicationType	string	(Required) Specify the pair type. <ul style="list-style-type: none"> TC: TrueCopy UR: Universal Replicator
doFailback	boolean	(Optional) Specify whether to perform a failback if a failure occurs in a 3DC cascade configuration. <ul style="list-style-type: none"> true: A failback is performed. false: A failback is not performed. If the value is omitted, false is assumed. If you specify true for this attribute, you cannot specify true for the doSwapSvol and doSwapPvol attributes. In the case of TC, you cannot specify the fenceLevel attribute.
failbackMuNumber	int	(Optional) Specify the MU (mirror unit) number of the volume to be failed back. You can specify this attribute only if the doFailback attribute is set to true.
doSwapSvol	boolean	(Optional) Specify the resynchronization method if the pairs on the specified S-VOL are split. Issue a request from the storage system of the secondary site. <ul style="list-style-type: none"> true: Resynchronize pairs by specifying the S-VOL (swap resync). Reverse the P-VOL and the S-VOL. Copy the data of the new P-VOL to the S-VOL to resynchronize the pairs. false: Resynchronize pairs by specifying the P-VOL. Copy the data of the P-VOL to the S-VOL to resynchronize the pairs. If the value is not specified, false will be set.

Attribute	Type	Description
		If you specify <code>true</code> for this attribute, you cannot specify <code>true</code> for the <code>doSwapPvol</code> and <code>doFailback</code> attributes. In the case of TC, you also cannot specify the <code>fenceLevel</code> attribute.
<code>doSwapPvol</code>	boolean	<p>(Optional) Specify the resynchronization method if the pairs in the specified P-VOL are split. Issue a request from the storage system of the primary site.</p> <ul style="list-style-type: none"> ▪ <code>true</code>: Resynchronize pairs by specifying the P-VOL (swap resync). Reverse the P-VOL and the S-VOL. Copy the data of the new P-VOL to the S-VOL to resynchronize the pairs. ▪ <code>false</code>: Resynchronize pairs by specifying the P-VOL. Copy the data of the P-VOL to the S-VOL to resynchronize the pairs. <p>If the value is not specified, <code>false</code> will be set.</p> <p>If you specify <code>true</code> for this attribute, you cannot specify <code>true</code> for the <code>doSwapSvol</code> and <code>doFailback</code> attributes. In the case of TC, you also cannot specify the <code>fenceLevel</code> attribute.</p>
<code>isConsistencyGroup</code>	boolean	<p>(Optional) In the case of TC, specify the value as follows according to whether the copy group is registered in a consistency group:</p> <ul style="list-style-type: none"> ▪ If the copy group is not registered in a consistency group <ul style="list-style-type: none"> • <code>true</code>: Registers the copy group in a consistency group. # • <code>false</code>: Leaves the copy group as it is without registering it in a consistency group. ▪ If the copy group is registered in a consistency group <ul style="list-style-type: none"> • <code>true</code>: Leaves the copy group registered in a consistency group. • <code>false</code>: Cancels the registration of the copy group in a consistency group, and places it in an unregistered state.

Attribute	Type	Description
		<p>If the value is not specified, <code>false</code> will be set. To leave the copy group registered in a consistency group, be sure to specify <code>true</code> for this attribute. If this attribute is omitted, the registration of the copy group in a consistency group is canceled.</p> <p>Make sure that each copy group contains either only pairs that are registered to a consistency group or only pairs that are not registered to a consistency group. If a copy group includes both pairs that are registered in a consistency group and pairs that are not registered in a consistency group, pair operations by consistency group cannot be correctly performed.</p> <p>If you specify <code>true</code> for this attribute, make sure to also specify the <code>fenceLevel</code> attribute.</p>
consistencyGroupID	int	<p>(Optional) In the case of TC, specify the consistency group ID by using a decimal (base 10) number in the range from 0 to 255.</p> <p>Use this attribute when registering the specified copy group in a consistency group.</p> <p>You cannot specify this attribute if the specified copy group is already registered in a consistency group.</p> <p>When specifying this attribute, make sure to specify <code>true</code> for the <code>isConsistencyGroup</code> attribute.</p>
fenceLevel	string	<p>(Required) In the case of TC, specify the fence level.</p> <ul style="list-style-type: none"> ▪ DATA: S-VOL data ▪ STATUS: S-VOL status ▪ NEVER: None <p>If you specify <code>true</code> for the <code>isConsistencyGroup</code> attribute, make sure to specify this attribute. When you specify this attribute, if there is no change in the fence level, specify the value of the existing fence level.</p> <p>To change the fence level, specify the new value.</p>

Attribute	Type	Description
		If you specify this attribute, you cannot specify <code>true</code> for the <code>doFailback</code> , <code>doSwapSvol</code> , and <code>doSwapPvol</code> attributes.
<code>copyPace</code>	<code>int</code>	(Optional) In the case of TC, specify a decimal (base 10) number in the range from 1 to 15 for the size of tracks to be copied. The larger the value you specify, the faster the copy speed.

#: This value can be specified only if the number of pairs in the copy group is 1,000 or less.

Response message

Body

A job object is returned. For details on attributes other than `affectedResources`, see the section explaining job objects.

Attribute	Description
<code>affectedResources</code>	URL of the copy group of the resynchronized TrueCopy pairs or Universal Replicator pairs

Action template

```
GET base-URL/v1/objects/remote-mirror-copygroups/object-ID/actions/resync
```

This action template returns only the specifiable attributes depending on the following: the type of the pairs of the copy group specified for the object ID, and whether the volume in the copy group of the local storage system is the primary volume or the secondary volume.

Status codes

The following table describes the meaning of the status code of the request for this operation. For details on other status codes, see the section explaining HTTP status codes.

Status code	Message	Description
412	Precondition Failed	This status code indicates that operations on the pairs of the specified copy group cannot be performed.

Coding example

To get an action template:

When the storage system of the P-VOL is specified:

```
curl -v -H "Accept: application/json" -H "Remote-Authorization:Session
10399a1ffce3489b9c3a823017462396" -H "Authorization:Session
d7b673af189048468c5af9bcf3bbbb6f" -X GET https://192.0.2.100/
ConfigurationManager/v1/objects/remote-mirror-copygroups/886000123789,
remoteCopyGroup,remoteCopyGroupP_,remoteCopyGroupS_/actions/resync
```

When the storage system of the S-VOL is specified:

```
curl -v -H "Accept: application/json" -H "Remote-Authorization:Session
10399a1ffce3489b9c3a823017462396" -H "Authorization:Session
d7b673af189048468c5af9bcf3bbbb6f" -X GET https://192.0.2.100/
ConfigurationManager/v1/objects/remote-mirror-copygroups/886000123456,
remoteCopyGroup,remoteCopyGroupS_,remoteCopyGroupP_/actions/resync
```

To run the request after getting an action template:

When the storage system of the P-VOL is specified:

```
curl -v -H "Accept: application/json" -H "Remote-Authorization:Session
10399a1ffce3489b9c3a823017462396" -H "Content-Type: application/json" -H
"Authorization:Session d7b673af189048468c5af9bcf3bbbb6f" -X POST --data-
binary @./InputParameters.json https://192.0.2.100/ConfigurationManager/v1/
objects/remote-mirror-copygroups/886000123789,remoteCopyGroup,
remoteCopyGroupP_,remoteCopyGroupS_/actions/resync/invoke
```

When the storage system of the S-VOL is specified:

```
curl -v -H "Accept: application/json" -H "Remote-Authorization:Session
10399a1ffce3489b9c3a823017462396" -H "Content-Type: application/json" -H
"Authorization:Session d7b673af189048468c5af9bcf3bbbb6f" -X POST --data-
binary @./InputParameters.json https://192.0.2.100/ConfigurationManager/v1/
objects/remote-mirror-copygroups/886000123456,remoteCopyGroup,
remoteCopyGroupS_,remoteCopyGroupP_/actions/resync/invoke
```

Resynchronizing a TrueCopy pair or Universal Replicator pair

The following request resynchronizes the specified TrueCopy pair or Universal Replicator pair. If the pair is resynchronized, the differential data that was accumulated after the pair was split is copied from the primary volume to the secondary volume, so that the data is consistent between the two volumes. Do not simultaneously perform other operations on the copy group or the pairs in that copy group on which a pair resynchronization operation is performed.



Tip: We recommend specifying `Job-Mode-Wait-Configuration-Change:NoWait` in the request header of this API function. For details, see the description of the flow of operations for pairs.

**Note:**

To register TrueCopy pairs in a consistency group when performing a pair resynchronization operation, the number of pairs in the target copy group must be 1,000 or less. If the number of pairs exceeds 1,000, delete all pairs in the copy group, and then register pairs in a consistency group when you re-create the pairs. Alternatively, delete some pairs so that the number of pairs decreases to 1,000 or less, perform a pair resynchronization operation, and then register the pairs in a consistency group when you re-create the pairs that you deleted.

Execution permission

Storage Administrator (Remote Copy)

Request line

```
POST base-URL/v1/objects/remote-mirror-copypairs/object-ID/actions/resync/
invoke
```

Request message**Object ID**

Specify the value of `remoteMirrorCopyPairId` that was obtained by the processing to get information about the remote copy pair. You can also specify the attributes and connect them with commas as follows:

```
remoteStorageDeviceId, copyGroupName, localDeviceGroupName,
remoteDeviceGroupName, copyPairName
```

Attribute	Type	Description
<code>remoteStorageDeviceId</code>	string	(Required) Storage device ID of the remote storage system
<code>copyGroupName</code>	string	(Required) Copy group name Specify a name consisting of 1 to 31 characters. The name is case sensitive.
<code>localDeviceGroupName</code>	string	(Required) Device group name in the local storage system

Attribute	Type	Description
		Specify a name consisting of 1 to 31 characters. The name is case sensitive.
remoteDeviceGroupName	string	(Required) Device group name in the remote storage system Specify a name consisting of 1 to 31 characters. The name is case sensitive.
copyPairName	string	(Required) Copy pair name Specify a name consisting of 1 to 31 characters. The name is case sensitive.

Query parameters

None.

Body

The following is a coding example for simply resynchronizing pairs:

```
{
  "parameters": {
    "replicationType": "UR"
  }
}
```

The following is a coding example for resynchronizing a pair to be failed back by specifying the MU (mirror unit) number of the pair:

```
{
  "parameters": {
    "replicationType": "TC",
    "doFailback": true,
    "failbackMuNumber": 1
  }
}
```

The following is a coding example for reversing and resynchronizing a pair by specifying the S-VOL:

```
{
  "parameters": {
    "replicationType": "TC",
    "doSwapSvol": true
  }
}
```

```
}
}
```

Attribute	Type	Description
replicationType	string	(Required) Specify the pair type. <ul style="list-style-type: none"> TC: TrueCopy UR: Universal Replicator
doFailback	boolean	(Optional) Specify whether to perform a failback if a failure occurs in a 3DC cascade configuration. <ul style="list-style-type: none"> true: A failback is performed. false: A failback is not performed. <p>If the value is omitted, false is assumed.</p> <p>If you specify true for this attribute, you cannot specify true for the doSwapSvol and doSwapPvol attributes. In the case of TC, you cannot specify the fenceLevel attribute.</p>
failbackMuNumber	int	(Optional) Specify the MU (mirror unit) number of the volume to be failed back. <p>You can specify this attribute only if the doFailback attribute is set to true.</p>
doSwapSvol	boolean	(Optional) Specify the resynchronization method if the pairs on the specified S-VOL are split. Issue a request from the storage system of the secondary site. <ul style="list-style-type: none"> true: Resynchronize pairs by specifying the S-VOL (swap resync). <p>Reverse the P-VOL and the S-VOL. Copy the data of the new P-VOL to the S-VOL to resynchronize the pairs.</p> false: Resynchronize pairs by specifying the P-VOL. <p>Copy the data of the P-VOL to the S-VOL to resynchronize the pairs.</p> <p>If the value is not specified, false will be set.</p>

Attribute	Type	Description
		If you specify <code>true</code> for this attribute, you cannot specify <code>true</code> for the <code>doSwapPvol</code> and <code>doFailback</code> attributes. In the case of TC, you also cannot specify the <code>fenceLevel</code> attribute.
doSwapPvol	boolean	<p>(Optional) Specify the resynchronization method if the pairs in the specified P-VOL are split. Issue a request from the storage system of the primary site.</p> <ul style="list-style-type: none"> ▪ <code>true</code>: Resynchronize pairs by specifying the P-VOL (swap resync). Reverse the P-VOL and the S-VOL. Copy the data of the new P-VOL to the S-VOL to resynchronize the pairs. ▪ <code>false</code>: Resynchronize pairs by specifying the P-VOL. Copy the data of the P-VOL to the S-VOL to resynchronize the pairs. <p>If the value is not specified, <code>false</code> will be set.</p> <p>If you specify <code>true</code> for this attribute, you cannot specify <code>true</code> for the <code>doSwapSvol</code> and <code>doFailback</code> attributes. In the case of TC, you also cannot specify the <code>fenceLevel</code> attribute.</p>
isConsistencyGroup	boolean	<p>(Optional) In the case of TC, specify the value as follows according to whether the pair is registered in a consistency group:</p> <ul style="list-style-type: none"> ▪ If the pair is not registered in a consistency group <ul style="list-style-type: none"> • <code>true</code>: Registers the pair in a consistency group. # • <code>false</code>: Leaves the pair as it is without registering it in a consistency group. ▪ If the pair is registered in a consistency group <ul style="list-style-type: none"> • <code>true</code>: Leaves the pair registered in a consistency group. • <code>false</code>: Cancels the registration of the pair in a consistency group, and places it in an unregistered state.

Attribute	Type	Description
		<p>If the value is not specified, <code>false</code> will be set. To leave the pair registered in a consistency group, be sure to specify <code>true</code> for this attribute. If this attribute is omitted, the registration of the pair in a consistency group is canceled.</p> <p>Make sure that each copy group contains either only pairs that are registered to a consistency group or only pairs that are not registered to a consistency group. If a copy group includes both pairs that are registered in a consistency group and pairs that are not registered in a consistency group, pair operations by consistency group cannot be correctly performed.</p> <p>If you specify <code>true</code> for this attribute, make sure to also specify the <code>fenceLevel</code> attribute.</p>
consistencyGroupID	int	<p>(Optional) In the case of TC, specify the consistency group ID by using a decimal (base 10) number in the range from 0 to 255.</p> <p>Use this attribute when registering the specified copy group in a consistency group.</p> <p>You cannot specify this attribute if the specified pair is already registered in a consistency group.</p> <p>Unify the consistency group ID within the copy group. If a copy group includes a pair whose consistency group ID differs, pair operations by consistency group cannot be correctly performed.</p> <p>When specifying this attribute, make sure to specify <code>true</code> for the <code>isConsistencyGroup</code> attribute.</p>
fenceLevel	string	<p>(Required) In the case of TC, specify the fence level.</p> <ul style="list-style-type: none"> ▪ DATA: S-VOL data ▪ STATUS: S-VOL status ▪ NEVER: None <p>If you specify <code>true</code> for the <code>isConsistencyGroup</code> attribute, make sure to specify this attribute. When you specify this attribute, if there is no change in the fence level, specify the value of the existing fence level.</p>

Attribute	Type	Description
		To change the fence level, specify the new value. If you specify this attribute, you cannot specify <code>true</code> for the <code>doFailback</code> , <code>doSwapSvol</code> , and <code>doSwapPvol</code> attributes.
<code>copyPace</code>	<code>int</code>	(Optional) In the case of TC, specify a decimal (base 10) number in the range from 1 to 15 for the size of tracks to be copied. The larger the value you specify, the faster the copy speed.

#: This value can be specified only if the number of pairs in the copy group is 1,000 or less.

Response message

Body

A job object is returned. For details on attributes other than `affectedResources`, see the section explaining job objects.

Attribute	Description
<code>affectedResources</code>	URL of the resynchronized TrueCopy pairs or Universal Replicator pairs

Action template

```
GET base-URL/v1/objects/remote-mirror-coppairs/object-ID/actions/resync
```

This action template returns only the specifiable attributes depending on the following: the type of the pair specified for the object ID, and whether the volume in the local storage system is the primary volume or the secondary volume.

Status codes

The following table describes the meaning of the status code of the request for this operation. For details on other status codes, see the section explaining HTTP status codes.

Status code	Message	Description
412	Precondition Failed	This status code indicates that operations on the specified pair cannot be performed.

Coding example

To get an action template:

When the storage system of the P-VOL is specified:

```
curl -v -H "Accept: application/json" -H "Remote-Authorization:Session
10399a1ffce3489b9c3a823017462396" -H "Authorization:Session
d7b673af189048468c5af9bcf3bbbb6f" -X GET https://192.0.2.100/
ConfigurationManager/v1/objects/remote-mirror-copypairs/886000123789,
remoteCopyGroup,remoteCopyGroupP_,remoteCopyGroupS_,pair1/actions/resync
```

When the storage system of the S-VOL is specified:

```
curl -v -H "Accept: application/json" -H "Remote-Authorization:Session
10399a1ffce3489b9c3a823017462396" -H "Authorization:Session
d7b673af189048468c5af9bcf3bbbb6f" -X GET https://192.0.2.100/
ConfigurationManager/v1/objects/remote-mirror-copypairs/886000123456,
remoteCopyGroup,remoteCopyGroupS_,remoteCopyGroupP_,pair1/actions/resync
```

To run the request after getting an action template:

When the storage system of the P-VOL is specified:

```
curl -v -H "Accept: application/json" -H "Remote-Authorization:Session
10399a1ffce3489b9c3a823017462396" -H "Content-Type: application/json" -H
"Authorization:Session d7b673af189048468c5af9bcf3bbbb6f" -X POST --data-
binary @./InputParameters.json https://192.0.2.100/ConfigurationManager/v1/
objects/remote-mirror-copypairs/886000123789,remoteCopyGroup,
remoteCopyGroupP_,remoteCopyGroupS_,pair1/actions/resync/invoke
```

When the storage system of the S-VOL is specified:

```
curl -v -H "Accept: application/json" -H "Remote-Authorization:Session
10399a1ffce3489b9c3a823017462396" -H "Content-Type: application/json" -H
"Authorization:Session d7b673af189048468c5af9bcf3bbbb6f" -X POST --data-
binary @./InputParameters.json https://192.0.2.100/ConfigurationManager/v1/
objects/remote-mirror-copypairs/886000123456,remoteCopyGroup,
remoteCopyGroupS_,remoteCopyGroupP_,pair1/actions/resync/invoke
```

Deleting TrueCopy pairs or Universal Replicator pairs in units of copy groups

The following request deletes TrueCopy pairs or Universal Replicator pairs by using the specified copy group. When the pairs are all deleted, the device groups are also deleted. Before deleting a pair, lock the resources or make sure the resources have not been locked by another user.

Execution permission

Storage Administrator (Provisioning) and Storage Administrator (Remote Copy)

Request lineDELETE *base-URL/v1/objects/remote-mirror-copygroups/object-ID***Request message****Object ID**

Specify the value of `remoteMirrorCopyGroupId` that was obtained by the processing to get information about the remote copy group. You can also specify the attributes and connect them with commas as follows:

remoteStorageDeviceId, copyGroupName, localDeviceGroupName, remoteDeviceGroupName

Attribute	Type	Description
remoteStorageDeviceId	string	(Required) Storage device ID of the remote storage system
copyGroupName	string	(Required) Copy group name Specify a name consisting of 1 to 31 characters. The name is case sensitive.
localDeviceGroupName	string	(Required) Device group name in the local storage system Specify a name consisting of 1 to 31 characters. The name is case sensitive.
remoteDeviceGroupName	string	(Required) Device group name in the remote storage system Specify a name consisting of 1 to 31 characters. The name is case sensitive.

Query parameters

None.

Body

None.

Response message**Body**

A job object is returned. For details on attributes other than affectedResources, see the section explaining job objects.

Attribute	Description
affectedResources	URL of the copy group of the deleted TrueCopy pairs or Universal Replicator pairs

Status codes

For details on the status codes of the request for this operation, see the description on HTTP status codes.

Coding example

```
curl -v -H "Accept: application/json" -H "Remote-Authorization:Session
10399a1ffce3489b9c3a823017462396" -H "Content-Type: application/json" -H
"Authorization:Session d7b673af189048468c5af9bcf3bbbb6f" -X DELETE --data-
binary @./InputParameters.json https://192.0.2.100/ConfigurationManager/v1/
objects/remote-mirror-copygroups/886000123789,remoteCopyGroup,
remoteCopyGroupP_,remoteCopyGroupS_
```

Deleting a TrueCopy pair or Universal Replicator pair

The following request deletes the specified TrueCopy pair or Universal Replicator pair. As a result of deleting a pair, if there is no pair in the copy group, the copy group and the device group are also deleted. Before deleting a pair, lock the resources or make sure that the resources have not been locked by another user.

Execution permission

Storage Administrator (Provisioning) and Storage Administrator (Remote Copy)

Request line

```
DELETE base-URL/v1/objects/remote-mirror-copypairs/object-ID
```

Request message**Object ID**

Specify the value of `remoteMirrorCopyPairId` that was obtained by the processing to get information about the remote copy pair. You can also specify the attributes and connect them with commas as follows:

```
remoteStorageDeviceId, copyGroupName, localDeviceGroupName,  
remoteDeviceGroupName, copyPairName
```

Attribute	Type	Description
<code>remoteStorageDeviceId</code>	string	(Required) Storage device ID of the remote storage system
<code>copyGroupName</code>	string	(Required) Copy group name Specify a name consisting of 1 to 31 characters. The name is case sensitive.
<code>localDeviceGroupName</code>	string	(Required) Device group name in the local storage system Specify a name consisting of 1 to 31 characters. The name is case sensitive.
<code>remoteDeviceGroupName</code>	string	(Required) Device group name in the remote storage system Specify a name consisting of 1 to 31 characters. The name is case sensitive.
<code>copyPairName</code>	string	(Required) Copy pair name Specify a name consisting of 1 to 31 characters. The name is case sensitive.

Query parameters

None.

Body

None.

Response message**Body**

A job object is returned. For details on attributes other than `affectedResources`, see the section explaining job objects.

Attribute	Description
<code>affectedResources</code>	URL of the deleted TrueCopy pairs or Universal Replicator pairs

Status codes

For details on the status codes of the request for this operation, see the description on HTTP status codes.

Coding example

```
curl -v -H "Accept: application/json" -H "Remote-Authorization:Session
10399a1ffce3489b9c3a823017462396" -H "Content-Type: application/json" -H
"Authorization:Session d7b673af189048468c5af9bcf3b66b6f" -X DELETE --data-
binary @./InputParameters.json https://192.0.2.100/ConfigurationManager/v1/
objects/remote-mirror-copypairs/886000123789,remoteCopyGroup,
remoteCopyGroupP_,remoteCopyGroupS_,pair1
```

Enabling volumes at the secondary site to take over work in units of copy groups

If a failure occurs at the primary site, the following request switches the roles between the primary volumes and the secondary volumes of Universal Replicator pairs (in units of copy groups) to enable data to be written in the secondary volumes so that work can be taken over and continued at the secondary site. This API request runs on the storage system of the secondary site.

**Note:**

- Valid targets are Universal Replicator pairs that are not in a cascade configuration.
- When running this API request, you do not need to specify `Remote-Authorization` for the request header.
- If you specify `Job-Mode-Wait-Configuration-Change:NoWait` for the request header, specify `forceSplit` for `mode` in the request body. When these are specified, the value specified for `timeout` is ignored.

Execution permission

Storage Administrator (Remote Copy)

Request line

```
POST base-URL/v1/objects/remote-mirror-copygroups/object-ID/actions/
takeover/invoke
```

Request message**Object ID**

Specify the `remoteMirrorCopyGroupId` value obtained by getting information about the remote copy group. You can also specify the attributes separated by commas as follows:

```
remoteStorageDeviceId, copyGroupName, localDeviceGroupName,
remoteDeviceGroupName
```

Attribute	Type	Description
<code>remoteStorageDeviceId</code>	string	(Required) Storage device ID of the remote storage system For this API request, specify <code>NotSpecified</code> .
<code>copyGroupName</code>	string	(Required) Copy group name Specify a character string of 1 to 31 characters. The name is case sensitive.
<code>localDeviceGroupName</code>	string	(Required) Device group name at the local storage system Specify a character string of 1 to 31 characters. The name is case sensitive.
<code>remoteDeviceGroupName</code>	string	(Required) Device group name at the remote storage system For this API request, specify <code>NotSpecified</code> .

Query parameters

None.

Body

```
{
  "parameters": {
    "mode": "auto"
  }
}
```

```
}  
}
```

Attribute	Type	Description
mode	string	<p>(Required) Execution mode at takeover</p> <p>After the P-VOL and the S-VOL are switched, the pair is in a split status (SSWS) and writable. For the subsequent transition of the pair status, specify one of the following values:</p> <ul style="list-style-type: none"> ▪ <code>forceSplit</code>: Does not change from the status in which the pair is split (SSWS). ▪ <code>auto</code>: Resynchronize the pair if possible according to the status of the storage system. <p>If you specify <code>Job-Mode-Wait-Configuration-Change:NoWait</code> for the request header, specify <code>forceSplit</code>.</p>
timeout	int	<p>(Optional) Timeout period for waiting for completion of synchronization of differential data (seconds)</p> <p>Specify the timeout time for the processing that synchronizes the differential data with the S-VOL if the journal contains differential data.</p> <p>Specify a value in the range from 1 to 10000.</p> <p>If you do not specify a value, 7200 is assumed.</p> <p>If you specify <code>Job-Mode-Wait-Configuration-Change:NoWait</code> for the request header, the value specified for this attribute is ignored.</p>

Attribute	Type	Description
		If the synchronization of the pairs does not finish within the specified time, the REST API job fails. However, on the storage system, the synchronization processing and the splitting processing after the synchronization is completed continue to be performed. To check whether the synchronization of the pairs has finished, obtain the information about the target pairs.

Response message

Body

A job object is returned. For details on attributes other than affectedResources, see the section explaining job objects.

Attribute	Description
affectedResources	URL of the copy group of the Universal Replicator pairs that were switched

Action template

None.

Status codes

For details on the status codes of the request for this operation, see the description on HTTP status codes.

Coding example

```
curl -v -H "Accept: application/json" -H "Content-type: application/json" -H "Authorization:Session d7b673af189048468c5af9bcf3b6bb6f" -X POST --data-binary @./InputParameters.json https://192.0.2.100/ConfigurationManager/v1/objects/remote-mirror-copygroups/NotSpecified,copyGroup,localDeviceGroup,NotSpecified/actions/takeover/invoke
```

Enabling volumes at the secondary site to take over work in units of copy pairs

If a failure occurs at the primary site, you can continue your work at the secondary site by switching the roles of the primary volume and the secondary volume of the Universal Replicator pair (in units of copy pairs), to enable writing to the secondary volume (takeover). This API is executed on the storage system of the secondary site.



Note:

- Valid targets are Universal Replicator pairs that are not in a cascade configuration.
- When running this API request, you do not need to specify `Remote-Authorization` for the request header.
- If you specify `Job-Mode-Wait-Configuration-Change:NoWait` for the request header, specify `forceSplit` for `mode` in the request body. When these are specified, the value specified for `timeout` is ignored.

Execution permission

Storage Administrator (Remote Copy)

Request line

```
POST base-URL/v1/objects/remote-mirror-coppairs/object-ID/actions/
takeover/invoke
```

Request message

Object ID

Specify the value of `remoteMirrorCopyPairId` that was obtained by the processing to get information about the remote copy pair. You can also specify the attributes and connect them with commas as follows:

```
remoteStorageDeviceId,copyGroupName,localDeviceGroupName,
remoteDeviceGroupName,copyPairName
```

Attribute	Type	Description
<code>remoteStorageDeviceId</code>	string	(Required) Storage device ID of the remote storage system For this API request, specify <code>NotSpecified</code> .
<code>copyGroupName</code>	string	(Required) Copy group name

Attribute	Type	Description
		Specify a character string of 1 to 31 characters. The name is case sensitive.
localDeviceGroupName	string	(Required) Device group name at the local storage system Specify a character string of 1 to 31 characters. The name is case sensitive.
remoteDeviceGroupName	string	(Required) Device group name at the remote storage system For this API request, specify <code>NotSpecified</code> .
copyPairName	string	(Required) Copy pair name Specify a name consisting of 1 to 31 characters. The name is case sensitive.

Query parameters

None.

Body

```
{
  "parameters": {
    "mode": "auto"
  }
}
```

Attribute	Type	Description
mode	string	(Required) Execution mode at takeover After the P-VOL and the S-VOL are switched, the pair is in a split status (SSWS) and writable. For the subsequent transition of the pair status, specify one of the following values: <ul style="list-style-type: none"> <code>forceSplit</code>: Does not change from the status in which the pair is split (SSWS). <code>auto</code>: Resynchronize the pair if possible according to the status of the storage system.

Attribute	Type	Description
		If you specify <code>Job-Mode-Wait-Configuration-Change:NoWait</code> for the request header, specify <code>forceSplit</code> .
timeout	int	<p>(Optional) Timeout period for waiting for completion of synchronization of differential data (seconds)</p> <p>Specify the timeout time for the processing that synchronizes the differential data with the S-VOL if the journal contains differential data.</p> <p>Specify a value in the range from 1 to 10000.</p> <p>If you do not specify a value, 7200 is assumed.</p> <p>If you specify <code>Job-Mode-Wait-Configuration-Change:NoWait</code> for the request header, the value specified for this attribute is ignored.</p> <p>If the synchronization of the pairs does not finish within the specified time, the REST API job fails. However, on the storage system, the synchronization processing and the splitting processing after the synchronization is completed continue to be performed. To check whether the synchronization of the pairs has finished, obtain the information about the target pairs.</p>

Response message

Body

A job object is returned. For details on attributes other than `affectedResources`, see the section explaining job objects.

Attribute	Description
<code>affectedResources</code>	URL of the copy group of the Universal Replicator pairs that were switched

Action template

None.

Status codes

For details on the status codes of the request for this operation, see the description on HTTP status codes.

Coding example

```
curl -v -H "Accept: application/json" -H "Content-type: application/json" -H "Authorization:Session d7b673af189048468c5af9bcf3bbbb6f" -X POST --data-binary @./InputParameters.json https://192.0.2.100/ConfigurationManager/v1/objects/remote-mirror-copypairs/NotSpecified,copyGroup,localDeviceGroup,NotSpecified,pair/actions/takeover/invoke
```

Chapter 12: Managing global-active device pairs

This chapter describes how to perform operations on global-active device pairs by using the REST API.

Overview of global-active device

Global-active device enables you to duplicate volumes between two storage systems to improve availability of the storage systems. If you register resources of each storage system in the same virtual storage machine and specify the same virtual LDEV ID for the volumes to be paired, the host can handle the volumes as a volume of a storage system. I/O from the host can be received by both storage systems. If data is written in one volume, the data is automatically synchronized with another volume.

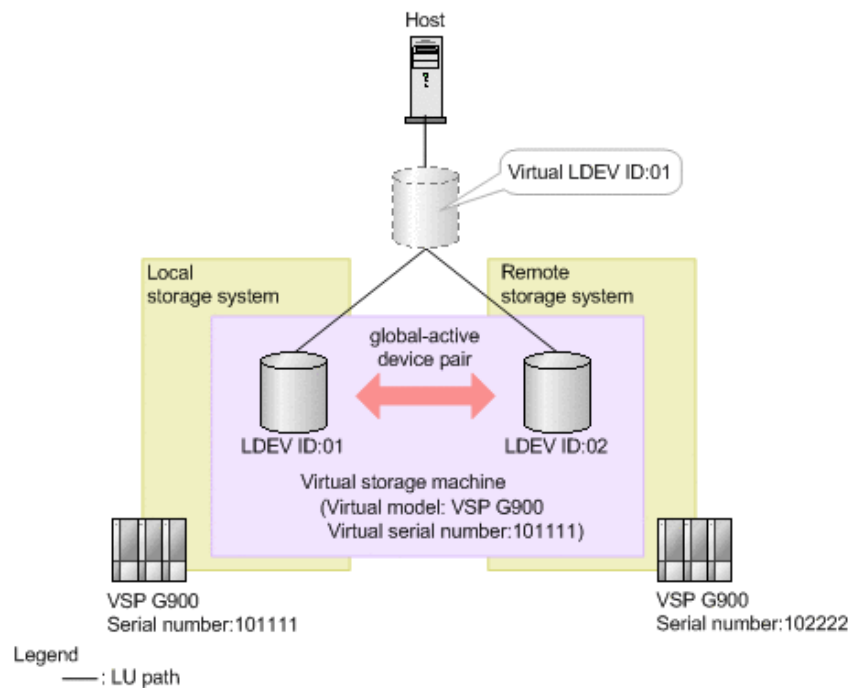

If you issue an API request from a REST API client, you can create a global-active device pair, or perform operations on pairs when stopping either storage system for maintenance.

For a global-active device in a cross-path configuration (using a Fibre Channel connection), you can change the volume settings to enable the ALUA attribute or to set the priority levels of ALUA paths.

For determining the synchronous status of data between global-active device paired volumes, the quorum is used. For details on global-active device, see the *Global-Active Device User Guide*.

Workflow for operating global-active device pairs

The global-active device pair operation, which is performed in an environment that uses the REST API, is divided into normal operation and maintenance operation.



Important:

If you perform operations on or get information about global-active device pairs, specify Remote-Authorization for the request header.

Normal operation

The following figure shows the workflow for the normal operation.

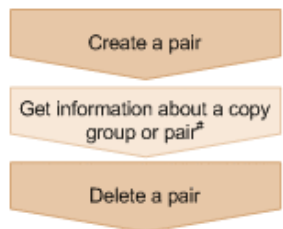

#: Optional operation

Creating a pair

Create a pair, and then copy all of the data in the P-VOL to the S-VOL. The pair is duplicated. Create a pair in a new copy group (mirror), or add a pair to an existing copy group (mirror). A copy group is a group made up of copy pairs. Each copy group consists of a device group made up of P-VOLs, and a device group made up of S-VOLs.

Getting information about a copy group or pair

You can perform operations on the pair in units of copy groups or pairs.

Deleting a pair

Suspend the pair in advance, and then dissolve the pair status of the volumes.

Maintenance operation

You can use the REST API to stop the storage systems used by global-active device as planned and to perform maintenance work.

The following figure shows the workflow for performing maintenance work of the primary site.

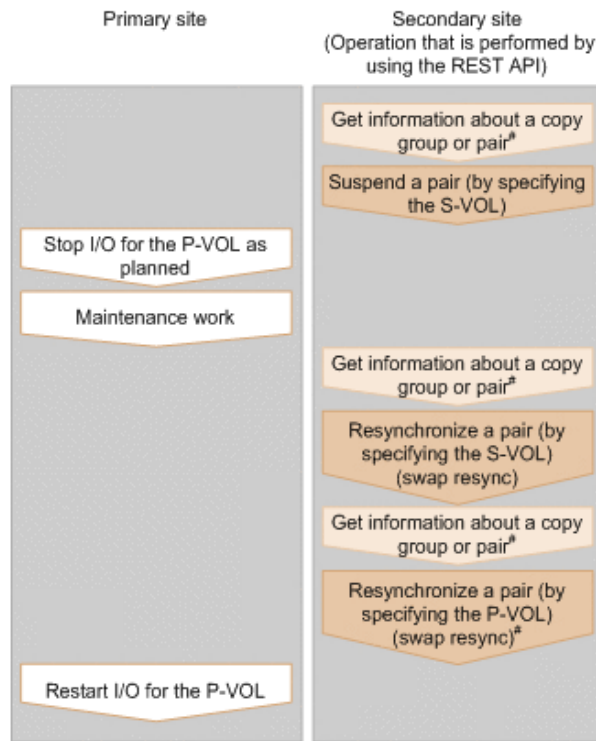

#: Optional operation

Suspending a pair (by specifying the S-VOL)

Suspend the status of a pair that is duplicated. I/O is switched to the secondary site.

Stopping I/O for the P-VOL as planned

Stop I/O for the P-VOL.

Maintenance work

At the primary site, upgrade the micro version or perform other maintenance work.

Resynchronizing a pair (by specifying the S-VOL) (swap resync)

After the maintenance work, resynchronize the differential data generated during stop of the P-VOL. Switch the P-VOL and the S-VOL, and then copy the data of the switched P-VOL to the S-VOL to resynchronize the pair.



Note:

Resynchronization can be performed in units of copy groups or pairs. If you want to register pairs to a consistency group during resynchronization, perform resynchronization in units of copy groups. Do not perform resynchronization in units of pairs.

Resynchronizing a pair (by specifying the P-VOL) (swap resync)

If necessary, switch the switched P-VOL and S-VOL.

Restarting I/O for the P-VOL

Restart I/O for the P-VOL.

Specifying Job-Mode-Wait-Configuration-Change in the request header

During the creation, splitting, and resynchronizing of pairs, if multiple asynchronous processing requests are issued at the same time, jobs might get stuck and the job status might not change to `Completed` because data copying takes a long time. In such cases, specify `Job-Mode-Wait-Configuration-Change:NoWait` in the request header so that the job status changes to `Completed` without waiting for data copying to finish, and the next job starts. At this time, data copying continues even after job execution ends. To check whether data copying has finished, check the pair status of the target resource instead of the job status. For details about the pair status, see the description of the pair status transitions.

Pair status (global-active device)

The following explains the operations and status transitions for global-active device pairs.

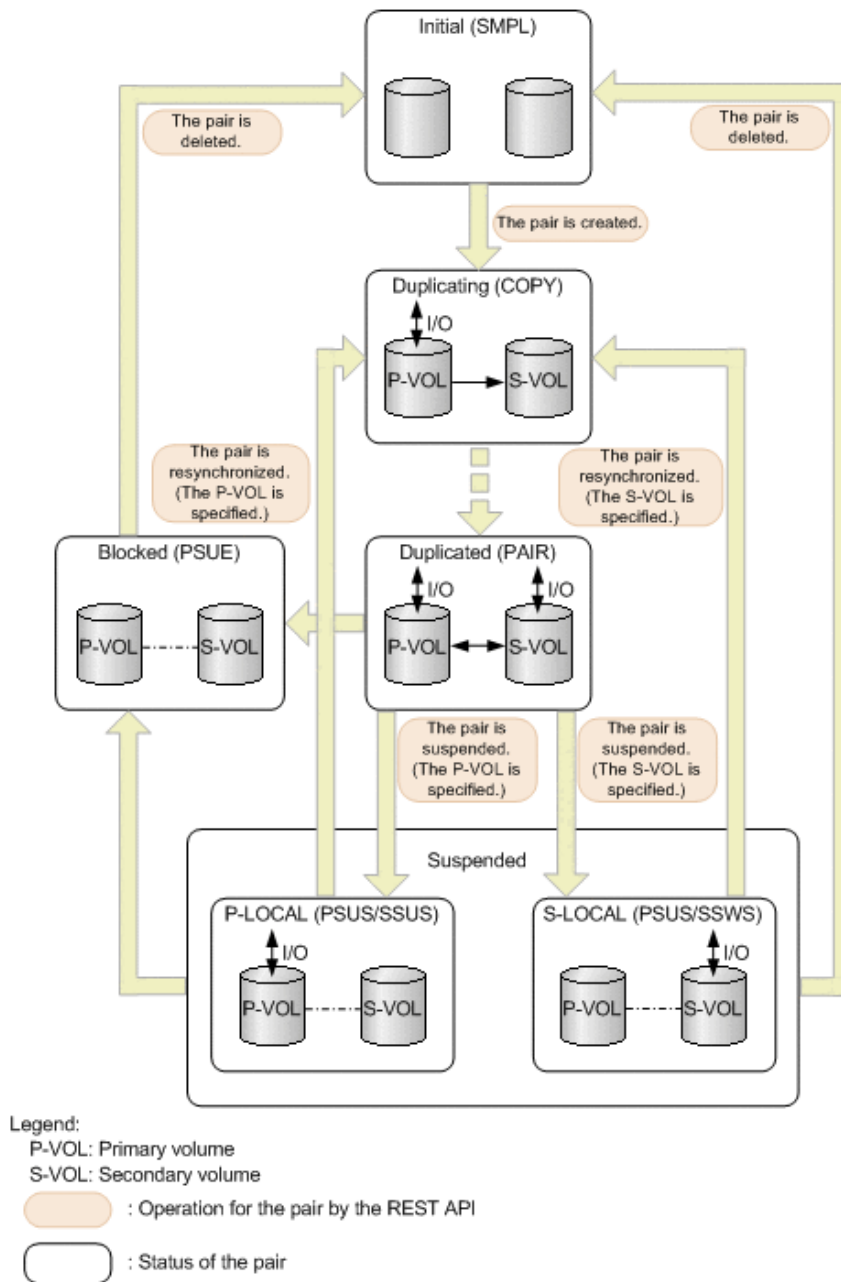

Management of the status for global-active device pairs

Global-active device pairs are managed based on the following statuses and mode:

- **GAD status**
Status of a global-active device pair. The value is determined by the combination of the pair status and I/O mode, and is not output anywhere.
- **Pair status**
Pair statuses for the primary volume and the secondary volume
- **I/O mode**
I/O modes for the primary volume and the secondary volume

The following table shows GAD status values.

GAD status	Description
Simplex	Status before creating a pair
Mirroring	The status is being changed to the mirrored status. This status indicates either of the following cases: <ul style="list-style-type: none"> ▪ A Quorum disk is being prepared. ▪ Data in the P-VOL is being copied to the S-VOL.
Mirrored	The pair is running normally. Data is duplicated.
Suspended	The pair is suspended by operation or due to a failure. The latest data is stored in either the P-VOL or the S-VOL. I/O from the host targets only the volume that contains the latest data.
Blocked	Multiple failures occurred at the same time, and neither the P-VOL nor the S-VOL accepts I/O from the host. This status indicates either of the following cases: <ul style="list-style-type: none"> ▪ The latest data is stored in both the P-VOL and the S-VOL, and one of the volumes can accept I/O from the host if the pair is forcibly deleted. However, the REST API cannot be used to forcibly delete the pair. ▪ A failure occurred on the local storage system or the remote storage system, and the volume on the other storage system also blocks I/O from the host.

The following table shows pair status values. The primary volume and the secondary volume each have the pair status.

Pair status	Description
SMPL	Unpaired volumes
COPY	A pair is being created. An initial copy or resynchronization is being performed.
PAIR	Paired volumes The initial copy is completed, and data is duplicated.
PSUS	The pair is suspended by operation.

Pair status	Description
	(This value is output for the P-VOL.)
SSUS	The pair is suspended by operation, and the S-VOL is not updated. (This value is output for the S-VOL.)
PSUE	The pair is suspended and blocked due to a failure.
SSWS	The pair is suspended by operation or due to a failure, and the P-VOL is not updated. (This value is output for the S-VOL.)

The following table shows I/O mode values. I/O mode indicates the I/O operations for the primary and secondary volumes that make up a global-active device pair.

I/O mode	Status	Read processing	Write processing
L/M	Mirror (RL)	Data in the volume on the local storage system is sent to the host.	Data is written to the volumes on the local storage system and the remote storage system, in this order.
L/L	Local	Data in the volume on the local storage system is sent to the host.	Data is written to the volume on the local storage system only.
B/B	Block	Denied. (An illegal request is returned.)	Denied. (An illegal request is returned.)

"L" indicates "local". "M" indicates "Mirror". "B" indicates "Block".

The following table shows the relationships of the GAD status, pair status, and I/O mode.

GAD status	Trigger of suspension	P-VOL		S-VOL		Volume that contains the latest data
		Pair status	I/O mode	Pair status	I/O mode	
Simplex	--	SMPL	--	SMPL	--	--
Mirroring	--	COPY	L/M	COPY	B/B	P-VOL
Mirrored	--	PAIR	L/M	PAIR	L/M	P-VOL

GAD status	Trigger of suspension	P-VOL		S-VOL		Volume that contains the latest data		
		Pair status	I/O mode	Pair status	I/O mode			
						S-VOL		
Suspended (P-LOCAL)	Operation for the pair	PSUS	L/L	SSUS	B/B	P-VOL		
	Failure	PSUE	L/L	PSUE	B/B			
				SMPL	--			
				N	N			
Suspended (S-LOCAL)	Operation for the pair	PSUS	B/B	SSWS	L/L	S-VOL		
	Failure	PSUE	B/B	SSWS	L/L			
							SMPL	--
							N	N
Blocked	--	PSUE	B/B	PSUE	B/B	P-VOL		
				N	N	S-VOL		
		N	N	PSUE	B/B			

(Legend)

--: Not applied.

N: The I/O mode and pair status cannot be confirmed due to a storage system failure.



Note:

In the following cases, if you perform an operation on a pair, the request successfully returns a response, but the details specified in the request body are not actually applied:

- When you perform a pair suspending operation on a pair for which the status is PSUS or SSUS
- When you perform a pair resynchronization operation on a pair for which the status is COPY or PAIR

Getting a list of remote copy groups

The following request gets a list of all the remote copy groups in which the remote copy pairs (TrueCopy, Universal Replicator, and global-active device) of the target storage system are registered. If the device group name or copy group name contains single-byte spaces, copy group information cannot be obtained.

Execution permission

Storage Administrator (View Only)

Request line

```
GET base-URL/v1/objects/remote-mirror-copygroups
```

Request message

Object ID

None.

Query parameters

Parameter	Type	Filter Condition
remoteStorageDeviceId	string	(Required) Storage device ID of the remote storage system If a failure occurs in a remote storage system and you then specify <code>NotSpecified</code> , only the information about the local storage system is obtained. In this situation (when a failure occurs and you specify <code>NotSpecified</code>), you do not need to specify the <code>Remote-Authorization</code> header.

Body

None.

Response message

Body

```
{
  "data" : [ {
    "remoteMirrorCopyGroupId" : "886000123789,remoteCopyGroup1,
remoteCopyGroup1S_,remoteCopyGroup1P_",
```

```

"copyGroupName" : "remoteCopyGroup1",
"muNumber" : 0,
"remoteStorageDeviceId" : "886000123789",
"localDeviceGroupName" : "remoteCopyGroup1S_",
"remoteDeviceGroupName" : "remoteCopyGroup1P_"
}, {
  "remoteMirrorCopyGroupId" : "886000123789,remoteCopyGroup2,
remoteCopyGroup2P_,remoteCopyGroup2S_",
  "copyGroupName" : "remoteCopyGroup2",
  "muNumber" : 0,
  "remoteStorageDeviceId" : "886000123789",
  "localDeviceGroupName" : "remoteCopyGroup2P_",
  "remoteDeviceGroupName" : "remoteCopyGroup2S_"
}, {
  "remoteMirrorCopyGroupId" : "886000123789,remoteCopyGroup3,
remoteCopyGroup3P_,remoteCopyGroup3S_",
  "copyGroupName" : "remoteCopyGroup3",
  "muNumber" : 0,
  "remoteStorageDeviceId" : "886000123789",
  "localDeviceGroupName" : "remoteCopyGroup3P_",
  "remoteDeviceGroupName" : "remoteCopyGroup3S_"
} ]
}

```

Attribute	Type	Description
remoteStorageDeviceId	string	Storage device ID of the remote storage system If you specify <code>NotSpecified</code> for <code>remoteStorageDeviceId</code> , <code>NotSpecified</code> is output.
copyGroupName	string	Copy group name
localDeviceGroupName	string	Device group name in the local storage system
remoteDeviceGroupName	string	Device group name in the remote storage system If you specify <code>NotSpecified</code> for <code>remoteStorageDeviceId</code> , <code>NotSpecified</code> is output.
muNumber	int	MU (mirror unit) number If the MU number cannot be obtained, information is not output.

Attribute	Type	Description
remoteMirrorCopyGroupID	string	Object ID of the remote copy group The following attributes are output, separated by commas: <ul style="list-style-type: none"> ▪ remoteStorageDeviceId ▪ copyGroupName ▪ localDeviceGroupName ▪ remoteDeviceGroupName

Status codes

For details on the status codes of the request for this operation, see the description on HTTP status codes.

Coding example

```
curl -v -H "Accept: application/json" -H "Remote-Authorization:Session
10399a1ffce3489b9c3a823017462396" -H "Authorization:Session
d7b673af189048468c5af9bcf3bbbb6f" -X GET https://192.0.2.100/
ConfigurationManager/v1/objects/remote-mirror-copygroups?
remoteStorageDeviceId=886000123789
```

Getting information about a specific remote copy group

The following request gets information about the specified copy group. This request also gets information about the pairs (TrueCopy, Universal Replicator, or global-active device) included in the copy group. If the copy group name or copy pair name contains single-byte spaces, pair information cannot be obtained.

Execution permission

Storage Administrator (View Only)

Request line

```
GET base-URL/v1/objects/remote-mirror-copygroups/object-ID
```

Request message**Object ID**

Specify the value of `remoteMirrorCopyGroupId` that was obtained by the processing to get information about the remote copy group. You can also specify the attributes and connect them with commas as follows:

```
remoteStorageDeviceId, copyGroupName, localDeviceGroupName, remoteDeviceGroupName
```

Attribute	Type	Description
<code>remoteStorageDeviceId</code>	string	(Required) Storage device ID of the remote storage system# Specify a decimal (base 10) number equal to or greater than 0.
<code>copyGroupName</code>	string	(Required) Copy group name Specify a character string consisting of 1 to 31 characters. The name is case sensitive.
<code>localDeviceGroupName</code>	string	(Required) Device group name in the local storage system Specify a character string consisting of 1 to 31 characters. The name is case sensitive.
<code>remoteDeviceGroupName</code>	string	(Required) Device group name in the remote storage system# Specify a character string consisting of 1 to 31 characters. The name is case sensitive.

#: If you specify `NotSpecified` in cases such as when a failure occurs in a remote storage system, only information about the local storage system can be acquired. If you specify `NotSpecified`, copy pair information about attributes of volumes that belong to the remote storage system will not be output. In this case, you do not need to specify the `Remote-Authorization` header.

Query parameters

None.

Body

None.

Response message**Body**

The following is an example of the output when information about TrueCopy pairs is obtained:

```
{
  "remoteMirrorCopyGroupId" : "886000123789,remoteCopyGroup1,
remoteCopyGroup1P_,remoteCopyGroup1S_",
  "copyGroupName" : "remoteCopyGroup1",
  "copyPairs" : [ {
    "copyGroupName" : "remoteCopyGroup1",
    "copyPairName" : "pair1",
    "replicationType" : "TC",
    "remoteMirrorCopyPairId" : "886000123789,remoteCopyGroup1,
remoteCopyGroup1P_,remoteCopyGroup1S_,pair1",
    "pvolLdevId" : 2108,
    "svolLdevId" : 1581,
    "fenceLevel" : "DATA",
    "pvolStatus" : "PAIR",
    "svolStatus" : "PAIR",
    "consistencyGroupId": 5,
    "pvolStorageDeviceId" : "886000123456",
    "svolStorageDeviceId" : "886000123789"
  }, {
    "copyGroupName" : "remoteCopyGroup1",
    "copyPairName" : "pair2",
    "replicationType" : "TC",
    "remoteMirrorCopyPairId" : "886000123789,remoteCopyGroup1,
remoteCopyGroup1P_,remoteCopyGroup1S_,pair2",
    "pvolLdevId" : 2109,
    "svolLdevId" : 1582,
    "fenceLevel" : "DATA",
    "pvolStatus" : "PSUS",
    "svolStatus" : "SMPL",
    "consistencyGroupId": 5,
    "pvolStorageDeviceId" : "886000123456",
    "svolStorageDeviceId" : "886000123789"
  } ],
  "remoteStorageDeviceId" : "886000123789",
  "localDeviceGroupName" : "remoteCopyGroup1P_",
  "remoteDeviceGroupName" : "remoteCopyGroup1S_"
}
```

The following is an example of the output when information about Universal Replicator pairs is obtained:

```
{
  "remoteMirrorCopyGroupId" : "886000123789,remoteCopyGroup2,
```

```

remoteCopyGroup2P_,remoteCopyGroup2S_",
  "copyGroupName" : "remoteCopyGroup2",
  "copyPairs" : [ {
    "copyGroupName" : "remoteCopyGroup2",
    "copyPairName" : "pair1",
    "replicationType" : "UR",
    "remoteMirrorCopyPairId" : "886000123789,remoteCopyGroup2,
remoteCopyGroup2P_,remoteCopyGroup2S_,pair1",
    "consistencyGroupId" : 10,
    "pvolLdevId" : 1569,
    "pvolJournalId" : 13,
    "svolLdevId" : 2835,
    "svolJournalId" : 36,
    "fenceLevel" : "ASYNC",
    "pvolStatus" : "PAIR",
    "svolStatus" : "PAIR",
    "pvolStorageDeviceId" : "886000123456",
    "svolStorageDeviceId" : "886000123789"
  } ],
  "remoteStorageDeviceId" : "886000123789",
  "localDeviceGroupName" : "remoteCopyGroup2P_",
  "remoteDeviceGroupName" : "remoteCopyGroup2S_"
}

```

The following is an example of the output when information about global-active device pairs is obtained:

```

{
  "remoteMirrorCopyGroupId" : "886000123789,remoteCopyGroup3,
remoteCopyGroup3P_,remoteCopyGroup3S_",
  "copyGroupName" : "remoteCopyGroup3",
  "copyPairs" : [ {
    "copyGroupName" : "remoteCopyGroup3",
    "copyPairName" : "pair1",
    "replicationType" : "GAD",
    "remoteMirrorCopyPairId" : "886000123789,remoteCopyGroup3,
remoteCopyGroup3P_,remoteCopyGroup3S_,pair1",
    "quorumDiskId" : 14,
    "pvolLdevId" : 1580,
    "svolLdevId" : 2128,
    "fenceLevel" : "NEVER",
    "pvolStatus" : "PAIR",
    "svolStatus" : "PAIR",
    "pvolIOMode" : "L/M",
    "svolIOMode" : "L/M",
    "pvolStorageDeviceId" : "886000123456",
    "svolStorageDeviceId" : "886000123789"
  } ],
  "remoteStorageDeviceId" : "886000123789",
}

```

```

"localDeviceGroupName" : "remoteCopyGroup3P_",
"remoteDeviceGroupName" : "remoteCopyGroup3S_"
}

```

Attribute	Type	Description
remoteStorageDeviceId	string	Storage device ID of the remote storage system If you specify a value that includes <code>NotSpecified</code> for the object ID, <code>NotSpecified</code> is output.
copyGroupName	string	Copy group name
localDeviceGroupName	string	Device group name in the local storage system
remoteDeviceGroupName	string	Device group name in the remote storage system If you specify a value that includes <code>NotSpecified</code> for the object ID, <code>NotSpecified</code> is output.
remoteMirrorCopyGroupId	string	Object ID of the remote copy group The following attributes are output, separated by commas: <ul style="list-style-type: none"> ▪ remoteStorageDeviceId ▪ copyGroupName ▪ localDeviceGroupName ▪ remoteDeviceGroupName

Attribute	Type	Description
copyPairs	object[]	The detailed information about the copy pair is output.

Attribute	Type	Description
		<ul style="list-style-type: none"> ▪ copyGroupName (string) Copy group name ▪ copyPairName (string) Copy pair name ▪ replicationType (string) Pair type <ul style="list-style-type: none"> ▪ TC: TrueCopy ▪ UR: Universal Replicator ▪ GAD: global-active device <p>If the pair status is <code>SMPL</code>, information is not output.</p> ▪ pvolLdevId (int) LDEV number of P-VOL If you specify a value that includes <code>NotSpecified</code> for the object ID, this attribute is output only if the P-VOL is a volume in the local storage system. ▪ svolLdevId (int) LDEV number of S-VOL If you specify a value that includes <code>NotSpecified</code> for the object ID, this attribute is output only if the S-VOL is a volume in the local storage system. ▪ fenceLevel (string) Fence level <ul style="list-style-type: none"> ▪ DATA: S-VOL data ▪ STATUS: S-VOL status ▪ NEVER: None ▪ ASYNC: Asynchronous <p>If the fence level cannot be obtained, information is not output.</p> ▪ pvolJournalId (int) Journal ID of the P-VOL If you specify a value that includes <code>NotSpecified</code> for the object ID, this

Attribute	Type	Description
		<p>attribute is output only if the P-VOL is a volume in the local storage system.</p> <p>A value from 0 to 255 is output only in the case of UR. If the pair status is <i>SMPL</i>, information is not output.</p> <ul style="list-style-type: none"> ▪ <i>svolJournalId</i> (int) Journal ID of the S-VOL If you specify a value that includes <i>NotSpecified</i> for the object ID, this attribute is output only if the S-VOL is a volume in the local storage system. <p>A value from 0 to 255 is output only in the case of UR. If the pair status is <i>SMPL</i>, information is not output.</p> <ul style="list-style-type: none"> ▪ <i>quorumDiskId</i> (int) ID of the Quorum disk A value from 0 to 31 is output only in the case of GAD. If the pair status is <i>SMPL</i>, information is not output. ▪ <i>pvolStatus</i> (string) Pair status of the P-VOL If you specify a value that includes <i>NotSpecified</i> for the object ID, this attribute is output only if the P-VOL is a volume in the local storage system. For details, see the section explaining on pair status (TrueCopy and Universal Replicator) or pair status (global-active device). If the pair status cannot be obtained, information is not output. ▪ <i>svolStatus</i> (string) Pair status of the S-VOL If you specify a value that includes <i>NotSpecified</i> for the object ID, this attribute is output only if the S-VOL is a volume in the local storage system.

Attribute	Type	Description
		<p>For details, see the section explaining on pair status (TrueCopy and Universal Replicator) or pair status (global-active device).</p> <p>If the pair status cannot be obtained, information is not output.</p> <ul style="list-style-type: none"> ▪ consistencyGroupID (int) Consistency group ID <p>If no consistency group consists, information is not output.</p> <ul style="list-style-type: none"> ▪ pvollIOMode (string) I/O mode of the P-VOL <ul style="list-style-type: none"> ▪ L/M: Mirror (RL) ▪ L/L: Local ▪ B/B: Block <p>Information is output only in the case of GAD. If the pair status is <i>SMPL</i>, information is not output.</p> <p>If you specify a value that includes <i>NotSpecified</i> for the object ID, this attribute is output only if the P-VOL is a volume in the local storage system.</p> <ul style="list-style-type: none"> ▪ svollIOMode (string) I/O mode of the S-VOL <ul style="list-style-type: none"> ▪ L/M: Mirror (RL) ▪ L/L: Local ▪ B/B: Block <p>Information is output only in the case of GAD. If the pair status is <i>SMPL</i>, information is not output.</p> <p>If you specify a value that includes <i>NotSpecified</i> for the object ID, this attribute is output only if the S-VOL is a volume in the local storage system.</p> <ul style="list-style-type: none"> ▪ pvolStorageDeviceID (string) Storage device ID of the storage system on the P-VOL

Attribute	Type	Description
		<p>If you specify a value that includes <code>NotSpecified</code> for the object ID, this attribute is output only if the P-VOL is a volume in the local storage system.</p> <ul style="list-style-type: none"> ▪ <code>svolStorageDeviceId</code> (string) Storage device ID of the storage system on the S-VOL <p>If you specify a value that includes <code>NotSpecified</code> for the object ID, this attribute is output only if the S-VOL is a volume in the local storage system.</p> <ul style="list-style-type: none"> ▪ <code>copyProgressRate</code> (int) Copy progress rate Information is output only when the pair status of the P-VOL is <code>COPY</code> (a pair is being created or resynchronized). This attribute is not output if you specify a value that includes <code>NotSpecified</code> for the object ID. ▪ <code>remoteMirrorCopyPairId</code> (string) Object ID of the remote copy pair[#] The following attributes are output, separated by commas: <ul style="list-style-type: none"> ▪ <code>remoteStorageDeviceId</code> ▪ <code>copyGroupName</code> ▪ <code>localDeviceGroupName</code> ▪ <code>remoteDeviceGroupName</code> ▪ <code>copyPairName</code>

[#]: We recommend that you save the object ID information you obtain in case a failure occurs. When you need to perform a takeover to recover the system, you can use the saved information to identify the pair that you need to work on, even if you cannot get information about the failed storage system.

Status codes

For details on the status codes of the request for this operation, see the description on HTTP status codes.

Coding example

For TrueCopy:

```
curl -v -H "Accept: application/json" -H "Remote-Authorization:Session
10399a1ffce3489b9c3a823017462396" -H "Authorization:Session
d7b673af189048468c5af9bcf3bbbb6f" -X GET https://192.0.2.100/
ConfigurationManager/v1/objects/remote-mirror-copygroups/886000123789,
remoteCopyGroup1,remoteCopyGroup1P_,remoteCopyGroup1S_
```

For Universal Replicator:

```
curl -v -H "Accept: application/json" -H "Remote-Authorization:Session
10399a1ffce3489b9c3a823017462396" -H "Authorization:Session
d7b673af189048468c5af9bcf3bbbb6f" -X GET https://192.0.2.100/
ConfigurationManager/v1/objects/remote-mirror-copygroups/886000123789,
remoteCopyGroup2,remoteCopyGroup2P_,remoteCopyGroup2S_
```

For global-active device:

```
curl -v -H "Accept: application/json" -H "Remote-Authorization:Session
10399a1ffce3489b9c3a823017462396" -H "Authorization:Session
d7b673af189048468c5af9bcf3bbbb6f" -X GET https://192.0.2.100/
ConfigurationManager/v1/objects/remote-mirror-copygroups/886000123789,
remoteCopyGroup3,remoteCopyGroup3P_,remoteCopyGroup3S_
```

Getting information about a global-active device pair

The following request acquires a list of volume information and storage system information about the P-VOLs and S-VOLs that make up a global-active device pair. You can get information about a pair without specifying information about the remote storage system in the request message.

**Important:**

- For this API request and the API request for getting a list of resource groups, you can run a maximum of two API requests at the same time for each storage system. The HTTP status code 503 will be returned for any unaccepted requests. In such cases, wait a while, and then run the applicable API requests again.
- If you want to run this API request at the same time as one of the following API requests, see the notes on the number of concurrent executions of the applicable API request:
 - API request for getting volume information
 - API request for getting port information (when executed with `detailInfoType=logins` specified in the query)
 - API request for getting information about host groups or iSCSI targets
 - API request for getting a list of external path groups
 - API request for getting information about a specific external path group

Execution permission

Administrator user group (built-in user group)

Request line

```
GET base-URL/v1/objects/remote-copypairs
```

Request message**Object ID**

None.

Query parameters

Parameter	Type	Filter Condition
replication Type	string	(Required) Specify the pair type. GAD: global-active device
startLdevId	int	(Optional) Specify, as a decimal (base 10) number, the number of the first LDEV for which you want to acquire information about the pair. Specify a value in the range from 0 to 65279. If you specify this attribute, be sure to also specify the <code>endLdevId</code> attribute. The value of this attribute must be equal to or less than the value of <code>endLdevId</code> .

Parameter	Type	Filter Condition
		If this attribute is omitted, 0 is set.
endLdevId	int	<p>(Optional) Specify, as a decimal (base 10) number, the number of the last LDEV for which you want to acquire information about the pair.</p> <p>Specify a value in the range from 0 to 65279.</p> <p>If you specify this attribute, be sure to also specify the <code>startLdevId</code> attribute. The value of this attribute must be equal to or greater than the value of <code>startLdevId</code>.</p> <p>Specify these values so that the range indicated by the <code>startLdevId</code> and <code>endLdevId</code> attributes consists of no more than 2048 LDEVs.</p> <p>If this attribute is omitted, 2047 will be set.</p>

Body

None.

Response message**Body**

```
{
  "data" : [ {
    "replicationType" : "GAD",
    "ldevId" : 8,
    "remoteSerialNumber" : "415008",
    "remoteStorageTypeId" : "M8",
    "remoteLdevId" : 22,
    "primaryOrSecondary" : "P-VOL",
    "muNumber" : 0,
    "status" : "PSUE",
    "isSSWS" : false,
    "createdLocalTime" : "2017-09-29T16:26:07",
    "quorumDiskId" : 1,
    "suspendedMode" : "BLOCK"
  }, {
    "replicationType" : "GAD",
    "ldevId" : 9,
    "remoteSerialNumber" : "415008",
    "remoteStorageTypeId" : "M8",
    "remoteLdevId" : 23,
    "primaryOrSecondary" : "P-VOL",
```



```

    "muNumber" : 2,
    "status" : "PSUS",
    "isSSWS" : false,
    "createdLocalTime" : "2017-10-02T09:46:36",
    "quorumDiskId" : 1,
    "suspendedMode" : "BLOCK"
  }, {
    "replicationType" : "GAD",
    "ldevId" : 73,
    "remoteSerialNumber" : "415008",
    "remoteStorageTypeId" : "M8",
    "remoteLdevId" : 2171,
    "primaryOrSecondary" : "P-VOL",
    "muNumber" : 0,
    "status" : "PAIR",
    "isSSWS" : false,
    "createdLocalTime" : "2018-11-04T01:12:39",
    "quorumDiskId" : 1,
    "suspendedMode" : "BLOCK"
  }, {
    "replicationType" : "GAD",
    "ldevId" : 93,
    "remoteSerialNumber" : "415008",
    "remoteStorageTypeId" : "M8",
    "remoteLdevId" : 25,
    "primaryOrSecondary" : "P-VOL",
    "muNumber" : 0,
    "status" : "PSUE",
    "isSSWS" : false,
    "createdLocalTime" : "2017-10-27T17:42:33",
    "quorumDiskId" : 1,
    "suspendedMode" : "BLOCK"
  }, {
    "replicationType" : "GAD",
    "ldevId" : 99,
    "remoteSerialNumber" : "415008",
    "remoteStorageTypeId" : "M8",
    "remoteLdevId" : 2163,
    "primaryOrSecondary" : "P-VOL",
    "muNumber" : 0,
    "status" : "PAIR",
    "isSSWS" : false,
    "createdLocalTime" : "2018-03-11T03:10:22",
    "quorumDiskId" : 1,
    "suspendedMode" : "BLOCK"
  } ]
}

```

Attribute	Type	Description
replicationType	string	Pair type GAD: global-active device
ldevId	int	LDEV number of the volume on the local storage system.
remoteSerialNumber	string	Serial number of the remote storage system
remoteStorageType	string	ID corresponding to the model of the remote storage system <ul style="list-style-type: none"> ▪ R8: VSP G1000, VSP G1500, or VSP F1500 ▪ M8: VSP G350, G370, G700, G900 or VSP F350, F370, F700, F900
remoteLdevId	int	LDEV number of the volume on the remote storage system
primaryOrSecondary	string	Attribute of the volume on the local storage system <ul style="list-style-type: none"> ▪ P-VOL ▪ S-VOL
muNumber	int	MU number
status	string	Pair status of the volume on the local storage system For details, see the section about pair status transition (global-active device).
isSSWS	boolean	Indicates whether the state of the volume on the local storage system is SSWS. <ul style="list-style-type: none"> ▪ true: The state of the volume is SSWS. ▪ false: The state of the volume is not SSWS.
createdLocalTime	string	Time at which the pair was created. The local time of the storage system is displayed in YYYY-MM-DDThh:mm:ss format.
quorumDiskId	int	Quorum disk ID

Attribute	Type	Description
suspendedMode	string	Block or Remote instructions when a pair is suspended <ul style="list-style-type: none"> ▪ BLOCK_IO: Block with I/O check ▪ BLOCK: Block without I/O check ▪ REMOTE: Remote

Status codes

For details on the status codes for the request that performs this operation, see the description of HTTP status codes.

Coding example

```
curl -v -H "Accept:application/json" -H "Content-Type:application/json" -H
"Authorization:Session d7b673af189048468c5af9bcf3b66b6f" -X GET https://
192.0.2.100/ConfigurationManager/v1/objects/remote-copypairs?
replicationType=GAD
```

Getting information about a specific remote copy pair

The following request gets information about the specified copy pair (TrueCopy, Universal Replicator, or global-active device). Use this information to get the information that is necessary for performing pair operations (for example, the pair status). If the copy group name or copy pair name contains single-byte spaces, pair information cannot be obtained.

Execution permission

Storage Administrator (View Only)

Request line

```
GET base-URL/v1/objects/remote-mirror-copypairs/object-ID
```

Request message**Object ID**

Specify the value of `remoteMirrorCopyPairId` that was obtained by the processing to get information about the remote copy group. You can also specify the attributes and connect them with commas as follows:

```
remoteStorageDeviceId, copyGroupName, localDeviceGroupName,
remoteDeviceGroupName, copyPairName
```

Attribute	Type	Description
remoteStorageDeviceId	string	(Required) Storage device ID of the remote storage system # Specify a decimal (base 10) number equal to or greater than 0.
copyGroupName	string	(Required) Copy group name Specify a character string consisting of 1 to 31 characters. The name is case sensitive.
localDeviceGroupName	string	(Required) Device group name in the local storage system Specify a character string consisting of 1 to 31 characters. The name is case sensitive.
remoteDeviceGroupName	string	(Required) Device group name in the remote storage system # Specify a character string consisting of 1 to 31 characters. The name is case sensitive.
copyPairName	string	(Required) Copy pair name Specify a name consisting of 1 to 31 characters. The name is case sensitive.

#: If you specify `NotSpecified` in cases such as when a failure occurs in a remote storage system, only information about the local storage system can be acquired. If you specify `NotSpecified`, copy pair information about attributes of volumes that belong to the remote storage system will not be output. In this case, you do not need to specify the `Remote-Authorization` header.

Query parameters

None.

Body

None.

Response message**Body**

The following is an example of the output when information about TrueCopy pairs is obtained:

```
{
  "copyGroupName" : "remoteCopyGroup1",
  "copyPairName" : "pair1",
  "replicationType" : "TC",
  "remoteMirrorCopyPairId" : "886000123789,remoteCopyGroup1,
remoteCopyGroup1P_,remoteCopyGroup1S_,pair1",
  "pvolLdevId" : 2108,
  "svolLdevId" : 1581,
  "fenceLevel" : "DATA",
  "pvolStatus" : "PAIR",
  "svolStatus" : "PAIR",
  "pvolStorageDeviceId" : "886000123456",
  "svolStorageDeviceId" : "886000123789"
}
```

The following is an example of the output when information about Universal Replicator pairs is obtained:

```
{
  "copyGroupName" : "remoteCopyGroup2",
  "copyPairName" : "pair1",
  "replicationType" : "UR",
  "remoteMirrorCopyPairId" : "886000123789,remoteCopyGroup2,
remoteCopyGroup2P_,remoteCopyGroup2S_,pair1",
  "consistencyGroupId" : 10,
  "pvolLdevId" : 1569,
  "pvolJournalId" : 13,
  "svolLdevId" : 2835,
  "svolJournalId" : 36,
  "fenceLevel" : "ASYNC",
  "pvolStatus" : "PAIR",
  "svolStatus" : "PAIR",
  "pvolStorageDeviceId" : "886000123456",
  "svolStorageDeviceId" : "886000123789"
}
```

The following is an example of the output when information about global-active device pairs is obtained:

```
{
  "copyGroupName" : "remoteCopyGroup3",
  "copyPairName" : "pair1",
  "replicationType" : "GAD",
}
```

```

"remoteMirrorCopyPairId" : "886000123789,remoteCopyGroup3,
remoteCopyGroup3P_,remoteCopyGroup3S_,pair1",
"quorumDiskId" : 14,
"pvolLdevId" : 1580,
"svolLdevId" : 2128,
"fenceLevel" : "NEVER",
"pvolStatus" : "PAIR",
"svolStatus" : "PAIR",
"pvolIOMode" : "L/M",
"svolIOMode" : "L/M",
"pvolStorageDeviceId" : "886000123456",
"svolStorageDeviceId" : "886000123789"
}

```

Attribute	Type	Description
copyGroupName	string	Copy group name
copyPairName	string	Copy pair name
replicationType	string	Pair type <ul style="list-style-type: none"> ▪ TC: TrueCopy ▪ UR: Universal Replicator ▪ GAD: global-active device If the pair status is <code>SMPL</code> , information is not output.
pvolLdevId	int	LDEV number of P-VOL If you specify a value that includes <code>NotSpecified</code> for the object ID, this attribute is output only if the P-VOL is a volume in the local storage system.
svolLdevId	int	LDEV number of S-VOL If you specify a value that includes <code>NotSpecified</code> for the object ID, this attribute is output only if the S-VOL is a volume in the local storage system.
fenceLevel	string	Fence level <ul style="list-style-type: none"> ▪ DATA: S-VOL data ▪ STATUS: S-VOL status ▪ NEVER: None ▪ ASYNC: Asynchronous

Attribute	Type	Description
		If the fence level cannot be obtained, information is not output.
pvolJournalId	int	Journal ID of the P-VOL A value from 0 to 255 is output only in the case of UR. If the pair status is <i>SMPL</i> , information is not output. If you specify a value that includes <i>NotSpecified</i> for the object ID, this attribute is output only if the P-VOL is a volume in the local storage system.
svolJournalId	int	Journal ID of the S-VOL A value from 0 to 255 is output only in the case of UR. If the pair status is <i>SMPL</i> , information is not output. If you specify a value that includes <i>NotSpecified</i> for the object ID, this attribute is output only if the S-VOL is a volume in the local storage system.
quorumDiskId	int	ID of the Quorum disk A value from 0 to 31 is output only in the case of GAD. If the pair status is <i>SMPL</i> , information is not output.
pvolStatus	string	Pair status of the P-VOL For details, see the section explaining on pair status (TrueCopy and Universal Replicator) or pair status (global-active device). If the pair status cannot be obtained, information is not output. If you specify a value that includes <i>NotSpecified</i> for the object ID, this attribute is output only if the P-VOL is a volume in the local storage system.
svolStatus	string	Pair status of the S-VOL For details, see the section explaining on pair status (TrueCopy and Universal Replicator) or pair status (global-active device). If the pair status cannot be obtained, information is not output.

Attribute	Type	Description
		If you specify a value that includes <code>NotSpecified</code> for the object ID, this attribute is output only if the S-VOL is a volume in the local storage system.
<code>consistencyGroupid</code>	int	Consistency group ID If no consistency group consists, information is not output.
<code>pvolIOMode</code>	string	I/O mode of the P-VOL <ul style="list-style-type: none"> ▪ L/M: Mirror (RL) ▪ L/L: Local ▪ B/B: Block Information is output only in the case of GAD. If the pair status is <code>SMPL</code> , information is not output. If you specify a value that includes <code>NotSpecified</code> for the object ID, this attribute is output only if the P-VOL is a volume in the local storage system.
<code>svolIOMode</code>	string	I/O mode of the S-VOL <ul style="list-style-type: none"> ▪ L/M: Mirror (RL) ▪ L/L: Local ▪ B/B: Block Information is output only in the case of GAD. If the pair status is <code>SMPL</code> , information is not output. If you specify a value that includes <code>NotSpecified</code> for the object ID, this attribute is output only if the S-VOL is a volume in the local storage system.
<code>pvolStorageDeviceid</code>	string	Storage device ID of the storage system on the P-VOL If you specify a value that includes <code>NotSpecified</code> for the object ID, this attribute is output only if the P-VOL is a volume in the local storage system.
<code>svolStorageDeviceid</code>	string	Storage device ID of the storage system on the S-VOL If you specify a value that includes <code>NotSpecified</code> for the object ID, this attribute is output only if the S-VOL is a volume in the local storage system.
<code>copyProgressRate</code>	int	Copy progress rate

Attribute	Type	Description
		Information is output only when the pair status of the P-VOL is <code>COPY</code> (a pair is being created or resynchronized). This attribute is not output if you specify a value that includes <code>NotSpecified</code> for the object ID.
<code>remoteMirrorCopyPairId</code>	string	Object ID of the remote copy pair# The following attributes are output, separated by commas: <ul style="list-style-type: none"> ▪ <code>remoteStorageDeviceId</code> ▪ <code>copyGroupName</code> ▪ <code>localDeviceGroupName</code> ▪ <code>remoteDeviceGroupName</code> ▪ <code>copyPairName</code>

#: We recommend that you save the object ID information you obtain in case a failure occurs. When you need to perform a takeover to recover the system, you can use the saved information to identify the pair that you need to work on, even if you cannot get information about the failed storage system.

Status codes

For details on the status codes of the request for this operation, see the description on HTTP status codes.

Coding example

For TrueCopy:

```
curl -v -H "Accept: application/json" -H "Remote-Authorization:Session
10399a1ffce3489b9c3a823017462396" -H "Authorization:Session
d7b673af189048468c5af9bcf3bbbbb6f" -X GET https://192.0.2.100/
ConfigurationManager/v1/objects/remote-mirror-copypairs/886000123789,
remoteCopyGroup1,remoteCopyGroup1P_,remoteCopyGroup1S_,pair1
```

For Universal Replicator:

```
curl -v -H "Accept: application/json" -H "Remote-Authorization:Session
10399a1ffce3489b9c3a823017462396" -H "Authorization:Session
d7b673af189048468c5af9bcf3bbbbb6f" -X GET https://192.0.2.100/
ConfigurationManager/v1/objects/remote-mirror-copypairs/886000123789,
remoteCopyGroup2,remoteCopyGroup2P_,remoteCopyGroup2S_,pair1
```

For global-active device:

```
curl -v -H "Accept: application/json" -H "Remote-Authorization:Session
10399a1ffce3489b9c3a823017462396" -H "Authorization:Session
d7b673af189048468c5af9bcf3b666f" -X GET https://192.0.2.100/
ConfigurationManager/v1/objects/remote-mirror-copypairs/886000123789,
remoteCopyGroup3,remoteCopyGroup3P_,remoteCopyGroup3S_,pair1
```

Creating a global-active device pair

The following request creates a global-active device pair in the storage systems of the primary and secondary sites. The global-active device pair is either added to a new copy group or to an existing copy group. If you create a copy group, a device group is also created. Before creating a pair, lock the resources or make sure that the resources have not been locked by another user.



Tip:

- Before creating the pair, set the reserved attribute of global-active device for the secondary volume by using the API that sets a virtual LDEV number.
- We recommend specifying `Job-Mode-Wait-Configuration-Change:NoWait` in the request header of this API function. For details, see the description of the flow of operations for the pairs.

Execution permission

Storage Administrator (Provisioning) and Storage Administrator (Remote Copy)

Request line

```
POST base-URL/v1/objects/remote-mirror-copypairs
```

Request message

Object ID

None.

Query parameters

None.

Body

The following is a coding example for creating a new copy group and adding a pair to the copy group:

```
{
  "copyGroupName": "remoteCopyGroup3",
```

```

"copyPairName": "pair1",
"replicationType": "GAD",
"remoteStorageDeviceId": "886000123789",
"pvolldevId": 1580,
"svolldevId": 2128,
"localDeviceGroupName": "remoteCopyGroup3P_",
"remoteDeviceGroupName": "remoteCopyGroup3S_",
"muNumber": 0,
"quorumDiskId": 14,
"isNewGroupCreation": true,
"fenceLevel": "NEVER",
"copyPace": 10,
"doInitialCopy": true,
"isDataReductionForceCopy": true
}

```

The following is a coding example for adding a pair to an existing copy group:

```

{
"copyGroupName": "remoteCopyGroup3",
"copyPairName": "pair2",
"replicationType": "GAD",
"remoteStorageDeviceId": "886000123789",
"pvolldevId": 1581,
"svolldevId": 2129,
"localDeviceGroupName": "remoteCopyGroup3P_",
"remoteDeviceGroupName": "remoteCopyGroup3S_",
"quorumDiskId": 14,
"isNewGroupCreation": false,
"fenceLevel": "NEVER",
"copyPace": 10,
"doInitialCopy": true,
"isDataReductionForceCopy": false
}

```

Attribute	Type	Description
copyGroupName	string	(Required) Specify a copy group name consisting of 1 to 29 characters. The name is case sensitive. Set a unique name that is the same for the storage systems on both the local and remote sides.
copyPairName	string	(Required) Specify a copy pair name consisting of 1 to 31 characters. The name is case sensitive.

Attribute	Type	Description
		Set a unique name that is the same for the storage systems in the copy group.
replicationType	string	(Required) Specify the pair type. GAD: global-active device
remoteStorageDeviceId	string	(Required) Specify the storage device ID of the remote storage system in which the pair is to be created.
pvolLdevId	int	(Required) Specify the LDEV number of the P-VOL with a decimal (base 10) number.
svolLdevId	int	(Required) Specify the LDEV number of the S-VOL for which the reserved attribute of global-active device is set. Specify it with a decimal (base 10) number. Specify the reserved attribute of global-active device by using the API that sets a virtual LDEV number.
pathGroupId	int	(Optional) Specify the path group ID by using a decimal (base 10) number in the range from 0 to 255. If you omit this value or specify 0, the lowest path group ID in the specified path group is used.
localDeviceGroupName	string	(Optional) Specify the device group name in the local storage system by using 1 to 31 characters. The name is case sensitive. If you add the pair to an existing copy group, specify the same device group name as that of the existing local storage system. The name needs to be unique in the local storage system. If this value is omitted, <i>copyGroupNameP_</i> is assumed.
remoteDeviceGroupName	string	(Optional) Specify the device group name in the remote storage system by using 1 to 31 characters. The name is case sensitive.

Attribute	Type	Description
		If you add the pair to an existing copy group, specify the same device group name as that of the existing remote storage system. The name needs to be unique in the remote storage system. If this value is omitted, <i>copyGroupNameS_</i> is assumed.
isNewGroupCreation	boolean	<p>(Required) Depending on the value, this attribute specifies whether to add the pair to a new copy group or to an existing copy group.</p> <ul style="list-style-type: none"> ▪ <code>true</code>: Adds the pair to a new copy group. ▪ <code>false</code>: Adds the pair to an existing copy group.
muNumber	int	<p>(Required) Specify the MU (mirror unit) number by using a number from 0 to 3.</p> <p>This value is used by the P-VOL and the S-VOL. You can specify this attribute only if you add the pair to a new copy group.</p>
quorumDiskId	int	(Required) Specify the quorum disk ID by using a decimal (base 10) number in the range from 0 to 31.
isConsistencyGroup	boolean	<p>(Optional) Depending on the value, this attribute specifies whether to register the new pair in a consistency group.</p> <ul style="list-style-type: none"> ▪ <code>true</code>: Registers the pair in a consistency group. ▪ <code>false</code>: Does not register the pair in a consistency group. <p>If you add the pair to an existing copy group, specify the same value as that of the existing copy pair. If a copy group includes both pairs that are registered in a consistency group and pairs that are not registered in a consistency group, pair operations by consistency group cannot be correctly performed. If this value is omitted, <code>false</code> is assumed.</p>
consistencyGroupId	int	(Optional) Specify the consistency group ID by using a decimal (base 10) number in the range from 0 to 255.

Attribute	Type	Description
		<p>If you omit this value when registering the new pair in a consistency group, the value is automatically assigned.</p> <p>If you add the pair to an existing copy group, specify the same value as that of the existing copy pair. If a copy group includes a pair whose consistency group ID differs, pair operations by consistency group cannot be correctly performed.</p> <p>When specifying this attribute, make sure to specify <code>true</code> for the <code>isConsistencyGroup</code> attribute.</p>
fenceLevel	string	<p>(Optional) Fence level</p> <p><code>NEVER</code> is automatically set.</p>
copyPace	int	<p>(Optional) Copy speed</p> <p>Specify a decimal (base 10) number in the range from 1 to 15 for the size of tracks to be copied. The larger the value you specify, the faster the copy speed.</p> <p>If this value is omitted, 3 is assumed.</p>
doInitialCopy	boolean	<p>(Optional) Specify whether to perform initial copy when creating a pair.</p> <ul style="list-style-type: none"> ▪ <code>true</code>: Performs initial copy. ▪ <code>false</code>: Does not perform initial copy. <p>If this value is omitted, <code>true</code> is assumed.</p>
isDataReductionForceCopy	boolean	<p>(Optional) Specify whether to forcibly create a pair for the volume for which the capacity saving function (dedupe and compression) is enabled.</p> <ul style="list-style-type: none"> ▪ <code>true</code>: Forcibly create a pair # ▪ <code>false</code>: Do not forcibly create a pair <p>When the attribute is omitted, <code>false</code> is assumed.</p>

#: Copying data of the volume for which the capacity saving function (compression or deduplication) is enabled might take up to several months, depending on the amount of data. Be sure to take this into account when planning when to create such a pair.

Response message**Body**

A job object is returned. For details on attributes other than `affectedResources`, see the section explaining job objects.

Attribute	Description
<code>affectedResources</code>	URL for accessing the created global-active device pair

Status codes

For details on the status codes of the request for this operation, see the section explaining HTTP status codes.

Coding example

```
curl -v -H "Accept: application/json" -H "Remote-Authorization:Session 10399a1ffce3489b9c3a823017462396" -H "Content-Type: application/json" -H "Authorization:Session d7b673af189048468c5af9bcf3b666f" -X POST --data-binary @./InputParameters.json https://192.0.2.100/ConfigurationManager/v1/objects/remote-mirror-copypairs
```

Deleting global-active device pairs in units of copy groups

The following request deletes global-active device pairs by using the specified copy group. When the pairs are all deleted, the device groups are also deleted. You can specify a copy group on the primary volume side to delete pairs. Alternatively, you can specify a copy group on the secondary volume side to delete pairs. Before deleting pairs, specify the copy group to suspend the pairs, and then change the statuses of the pairs to suspension. If a copy group includes the primary volume and the secondary volume, you cannot specify a copy group to delete pairs. Before deleting a pair, lock the resources or make sure that the resources have not been locked by another user.

Execution permission

Storage Administrator (Provisioning) and Storage Administrator (Remote Copy)

Request line

```
DELETE base-URL/v1/objects/remote-mirror-copygroups/object-ID
```

Request message**Object ID**

Specify the value of `remoteMirrorCopyGroupId` that was obtained by the processing to get information about the remote copy group. You can also specify the attributes and connect them with commas as follows:

```
remoteStorageDeviceId, copyGroupName, localDeviceGroupName,
remoteDeviceGroupName
```

Attribute	Type	Description
<code>remoteStorageDeviceId</code>	string	(Required) Storage device ID of the remote storage system
<code>copyGroupName</code>	string	(Required) Copy group name Specify a name consisting of 1 to 31 characters. The name is case sensitive.
<code>localDeviceGroupName</code>	string	(Required) Device group name in the local storage system Specify a name consisting of 1 to 31 characters. The name is case sensitive.
<code>remoteDeviceGroupName</code>	string	(Required) Device group name in the remote storage system Specify a name consisting of 1 to 31 characters. The name is case sensitive.

Query parameters

None.

Body

The following is a coding example of continuing to use the S-VOL after a suspended (S-LOCAL) pair is deleted:

```
{
  "isSvolToKeepUsing" : true
}
```

Attribute	Type	Description
isSvolToKeepUsing	boolean	<p>(Optional) Specify the volume that continues I/O after pairs are deleted.</p> <ul style="list-style-type: none"> <code>true</code>: Deletes the pairs by specifying the S-VOL. The S-VOL continues I/O, and the reserved attribute of global-active device is set for the P-VOL. If you set <code>true</code>, you must suspend pairs in advance by specifying the S-VOL. <code>false</code>: Deletes the pairs by specifying the P-VOL. The P-VOL continues I/O, and the reserved attribute of global-active device is set for the S-VOL. If you set <code>false</code>, you must suspend pairs in advance by specifying the P-VOL. <p>If this value is omitted, <code>false</code> is set.</p>

Response message

Body

A job object is returned. For details on attributes other than `affectedResources`, see the section explaining job objects.

Attribute	Description
<code>affectedResources</code>	URL of the copy group of the deleted global-active device pairs

Status codes

For details on the status codes of the request for this operation, see the section explaining HTTP status codes.

Coding example

```
curl -v -H "Accept: application/json" -H "Remote-Authorization:Session
10399alffce3489b9c3a823017462396" -H "Content-Type: application/json" -H
"Authorization:Session d7b673af189048468c5af9bcf3b6bb6f" -X DELETE --data-
binary @./InputParameters.json https://192.0.2.100/ConfigurationManager/v1/
objects/remote-mirror-copygroups/886000123789,remoteCopyGroup,
remoteCopyGroupP_,remoteCopyGroupS_
```

Deleting a global-active device pair

The following request deletes the specified global-active device pair. As a result of deleting a pair, if there is no pair in the copy group, the copy group and the device group are also deleted. You can specify the primary volume to delete a pair. Alternatively, you can specify the secondary volume to delete a pair. Before deleting a pair, suspend the pair, and then change the status of the pair to suspension. Before deleting a pair, lock the resources or make sure that the resources have not been locked by another user.

Execution permission

Storage Administrator (Provisioning) and Storage Administrator (Remote Copy)

Request line

```
DELETE base-URL/v1/objects/remote-mirror-copypairs/object-ID
```

Request message

Object ID

Specify the value of `remoteMirrorCopyPairId` that was obtained by the processing to get information about the remote copy pair. You can also specify the attributes and connect them with commas as follows:

```
remoteStorageDeviceId, copyGroupName, localDeviceGroupName,  
remoteDeviceGroupName, copyPairName
```

Attribute	Type	Description
<code>remoteStorageDeviceId</code>	string	(Required) Storage device ID of the remote storage system
<code>copyGroupName</code>	string	(Required) Copy group name Specify a name consisting of 1 to 31 characters. The name is case sensitive.
<code>localDeviceGroupName</code>	string	(Required) Device group name in the local storage system Specify a name consisting of 1 to 31 characters. The name is case sensitive.
<code>remoteDeviceGroupName</code>	string	(Required) Device group name in the remote storage system Specify a name consisting of 1 to 31 characters. The name is case sensitive.

Attribute	Type	Description
copyPairName	string	(Required) Copy pair name Specify a name consisting of 1 to 31 characters. The name is case sensitive.

Query parameters

None.

Body

The following is a coding example of continuing to use the S-VOL after a suspended (S-LOCAL) pair is deleted:

```
{
  "isSvolToKeepUsing" : true
}
```

Attribute	Type	Description
isSvolToKeepUsing	boolean	(Optional) Specify the volume that continues I/O after the pair is deleted. <ul style="list-style-type: none"> <code>true</code>: Deletes the pair by specifying the S-VOL. The S-VOL continues I/O, and the reserved attribute of global-active device is set for the P-VOL. If you set <code>true</code>, you must suspend pairs in advance by specifying the S-VOL. <code>false</code>: Deletes the pair by specifying the P-VOL. The P-VOL continues I/O, and the reserved attribute of global-active device is set for the S-VOL. If you set <code>false</code>, you must suspend pairs in advance by specifying the P-VOL. If this value is omitted, <code>false</code> is set.

Response message**Body**

A job object is returned. For details on attributes other than `affectedResources`, see the section explaining job objects.

Attribute	Description
<code>affectedResources</code>	URL of the deleted global-active device pair

Status codes

For details on the status codes of the request for this operation, see the section explaining HTTP status codes.

Coding example

```
curl -v -H "Accept: application/json" -H "Remote-Authorization:Session
10399a1fffce3489b9c3a823017462396" -H "Content-Type: application/json" -H
"Authorization:Session d7b673af189048468c5af9bcf3b6bb6f" -X DELETE --data-
binary @./InputParameters.json https://192.0.2.100/ConfigurationManager/v1/
objects/remote-mirror-copypairs/886000123789,remoteCopyGroup,
remoteCopyGroupP_,remoteCopyGroupS_,pair1
```

Suspending global-active device pairs in units of copy groups

The following request suspends global-active device pairs by using the specified copy group. You can specify a copy group on the primary volume side to suspend pairs. Alternatively, you can specify a copy group on the secondary volume side to suspend pairs. If a copy group includes the primary volume and the secondary volume, you cannot specify the copy group to suspend pairs. Also, when suspending pairs by copy group, do not simultaneously perform other operations on the copy group or the pairs in that copy group on which a pair suspending operation is performed.



Tip: We recommend specifying `Job-Mode-Wait-Configuration-Change:NoWait` in the request header of this API function. For details, see the description of the flow of operations for the pairs.

Execution permission

Storage Administrator (Remote Copy)

Request line

```
POST base-URL/v1/objects/remote-mirror-copygroups/object-ID/actions/split/
invoke
```

Request message**Object ID**

Specify the value of `remoteMirrorCopyGroupId` that was obtained by the processing to get information about the remote copy group. You can also specify the attributes and connect them with commas as follows:

```
remoteStorageDeviceId, copyGroupName, localDeviceGroupName,
remoteDeviceGroupName
```

Attribute	Type	Description
<code>remoteStorageDeviceId</code>	string	(Required) Storage device ID of the remote storage system
<code>copyGroupName</code>	string	(Required) Copy group name Specify a name consisting of 1 to 31 characters. The name is case sensitive.
<code>localDeviceGroupName</code>	string	(Required) Device group name in the local storage system Specify a name consisting of 1 to 31 characters. The name is case sensitive.
<code>remoteDeviceGroupName</code>	string	(Required) Device group name in the remote storage system Specify a name consisting of 1 to 31 characters. The name is case sensitive.

Query parameters

None.

Body

The following coding example is for simply suspending pairs. After pairs are suspended, I/O is continued on the P-VOL.

```
{
  "parameters": {
    "replicationType": "GAD"
  }
}
```

The following coding example is for suspending pairs by specifying the S-VOL. After pairs are suspended, I/O is continued on the S-VOL.

```
{
  "parameters": {
    "replicationType": "GAD",
    "svolOperationMode": "SSWS"
  }
}
```

Attribute	Type	Description
replicationType	string	(Required) Specify the pair type. GAD: global-active device
svolOperationMode	string	(Optional) Specify the volume that continues I/O after pairs are suspended. Specify the following value. <ul style="list-style-type: none"> SSWS: The S-VOL continues I/O. Specify the S-VOL to suspend a pair. If this attribute is omitted, the P-VOL continues I/O. In this case, specify the P-VOL to suspend a pair.

Response message

Body

A job object is returned. For details on attributes other than affectedResources, see the section explaining job objects.

Attribute	Description
affectedResources	URL of the copy group of the suspended global-active device pairs

Action template

```
GET base-URL/v1/objects/remote-mirror-copygroups/object-ID/actions/split
```

This action template returns only the specifiable attributes, depending on the following: the type of the pairs of the copy group specified for the object ID, and whether the volume in the local storage system is the primary volume or the secondary volume.

Status codes

The following table describes the meaning of the status code of the request for this operation. For details on other status codes, see the section explaining HTTP status codes.

Status code	Message	Description
412	Precondition Failed	This object indicates that operations on the pairs of the specified copy group cannot be performed.

Coding example

To get an action template:

When the storage system of the P-VOL is specified:

```
curl -v -H "Accept: application/json" -H "Remote-Authorization:Session
10399a1ffce3489b9c3a823017462396" -H "Authorization:Session
d7b673af189048468c5af9bcf3bbbb6f" -X GET https://192.0.2.100/
ConfigurationManager/v1/objects/remote-mirror-copygroups/886000123789,
remoteCopyGroup,remoteCopyGroupP_,remoteCopyGroupS_/actions/split
```

When the storage system of the S-VOL is specified:

```
curl -v -H "Accept: application/json" -H "Remote-Authorization:Session
10399a1ffce3489b9c3a823017462396" -H "Authorization:Session
d7b673af189048468c5af9bcf3bbbb6f" -X GET https://192.0.2.100/
ConfigurationManager/v1/objects/remote-mirror-copygroups/886000123456,
remoteCopyGroup,remoteCopyGroupS_,remoteCopyGroupP_/actions/split
```

To run the request after getting an action template:

When the storage system of the P-VOL is specified:

```
curl -v -H "Accept: application/json" -H "Remote-Authorization:Session
10399a1ffce3489b9c3a823017462396" -H "Content-Type: application/json" -H
"Authorization:Session d7b673af189048468c5af9bcf3bbbb6f" -X POST --data-
binary @./InputParameters.json https://192.0.2.100/ConfigurationManager/v1/
objects/remote-mirror-copygroups/886000123789,remoteCopyGroup,
remoteCopyGroupP_,remoteCopyGroupS_/actions/split/invoke
```

When the storage system of the S-VOL is specified:

```
curl -v -H "Accept: application/json" -H "Remote-Authorization:Session
10399a1ffce3489b9c3a823017462396" -H "Content-Type: application/json" -H
"Authorization:Session d7b673af189048468c5af9bcf3bbbb6f" -X POST --data-
binary @./InputParameters.json https://192.0.2.100/ConfigurationManager/v1/
```

```
objects/remote-mirror-copygroups/886000123456,remoteCopyGroup,
remoteCopyGroupS_,remoteCopyGroupP_/actions/split/invoke
```

Suspending a global-active device pair

The following request suspends the specified global-active device pair. You can specify the primary volume to suspend a pair. Alternatively, you can specify the secondary volume to suspend a pair. Also, when suspending a pair, do not simultaneously perform other operations on the copy group or the pairs in that copy group on which a pair suspending operation is performed.



Tip: We recommend specifying `Job-Mode-Wait-Configuration-Change:NoWait` in the request header of this API function. For details, see the description of the flow of operations for the pairs.

Execution permission

Storage Administrator (Remote Copy)

Request line

```
POST base-URL/v1/objects/remote-mirror-copypairs/object-ID/actions/split/
invoke
```

Request message

Object ID

Specify the value of `remoteMirrorCopyPairId` that was obtained by the processing to get information about the remote copy pair. You can also specify the attributes and connect them with commas as follows:

```
remoteStorageDeviceId,copyGroupName,localDeviceGroupName,
remoteDeviceGroupName,copyPairName
```

Attribute	Type	Description
remoteStorageDeviceId	string	(Required) Storage device ID of the remote storage system
copyGroupName	string	(Required) Copy group name Specify a name consisting of 1 to 31 characters. The name is case sensitive.
localDeviceGroupName	string	(Required) Device group name in the local storage system

Attribute	Type	Description
		Specify a name consisting of 1 to 31 characters. The name is case sensitive.
remoteDeviceGroupName	string	(Required) Device group name in the remote storage system Specify a name consisting of 1 to 31 characters. The name is case sensitive.
copyPairName	string	(Required) Copy pair name Specify a name consisting of 1 to 31 characters. The name is case sensitive.

Query parameters

None.

Body

The following coding example is for simply suspending pairs. After pairs are suspended, I/O is continued on the P-VOL.

```
{
  "parameters": {
    "replicationType": "GAD"
  }
}
```

The following coding example is for suspending pairs by specifying the S-VOL. After pairs are suspended, I/O is continued on the S-VOL.

```
{
  "parameters": {
    "replicationType": "GAD",
    "svolOperationMode": "SSWS"
  }
}
```

Attribute	Type	Description
replicationType	string	(Required) Specify the pair type. GAD: global-active device

Attribute	Type	Description
svolOperationMode	string	(Optional) Specify the volume that continues I/O after pairs are suspended. Specify the following value. <ul style="list-style-type: none"> SSWS: The S-VOL continues I/O. Specify the S-VOL to suspend a pair. If this attribute is omitted, the P-VOL continues I/O. In this case, specify the P-VOL to suspend a pair.

Response message

Body

A job object is returned. For details on attributes other than `affectedResources`, see the section explaining job objects.

Attribute	Description
<code>affectedResources</code>	URL of the suspended global-active device pair

Action template

```
GET base-URL/v1/objects/remote-mirror-coppairs/object-ID/actions/split
```

This action template returns only the specifiable attributes, depending on the following: the type of the copy pair specified for the object ID, and whether the volume in the local storage system is the primary volume or the secondary volume.

Status codes

The following table describes the meaning of the status code of the request for this operation. For details on other status codes, see the section explaining HTTP status codes.

Status code	Message	Description
412	Precondition Failed	This object indicates that operations on the specified pair cannot be performed.

Coding example

To get an action template:

When the storage system of the P-VOL is specified:

```
curl -v -H "Accept: application/json" -H "Remote-Authorization:Session 10399a1ffce3489b9c3a823017462396" -H "Authorization:Session d7b673af189048468c5af9bcf3bbbb6f" -X GET https://192.0.2.100/ConfigurationManager/v1/objects/remote-mirror-copypairs/886000123789,remoteCopyGroup,remoteCopyGroupP_,remoteCopyGroupS_,pair1/actions/split
```

When the storage system of the S-VOL is specified:

```
curl -v -H "Accept: application/json" -H "Remote-Authorization:Session 10399a1ffce3489b9c3a823017462396" -H "Authorization:Session d7b673af189048468c5af9bcf3bbbb6f" -X GET https://192.0.2.100/ConfigurationManager/v1/objects/remote-mirror-copypairs/886000123456,remoteCopyGroup,remoteCopyGroupS_,remoteCopyGroupP_,pair1/actions/split
```

To run the request after getting an action template:

When the storage system of the P-VOL is specified:

```
curl -v -H "Accept: application/json" -H "Remote-Authorization:Session 10399a1ffce3489b9c3a823017462396" -H "Content-Type: application/json" -H "Authorization:Session d7b673af189048468c5af9bcf3bbbb6f" -X POST --data-binary @./InputParameters.json https://192.0.2.100/ConfigurationManager/v1/objects/remote-mirror-copypairs/886000123789,remoteCopyGroup,remoteCopyGroupP_,remoteCopyGroupS_,pair1/actions/split/invoke
```

When the storage system of the S-VOL is specified:

```
curl -v -H "Accept: application/json" -H "Remote-Authorization:Session 10399a1ffce3489b9c3a823017462396" -H "Content-Type: application/json" -H "Authorization:Session d7b673af189048468c5af9bcf3bbbb6f" -X POST --data-binary @./InputParameters.json https://192.0.2.100/ConfigurationManager/v1/objects/remote-mirror-copypairs/886000123456,remoteCopyGroup,remoteCopyGroupS_,remoteCopyGroupP_,pair1/actions/split/invoke
```

Resynchronizing global-active device pairs in units of copy groups

The following request resynchronizes global-active device pairs by using the specified copy groups. You can specify a copy group on the primary volume side to resynchronize pairs. Alternatively, you can specify a copy group on the secondary volume side to resynchronize pairs. If a copy group includes the primary volume and the secondary volume, you cannot specify the copy group to resynchronize pairs. Also, when resynchronizing pairs by copy group, do not simultaneously perform other operations on the copy group or the pairs in that copy group on which a pair resynchronization operation is performed.



Tip: We recommend specifying `Job-Mode-Wait-Configuration-Change:NoWait` in the request header of this API function. For details, see the description of the flow of operations for the pairs.

**Note:**

To register pairs in a consistency group when performing a pair resynchronization operation, the number of pairs in the target copy group must be 1,000 or less. If the number of pairs exceeds 1,000, delete all pairs in the copy group, and then register pairs in a consistency group when you re-create the pairs. Alternatively, delete some pairs so that the number of pairs decreases to 1,000 or less, perform a pair resynchronization operation, and then register the pairs in a consistency group when you re-create the pairs that you deleted.

Execution permission

Storage Administrator (Remote Copy)

Request line

```
POST base-URL/v1/objects/remote-mirror-copygroups/object-ID/actions/resync/
invoke
```

Request message**Object ID**

Specify the value of `remoteMirrorCopyGroupId` that was obtained by the processing to get information about the remote copy group. You can also specify the attributes and connect them with commas as follows:

```
remoteStorageDeviceId, copyGroupName, localDeviceGroupName,
remoteDeviceGroupName
```

Attribute	Type	Description
<code>remoteStorageDeviceId</code>	string	(Required) Storage device ID of the remote storage system
<code>copyGroupName</code>	string	(Required) Copy group name Specify a name consisting of 1 to 31 characters. The name is case sensitive.
<code>localDeviceGroupName</code>	string	(Required) Device group name in the local storage system Specify a name consisting of 1 to 31 characters. The name is case sensitive.

Attribute	Type	Description
remoteDeviceGroupName	string	(Required) Device group name in the remote storage system Specify a name consisting of 1 to 31 characters. The name is case sensitive.

Query parameters

None.

Body

The following is a coding example for simply resynchronizing pairs:

```
{
  "parameters": {
    "replicationType": "GAD"
  }
}
```

The following is a coding example for reversing and resynchronizing pairs by specifying the S-VOL:

```
{
  "parameters": {
    "replicationType": "GAD",
    "doSwapSvol": true
  }
}
```

Attribute	Type	Description
replicationType	string	(Required) Specify the pair type. GAD: global-active device

Attribute	Type	Description
doSwapSvol	boolean	<p>(Optional) Specify the copy group to be used for a pair resynchronization operation. Use this attribute when the S-VOL side is used as the local storage system.</p> <ul style="list-style-type: none"> ▪ <code>true</code>: Resynchronize pairs by specifying the copy group on the S-VOL side (swap resync). You can use this value if the pairs in the specified copy group on the S-VOL side are suspended. Reverse the P-VOL and the S-VOL, and then copy data of the new P-VOL to the new S-VOL. ▪ <code>false</code>: Resynchronize pairs by specifying the copy group on the P-VOL side. <p>If the value is not specified, <code>false</code> will be set.</p> <p>If this attribute is set to <code>true</code>, you cannot specify <code>true</code> for the <code>doSwapPvol</code> and <code>isConsistencyGroup</code> attributes.</p>
doSwapPvol	boolean	<p>(Optional) Specify the copy group to be used for a pair resynchronization operation. Use this attribute when the P-VOL side is used as the local storage system.</p> <ul style="list-style-type: none"> ▪ <code>true</code>: Resynchronize pairs by specifying the copy group on the P-VOL side (swap resync). You can use this value if the pairs in the specified copy group on the P-VOL side are suspended. Reverse the P-VOL and the S-VOL, and then copy data of the new P-VOL to the new S-VOL. ▪ <code>false</code>: Resynchronize pairs by specifying the copy group on the P-VOL side. <p>If the value is not specified, <code>false</code> will be set.</p> <p>If this attribute is set to <code>true</code>, you cannot specify <code>true</code> for the <code>doSwapSvol</code> and <code>isConsistencyGroup</code> attributes.</p>

Attribute	Type	Description
isConsistencyGroup	boolean	<p>(Optional) You can specify the value as follows:</p> <ul style="list-style-type: none"> ▪ If the copy group is not registered in a consistency group <ul style="list-style-type: none"> • <code>true</code>: Registers the copy group in a consistency group.[#] • <code>false</code>: Leaves the copy group as it is without registering it in a consistency group. ▪ If the copy group is registered in a consistency group <ul style="list-style-type: none"> • <code>true</code>: Leaves the copy group registered in a consistency group. <p>If the value is not specified, <code>false</code> will be set. To leave the copy group registered in a consistency group, be sure to specify <code>true</code> for this attribute.</p> <p>To register the copy group in a consistency group, you must also specify the <code>consistencyGroupId</code> attribute.</p> <p>Make sure that each copy group contains either only pairs that are registered to a consistency group or only pairs that are not registered to a consistency group. If a copy group includes both pairs that are registered in a consistency group and pairs that are not registered in a consistency group, pair operations by consistency group cannot be correctly performed.</p> <p>If you specify <code>true</code> for this attribute, you cannot specify the <code>doSwapSvol</code> and <code>doSwapPvol</code> attributes.</p>
consistencyGroupId	int	<p>(Optional) Specify the consistency group ID by using a decimal (base 10) number in the range from 0 to 255.</p> <p>Be sure to specify this attribute when registering the copy group in a consistency group.</p>
fenceLevel	string	<p>(Optional) Specify <code>NEVER</code> for the fence level.</p> <p>If you specify <code>true</code> for the <code>isConsistencyGroup</code> attribute, <code>NEVER</code> is automatically set.</p>
copyPace	int	<p>(Optional) Copy speed</p> <p>Specify a decimal (base 10) number in the range from 1 to 15 for the size of tracks to be copied. The larger the value you specify, the faster the copy speed.</p>

#: This value can be specified only if the number of pairs in the copy group is 1,000 or less.

Response message

Body

A job object is returned. For details on attributes other than `affectedResources`, see the description on job objects.

Attribute	Description
<code>affectedResources</code>	URL of the copy group of the resynchronized global-active device pairs

Action template

```
GET base-URL/v1/objects/remote-mirror-copygroups/object-ID/actions/resync
```

This action template returns only the specifiable attributes, depending on the following: the type of the pairs of the copy group specified for the object ID, and whether the volume in the local storage system is the primary volume or the secondary volume.

Status codes

The following table describes the meaning of the status code of the request for this operation. For details on other status codes, see the description on HTTP status codes.

Status code	Message	Description
412	Precondition Failed	This object indicates that operations on the specified pair cannot be performed.

Coding example

To get an action template:

When the storage system of the P-VOL is specified:

```
curl -v -H "Accept: application/json" -H "Remote-Authorization:Session
10399a1ffce3489b9c3a823017462396" -H "Authorization:Session
d7b673af189048468c5af9bcf3bb6f" -X GET https://192.0.2.100/
ConfigurationManager/v1/objects/remote-mirror-copygroups/886000123789,
remoteCopyGroup,remoteCopyGroupP_,remoteCopyGroupS_/actions/resync
```

When the storage system of the S-VOL is specified:

```
curl -v -H "Accept: application/json" -H "Remote-Authorization:Session
10399a1ffce3489b9c3a823017462396" -H "Authorization:Session
d7b673af189048468c5af9bcf3bbbb6f" -X GET https://192.0.2.100/
ConfigurationManager/v1/objects/remote-mirror-copygroups/886000123456,
remoteCopyGroup,remoteCopyGroupS_,remoteCopyGroupP_/actions/resync
```

To run the request after getting an action template:

When the storage system of the P-VOL is specified:

```
curl -v -H "Accept: application/json" -H "Remote-Authorization:Session
10399a1ffce3489b9c3a823017462396" -H "Content-Type: application/json" -H
"Authorization:Session d7b673af189048468c5af9bcf3bbbb6f" -X POST --data-
binary @./InputParameters.json https://192.0.2.100/ConfigurationManager/v1/
objects/remote-mirror-copygroups/886000123789,remoteCopyGroup,
remoteCopyGroupP_,remoteCopyGroupS_/actions/resync/invoke
```

When the storage system of the S-VOL is specified:

```
curl -v -H "Accept: application/json" -H "Remote-Authorization:Session
10399a1ffce3489b9c3a823017462396" -H "Content-Type: application/json" -H
"Authorization:Session d7b673af189048468c5af9bcf3bbbb6f" -X POST --data-
binary @./InputParameters.json https://192.0.2.100/ConfigurationManager/v1/
objects/remote-mirror-copygroups/886000123456,remoteCopyGroup,
remoteCopyGroupS_,remoteCopyGroupP_/actions/resync/invoke
```

Resynchronizing a global-active device pair

The following request resynchronizes the specified global-active device pair. You can specify the primary volume to resynchronize pairs. Alternatively, you can specify the secondary volume to resynchronize pairs. Also, when resynchronizing pairs, do not simultaneously perform other operations on the copy group or pairs on which a pair resynchronization operation is performed.



Tip: We recommend specifying `Job-Mode-Wait-Configuration-Change:NoWait` in the request header of this API function. For details, see the description of the flow of operations for the pairs.

**Note:**

To register pairs in a consistency group when performing a pair resynchronization operation, the number of pairs in the target copy group must be 1,000 or less. If the number of pairs exceeds 1,000, delete all pairs in the copy group, and then register pairs in a consistency group when you re-create the pairs. Alternatively, delete some pairs so that the number of pairs decreases to 1,000 or less, perform a pair resynchronization operation, and then register the pairs in a consistency group when you re-create the pairs that you deleted.

Execution permission

Storage Administrator (Remote Copy)

Request line

```
POST base-URL/v1/objects/remote-mirror-coppairs/object-ID/actions/resync/
invoke
```

Request message**Object ID**

Specify the value of `remoteMirrorCopyPairId` that was obtained by the processing to get information about the remote copy pair. You can also specify the attributes and connect them with commas as follows:

```
remoteStorageDeviceId, copyGroupName, localDeviceGroupName,
remoteDeviceGroupName, copyPairName
```

Attribute	Type	Description
<code>remoteStorageDeviceId</code>	string	(Required) Storage device ID of the remote storage system
<code>copyGroupName</code>	string	(Required) Copy group name Specify a name consisting of 1 to 31 characters. The name is case sensitive.
<code>localDeviceGroupName</code>	string	(Required) Device group name in the local storage system Specify a name consisting of 1 to 31 characters. The name is case sensitive.
<code>remoteDeviceGroupName</code>	string	(Required) Device group name in the remote storage system

Attribute	Type	Description
		Specify a name consisting of 1 to 31 characters. The name is case sensitive.
copyPairName	string	(Required) Copy pair name Specify a name consisting of 1 to 31 characters. The name is case sensitive.

Query parameters

None.

Body

The following is a coding example for simply resynchronizing pairs:

```
{
  "parameters": {
    "replicationType": "GAD"
  }
}
```

The following is a coding example for reversing and resynchronizing pairs by specifying the P-VOL:

```
{
  "parameters": {
    "replicationType": "GAD",
    "doSwapPvol": true
  }
}
```

Attribute	Type	Description
replicationType	string	(Required) Specify the pair type. GAD: global-active device

Attribute	Type	Description
doSwapSvol	boolean	<p>(Optional) Specify the volume to be specified for a pair resynchronization operation. Use this attribute when the S-VOL side is used as the local storage system.</p> <ul style="list-style-type: none"> ▪ <code>true</code>: Resynchronize pairs by specifying the S-VOL (swap resync). <p>You can use this value if the pairs in the specified S-VOL are suspended. Reverse the P-VOL and the S-VOL, and then copy data of the new P-VOL to the new S-VOL.</p> <ul style="list-style-type: none"> ▪ <code>false</code>: Resynchronize pairs by specifying the P-VOL. <p>If the value is not specified, <code>false</code> will be set.</p> <p>If this attribute is set to <code>true</code>, you cannot specify <code>true</code> for the <code>doSwapPvol</code> and <code>isConsistencyGroup</code> attributes.</p>
doSwapPvol	boolean	<p>(Optional) Specify the volume to be specified for a pair resynchronization operation. Use this attribute when the P-VOL side is used as the local storage system.</p> <ul style="list-style-type: none"> ▪ <code>true</code>: Resynchronize pairs by specifying the P-VOL (swap resync). <p>You can use this value if the pairs in the specified P-VOL are suspended. Reverse the P-VOL and the S-VOL, and then copy data of the new P-VOL to the new S-VOL.</p> <ul style="list-style-type: none"> ▪ <code>false</code>: Resynchronize pairs by specifying the P-VOL. <p>If the value is not specified, <code>false</code> will be set.</p> <p>If this attribute is set to <code>true</code>, you cannot specify <code>true</code> for the <code>doSwapSvol</code> and <code>isConsistencyGroup</code> attributes.</p>

Attribute	Type	Description
isConsistencyGroup	boolean	<p>(Optional) You can specify the value as follows:</p> <ul style="list-style-type: none"> ▪ If the pair is not registered in a consistency group <ul style="list-style-type: none"> • <code>true</code>: Registers the pair in a consistency group. • <code>false</code>: Leaves the pair as it is without registering it in a consistency group. ▪ If the pair is registered in a consistency group <ul style="list-style-type: none"> • <code>true</code>: Leaves the pair registered in a consistency group. <p>If the value is not specified, <code>false</code> will be set. To leave the pair registered in a consistency group, be sure to specify <code>true</code> for this attribute.</p> <p>To register the pair in a consistency group, you must also specify the <code>consistencyGroupId</code> attribute.</p> <p>Make sure that each copy group contains either only pairs that are registered to a consistency group or only pairs that are not registered to a consistency group. If a copy group includes both pairs that are registered in a consistency group and pairs that are not registered in a consistency group, pair operations by consistency group cannot be correctly performed.</p> <p>If you specify <code>true</code> for this attribute, you cannot specify the <code>doSwapSvol</code> and <code>doSwapPvol</code> attributes.</p>
consistencyGroupId	int	<p>(Optional) Specify the consistency group ID by using a decimal (base 10) number in the range from 0 to 255.</p> <p>Be sure to specify this attribute when registering the pair in a consistency group.</p> <p>Unify the consistency group ID within the copy group. If a copy group includes a pair whose consistency group ID differs, pair operations by consistency group cannot be correctly performed.</p>
fenceLevel	string	<p>(Optional) Specify <code>NEVER</code> for the fence level.</p> <p>If you specify <code>true</code> for the <code>isConsistencyGroup</code> attribute, <code>NEVER</code> is automatically set.</p>
copyPace	int	(Optional) Copy speed

Attribute	Type	Description
		Specify a decimal (base 10) number in the range from 1 to 15 for the size of tracks to be copied. The larger the value you specify, the faster the copy speed.

#: This value can be specified only if the number of pairs in the copy group is 1,000 or less.

Response message

Body

A job object is returned. For details on attributes other than affectedResources, see the description on job objects.

Attribute	Description
affectedResources	URL of the resynchronized global-active device pairs

Action template

```
GET base-URL/v1/objects/remote-mirror-coppairs/object-ID/actions/resync
```

This action template returns only the specifiable attributes, depending on the following: the type of the copy pair specified for the object ID, and whether the volume in the local storage system is the primary volume or the secondary volume.

Status codes

The following table describes the meaning of the status code of the request for this operation. For details on other status codes, see the description on HTTP status codes.

Status code	Message	Description
412	Precondition Failed	This object indicates that operations on the specified pair cannot be performed.

Coding example

To get an action template:

When the storage system of the P-VOL is specified:

```
curl -v -H "Accept: application/json" -H "Remote-Authorization:Session
10399a1ffce3489b9c3a823017462396" -H "Authorization:Session
d7b673af189048468c5af9bcf3bbbb6f" -X GET https://192.0.2.100/
ConfigurationManager/v1/objects/remote-mirror-copypairs/886000123789,
remoteCopyGroup,remoteCopyGroupP_,remoteCopyGroupS_,pair1/actions/resync
```

When the storage system of the S-VOL is specified:

```
curl -v -H "Accept: application/json" -H "Remote-Authorization:Session
10399a1ffce3489b9c3a823017462396" -H "Authorization:Session
d7b673af189048468c5af9bcf3bbbb6f" -X GET https://192.0.2.100/
ConfigurationManager/v1/objects/remote-mirror-copypairs/886000123456,
remoteCopyGroup,remoteCopyGroupS_,remoteCopyGroupP_,pair1/actions/resync
```

To run the request after getting an action template:

When the storage system of the P-VOL is specified:

```
curl -v -H "Accept: application/json" -H "Remote-Authorization:Session
10399a1ffce3489b9c3a823017462396" -H "Content-Type: application/json" -H
"Authorization:Session d7b673af189048468c5af9bcf3bbbb6f" -X POST --data-
binary @./InputParameters.json https://192.0.2.100/ConfigurationManager/v1/
objects/remote-mirror-copypairs/886000123789,remoteCopyGroup,
remoteCopyGroupP_,remoteCopyGroupS_,pair1/actions/resync/invoke
```

When the storage system of the S-VOL is specified:

```
curl -v -H "Accept: application/json" -H "Remote-Authorization:Session
10399a1ffce3489b9c3a823017462396" -H "Content-Type: application/json" -H
"Authorization:Session d7b673af189048468c5af9bcf3bbbb6f" -X POST --data-
binary @./InputParameters.json https://192.0.2.100/ConfigurationManager/v1/
objects/remote-mirror-copypairs/886000123456,remoteCopyGroup,
remoteCopyGroupS_,remoteCopyGroupP_,pair1/actions/resync/invoke
```

Chapter 13: Performing Volume Migration operations

This chapter describes how to use the REST API to perform Volume Migration operations.

Overview of Volume Migration

Volume Migration is used to move data on a volume to another volume within the storage system (including a volume on an external storage system). Moving data to another volume is called migration.

Use Volume Migration to perform migration in situations such as the following:

- When you want to migrate data from the old storage system when a new storage system is installed
- When you want to migrate data with a low frequency of I/O operations to an external storage system
- When you want to relocate data with a high frequency of I/O operations to a volume on a drive with a low usage rate or to a volume on a drive with high performance

The host can access data during migration. When migration is complete, the LDEV ID and the host I/O of the migration source volume are automatically swapped with those of the migration target volume. For this reason, the host can continue to access data after the migration by using the same path settings.

The following figures show the flow of data when migration is performed by using Volume Migration.

Before migration

I/O from the host is directed to the migration source volume. From the source volume and the target volume (the volume that was created for the purpose of migration), create a pair to be used for Volume Migration.

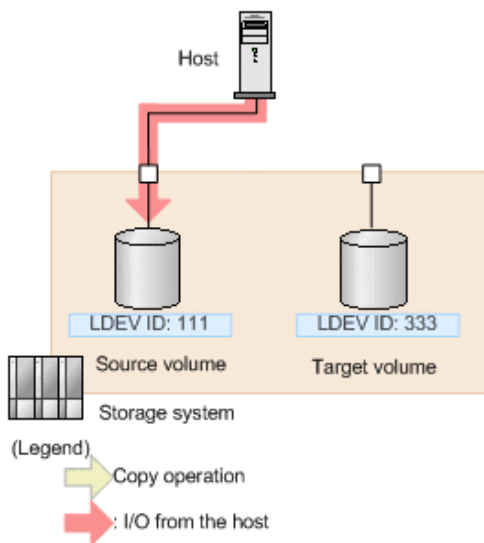

During migration

When migration is performed, data is copied from the source volume to the target volume. During migration, the host can read and write data online. If a write I/O operation from the host is performed while the data is being copied, only the differential data is copied to the target volume. Copy operations continue to be performed until all differential data has been copied.

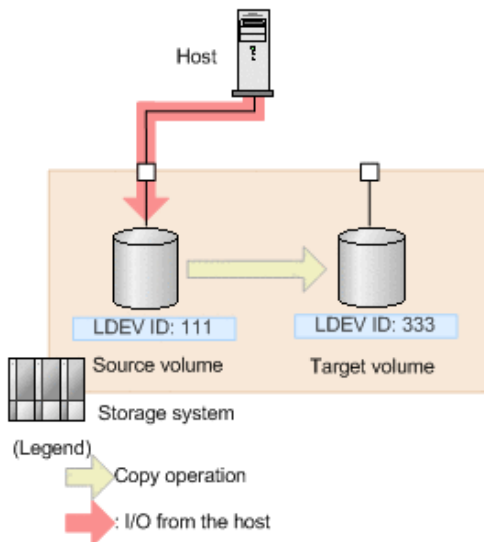

Note:

There is an upper limit to the number of copy operations that can be performed, and the upper limit varies depending on the capacity of the source volume. If differential data still exists after the upper limit for the number of copy operations is exceeded, migration will fail. In this case, reduce the load from the host, and then perform migration again. Use a value of 50 IOPS or less as a reference value for the update I/O operations from the host.

When migration is complete

After the data is copied and the data on the source volume and the data on the target volume are fully synchronized, the LDEV ID and the host I/O of the source volume are swapped with those of the target volume. From the host, the volume and the path settings are the same as before the migration. The actual data, however, has been migrated to the volume that was prepared for migration.

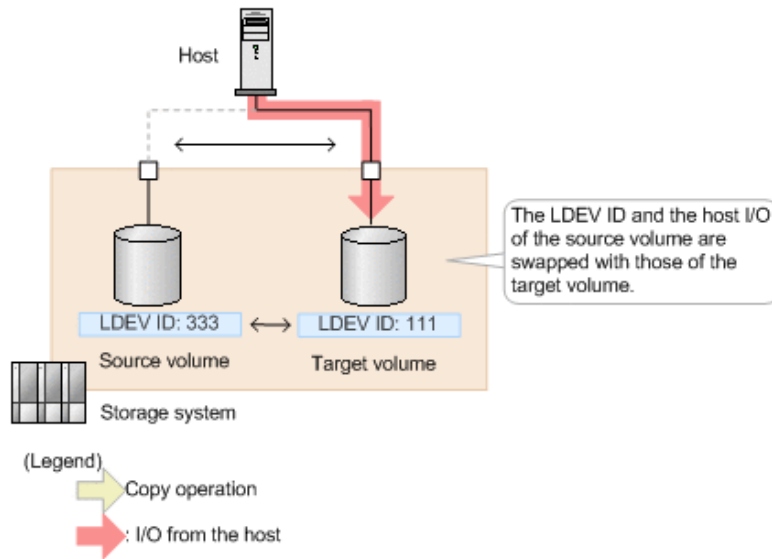

For details about the requirements for using Volume Migration and notes regarding the migration of volumes, see the *Hitachi Volume Migration User Guide*.

Workflow for performing Volume Migration

The following explains how to perform migrations by using Volume Migration, which is executed by the REST API.

For details about the requirements for volumes to be used for Volume Migration and notes on performing migration, see the *Hitachi Volume Migration User Guide*.

Preparing for migration

Before starting migration, prepare a volume as the migration destination (target volume). You must set an LU path for the target volume.

The following figure shows the workflow.

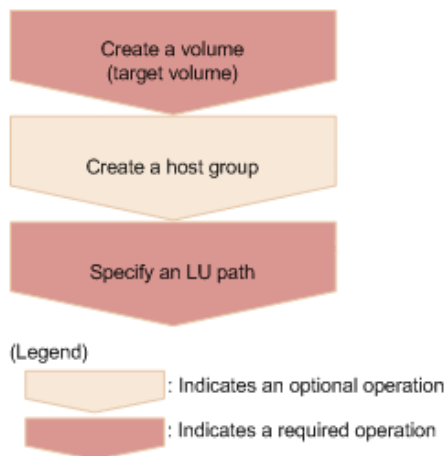

Creating volumes (target volumes)

Create target volumes to which data is to be migrated.

Creating a host group

Create a host group so that LU paths can be set for the target volumes. The host group does not need to be allocated to the host. You can use an existing host group, but it must not include the volumes to be migrated (source volumes).

Setting LU paths

Specify the host group that you created for the target volumes, and then set LU paths.

Migrating data

Create Volume Migration pairs by specifying the source volumes as the P-VOLs and the target volumes as the S-VOLs, and then copy the data. You can perform operations on copy pairs in units of copy groups. A copy group is a group made up of copy pairs. Each copy group consists of a device group that is made up of P-VOLs and a device group made up of S-VOLs.

The following figure shows the workflow.

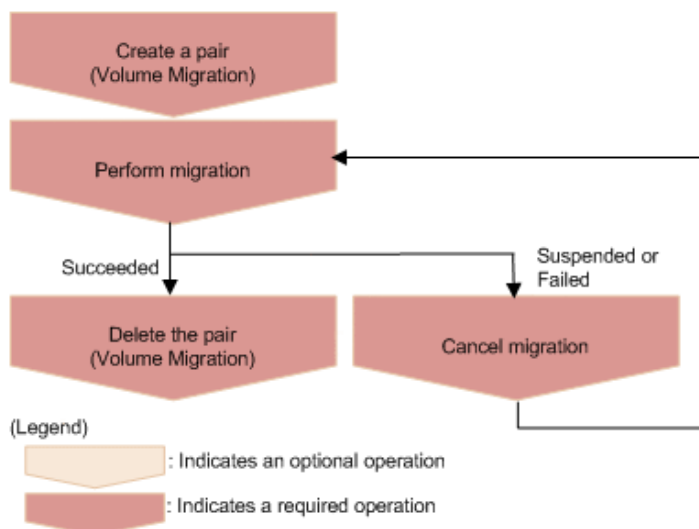

Creating pairs (Volume Migration)

Use the source volumes and the target volumes to create Volume Migration pairs. When a Volume Migration pair is created, the pair status is SMPL. Data is not copied until migration is performed.

Migrating data

Copy data from the source volumes to the target volumes in units of pairs or copy groups. When data copying is complete, the LDEV IDs and the path settings of the source volumes and the target volumes are switched, and the I/O from the host switches to the target volumes.

Deleting pairs (Volume Migration)

After the migration job is complete, if migration was successful, delete the pairs for migration.

Canceling migration

Cancel migration to stop the migration processing or if a migration job fails. When the migration of a pair is canceled, the pair status changes to SMPL, and you can then perform migration again.

Performing post-migration tasks

Delete the volumes and the host group that were created for migration.

The following figure shows the workflow.

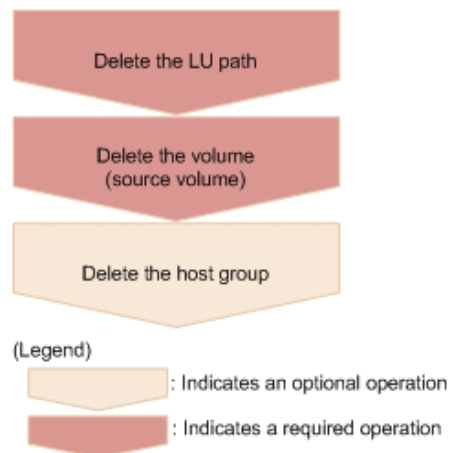
**Deleting LU paths**

Delete the LU paths that were set for the source volumes. Note that the path settings of source volumes and target volumes are switched when migration finishes. For this reason, be sure to delete the paths set for the host group that was created for volume migration (the host group that is not allocated to the host).

Deleting volumes (source volumes)

Delete the source volumes. Note that the LDEV IDs are switched when migration finishes. For this reason, when specifying the LDEV IDs of the volumes to be deleted, be sure to specify the LDEV IDs of the volumes that were created as the target volumes (volumes that do not receive I/O from the host).

Deleting the host group

If the host group to which the source volumes belong is no longer necessary, delete the host group.

Specifying Job-Mode-Wait-Configuration-Change in the request header

With respect to operations to perform or cancel migration, data copying might take a long time. As a result, the job status might not change to `Completed` and other jobs might become delayed if you execute multiple asynchronous processes at the same time. In such cases, specify `Job-Mode-Wait-Configuration-Change:NoWait` in the request header, so that the job status changes to `Completed` without waiting for data copying to finish, and the next job starts. In other words, data copying will continue even after the job execution ends. To check whether data copying has finished, check the status of the applicable pair, instead of checking the job status. For details about pair statuses, see the description of pair status transitions.

Pair status transitions (Volume Migration)

The following figure shows how pair statuses transition when certain pair operations are performed.

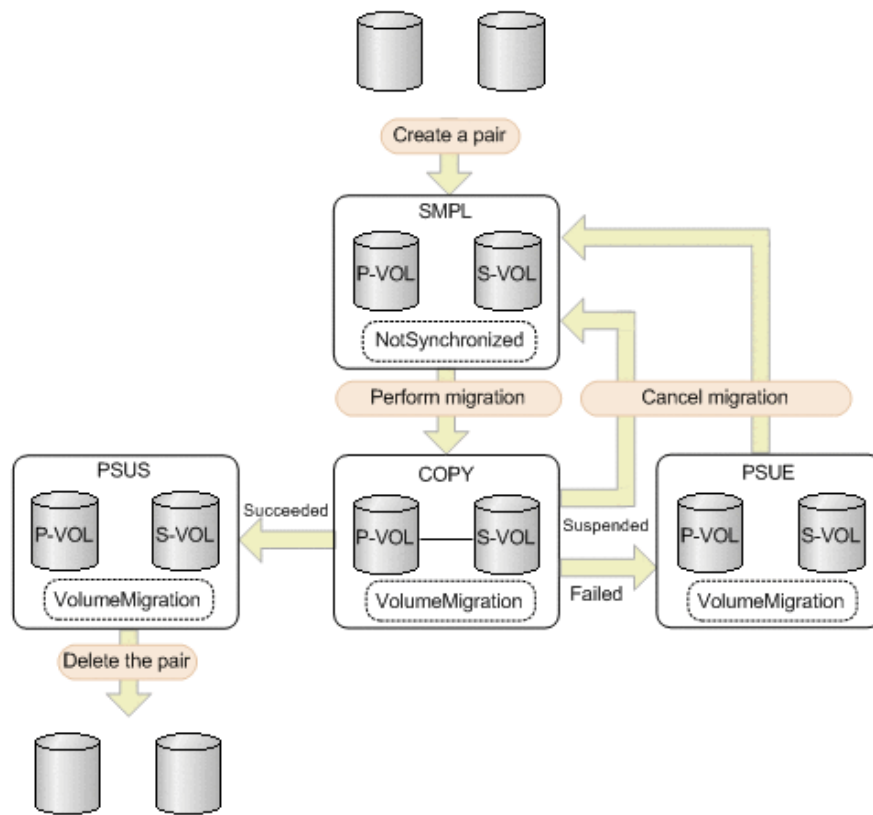

- (Legend)
- P-VOL: Primary volume
 - S-VOL: Secondary volume
 - : Indicates a pair operation performed from the REST API
 - : Indicates the pair status
 - : Indicates the copy mode

Pair status	Copy mode	Description	Access to the P-VOL	Access to the S-VOL
SMPL	NotSynchronized	Volume Migration can be performed.	R/W enabled	R/W enabled
COPY	VolumeMigration	The pair status is being migrated.	R/W enabled	-
PSUS	VolumeMigration	Migration is complete.	R/W enabled	R/W enabled
PSUE	VolumeMigration	Migration was interrupted, or migration failed.	R/W enabled	R enabled

Creating a pair to be used for Volume Migration

To perform migration by using the REST API, create a pair of volumes from the source volume (P-VOL) and the target volume (S-VOL). When the pair is created, the status of the pair is SMPL.

Execution permission

Storage Administrator (Provisioning) and Storage Administrator (Local Copy)

Request line

```
POST base-URL/v1/objects/local-clone-copypairs
```

Request message

Object ID

None.

Query parameters

None.

Body

```
{
  "copyGroupName": "vm-cg",
  "pvollDeviceGroupName": "dgp",
  "svollDeviceGroupName": "dgs",
  "copyPairName": "pair",
  "svolldevId": 40970,
  "pvolldevId": 40960,
  "replicationType": "SI",
  "copyMode": "NotSynchronized",
  "isNewGroupCreation": true
}
```

Attribute	Type	Description
copyGroupName	string	(Required) Specify the copy group name. Value should not exceed 29 characters. The name is case sensitive.
isNewGroupCreation	boolean	(Required) Depending on the value, this attribute specifies whether to add a pair to a newly created copy group or to an existing copy group.

Attribute	Type	Description
		<p>Make sure that the Volume Migration pair is not added to a copy group that includes ShadowImage pairs.</p> <ul style="list-style-type: none"> ▪ <code>true</code>: Adds the pair to a newly created copy group. ▪ <code>false</code>: Adds the pair to an existing copy group.
<code>copyPairName</code>	string	(Required) Specify the pair name. Value should not exceed 31 characters. The name is case sensitive.
<code>copyMode</code>	string	(Required) Copy mode Specify <code>NotSynchronized</code> .
<code>replicationType</code>	string	(Required) Specify <code>SI</code> .
<code>pvolLdevId</code>	int	(Required) Specify the LDEV number of the P-VOL (source volume) with a decimal (base 10) number.
<code>svolLdevId</code>	int	(Required) Specify the LDEV number of the S-VOL (target volume) with a decimal (base 10) number.
<code>pvolDeviceGroupName</code>	string	<p>(Optional) Specify the device group name for the P-VOL. Value should not exceed 31 characters. The name is case sensitive.</p> <p>Specify a device group name that differs from the device group name for the S-VOL. In addition, to add a pair to an existing copy group, specify the device group name for an existing P-VOL.</p> <p>If this value is omitted, <code>copyGroupNameP_</code> is assumed.</p>
<code>svolDeviceGroupName</code>	string	<p>(Optional) Specify the device group name for the S-VOL. Value should not exceed 31 characters. The name is case sensitive.</p> <p>Specify a device group name that differs from the device group name for the P-VOL. To add a pair to an existing copy group, specify the device group name for an existing S-VOL.</p>

Attribute	Type	Description
		If this value is omitted, <code>copyGroupNameS_</code> is assumed.

Response message

Body

A job object is returned. For details on attributes other than `affectedResources`, see the section explaining job objects.

Attribute	Description
<code>affectedResources</code>	URL of the created pair

Status codes

For details on the status codes of the request for this operation, see the description on HTTP status codes.

Coding example

```
curl -v -H "Accept: application/json" -H "Content-Type: application/json" -H "Authorization:Session d7b673af189048468c5af9bcf3b66b6f" -X POST --data-binary @./InputParameters.json https://192.0.2.100/ConfigurationManager/v1/objects/local-clone-coppairs
```

Performing migration for an entire copy group

The following request performs migration to copy the data in the source volume (P-VOL) to the target volume (S-VOL) for the entire specified copy group. When the copy operation is complete, the host switches from accessing the target volume to accessing the source volume.



Note:

After copying the data by successfully executing the API request for performing migration, execute the API request for deleting a pair to change the pair status of the source volume and the target volume to SMPL.



Tip: We recommend specifying `Job-Mode-Wait-Configuration-Change:NoWait` in the request header of this API function. For details, see the description of the flow of operations for the pairs.

Execution permission

Storage Administrator (Provisioning)

Request line

```
POST base-URL/v1/objects/local-clone-copygroups/object-ID/actions/migrate/
invoke
```

Request message**Object ID**

Specify the `localCloneCopygroupId` value obtained by getting the list of copy groups. You can also specify the following attributes and connect them with commas:

```
copyGroupName, pvolDeviceGroupName, svolDeviceGroupName
```

Attribute	Type	Description
<code>copyGroupName</code>	string	(Required) Specify the copy group name. Value should not exceed 31 characters. The name is case sensitive.
<code>pvolDeviceGroupName</code>	string	(Required) Specify the P-VOL (source volume) device group name. Value should not exceed 31 characters. The name is case sensitive.
<code>svolDeviceGroupName</code>	string	(Required) Specify the S-VOL (target volume) device group name. Value should not exceed 31 characters. The name is case sensitive.

Query parameters

None.

Body

None.

Response message**Body**

A job object is returned. See the description for the job object.

`affectedResources` is not displayed for this API. To check whether the migration was successful, execute the API request for obtaining information about a copy group. The possible pair statuses are as follows:

- If the migration was successful: `PSUS`
- If the migration failed: `PSUE`

Action template

None.

Status codes

For details on the status codes of the API, see the description on HTTP status codes.

Coding example

```
curl -v -H "Accept: application/json" -H "Content-Type: application/json" -
H "Authorization:Session d7b673af189048468c5af9bcf3bbbb6f" -X POST -d ""
https://192.0.2.100/ConfigurationManager/v1/objects/local-clone-
copygroups/vm-cg,dgp,dgs/actions/migrate/invoke
```

Performing migration

The following request performs migration to copy the data of the source volume (P-VOL) to the target volume (S-VOL). When the copy operation is complete, the host switches from accessing the target volume to accessing the source volume.

**Note:**

After copying the data by successfully executing the API request for performing migration, execute the API request for deleting a pair to change the pair status of the source volume and the target volume to SMPL.



Tip: We recommend specifying `Job-Mode-Wait-Configuration-Change:NoWait` in the request header of this API function. For details, see the description of the flow of operations for the pairs.

Execution permission

Storage Administrator (Provisioning)

Request line

```
POST base-URL/v1/objects/local-clone-coppairs/object-ID/actions/migrate/
invoke
```

Request message**Object ID**

Specify the `localCloneCoppairId` value obtained by getting the pair information. You can also specify the following attributes and connect them with commas:

```
copyGroupName, pvolDeviceGroupName, svolDeviceGroupName, copyPairName
```

Attribute	Type	Description
copyGroupName	string	(Required) Specify the copy group name. Value should not exceed 31 characters. The name is case sensitive.
pvolDeviceGroupName	string	(Required) Specify the P-VOL (source volume) device group name. Value should not exceed 31 characters. The name is case sensitive.
svolDeviceGroupName	string	(Required) Specify the S-VOL (target volume) device group name. Value should not exceed 31 characters. The name is case sensitive.
copyPairName	string	(Required) Specify the name of the pair. Value should not exceed 31 characters. The name is case sensitive.

Query parameters

None.

Body

None.

Response message**Body**

A job object is returned. See the description for the job object.

`affectedResources` is not displayed for this API. To check whether the migration was successful, execute the API request for obtaining information about a pair. The possible pair statuses are as follows:

- If the migration was successful: PSUS
- If the migration failed: PSUE

Action template

None.

Status codes

For details on the status codes of the request for this operation, see the description on HTTP status codes.

Coding example

```
curl -v -H "Accept: application/json" -H "Content-Type: application/json" -H "Authorization:Session d7b673af189048468c5af9bcf3bbbb6f" -X POST -d ""
```

```
https://192.0.2.100/ConfigurationManager/v1/objects/local-clone-copypairs/vm-cg,dgp,dgs,p1/actions/migrate/invoke
```

Getting a list of copy groups (Volume Migration)

The following request gets information about the copy groups containing pairs in the storage system.



Important:

If the copy group name or device group name contains spaces, the copy group information cannot be obtained.

Execution permission

Storage Administrator (View Only)

Request line

```
GET base-URL/v1/objects/local-clone-copygroups
```

Request message

Object ID

None.

Query parameters

None.

Body

None.

Response message

Body

```
{
  "data": [
    {
      "copyGroupName": "localCopyGroup1",
      "pvolDeviceGroupName": "localCopyGroup1P_",
      "svolDeviceGroupName": "localCopyGroup1S_",
      "localCloneCopygroupId": "localCopyGroup1,localCopyGroup1P_,
localCopyGroup1S_"
    },
    {
      "copyGroupName": "localCopyGroup2",
      "pvolDeviceGroupName": "localCopyGrouppvoll",

```

```

    "svolDeviceGroupName": "localCopyGroupsvol",
    "localCloneCopygroupId": "localCopyGroup2,localCopyGrouppv1,
localCopyGroupsvol"
  }
]
}

```

Attribute	Type	Description
copyGroupName	string	Copy group name
pvolDeviceGroupName	string	Device group name for the P-VOL (source volume)
svolDeviceGroupName	string	Device group name for the S-VOL (target volume)
localCloneCopygroupId	string	Object ID of the copy group that contains a pair The following attributes are output, separated by commas: <ul style="list-style-type: none"> ▪ copyGroupName ▪ pvolDeviceGroupName ▪ svolDeviceGroupName

Status codes

For details on the status codes of the request for this operation, see the section explaining HTTP status codes.

Coding example

```

curl -v -H "Accept: application/json" -H "Authorization:Session
d7b673af189048468c5af9bcf3bbbb6f" -X GET https://192.0.2.100/
ConfigurationManager/v1/objects/local-clone-copygroups

```

Getting information about a specific copy group (Volume Migration)

The following request acquires information about the specified copy group and about the pairs within that copy group that are to be used for Volume Migration. This operation allows you to check the status of the pairs and to acquire their pair configuration information.

**Important:**

- If the target copy group contains a pair that was created or deleted by using another REST API server or software other than the REST API, correct information about that pair might not be obtained. To obtain the most recent information about such pairs, use the API for obtaining a list of pairs.
- If the copy group name, device group name, or copy pair name contains spaces, the information cannot be obtained.

Execution permission

Storage Administrator (View Only)

Request lineGET *base-URL/v1/objects/local-clone-copygroups/object-ID***Request message****Object ID**

Specify the `localCloneCopygroupId` value obtained by getting the list of copy groups. You can also specify the following attributes and connect them with commas:

copyGroupName, pvolDeviceGroupName, svolDeviceGroupName

Attribute	Type	Description
copyGroupName	string	(Required) Specify the copy group name. Value should not exceed 31 characters. The name is case sensitive.
pvolDeviceGroupName	string	(Required) Specifies the device group name for the P-VOL (source volume). Value should not exceed 31 characters. The name is case sensitive.
svolDeviceGroupName	string	(Required) Specifies the device group name for the S-VOL (target volume). Value should not exceed 31 characters. The name is case sensitive.

Query parameters

None.

Body

None.

Response message**Body**

```

{
  "localCloneCopygroupId" : "vm-cg,dgp,dgs",
  "copyGroupName" : "vm-cg",
  "pvolDeviceGroupName" : "dgp",
  "svolDeviceGroupName" : "dgs",
  "copyPairs" : [ {
    "localCloneCoppairId" : "vm-cg,dgp,dgs,p0",
    "copyGroupName" : "vm-cg",
    "copyPairName" : "p0",
    "replicationType" : "SI",
    "copyMode" : "NotSynchronized",
    "pvolLdevId" : 40970,
    "pvolStatus" : "SMPL",
    "svolLdevId" : 40960,
    "svolStatus" : "SMPL",
    "pvolMuNumber" : 0
  }, {
    "localCloneCoppairId" : "vm-cg,dgp,dgs,p1",
    "copyGroupName" : "vm-cg",
    "copyPairName" : "p1",
    "replicationType" : "SI",
    "copyMode" : "NotSynchronized",
    "pvolLdevId" : 40971,
    "pvolStatus" : "SMPL",
    "svolLdevId" : 40961,
    "svolStatus" : "SMPL",
    "pvolMuNumber" : 0
  } ]
}

```

Attribute	Type	Description
copyGroupName	string	Copy group name
pvolDeviceGroupName	string	Device group name for the P-VOL
svolDeviceGroupName	string	Device group name for the S-VOL
localCloneCopygroupid	string	Object ID of the copy group that contains a pair

Attribute	Type	Description
		<p>The following attributes are output, separated by commas:</p> <ul style="list-style-type: none"> ▪ copyGroupName ▪ pvolDeviceGroupName ▪ svolDeviceGroupName
copyPairs	object[]	<p>The following attributes about the pairs included in the copy group:</p> <ul style="list-style-type: none"> ▪ copyGroupName (string) Copy group name ▪ copyPairName (string) Pair name ▪ replicationType (string) Pair type Outputs SI . ▪ copyMode (string) Copy mode <ul style="list-style-type: none"> ▪ NotSynchronized: Pairs created for the purpose of performing migration ▪ VolumeMigration: Pairs for which migration is in progress or for which migration is complete <p>Other values are displayed for pairs that do not meet either of the preceding conditions.</p> ▪ copyProgressRate (int) Copy progress rate (%) This attribute is not output if no information can be obtained. ▪ pvolLdevId (int) LDEV number of the P-VOL ▪ svolLdevId (int) LDEV number of the S-VOL

Attribute	Type	Description
		<ul style="list-style-type: none"> ▪ pvolStatus (string) Pair volume status of the P-VOL For details, see the section describing the pair status (Volume Migration). This attribute is not output if no information can be obtained. ▪ svolStatus (string) Pair volume status of the S-VOL For details, see the section describing the pair status (Volume Migration). This attribute is not output if no information can be obtained. ▪ localCloneCopypairId (string) Object ID of the pair ▪ pvolMuNumber (int) MU number of the P-VOL

Status codes

The following table describes the meaning of the status code of the request for this operation. For details on other status codes, see the section explaining HTTP status codes.

Status code	Message	Description
404	Not Found	No copy group can be obtained, or no pair was included in the copy group that was obtained.

Coding example

```
curl -v -H "Accept: application/json" -H "Content-Type: application/json" -
H "Authorization:Session d7b673af189048468c5af9bcf3b6bb6f" -X GET
https://192.0.2.100/ConfigurationManager/v1/objects/local-clone-copypairs?
localCloneCopyGroupId=vm-cg,dgp,dgs
```

Getting a list of pairs (Volume Migration)

The following request obtains information about the pairs in a copy group specified by using query parameters. You can also update the pair information when you obtain information about pairs.



Important:

- If the target copy group contains a pair that was created or deleted by using another REST API server or software other than the REST API, information about that pair might not be obtained. To obtain the most recent information about such pairs, run the API with `refresh=true` specified for the query parameter. Note that such processing takes time because the information about the pairs in the specified copy group is updated, and then information is obtained.
- If the copy group name, device group name, or copy pair name contains spaces, the information cannot be obtained.

Execution permission

Storage Administrator (View Only)

Request line

```
GET base-URL/v1/objects/local-clone-copypairs
```

Request message

Object ID

None.

Query parameters

Parameter	Type	Filter condition
localCloneCopyGroupId	string	(Required) Object ID of the copy group that contains a pair

Parameter	Type	Filter condition
		<p>Specify the <code>localCloneCopygroupId</code> value obtained by getting the list of copy groups. You can also specify the following attributes, separated by a comma:</p> <p><i>copyGroupName, pvolDeviceGroupName, svolDeviceGroupName</i></p> <ul style="list-style-type: none"> ▪ <code>copyGroupName</code> (string) Copy group name Value should not exceed 31 characters. ▪ <code>pvolDeviceGroupName</code> (string) Device group name for the P-VOL (source volume) Value should not exceed 31 characters. ▪ <code>svolDeviceGroupName</code> (string) Device group name for the S-VOL (target volume) Value should not exceed 31 characters.
<code>refresh</code>	boolean	<p>(Optional) Whether to update the pair information to the most recent:</p> <ul style="list-style-type: none"> ▪ <code>true</code>: Pair information will be updated. ▪ <code>false</code>: Pair information will not be updated. <p>If you specify <code>true</code>, processing takes time because the information about the pairs in the specified copy group is updated and then information is obtained. If this parameter is omitted, <code>false</code> is assumed.</p>

Body

None.

Response message**Body**

Information about the pairs in the specified copy group is obtained in a list. For details about the response body, see the section describing the API for obtaining information about a specific pair.

Status codes

For details on the status codes of the request for this operation, see the section explaining HTTP status codes.

Coding example

```
curl -v -H "Accept: application/json" -H "Authorization:Session
d7b673af189048468c5af9bcf3bbbb6f" -X GET "https://192.0.2.100/
ConfigurationManager/v1/objects/local-clone-coppairs?
localCloneCopyGroupId=localCopyGroup1,localCopyGroup1P_,
localCopyGroup1S_&refresh=true"
```

Getting information about a specific pair (Volume Migration)

The following request gets information about specific pairs to be used for Volume Migration. This operation allows you to obtain information about the status and the configuration information of the pairs.

**Important:**

- If the target pair was created or deleted by using another REST API server or software other than the REST API, correct information about that pair might not be obtained. To obtain the most recent information about the pairs, use the API for obtaining a list of pairs.
- If the copy group name, device group name, or pair name contains spaces, information cannot be obtained.

Execution permission

Storage Administrator (View Only)

Request line

```
GET base-URL/v1/objects/local-clone-coppairs/object-ID
```

Request message**Object ID**

Specify the `localCloneCoppairId` value obtained by getting the pair information. You can also specify the following attributes and connect them with commas:

```
copyGroupName,pvolDeviceGroupName,svolDeviceGroupName,copyPairName
```

Attribute	Type	Description
copyGroupName	string	(Required) Specify the copy group name. Value should not exceed 31 characters. The name is case sensitive.
pvolDeviceGroupName	string	(Required) Specify the P-VOL (source volume) device group name. Value should not exceed 31 characters. The name is case sensitive.
svolDeviceGroupName	string	(Required) Specify the S-VOL (target volume) device group name. Value should not exceed 31 characters. The name is case sensitive.
copyPairName	string	(Required) Specify the name of the pair. Value should not exceed 31 characters. The name is case sensitive.

Query parameters

None.

Body

None.

Response message**Body**

```
{
  "localCloneCopypairId" : "vm-cg,dgp,dgs,p1",
  "copyGroupName" : "vm-cg",
  "copyPairName" : "p1",
  "replicationType" : "SI",
  "copyMode" : "NotSynchronized",
  "pvolLdevId" : 40971,
  "pvolStatus" : "SMPL",
  "svolLdevId" : 40961,
  "svolStatus" : "SMPL",
  "pvolMuNumber" : 0
}
```

Attribute	Type	Description
copyGroupName	string	Copy group name

Attribute	Type	Description
copyPairName	string	Pair name
replicationType	string	Pair type Outputs SI
copyMode	string	Copy mode <ul style="list-style-type: none"> ▪ NotSynchronized: Pairs created to be used for migration ▪ VolumeMigration: Pairs for which migration is being performed or complete Other values are displayed for pairs other than the above.
copyProgressRate	int	Copy progress rate (%) This attribute is not output if no information can be obtained.
pvolLdevId	int	LDEV number of the P-VOL
svolLdevId	int	LDEV number of the S-VOL
pvolStatus	string	Pair volume status of the P-VOL For details, see the section describing the pair status (Volume Migration). This attribute is not output if no information can be obtained.
svolStatus	string	Pair volume status of the S-VOL For details, see the section describing the pair status (Volume Migration). This attribute is not output if no information can be obtained.
localCloneCopypairId	string	Object ID of the pair
pvolMuNumber	int	MU number of the P-VOL

Status codes

For details on the status codes of the request for this operation, see the section explaining HTTP status codes.

Coding example

```
curl -v -H "Accept: application/json" -H "Content-Type: application/json" -
H "Authorization:Session d7b673af189048468c5af9bcf3b66b6f" -X GET
https://192.0.2.100/ConfigurationManager/v1/objects/local-clone-
copypairs/vm-cg,dgp,dgs,p1
```

Deleting a pair (Volume Migration)

The following request deletes the specified pair. If there is no pair in the copy group, the copy group and the device group that make up the copy group are also deleted.

Execution permission

Storage Administrator (Provisioning) and Storage Administrator (Local Copy)

Request line

```
DELETE base-URL/v1/objects/local-clone-copypairs/object-ID
```

Request message**Object ID**

Specify the `localCloneCopypairId` value obtained by getting the pair information. You can also specify the following attributes and connect them with commas:

```
copyGroupName,pvolDeviceGroupName,svolDeviceGroupName,copyPairName
```

Attribute	Type	Description
copyGroupName	string	(Required) Specify the copy group name. Value should not exceed 31 characters. The name is case sensitive.
pvolDeviceGroupName	string	(Required) Specify the P-VOL (source volume) device group name. Value should not exceed 31 characters. The name is case sensitive.
svolDeviceGroupName	string	(Required) Specify the S-VOL (target volume) device group name. Value should not exceed 31 characters. The name is case sensitive.
copyPairName	string	(Required) Specify the name of the pair. Value should not exceed 31 characters. The name is case sensitive.

Query parameters

None.

Body

None.

Response message**Body**

A job object is returned. For details on attributes other than `affectedResources`, see the section explaining job objects.

Attribute	Description
<code>affectedResources</code>	URL of the deleted pair

Status codes

For details on the status codes of the request for this operation, see the description on HTTP status codes.

Coding example

```
curl -v -H "Accept: application/json" -H "Authorization:Session
d7b673af189048468c5af9bcf3bbbbb6f" -X DELETE https://192.0.2.100/
ConfigurationManager/v1/objects/local-clone-copypairs/localCopyGroup1,
localCopyGroup1P_,localCopyGroup1S_,pair1
```

Deleting a copy group (Volume Migration)

The following request deletes pairs by using the specified copy group. When the pairs are all deleted, the device groups are also deleted.

Execution permission

Storage Administrator (Provisioning) and Storage Administrator (Local Copy)

Request line

```
DELETE base-URL/v1/objects/local-clone-copygroups/object-ID
```

Request message**Object ID**

Specify the `localCloneCopygroupId` value obtained by getting the list of copy groups. You can also specify the following attributes and connect them with commas:

```
copyGroupName, pvolDeviceGroupName, svolDeviceGroupName
```

Attribute	Type	Description
<code>copyGroupName</code>	string	(Required) Specify the copy group name. Value should not exceed 31 characters. The name is case sensitive.
<code>pvolDeviceGroupName</code>	string	(Required) Specify the P-VOL (source volume) device group name. Value should not exceed 31 characters. The name is case sensitive.
<code>svolDeviceGroupName</code>	string	(Required) Specify the S-VOL (target volume) device group name. Value should not exceed 31 characters. The name is case sensitive.

Query parameters

None.

Body

None.

Response message**Body**

A job object is returned. For details on attributes other than `affectedResources`, see the section explaining job objects.

Attribute	Description
<code>affectedResources</code>	URL of the deleted copy group

Coding example

```
curl -v -H "Accept: application/json" -H "Content-Type: application/json" -H "Authorization:Session d7b673af189048468c5af9bcf3bbbb6f" -X DELETE --data-binary @./InputParameters.json https://192.0.2.100/ConfigurationManager/v1/objects/local-clone-copygroups/localCopyGroup1,localCopyGroup1P_,localCopyGroup1S_
```

When forcibly deleting a copy group

When a copy group cannot be deleted because the device group in a local storage system remains or because the configuration is not normal, you can forcibly delete the copy group by specifying the `forceDelete` attribute for the request body. The following shows a coding example of using the `forceDelete` attribute:

```
{
  "forceDelete" : true
}
```

Attribute	Type	Description
forceDelete	boolean	(Optional) Specify whether to delete the copy group forcibly. <ul style="list-style-type: none"> ▪ <code>true</code>: Forcibly delete the copy group. ▪ <code>false</code>: Do not forcibly delete the copy group. When the attribute is omitted, <code>false</code> is assumed.

Canceling migration for an entire copy group

The following request cancels migration of the pairs in a specified copy group. You can use this request if you want to cancel a migration that is in progress, or if an attempted migration fails. If migration is canceled, the status of the pairs included in the target copy group reverts to SMPL.

Execution permission

Storage Administrator (Local Copy)

Request line

```
POST base-URL/v1/objects/local-clone-copygroups/object-ID/actions/split/
invoke
```

Request message**Object ID**

Specify the `localCloneCopygroupId` value obtained by getting the list of copy groups. You can also specify the following attributes and connect them with commas:

```
copyGroupName, pvolDeviceGroupName, svolDeviceGroupName
```

Attribute	Type	Description
copyGroupName	string	(Required) Specify the copy group name. Value should not exceed 31 characters. The name is case sensitive.
pvolDeviceGroupName	string	(Required) Specify the P-VOL (source volume) device group name. Value should not exceed 31 characters. The name is case sensitive.
svolDeviceGroupName	string	(Required) Specify the S-VOL (target volume) device group name. Value should not exceed 31 characters. The name is case sensitive.

Query parameters

None.

Body

```
{
  "parameters":{
    "forceSplit": true
  }
}
```

Attribute	Type	Description
forceSplit	boolean	(Optional) Specify whether to cancel migration. <ul style="list-style-type: none"> ▪ <code>true</code>: Cancel migration. ▪ <code>false</code>: Do not cancel migration. If this attribute is omitted, <code>false</code> is assumed.

Response message**Body**

A job object is returned. For details on attributes other than `affectedResources`, see the section explaining job objects.

Attribute	Description
<code>affectedResources</code>	URL of the copy group for which migration was canceled

Status codes

For details on the status codes of the request for this operation, see the description on HTTP status codes.

Coding example

```
curl -v -H "Accept: application/json" -H "Content-Type: application/json" -
H "Authorization:Session d7b673af189048468c5af9bcf3bbbb6f" -X POST --data-
binary @./InputParameters.json https://192.0.2.100/ConfigurationManager/v1/
objects/local-clone-copygroups/vm-cg,dgp,dgs/actions/split/invoke
```

Canceling migration

The following request cancels migration of the specified pair. You can use this request if you want to cancel a migration that is in progress, or if an attempted migration fails. If migration is canceled, the status of the pair reverts to SMPL.

Execution permission

Storage Administrator (Local Copy)

Request line

```
POST base-URL/v1/objects/local-clone-copypairs/object-ID/actions/split/
invoke
```

Request message**Object ID**

Specify the `localCloneCopypairId` value obtained by getting the pair information. You can also specify the following attributes and connect them with commas:

```
copyGroupName,pvolDeviceGroupName,svolDeviceGroupName,copyPairName
```

Attribute	Type	Description
copyGroupName	string	(Required) Specify the copy group name. Value should not exceed 31 characters. The name is case sensitive.
pvolDeviceGroupName	string	(Required) Specify the P-VOL (source volume) device group name. Value should not exceed 31 characters. The name is case sensitive.

Attribute	Type	Description
svolDeviceGroupName	string	(Required) Specify the S-VOL (target volume) device group name. Value should not exceed 31 characters. The name is case sensitive.
copyPairName	string	(Required) Specify the name of the pair. Value should not exceed 31 characters. The name is case sensitive.

Query parameters

None.

Body

```
{
  "parameters": {
    "forceSplit": true
  }
}
```

Attribute	Type	Description
forceSplit	boolean	(Optional) Specify whether to cancel migration. <ul style="list-style-type: none"> <code>true</code>: Cancel migration. <code>false</code>: Do not cancel migration. If this attribute is omitted, <code>false</code> is assumed.

Response message

Body

A job object is returned. For details on attributes other than `affectedResources`, see the section explaining job objects.

Attribute	Description
<code>affectedResources</code>	URL of the pair for which migration was canceled

Status codes

For details on the status codes of the request for this operation, see the description on HTTP status codes.

Coding example

```
curl -v -H "Accept: application/json" -H "Content-Type: application/json" -H "Authorization:Session d7b673af189048468c5af9bcf3b6666f" -X POST --data-binary @./InputParameters.json https://192.0.2.100/ConfigurationManager/v1/objects/local-clone-copypairs/vm-cg,dgp,dgs,p1/actions/split/invoke
```

Chapter 14: Performing Universal Volume Manager operations

This chapter describes how to use the REST API to perform Universal Volume Manager operations.

Overview of Universal Volume Manager

Universal Volume Manager is a function that virtualizes storage devices and enables different models of storage systems to be used as one storage system.

To use volumes on an external storage system as external volumes, use a cable to connect the external connection port of the local storage system and the port of the external storage system, and then allocate (map) the volumes of the external storage system to the local storage system.

External volumes are used in situations such as the following:

- When you want to back up data in the volumes on the local storage system to the external storage system
- When you want to allocate an external volume to a host when the host issues a request for a volume to be used for storing data
- When you want to migrate data from the old storage system (external storage system) when a new storage system is installed

To discontinue the use of an external storage system that has become necessary, unmap the volumes of the unnecessary external storage system.

For details about the functions of Universal Volume Manager and related notes, see the *Hitachi Universal Volume Manager User Guide*.

The following figure shows the system configuration for using Universal Volume Manager, and the components of that configuration.

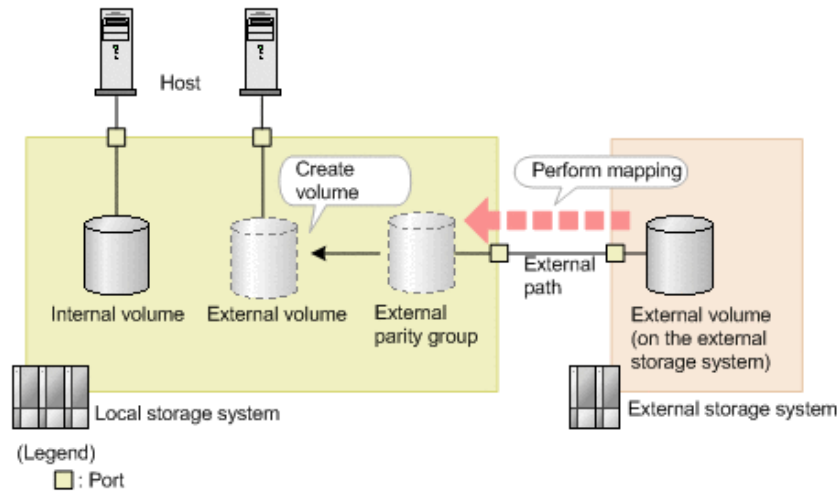

Local storage system

The local storage system receives requests from the REST API client.

External storage system

The external storage system is connected to the local storage system via external paths.

External path

An external path is a route by which the external connection port of the local storage system and the port of the external storage system are connected. You can set multiple routes as external paths. A group consisting of multiple external volumes that use the same external path is called an external parity group.

External parity group

An external parity group is used to manage external volumes on the local storage system. Although an external parity group does not include parity information, it is managed in the same way as a parity group is managed. By registering external volumes on the external storage system in the external parity group, you can use the external volume from the local storage system.

External volume

You can enable volumes on an external storage system to be used from the host by creating external volumes from the external parity group. You can use the external volumes in the same way as other volumes on the local storage system.



Tip:

The mapped volumes on the external storage system are also called external volumes. When these mapped volumes need to be distinguished from the external volumes that are used on the local storage system, the mapped volumes will be referred to as "external volumes on the external storage system".

! **Important:**

If you are using the REST API, Storage Advisor Embedded, or CCI, attempts to perform multiple, concurrent executions of the following operations on external volumes might fail or produce incorrect results.

- Getting a list of ports on an external storage system
- Getting a list of the LUs of ports on an external storage system
- Getting information about the iSCSI targets of ports on an external storage system
- Performing a test to log in to an iSCSI target of an external storage system registered to the port of the local storage system

We recommend that you do not perform multiple, concurrent executions of these operations. For details about the problems that might occur if you perform multiple, concurrent executions of these operations and how to resolve these problems, see the note on the number of concurrent executions of operations on external volumes in the *Hitachi Universal Volume Manager User Guide*.

Workflow for Universal Volume Manager

This section describes the workflow in the REST API for using Universal Volume Manager to virtualize and use external storage system resources.



Note: For the REST API, if the virtual port mode of the local storage system is enabled, the virtual port ID is assumed to be 0. If the virtual port mode is disabled, use CCI to perform operations on ports.

Using external volumes

Create external volumes by mapping volumes of the external storage system that is connected to the port of the local storage system.

The workflow is shown in the following diagram.

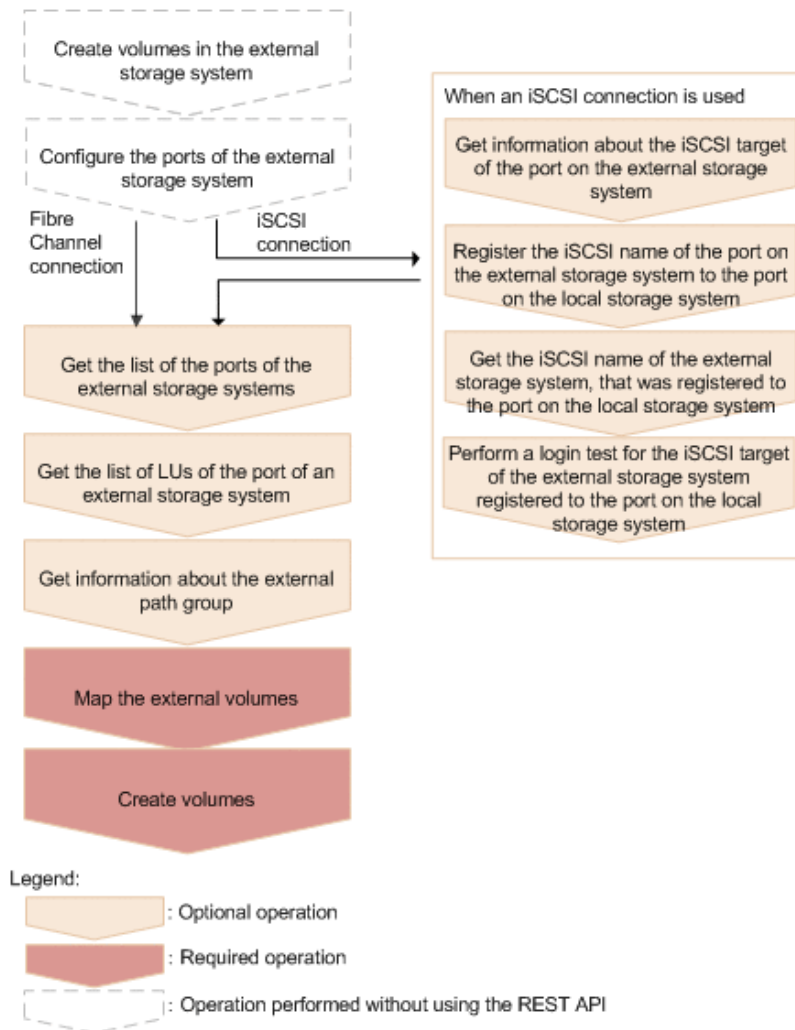

Create volumes in the external storage system

Create volumes in the external storage system. If the external storage system supports the REST API, you can use the REST API on the external storage system to create volumes.

Configure the ports of the external storage system

Configure the ports of the external storage system and the system options. For details on how to configure the ports and options, see the manual for the external storage system that you are using.

(for iSCSI) Get information about the iSCSI target of the port on the external storage system

If the external storage system is connected via an iSCSI connection, retrieve information about the iSCSI target of the port on the external storage system.

(for iSCSI) Register the iSCSI name of the port on the external storage system to the port on the local storage system

If the external storage system is connected via an iSCSI connection, register the retrieved iSCSI name of the port on the external storage system to the port on the local storage system.

After registering the iSCSI name, use the API request for performing a login test make sure that you can successfully log in.

(for iSCSI) Get the iSCSI name of the external storage system, that was registered to the port on the local storage system

If the external storage system is connected via an iSCSI connection, get the iSCSI name of the port on the external storage system, that was registered to the port on the local storage system.

(for iSCSI) Perform a login test for the iSCSI target of the external storage system, that was registered to the port of the local storage system

If the external storage system is connected via an iSCSI connection, test whether you can log in to the iSCSI target of the external storage system by using the retrieved iSCSI name.

If you cannot log in, revise the settings so that you can log in, or delete the iSCSI target. If you do not delete iSCSI targets that cannot be used to log in, when you retrieve information about iSCSI targets of the port on the external storage system, there will be an increased load on the network or external storage system and information might not be retrieved successfully.

Get the list of the ports of the external storage systems

Get information about the ports of the external storage systems that are connected. The obtained information will be used to map external volumes.

Get the list of LUs defined for the port on the external storage system

Get information about the LUs that are defined for the ports of the connected external storage system. The obtained information will be used to map external volumes.

Get information about the external path group

To use an existing external path group to perform mapping, get information about the external path group and check the path group ID.

When an iSCSI connection is used, you can perform this operation by using the Platform REST API (Simple). For detailed information about this operation, see the [Hitachi Vantara Knowledge](#).

Map the external volumes

Create external parity groups, and register information about the external volumes of the external storage system that you want to map. Check the registered mapping information with the API function for getting information about the external path group to which the parity groups that you created belong.

When an iSCSI connection is used, you can perform this operation by using the Platform REST API (Simple). For detailed information about this operation, see the [Hitachi Vantara Knowledge](#).

Create volumes

Create external volumes from the external parity groups that have been created in the local storage system. The created external volumes can be allocated to the host or used as pool volumes (this is the same as other volumes in the local storage system).

Making the external paths redundant

You can make the access routes to the external volumes redundant by setting multiple external paths between the local storage system and the external storage system. To set multiple external paths, add the paths to the external path group. The external path group is created automatically when external volumes are mapped.

The workflow is shown in the following diagram.

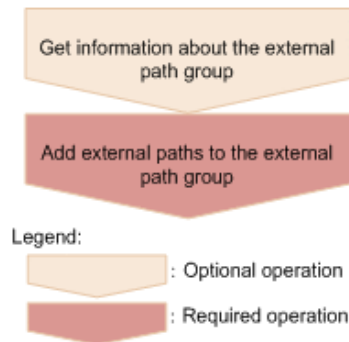

Get information about the external path group

Get information about the target external path group to check the path group ID.

When an iSCSI connection is used, you can perform this operation by using the Platform REST API (Simple). For detailed information about this operation, see the [Hitachi Vantara Knowledge](#).

Add external paths to the external path group

Add external paths by specifying the external path group.

Changing priorities of external paths

The priorities of external paths depend on the order that the paths are registered to the external path group. To change the priority of a path in the REST API, delete the paths that are registered before the path for which you want to increase the priority, and then re-register the paths.

The workflow for external paths is shown in the following diagram.

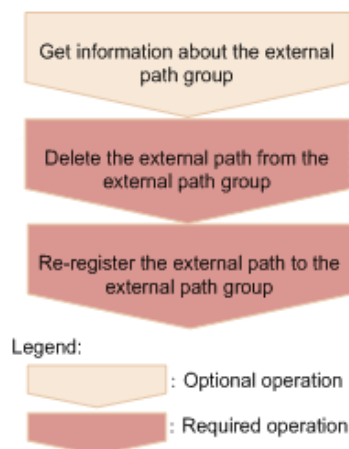

Get information about the external path group

Get information about the target external path group, and check the priorities of the external paths and the path group ID.

When an iSCSI connection is used, you can perform this operation by using the Platform REST API (Simple). For detailed information about this operation, see the [Hitachi Vantara Knowledge](#).

Delete the external path from the external path group

From the external path group, delete the external path whose priority you want to reduce.

Re-register the external path to the external path group

Re-register the deleted external path in the external path group. To add more than one path, re-register the paths starting from the path with a higher priority.

Abolishing the use of external volumes

To dispose of an external storage system, disconnect the external volumes to release the mappings, and abolish the use of the external volumes.

The workflow is shown in the following diagram.

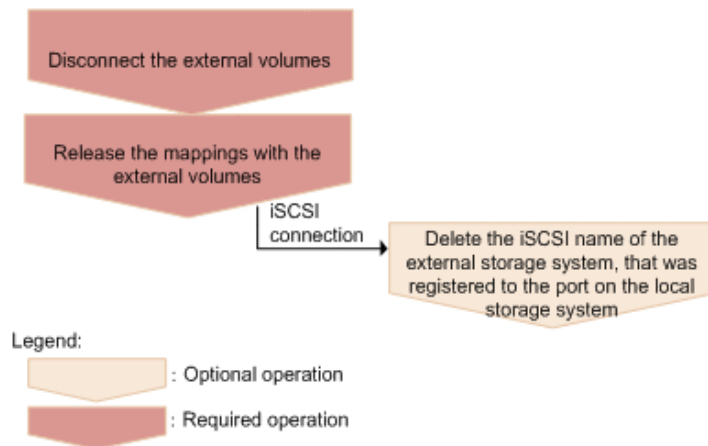
**Disconnect the external volumes**

Disconnect the external volumes. Input operations to and output operations from the mapped external volumes are stopped, and the data stored in the cache memory is written (destaged) to the external volumes.

Release the mappings with the external volumes

Delete the external parity groups to release the mappings with the external volumes. Data that has been written to the volumes on the external storage system site is not deleted after mappings are released. When the last external parity group in the external path group is deleted, the path group is automatically deleted.

(for iSCSI) Delete the iSCSI name of the external storage system, that was registered to the port on the local storage system

If the connection to the iSCSI target is no longer necessary, delete the iSCSI name of the external storage system, that was registered to the port on the local storage system.

Getting information about an iSCSI target of a port on an external storage system

This request gets information by searching for an iSCSI target (on an external storage system) that is connected to the local storage system.



Note:

- 0 is assumed for the virtual port ID if virtual port mode is enabled for the local storage system.

Execution permission

Storage Administrator (View Only)

Request line

```
POST base-URL/v1/objects/iscsi-ports/object-ID/actions/discover/invoke
```

Request message

Object ID

Specify the value of `portId` that was obtained by the processing to get information about ports.

Attributes	Type	Description
<code>portId</code>	string	(Required) Port number of the local storage system

Query parameters

None.

Body

```
{
  "parameters": {
    "iscsiIpAddress": "192.168.0.100",
    "tcpPort": 3260
  }
}
```

```
}
}
```

Attribute	Type	Description
iscsilpAddress	string	(Required) IP address of the iSCSI target on the external storage system Specify an IPv4 or IPv6 IP address.
tcpPort	int	(Optional) TCP port number of the iSCSI target on the external storage system If this attribute is omitted, the TCP port number of the port on the local storage system is assumed.

Response message

Body

```
{
  "portId": "CL1-A",
  "externalIscsiTargets": [
    {
      "iscsiIpAddress": "192.168.0.100",
      "tcpPort": 3260,
      "iscsiName": "iqn.rest.example.of.iscsi1",
      "virtualPortId": 0,
      "isRegistered": true
    },
    {
      "iscsiIpAddress": "192.168.0.101",
      "tcpPort": 3260,
      "iscsiName": "iqn.rest.example.of.iscsi2",
      "virtualPortId": 0,
      "isRegistered": false
    }
  ]
}
```

Attribute	Type	Description
portId	string	Port number of the local storage system

Attribute	Type	Description
externalscsiTargets	object[]	<p>The following attributes related to the iSCSI target of the external storage system are output:</p> <ul style="list-style-type: none"> ▪ tcpPort (int) TCP port number ▪ iscsiIpAddress (string) IP address of the iSCSI target ▪ iscsiName (string) iSCSI name of the iSCSI target ▪ virtualPortId (int) ID of the virtual port by which the local storage system is connected to the external storage system This attribute is output if the virtual port mode is enabled. ▪ isRegistered (boolean) Indicates whether this iSCSI target is registered to the iSCSI port of the local storage system <ul style="list-style-type: none"> ▪ true: The iSCSI target is registered to the iSCSI port of the local storage system. ▪ false: The iSCSI target is not registered to the iSCSI port of the local storage system.

Action template

None.

Status codes

For details about the status codes of the request for this operation, see the description of HTTP status codes.

Coding example

```
curl -v -H "Accept:application/json" -H "Content-Type:application/json" -H
"Authorization:Session f76884c29fff4dfaa664aa6981087b71" -X POST
"https://192.0.2.100/ConfigurationManager/v1/objects/iscsi-ports/CL1-A/
actions/discover/invoke"
```

Registering an iSCSI name of an external storage system to a port on the local storage system

This request registers an iSCSI name of an external storage system to a port on the local storage system.

After registering the iSCSI name, run the API request that performs a login test to verify that you can log in. If the attempt to log in fails, revise the settings so that you can log in, or delete that iSCSI target. If iSCSI targets remain to which you cannot log in, attempts to obtain information might fail because a heavy load might be placed on the network or external storage system when you search for an iSCSI target of a port on the external storage system.



Note:

- 0 is assumed for the virtual port ID if virtual port mode is enabled for the local storage system.

Execution permission

Storage Administrator (Provisioning)

Request line

POST *base-URL/v1/objects/iscsi-ports/object-ID/actions/register/invoke*

Request message

Object ID

Specify the value of `portId` that was obtained by the processing to get information about ports.

Attribute	Type	Description
portId	string	(Required) Port number of the local storage system

Query parameters

None.

Body

```
{
  "parameters": {
    "iscsiIpAddress": "192.168.0.100",
    "iscsiName": "iqn.rest.example.of.iscsi1",
    "tcpPort" : 3260
  }
}
```

```
}
}
```

Attribute	Type	Description
iscsilpAddress	string	(Required) IP address of the iSCSI target on the external storage system Specify an IPv4 or IPv6 IP address.
iscsiName	string	(Required) iSCSI name of the iSCSI target on the external storage system Specify the name in iqn or eui format. This attribute is case sensitive.
tcpPort	int	(Optional) TCP port number of the iSCSI target on the external storage system If this attribute is omitted, the TCP port number of the port on the local storage system is assumed. If the iSCSI name and IP address to be specified are already registered to a port of the local storage system, set the same value as that port or omit this attribute. If you omit this attribute in this situation, the following settings are applied: <ul style="list-style-type: none"> ▪ If the iSCSI name and IP address are already registered to the same port as the port specified for object-ID, the registered <code>tcpPort</code> value is not changed. ▪ If the iSCSI name and IP address are registered to a port different from the port specified for object-ID, the same value as the value that was set for <code>tcpPort</code> when the iSCSI name and IP address were registered to that port is set for the port specified for object-ID.

Response message

A job object is returned. For details about attributes other than `affectedResources`, see the description of job objects.

Attribute	Description
affectedResources	URL of the port (on the local storage system) to which information about the iSCSI name of the external storage system is registered

Action template

None.

Status codes

For details about the status codes of the request for this operation, see the description of HTTP status codes.

Coding example

```
curl -v -H "Accept:application/json" -H "Content-Type:application/json" -H "Authorization:Session f76884c29fff4dfaa664aa6981087b71" -X POST "https://192.0.2.100/ConfigurationManager/v1/objects/iscsi-ports/CL1-A/actions/register/invoke"
```

Getting the iSCSI name of an external storage system that is registered to a port on the local storage system

The following request gets information about the iSCSI name of an iSCSI target of a port on an external storage system that is registered to a port on the specified local storage system.

Execution permission

Storage Administrator (View Only)

Request line

```
GET base-URL/v1/objects/iscsi-ports/object-ID
```

Request message

Object ID

Specify the value of `portId` that was obtained by the processing to get information about ports.

Attribute	Type	Description
portId	string	(Required) Port number of the local storage system

Query parameters

None.

Body

None.

Response message

Body

```
{
  "portId": "CL1-A",
  "externalIscsiTargets": [
    {
      "iscsiIpAddress": "192.168.0.100",
      "tcpPort": 3260,
      "iscsiName": "iqn.rest.example.of.iscsi1",
      "authenticationMode": "CHAP",
      "iscsiTargetDirection": "D",
      "chapUserName": "Win_SQL_EX",
      "isSecretSet": true,
      "virtualPortId": 0
    },
    {
      "iscsiIpAddress": "192.168.0.101",
      "tcpPort": 3260,
      "iscsiName": "iqn.rest.example.of.iscsi2",
      "authenticationMode": "NONE",
      "iscsiTargetDirection": "S",
      "chapUserName": "-",
      "isSecretSet": false,
      "virtualPortId": 0
    }
  ]
}
```

Attribute	Type	Description
portId	string	Port number of the local storage system
externalIscsiTargets	object[]	<p>The attributes related to the iSCSI target on the external storage system are output.</p> <p>An empty array is output if the port on the external storage system is a Fibre Channel port.</p> <ul style="list-style-type: none"> ▪ iscsiIpAddress (string) IP address of the iSCSI target ▪ tcpPort (int) TCP port number ▪ iscsiName (string) iSCSI name

Attribute	Type	Description
		<ul style="list-style-type: none"> <li data-bbox="743 254 1424 457"> <p>▪ authenticationMode (string)</p> <p>CHAP-authentication mode</p> <ul style="list-style-type: none"> <li data-bbox="781 352 1235 384">• CHAP: CHAP-authentication mode <li data-bbox="781 405 1198 436">• NONE: No authentication mode <li data-bbox="743 478 1424 730"> <p>▪ iscsiTargetDirection (string)</p> <p>Direction of the iSCSI target CHAP-authentication</p> <ul style="list-style-type: none"> <li data-bbox="781 573 1406 646">• D: Bidirectional authentication (The iSCSI target and the iSCSI initiator authenticate each other.) <li data-bbox="781 657 1424 730">• S: Unidirectional authentication (The iSCSI target authenticates the iSCSI initiator.) <li data-bbox="743 762 1424 1140"> <p>▪ chapUserName (string)</p> <p>CHAP user name</p> <p>The following user name is output: the user name used when the direction of CHAP-authentication is bidirectional.</p> <p>This also appears if CHAP-authentication mode is NONE.</p> <p>A hyphen (-) appears if the CHAP user name is omitted.#</p> <li data-bbox="743 1171 1424 1392"> <p>▪ isSecretSet (boolean)</p> <p>Indicates whether a secret password is set for the CHAP authentication</p> <ul style="list-style-type: none"> <li data-bbox="781 1308 1117 1339">• true: A password is set. <li data-bbox="781 1360 1182 1392">• false: A password is not set. <li data-bbox="743 1423 1424 1623"> <p>▪ virtualPortId (int)</p> <p>ID of the virtual port by which the local storage system is connected to the external storage system</p> <p>This attribute is output if virtual port mode is enabled.</p>

#: A hyphen (-) is output if - is specified for the CHAP user name.

Status codes

For details about the status codes of the request for this operation, see the description of HTTP status codes.

Coding example

```
curl -v -H "Accept:application/json" -H "Content-Type:application/json" -H "Authorization:Session f76884c29fff4dfaa664aa6981087b71" -X GET "https://192.0.2.100/ConfigurationManager/v1/objects/iscsi-ports/CL1-A"
```

Performing a login test on an iSCSI target of an external storage system that is registered to a port on the local storage system

The following request gets a login result by logging in to an iSCSI target on an external storage system that is registered to a port on the local storage system.

If an attempt to log in fails, revise the settings so that you can log in to the iSCSI target, or delete that iSCSI target. If iSCSI targets remain to which you cannot log in, attempts to obtain information might fail because a heavy load might be placed on the network or external storage system when you search for an iSCSI target of a port on the external storage system.



Note:

- 0 is assumed for the virtual port ID if virtual port mode is enabled for the local storage system.

Execution permission

Storage Administrator (View Only)

Request line

```
POST base-URL/v1/objects/iscsi-ports/object-ID/actions/check/invoke
```

Request message

Object ID

Specify the value of `portId` that was obtained by the processing to get information about ports.

Attribute	Type	Description
portId	string	(Required) Port number of the local storage system

Query parameters

None.

Body

```
{
  "parameters": {
    "iscsiIpAddress": "192.168.0.100",
    "iscsiName": "iqn.rest.example.of.iscsi1"
  }
}
```

Attribute	Type	Description
iscsiIpAddress	string	(Required) IP address of the iSCSI target of the external storage system Specify an IPv4 or IPv6 IP address.
iscsiName	string	(Required) iSCSI name of the iSCSI target of the external storage system Specify the name in iqn or eui format. This attribute is case sensitive.

Response message

Body

```
{
  "portId": "CL1-A",
  "externalIscsiTargets": [
    {
      "iscsiIpAddress": "192.168.0.100",
      "iscsiName": "iqn.rest.example.of.iscsi1",
      "isLoginSucceeded": true
    }
  ]
}
```

Attribute	Type	Description
portId	string	Port number of the local storage system

Attribute	Type	Description
externalIscsiTargets	object[]	<p>The following attributes related to the iSCSI target of the external storage system are output:</p> <ul style="list-style-type: none"> ▪ <code>iscsiIpAddress</code> (string) IP address of the iSCSI target ▪ <code>iscsiName</code> (string) iSCSI name of the iSCSI target ▪ <code>isLoginSucceeded</code> (boolean) Result of logging in to the iSCSI target <ul style="list-style-type: none"> ▪ <code>true</code>: The login attempt succeeded. ▪ <code>false</code>: The login attempt failed.

Action template

None.

Status codes

For details about the status codes of the request for this operation, see the description of HTTP status codes.

Coding example

```
curl -v -H "Accept:application/json" -H "Content-Type:application/json" -H "Authorization:Session f76884c29fff4dfaa664aa6981087b71" -X POST "https://192.0.2.100/ConfigurationManager/v1/objects/iscsi-ports/CL1-A/actions/check/invoke"
```

Getting a list of ports on an external storage system

The following request acquires a list of ports for an external storage system that is connected to the local storage system.

**Note:**

In the case of an iSCSI port, if an iSCSI target that cannot connect to the target iSCSI port is registered, attempts to obtain information might fail because a heavy load might be placed on the network or external storage system. After registering the iSCSI name, perform a login test to verify that you can log in.

Execution permission

Storage Administrator (View Only)

Request lineGET *base-URL*/v1/objects/external-storage-ports**Request message****Object ID**

None.

Query parameters

Parameter	Type	Filter condition
portId	string	(Required) Number of the port on the local storage system

Body

None.

Response message**Body**

The following is a coding example when a Fibre Channel port is used:

```
{
  "data" : [ {
    "externalWwn" : "50060e80222fd141",
    "portId" : "CL7-A",
    "externalSerialNumber" : "477777",
    "externalStorageInfo" : "HITACHI VSP Gx00",
    "externalPathMode" : "Multi",
    "externalIsUsed" : false
  } ]
}
```

The following is a coding example when an iSCSI port is used:

```
{
  "data" : [ {
    "portId" : "CL2-D",
    "externalSerialNumber" : "477777",
    "externalStorageInfo" : "HITACHI VSP Gx00",
    "externalPathMode" : "Multi",
    "externalIsUsed" : true,
    "iscsiIpAddress" : "192.0.1.100",
  } ]
}
```

```

"iscsiName" : "iqn.rest.example.of.iscsi1",
"virtualPortId" : 0
} ]
}

```

Attribute	Type	Description
portId	string	Number of the port on the local storage system
externalWwn	string	WWN of the port on the external storage system This attribute is displayed when a Fibre Channel port is used.
iscsiIpAddress	string	IP address of the iSCSI target on the external storage system This attribute is displayed when an iSCSI port is used.
iscsiName	string	Name of the iSCSI target on the external storage system This attribute is displayed when an iSCSI port is used.
virtualPortId	int	Virtual port ID This attribute is displayed when an iSCSI port is used and virtual port mode is enabled.
externalSerialNumber	string	Serial number of the external storage system
externalStorageInfo	string	The vendor information and product ID of the external storage system This information is obtained in a format in which the vendor information and product ID are concatenated by a space.
externalPathMode	string	Path mode for the external path of the port on the external storage system <ul style="list-style-type: none"> ▪ Multi: Multi mode ▪ Single: Single mode ▪ APLB: APLB mode

Attribute	Type	Description
externallsUsed	boolean	Whether the port of the external storage system that is externally connected to the local storage system is being used to map external volumes <ul style="list-style-type: none"> ▪ true: Used ▪ false: Not used

Status codes

For details on the status codes of the request for this operation, see the description on HTTP status codes.

Coding example

```
curl -v -H "Accept:application/json" -H "Content-Type:application/json" -H
"Authorization:Session d7b673af189048468c5af9bcf3b66b6f" -X GET https://
192.0.2.100/ConfigurationManager/v1/objects/external-storage-ports?
portId=CL7-A
```

Getting a list of LUs defined for a port on an external storage system

The following request acquires a list of the LUs that are defined for the port on an external storage system that is externally connected to the local storage system.

Execution permission

Storage Administrator (View Only)

Request line

```
GET base-URL/v1/objects/external-storage-luns
```

Request message**Object ID**

None.

Query parameters

When a Fibre Channel port is used:

Parameter	Type	Filter Condition
portId	string	(Required) Number of the port on the local storage system
externalWwn	string	(Required) WWN of the port on the external storage system

When an iSCSI port is used:

Parameter	Type	Filter Condition
portId	string	(Required) Port number on the local storage system
iscsilpAddress	string	(Required) IP address of the iSCSI target on the external storage system
iscsiName	string	(Required) iSCSI name of the iSCSI target on the external storage system Specify this parameter in iqn or eui format.

Body

None.

Response message

Body

The following is a coding example when a Fibre Channel port is used:

```
{
  "data" : [ {
    "externalLun" : 0,
    "portId" : "CL7-A",
    "externalWwn" : "50060e80222fd141",
    "externalVolumeCapacity" : 62914560,
    "externalVolumeInfo" : "OPEN-V HITACHI 50412FD100CC"
  } ]
}
```

The following is a coding example when an iSCSI port is used:

```
{
  "data" : [ {
```

```

"externalLun" : 0,
"portId" : "CL7-A",
"externalVolumeCapacity" : 62914560,
"externalVolumeInfo" : "OPEN-V HITACHI 50412FD100CC",
"iscsiIpAddress" : "192.168.0.100",
"iscsiName" : "iqn.rest.example.of.iscsi1",
"virtualPortId" : 0
} ]
}

```

Attribute	Type	Description
portId	string	Number of the port on the local storage system
externalWwn	string	WWN of the port on the external storage system This attribute is displayed when a Fibre Channel port is used.
iscsiIpAddress	string	IP address of the iSCSI target on the external storage system This attribute is displayed when an iSCSI port is used.
iscsiName	string	Name of the iSCSI target on the external storage system This attribute is displayed when an iSCSI port is used.
virtualPortId	int	Virtual port ID This attribute is displayed when an iSCSI port is used and virtual port mode is enabled.
externalLun	int	LUN that can be referenced from the port on the external storage system
externalVolumeCapacity	long	Capacity of the external volume on the external storage system (1 block = 512 bytes)
externalVolumeInfo	string	The product ID and the device identification (output in ASCII format) in the SCSI information for the external volume on the external storage system

Attribute	Type	Description
		<p>This information is obtained in a format in which the product ID and the device identification are concatenated by a space.</p> <p>If the LU cannot be used as an external volume group, <code>OTHER</code> is output for the product ID.</p>

Status codes

For details on the status codes of the request for this operation, see the description on HTTP status codes.

Coding example

```
curl -v -H "Accept:application/json" -H "Content-Type:application/json" -H
"Authorization:Session d7b673af189048468c5af9bcf3b6bb6f" -X GET "https://
192.0.2.100/ConfigurationManager/v1/objects/external-storage-luns?
portId=CL7-A&externalWwn=50060e80222fd141"
```

Mapping an external volume

The following request creates an external parity group on the local storage system, and then registers (maps) volumes on an external storage system to the created external parity group. When a volume is mapped, the external path group and the external path are also created.



Important:

The API request for mapping an external volume can be used only when Fibre Channel ports are used. The request cannot be used when iSCSI ports are used.

If you are using an iSCSI port, use storage management software such as CCI. You can perform this operation by using the Platform REST API (Simple). For detailed information about this operation, see the [Hitachi Vantara Knowledge website](#).

Execution permission

Storage Administrator (Provisioning)

Request line

```
POST base-URL/v1/objects/external-parity-groups
```

Request message**Object ID**

None.

Query parameters

None.

Body

```
{
  "externalParityGroupId":"1-1",
  "externalPathGroupId":1,
  "portId":"CL7-A",
  "externalWwn":"50060e80222fd141",
  "lunId":0,
  "emulationType":"OPEN-V",
  "clprId":0
}
```

Attribute	Type	Description
externalParityGroupId	string	(Required) External parity group number Specify the number in <i>gno-sgno</i> format.
externalPathGroupId	int	(Required) External path group ID If the specified path group ID does not exist, a new path group ID will be created.
portId	string	(Required) Number of the port on the local storage system
externalWwn	string	(Required) WWN of the external storage system
lunId	int	(Required) LUN of the port on the external storage system
emulationType	string	(Optional) Emulation type Specifiable values are as follows:

Attribute	Type	Description
		<p>OPEN-3 , OPEN-8 , OPEN-9 , OPEN-E , OPEN-K , OPEN-L , OPEN-V , 3380-3 , 3380-3A , 3380-3B , 3380-3C , 3390-1 , 3390-2 , 3390-3 , 3390-A , 3390-3A , 3390-3B , 3390-3C , 3390-3R , 3390-9 , 3390-9A , 3390-9B , 3390-9C , 3390-L , 3390-LA , 3390-LB , 3390-LC , 3390-M , 3390-MA , 3390-MB , 3390-MC , 3390-V , 6586-G , 6586-J , 6586-K , 6586-KA , 6586-KB , 6586-KC , 6588-1 , 6588-3 , 6588-9 , 6588-A , 6588-3A , 6588-3B , 6588-3C , 6588-9A , 6588-9B , 6588-9C , 6588-L , 6588-LA , 6588-LB , 6588-LC</p> <p>If this attribute is omitted, OPEN-V is set.</p>
clprid	int	<p>(Optional) CLPR number to be used by the external parity group</p> <p>Specify a decimal (base 10) number in the range from 0 to 31.</p> <p>If this attribute is omitted, 0 is set.</p>
isExternalAttributeMigration	boolean	<p>(Optional) Whether to set the nondisruptive migration attribute for the external parity group</p> <ul style="list-style-type: none"> ▪ true: Set the attribute. ▪ false: Do not set the attribute <p>If this attribute is omitted, false is set.</p>
commandDeviceLdevId	int	<p>(Optional) LDEV number of the remote command device</p> <p>Specify this attribute if you want to map the command device of the external storage system.</p> <p>The specified LDEV number is assigned to the remote command device.</p>

Response message**Body**

A job object is returned. For details on attributes other than `affectedResources`, see the section explaining job objects. To check whether the execution results of this API request have been correctly applied, execute the API request for getting information about the external paths.

Attribute	Description
<code>affectedResources</code>	URL of the mapped external parity group

Status codes

For details on the status codes of the request for this operation, see the description on HTTP status codes.

Coding example

```
curl -v -H "Accept:application/json" -H "Content-Type:application/json" -H
"Authorization:Session d7b673af189048468c5af9bcf3b66b6f" -X POST --data-
binary @./InputParameters.json https://192.0.2.100/ConfigurationManager/v1/
objects/external-parity-groups
```

Getting a list of external path groups

The following request obtains a list of information about external path groups. It also obtains information about the related external parity groups and external paths.

Depending on the number of resources for which information is to be obtained, you might have to run this API request more than once to obtain information about all of those resources. In such cases, each time you run the request, if information was not obtained for one or more external path groups, the attribute `nextPageHeadPathGroupId` in the response body indicates the ID of the first external path group for which information was not obtained. To obtain information about the remaining external path groups, run the API request with the path group ID indicated by `nextPageHeadPathGroupId` specified for the parameter `headPathGroupId` in the query. If information was obtained for all target resources, the attribute `nextPageHeadPathGroupId` returns the value `-1`.

**Important:**

- The API request for getting a list of external path groups can be used only when Fibre Channel ports are used. The request cannot be used when iSCSI ports are used.

If you are using an iSCSI port, use storage management software such as CCI. You can perform this operation by using the Platform REST API (Simple). For detailed information about this operation, see the [Hitachi Vantara Knowledge](#) website.

- the number of concurrent executions of this API request might be limited depending on the number of paths in the external path groups for which information is to be obtained or depending on the other processing being executed at the same time. For details on this limitation and the conditions under which the limitation applies, see the note on the number of concurrent executions.

Execution permission

Storage Administrator (View Only)

Request line

```
GET base-URL/v1/objects/external-path-groups
```

Request message**Object ID**

None.

Query parameters

Parameter	Type	Filter Condition
externalParityGroupId	string	(Optional) External parity group number Specify the number in <i>gno-sgno</i> format. You cannot specify this parameter and the <code>ldevId</code> parameter at the same time.
ldevId	string	(Optional) LDEV number You cannot specify this parameter and the <code>externalParityGroupId</code> parameter at the same time.
headPathGroupId	int	(Optional) ID of the first external path group of the external path groups for which information is to be obtained

Parameter	Type	Filter Condition
		If you want to specify a range of external path groups for which to information is to be obtained, specify the ID of the first external path group in the target range.

Body

None.

Response message**Body**

```
{
  "data": [
    {
      "externalPathGroupId": 0,
      "externalSerialNumber": "91110309",
      "externalProductId": "HUS",
      "externalParityGroups": [
        {
          "externalParityGroupId": "1-1",
          "externalParityGroupStatus": "BLK",
          "cacheMode": "D",
          "isInflowControlEnabled": false,
          "mpBladeId": 0,
          "loadBalanceMode": "N",
          "pathMode": "M",
          "isDataDirectMapping": false,
          "externalLuns": [
            {
              "portId": "CL5-B",
              "externalWwn": "50060e8010539b51",
              "priority": 1,
              "externalLun": 0,
              "pathStatus": "BLK"
            }
          ]
        }
      ],
    },
    {
      "externalParityGroupId": "1-12",
      "externalParityGroupStatus": "BLK",
      "cacheMode": "E",
      "isInflowControlEnabled": false,
      "mpBladeId": 2,
      "loadBalanceMode": "N",
    }
  ]
}
```

```

        "pathMode": "M",
        "isDataDirectMapping": false,
        "externalLuns": [
            {
                "portId": "CL5-B",
                "externalWwn": "50060e8010539b51",
                "priority": 1,
                "externalLun": 19,
                "pathStatus": "BLK"
            }
        ]
    },
    ],
    "externalPaths": [
        {
            "portId": "CL5-B",
            "externalWwn": "50060e8010539b51"
        }
    ],
    "nextPageHeadPathGroupId": -1
},
{
    "externalPathGroupId": 1,
    "externalSerialNumber": "210945",
    "externalProductId": "HUS VM",
    "externalParityGroups": [
        {
            "externalParityGroupId": "1-2",
            "externalParityGroupStatus": "NML",
            "cacheMode": "D",
            "isInflowControlEnabled": false,
            "mpBladeId": 1,
            "loadBalanceMode": "N",
            "pathMode": "M",
            "isDataDirectMapping": false,
            "externalLuns": [
                {
                    "portId": "CL5-B",
                    "externalWwn": "50060e80132ac120",
                    "priority": 1,
                    "externalLun": 21,
                    "pathStatus": "NML"
                }
            ]
        }
    ],
},
{
    "externalParityGroupId": "1-23",
    "externalParityGroupStatus": "NML",
    "cacheMode": "E",

```

```

    "isInflowControlEnabled": false,
    "mpBladeId": 2,
    "loadBalanceMode": "N",
    "pathMode": "M",
    "isDataDirectMapping": false,
    "externalLuns": [
      {
        "portId": "CL5-B",
        "externalWwn": "50060e80132ac120",
        "priority": 1,
        "externalLun": 32,
        "pathStatus": "NML"
      }
    ]
  },
  ],
  "externalPaths": [
    {
      "portId": "CL5-B",
      "externalWwn": "50060e80132ac120"
    }
  ],
  "nextPageHeadPathGroupId": -1
}
]
}

```

Attribute	Type	Description
externalPathGroupId	int	External path group number
externalSerialNumber	string	Serial number of the external storage system
externalProductId	string	Product ID of the external storage system

Attribute	Type	Description
externalParityGroups	object[]	<p>The following attributes are output for each external parity group:</p> <ul style="list-style-type: none"> ▪ externalParityGroupId (string) External parity group number ▪ externalParityGroupStatus (string) Status of the external parity group <ul style="list-style-type: none"> ▪ NML: Normal ▪ CHK: The mapping path status is being checked ▪ SYN: Data in the cache is being written to the volume ▪ DSC: The parity group is disconnected from the external storage system or the external volumes ▪ BLK: The mapping path is blocked ▪ WAR: The status of the mapping path is not normal ▪ Unknown: Unknown ▪ cacheMode (string) Cache mode <ul style="list-style-type: none"> ▪ E: Enabled ▪ D: Disabled <p>For an external parity group that has the nondisruptive migration attribute, the following values are output:</p> <ul style="list-style-type: none"> ▪ EM: Enabled ▪ DM: Disabled ▪ TM: Through ▪ SM: Synchronized writing

Attribute	Type	Description
		<ul style="list-style-type: none"> ▪ <code>isInflowControlEnabled</code> (boolean) Inflow cache control <ul style="list-style-type: none"> ▪ <code>true</code>: Enabled ▪ <code>false</code>: Disabled ▪ <code>mpBladeId</code> (int) MP blade ID ▪ <code>loadBalanceMode</code> (string) The load balancing method for I/O operations for the external storage system <ul style="list-style-type: none"> ▪ <code>N</code>: Standard round-robin method ▪ <code>E</code>: Expanded round-robin method ▪ <code>D</code>: I/O is performed over a single path, and load balancing is not used ▪ <code>pathMode</code> (string) Path mode of the external storage system <ul style="list-style-type: none"> ▪ <code>M</code>: Multi mode ▪ <code>S</code>: Single mode ▪ <code>A</code>: APLB mode ▪ <code>AL</code>: ALUA mode ▪ <code>MA</code>: Multi mode (in a state in which the mode can be changed to the ALUA mode) ▪ <code>SA</code>: Single mode (in a state in which the mode can be changed to the ALUA mode)

Attribute	Type	Description
		<ul style="list-style-type: none"> ▪ <code>isDataDirectMapping</code> (boolean) Whether the data direct mapping attribute is enabled <ul style="list-style-type: none"> ▪ <code>true</code>: Enabled ▪ <code>false</code>: Disabled ▪ <code>externalLuns</code> (object[]) The following attributes are output for each LU on the external storage system: <ul style="list-style-type: none"> • <code>portId</code> (string) Port number • <code>externalWwn</code> (string) WWN of the external storage system • <code>priority</code> (int) Priority within the external path group • <code>externalLun</code> (int) LUN within the ports of the external storage system • <code>pathStatus</code> (string) Status of the external path NML: Normal CHK: Temporarily blocked (The status of the external path is being checked.) BLK: Blocked DSC: Disconnected Unknown: Unknown
<code>externalPaths</code>	<code>object[]</code>	<p>The following attributes are output for each external path:</p> <ul style="list-style-type: none"> ▪ <code>portId</code> (string) Port number ▪ <code>externalWwn</code> (string) WWN of the external storage system

Attribute	Type	Description
		<ul style="list-style-type: none"> ▪ <code>qDepth</code> (int) Number of Read/Write commands that can be queued to the external parity group This information is obtained only when the <code>qDepth</code> attribute is set. ▪ <code>ioTimeOut</code> (int) The value (in seconds) set for the I/O time over for the external parity group This information is obtained only when the <code>ioTimeOut</code> attribute is set. ▪ <code>blockedPathMonitoring</code> (int) The time (in seconds) until the external parity group is blocked after all paths to the external parity group are disconnected This information is obtained only when the <code>blockedPathMonitoring</code> attribute is set.
<code>nextPageHeadPathGroupId</code>	int	<p>ID of the first external path group for which information was not obtained</p> <p>If you were not able to obtain information about all target external path groups by a single execution of the request, you can obtain information about the remaining external path groups by running the request again, with this value specified for the parameter <code>headPathGroupId</code> in the query.</p> <p>If information was obtained about all target external path groups, the value <code>-1</code> is output.</p>

Status codes

For details on the status codes of the API, see the description on HTTP status codes.

Coding example

```
curl -v -H "Accept:application/json" -H "Content-Type:application/json" -H
"Authorization:Session d7b673af189048468c5af9bcf3bbbb6f" -X GET https://
192.0.2.100/ConfigurationManager/v1/objects/external-path-groups
```

Note on the number of concurrent executions

The number of concurrent executions of this API request might be limited depending on the number of paths in the external path groups for which information is to be obtained or depending on the other processing being executed at the same time.

The number of concurrent executions can be affected by the following:

- Processing to get a list of resource groups
- Processing to get information about multiple LDEVs
- Processing to get port information (when executed with `detailInfoType=logins` specified in the query)
- Processing to get information about host groups or iSCSI targets
- Processing to get information about global-active device pairs
- Processing to get information about a specific external path group

Refer to the information below to estimate the maximum number of concurrent requests for getting a list of external path groups if one or more of the above processing is in progress.

Processing being executed	Maximum number of requests that can be executed concurrently (expected number of resources for which information can be obtained)
None	13 (Number of paths in the external path groups: less than 10,240)
None	4 (Number of paths in the external path groups: 10,240 or more)
Processing to get LDEV information (Number of LDEVs: 16,384) × 1	9 (Number of paths in the external path groups: less than 10,240)
Processing to get LDEV information (Number of LDEVs: 16,384) × 1	1 (Number of paths in the external path groups: 10,240 or more)

Getting information about a specific external path group

The following request acquires information about a specified external path group and the external parity groups and external paths that are related to the specified external path group.

**Important:**

- The API request for getting information about a specific external path group can be used only when Fibre Channel ports are used. The request cannot be used when iSCSI ports are used.

If you are using an iSCSI port, use storage management software such as CCI. You can perform this operation by using the Platform REST API (Simple). For detailed information about this operation, see the [Hitachi Vantara Knowledge](#) website.

- the number of concurrent executions of this API request might be limited depending on the number of paths in the external path groups for which information is to be obtained or depending on the other processing being executed at the same time. For details on this limitation and the conditions under which the limitation applies, see the note on the number of concurrent executions for the API for getting a list of external path groups.

Execution permission

Storage Administrator (View Only)

Request line

```
GET base-URL/v1/objects/external-path-groups/object-ID
```

Request message**Object ID**

Specify the value of `externalPathGroupId` that was obtained by the request to get information about the external path group.

Attribute	Type	Description
externalPathGroupId	int	(Required) External path group number

Query parameters

None.

Body

None.

Response message**Body**

```
{
  "externalPathGroupId": 1,
  "externalSerialNumber": "210945",
```

```

"externalProductId": "HUS VM",
"externalParityGroups": [
  {
    "externalParityGroupId": "1-2",
    "externalParityGroupStatus": "NML",
    "cacheMode": "D",
    "mpBladeId": 1,
    "loadBalanceMode": "N",
    "pathMode": "M",
    "externalLuns": [
      {
        "portId": "CL5-B",
        "externalWwn": "50060e80132ac120",
        "priority": 1,
        "externalLun": 21,
        "pathStatus": "NML"
      }
    ],
    "isInflowControlEnabled": false,
    "isDataDirectMapping": false
  },
  {
    "externalParityGroupId": "1-23",
    "externalParityGroupStatus": "NML",
    "cacheMode": "E",
    "mpBladeId": 2,
    "loadBalanceMode": "N",
    "pathMode": "M",
    "externalLuns": [
      {
        "portId": "CL5-B",
        "externalWwn": "50060e80132ac120",
        "priority": 1,
        "externalLun": 32,
        "pathStatus": "NML"
      }
    ],
    "isInflowControlEnabled": false,
    "isDataDirectMapping": false
  }
],
"externalPaths": [
  {
    "portId": "CL5-B",
    "externalWwn": "50060e80132ac120"
  }
]
}

```

Attribute	Type	Description
externalPathGroupId	int	External path group number
externalSerialNumber	string	Serial number of the external storage system
externalProductId	string	Product ID of the external storage system
externalParityGroups	object[]	<p>The following attributes are output for each external parity group:</p> <ul style="list-style-type: none"> ▪ externalParityGroupId (string) External parity group number ▪ externalParityGroupStatus (string) Status of the external parity group <ul style="list-style-type: none"> ▪ NML: Normal ▪ CHK: The mapping path status is being checked ▪ SYN: Data in the cache is being written to the volume ▪ DSC: The external parity group is disconnected from the external storage system or the external volume ▪ BLK: The mapping path is blocked ▪ WAR: The status of the mapping path is not normal ▪ Unknown: Unknown

Attribute	Type	Description
		<ul style="list-style-type: none"> ▪ cacheMode (string) Cache mode <ul style="list-style-type: none"> ▪ E: Enabled ▪ D: Disabled <p>For an external parity group that has the nondisruptive migration attribute, the following values are output:</p> <ul style="list-style-type: none"> ▪ EM: Enabled ▪ DM: Disabled ▪ TM: Through ▪ SM: Synchronized writing ▪ isInflowControlEnabled (boolean) Inflow cache control <ul style="list-style-type: none"> ▪ true: Enabled ▪ false: Disabled ▪ mpBladeId (int) MP blade ID ▪ loadBalanceMode (string) The load balancing method for I/O operations for the external storage system <ul style="list-style-type: none"> ▪ N: Standard round-robin method ▪ E: Expanded round-robin method ▪ D: I/O is performed over a single path, and load balancing is not used

Attribute	Type	Description
		<ul style="list-style-type: none"> ▪ pathMode (string) Path mode of the external storage system <ul style="list-style-type: none"> ▪ M: Multi mode ▪ S: Single mode ▪ A: APLB mode ▪ AL: ALUA mode ▪ MA: Multi mode (E) ▪ SA: Single mode (in a state in which the mode can be changed to the ALUA mode)

Attribute	Type	Description
		<ul style="list-style-type: none"> ▪ <code>isDataDirectMapping</code> (boolean) Whether the data direct mapping attribute is enabled <ul style="list-style-type: none"> ▪ <code>true</code>: Enabled ▪ <code>false</code>: Disabled ▪ <code>externalLuns</code> (object[]) The following attributes are output for each LU on the external storage system: <ul style="list-style-type: none"> • <code>portId</code> (string) Port number • <code>externalWwn</code> (string) WWN of the external storage system • <code>priority</code> (int) Priority within the external path group • <code>externalLun</code> (int) LUN within the ports of the external storage system • <code>pathStatus</code> (string) Status of the external path NML: Normal CHK: Temporarily blocked (The status of the external path is being checked.) BLK: Blocked DSC: Disconnected Unknown: Unknown
<code>externalPaths</code>	<code>object[]</code>	<p>The following attributes are displayed for each external path:</p> <ul style="list-style-type: none"> ▪ <code>portId</code> (string) Port number ▪ <code>externalWwn</code> (string) WWN of the external storage system

Attribute	Type	Description
		<ul style="list-style-type: none"> <li data-bbox="852 256 1424 499"> ▪ <code>qDepth</code> (int) Number of Read/Write commands that can be queued to the external parity group This information is obtained only when the <code>qDepth</code> attribute is set. <li data-bbox="852 508 1424 718"> ▪ <code>ioTimeout</code> (int) The value (in seconds) set for the I/O time over for the external parity group This information is obtained only when the <code>ioTimeout</code> attribute is set. <li data-bbox="852 726 1424 1033"> ▪ <code>blockedPathMonitoring</code> (int) The time (in seconds) until the external parity group is blocked after all paths to the external parity group are disconnected This information is obtained only when the <code>blockedPathMonitoring</code> attribute is set.

Status codes

For details on the status codes of the API, see the description on HTTP status codes.

Coding example

```
curl -v -H "Accept:application/json" -H "Content-Type:application/json" -H "Authorization:Session d7b673af189048468c5af9bcf3b6bb6f" -X GET https://192.0.2.100/ConfigurationManager/v1/objects/external-path-groups/1
```

Adding an external path to an external path group

The following request adds external path information to an existing external path group. The priority of the path is set in ascending order, according to the order in which the path was added.

Execution permission

Storage Administrator (Provisioning)

Request line

```
POST base-URL/v1/objects/external-path-groups/object-ID/actions/add-path/
invoke
```

Request message**Object ID**

Specify the value of `externalPathGroupId` that was obtained by the request to get information about the external path group.

Attribute	Type	Description
<code>externalPathGroupId</code>	int	(Required) External path group number

Query parameters

None.

Body

The following is a coding example when a Fibre Channel port is used:

```
{
  "parameters": {
    "portId": "CL7-A",
    "externalWwn": "50060E801033C2F0"
  }
}
```

When a Fibre Channel port is used:

Attribute	Type	Description
<code>portId</code>	string	(Required) Number of the port on the local storage system
<code>externalWwn</code>	string	(Required) WWN of the external storage system

The following is a coding example when an iSCSI port is used:

```
{
  "parameters": {
    "portId": "CL1-C",
    "iscsiIpAddress": "192.168.0.100",
    "iscsiName": "iqn.rest.example.of.iscsi1"
  }
}
```

```
}
}
```

When an iSCSI port is used:

Attribute	Type	Description
portId	string	(Required) Port number on the local storage system
iscsilpAddress	string	(Required) IP address of the iSCSI target on the external storage system Specify an IPv4 or IPv6 address.
iscsiName	string	(Required) iSCSI name of the iSCSI target on the external storage system Specify this attribute in iqn or eui format.

Response message

Body

A job object is returned. For details on attributes other than `affectedResources`, see the section explaining job objects.

Attribute	Description
affectedResources	<ul style="list-style-type: none"> When a Fibre Channel port is used: The URL of the external path group to which the external path was added is returned. When an iSCSI port is used: <code>affectedResources</code> is not displayed for this API. To check whether the external path was added to the external path group, use storage management software such as CCI. You can perform this operation by using the Platform REST API (Simple). For detailed information about this operation, see the Hitachi Vantara Knowledge website.

Action template

None.

Status codes

For details on the status codes of the request for this operation, see the description on HTTP status codes.

Coding example

```
curl -v -H "Accept:application/json" -H "Content-Type:application/json" -H
"Authorization:Session d7b673af189048468c5af9bcf3b66b6f" -X POST --data-
binary @./InputParameters.json https://192.0.2.100/ConfigurationManager/v1/
objects/external-path-groups/1/actions/add-path/invoke
```

Removing an external path from an external path group

The following request removes external path information from an external path group.

Execution permission

Storage Administrator (Provisioning)

Request line

```
POST base-URL/v1/objects/external-path-groups/object-ID/actions/remove-
path/invoke
```

Request message**Object ID**

Specify the value of `externalPathGroupId` that was obtained by the request to get information about the external path group.

Attribute	Type	Description
<code>externalPathGroupId</code>	int	(Required) External path group number

Query parameters

None.

Body

The following is a coding example when a Fibre Channel port is used:

```
{
  "parameters": {
    "portId": "CL7-A",
    "externalWwn": "50060E801033C2F0"
  }
}
```

```
}
}
```

When a Fibre Channel port is used:

Attribute	Type	Description
portId	string	(Required) Number of the port on the local storage system
externalWwn	string	(Required) WWN of the external storage system

The following is a coding example when an iSCSI port is used:

```
{
  "parameters": {
    "portId": "CL1-C",
    "iscsiIpAddress": "192.168.0.100",
    "iscsiName": "iqn.rest.example.of.iscsi1"
  }
}
```

When an iSCSI port is used:

Attribute	Type	Description
portId	string	(Required) Port number on the local storage system
iscsiIpAddress	string	(Required) IP address of the iSCSI target on the external storage system Specify an IPv4 or IPv6 address.
iscsiName	string	(Required) iSCSI name of the iSCSI target on the external storage system Specify this attribute in iqn or eui format.

Response message

Body

A job object is returned. For details on attributes other than `affectedResources`, see the section explaining job objects.

Attribute	Description
affectedResources	<ul style="list-style-type: none"> <li data-bbox="686 262 1424 380">▪ When a Fibre Channel port is used: The URL of the external path group from which the external path was removed is returned. <li data-bbox="686 415 1424 716">▪ When an iSCSI port is used: <code>affectedResources</code> is not displayed for this API. To check whether the external path was removed from the external path group, use storage management software such as CCI. You can perform this operation by using the Platform REST API (Simple). For detailed information about this operation, see the Hitachi Vantara Knowledge website.

Action template

None.

Status codes

For details on the status codes of the request for this operation, see the description on HTTP status codes.

Coding example

```
curl -v -H "Accept:application/json" -H "Content-Type:application/json" -H
"Authorization:Session d7b673af189048468c5af9bcf3b66b6f" -X POST --data-
binary @./InputParameters.json https://192.0.2.100/ConfigurationManager/v1/
objects/external-path-groups/1/actions/remove-path/invoke
```

Unmapping an external volume

The following request unmaps an external volume by deleting the external parity group. If the last external parity group is deleted, the external path group itself is also deleted.

Execution permission

Storage Administrator (Provisioning)

Request line

```
DELETE base-URL/v1/objects/external-parity-groups/object-ID
```

Request message**Object ID**

Specify the value of `externalParityGroupId` that was obtained by the processing to get information about the external path group.

Attribute	Type	Description
<code>externalParityGroupId</code>	string	(Required) External parity group number

Query parameters

None.

Body

```
{
  "force": true
}
```

Attribute	Type	Description
<code>force</code>	boolean	<p>(Optional) Specify whether to forcibly unmap the external volume without destaging it.</p> <p>Specify <code>true</code> to unmap the external volume without destaging it.</p> <ul style="list-style-type: none"> ▪ <code>true</code>: Forcibly unmap the external volume. ▪ <code>false</code>: Unmap the external volume only if the external volume has been destaged. <p>If this attribute is omitted, <code>false</code> is set.</p> <p>If you specify <code>false</code>, first execute the API function to disconnect the external volume.</p>

Response message**Body**

A job object is returned. See the description for the job object. `affectedResources` is not displayed for this API. To check whether the unmapping was successful, execute the API request for getting information about an external path group.

Status codes

For details on the status codes of the request for this operation, see the description on HTTP status codes.

Coding example

```
curl -v -H "Accept:application/json" -H "Content-Type:application/json" -H
"Authorization:Session d7b673af189048468c5af9bcf3bbbb6f" -X DELETE
https://192.0.2.100/ConfigurationManager/v1/objects/external-parity-
groups/1-1
```

Disconnecting from an external volume

The following request disconnects an external volume on an external storage system from the local storage system. The external volume is not unmapped.

Execution permission

Storage Administrator (Provisioning)

Request line

```
POST base-URL/v1/objects/external-parity-groups/object-ID/actions/
disconnect/invoke
```

Request message**Object ID**

Specify the value of `externalParityGroupId` that was obtained by the processing to get information about the external path group.

Attribute	Type	Description
<code>externalParityGroupId</code>	string	(Required) External parity group number

Query parameters

None.

Body

None.

Response message

Body

A job object is returned. See the description for the job object. `affectedResources` is not displayed for this API function. To check whether the disconnection was successful, check the status of the external path by executing the API function for getting information about an external path group.

Action template

None.

Status codes

For details on the status codes of the request for this operation, see the description of HTTP status codes.

Coding example

```
curl -v -H "Accept:application/json" -H "Content-Type:application/json" -H "Authorization:Session d7b673af189048468c5af9bcf3b6666f" -X POST https://192.0.2.100/ConfigurationManager/v1/objects/external-parity-groups/1-1/actions/disconnect/invoke -d ""
```

Deleting an iSCSI name of an external storage system that is registered to a port on the local storage system

This request deletes information about an iSCSI name (on the external storage system) that is registered to the local storage system.



Note:

- 0 is assumed for the virtual port ID if virtual port mode is enabled for the local storage system.

Execution permission

Storage Administrator (Provisioning)

Request line

```
POST base-URL/v1/objects/iscsi-ports/object-ID/actions/remove/invoke
```

Request message

Object ID

Specify the value of `portId` that was obtained by the processing to get information about ports.

Attribute	Type	Description
portId	string	(Required) Port number of the local storage system

Query parameters

None.

Body

```
{
  "parameters": {
    "iscsiIpAddress": "192.168.0.100",
    "iscsiName": "iqn.rest.example.of.iscsi1"
  }
}
```

Attribute	Type	Description
iscsiIpAddress	string	(Required) IP address of the iSCSI target on the external storage system Specify an IPv4 or IPv6 IP address.
iscsiName	string	(Required) iSCSI name of the iSCSI target on the external storage system Specify the name in iqn or eui format. This attribute is case sensitive.

Response message

A job object is returned. For details about attributes other than `affectedResources`, see the description of job objects.

Attribute	Description
affectedResources	URL of the port (on the local storage system) whose iSCSI name information about the external storage system has been deleted

Action template

None.

Status codes

For details about the status codes of the request for this operation, see the description of HTTP status codes.

Coding example

```
curl -v -H "Accept:application/json" -H "Content-Type:application/json" -H "Authorization:Session f76884c29fff4dfaa664aa6981087b71" -X POST "https://192.0.2.100/ConfigurationManager/v1/objects/iscsi-ports/CL1-A/actions/remove/invoke"
```

Chapter 15: Initial settings for a storage system

This chapter describes the initial settings for a storage system that are performed by using the REST API.

Overview of the initial settings of a storage system

This section describes the operations that can be performed by using the REST API, related to the initial settings of a storage system.

Initial setup operations that can be performed in the REST API

- Setting the system date and time for a storage system
Set the system date and time for a storage system.
- Setting the transfer destinations for audit log files
Specify settings related to the transfer of audit log files from a storage system to the syslog servers. You can also upload to the storage system the certificate files that are required when SSL communication is used to transfer audit log files between a storage system and the syslog servers.
- Setting the SNMP notification destinations
Specify settings related to reporting error information (SIM) of a storage system by using SNMP.
- Setting error notification emails
Specify settings related to reporting error information (SIM) of a storage system by using emails.
- License management
Set software licenses.

Related manuals

For details about the initial settings of the storage system, see the following manuals.

- *System Administrator Guide*
- *Hitachi SNMP Agent User Guide*

Getting the system date and time of a storage system

The following request gets the system date and time of a storage system.

Execution permission

Storage Administrator (View Only)

Request lineGET *base-URL/v1/objects/date-times/instance***Request message****Object ID**Specify *instance*.

If an object has only one instance, the *instance* is the fixed value that specifies the object ID.

Query parameters

None.

Body

None.

Response message**Body**

```
{
  "isNtpEnabled": true,
  "ntpServerNames": [
    "192.0.2.200"
  ],
  "timeZoneId": "America/Los_Angeles",
  "systemTime": "2016-07-20T17:02:12Z",
  "synchronizingLocalTime": "22:00",
  "adjustsDaylightSavingTime": true
}
```

Attribute	Type	Description
isNtpEnabled	boolean	Whether to synchronize the time with the NTP server <ul style="list-style-type: none"> <code>true</code>: Synchronize the time with the NTP server <code>false</code>: Do not synchronize the time with the NTP server
ntpServerNames	string[]	The IP address or host name of the NTP server

Attribute	Type	Description
		This attribute is displayed if the time is synchronized with the NTP server.
timeZoneId	string	Time zone ID
systemTime	ISO8601 string	System date and time (UTC)
synchronizingLocalTime	string	Synchronization time with the NTP server (local time) This attribute is displayed if the time is synchronized with the NTP server.
adjustsDaylightSavingTime	boolean	Whether to automatically adjust for daylight saving time This attribute is displayed if the time zone supports daylight saving time. <ul style="list-style-type: none"> ▪ <code>true</code>: Adjust for daylight saving time ▪ <code>false</code>: Do not adjust for daylight saving time

Status codes

The following table describes the meaning of the status code of the request for this operation. For details on other status codes, see the description of HTTP status codes.

Status code	Message	Description
412	Precondition Failed	The microcode version of the storage system does not support this operation.

Coding example

```
curl -v -H "Accept:application/json" -H "Content-Type:application/json" -H "Authorization:Session d7b673af189048468c5af9bcf3b66b6f" -X GET https://192.0.2.100/ConfigurationManager/v1/objects/date-times/instance
```

Getting a list of time zones that can be used in a storage system

The following request checks the time zones that can be used when you set the system date and time of a storage system or other information.

Execution permission

Storage Administrator (View Only)

Request line

```
GET base-URL/v1/objects/time-zones
```

Request message

Object ID

None.

Query parameters

None.

Body

None.

Response message

Body

```
{
  "data": [
    {
      "timeZoneId": "Etc/GMT+12",
      "timeZone": "(UTC-12:00)",
      "displayName": "International Date Line West",
      "observesDaylightSavingTime": false
    },
    {
      "timeZoneId": "Etc/GMT+11",
      "timeZone": "(UTC-11:00)",
      "displayName": "Coordinated Universal Time-11",
      "observesDaylightSavingTime": false
    },
    {
      "timeZoneId": "Pacific/Honolulu",
      "timeZone": "(UTC-10:00)",
      "displayName": "Hawaii",
      "observesDaylightSavingTime": false
    }
  ]
}
```



```

    }
  ]
}

```

Attribute	Type	Description
timeZoneId	string	Time zone ID
timeZone	string	Time zone
displayName	string	Displays the name of the time zone
observesDaylightSavingTime	boolean	Whether daylight saving time is supported <ul style="list-style-type: none"> ▪ <code>true</code>: Daylight saving time is supported. ▪ <code>false</code>: Daylight saving time is not supported.

Status codes

The following table describes the meaning of the status code of the request for this operation. For details on other status codes, see the description of HTTP status codes.

Status code	Message	Description
412	Precondition Failed	The microcode version of the storage system does not support this operation.

Coding example

```

curl -v -H "Accept:application/json" -H "Content-Type:application/json" -H
"Authorization:Session d7b673af189048468c5af9bcf3b6bb6f" -X GET https://
192.0.2.100/ConfigurationManager/v1/objects/time-zones

```

Setting the system date and time of a storage system

The following request sets the system date and time of a storage system.



Note:

If you locked any resources of the target storage system by using the REST API, you will not be able to use this API function. In such cases, unlock the resources before running the API function.

Execution permission

Storage Administrator (Initial Configuration)

Request linePATCH *base-URL/v1/objects/date-times/instance***Request message****Object ID**Specify *instance*.

If an object has only one instance, the *instance* is the fixed value that specifies the object ID.

Query parameters

None.

Body

```
{
  "isNtpEnabled": true,
  "ntpServerNames": [
    "192.0.2.200",
    "192.0.2.300"
  ],
  "timeZoneId": "America/Los_Angeles",
  "systemTime": "2016-07-20T17:02:12Z",
  "synchronizingLocalTime": "22:00",
  "adjustsDaylightSavingTime": true,
  "synchronizesNow": true
}
```

Attribute	Type	Description
isNtpEnabled	boolean	(Required) Whether to synchronize the time with the NTP server <ul style="list-style-type: none"> <code>true</code>: Synchronize the time with the NTP server <code>false</code>: Do not synchronize the time with the NTP server
ntpServerNames	string[]	(Optional) The IP address or host name of the NTP server

Attribute	Type	Description
		<p>You can specify this attribute only if <code>true</code> is specified for the <code>isNtpEnabled</code> attribute. If <code>true</code> is specified for the <code>isNtpEnabled</code> attribute, you must specify this attribute.</p> <p>If you specify multiple NTP servers, use commas to delimit the names. You can set a maximum of 5 NTP servers.</p>
timeZoneId	string	<p>(Required) Time zone ID</p> <p>Specify a time zone ID that you obtained by using the API function that obtains a list of available time zones for the storage system.</p>
systemTime	ISO8601 string	<p>(Required) System date and time (UTC)</p> <p>Specify a date between January 1, 2000 and December 31, 2037 in YYYY-MM-DDThh:mm:ssZ format.</p> <p>If the time zone specified for the <code>timeZoneId</code> attribute uses daylight saving time and the <code>adjustsDaylightSavingTime</code> attribute is set to <code>true</code>, you cannot set a time that is within the transition period of standard time to daylight saving time or the transition period of daylight saving time to standard time.</p> <p>The specified system date and time might be different from the date and time actually set on the storage system by several seconds. To set an accurate date and time, we recommend that you synchronize the date and time with the NTP server.</p>
synchronizingLocalTime	string	<p>(Optional) Synchronization time with the NTP server (local time)</p>

Attribute	Type	Description
		<p>You can specify this attribute only if <code>true</code> is specified for the <code>isNtpEnabled</code> attribute. Specify a time between <code>00:00</code> and <code>23:59</code> in "hh:mm" format.</p> <p>If this attribute is omitted, <code>00:00</code> is assumed to be set.</p>
adjustsDaylightSavingTime	boolean	<p>(Optional) Whether to automatically switch to daylight saving time</p> <p>You can specify this attribute only if the time zone specified for the <code>timeZoneId</code> attribute supports daylight saving time.</p> <p>You cannot specify this attribute if the specified time zone does not support daylight saving time. To check whether the time zone supports daylight saving time, you can use the API function that obtains a list of available time zones for the storage system.</p> <ul style="list-style-type: none"> ▪ <code>true</code>: Switch to daylight saving time ▪ <code>false</code>: Do not switch to daylight saving time <p>If this attribute is omitted, <code>true</code> is assumed to be set.</p>
synchronizesNow	boolean	<p>(Optional) Whether to immediately synchronize with the NTP server</p> <p>You can specify this attribute only when <code>true</code> is specified for the <code>isNtpEnabled</code> attribute.</p> <ul style="list-style-type: none"> ▪ <code>true</code>: Immediately synchronize with the NTP server ▪ <code>false</code>: Do not synchronize with the NTP server until the synchronization time

Attribute	Type	Description
		<p>If you specify <code>false</code> for this attribute, the time will be set as the time specified for the <code>systemTime</code> attribute until the time specified for the synchronization time of the <code>synchronizingLocalTime</code> attribute.</p> <p>If this attribute is omitted, <code>true</code> is assumed to be set.</p>

Response message

Body

```
{
  "isNtpEnabled": true,
  "ntpServerNames": [
    "192.0.2.200",
    "192.0.2.300"
  ],
  "timeZoneId": "America/Los_Angeles",
  "systemTime": "2016-07-20T17:02:12Z",
  "synchronizingLocalTime": "22:00",
  "adjustsDaylightSavingTime": true
}
```

Attribute	Type	Description
isNtpEnabled	boolean	<p>Whether to synchronize the time with the NTP server</p> <ul style="list-style-type: none"> ▪ <code>true</code>: Synchronize the time with the NTP server ▪ <code>false</code>: Do not synchronize the time with the NTP server
ntpServerNames	string[]	The IP address or host name of the NTP server
timeZoneId	string	Time zone ID
systemTime	ISO8601 string	System date and time (UTC)

Attribute	Type	Description
synchronizingLocalTime	string	Synchronization time with the NTP server (local time)
adjustsDaylightSavingTime	boolean	Whether to automatically switch to daylight saving time <ul style="list-style-type: none"> ▪ <code>true</code>: Switch to daylight saving time ▪ <code>false</code>: Do not switch to daylight saving time

Action template

None.

Status codes

The following table describes the meaning of the status code of the request for this operation. For details on other status codes, see the description of HTTP status codes.

Status code	Message	Description
412	Precondition Failed	The microcode version of the storage system does not support this operation.

Coding example

```
curl -v -H "Accept:application/json" -H "Content-Type:application/json" -H "Authorization:Session d7b673af189048468c5af9bcf3b6bb6f" -X PATCH --data-binary @./InputParameters.json https://192.0.2.100/ConfigurationManager/v1/objects/date-times/instance
```

Uploading the files required for initial configuration

The following request uploads the files required for the initial configuration of storage systems. The files are uploaded from a REST API client to the storage system. In the request header of this API function, specify `multipart/form-data` for Content-Type. For details about the initial configuration of storage systems, see the *System Administrator Guide*.

If SSL communication is used between the storage system and the syslog server, run this API function to upload the required certificate file to the storage system in advance. After that, run the API function for setting the transfer destinations of the audit log. When you do so, the storage system will be set to use the uploaded certificate file for communication.

**Important:**

- Only one file can be uploaded in one request.
- If files with the same `fileType` attribute are already uploaded, the currently uploaded file will be overwritten by the file to be uploaded.

Execution permission

Audit Log Administrator (View & Modify)

Request header

In this API, the request body is sent in the format of multipart/form-data. Specify `multipart/form-data` for the Content-Type of the request header.

Request line

```
POST base-URL/v1/objects/actions/file-upload/invoke
```

Request message**Object ID**

None.

Query parameters

None.

Body

Attribute	Type	Description
<code>fileType</code>	string	(Required) File type of the file to be uploaded

Attribute	Type	Description
		<p>The specifiable values are as follows:</p> <ul style="list-style-type: none"> ▪ AuditSyslogPrimaryClientCertFile: Client certificate file of the syslog server to which audit log files are to be transferred (for the primary server) ▪ AuditSyslogPrimaryRootCertFile: Root certificate file of the syslog server to which audit log files are to be transferred (for the primary server) ▪ AuditSyslogSecondaryClientCertFile: Client certificate file of the syslog server to which audit log files are to be transferred (for the secondary server) ▪ AuditSyslogSecondaryRootCertFile: Root certificate file of the syslog server to which audit log files are to be transferred (for the secondary server)
file	file	<p>(Required) File to be uploaded</p> <p>You can use the following characters:</p> <ul style="list-style-type: none"> ▪ Spaces ▪ Alphanumeric characters ▪ The following symbols: <p>! " # \$ % & ' () * + , - . : ; < = > ? @ [\] ^ _ ` { } ~</p>

Response message

Body

None.

Status codes

For details on the status codes of the request for this operation, see the description of HTTP status codes.

If HTTP status code 502 is returned, make sure the file is correctly specified, and then run the API request again.

Coding example

```
curl -v -H "Accept:application/json" -H "Content-Type: multipart/form-data" -H "Authorization:Session d7b673af189048468c5af9bcf3bbbb6f" -H "Expect:" -X POST -F "file=@C:\certfile.crt" -F "fileType=AuditSyslogPrimaryClientCertFile" https://192.0.2.100/ConfigurationManager/v1/objects/actions/file-upload/invoke
```

If you run a request in which `multipart/form-data` is specified for Content-Type, `Expect: 100-continue` might be automatically assigned to the header, depending on the specifications of the client software. Depending on the specifications of the web server, this header might not be accepted. If the header is not accepted, a 417 error occurs, and the request fails. In this coding example, the `Expect` header is specified to overwrite the automatically assigned header, thereby preventing this error.

Getting information about the transfer destinations of audit log files

The following request gets information, specified for a storage system, about the settings related to the transfer of audit log files to the syslog servers.

Execution permission

Audit Log Administrator (View Only)

Request line

```
GET base-URL/v1/objects/auditlog-syslog-servers/instance
```

Request message

Object ID

Specify `instance`.

If an object has only one instance, the `instance` is the fixed value that specifies the object ID.

Query parameters

None.

Body

None.

Response message

Body

```
{
  "transferProtocol": "TLS",
  "locationName": "886000123456",
  "retries": true,
  "retryInterval": 30,
  "isDetailed": true,
  "primarySyslogServer": {
    "isEnabled": true,
    "ipAddress": "192.0.1.100",
```

```

    "port": 12345
  },
  "secondarySyslogServer": {
    "isEnabled": true,
    "ipAddress": "192.0.1.200",
    "port": 12345
  }
}

```

Attribute	Type	Description
transferProtocol	string	Protocol to be used when transferring audit log files to the syslog servers <ul style="list-style-type: none"> ▪ TLS: TLS1.2/RFC5424 ▪ UDP: UDP/RFC3164
locationName	string	Name of the storage system from which audit log files are to be transferred
retries	boolean	Specifies whether to try again if communication with a syslog server fails This attribute is displayed if the <code>transferProtocol</code> attribute is <code>TLS</code> . <ul style="list-style-type: none"> ▪ <code>true</code>: Tries again ▪ <code>false</code>: Does not try again
retryInterval	int	Retry interval (in seconds) when communication with a syslog server fails This attribute is displayed if the <code>retries</code> attribute is <code>true</code> .
isDetailed	boolean	Specifies whether to transfer detailed information about audit log files to the syslog servers <ul style="list-style-type: none"> ▪ <code>true</code>: Transfers detailed information ▪ <code>false</code>: Does not transfer detailed information
primarySyslogServer	object	Settings of the primary-site syslog server

Attribute	Type	Description
		<p>The following information about the primary-site syslog server is displayed:</p> <ul style="list-style-type: none"> ▪ <code>isEnabled</code> (boolean) Whether audit log files are transferred to the syslog server <ul style="list-style-type: none"> ▪ <code>true</code>: Audit log files are transferred to the syslog server ▪ <code>false</code>: Audit log files are not transferred to the syslog server ▪ <code>ipAddress</code> (string) IP address This is displayed when the value of the <code>isEnabled</code> attribute is <code>true</code>. ▪ <code>port</code> (int) Port number This is displayed when the value of the <code>isEnabled</code> attribute is <code>true</code>.
secondarySyslogServer	object	Settings of the secondary-site syslog server

Attribute	Type	Description
		<p>The following information about the secondary-site syslog server is displayed:</p> <ul style="list-style-type: none"> ▪ <code>isEnabled</code> (boolean) Whether audit log files are transferred to the syslog server <ul style="list-style-type: none"> ▪ <code>true</code>: Audit log files are transferred to the syslog server ▪ <code>false</code>: Audit log files are not transferred to the syslog server ▪ <code>ipAddress</code> (string) IP address This is displayed when the value of the <code>isEnabled</code> attribute is <code>true</code>. ▪ <code>port</code> (int) Port number This is displayed when the value of the <code>isEnabled</code> attribute is <code>true</code>.

Status codes

For details on the status codes of the request for this operation, see the description of HTTP status codes.

Coding example

```
curl -v -H "Accept:application/json" -H "Content-Type:application/json" -H
"Authorization:Session d7b673af189048468c5af9bcf3b6bb6f" -X GET https://
192.0.2.100/ConfigurationManager/v1/objects/auditlog-syslog-servers/
instance
```

Specifying the transfer destinations of audit log files

The following request specifies settings related to the transfer of audit log files from a storage system to the syslog servers. Run this API function with `https` specified as the protocol to be used.

**Note:**

- If SSL communication is to be used to transfer audit log files between syslog servers, upload the necessary certificate files to the storage system before specifying the transfer destinations of audit log files.
- If you locked the resources of the target storage system by using the REST API, you will not be able to use the API function for specifying the transfer destinations of audit log files. In such cases, unlock the resources before running the API function.

Execution permission

Audit Log Administrator (View & Modify)

Request line

```
PATCH base-URL/v1/objects/auditlog-syslog-servers/instance
```

Request message**Object ID**

Specify *instance*.

If an object has only one instance, the *instance* is the fixed value that specifies the object ID.

Query parameters

None.

Body

```
{
  "transferProtocol": "TLS",
  "locationName": "886000123456",
  "retries": true,
  "retryInterval": 30,
  "isDetailed": true,
  "primarySyslogServer": {
    "isEnabled": true,
    "ipAddress": "192.0.1.100",
    "port": 12345,
    "clientCertFileName": "primaryClientCert.crt",
    "clientCertFilePassword": "123456",
    "rootCertFileName": "primaryRootCert.crt"
  },
  "secondarySyslogServer": {
    "isEnabled": true,
    "ipAddress": "192.0.1.200",
    "port": 12345,
    "clientCertFileName": "secondaryClientCert.crt",
```

```

"clientCertFilePassword": "123456",
"rootCertFileName": "secondaryRootCert.crt"
}
}

```

Attribute	Type	Description
transferProtocol	string	(Required) Protocol used when transferring audit log files to syslog servers Specify one of the following values: <ul style="list-style-type: none"> ▪ TLS: TLS1.2/RFC5424 ▪ UDP: UDP/RFC3164
locationName	string	(Required) Name of the storage system from which audit log files are to be transferred Specify a character string consisting of 1 to 32 characters. You can use the following characters: <ul style="list-style-type: none"> ▪ Alphanumeric characters ▪ The following symbols: ! " # \$ % & ' () * + - . / : ; < = > ? @ [\] ^ _ ` { } ~
retries	boolean	(Optional) Specify whether to try again if communication with a syslog server fails. If the <code>transferProtocol</code> attribute is <code>TLS</code> , specify either of the following values: <ul style="list-style-type: none"> ▪ <code>true</code>: Try again. ▪ <code>false</code>: Do not try again. If you omit this item, <code>true</code> is assumed.
retryInterval	int	(Optional) Retry interval (in seconds) if communication with a syslog server fails If the <code>retries</code> attribute is <code>true</code> , specify a value in the range from 1 to 60. If you omit this item, 1 will be set.
isDetailed	boolean	(Optional) Specify whether to transfer detailed information about audit log files to the syslog servers.

Attribute	Type	Description
		Specify one of the following values: <ul style="list-style-type: none">▪ <code>true</code>: Transfer detailed information.▪ <code>false</code>: Do not transfer detailed information. If you omit this item, <code>true</code> is assumed.
primarySyslogServer	object	(Required) Settings of the primary-site syslog server

Attribute	Type	Description
		<p>Specify values for the following attributes of the primary-site syslog server:</p> <ul style="list-style-type: none"> ▪ <code>isEnabled</code> (boolean) (Required) Specify whether audit log files are to be transferred to the syslog server. <ul style="list-style-type: none"> ▪ <code>true</code>: Transfer audit log files. ▪ <code>false</code>: Do not transfer audit log files. ▪ <code>ipAddress</code> (string) (Optional) IP address You must specify this attribute if <code>true</code> is specified for <code>isEnabled</code>. You can specify the address in either the IPv4 format or the IPv6 format. ▪ <code>port</code> (int) (Optional) Port number You must specify this attribute if <code>true</code> is specified for <code>isEnabled</code>. ▪ <code>clientCertFileName</code> (string) (Optional) Name of the client certificate file You must specify this attribute if <code>true</code> is specified for <code>isEnabled</code> and TLS is specified for <code>transferProtocol</code>. If you specify this attribute, the certificate file that was uploaded to the storage system will be set to be used. (The system will not check whether the file name of the certificate matches the file name specified for this attribute.) If a null character string is specified for this attribute, the certificate file that is already set for the storage system will be used. ▪ <code>clientCertFilePassword</code> (string) (Optional) Password for client certificate You must specify this attribute if <code>true</code> is specified for <code>isEnabled</code> and TLS is specified for <code>transferProtocol</code>. ▪ <code>rootCertFileName</code> (string) (Optional) File name for root certificate

Attribute	Type	Description
		<p>You must specify this attribute if <code>true</code> is specified for <code>isEnabled</code> and <code>TLS</code> is specified for <code>transferProtocol</code>. If you specify this attribute, the certificate file that was uploaded to the storage system will be set to be used. (The system will not check whether the file name of the certificate matches the file name specified for this attribute.) If a null character string is specified for this attribute, the certificate file that is already set for the storage system will be used.</p>
secondarySyslogServer	object	(Required) Settings of the secondary-site syslog server

Attribute	Type	Description
		<p>Specify values for the following attributes of the secondary-site syslog server:</p> <ul style="list-style-type: none"> ▪ <code>isEnabled</code> (boolean) (Required) Specify whether audit log files are to be transferred to the syslog server. <ul style="list-style-type: none"> ▪ <code>true</code>: Transfer audit log files. ▪ <code>false</code>: Do not transfer audit log files. ▪ <code>ipAddress</code> (string) (Optional) IP address You must specify this attribute if <code>true</code> is specified for <code>isEnabled</code>. You can specify the address in either the IPv4 format or the IPv6 format. ▪ <code>port</code> (int) (Optional) Port number You must specify this attribute if <code>true</code> is specified for <code>isEnabled</code>. ▪ <code>clientCertFileName</code> (string) (Optional) Name of the client certificate file You must specify this attribute if <code>true</code> is specified for <code>isEnabled</code> and TLS is specified for <code>transferProtocol</code>. If you specify this attribute, the certificate file that was uploaded to the storage system will be set to be used. (The system will not check whether the file name of the certificate matches the file name specified for this attribute.) If a null character string is specified for this attribute, the certificate file that is already set for the storage system will be used. ▪ <code>clientCertFilePassword</code> (string) (Optional) Password for client certificate You must specify this attribute if <code>true</code> is specified for <code>isEnabled</code> and TLS is specified for <code>transferProtocol</code>. ▪ <code>rootCertFileName</code> (string) (Optional) File name for root certificate

Attribute	Type	Description
		You must specify this attribute if <code>true</code> is specified for <code>isEnabled</code> and <code>TLS</code> is specified for <code>transferProtocol</code> . If you specify this attribute, the certificate file that was uploaded to the storage system will be set to be used. (The system will not check whether the file name of the certificate matches the file name specified for this attribute.) If a null character string is specified for this attribute, the certificate file that is already set for the storage system will be used.

Response message

Body

A job object is returned. For details on attributes other than `affectedResources`, see the description of job objects.

Attribute	Description
<code>affectedResources</code>	URL of the transfer destinations set for the audit log files of the storage system

Status codes

For details on the status codes of the request for this operation, see the description of HTTP status codes.

Coding example

```
curl -v -H "Accept:application/json" -H "Content-Type:application/json" -H
"Authorization:Session d7b673af189048468c5af9bcf3b6bb6f" -X PATCH --data-
binary @./InputParameters.json https://192.0.2.100/ConfigurationManager/v1/
objects/auditlog-syslog-servers/instance
```

Sending test messages to the transfer destinations of audit log files

The following request sends test messages to the syslog servers to verify that the settings related to the transfer destinations of audit log files are correctly specified.



Note:

If you locked the resources of the target storage system by using the REST API, you will not be able to use the API function for sending test messages. In such cases, unlock the resources before running the API function.

Execution permission

Audit Log Administrator (View & Modify)

Request line

```
POST base-URL/v1/objects/auditlog-syslog-servers/instance/actions/send-test/invoke
```

Request message

Object ID

Specify *instance*.

If an object has only one instance, the *instance* is the fixed value that specifies the object ID.

Query parameters

None.

Body

None.

Response message

Body

A job object is returned. For details on the schema of job objects, see the description of job objects.

Action template

None.

Status codes

For details on the status codes of the request for this operation, see the description of HTTP status codes.

Coding example

```
curl -v -H "Accept:application/json" -H "Content-Type:application/json" -H "Authorization:Session d7b673af189048468c5af9bcf3bbbb6f" -X POST https://192.0.2.100/ConfigurationManager/v1/objects/auditlog-syslog-servers/instance/actions/send-test/invoke -d ""
```

Getting SNMP settings

The following request explains how to obtain the SNMP settings for a storage system.

Execution permission

Storage Administrator (View Only)

Request line

```
GET base-URL/v1/objects/snmp-settings/instance
```

Request message

Object ID

Specify *instance*.

If an object has only one instance, the *instance* is the fixed value that specifies the object ID.

Query parameters

None.

Body

None.

Response message

Body

The following is an example of output when the SNMP version is SNMP v1:

```
{
  "isSNMPAgentEnabled": true,
  "snmpVersion": "v1",
  "sendingTrapSetting": {
    "snmpv1v2cSettings": [
      {
        "community": "MyRestSNMPCommunity1",
        "sendTrapTo": [
          "192.0.2.100",
          "192.0.2.200"
        ]
      }
    ]
  },
  "requestAuthenticationSetting": {
    "snmpv1v2cSettings": [
      {
```

```

    "community": "MyRestSNMPCommunity2",
    "requestsPermitted": [
      "192.0.3.100"
    ]
  }
]
},
"systemGroupInformation": {
  "storageSystemName": "VSP_G700",
  "contact": "confmanager@example.com",
  "location": "Data Center 1F"
},
"snmpEngineID": "0x80000074046361336663353061"
}

```

The following is an example of output when the SNMP version is SNMP v3:

```

{
  "isSNMPAgentEnabled": true,
  "snmpVersion": "v3",
  "sendingTrapSetting": {
    "snmpv3Settings": [
      {
        "userName": "MyRestSNMPUser1",
        "sendTrapTo": "192.0.2.100",
        "authentication": {
          "protocol": "SHA",
          "password": "",
          "encryption": {
            "protocol": "AES",
            "key": ""
          }
        }
      }
    ],
    {
      "userName": "MyRestSNMPUser2",
      "sendTrapTo": "192.0.2.200"
    }
  ]
},
  "requestAuthenticationSetting": {
    "snmpv3Settings": [
      {
        "userName": "MyRestSNMPUser3",
        "authentication": {
          "protocol": "MD5",
          "password": "",
          "encryption": {
            "protocol": "DES",

```

```

        "key": ""
      }
    }
  ]
},
"systemGroupInformation": {
  "storageSystemName": "VSP_G700",
  "contact": "confmanager@example.com",
  "location": "Data Center 1F"
},
"snmpEngineID": "0x80000074046361336663353061"
}

```

Attribute	Type	Description
isSNMPAgentEnabled	boolean	<p>Whether the SNMP Agent is enabled</p> <ul style="list-style-type: none"> ▪ true: Enabled ▪ false: Disabled <p>If this attribute is <code>true</code>, error information (SIM) is reported by SNMP traps. Also, SNMP operation requests (GET REQUEST, GETNEXT REQUEST, and GETBULK REQUEST) are received.</p>
snmpVersion	string	<p>SNMP version</p> <p>Outputs the SNMP version that is being used.</p> <ul style="list-style-type: none"> ▪ v1 : SNMP v1 ▪ v2c : SNMP v2c ▪ v3 : SNMP v3 <p>If this attribute is not set, <code>Unestablished</code> is output.</p>

Attribute	Type	Description
sendingTrapSetting	object	<p>SNMP trap destinations</p> <ul style="list-style-type: none"> ▪ snmpv1v2cSettings (object[]) <p>Array of settings for SNMP trap destinations</p> <p>This is output when there is a setting for which the SNMP version is SNMPv1 or SNMPv2c.</p> <ul style="list-style-type: none"> • community (string) <p>Community name used for SNMP trap reports</p> • sendTrapTo (string[]) <p>Array of IP addresses to which SNMP traps are sent</p> <p>The addresses are output in IPv4 or IPv6 IP.</p> ▪ snmpv3Settings (object[]) <p>Array of the settings for SNMP trap destinations</p> <p>This is output when there is a setting for which the SNMP protocol version is SNMP v3.</p> <ul style="list-style-type: none"> • userName (string) <p>User name that is used for SNMP trap reports</p> • sendTrapTo (string) <p>The IP address to which an SNMP trap is sent</p> <p>This is output in IPv4 or IPv6 format.</p> • authentication (object) <p>Authentication information</p> <p>This is output when password-based authentication is enabled. For details on the output attributes, see the table of the attributes output to the <code>authentication</code> attribute.</p>

Attribute	Type	Description
requestAuthenticationSetting	object	Settings for permitted requests.

Attribute	Type	Description
		<p>Settings for the permitted requests (GET REQUEST, GETNEXT REQUEST, and GETBULK REQUEST) of SNMP operations are output.</p> <ul style="list-style-type: none"> ▪ snmpv1v2cSettings (object[]) <p>Array of the settings for permitted requests</p> <p>This is output when there is a setting for which the SNMP protocol version is SNMPv1 or SNMPv2c.</p> <ul style="list-style-type: none"> • community (string) <p>Name of the community that receives requests</p> • requestsPermitted (string[]) <p>Array of the IP addresses of the SNMP Managers that receive requests</p> <p>This is output in IPv4 or IPv6 format. If the array is empty, requests of all SNMP Managers are received.</p> ▪ snmpv3Settings (object[]) <p>Array of the settings for permitted requests</p> <p>This is output when there is a setting for which the SNMP version is SNMP v3.</p> <ul style="list-style-type: none"> • userName (string) <p>Name of the user who receives requests</p> • authentication (object) <p>Authentication information</p> <p>This is output when password-based authentication is enabled. For details on the output attributes, see the table of the attributes output to the authentication attribute.</p>

Attribute	Type	Description
systemGroupInformation	object	Information of the system group <ul style="list-style-type: none"> ▪ storageSystemName (string) Name of the storage system ▪ contact (string) Contact information or name of the administrator ▪ location (string) Location of the storage system
snmpEngineID	string	ID identifying the SNMP engine

The following table shows the attributes output to the `authentication` attribute.

Attribute	Type	Description
protocol	string	Authentication method The following values are output: <ul style="list-style-type: none"> ▪ SHA ▪ MD5
password	string	Password An empty character string is output even if a password has been set.
encryption	object	Encryption information This is output when encryption is enabled. <ul style="list-style-type: none"> ▪ protocol (string) Encryption method The following values are output: <ul style="list-style-type: none"> ▪ AES ▪ DES ▪ key (string) Encryption key An empty character string is output even if an encryption key has been set.

Status codes

For details on the status codes of the request for this operation, see the description on HTTP status codes.

Coding example

```
curl -v -H "Accept:application/json" -H "Content-Type:application/json" -H
"Authorization:Session d7b673af189048468c5af9bcf3bbbb6f" -X GET https://
192.0.2.100/ConfigurationManager/v1/objects/snmp-settings/instance
```

Specifying the SNMP error notification destinations

The following request specifies settings related to reporting error information (SIM) of a storage system by using SNMP. Run this API function with `https` specified as the protocol to be used.

For details on SNMP, see the *Hitachi SNMP Agent User Guide*.

Notes on creating the request body

Before running this API function, obtain the current settings by using the API function that obtains SNMP information. The response body you have obtained is to be used as the request body for this API function. Change only the values of the attributes that you want to change. This API function overwrites all the specified values.

If you delete the information in the response body you have obtained, the setting is deleted.

**Note:**

- Null character values are output to the acquired response body for the `password` attribute and `key` attribute. Change the values only when you want to change the setting.
- You cannot change the setting for the `snmpEngineID` attribute. The value is ignored even if it is specified.
- If you locked any resources of the target storage system by using the REST API, you will not be able to use this API function. In such cases, unlock the resources before running the API function.

Execution permission

Storage Administrator (Initial Configuration)

Request line

```
PATCH base-URL/v1/objects/snmp-settings/instance
```

Request message**Object ID**

Specify `instance`.

If an object has only one instance, the `instance` is the fixed value that specifies the object ID.

Query parameters

None.

Body

The following is a coding example when the SNMP version is SNMP v1:

```
{
  "isSNMPAgentEnabled": true,
  "snmpVersion": "v1",
  "sendingTrapSetting": {
    "snmpv1v2cSettings": [
      {
        "community": "MyRestSNMPCommunity1",
        "sendTrapTo": [
          "192.0.2.100",
          "192.0.2.200"
        ]
      }
    ]
  },
  "requestAuthenticationSetting": {
    "snmpv1v2cSettings": [
      {
        "community": "MyRestSNMPCommunity2",
        "requestsPermitted": [
          "192.0.3.100"
        ]
      }
    ]
  },
  "systemGroupInformation": {
    "storageSystemName": "VSP_G700",
    "contact": "confmanager@example.com",
    "location": "Data Center 1F"
  }
}
```

The following is a coding example when the SNMP version is SNMP v3:

```
{
  "isSNMPAgentEnabled": true,
  "snmpVersion": "v3",
```

```

"sendingTrapSetting": {
  "snmpv3Settings": [
    {
      "userName": "MyRestSNMPUser1",
      "sendTrapTo": "192.0.2.100",
      "authentication": {
        "protocol": "SHA",
        "password": "TopSecretForMySNMP1",
        "encryption": {
          "protocol": "AES",
          "key": "KeyForMySNMP1"
        }
      }
    },
    {
      "userName": "MyRestSNMPUser2",
      "sendTrapTo": "192.0.2.200"
    }
  ]
},
"requestAuthenticationSetting": {
  "snmpv3Settings": [
    {
      "userName": "MyRestSNMPUser3",
      "authentication": {
        "protocol": "MD5",
        "password": "",
        "encryption": {
          "protocol": "DES",
          "key": ""
        }
      }
    }
  ]
},
"systemGroupInformation": {
  "storageSystemName": "VSP_G700",
  "contact": "confmanager@example.com",
  "location": "Data Center 1F"
}
}

```

Attribute	Type	Description
isSNMPAgentEnabled	boolean	(Required) Whether SNMP Agent is enabled <ul style="list-style-type: none"> ▪ true: Enabled ▪ false: Disabled

Attribute	Type	Description
		If this attribute is <code>true</code> , error information (SIM) is sent by using SNMP traps. Also, SNMP operation requests (GET REQUEST, GET NEXT REQUEST, and GET BULK REQUEST) are received.
snmpVersion	string	(Required) SNMP version Specify the SNMP version that is used. The specifiable values are as follows: <ul style="list-style-type: none"> ▪ <code>v1</code>: SNMP v1 ▪ <code>v2c</code>: SNMP v2c ▪ <code>v3</code>: SNMP v3
sendingTrapSetting	object	(Optional) SNMP trap destinations

Attribute	Type	Description
		<p>Specifiable attributes vary depending on the SNMP version.</p> <ul style="list-style-type: none"> ▪ snmpv1v2cSettings (object[]) <p>(Optional) Array of the settings for SNMP trap destinations (for SNMP v1 or SNMP v2c)</p> <p>You can specify up to 32 destinations. If you specify more than one destination, you must specify a unique <code>community</code> attribute. If you specify <code>snmpv1v2cSettings</code> attribute, you must also specify both the <code>community</code> attribute and the <code>sendTrapTo</code> attribute.</p> <ul style="list-style-type: none"> • community (string) <p>Community name used to report an SNMP trap#</p> <p>Specify a character string that consists of 1 to 180 characters.</p> • sendTrapTo (string[]) <p>Array of the IP addresses to which SNMP traps are sent.</p> <p>Specify these in IPv4 or IPv6 format. You can specify up to 32 IP addresses.</p>

Attribute	Type	Description
		<ul style="list-style-type: none"> ▪ <code>snmpv3Settings</code> (object[]) (Optional) Array of the settings for SNMP trap destinations (for SNMP v3) You can specify up to 8 destinations. If you specify more than one destination, you must specify a unique <code>sendTrapTo</code> attribute. If you specify <code>snmpv3Settings</code> attribute, you must also specify both the <code>userName</code> attribute and the <code>sendTrapTo</code> attribute. <ul style="list-style-type: none"> • <code>userName</code> (string) User name that is used for SNMP trap reports[#] Specify a character string that consists of 1 to 32 characters. • <code>sendTrapTo</code> (string) Specify the IP address to which SNMP traps are sent. Specify these in IPv4 or IPv6 format. • <code>authentication</code> (object) (Optional) Authentication information Specify this attribute when password-based authentication is enabled. For details on the specifiable attributes, see the table of the attributes that can be specified for the <code>authentication</code> attribute.
requestAuthenticationSetting	object	(Optional) Settings for the permitted requests

Attribute	Type	Description
		<p>Specify the settings for the permitted requests (GET REQUEST, GETNEXT REQUEST, and GETBULK REQUEST) of SNMP operations. Specifiable attributes vary depending on the SNMP version.</p> <ul style="list-style-type: none"> ▪ <code>snmpv1v2cSettings</code> (object[]) <p>(Optional) Array of the settings for permitted requests (for SNMP v1 or SNMP v2c)</p> <p>You can specify up to 32 requests. If you specify more than one request, you must specify a unique <code>community</code> attribute. If you specify <code>snmpv1v2cSettings</code> attribute, you must also specify both the <code>community</code> attribute and the <code>requestsPermitted</code> attribute.</p> <ul style="list-style-type: none"> • <code>community</code> (string) <p>Name of the community that receives requests[#]</p> <p>Specify a character string that consists of 1 to 180 characters.</p> • <code>requestsPermitted</code> (string[]) <p>Array of the IP addresses of the SNMP Managers that receive requests</p> <p>Specify this in IPv4 or IPv6 format. You can specify up to 32 IP addresses. If you specify an empty array, requests of all SNMP Managers are received.</p>

Attribute	Type	Description
		<ul style="list-style-type: none"> ▪ <code>snmpv3Settings</code> (object[]) (Optional) Array of the settings for permitted requests (for SNMP v3) You can specify up to 8 requests. If you specify more than one request, you must specify a unique <code>userName</code> attribute. If you specify <code>snmpv3Settings</code> attribute, you must also specify the <code>userName</code> attribute. • <code>userName</code> (string) Name of the user who receives requests# Specify a character string that consists of 1 to 32 characters. This attribute is case sensitive. • <code>authentication</code> (object) (Optional) Authentication information Specify this attribute when password-based authentication is enabled. For details on the specifiable attributes, see the table of the attributes that can be specified for the <code>authentication</code> attribute.

Attribute	Type	Description
systemGroupInformation	object	<p>(Required) Information of the system group</p> <ul style="list-style-type: none"> ▪ storageSystemName (string) (Required) Name of the storage system# This is output as the sysName of the MIB of SNMP Agent. Specify a character string that consists of 1 to 180 characters. ▪ contact (string) (Required) Contact information or name of the administrator# This is output as the sysContact of the MIB of SNMP Agent. Specify a character string that consists of 0 to 180 characters. ▪ location (string) (Required) Location of the storage system# This is output as the sysLocation of the MIB of SNMP Agent. Specify a character string that consists of 0 to 180 characters.

The following table shows the attributes that can be specified for the `authentication` attribute. If you specify `authentication` attribute, you must also specify both the `protocol` attribute and the `password` attribute.

Attribute	Type	Description
protocol	string	<p>Authentication method</p> <p>You can specify the following values:</p> <ul style="list-style-type: none"> ▪ SHA ▪ MD5
password	string	<p>Password#</p> <p>Specify a character string that consists of 8 to 64 characters. If you do not want to change the password, specify an empty character string.</p>

Attribute	Type	Description
encryption	object	<p>(Optional) Encryption information</p> <p>Specify this item to enable encryption. If you specify this attribute, you must also specify both the <code>protocol</code> attribute and the <code>key</code> attribute.</p> <ul style="list-style-type: none"> ▪ <code>protocol</code> (string) Encryption method <p>You can specify the following values:</p> <ul style="list-style-type: none"> ▪ AES ▪ DES <ul style="list-style-type: none"> ▪ <code>key</code> (string) Encryption key[#] <p>Specify a character string that consists of 8 to 64 characters. If you do not want to change the encryption key, specify an empty character string.</p>

[#]: You can use the following characters:

- Alphanumeric characters
- The following symbols:
! # \$ % ' () + - . = @ [] _ ` { } ~
- Spaces (except at the beginning or end of a character string)

Response message

Body

A job object is returned. For details on attributes other than `affectedResources`, see the section explaining job objects.

Attribute	Description
<code>affectedResources</code>	URL of the SNMP settings

Status codes

For details on the status codes of the request for this operation, see the description on HTTP status codes.

Coding example

```
curl -v -H "Accept:application/json" -H "Content-Type:application/json" -H
"Authorization:Session d7b673af189048468c5af9bcf3b6bb6f" -X PATCH --data-
binary @./InputParameters.json https://192.0.2.100/ConfigurationManager/v1/
objects/snmp-settings/instance
```

Sending a test SNMP trap

The following request sends a test SNMP trap to make sure that the settings for reporting error information (SIM) to the SNMP manager are correctly specified.

For details on SNMP, see the *Hitachi SNMP Agent User Guide*.

**Note:**

If you locked any resources of the target storage system by using the REST API, you will not be able to use this API function. In such cases, unlock the resources before running the API function.

Execution permission

Storage Administrator (Initial Configuration)

Request line

```
POST base-URL/v1/objects/snmp-settings/instance/actions/send-trap-test/
invoke
```

Request message**Object ID**

Specify *instance*.

If an object has only one instance, the *instance* is the fixed value that specifies the object ID.

Query parameters

None.

Body

None.

Response message**Body**

A job object is returned. For details on the schema of job objects, see the description of job objects.

Action template

None.

Status codes

For details on the status codes of the request for this operation, see the description of HTTP status codes.

Coding example

```
curl -v -H "Accept:application/json" -H "Content-Type:application/json" -H
"Authorization:Session d7b673af189048468c5af9bcf3b6bb6f" -X POST https://
192.0.2.100/ConfigurationManager/v1/objects/snmp-settings/instance/actions/
send-trap-test/invoke -d ""
```

Getting information about the error notification email settings

The following request gets information about settings related to the sending of email notifications for the service information messages (SIMs) of storage systems.

Execution permission

Storage Administrator (View Only)

Request line

```
GET base-URL/v1/objects/alert-email-settings/instance
```

Request message**Object ID**

Specify *instance*.

If an object has only one instance, the *instance* is the fixed value that specifies the object ID.

Query parameters

None.

Body

None.

Response message**Body**

```
{
  "isEmailNotificationEnabled" : true,
```

```

"mailServer" : {
  "serverName" : "server1",
  "smtpAuth" : {
    "isSmtpAuthEnabled" : false,
    "account" : "user1",
    "password" : "*****"
  }
},
"fromAddress" : "from@example.com",
"replyToAddress" : "replyTo@example.com",
"toAddresses" : [
  {
    "attribute" : "to",
    "address" : "to@example.com"
  }
],
"description" : "description"
}

```

Attribute	Type	Description
isEmailNotificationEnabled	boolean	Whether notification by error notification emails is enabled <ul style="list-style-type: none"> ▪ true: Enabled ▪ false: Disabled
mailServer	object	Settings related to the server that sends the error notification emails

Attribute	Type	Description
		<p>The IP address or host name of the server is displayed, along with the following SMTP authentication settings.</p> <ul style="list-style-type: none"> ▪ <code>serverName</code> (string) IP address or host name of the server ▪ <code>smtpAuth</code> (object) SMTP authentication settings for the server <ul style="list-style-type: none"> ▪ <code>isSmtpAuthEnabled</code> (boolean) Whether SMTP authentication is enabled <code>true</code>: Enabled <code>false</code>: Disabled ▪ <code>account</code> (string) Account (user name) for SMTP authentication ▪ <code>password</code> (string) Password for SMTP authentication If a password is set, four asterisks (****) are displayed. If no password is set, an empty character string is displayed.
<code>fromAddress</code>	string	Source (from) email address from which error notification emails are sent
<code>replyToAddress</code>	string	Reply-destination (reply-to) email address to which replies to error notification emails are sent
<code>toAddresses</code>	object[]	Array of destination addresses for error notification emails

Attribute	Type	Description
		<p>If destination addresses for error notification emails are set, the following information is output:</p> <ul style="list-style-type: none"> attribute (string) An attribute of a destination address for error notification emails. Either <code>to</code>, <code>cc</code>, or <code>bcc</code> is output. address (string) A destination address for error notification emails.
description	string	<p>Information displayed at the beginning of an error notification email</p> <p>Additional notification information that is displayed at the beginning of an error notification email is output.</p>

Status codes

For details on the status codes of the request for this operation, see the description on HTTP status codes.

Coding example

```
curl -v -H "Accept:application/json" -H "Content-Type:application/json" -H
"Authorization:Session d7b673af189048468c5af9bcf3b6bb6f" -X GET https://
192.0.2.100/ConfigurationManager/v1/objects/alert-email-settings/instance
```

Specifying settings for error notification emails

The following request specifies settings related to the sending of email notifications for the service information messages (SIMs) of storage systems. You can specify, in a batch operation, the server that sends the error notification emails, additional information to be included in each email, and the destination addresses.



Note:

If you locked any resources of the target storage system by using the REST API, you will not be able to use this API function. In such cases, unlock the resources before running the API function.

Execution permission

Storage Administrator (Initial Configuration)

Request linePATCH *base-URL/v1/objects/alert-email-settings/instance***Request message****Object ID**Specify *instance*.

If an object has only one instance, the *instance* is the fixed value that specifies the object ID.

Query parameters

None.

Body

```
{
  "isEmailNotificationEnabled": true,
  "mailServer": {
    "serverName": "server1",
    "smtpAuth" : {
      "account": "user1",
      "password": "userPass"
    }
  },
  "fromAddress" : "from@example.com",
  "replyToAddress" : "reply@example.com",
  "toAddresses" : [
    {
      "attribute" : "to",
      "address" : "to@example.com"
    },
    {
      "attribute" : "cc",
      "address" : "cc@example.com"
    },
    {
      "attribute" : "bcc",
      "address" : "bcc@example.com"
    }
  ],
  "description" : "description"
}
```

Attribute	Type	Description
isEmailNotificationEnabled	boolean	<p>(Optional) Whether to enable the sending of error notification emails</p> <ul style="list-style-type: none">▪ <code>true</code>: Enabled▪ <code>false</code>: Disabled <p>If you specify <code>true</code>, be sure to specify at least one source (from) address and one destination address.</p>

Attribute	Type	Description
mailServer	object	<p>(Optional) Settings related to the server that sends the error notification emails</p> <ul style="list-style-type: none"> ▪ serverName (string) <p>(Optional) IP address or host name of the server</p> <p>You can specify an IPv4 address, an IPv6 address, or a host name.</p> <p>Specify a name consisting of 1 to 255 characters.</p> <p>You can use the following characters in the host name:</p> <ul style="list-style-type: none"> ▪ Alphanumeric characters ▪ The following symbols: ! \$ % - . @ _ ` ~ <p>You cannot use spaces.</p> <p>To delete the IP address or host name of the server for sending emails, specify <code>false</code> for the <code>isEmailNotificationEnabled</code> attribute, and then specify an empty character string for this attribute.</p>

Attribute	Type	Description
		<ul style="list-style-type: none"> <li data-bbox="878 254 1424 604"> <p>▪ smtpAuth (object)</p> <p>(Optional) SMTP authentication settings for the server</p> <ul style="list-style-type: none"> <li data-bbox="915 390 1424 604"> <p>▪ isSmtplibAuthEnabled (boolean)</p> <p>(Optional) Whether to use SMTP authentication</p> <p>true: Use</p> <p>false: Do not use</p> <li data-bbox="915 642 1424 1409"> <p>▪ account (string)</p> <p>(Optional) Account (user name) for SMTP authentication</p> <p>You must specify this attribute if true is specified for the isSmtplibAuthEnabled attribute.</p> <p>Specify a name consisting of 1 to 255 characters.</p> <p>You can use the following characters:</p> <p>Alphanumeric characters</p> <p>The following symbols:</p> <p>! \$ % () - . @ _ ` ~</p> <p>You cannot use spaces.</p> <p>To delete the account (user name) for SMTP authentication, specify false for the isSmtplibAuthEnabled attribute, and specify an empty character string for this attribute.</p> <li data-bbox="915 1446 1424 1856"> <p>▪ password (string)</p> <p>(Optional) Password for SMTP authentication</p> <p>You must specify this attribute if true is specified for the isSmtplibAuthEnabled attribute.</p> <p>Specify a name consisting of 1 to 255 characters.</p> <p>You can use the following characters:</p> <p>Alphanumeric characters</p>

Attribute	Type	Description
		<p>The following symbols: ! \$ % () - . @ _ ` ~</p> <p>You cannot use spaces.</p> <p>To delete the SMTP authentication password, specify <code>false</code> for the <code>isSmtplibAuthEnabled</code> attribute, and specify an empty character string for this attribute.</p>
fromAddress	string	<p>(Optional) Source (from) email address from which error notification emails are sent[#]</p> <p>Specify a name consisting of 1 to 255 characters.</p> <p>To delete a source (from) email address from which error notification emails are sent, specify <code>false</code> for the <code>isEmailNotificationEnabled</code> attribute, and then specify an empty character string for this attribute.</p>
replyToAddress	string	<p>(Optional) Reply-destination (reply-to) email address to which replies to error notification emails are to be sent[#]</p> <p>Specify a name consisting of 1 to 255 characters.</p> <p>To delete the reply-destination (reply-to) address, specify an empty character string.</p>
toAddresses	object[]	<p>(Optional) Array of destination addresses for error notification emails</p>

Attribute	Type	Description
		<p>You can specify up to 32 destination addresses to which error notification emails are to be sent. If you specify this attribute, all destination addresses that are currently registered will be overwritten.</p> <ul style="list-style-type: none"> ▪ attribute (string) <p>An attribute of a destination address for error notification emails.</p> <p>You must specify this attribute if you specify the <code>toAddresses</code> attribute.</p> <ul style="list-style-type: none"> • <code>to</code> • <code>cc</code> • <code>bcc</code> ▪ address (string) <p>A destination address for error notification emails.#</p> <p>You must specify this attribute if you specify the <code>toAddresses</code> attribute. Specify an address consisting of 1 to 255 characters.</p> <p>To delete all registered destination addresses for error notification emails, specify <code>false</code> for the <code>isEmailNotificationEnabled</code> attribute, and then specify an empty array for this attribute.</p>
description	string	<p>(Optional) Information displayed at the beginning of an error notification email</p> <p>Specify additional notification information to be displayed at the beginning of an error notification email. You can use between 1 and 511 characters.</p>

Attribute	Type	Description
		<p>You can use the following characters:</p> <ul style="list-style-type: none"> ▪ Alphanumeric characters ▪ The following symbols: ! " # \$ % & ' () * + , - . / : ; < = > ? @ [\] ^ _ ` { } ~ ▪ Spaces ▪ Newlines <p>A newline character is counted as two characters.</p> <p>To delete the information displayed at the beginning of an error notification email, specify an empty character string.</p>

#: You can use the following characters for the source (from) address, reply-destination (reply-to) address, and destination address:

- Alphanumeric characters
- The following symbols:
! # \$ % & ' * + - . = ? @ ^ _ ` { | } ~

You cannot use spaces.

Response message

Body

A job object is returned. For details on attributes other than affectedResources, see the section explaining job objects.

Attribute	Description
affectedResources	URL for acquiring settings information about an error notification email

Status codes

For details on the status codes of the request for this operation, see the description on HTTP status codes.

Coding example

```
curl -v -H "Accept:application/json" -H "Content-Type:application/json" -H
"Authorization:Session d7b673af189048468c5af9bcf3b66b6f" -X PATCH --data-
binary @./InputParameters.json https://192.0.2.100/ConfigurationManager/v1/
objects/alert-email-settings/instance
```

Adding a destination address for error notification emails

You can add a destination address for error notification emails. These notification emails are used to report service information messages (SIMs) of storage systems. This API allows you to add one destination address for error notification emails at a time.

**Note:**

If you locked any resources of the target storage system by using the REST API, you will not be able to use this API function. In such cases, unlock the resources before running the API function.

Execution permission

Storage Administrator (Initial Configuration)

Request line

```
POST base-URL/v1/objects/alert-email-settings/instance/actions/add-
recipient-address/invoke
```

Request message**Object ID**

Specify *instance*.

If an object has only one instance, the *instance* is the fixed value that specifies the object ID.

Query parameters

None.

Body

```
{
  "parameters": {
    "attribute" : "to",
    "address"   : "to@example.com"
  }
}
```

Attribute	Type	Description
attribute	string	(Required) An attribute of a destination address for error notification emails that you want to add. <ul style="list-style-type: none"> ▪ to ▪ cc ▪ bcc
address	string	(Required) A destination address for error notification emails that you want to add. Specify a name consisting of 1 to 255 characters. You can use the following characters: <ul style="list-style-type: none"> ▪ Alphanumeric characters ▪ The following symbols: ! # \$ % & ' * + - . = ? @ ^ _ ` { } ~ You cannot use spaces.

Response message

Body

A job object is returned. For details on attributes other than affectedResources, see the section explaining job objects.

Attribute	Description
affectedResources	URL for acquiring settings information about an error notification email

Action template

None.

Status codes

For details on the status codes of the request for this operation, see the description on HTTP status codes.

Coding example

```
curl -v -H "Accept:application/json" -H "Content-Type:application/json" -H
"Authorization:Session d7b673af189048468c5af9bcf3b6bb6f" -X POST --data-
binary @./InputParameters.json https://192.0.2.100/ConfigurationManager/v1/
objects/alert-email-settings/instance/actions/add-recipient-address/invoke
```

Deleting a destination address for error notification emails

You can delete a destination address for error notification emails. These notification emails are used to report service information messages (SIMs) of storage systems. This API allows you to delete one destination address at a time.

**Note:**

- To delete all destination addresses at once, disable the setting for sending error notification emails.
- If you locked any resources of the target storage system by using the REST API, you will not be able to use this API function. In such cases, unlock the resources before running the API function.

Execution permission

Storage Administrator (Initial Configuration)

Request line

```
POST base-URL/v1/objects/alert-email-settings/instance/actions/remove-
recipient-address/invoke
```

Request message**Object ID**

Specify *instance*.

If an object has only one instance, the *instance* is the fixed value that specifies the object ID.

Query parameters

None.

Body

```
{
  "parameters": {
    "address" : "to@example.com"
```

```
}
}
```

Attribute	Type	Description
address	string	<p>(Required) A destination address for error notification emails that you want to delete.</p> <p>Specify a name consisting of 1 to 255 characters.</p> <p>You can use the following characters:</p> <ul style="list-style-type: none"> ▪ Alphanumeric characters ▪ The following symbols: ! # \$ % & ' * + - . = ? @ ^ _ ` { } ~ <p>You cannot use spaces.</p>

Response message

Body

A job object is returned. For details on attributes other than `affectedResources`, see the section explaining job objects.

Attribute	Description
<code>affectedResources</code>	URL for acquiring settings information about an error notification email

Action template

None.

Status codes

For details on the status codes of the request for this operation, see the description on HTTP status codes.

Coding example

```
curl -v -H "Accept:application/json" -H "Content-Type:application/json" -H
"Authorization:Session d7b673af189048468c5af9bcf3b66b6f" -X POST --data-
binary @./InputParameters.json https://192.0.2.100/ConfigurationManager/v1/
objects/alert-email-settings/instance/actions/remove-recipient-address/
invoke
```

Sending a test error notification email

The following request sends a test error notification email to verify that the settings related to the sending of email notifications for the service information messages (SIMs) of storage systems are correctly specified.



Note:

If you locked any resources of the target storage system by using the REST API, you will not be able to use this API function. In such cases, unlock the resources before running the API function.

Execution permission

Storage Administrator (Initial Configuration)

Request line

```
POST base-URL/v1/objects/alert-email-settings/instance/actions/send-email-test/invoke
```

Request message

Object ID

Specify *instance*.

If an object has only one instance, the *instance* is the fixed value that specifies the object ID.

Query parameters

None.

Body

None.

Response message

Body

A job object is returned. For details on attributes other than `affectedResources`, see the section explaining job objects. `affectedResources` is not displayed for this API. To verify that the email was successfully sent, check whether the test email was received by the specified recipients (destination addresses).

Status codes

The following table describes the meaning of the status code of the request for this operation. For details on other status codes, see the description of HTTP status codes.

Status code	Message	Description
412	Precondition Failed	If the setting for sending error notification emails is disabled, test emails cannot be sent.

Coding example

```
curl -v -H "Accept:application/json" -H "Content-Type:application/json" -H "Authorization:Session d7b673af189048468c5af9bcf3bbbb6f" -X POST https://192.0.2.100/ConfigurationManager/v1/objects/alert-email-settings/instance/actions/send-email-test/invoke -d ""
```

Getting a list of license information

The following request obtains a list of software license information. You can also obtain the list by specifying the software name or installation status of the software.



Note:

If you execute this API request immediately after updating the license, the request might not be processed correctly if the system does not recognize the updated license. If this happens, wait a while, and then execute the request again.

Execution permission

Storage Administrator (View Only)

Request line

```
GET base-URL/v1/objects/licenses
```

Request message

Object ID

None.

Query parameters

Parameter	Type	Filter condition
programProductName	string	(Optional) Software name You cannot specify this parameter and the <i>status</i> parameter at the same time.

Parameter	Type	Filter condition
status	string	(Optional) Installation status of the software You can specify the following values: <ul style="list-style-type: none"> ▪ Installed ▪ Installed (Disabled) ▪ Not Installed ▪ Not Enough License ▪ Grace Period ▪ Expired You cannot specify this parameter and the <code>programProductName</code> parameter at the same time.

Body

None.

Response message**Body**

```

{
  "data": [
    {
      "licenseId": 32775,
      "programProductName": "Dynamic Provisioning",
      "status": "Installed",
      "keyType": "Permanent",
      "capacityLimitStatus": "Unlimited",
      "usedCapacityInGB": 24379
    },
    {
      "licenseId": 32835,
      "programProductName": "Dynamic Tiering",
      "status": "Installed",
      "keyType": "Permanent",
      "capacityLimitStatus": "Unlimited",
      "usedCapacityInGB": 14682
    },
    {
      "licenseId": 32880,
      "programProductName": "Thin Image",
      "status": "Installed",
      "keyType": "Permanent",

```



```

    "capacityLimitStatus": "Unlimited",
    "usedCapacityInGB": 940
  },
  {
    "licenseId": 32884,
    "programProductName": "global-active device",
    "status": "Installed",
    "keyType": "Permanent",
    "capacityLimitStatus": "Unlimited",
    "usedCapacityInGB": 161
  }
]
}

```

The following is an example of output generated when the query parameters are specified:

```

{
  "data": [
    {
      "licenseId": 32775,
      "programProductName": "Dynamic Provisioning",
      "status": "Installed",
      "keyType": "Permanent",
      "capacityLimitStatus": "Unlimited",
      "usedCapacityInGB": 24379
    }
  ]
}

```

The following table lists the license information that you can obtain. For details about license information, see the *System Administrator Guide*.

Attribute	Type	Description
licenseId	int	License ID
programProductName	string	Software name

Attribute	Type	Description
status	string	<p>Installation status of the software</p> <ul style="list-style-type: none"> ▪ Installed: Installed ▪ Installed (Disabled): Installed (License is disabled) ▪ Not Installed: Not installed ▪ Not Enough License: Installed (Not enough license capacity) ▪ Grace Period: Not enough license capacity because of additional LDEVs or pool volumes, or creation of pairs ▪ Expired: Expired <p>Output when the <code>keyType</code> attribute is <code>Temporary</code>.</p>
keyType	string	<p>License key type</p> <ul style="list-style-type: none"> ▪ Permanent: For purchase (no limit on effective term) ▪ Term: For purchase (effective term specified) ▪ Temporary: For trial use before purchase ▪ Emergency: For emergency use
capacityLimitStatus	string	<p>Specified if the permitted license capacity has a limit</p> <ul style="list-style-type: none"> ▪ Limited: Limited ▪ Unlimited: Unlimited
permittedCapacityInTB	long	Permitted license capacity (TB)
usedCapacityInGB	long	Volume capacity used by the software (GB)
remainingDays	int	<p>Remaining days before expiration</p> <ul style="list-style-type: none"> ▪ If the <code>keyType</code> attribute is <code>Term</code>, <code>Temporary</code>, or <code>Emergency</code>: Remaining days before expiration ▪ If a license for which the <code>keyType</code> attribute is <code>Temporary</code> is expired: Remaining days after the expiration date until re-installation of the software becomes available

Status codes

For details on the status codes of the request for this operation, see the description on HTTP status codes.

Coding example

```
curl -v -H "Accept:application/json" -H "Content-Type:application/json" -H
"Authorization:Session d7b673af189048468c5af9bcf3bbbb6f" -X GET https://
192.0.2.100/ConfigurationManager/v1/objects/licenses
```

Getting information about a specific license

The following request obtains license information by specifying a software license ID.

Execution permission

Storage Administrator (View Only)

Request line

```
GET base-URL/v1/objects/licenses/object-ID
```

Request message**Object ID**

Specify the `licenseId` value obtained by getting information about the licenses.

Attribute	Type	Description
licenseId	int	(Required) License ID

Query parameters

None.

Body

None.

Response message**Body**

```
{
  "licenseId": 32775,
```

```

"programProductName": "Dynamic Provisioning",
"status": "Installed",
"keyType": "Permanent",
"capacityLimitStatus": "Unlimited",
"usedCapacityInGB": 24379
}

```

The following table lists the license information that you can obtain. For details about license information, see the *System Administrator Guide*.

Attribute	Type	Description
licenseId	int	License ID
programProductName	string	Software name
status	string	<p>Installation status of the software</p> <ul style="list-style-type: none"> ▪ <code>Installed</code>: Installed ▪ <code>Installed (Disabled)</code>: Installed (License is disabled) ▪ <code>Not Installed</code>: Not installed ▪ <code>Not Enough License</code>: Installed (Not enough license capacity) ▪ <code>Grace Period</code>: Not enough license capacity because of additional LDEVs or pool volumes, or creation of pairs ▪ <code>Expired</code>: Expired <p>Output when the <code>keyType</code> attribute is <code>Temporary</code>.</p>
keyType	string	<p>License key type</p> <ul style="list-style-type: none"> ▪ <code>Permanent</code>: For purchase (no limit on effective term) ▪ <code>Term</code>: For purchase (effective term specified) ▪ <code>Temporary</code>: For trial use before purchase ▪ <code>Emergency</code>: For emergency use
capacityLimitStatus	string	<p>Specified if the permitted license capacity has a limit</p> <ul style="list-style-type: none"> ▪ <code>Limited</code>: Limited ▪ <code>Unlimited</code>: Unlimited

Attribute	Type	Description
permittedCapacityInTB	long	Permitted license capacity (TB)
usedCapacityInGB	long	Volume capacity used by the software (GB)
remainingDays	int	Remaining days before expiration <ul style="list-style-type: none"> ▪ If the <code>keyType</code> attribute is <code>Term</code>, <code>Temporary</code>, or <code>Emergency</code>: Remaining days before expiration ▪ If a license for which the <code>keyType</code> attribute is <code>Temporary</code> is expired: Remaining days after the expiration date until re-installation of the software becomes available

Status codes

For details on the status codes of the request for this operation, see the description on HTTP status codes.

Coding example

```
curl -v -H "Accept:application/json" -H "Content-Type:application/json" -H "Authorization:Session d7b673af189048468c5af9bcf3b6bb6f" -X GET https://192.0.2.100/ConfigurationManager/v1/objects/licenses/34055
```

Installing software

The following request installs software by registering a license key code.

Execution permission

Storage Administrator (Initial Configuration)

Request line

```
POST base-URL/v1/objects/licenses
```

Request message

Object ID

None.

Query parameters

None.

Body

```
{
  "keyCode":
  "ABCDEFGHIJKLMNOPQRSTUVWXYZ123456789012345678901234567890ABCDEFGHIJKLMNOPQRSTUVWXYZ"
}
```

Attribute	Type	Description
keyCode	string	(Required) License key code

Response message**Body**

A job object is returned. For details on attributes other than affectedResources, see the section explaining job objects.

Attribute	Description
affectedResources	URL of the list of software license information

Status codes

For details on the status codes of the request for this operation, see the description on HTTP status codes.

Coding example

```
curl -v -H "Accept:application/json" -H "Content-Type:application/json" -H
"Authorization:Session d7b673af189048468c5af9bcf3bbbb6f" -X POST --data-
binary @./InputParameters.json https://192.0.2.100/ConfigurationManager/v1/
objects/licenses
```

Enabling or disabling a license

You can enable or disable a software license by specifying the software license ID.

Execution permission

Storage Administrator (Initial Configuration)

Request line

```
PATCH base-URL/v1/objects/licenses/object-ID
```

Request message**Object ID**

Specify the `licenseId` value obtained by getting information about the licenses.

Attribute	Type	Description
<code>licenseId</code>	int	(Required) License ID

Query parameters

None.

Body

```
{
  "isEnabled": true
}
```

Attribute	Type	Description
<code>isEnabled</code>	boolean	(Required) Whether to enable a license or not <ul style="list-style-type: none"> ▪ <code>true</code>: Enables a license ▪ <code>false</code>: Disables a license

Response message**Body**

A job object is returned. For details on attributes other than `affectedResources`, see the section explaining job objects.

Attribute	Description
<code>affectedResources</code>	URL of information about the license for which the setting was changed

Action template

None.

Status codes

For details on the status codes of the request for this operation, see the description on HTTP status codes.

Coding example

```
curl -v -H "Accept:application/json" -H "Content-Type:application/json" -H
"Authorization:Session d7b673af189048468c5af9bcf3bbbb6f" -X PATCH --data-
binary @./InputParameters.json https://192.0.2.100/ConfigurationManager/v1/
objects/licenses/34055
```

Removing software

The following request shows how to remove software by specifying the license ID.

Execution permission

Storage Administrator (Initial Configuration)

Request line

```
DELETE base-URL/v1/objects/licenses/object-ID
```

Request message**Object ID**

Specify the `licenseId` value obtained by getting information about the licenses.

Attribute	Type	Description
licenseId	int	(Required) License ID

Query parameters

None.

Body

None.

Response message**Body**

A job object is returned. For details on attributes other than `affectedResources`, see the section explaining job objects.

Attribute	Description
<code>affectedResources</code>	URL of the license information of the removed program product

Status codes

For details on the status codes of the request for this operation, see the description on HTTP status codes.

Coding example

```
curl -v -H "Accept:application/json" -H "Content-Type:application/json" -H "Authorization:Session d7b673af189048468c5af9bcf3b6666f" -X DELETE https://192.0.2.100/ConfigurationManager/v1/objects/licenses/34055
```

Chapter 16: Encrypting data

You can use REST API to perform operations related to data encryption that utilizes Encryption License Key.

Overview of data encryption

You can use the Encryption License Key functionality to encrypt data stored in a volume of the storage system. If you encrypt data, you can prevent information leakage when hard disks in the storage system are replaced or the hard disks are stolen. Even if you encrypt data, the processing time or waiting time during I/O will not increase and the existing applications and infrastructure will not be affected.

The operations for data encryption to be performed by using the REST API are as follows:

- Setting an encryption environment

You can use the REST API to change the encryption environment settings for the storage system or initialize the encryption environment.

- Encrypting data to be stored in a volume

If you enable data encryption when creating a parity group and create a volume from the parity group, data to be stored in that volume is encrypted. In addition, if you migrate existing volumes to the volume, the data stored in these existing volumes can also be encrypted.

- Managing encryption keys

You can use the REST API to manage encryption keys used to encrypt and decrypt data. Encryption keys are automatically created when an encryption environment is enabled for the first time. You can create a new key if unassigned keys become insufficient due to replacement of a drive, or delete unnecessary unassigned keys. In addition, you can back up encryption keys to a REST API client and restore them if needed.



Note: If the settings are specified so that an encryption environment for the storage system links with the key management server, you cannot use the REST API to perform the following operations:

- Change or get the encryption environment settings
- Create or delete encryption keys
- Back up or restore encryption keys

For details on the Encryption License Key functionality such as the encryption specifications and system requirements, see the *Encryption License Key User Guide*.

Workflow for operations related to data encryption

The workflow for using the REST API to perform operations to encrypt and use data stored in a volume of a storage system is as follows.

Specifying encryption environment settings

Specify settings for an environment used to encrypt data stored in a volume.

The following figure shows the workflow.

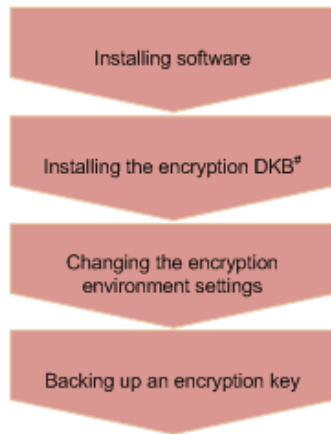

Legend:

 : Required operation

#: Operation performed without using the REST API

Installing software

Install the license key for the Encryption License Key software.

Installing the encryption disk board (DKB)

Install the encryption DKB.

Changing the encryption environment settings

Enable the encryption environment settings.

Backing up an encryption key

When you enable the encryption environment settings and create an encryption key, you need to back up the encryption key.

Encrypting new data

The following describes how to create a volume, and then encrypt data to be newly written to the volume.

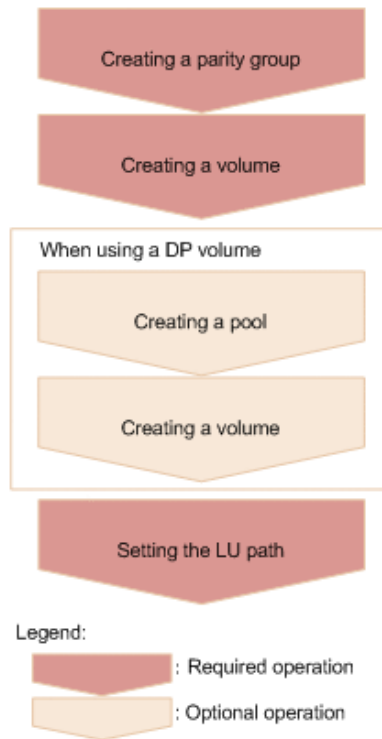
**Creating a parity group**

Create a parity group for which data encryption is enabled (specify `true` for the attribute `isEncryptionEnabled`).

Creating a volume

Create a volume by specifying the parity group for which data encryption is enabled.

When using a DP volume**Creating a pool**

Create a pool by specifying volumes whose data is encrypted.

Creating a volume

Create a DP volume by specifying a pool consisting only of volumes whose data is encrypted.

Setting the LU path

Specify the LU path from the host to the volume.

Encrypting existing data

The following describes how to encrypt the existing data stored in a volume.

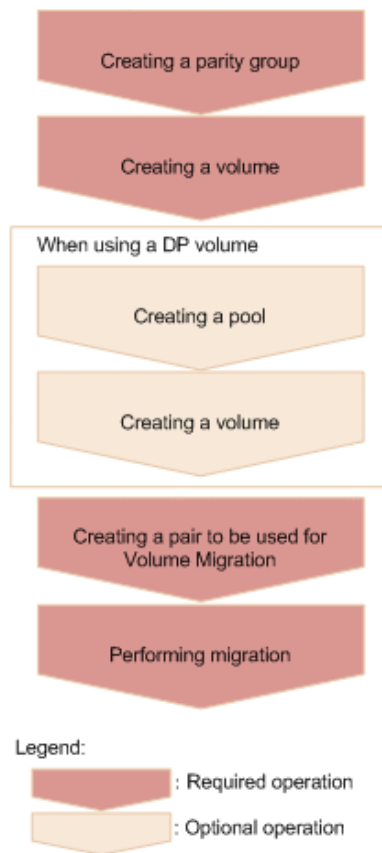
**Creating a parity group**

Create a parity group for which data encryption is enabled (specify `true` for the attribute `isEncryptionEnabled`).

Creating a volume

Create a volume by specifying the parity group for which data encryption is enabled.

When using a DP volume**Creating a pool**

Create a pool by specifying volumes whose data is encrypted.

Creating a volume

Create a DP volume by specifying a pool consisting only of volumes whose data is encrypted.

Creating a pair to be used for Volume Migration

Create a pair by specifying the volume whose data is to be encrypted as the source volume (P-VOL). For the target volume (S-VOL), specify a volume created from a parity group for which data encryption is enabled.

Performing migration

Perform migration to copy the data of the source volume (P-VOL) that is to be encrypted to the target volume (S-VOL).

Encrypting existing data without changing the drive configuration

The following describes how to encrypt the data in a volume in a parity group for which data encryption is disabled, without changing the drive configuration.

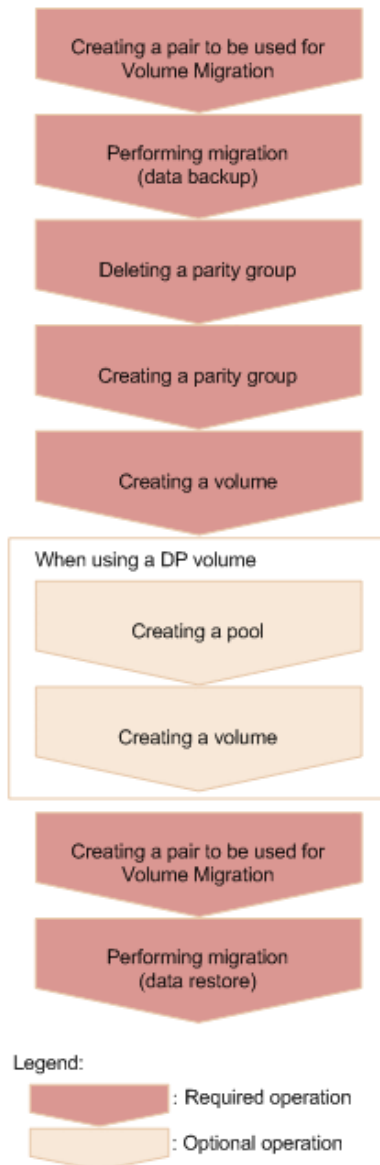

Creating a pair to be used for Volume Migration

Create a pair to which to back up the data to be encrypted, by specifying a volume in one parity group as the source volume (P-VOL). For the target volume (S-VOL), specify a volume in another parity group as the destination volume for the volume to be backed up.

Performing migration

Back up (migrate) the data of the source volume (P-VOL) to the target volume (S-VOL).

Deleting a parity group

Verify that the data has been migrated, and then delete the parity group.

Creating a parity group

Create a parity group for which data encryption is enabled (specify `true` for the attribute `isEncryptionEnabled`).

Creating a volume

Create a volume by specifying the parity group for which data encryption is enabled.

When using a DP volume

Creating a pool

Create a pool by specifying volumes whose data is encrypted.

Creating a volume

Create a DP volume by specifying a pool consisting only of volumes whose data is encrypted.

Creating a pair to be used for Volume Migration

Create a pair by specifying the migrated volume as the source volume (P-VOL) to be encrypted. For the target volume (S-VOL), specify a volume created from a parity group for which data encryption is enabled.

Performing migration

Restore (migrate) the data of the source volume (P-VOL) to be encrypted to the target volume (S-VOL).



Note:

Use the following method to check whether the data in a volume is encrypted.

- To check a basic volume:

Get information about the volume by running the API request for getting information about a specific volume.

If `ENCD` is output for the `attributes` attribute, this indicates that the data in the volume is encrypted.

- To check a DP volume:

Get information about a list of volumes that make up a pool, by running the API request for getting volume information with the pool number specified for the query parameter `poolId`.

If `ENCD` is output for the `attributes` attribute of each pool volume that makes up the pool, this indicates that the data in the DP volume is encrypted.

Getting information about the encryption environment settings

The following request gets information about the encryption environment settings.

Execution permission

Security Administrator (View & Modify)

Request lineGET *base-URL*/v1/objects/encryption-settings/instance**Request message****Object ID**Specify *instance*.

If an object has only one instance, the *instance* is the fixed value that specifies the object ID.

Query parameters

None.

Body

None.

Response message**Body**

```
{
  "isEnabled": true,
  "detectsError": false
}
```

Attribute	Type	Description
isEnabled	boolean	Whether the encryption environment is enabled <ul style="list-style-type: none"> ▪ <code>true</code>: The encryption environment is enabled ▪ <code>false</code>: The encryption environment is disabled
detectsError	boolean	Whether an error occurred while the encryption environment settings were being changed <ul style="list-style-type: none"> ▪ <code>true</code>: An error occurred. ▪ <code>false</code>: No error occurred.

Attribute	Type	Description
		If this value is <code>true</code> , data encryption cannot be performed. Disable (initialize) the encryption environment settings by running the API request that changes the encryption environment settings, and then enable the encryption environment settings again.

Status codes

For details about the status codes of the request for this operation, see the description of HTTP status codes.

Coding example

```
curl -v -H "Accept:application/json" -H "Content-Type:application/json" -H
"Authorization:Session d7b673af189048468c5af9bcf3b6bb6f" -X GET https://
192.0.2.100/ConfigurationManager/v1/objects/encryption-settings/instance
```

Changing the encryption environment settings

You can change the encryption environment settings. If you change the settings to enable the encryption environment, encryption is applied. If you change the settings to disable the encryption environment, the encryption environment settings are initialized.



Note:

If you locked any resources of the target storage system by using the REST API, you will not be able to use this API function. In such cases, unlock the resources before running the API function.

Execution permission

Security Administrator (View & Modify)

Request line

```
PATCH base-URL/v1/objects/encryption-settings/instance
```

Request message

Object ID

Specify `instance`

If an object has only one instance, the `instance` is the fixed value that specifies the object ID.

Query parameters

None.

Body

```
{
  "isEnabled": true
}
```

Attribute	Type	Description
isEnabled	boolean	(Required) Specify whether to enable the encryption environment. <ul style="list-style-type: none"> ▪ <code>true</code>: Enables the encryption environment ▪ <code>false</code>: Disables (initialize) the encryption environment

Response message

Body

A job object is returned. For details on attributes other than `affectedResources`, see the section explaining job objects.

Attribute	Description
affectedResources	URL of the encryption environment settings specified for the storage system

Action template

None.

Status codes

For details on the status codes of the request for this operation, see the description of HTTP status codes.

Coding example

```
curl -v -H "Accept:application/json" -H "Content-Type:application/json" -H
"Authorization:Session d7b673af189048468c5af9bcf3b6f" -X PATCH --data-
```

```
binary @./InputParameters.json https://192.0.2.100/ConfigurationManager/v1/objects/encryption-settings/instance
```

Getting the number of encryption keys

This request obtains the number of encryption keys.

Execution permission

Security Administrator (View Only)

Request line

```
GET base-URL/v1/objects/encryption-key-counts/instance
```

Request message

Object ID

Specify *instance*.

If an object has only one instance, the *instance* is the fixed value that specifies the object ID.

Query parameters

None.

Body

None.

Response message

Body

```
{
  "cek": 4,
  "dek": 12,
  "free": 1003
}
```

Attribute	Type	Description
cek	int	The number of certificate encryption keys (CEKs)
dek	int	The number of data encryption keys (DEKs)
free	int	The number of unused keys

Status codes

The following table describes the meaning of the status code of the request for this operation. For details on other status codes, see the description on HTTP status codes.

Status code	Message	Description
412	Precondition Failed	This operation is not supported for the microcode version of the storage system.

Coding example

```
curl -v -H "Accept:application/json" -H "Content-Type:application/json" -H
"Authorization:Session d7b673af189048468c5af9bcf3b6bb6f" -X GET https://
192.0.2.100/ConfigurationManager/v1/objects/encryption-key-counts/instance
```

Getting information about a list of encryption keys

You can get information about a list of encryption keys.

Execution permission

Security Administrator (View Only)

Request line

```
GET base-URL/v1/objects/encryption-keys
```

Request message**Object ID**

None.

Query parameters

Parameter	Type	Filter condition
keyType	string	(Required) Type of keys for which information is to be obtained <ul style="list-style-type: none"> ▪ DEK ▪ CEK ▪ KEK ▪ FREE ▪ DEKANDFREE (DEK and FREE)

Parameter	Type	Filter condition
		If you specify <code>DEK</code> , <code>FREE</code> , or <code>DEKANDFREE</code> for this parameter, you can specify other optional parameters.
<code>startKeyId</code>	int	(Optional) ID of the key from which to start getting information Specify a value in the range from 0 to 4095. This parameter is valid only if you specify <code>DEK</code> , <code>FREE</code> , or <code>DEKANDFREE</code> for the <code>keyType</code> parameter. If this parameter is omitted, 0 is assumed.
<code>count</code>	int	(Optional) Number of keys for which information is to be obtained Specify a value in the range from 1 to 1024. This parameter is valid only if you specify <code>DEK</code> , <code>FREE</code> , or <code>DEKANDFREE</code> for the <code>keyType</code> parameter. If this parameter is omitted, 1024 is assumed.
<code>startCreatedTime</code>	ISO8601string	(Optional) Information is obtained about keys that were created on or after the specified date and time. Specify a value in YYYY-MM-DDThh:mm:ssZ format. If you also specify the <code>endCreatedTime</code> parameter, specify a date and time that is earlier than the date and time specified for the <code>endCreatedTime</code> parameter. This parameter is valid only if you specify <code>DEK</code> , <code>FREE</code> , or <code>DEKANDFREE</code> for the <code>keyType</code> parameter.
<code>endCreatedTime</code>	ISO8601string	(Optional) Information is obtained about keys that were created on or before the specified date and time. Specify a value in YYYY-MM-DDThh:mm:ssZ format.

Parameter	Type	Filter condition
		<p>If you also specify the <code>startCreatedTime</code> parameter, specify a date and time that is later than the date and time specified for the <code>startCreatedTime</code> parameter.</p> <p>This parameter is valid only if you specify <code>DEK</code>, <code>FREE</code>, or <code>DEKANDFREE</code> for the <code>keyType</code> parameter.</p>

Body

None.

Response message**Body**

```
{
  "data": [
    {
      "keyId": "6",
      "createdTime": "2018-10-29T04:32:26Z",
      "keyType": "DEK",
      "uuid": "-",
      "targetDeviceLocation": "HDD00-08",
      "keyGeneratedLocation": "DKC",
      "numOfBackups": 4
    },
    {
      "keyId": "7",
      "createdTime": "2018-10-29T04:32:26Z",
      "keyType": "DEK",
      "uuid": "-",
      "targetDeviceLocation": "HDD00-09",
      "keyGeneratedLocation": "DKC",
      "numOfBackups": 4
    }
  ]
}
```

Attribute	Type	Description
keyId	string	<p>ID of the key</p> <p>If the value of the <code>keyType</code> attribute is <code>CEK</code> or <code>KEK</code>, a hyphen (-) is output.</p>

Attribute	Type	Description
createdTime	ISO8601string	Date and time when the key was created If the value of the <code>keyType</code> attribute is <code>KEK</code> and the value of the <code>keyGeneratedLocation</code> attribute is <code>DKC</code> , a hyphen (-) is output.
keyType	string	Type of the key <ul style="list-style-type: none"> ▪ <code>DEK</code>: Encryption key The key is used to encrypt stored data. ▪ <code>CEK</code>: Key for authentication This key is used to encrypt a certificate. It is also used when a DEK is stored in a DKB. ▪ <code>KEK</code>: Key for encrypting keys This key is used to encrypt a CEK, a DEK, or a FREE key. Only one KEK exists for each storage system. ▪ <code>FREE</code>: Unused key that has not been assigned an encryption key
uuid	string	UUID of the key If the value of the <code>keyType</code> attribute is not <code>KEK</code> , or if the value of the <code>keyType</code> attribute is <code>KEK</code> but no key management server is linked, a hyphen (-) is output.
targetDeviceLocation	string	Device to which the key is assigned <ul style="list-style-type: none"> ▪ Location number of the drive (if the key type is DEK) ▪ Location number of the controller (if the key type is CEK) ▪ A hyphen (-) (if the key type is KEK or FREE)
keyGeneratedLocation	string	Location where the key was created <ul style="list-style-type: none"> ▪ <code>DKC</code>: Storage system ▪ <code>KMS</code>: Key management server
numOfBackups	int	Number of times the key was backed up

Attribute	Type	Description
		If the value of the <code>keyType</code> attribute is <code>KEK</code> , <code>-1</code> is output, indicating an invalid value.

Status codes

The following table describes the meaning of the status code of the request for this operation. For details on other status codes, see the description on HTTP status codes.

Status code	Message	Description
412	Precondition Failed	This operation is not supported for the microcode version of the storage system.

Coding example

```
curl -v -H "Accept:application/json" -H "Content-Type:application/json" -H
"Authorization:Session d7b673af189048468c5af9bcf3b66b6f" -X GET https://
192.0.2.100/ConfigurationManager/v1/objects/encryption-keys?keyType=DEK
```

Getting a specific encryption key

You can get information about a specific encryption key by specifying the ID of the key. You can use this API request to get information about a key whose type is `DEK` or `FREE`. To get information about a key whose type is `CEK` or `KEK`, use the API request that gets information about a list of encryption keys.

Execution permission

Security Administrator (View Only)

Request line

```
GET base-URL/v1/objects/encryption-keys/object-ID
```

Request message

Object ID

Specify the value for `keyId` that you acquired by running the API request to obtain a list of encryption keys.

Attribute	Type	Description
keyId	string	(Required) ID of the key

Query parameters

None.

Body

None.

Response message**Body**

```
{
  "keyId": "7",
  "createdTime": "2018-10-29T04:32:26Z",
  "keyType": "DEK",
  "uuid": "-",
  "targetDeviceLocation": "HDD00-09",
  "keyGeneratedLocation": "DKC",
  "numOfBackups": 4
}
```

Attribute	Type	Description
keyId	string	ID of the key
createdTime	ISO8601string	Date and time when the key was created
keyType	string	Type of the key <ul style="list-style-type: none"> ▪ DEK: Encryption key The key is used to encrypt stored data. ▪ FREE: Unused key that has not been assigned an encryption key
uuid	string	UUID of the key A hyphen (-) is always output.

Attribute	Type	Description
targetDeviceLocation	string	Device to which the key is assigned <ul style="list-style-type: none"> Location number of the drive (if the key type is DEK) A hyphen (-) (if the key type is FREE)
keyGeneratedLocation	string	Location where the key was created <ul style="list-style-type: none"> DKC: Storage system KMS: Key management server
numOfBackups	int	Number of times the key was backed up

Status codes

The following table describes the meaning of the status code of the request for this operation. For details on other status codes, see the description of HTTP status codes.

Status code	Message	Description
412	Precondition Failed	The microcode version of the storage system does not support this operation.

Coding example

```
curl -v -H "Accept:application/json" -H "Content-Type:application/json" -H
"Authorization:Session d7b673af189048468c5af9bcf3b6bb6f" -X GET https://
192.0.2.100/ConfigurationManager/v1/objects/encryption-keys/7
```

Creating encryption keys

You can create encryption keys by specifying the number of encryption keys you want to create. After creating an encryption key, be sure to back it up.



Note:

If you locked any resources of the target storage system by using the REST API, you will not be able to use this API function. In such cases, unlock the resources before running the API function.

Execution permission

Security Administrator (View & Modify)

Request line

```
POST base-URL/v1/objects/encryption-keys
```

Request message**Object ID**

None.

Query parameters

None.

Body

```
{
  "count": 10
}
```

Attribute	Type	Description
count	int	(Required) The number of encryption keys to be created Specify a value equal to or greater than 1. If the sum of the value specified for the <code>count</code> attribute and the number of existing keys exceeds the maximum number of keys that can be created, no keys are created, and an error occurs.

Response message**Body**

A job object is returned. See the description for the job object.
`affectedResources` is not displayed for this API. To confirm that the encryption keys have been created, run the API request for obtaining the number of encryption keys or the API request for obtaining a list of encryption keys.

Status codes

The following table describes the meaning of the status code of the request for this operation. For details on other status codes, see the description of HTTP status codes.

Status code	Message	Description
412	Precondition Failed	The microcode version of the storage system does not support this operation.

Coding example

```
curl -v -H "Accept:application/json" -H "Content-Type:application/json" -H "Authorization:Session d7b673af189048468c5af9bcf3b6bb6f" -X POST --data-binary @./InputParameters.json https://192.0.2.100/ConfigurationManager/v1/objects/encryption-keys
```

Deleting an encryption key

You can delete unused (FREE) keys by specifying the ID of the key you want to delete. Keys whose type is CEK or DEK cannot be deleted.



Note:

If you locked any resources of the target storage system by using the REST API, you will not be able to use this API function. In such cases, unlock the resources before running the API function.

Execution permission

Security Administrator (View & Modify)

Request line

```
DELETE base-URL/v1/objects/encryption-keys/object-ID
```

Request message

Object ID

Specify the value for `keyId` that you acquired by running the API request to obtain a list of encryption keys.

Attribute	Type	Description
keyId	string	(Required) The key ID

Query parameters

None.

Body

None.

Response message**Body**

A job object is returned. For details on attributes other than `affectedResources`, see the section explaining job objects.

Attribute	Description
<code>affectedResources</code>	The URL of the key that was deleted

Status codes

The following table describes the meaning of the status code of the request for this operation. For details on other status codes, see the description of HTTP status codes.

Status code	Message	Description
412	Precondition Failed	The microcode version of the storage system does not support this operation.

Coding example

```
curl -v -H "Accept:application/json" -H "Content-Type:application/json" -H
"Authorization:Session d7b673af189048468c5af9bcf3b6bb6f" -X DELETE
https://192.0.2.100/ConfigurationManager/v1/objects/encryption-keys/4
```

Backing up encryption keys

You can back up encryption keys to a file on the REST API client. In the request header of this API function, specify `application/octet-stream` for `Accept`.

**Note:**

- When you create an encryption key, be sure to back it up. We also recommend that you periodically back up encryption keys.
- If you locked any resources of the target storage system by using the REST API, you will not be able to use this API function. In such cases, unlock the resources before running the API function.

Execution permission

Security Administrator (View & Modify)

Request header

This API request downloads an encryption key file to the REST API client. Specify `application/octet-stream` for the Accept of the request header.

Request line

```
POST base-URL/v1/objects/encryption-keys/file/actions/backup/invoke
```

Request message**Object ID**

Specify a value for `file`.

When backing up encryption keys to a file or restoring encryption keys from a file, the value of `file` is a fixed value (the object ID).

Query parameters

None.

Body

```
{
  "parameters": {
    "password": "backuppasword"
  }
}
```

Attribute	Type	Description
password	string	<p>(Required) Password.</p> <p>Specify a character string consisting of 6 to 255 characters.</p> <p>You can use the following characters:</p> <ul style="list-style-type: none"> ▪ Alphanumeric characters ▪ ! " # \$ % & ' () * + , - . / : ; < = > ? @ [\] ^ _ ` { } ~ <p>You will need this password when you restore the encryption key.</p>

Response header

This API request returns the following response header.

Header	Description
Content-Disposition	attachment
Content-Length	The size of the backup data (in bytes)
Content-type	application/octet-stream

Response message

Body

None.

Action template

None.

Status codes

The following table describes the meaning of the status code of the request for this operation. For details on other status codes, see the description of HTTP status codes.

Status code	Message	Description
412	Precondition Failed	The microcode version of the storage system does not support this operation.

Coding example

```
curl -v -H "Accept:application/octet-stream" -H "Content-Type:application/json" -H "Authorization:Session d7b673af189048468c5af9bcf3b66b6f" -X POST --data-binary @./InputParameters.json https://192.0.2.100/ConfigurationManager/v1/objects/encryption-keys/file/actions/backup/invoke -o "backupfile.ekf"
```

Restoring encryption keys

You can restore encryption key file that was previously backed up. In the request header of this API function, specify `multipart/form-data` for Content-Type.



Note:

If you locked any resources of the target storage system by using the REST API, you will not be able to use this API function. In such cases, unlock the resources before running the API function.

Execution permission

Security Administrator (View & Modify)

Request header

In this API, the request body is sent in the format of multipart/form-data. Specify `multipart/form-data` for the Content-Type of the request header.

Request line

POST *base-URL/v1/objects/encryption-keys/file/actions/restore/invoke*

Request message**Object ID**

Specify a value for `file`.

When backing up encryption keys to a file or restoring encryption keys from a file, the value of `file` is a fixed value (the object ID).

Query parameters

None.

Body

Attribute	Type	Description
password	string	(Required) The password that was specified when the encryption key was backed up.
file	file	(Required) The backed-up encryption key file. Specify the most recent backup file. Encryption keys that are not up to date (for example, encryption keys that were changed after the file was backed up) cannot be restored.

Response message**Body**

A job object is returned. For details on the schema of job objects, see the description of job objects. Note, however, that this API function does not display the `affectedResources` attribute.

Action template

None.

Status codes

The following table describes the meaning of the status code of the request for this operation. For details on other status codes, see the description of HTTP status codes.

Status code	Message	Description
412	Precondition Failed	The microcode version of the storage system does not support this operation.

Coding example

```
curl -v -H "Accept:application/json" -H "Content-Type: multipart/form-data" -H "Authorization:Session d7b673af189048468c5af9bcf3b6bb6f" -H "Expect:" -X POST -F "file=@C:\backupfile.ekf" -F "password=backupperpassword" https://192.0.2.100/ConfigurationManager/v1/objects/encryption-keys/file/actions/restore/invoke
```

Chapter 17: Monitoring storage systems

You can monitor the status of storage systems by getting alerts (SIMs) generated on each storage system, as well as information about the hardware installed in each storage system.

Getting a list of alert information

The following request gets a list of alerts related to the error information (SIM) of a storage system.

Execution permission

Support Personnel or User Maintenance

Request line

```
GET base-URL/v1/objects/alerts
```

Request message

Object ID

None.

Query parameters

Attribute	Type	Filter Condition
type	string	(Required) Specify the type of the alert information you want to obtain. Specifiable values are as follows: <ul style="list-style-type: none">DKC: DKCCTL1: controller 1CTL2: controller 2
start	int	(Optional) Specify the number of the alert from which you want to start obtaining information. Alerts are sorted by date and time in descending order.

Attribute	Type	Filter Condition
		<p>If you specified <code>DKC</code> for the <code>type</code> parameter, specify a value in the range from 1 to 10240.</p> <p>If you specified <code>CTL1</code> or <code>CTL2</code> for the <code>type</code> parameter, specify a value in the range from 1 to 256.</p> <p>If this parameter is omitted, alert information will be obtained starting from the first alert.</p>
<code>count</code>	<code>int</code>	<p>(Optional) Specify the number of alerts to be obtained.</p> <p>If you specified <code>DKC</code> for the <code>type</code> parameter, specify a value in the range from 1 to 10240.</p> <p>If you specified <code>CTL1</code> or <code>CTL2</code> for the <code>type</code> parameter, specify a value in the range from 1 to 256.</p> <p>If this parameter is omitted, 10 alerts will be obtained.</p>

Body

None.

Response message**Body**

```
{
  "data" : [
    {
      "alertIndex" : "133ed620e449-0f0c9-7d0700",
      "alertId" : 61641,
      "occurrenceTime" : "2018-03-22T16:14:01",
      "referenceCode" : 8193792,
      "errorLevel" : "Moderate",
      "errorSection" : "GUM detection error",
      "errorDetail" : "GUM security error detected",
      "location" : "CTL1",
      "actionCodes" : [
        {
          "actionCode" : 1492123648,
          "possibleFailureParts" : "TSC CALL",
          "accLocation" : "-"
        }
      ]
    },
    {
      "alertIndex" : "133ed620a156-0f0c6-7d0700",
      "alertId" : 61638,
```

```

"occurrenceTime" : "2018-03-22T11:28:22",
"referenceCode" : 8193792,
"errorLevel" : "Moderate",
"errorSection" : "GUM detection error",
"errorDetail" : "GUM security error detected",
"location" : "CTL1",
"actionCodes" : [
  {
    "actionCode" : 1492123648,
    "possibleFailureParts" : "TSC CALL",
    "accLocation" : "-"
  }
]
},
{
  "alertIndex" : "133ed6011907-0f0c3-7d0700",
  "alertId" : 61635,
  "occurrenceTime" : "2018-03-20T19:59:03",
  "referenceCode" : 8193792,
  "errorLevel" : "Moderate",
  "errorSection" : "GUM detection error",
  "errorDetail" : "GUM security error detected",
  "location" : "CTL1",
  "actionCodes" : [
    {
      "actionCode" : 1492123648,
      "possibleFailureParts" : "TSC CALL",
      "accLocation" : "-"
    }
  ]
},
{
  "alertIndex" : "133ed601164f-0f0bd-7d0700",
  "alertId" : 61629,
  "occurrenceTime" : "2018-03-20T19:47:27",
  "referenceCode" : 8193792,
  "errorLevel" : "Moderate",
  "errorSection" : "GUM detection error",
  "errorDetail" : "GUM security error detected",
  "location" : "CTL1",
  "actionCodes" : [
    {
      "actionCode" : 1492123648,
      "possibleFailureParts" : "TSC CALL",
      "accLocation" : "-"
    }
  ]
}
}

```

```

    ]
}

```

Attribute	Type	Description
alertIndex	string	Character string that uniquely identifies an alert
alertID	int	Alert ID The log number of the SIM is displayed.
occurrence Time	string	Date and time when the alert occurred The local time of the storage system is displayed in YYYY-MM-DDThh:mm:ss format.
referenceCode	int	SIM reference code
errorLevel	string	One of the following values is displayed as the error level: <ul style="list-style-type: none"> ▪ Service: Service ▪ Moderate: Warning (Moderate) ▪ Serious: Error (Serious) ▪ Acute: Acute
errorSection	string	Information about where the alert occurred
errorDetail	string	Details of the alert
location	string	The location of the component or part for which the error occurred

Attribute	Type	Description
actions	object[]	<p>The following information related to the action code of the alert is displayed:</p> <ul style="list-style-type: none"> ▪ <code>actionCode</code> (long) Action code ▪ <code>possibleFailureParts</code> (string) The part that might have been the cause of the error The name of the part that is assumed to be the cause of the error is displayed. ▪ <code>accLocation</code> (string) Location The location of the component in which the error occurred is displayed.

Status codes

For details on the status codes of the request for this operation, see the description on HTTP status codes.

Coding example

```
curl -v -H "Accept:application/json" -H "Content-Type:application/json" -H
"Authorization:Session f76884c29fff4dfaa664aa6981087b71" -X GET "https://
192.0.2.100/ConfigurationManager/v1/objects/alerts?
type=CTL1&start=2&count=4"
```

Getting information about the hardware installed in a storage system

The following request gets information about the hardware installed in a storage system, including information about the controller's temperature and the battery status.

Execution permission

Storage Administrator (View Only)

Request line

```
GET base-URL/v1/objects/components/instance
```

Request message**Object ID**

Specify `instance`. If an object has only one instance, the value for `instance` is the fixed value that specifies the object ID.

Query parameters

None.

Body

None.

Response message**Body**

```
{
  "system": {
    "powerConsumption": 283
  },
  "ctls": [
    {
      "location": "CTL1",
      "status": "Normal",
      "temperature": 29,
      "temperatureStatus": "Normal",
      "charge": 100,
      "type": "Controller Board"
    },
    {
      "location": "CTL2",
      "status": "Normal",
      "temperature": 29,
      "temperatureStatus": "Normal",
      "charge": 100,
      "type": "Controller Board"
    }
  ],
  "cacheMemories": [
    {
      "location": "CTL1 CMG0",
      "status": "Normal",
      "cacheSize": 16
    },
    {
      "location": "CTL2 CMG0",
      "status": "Normal",
      "cacheSize": 16
    }
  ],
}
```

```

"chbs": [
  {
    "location": "CHB-1A",
    "status": "Normal",
    "type": "10G 2Port iSCSI (Optic)"
  },
  {
    "location": "CHB-2A",
    "status": "Normal",
    "type": "10G 2Port iSCSI (Optic)"
  }
],
"cacheFlashMemories": [
  {
    "location": "CFM-1",
    "status": "Normal",
    "type": "BM05"
  },
  {
    "location": "CFM-2",
    "status": "Normal",
    "type": "BM05"
  }
],
"dkbs": [],
"lanbs": [],...
}

```

For attributes indicated by a hash mark (#), if there is no hardware and information cannot be obtained, the attributes under the object are not output.

Attribute	Type	Description
system	object	<p>The following attribute related to the storage system information is output:</p> <ul style="list-style-type: none"> powerConsumption (int) Power consumption of the storage system (Watt) <p>A value is output indicating the average amount of power consumed by the controller and the drive box per minute.</p> <p>If a valid value cannot be obtained, -1 is output.</p>

Attribute	Type	Description
ctls	object[]	<p>The following attributes related to the controller information are output:</p> <ul style="list-style-type: none"> ▪ location (string) Location of the controller ▪ status (string) Status of the controller <ul style="list-style-type: none"> • Normal • Warning • Blocked • Failed ▪ temperature (int) Temperature of the controller (°C) A value in the range from -55 to 125 is output. If a value outside of this range is obtained, -274 is output. If the value of the <code>status</code> attribute is <code>Blocked</code>, the value that was obtained immediately before the controller was blocked is output. A similar value might also be output if the value of the <code>status</code> attribute is <code>Failed</code>. ▪ temperatureStatus (string) Status indicating the temperature of the controller <ul style="list-style-type: none"> • Normal • Warning • Failed

Attribute	Type	Description
		<ul style="list-style-type: none"> <li data-bbox="703 254 1416 478"> ▪ charge (int) Charge status of the battery (%) A value in the range from 0 to 100 is output. If a value outside of this range is obtained, -1 is output. <li data-bbox="703 506 1416 779"> ▪ type (string) Type of the controller <ul style="list-style-type: none"> <li data-bbox="740 604 1386 674">• Encryption Controller Board: Encryption is enabled. <li data-bbox="740 688 1328 722">• Controller Board: Encryption is disabled. If a valid value cannot be obtained, - is output.
cacheMemories#	object[]	<p data-bbox="703 821 1416 890">The following attributes related to the cache memory are output:</p> <ul style="list-style-type: none"> <li data-bbox="703 905 1416 989"> ▪ location (string) Location of the cache memory <li data-bbox="703 1016 1416 1205"> ▪ status (string) Status of the cache memory <ul style="list-style-type: none"> <li data-bbox="740 1121 873 1150">• Normal <li data-bbox="740 1171 889 1201">• Warning <li data-bbox="703 1232 1416 1373"> ▪ cacheSize (int) Size (GB) of the cache memory If a valid value cannot be obtained, -1 is output.

Attribute	Type	Description
chbs#	object[]	<p>The following attributes related to the channel board are output:</p> <ul style="list-style-type: none"> ▪ location (string) Location of the channel board ▪ status (string) Status of the channel board <ul style="list-style-type: none"> • Normal • Warning • Blocked • Failed ▪ type (string) Type of the channel board <ul style="list-style-type: none"> • 16G 2Port FC • 32G Ready 4Port FC • 10G 2Port iSCSI (Optic) • 10G 2Port iSCSI (Copper)

Attribute	Type	Description
cacheFlashMemories#	object[]	<p>The following attributes related to the cache flash memory are output:</p> <ul style="list-style-type: none"> ▪ location (string) Location of the cache flash memory ▪ status (string) Status of the cache flash memory <ul style="list-style-type: none"> • Normal • Warning • Blocked • Failed ▪ type (string) Type of the cache flash memory <ul style="list-style-type: none"> • BM10 • BM20 • BM30 • BM05 • BM15 • BM35 • BM45

Attribute	Type	Description
dkbs#	object[]	<p>The following attributes related to the disk board are output:</p> <ul style="list-style-type: none"> ▪ location (string) Location of the disk board ▪ status (string) Status of the disk board <ul style="list-style-type: none"> • Normal • Warning • Blocked • Failed ▪ type (string) Type of the disk board <ul style="list-style-type: none"> • Disk Board • Encryption Disk Board
lanbs#	object[]	<p>The following attributes related to the LAN board are output:</p> <ul style="list-style-type: none"> ▪ location (string) Location of the LAN board ▪ status (string) Status of the LAN board <ul style="list-style-type: none"> • Normal • Warning

Attribute	Type	Description
sfps#	object[]	<p>The following attributes related to the SFP (Small Form Factor Pluggable) information are output:</p> <ul style="list-style-type: none"> ▪ portId (string) Port number of the SFP ▪ status (string) Status of the SFP <ul style="list-style-type: none"> • Not fix • Normal • Warning ▪ type (string) Type of the SFP <ul style="list-style-type: none"> • Short Wave • Long Wave • Copper Cable <p>If no port is used, an empty character string is output.</p> ▪ speed (string) SFP Speed <ul style="list-style-type: none"> • 16Gbps • 32Gbps <p>If no speed is set, an empty character string is output.</p> ▪ portCondition (string) Condition of the SFP port <ul style="list-style-type: none"> • Not Available • Available (Connected) • Available (Not Connected) <p>If the value of the attribute is anything other than the above, a hyphen (-) is output.</p>

Attribute	Type	Description
bkdfs#	object[]	<p>The following attributes related to the backup module are output:</p> <ul style="list-style-type: none"> ▪ location (string) Location of the backup module ▪ status (string) Status of the backup module <ul style="list-style-type: none"> • Normal • Warning • Blocked • Failed ▪ batteries (object[]) The following attributes related to the battery are output: <ul style="list-style-type: none"> • location(string) Location of the battery • status (string) Status of the battery Normal Warning Blocked Failed • life (int) Life expectancy of the battery A value in the range from 0 to 100 is output. If a value outside of this range is obtained, -1 is output.

Attribute	Type	Description
dkcps#	object[]	<p>The following attributes related to the DKCPS information are output:</p> <ul style="list-style-type: none"> ▪ location (string) Location of the DKCPS ▪ status (string) Status of the DKCPS <ul style="list-style-type: none"> • Normal • Warning • Failed
driveBoxes#	object[]	<p>The following attributes related to the drive box are output:</p> <ul style="list-style-type: none"> ▪ location (string) Location of the drive box ▪ type (string) Type of the drive box <ul style="list-style-type: none"> • DBS • DBL • DB60 • DBF ▪ led (string) Status of the LED <ul style="list-style-type: none"> • ON • OFF

Attribute	Type	Description
		<ul style="list-style-type: none"> ▪ drives (object[]) <p>The following attributes related to drives are output:</p> <ul style="list-style-type: none"> • location (string) Location of the drives • modelCode (string) Drive type code • status (string) Status of the drives Normal Warning Warning (Port 0 failed) Warning (Port 1 failed) Failed Copying n % (xxx to xxx) Copying n % (xxx from xxx) Pending (xxx to xxx) Pending (xxx from xxx) Copy incomplete Reserved If multiple copy statuses exist, all of them are output. • usage (string) Drive usage DATA Spare Free • recomendReplacement (int) Whether the replacement of the drive is recommended 0: PDEV replacement is not recommended. 1: PDEV replacement is recommended.

Attribute	Type	Description
		<ul style="list-style-type: none"> ▪ encs (object[]) <p>The following attributes related to the ENC information are output:</p> <ul style="list-style-type: none"> • location (string) Location of the ENC • status (string) Status of the ENC Normal Warning Blocked Failed ▪ dbps (object[]) <p>The following attributes related to the power supply for drive boxes are output:</p> <ul style="list-style-type: none"> • location (string) Location of the power supply for drive boxes • status (string) Status of the power supply for drive boxes Normal Warning Failed
fans#	object[]	<p>The following attributes related to fans are output:</p> <ul style="list-style-type: none"> ▪ location (string) Location of the fans ▪ status (string) Status of the fans <ul style="list-style-type: none"> • Normal • Warning • Failed

Attribute	Type	Description
upsMode	string	UPS mode <ul style="list-style-type: none"> ▪ UPS Interlock Mode 1 ▪ UPS Interlock Mode 2 ▪ UPS Interlock Mode 3 ▪ Standard Mode
pecbs#	object[]	The following attributes related to the PCIe channel board are output: <ul style="list-style-type: none"> ▪ location (string) Location of the PCIe channel board ▪ status (string) Status of the PCIe channel board <ul style="list-style-type: none"> • Normal • Warning • Blocked ▪ connectionMode (string) Connection mode of the PCIe channel board <ul style="list-style-type: none"> • Channel Board Box • Server Chassis If the value of the attribute is anything other than the above, a hyphen (-) is output.
chbb#	object	The following attributes related to the channel board box are output: <ul style="list-style-type: none"> ▪ location (string) Location of the channel board box ▪ expansionMode (string) Expansion mode of the channel board box <ul style="list-style-type: none"> • 1-vSW • 2-vSW If the value of the attribute is anything other than the above, a hyphen (-) is output.

Attribute	Type	Description
pcps [#]	object[]	<p>The following attributes related to the PCIe channel package are output:</p> <ul style="list-style-type: none"> ▪ location (string) Location of the PCIe channel package ▪ status (string) Status of the PCIe channel package <ul style="list-style-type: none"> • Normal • Warning • Blocked
swpks [#]	object[]	<p>The following attributes related to the switch package are output:</p> <ul style="list-style-type: none"> ▪ location (string) Location of the switch package ▪ status (string) Status of the switch package <ul style="list-style-type: none"> • Normal • Warning • Blocked
chbbfans [#]	object[]	<p>The following attributes related to the fan for the channel board box are output:</p> <ul style="list-style-type: none"> ▪ location (string) Location of the fan for the channel board box ▪ status (string) Status of the fan for the channel board box <ul style="list-style-type: none"> • Normal • Warning

Attribute	Type	Description
chbbps#	object[]	<p>The following attributes related to the power supply for the channel board box are output:</p> <ul style="list-style-type: none"> ▪ location (string) Location of the power supply for the channel board box ▪ status (string) Status of the power supply for the channel board box <ul style="list-style-type: none"> • Normal • Warning

Status codes

For details on the status codes of the request for this operation, see the section explaining HTTP status codes.

Coding example

```
curl -v -H "Accept:application/json" -H "Content-Type:application/json" -H
"Authorization:Session d7b673af189048468c5af9bcf3b6bb6f" -X GET https://
192.0.2.100/ConfigurationManager/v1/objects/components/instance
```

Chapter 18: Managing resources by using virtual storage machines

This chapter explains how to manage resources on virtual storage machines by using the REST API.

Overview of managing resources by using virtual storage machines

A "virtual storage machine" is a virtual storage system created on a storage system by using the global storage virtualization function. You can set virtual information, such as models and serial numbers, for virtual storage machines.

A virtual storage machine can be used as a global-active device or for nondisruptive migration. By registering resources in virtual storage machines, you can collectively manage resources of multiple physical storage systems on a single virtual storage machine, or divide resources of a single physical storage system into multiple virtual storage machines and manage the resources separately.

Examples of virtual storage machine configurations

The following figure shows examples of virtual storage machine configurations:

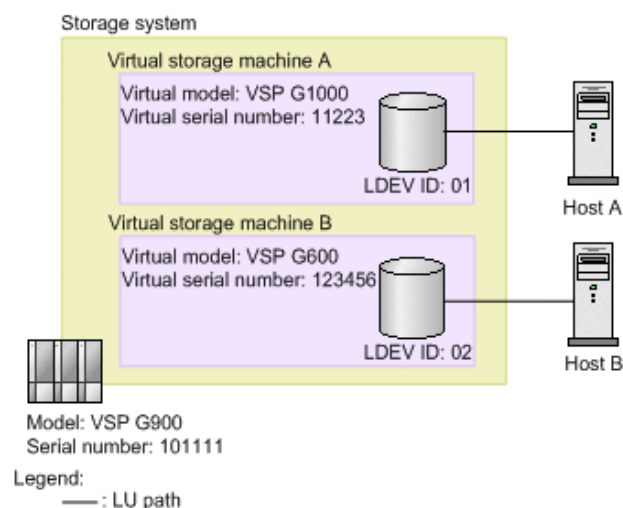

In this figure, a virtual storage machine of the virtual model VSP G1000 (virtual serial number: 11223) and a virtual storage machine of the virtual model VSP G600 (virtual serial number: 123456) are created in a VSP G900 storage system (serial number: 101111), and the resources registered in the virtual storage machines are allocated to the hosts. When the configuration is set up like this, from the virtual point of view it seems as if host A is accessing VSP G1000 (virtual serial number: 11223), and host B is accessing VSP G600 (virtual serial number: 123456).

For details on how to manage resources by using virtual storage machines, see the manual Provisioning Guide for Open Systems or Provisioning Guide.

Workflow for managing resources by using virtual storage machines

The following explains how to manage resources on virtual storage machines by using the REST API.

Workflow for creating a virtual storage machine and registering resources

Create a virtual storage machine, and then register the required resources. Allocate the registered resources to the hosts in the same way as allocating resources of a physical storage system, or use the registered resources in the volumes of a global-active device pair.

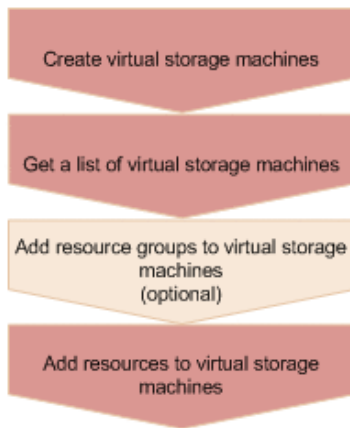

Create a virtual storage machine

Create a virtual storage machine, and then specify the model name and serial number. A resource group to be used on the virtual storage machine is also created at the same time.

Get a list of the virtual storage machines

Get information such as the storage device IDs of the created virtual storage machines, and the IDs of resource groups on the virtual storage machines.

Add resource groups on a virtual storage machine (optional)

If necessary, add resource groups to the virtual storage machine. Perform this operation by executing the API request for creating resource groups.

Add resources to the virtual storage machines

In the resource groups of the virtual storage machine, add resources such as host numbers, host group numbers, and LDEV numbers. Perform this operation by executing the API request for adding a resource to a resource group.

- To add an LDEV number, first delete the set virtual LDEV number, and then add the LDEV number. After adding the LDEV number in the virtual storage machine, set the virtual LDEV number.
- To add a host group number or iSCSI target number, add an undefined host group or iSCSI target.

Workflow for deleting an unnecessary virtual storage machine

Delete the resources on a virtual storage machine before you delete the virtual storage machine.

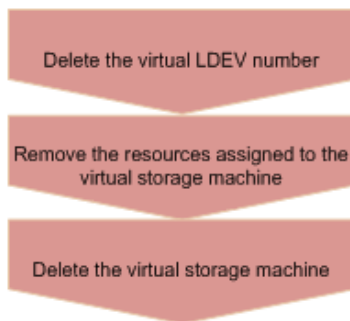
**Delete the virtual LDEV number**

Delete the virtual LDEV number that was set for the virtual LDEV on the virtual storage machine.

Remove the resources in the virtual storage machine

Delete the LDEVs, parity groups, host numbers, and all other resources that are added in the resource group in the virtual storage machine. Perform this operation by executing the API request for removing resources from resource groups.

Delete the virtual storage machine

Delete the virtual storage machine. Note that when all of the resource groups are deleted from the virtual storage machine, the virtual storage machine is automatically deleted.

Getting a list of virtual storage machines

The following request obtains a list of virtual storage machines. You can get information such as serial numbers, model names, and resource group IDs.

Execution permission

Storage Administrator (View Only)

Request line

```
GET base-URL/v1/objects/virtual-storages
```

Request message**Object ID**

None.

Query parameters

None.

Body

None.

Response message**Body**

```
{
  "data" : [
    {
      "virtualStorageDeviceId" : "800000002015",
      "virtualSerialNumber" : "2015",
      "virtualModel" : "VSP G1000/G1500 and VSP F1500",
      "resourceGroupIds" : [
        1,
        3
      ]
    },
    {
      "virtualStorageDeviceId" : "882000400002",
      "virtualSerialNumber" : "400002",
      "virtualModel" : "VSP G350",
      "resourceGroupIds" : [
        0,
        2,
        4
      ]
    }
  ]
}
```

Attribute	Type	Description
virtualStorageDeviceId	string	Storage device ID of the virtual storage machine
virtualSerialNumber	string	Serial number of the virtual storage machine
virtualModel	string	Model name of the virtual storage machine
resourceGroupIds	int[]	Resource group ID

Status codes

For details on the status codes for the request that performs this operation, see the description of HTTP status codes.

Coding example

```
curl -v -H "Accept:application/json" -H "Content-Type:application/json" -H
"Authorization:Session d7b673af189048468c5af9bcf3bbbb6f" -X GET https://
192.0.2.100/ConfigurationManager/v1/objects/virtual-storages
```

Getting information about a specific virtual storage machine

The following request gets information about the specified virtual storage machine. You can get information such as serial numbers, model names, and resource group IDs.

Execution permission

Storage Administrator (View Only)

Request line

```
GET base-URL/v1/objects/virtual-storages/object-ID
```

Request message

Object ID

Specify the `virtualStorageDeviceId` value obtained by getting information about the virtual storage machine.

Attribute	Type	Description
virtualStorageDeviceId	string	(Required) Storage device ID of the virtual storage machine

Query parameters

None.

Body

None.

Response message**Body**

```
{
  "virtualStorageDeviceId" : "882000400002",
  "virtualSerialNumber" : "400002",
  "virtualModel" : "VSP G350",
  "resourceGroupIds" : [
    0,
    2,
    4
  ]
}
```

Attribute	Type	Description
virtualStorageDeviceId	string	Storage device ID of the virtual storage machine
virtualSerialNumber	string	Serial number of the virtual storage machine
virtualModel	string	Model name of the virtual storage machine
resourceGroupIds	int[]	Resource group ID

Status codes

For details on the status codes for the request that performs this operation, see the description of HTTP status codes.

Coding example

```
curl -v -H "Accept:application/json" -H "Content-Type:application/json" -H
"Authorization:Session d7b673af189048468c5af9bcf3b6666f" -X GET https://
192.0.2.100/ConfigurationManager/v1/objects/virtual-storages/882000400002
```

Creating a virtual storage machine

The following request creates a virtual storage machine. A resource group is also created at the same time.

**Note:**

If you locked any resources of the target storage system by using the REST API, you will not be able to use this API function. In such cases, unlock the resources before running the API function.

Execution permission

Security Administrator (View & Modify)

Request line

```
POST base-URL/v1/objects/virtual-storages
```

Request message**Object ID**

None.

Query parameters

None.

Body

```
{
  "virtualSerialNumber": "422222",
  "virtualModel": "VSP G700",
  "resourceGroupName": "DevGroup"
}
```

Attribute	Type	Description
virtualSerialNumber	string	(Required) Serial number of the virtual storage machine

Attribute	Type	Description
virtualModel	string	<p>(Required) Model name of the virtual storage machine</p> <p>Specifiable values are as follows:</p> <ul style="list-style-type: none"> ▪ VSP F900 ▪ VSP F700 ▪ VSP F370 ▪ VSP F350 ▪ VSP G900 ▪ VSP G700 ▪ VSP G370 ▪ VSP G350 ▪ VSP G130 ▪ VSP G800 and VSP F800[#] ▪ VSP G400/G600 and VSP F400/F600[#] ▪ VSP G200 ▪ HUS VM ▪ VSP G1000/G1500 and VSP F1500 ▪ VSP ▪ USP VM ▪ USP V
resourceGroupName	string	<p>(Required) Name of the resource group to be created when the virtual storage machine is created</p> <p>Specify a name consisting of 1 to 32 characters.</p>

#: If the storage system model is VSP N400 or VSP N600, specify VSP G400/G600 and VSP F400/F600. If the storage system model is VSP N800, specify VSP G800 and VSP F800.

Response message

Body

A job object is returned. For details on attributes other than `affectedResources`, see the description of job objects.

Attribute	Description
<code>affectedResources</code>	URL of the created virtual storage machine

Status codes

For details on the status codes of the request for this operation, see the description on HTTP status codes.

Coding example

```
curl -v -H "Accept:application/json" -H "Content-Type:application/json" -H
"Authorization:Session d7b673af189048468c5af9bcf3bbbb6f" -X POST --data-
binary @./InputParameters.json https://192.0.2.100/ConfigurationManager/v1/
objects/virtual-storages/
```

Deleting a virtual storage machine

The following request deletes a virtual storage machine. Remove all of the resources included in the virtual storage machine before running this request.



Note:

If you locked any resources of the target storage system by using the REST API, you will not be able to use this API function. In such cases, unlock the resources before running the API function.

Execution permission

Security Administrator (View & Modify)

Request line

```
DELETE base-URL/v1/objects/virtual-storages/object-ID
```

Request message**Object ID**

Specify the `virtualStorageDeviceId` value obtained by getting information about the virtual storage machine.

Attribute	Type	Description
<code>virtualStorageDeviceId</code>	string	(Required) Storage device ID of the virtual storage machine

Query parameters

None.

Body

None.

Response message**Body**

A job object is returned. For details on attributes other than `affectedResources`, see the description of job objects.

Attribute	Description
<code>affectedResources</code>	URL of the deleted virtual storage machine

Status codes

For details on the status codes of the request for this operation, see the description on HTTP status codes.

Coding example

```
curl -v -H "Accept:application/json" -H "Content-Type:application/json" -H
"Authorization:Session d7b673af189048468c5af9bcf3bbbb6f" -X DELETE
https://192.0.2.100/ConfigurationManager/v1/objects/virtual-storages/
409900010000
```

Getting information about virtual LDEVs

The following request gets information about the virtual LDEVs (LDEVs to which virtual LDEV numbers have been assigned) on a virtual storage machine. If no virtual LDEVs

exist in the specified range, an empty list will be returned. To get information about virtual LDEVs, use multiple query parameters so that virtual LDEVs are included.

Execution permission

Storage Administrator (View Only)

Request line

```
GET base-URL/v1/objects/ldevs
```

Request message

Object ID

None.

Query parameters

You can filter the execution result by specifying conditions, or request additional detailed information about virtual LDEVs. To get information about virtual LDEVs, specify the target virtual storage machine by using the `virtualSerialNumber` parameter.

- When filtering the execution result

By default, information about a maximum of 100 virtual LDEVs is obtained. You can get information about a maximum of 16,384 virtual LDEVs by specifying the `count` parameter. When the `ldevOption` parameter or the `poolId` parameter is specified, if the number of virtual LDEVs for which information is to be obtained exceeds 16,384, use the `headVirtualLdevId` parameter and specify a value so that the virtual LDEV numbers whose information is to be obtained are included in the range. The information that can be obtained is only about the number of virtual LDEVs that are included in the range specified by the combination of the `headVirtualLdevId` parameter and the `count` parameter.



Important:

For this API, the number of concurrent executions might be restricted due to the number of LDEVs to be obtained and the details of other processing to be executed at the same time. For details about restriction conditions, see the notes about the number of concurrent executions.

For query parameters that can be specified at the same time, see the following table that lists the combinations of query parameters that can be specified.

Parameter	Type	Filter Condition
virtualSerialNumber	string	(Required) Specify the serial number of a virtual storage machine.

Parameter	Type	Filter Condition
		Information about virtual LDEVs on the virtual storage machine is obtained in the ascending order of virtual LDEV numbers.
headVirtualLdevId	int	<p>(Optional) Specify the virtual LDEV number (a decimal) from which the processing to get information is to start.</p> <p>Information about the LDEVs is obtained in the ascending order of virtual LDEV numbers, starting with the specified virtual LDEV number.</p> <p>If this parameter is omitted, 0 is assumed.</p> <p>When specifying this parameter, be sure to also specify the <code>virtualSerialNumber</code> parameter.</p>
count	int	<p>(Optional) Specify the number of virtual LDEVs about which you want to obtain information. Specify a value in the range from 1 to 16384.</p> <p>If this parameter is omitted, 100 is assumed.</p>
ldevOption	string	<p>(Optional) Virtual LDEV conditions for getting information</p> <p>You can specify the following conditions:</p> <ul style="list-style-type: none"> ▪ <code>defined</code> Get information about virtual LDEVs that have been implemented. ▪ <code>undefined</code> Get information about virtual LDEVs that are not implemented. ▪ <code>dpVolume</code> Obtaining DP volume information ▪ <code>luMapped</code> Get information about virtual LDEVs for which LU paths are defined. ▪ <code>luUnmapped</code> Get information about virtual LDEVs for which LU paths have not been defined. ▪ <code>externalVolume</code> Get information about external volumes.

Parameter	Type	Filter Condition
		If this is omitted, information about all types of virtual LDEVs will be obtained.
poolId	int	<p>(Optional) Pool number</p> <p>Get information about the virtual LDEVs that are associated with the specified pool.</p> <p>By using the <code>ldevOption</code> parameter when specifying conditions, the following information can be obtained:</p> <ul style="list-style-type: none"> ▪ If <code>dpVolume</code> is specified for the <code>ldevOption</code> parameter: Gets information about the DP volumes that are associated with the specified pool. ▪ If <code>luMapped</code> is specified for the <code>ldevOption</code> parameter: Gets information about virtual LDEVs for which LU paths associated with the specified pool are defined. ▪ If <code>luUnmapped</code> is specified for the <code>ldevOption</code> parameter: Gets information about virtual LDEVs for which LU paths associated with the specified pool have not been defined. <p>If you specify this parameter without specifying the <code>ldevOption</code> parameter, the API gets information about the volumes that make up the pool (pool volumes).</p>
resourceGroupId	int	(Optional) ID of the resource group to which virtual LDEVs for which information is to be obtained belong
journalId	int	(Optional) ID of the journal to which virtual LDEVs for which information is to be obtained belong
parityGroupId	string	<p>(Optional) Number of the parity group to which LDEVs for which information is to be obtained belong</p> <p>Specify concatenated parity groups in the same way as the above.</p>

Parameter	Type	Filter Condition
		If the concatenated parity groups are 1-3-1, 1-3-2, or 1-3-3, specify as follows: parityGroupId=1-3

The following table shows the combinations of query parameters that can be specified.

Parameter	virtual Serial Number	head Virtual Ldev Id	count	ldev Option	poolId	resource GroupId	journalId	parity GroupId
virtual Serial Number	--	Y	Y	Y	Y	Y	Y	Y
head Virtual LdevId	Y	--	Y	N	N	N	N	N
count	Y	Y	--	Y	Y	Y	Y	Y
ldevOption	Y	N	Y	--	Y#	Y	N	N
poolId	Y	N	Y	Y#	--	Y	N	N
resourceGroupId	Y	N	Y	Y	Y	--	Y	Y
journalId	Y	N	Y	N	N	Y	--	N
parityGroupId	Y	N	Y	N	N	Y	N	--

#: If defined, undefined, or externalVolume is specified as the value of the ldevOption parameter, you cannot specify this combination of parameters.

- When requesting additional detailed information

Parameter	Type	Description
detailInfoType	string	(Optional) Type of detailed information to be obtained

Parameter	Type	Description
		<p>You can use this parameter together with parameters that filter the execution results.</p> <p>The following values can be specified. To specify multiple values, separate the values by using commas.</p> <ul style="list-style-type: none"> ▪ FMC <p>Adds detailed information about accelerated compression for the virtual LDEVs that belong to parity groups with drive type SSD (FMC).</p> ▪ virtualSerialNumber <p>Adds detailed information about virtual storage machines.</p> ▪ savingInfo <p>Adds detailed information about capacity saving function (dedupe and compression).</p>

Body

None.

Response message**Body**

```
{
  "data": [
    {
      "ldevId": 0,
      "virtualLdevId": 0,
      "virtualSerialNumber": "410012",
      "clprId": 0,
      "emulationType": "OPEN-V-CVS",
      "byteFormatCapacity": "1.00 G",
      "blockCapacity": 2097152,
      "numOfPorts": 1,
      "ports": [
        {
          "portId": "CL3-B",
          "hostGroupNumber": 25,
          "hostGroupName": "bs10300-7",
          "lun": 19
        }
      ]
    }
  ],
}
```

```

"attributes": [
  "CVS",
  "HDP",
  "GAD"
],
"status": "NML",
"mpBladeId": 2,
"ssid": "0004",
"poolId": 4,
"numOfUsedBlock": 0,
"isFullAllocationEnabled": false,
"resourceGroupId": 6,
"dataReductionStatus": "DISABLED",
"dataReductionMode": "disabled",
"isAluaEnabled": false
},
{
  "ldevId": 1,
  "virtualLdevId": 1,
  "virtualSerialNumber": "410012",
  "clprId": 0,
  "emulationType": "OPEN-V-CVS",
  "byteFormatCapacity": "1.00 G",
  "blockCapacity": 2097152,
  "numOfPorts": 1,
  "ports": [
    {
      "portId": "CL3-B",
      "hostGroupNumber": 25,
      "hostGroupName": "bs10300-7",
      "lun": 21
    }
  ],
  "attributes": [
    "CVS",
    "HDP",
    "GAD"
  ],
  "label": "ldev_label_1",
  "status": "NML",
  "mpBladeId": 0,
  "ssid": "0004",
  "poolId": 10,
  "numOfUsedBlock": 0,
  "isFullAllocationEnabled": false,
  "resourceGroupId": 6,
  "dataReductionStatus": "DISABLED",
  "dataReductionMode": "disabled",
  "isAluaEnabled": false
}

```

```

    }
  ]
}

```

The following table describes the attributes to be obtained in the body of the response message. For details on attributes to be obtained, see the description of the API function for getting volume information.

Attribute	Type	Description
ldevId	int	LDEV number
virtualLdevId	int	Virtual LDEV number
virtualSerialNumber	string	Serial number of the virtual storage machine

If you execute the request with `virtualSerialNumber` specified for the `detailInfoType` query parameter, the request also obtains detailed information about the virtual storage machines.

Attribute	Type	Description
virtualModel	string	Model name of the virtual storage machine

If you run the request with `savingInfo` specified for the `detailInfoType` query parameter, the request also obtains detailed information about the capacity saving function.

```

{
  "data": [
    {
      "ldevId": 12,
      ...
      "dataReductionTotalSavingRatio": "2.44",
      "isDataReductionTotalSavingBlockAvailable": true,
      "dataReductionTotalSavingBlock": 13878844,
      "dataReductionSavingBlockCompression": 12134812,
      "dataReductionSavingBlockDeduplication": 808078,
      "dataReductionSavingBlockReclaim": 1076144,
      "dataReductionSystemBlock": 140190,
      "dataReductionPreUsedBlock": 23489911,
      "dataReductionPoolBlock": 9611067
    }
  ]
}

```

Attribute	Type	Description
dataReductionTotalSavingRatio	string	<p>The ratio of volume capacity reduced by using the capacity reduction function</p> <p>The capacity before data reduction is displayed as a ratio of the capacity after data reduction, where the capacity after data reduction is assigned a value of 1.</p>
isDataReductionTotalSavingBlockAvailable	boolean	<p>Whether the size of the data can be reduced</p> <ul style="list-style-type: none"> ▪ <code>true</code> : The size of the data can be reduced. <p>If the value of this attribute is <code>true</code>, the size of the data that has been reduced is displayed for the <code>dataReductionTotalSavingBlock</code> attribute.</p> <ul style="list-style-type: none"> ▪ <code>false</code> : The size of the data cannot be reduced (for example, if the size of the data after data reduction is greater than the size of the data before data reduction).
dataReductionTotalSavingBlock	long	<p>Total number of blocks reduced by using the capacity saving function</p> <p>This value is displayed when the <code>isDataReductionTotalSavingBlockAvailable</code> attribute is set to <code>true</code>.</p> <p>This value includes the amount of zero data that was reduced and the volume of metadata and garbage data generated by the storage system.</p>
dataReductionSavingBlockCompression	long	<p>Number of blocks reduced by using the capacity saving function (compression)</p> <p>The value does not include the volume of metadata and garbage data generated by the storage system.</p>
dataReductionSavingBlockDeduplication	long	<p>Number of blocks reduced by using the capacity saving function (deduplication)</p>

Attribute	Type	Description
		The value does not include the volume of metadata and garbage data generated by the storage system.
dataReductionSavingBlockReclaim	long	Number of blocks reduced by using the capacity saving function (reclaiming of the specified data pattern) The value does not include the volume of metadata and garbage data generated by the storage system.
dataReductionSystemBlock	long	Total number of blocks of system data (metadata and garbage collection) used by the capacity saving function The value does not include the volume of metadata and garbage data in the deduplication system data volumes.
dataReductionPreUsedBlock	long	Number of blocks before data reduction
dataReductionPoolBlock	long	Number of blocks in the pool volume used by the volume

Status codes

For details on the status codes of the request for this operation, see the section explaining HTTP status codes.

Coding example

```
curl -v -H "Accept:application/json" -H "Content-Type:application/json" -H "Authorization:Session d7b673af189048468c5af9bcf3b6bb6f" -X GET "https://192.0.2.100/ConfigurationManager/v1/objects/ldevs?count=2&virtualSerialNumber=410012"
```

Notes about the number of concurrent executions

A maximum of two requests to get more than 2,048 LDEVs can be run at the same time for each storage system. The HTTP status code 503 is returned for the unaccepted request. In such case, wait a while, and then run the API request again.

For API requests that obtain 2,048 or fewer LDEVs, the number of concurrent executions might be restricted due to the details of other processing to be executed at the same time. The following processing affects the number of concurrent executions:

- Processing to get resource group information
- Processing to get multiple pieces of LDEV information
- Processing to get port information (when executed with `detailInfoType=logins` specified in the query)
- Processing to get information about host groups or iSCSI targets
- Processing to get global-active device pair information
- Processing to get a list of external path groups
- Processing to get information about a specific external path group

If the above processes are running, use the following as a reference for the maximum number of requests to obtain LDEV information that can be executed at the same time:

Details of the processing being executed	Maximum number of requests that can be executed at the same time
Processing to get LDEV information (number of LDEVs: 16,384) × 1	11
Processing to get port information (number of ports: 40) × 1	10
Processing to get LDEV information (number of LDEVs: 16,384) × 1 Processing to get resource group information × 1	8
Processing to get LDEV information (number of LDEVs: 16,384) × 1 Processing to get port information (number of ports: 1) × 1	7
Processing to get LDEV information (number of LDEVs: 16,384) × 1 Processing to get resource group information × 2	6
Processing to get LDEV information (number of LDEVs: 16,384) × 1 Processing to get information about host groups or iSCSI targets (number of ports: 80) × 2	6
Processing to get LDEV information (number of LDEVs: 16,384) × 1	5

Details of the processing being executed	Maximum number of requests that can be executed at the same time
Processing to get port information (number of ports: 20) × 1	
Processing to get LDEV information (number of LDEVs: 16,384) × 2	3
Processing to get LDEV information (number of LDEVs: 16,384) × 1 Processing to get port information (number of ports: 40) × 1	2
Processing to get LDEV information (number of LDEVs: 16,384) × 2 Processing to get resource group information × 1	0 However, one request that obtains 1,024 or fewer LDEVs can be executed.

If you simultaneously execute the request to get global-active device pair information, the approximate maximum number of requests is the same as when you execute the request to get resource group information.

Setting a virtual LDEV number

The following request sets a virtual LDEV number for an LDEV.

Execution permission

Security Administrator (View & Modify)

Request line

```
POST base-URL/v1/objects/ldevs/object-ID/actions/assign-virtual-ldevid/
invoke
```

Request message

Object ID

Specify the `ldevId` value obtained by getting information about volumes.

Attribute	Type	Description
ldevId	int	(Required) Specify the LDEV number with a decimal (base 10) number.

Query parameters

None.

Body

The following coding example sets the virtual LDEV number 405 for a LDEV:

```
{
  "parameters": {
    "virtualLdevId": 405
  }
}
```

Attribute	Type	Description
virtualLdevId	int	(Required) Specify the virtual LDEV number with a decimal (base 10) number. If you specify 65535, the reserved attribute of global-active device will be set.

Response message**Body**

A job object is returned. For details on attributes other than affectedResources, see the section explaining job objects.

Attribute	Description
affectedResources	URL of the LDEV for which the virtual LDEV number is set

Action template

```
GET base-URL/v1/objects/ldevs/object-ID/actions/assign-virtual-ldevId
```

Status codes

The following table describes the meaning of the status code of the request for this operation. For details on other status codes, see the description on HTTP status codes.

Status code	Message	Description
412	Precondition Failed	The virtual LDEV number is already set for the target LDEV.

Coding example

To get an action template:

```
curl -v -H "Accept:application/json" -H "Content-Type:application/json" -H
"Authorization:Session d7b673af189048468c5af9bcf3b66b6f" -X GET https://
192.0.2.100/ConfigurationManager/v1/objects/ldevs/1/actions/assign-virtual-
ldevid
```

To run the request after getting an action template:

```
curl -v -H "Accept:application/json" -H "Content-Type:application/json" -H
"Authorization:Session d7b673af189048468c5af9bcf3b66b6f" -X POST --data-
binary @./InputParameters.json https://192.0.2.100/ConfigurationManager/v1/
objects/ldevs/1/actions/assign-virtual-ldevid/invoke
```

Deleting a virtual LDEV number

The following request deletes the virtual LDEV number set for an LDEV.

Execution permission

Security Administrator (View & Modify)

Request line

```
POST base-URL/v1/objects/ldevs/object-ID/actions/unassign-virtual-ldevid/
invoke
```

Request message**Object ID**

Specify the `ldevId` value obtained by getting information about the virtual LDEV number.

Attribute	Type	Description
ldevId	int	(Required) Specify the LDEV number with a decimal (base 10) number.

Query parameters

None.

Body

The following coding example deletes virtual LDEV number 405:

```
{
  "parameters": {
    "virtualLdevId": 405
  }
}
```

Attribute	Type	Description
virtualLdevId	int	(Required) Specify the virtual LDEV number with a decimal (base 10) number. If you specify 65535, the reserved attribute of global-active device is canceled.

Response message**Body**

A job object is returned. For details on attributes other than affectedResources, see the section explaining job objects.

Attribute	Description
affectedResources	URL of the LDEV for which the virtual LDEV number is deleted

Action template

```
GET base-URL/v1/objects/ldevs/object-ID/actions/unassign-virtual-ldevId
```

Status codes

The following table describes the meaning of the status code of the request for this operation. For details on other status codes, see the description on HTTP status codes.

Status code	Message	Description
412	Precondition Failed	The virtual LDEV number is not set for the target LDEV.

Coding example

To get an action template:

```
curl -v -H "Accept:application/json" -H "Content-Type:application/json" -H "Authorization:Session d7b673af189048468c5af9bcf3bbbb6f" -X GET https://192.0.2.100/ConfigurationManager/v1/objects/ldevs/1/actions/unassign-virtual-ldevid
```

To run the request after getting an action template:

```
curl -v -H "Accept:application/json" -H "Content-Type:application/json" -H "Authorization:Session d7b673af189048468c5af9bcf3bbbb6f" -X POST --data-binary @./InputParameters.json https://192.0.2.100/ConfigurationManager/v1/objects/ldevs/1/actions/unassign-virtual-ldevid/invoke
```

Chapter 19: Sample coding

This chapter explains the sample coding.

Overview of sample coding

This section provides sample client coding written in Python, as reference information for calling and using the REST API. The sample client coding includes basic code constructs required for client programs, including those for getting information about, creating, and changing the attributes of objects. Each sample of client coding shows an operation example such as allocating a volume or creating a copy pair. You can apply the code constructs included in the sample client coding to other use cases.

Code constructs of sample coding

The following operations are performed by the sample coding:

- Allocate a volume
In one of the samples, an HDP volume is created from an HDP pool that has already been created, and the volume is made accessible by allocating it to a host.
- Operate a ShadowImage pair
In one of the samples, volumes that have already been created are used to create a ShadowImage pair. After the pair is split, the status of the pair is verified.
- Register remote storage system information
In one of the code samples, information about the remote storage systems is registered to the REST API server of the local storage system. This is a prerequisite operation for a remote copy operation.
- Operate a TrueCopy pair
In one of the code samples, a TrueCopy pair is created by using volumes that have already been created, and the pair status is checked. A resource group is locked while the pair is being created.
- Upload files (specify the transfer destinations of audit log files)
Specify settings so that the audit log files of storage systems are transferred to the syslog server. This sample coding includes the procedure for uploading the client certificates to a storage system.

- Download a file (back up encryption keys)

Back up the encryption keys by using a REST API client. This sample coding includes the procedure for downloading an encryption backup file to a client.
- Re-create a parity group (encrypt data)

Delete an existing parity group, and then create a parity group for which encryption is enabled. This operation is performed as part of the procedure for encrypting existing data without changing the drive configuration. For details on the entire procedure, see the description of the flow of data encryption operations.

Code constructs such as the following are included in the previously listed operations:

1. Processing that is run before the REST API is called
 - Generating request bodies in JSON format
 - Creating form data
 - Specifying request headers (for the default HTTP headers or for the custom HTTP headers)
 - Setting user authentication information (for authentication by using a user ID and a password, or for authentication by using session-based authentication)
 - Getting the URLs of the resources (when object IDs are not specified, when object IDs that are obtained from the operation results are specified, or when the objects are of a single instance)
2. Processing to call the REST API
 - Getting information about the version of the REST API by performing a GET operation
 - Getting the action template by performing a GET operation
 - Changing object attributes by performing a PATCH operation
 - Running actions that use the action template by performing a POST operation
 - Running actions for objects by using the POST operation
 - Running actions for services by performing a POST operation
 - Creating objects by performing a POST operation
 - Running actions for objects by using the POST operation
 - Operations that require sessions to be generated on multiple devices (remote copy operation)
 - Deleting objects by performing a DELETE operation
3. Processing that is run after the REST API is called
 - Outputting obtained information
 - Getting job execution results
 - Getting the URLs of the resources to which the operation results have been applied

- Getting error codes
- Outputting error messages

The following table shows an example of using each code construct included in the samples. For details about each code, see the description of each sample coding.

Code constructs	Example of using sample coding	Corresponding sample coding
Generating a request body in JSON format	Define functions for issuing an HTTP request and for verifying the status of asynchronous processing.	Volume allocation Operate a ShadowImage pair
	Create an HDP volume.	Volume allocation
	Create a ShadowImage pair.	Operate a ShadowImage pair
Creating form data	Upload the root certificate of the syslog server to which audit log files are to be transferred. Upload the client certificate of the syslog server to which audit log files are to be transferred.	Upload files (specify the transfer destinations of audit log files)
Specifying request headers (for the default HTTP headers)	Define headers.	Volume allocation Operate a ShadowImage pair Register remote storage system information Operate a TrueCopy pair
Specifying request headers (for the custom HTTP headers)	Define headers.	Operate a ShadowImage pair
Setting user authentication information (for authentication by using a user ID and a password)	Generate a session.	Volume allocation Operate a ShadowImage pair Register remote storage system information

Code constructs	Example of using sample coding	Corresponding sample coding
		Operate a TrueCopy pair
Setting user authentication information (for authentication by using session-based authentication)	Define functions for issuing an HTTP request and for verifying the status of asynchronous processing.	Volume allocation Operate a ShadowImage pair
	Create an HDP volume.	Volume allocation
	Split a ShadowImage pair.	Operate a ShadowImage pair
Getting the URLs of the resources (when object IDs are not specified)	Create an HDP volume. (BlockStorageAPI.ldevs)	Volume allocation
	Create a host group. (BlockStorageAPI.host_groups)	Volume allocation
	Create a ShadowImage pair. (BlockStorageAPI.local_copy_pairs)	Operate a ShadowImage pair
Getting the URLs of the resources (when object IDs that are obtained from the operation results are specified)	Create a host group. (BlockStorageAPI.affected_resource)	Volume allocation
	Create a ShadowImage pair. (BlockStorageAPI.affected_resource)	Operate a ShadowImage pair
Getting the URLs of the resources (when fixed object IDs such as those for single instances are specified)	Specify the syslog server to which audit log files are to be transferred. (BlockStorageAPI.auditlog_syslog) Send a test message to the syslog server to which audit log files are to be transferred. (BlockStorageAPI.auditlog_syslog_send_test)	Upload files (specify the transfer destinations of audit log files)
	Download the encryption key backup file.	Download a file (back up encryption keys)

Code constructs	Example of using sample coding	Corresponding sample coding
	(BlockStorageAPI.encryption_key_file_backup)	
Getting information about the version of the REST API by performing the GET operation	Check the version of the REST API. (BlockStorageAPI.api_version)	Volume allocation Operate a ShadowImage pair Register remote storage system information Operate a TrueCopy pair
Getting an object by performing the GET operation	Get HDP volume information. (BlockStorageAPI.ldev)	Volume allocation
	Get information about a ShadowImage pair.	Operate a ShadowImage pair
Getting the action template by performing the GET operation	Split a ShadowImage pair. (BlockStorageAPI.split_local_copy_pair_template)	Operate a ShadowImage pair
Getting information about the job status by performing the GET operation	Define functions for issuing an HTTP request and for verifying the status of asynchronous processing.	Volume allocation Operate a ShadowImage pair Register remote storage system information
	Define the function for getting status changes for asynchronous processing.	Operate a TrueCopy pair
Changing the object attribute by performing the PATCH operation	Change the host mode.	Volume allocation
Running actions that use the action template by performing a POST operation	Split a ShadowImage pair. (BlockStorageAPI.split_local_copy_pair)	Operate a ShadowImage pair
Running actions for objects by using the POST operation	Send a test message to the syslog server to which audit log files are to be transferred.	Upload files (specify the transfer destinations of audit log files)

Code constructs	Example of using sample coding	Corresponding sample coding
Running actions for services by performing a POST operation	Lock resources. Unlock resources.	Operate a TrueCopy pair
Creating objects by performing a POST operation	Create an HDP volume. (BlockStorageAPI.ldevs) Register the WWN of the host. (BlockStorageAPI.host_wwns) Create a host group. (BlockStorageAPI.host_groups) Set an LU path. (BlockStorageAPI.luns)	Volume allocation
	Create a ShadowImage pair. (BlockStorageAPI.local_copy_pairs)	Operate a ShadowImage pair
Running actions for objects by using the POST operation	Upload the root certificate of the syslog server to which audit log files are to be transferred. Upload the client certificate of the syslog server to which audit log files are to be transferred.	Upload files (specify the transfer destinations of audit log files)
Operations that require sessions to be generated on multiple devices (remote copy operation)	Create a TrueCopy pair.	Operate a TrueCopy pair
Deleting objects by performing a DELETE operation	Discard the session.	Volume allocation Operate a ShadowImage pair Register remote storage system information Operate a TrueCopy pair
Outputting the obtained information	Get HDP volume information.	Volume allocation

Code constructs	Example of using sample coding	Corresponding sample coding
	Get information about a ShadowImage pair.	Operate a ShadowImage pair
Getting the job execution results	Define functions for issuing an HTTP request and for verifying the status of asynchronous processing. (BlockStorageAPI.job)	Volume allocation Operate a ShadowImage pair Register remote storage system information
	Define the function for getting status changes for asynchronous processing.	Operate a TrueCopy pair
Getting the URLs of the resources to which the operation results have been applied	Define functions for issuing an HTTP request and for verifying the status of asynchronous processing.	Volume allocation Operate a ShadowImage pair Register remote storage system information
	Define the function for getting status changes for asynchronous processing.	Operate a TrueCopy pair
Getting error codes	Define functions for issuing an HTTP request and for verifying the status of asynchronous processing.	Volume allocation Operate a ShadowImage pair Register remote storage system information
	Define the function for getting status changes for asynchronous processing.	Operate a TrueCopy pair
Outputting error messages	Output error messages.	Volume allocation Operate a ShadowImage pair Register remote storage system information Operate a TrueCopy pair

Structure of sample coding

The following operations are shared by the samples. These operations are implemented as functions, which are called and executed by the main operation. For details on each function, see the section explaining the functions used in the sample coding.

- **Generating a URL (BlockStorageAPI class)**
Creates a URL to issue an HTTP request to the storage system.
- **Issuing an HTTP request and verify the status of the asynchronous processing (invoke_async_command)**
Issues an HTTP request, verifies whether the execution results of the asynchronous processing have been applied, and then returns the result.
- **Getting status changes for asynchronous processing (wait_until_jobstatus_is_changed)**
Verifies that jobs have moved to the status specified in the parameter, and then returns the result.

Sample coding files

The following describes files that are provided as sample coding and their content:

- `provisioning.py`
This file contains sample coding for volume allocation.
- `local_copy.py`
This file contains sample coding for ShadowImage pair operations.
- `register_remote_storage.py`
This file contains sample coding for registering remote storage system information.
- `synchronous_remote_copy.py`
This file contains sample coding for TrueCopy pair operations.
- `auditlog_syslog_server_setting.py`
This file contains sample coding for uploading files (specifying the transfer destinations of audit log files).
- `backup_encryption_keys.py`
This file contains sample coding for downloading a file (backing up encryption keys).
- `recreate_parity_group.py`
This file contains sample coding for re-creating a parity group (encrypting data).
- `block_storage_api.py`
This file defines the BlockStorageAPI class.
- `rest_server_param.py`
This file defines information about the server where the REST API server is installed.
- `storage_param.py`
This file defines information about the local storage system.
- `remote_copy_param.py`
This file defines information about the remote and the local storage systems.

You can download the sample coding file from the following URL:

```
http://GUM-IP-address/download/restapi/samplecode.zip
```

Operation environment for sample coding

The samples are coded in the script language Python. Python code has excellent readability. Python is a versatile programming language widely used by Web service developers. Please download Python from the official Python website (<https://www.python.org/>) and configure the operation environment.

The code samples provided in this chapter use the standard library (json, sys, http.client, time, and traceback). Along with the standard library, you are also going to use the Requests library, which is a third-party library. Please download it from the web page for downloading the Requests library.

Note that the operations of the code samples described in this chapter have been checked in an environment of Python 3.4.2 and Requests 2.5.1.



Tip: To prevent errors that occur when the server certificate used for SSL communication between the REST API client and the storage system is a self-signed certificate, the sample coding specifies that verification of the server certificate is skipped when a request is issued.

Sample coding for volume allocation

This section explains the sample coding for volume allocation.

Sample coding operation flow for volume allocation

The following table shows the sample coding operation flow for volume allocation and the corresponding code constructs.

Step	Sample coding operation flow	Code constructs
1	Import necessary libraries and set parameters.	-
2	Define headers.	Specifying request headers (for the default HTTP headers)
3	Define functions for issuing an HTTP request and for verifying the status of asynchronous processing.	Getting information about the job status by performing a GET operation Setting user authentication information (for authentication by using session-based authentication) Generating a request body in JSON format Getting the job execution results Getting the URLs of the resources to which the operation results have been applied Getting error codes
4	Check the version of the REST API.	Getting information about the version of the REST API by performing a GET operation
5	Generate a session.	Getting the URLs of the resources (when object IDs are not specified) Setting user authentication information (for authentication by using a user ID and a password)

Step	Sample coding operation flow	Code constructs
		Creating objects by performing a POST operation
6	Create an HDP volume.	Getting the URLs of the resources (when object IDs are not specified) Setting user authentication information (for authentication by using session-based authentication) Generating a request body in JSON format Creating objects by performing a POST operation
7	Create a host group.	Getting the URLs of the resources (when object IDs are not specified) Generating a request body in JSON format Creating objects by performing a POST operation Getting the URLs of the resources (when object IDs that are automatically obtained from the operation results are specified)
8	Change the host mode.	Generating a request body in JSON format Changing the object attribute by performing a PATCH operation
9	Register the WWN of the host.	Getting the URLs of the resources (when object IDs are not specified) Generating a request body in JSON format Creating objects by performing a POST operation
10	Set an LU path.	Getting the URLs of the resources (when object IDs are not specified) Generating a request body in JSON format Creating objects by performing a POST operation
11	Get HDP volume information.	Getting an object by performing the GET operation Setting user authentication information (for authentication by using session-based authentication) Outputting the obtained information
12	Output error messages.	Outputting error messages

Step	Sample coding operation flow	Code constructs
13	Discard the session.	Getting the URLs of the resources (when object IDs that are obtained from the operation results are specified) Deleting objects by performing a DELETE operation

Expected system configuration

This sample coding assumes the system configuration is as shown in the following figure.

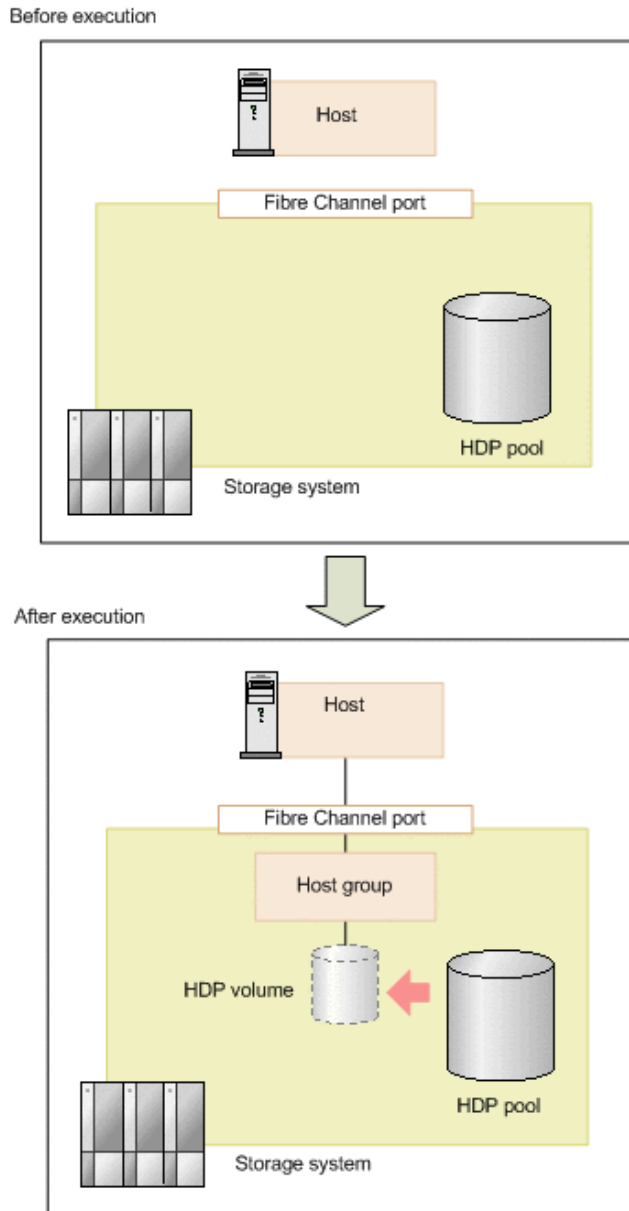

The following table shows the values specified for the parameters in the sample coding. If necessary, change the settings to match the system environment and requirements.

Parameter	Value	Description
USER_CREDENTIAL	("user1", "pass1")	This is the authentication information to be used for authentication in the storage system. The coding sample shows a setting example when the user ID is <code>user1</code> , and the password is <code>pass1</code> . The user needs the Storage Administrator (Provisioning) role.

Parameter	Value	Description
POOL_ID	8	ID of the created HDP pool which will be used to create the HDP volume
BYTE_CAPACITY	1T	Capacity of the HDP volume to be created
PORT_ID	["CL1-A"]	The array of names of the Fibre Channel port that is used for I/O with the host
HOST_GRP_NAME	WindowsHost	The host group name to be created in order to associate the host and the port
HOST_MODE	WIN	The host mode to be specified for the host group
HOST_WWN	aaaabbbbcccc 0123	The WWN of the host
FIRST_WAIT_TIME	1	The first interval (seconds) for collecting the execution result of asynchronous processing. Normally, you do not need to change this value.
MAX_RETRY_COUNT	6	The maximum number of retries for collecting the execution result of asynchronous processing. Normally, you do not need to change this value.

Contents of the sample coding

This subsection explains the sample coding.

1. Import necessary libraries and set parameters.

Before starting the volume allocation processing, the sample coding imports the required libraries or classes. In addition to the common libraries, the sample coding also imports the BlockStorageAPI class that defines the function that generates URLs.

```
# coding:utf-8

"""
provisioning

This program requires API version 1.9.0 or newer.
"""

import requests
import json
import sys
import http.client
```

```
import time
import traceback
import rest_server_param
import storage_param

from block_storage_api import BlockStorageAPI
```

Set parameters to be used in the sample coding.

```
# #####Initialize parameters##### #
# Change the following parameters to fit your environment

# A POOL ID for creating a volume
POOL_ID = 8

# The DP volume capacity to create
BYTE_CAPACITY = "1T"

# A port name to add a LUN path
PORT_ID = ["CL1-A"]

# A host group name to create
# You can assign any host group name
HOST_GRP_NAME = "WindowsHost"

# A Host mode for the created host group
# Please refer to the manual and set an appropriate mode
HOST_MODE = "WIN"

# A World Wide Name of the host (HBA) to allocate the volume
HOST_WWN = "aaaabbbbcccc0123"

# This parameter defines the first interval to access
# an asynchronous job. (Unit: Second)
FIRST_WAIT_TIME = 1

# This parameter defines the maximum retry time
# to confirm job status.
MAX_RETRY_COUNT = 6

# An user id and password of the target storage
USER_CREDENTIAL = ("user1", "pass1")

#####
```

2. Define headers.

Define the HTTP request header. Because the REST API only supports JSON format data, the sample coding defines header information so that data is handled in JSON format.

```
# ###You don't have to change the following parameters### #
block_storage_api = BlockStorageAPI(
    rest_server_param.REST_SERVER_IP_ADDR,
    rest_server_param.REST_SERVER_PORT,
    storage_param.STORAGE_MODEL,
    storage_param.SERIAL_NUMBER)

headers = {"content-type": "application/json",
          "accept": "application/json"}

REQUIRED_MAJOR_VERSION = 1
REQUIRED_MINOR_VERSION = 9

session_id = 0

#####
```

3. Define the function for issuing an HTTP request and for verifying the status of asynchronous processing (the `invoke_async_command` function).

Define the function that issues an HTTP request and verifies the status of asynchronous processing. Call and use this function from the main volume allocation operation. For details on this function, see the section explaining the functions used in the sample coding.



Tip: To prevent errors that occur when the server certificate used for SSL communication between the REST API client and the storage system is a self-signed certificate, the sample coding specifies `verify=False` in the request message to skip verification of the server certificate.

```
"""
Check whether the asynchronous command was finished.
@param job_id the job ID to identify
        the asynchronous command
@return r the response data
"""

def check_update(job_id):
    url = block_storage_api.job(str(job_id))
    r = requests.get(url, headers=headers, verify=False)
    return r
```

```
"""
Execute the HTTP request (POST or PATCH)
@param method_type HTTP request method (POST or PATCH)
@param url URL to execute HTTP method
@param body The information of a resource
@return job_result.json()["affectedResources"][0]
        URL of an affected resource
"""

def invoke_async_command(method_type, url, body):
    if method_type == "patch":
        r = requests.patch(url, headers=headers,
                           data=json.dumps(body), verify=False)
    elif method_type == "post":
        r = requests.post(
            url,
            headers=headers,
            data=json.dumps(body),
            verify=False)
    if r.status_code != http.client.ACCEPTED:
        raise requests.HTTPError(r)
    print("Request was accepted. JOB URL : " +
          r.json()["self"])
```

```
status = "Initializing"
```

```

job_result = None
retry_count = 1
wait_time = FIRST_WAIT_TIME
while status != "Completed":
    if retry_count > MAX_RETRY_COUNT:
        raise Exception("Timeout Error! "
                        "Operation was not completed.")
    time.sleep(wait_time)
    job_result = check_update(r.json()["jobId"])
    status = job_result.json()["status"]
    double_time = wait_time * 2
    if double_time < 120:
        wait_time = double_time
    else:
        wait_time = 120
    retry_count += 1
if job_result.json()["state"] == "Failed":
    error_obj = job_result.json()["error"]
    if "errorCode" in error_obj:
        if "SSB1" in error_obj["errorCode"]:
            print("Error! SSB code : ",
                  error_obj["errorCode"]["SSB1"],
                  ", ", error_obj["errorCode"]["SSB2"])
        elif "errorCode" in error_obj["errorCode"]:
            print("Error! error code : ",
                  error_obj["errorCode"]["errorCode"])
    raise Exception("Job Error!", job_result.text)

print("Async job was succeeded. affected resource : " +
      job_result.json()["affectedResources"][0])
return job_result.json()["affectedResources"][0]

```

4. Check the version of the REST API.

Get information about the version of the REST API to make sure that the version is supported.

```

"""
Check whether this API version allows the REST
Server to execute this program

@param api_version api version of this REST Server
@param required_major_version the lowest number of
    the major version that this program requires
@param required_minor_version the lowest number of
    the minor version that this program requires

"""

def check_api_version(api_version, required_major_version,
                     required_minor_version):
    version = api_version.split(".")
    major_version = int(version[0])
    minor_version = int(version[1])
    if not ((major_version == required_major_version and
             minor_version >= required_minor_version) or
            major_version >= required_major_version + 1):
        sys.exit("This program requires API Version " +
                 str(required_major_version) + "." +
                 str(required_minor_version) +
                 "." + "x or newer.\n")

try:
    # step1 Check the API version #
    print("Check the API version")
    url = block_storage_api.api_version()
    r = requests.get(url, headers=headers, verify=False)
    if r.status_code != http.client.OK:
        raise requests.HTTPError(r)
    check_api_version(
        r.json()["apiVersion"],
        REQUIRED_MAJOR_VERSION,
        REQUIRED_MINOR_VERSION)

```

5. Generate a session.

Generate sessions by using the REST API server.

```
# step2 Generate a session #
print("Generate a session")
url = block_storage_api.generate_session()
r = requests.post(url, headers=headers, auth=USER_CREDENTIAL,
                  verify=False)
if r.status_code != http.client.OK:
    raise requests.HTTPError(r)
token = r.json()["token"]
auth = "Session " + token
session_id = r.json()["sessionId"]
```

When a session is generated, a session ID and a token are returned. When running the API, specify the token for the Authentication header as the required authentication information for the subsequent operations. Use the session ID to discard the session after a set of operations is completed.

6. Create an HDP volume.

Specify the undefined LDEV number that you obtained, the pool ID, and the volume capacity, and then create the HDP volume.

```
# step3 Add an LDEV #
print("Add an LDEV")
url = block_storage_api.ldevs()
headers["Authorization"] = auth
body = {
    "poolId": POOL_ID,
    "byteFormatCapacity": BYTE_CAPACITY,
    "isParallelExecutionEnabled": True
}
ldev_id = invoke_async_command("post", url, body).split("/")[-1]
```

The `invoke_async_command` function issues the request to create the HDP volume, checks the execution status of the jobs that were run asynchronously, and then returns the URL of the created HDP volume as the execution result.

7. Create a host group.

To allocate the created HDP volume to the host, create a host group. The sample coding only specifies the port number to be used by the host group and the host group name. Specification of the host group number is omitted. In this case, a host group number is automatically assigned.

```
# step4 Add a host group #
print("Add a host group")
url = block_storage_api.host_groups()
body = {
    "portId": PORT_ID[0],
    "hostGroupName": HOST_GRP_NAME
}
affected_resource_path = invoke_async_command("post",
                                             url, body)
```

Get the URL of the created host group and the assigned host group number.

```
url = block_storage_api.affected_resource(
    affected_resource_path)

r = requests.get(url, headers=headers, verify=False)
if r.status_code != http.client.OK:
    raise requests.HTTPError(r)

host_group_number = r.json()["hostGroupName"]
```

8. Change the host mode.

Change the host mode of the created host group according to the platform of the host to which the volume will be allocated. To issue a request to change the host mode, use the URL of the host group that was obtained in the step when the host group was created.

```
# step5 Modify the host group #
print("Modify the host group")
body = {
    "hostMode": HOST_MODE
}
invoke_async_command("patch", url, body)
```

9. Register the WWN of the host.

Register the host to which the HDP volume will be allocated in the host group that you created. Specify the WWN of the HBA of the host to be registered, the port number of the host group, and the assigned host group number. Use the host group number that was obtained when the host group was created.

```
# step6 Add an HBA WWN #
print("Add an HBA WWN")
url = block_storage_api.host_wwns()
body = {
    "hostWwn": HOST_WWN,
    "portId": PORT_ID[0],
    "hostGroupNumber": host_group_number
}
invoke_async_command("post", url, body)
```

10. Set an LU path.

Set the LU path by associating the created volume with the host group. The sample coding specifies the LDEV number of the created HDP volume, the port number to be used by the host group, and the host group number. Specification of the LUN is omitted. In this case, a LUN is automatically assigned.

```
# step7 Add a LUN path #
print("Add a LUN path")
url = block_storage_api.luns()
body = {
    "ldevId": ldev_id,
    "portIds": PORT_ID,
    "hostGroupNumber": host_group_number
}
invoke_async_command("post", url, body)
```

The LU path is set, and the HDP volume is now accessible from the host.

11. Get HDP volume information.

To check whether the operations up to this step have been correctly applied to the resource, specify the LDEV number that was obtained when the HDP volume was created, and then obtain HDP volume information. From the collected information, the sample coding outputs the LDEV number, the ID of the pool from which the volume was created, the capacity of the HDP volume, and the assigned port.

```
# step8 Print the LDEV #
print("Print the LDEV")
url = block_storage_api.ldev(ldev_id)
r = requests.get(url, headers=headers, verify=False)
if r.status_code != http.client.OK:
    raise requests.HTTPError(r)

print("LDEV ID : " + str(r.json()["ldevId"]))
print("POOL ID : " + str(r.json()["poolId"]))
print("CAPACITY : " +
      str(r.json()["byteFormatCapacity"]))
print("PORT : " + str(r.json()["ports"]))
print()
```

12. Output error messages.

In the sample coding, processing for communication errors, HTTP request errors, and job execution errors is described. If a communication error occurs, an error message is output. If an HTTP request error occurs, the error code, the error message, and the response body are output. If a job execution error occurs, all of the contents included in the job execution result are output.

```
except requests.ConnectionError:
    sys.stderr.write("Connection Error!\n")
    sys.stderr.write(traceback.format_exc())
except requests.HTTPError as he:
    sys.stderr.write("HTTP Error! status code : ")
    sys.stderr.write(str(he.args[0].status_code) + "\n")
    sys.stderr.write(he.args[0].text + "\n")
except Exception as e:
    sys.stderr.write(traceback.format_exc())
    for msg in e.args:
        sys.stderr.write(str(msg) + "\n")
```

13. Discard the session.

After a set of operations is completed, discard the session. Specify the session ID that was obtained when the session was generated. The "finally" statement in the sample coding makes sure that the session will be discarded even if an error occurs while the API is running. After the session is discarded, the processing ends.

```
finally:
    # ----step10 Discard the session----#
    print("Discard the session")
    url = block_storage_api.discard_session(session_id)
    r = requests.delete(url, headers=headers, verify=False)
    try:
        if r.status_code != http.client.OK:
            raise requests.HTTPError(r)
    except requests.HTTPError as he:
        sys.stderr.write("HTTP Error! status code : ")
        sys.stderr.write(str(he.args[0].status_code) + "\n")
        sys.stderr.write(he.args[0].text + "\n")

    print("Operation was completed.")
    sys.exit()
```

Sample coding for ShadowImage pair operations

This section explains the sample coding for the ShadowImage pair operations.

Sample coding operation flow for ShadowImage pair operations

The following table shows the sample coding operation flow for ShadowImage pair operations and the corresponding code constructs.

Step	Sample coding operation flow	Code constructs
1	Import necessary libraries and set parameters.	-
2	Define headers.	Specifying request headers (for the default HTTP headers) Specifying request headers (for the custom HTTP headers)
3	Define functions for issuing an HTTP request and for verifying the status of asynchronous processing.	Getting information about the job status by performing a GET operation Setting user authentication information (for authentication by using session-based authentication) Generating a request body in JSON format

Step	Sample coding operation flow	Code constructs
		Getting the job execution results Getting the URLs of the resources to which the operation results have been applied Getting error codes
4	Check the version of the REST API.	Getting information about the version of the REST API by performing a GET operation
5	Generate a session.	Getting the URLs of the resources (when object IDs are not specified) Setting user authentication information (for authentication by using a user ID and a password) Creating objects by performing a POST operation
6	Create a ShadowImage pair.	Getting the URLs of the resources (when object IDs are not specified) Getting the URLs of the resources (when object IDs that are obtained from the operation results are specified) Generating a request body in JSON format Creating objects by performing a POST operation
7	Split a ShadowImage pair.	Getting the action template by performing a GET operation Setting user authentication information (for authentication by using session-based authentication) Generating a request body in JSON format Running actions that use the action template by using a POST operation
8	Get information about a ShadowImage pair.	Getting an object by performing a GET operation Setting user authentication information (for authentication by using session-based authentication) Outputting the obtained information
9	Output error messages.	Outputting error messages
10	Discard the session.	Getting the URLs of the resources (when object IDs that are obtained from the operation results are specified)

Step	Sample coding operation flow	Code constructs
		Deleting objects by performing a DELETE operation

Expected system configuration

This sample coding assumes the system configuration is as shown in the following figure.

Before execution

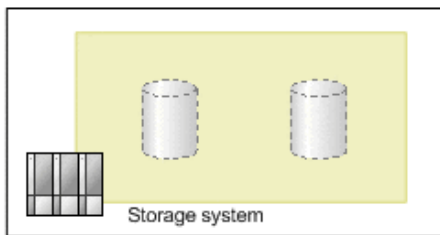

After the pair is created

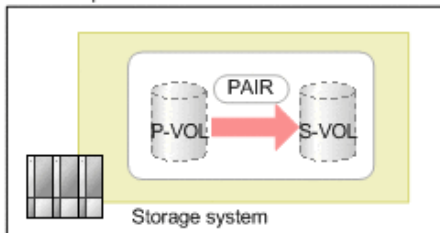

After the pair is split

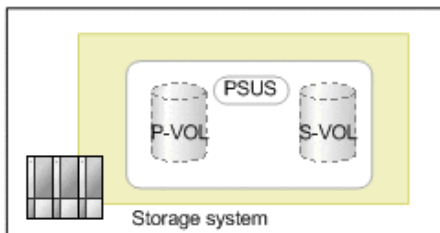

(Legend)



: Volume



: Copy group



: Pair status



: Data copy direction

The following table shows the values specified for the parameters in the sample coding. If necessary, change the settings to match the system environment and requirements.

Parameter	Value	Description
USER_CREDENTIAL	("user1", "pass1")	This is the authentication information to be used for authentication in the storage system. The coding sample shows a setting example when the user ID is <code>user1</code> , and the password is <code>pass1</code> . The user needs the Storage Administrator (Provisioning) role and the Storage Administrator (Local Copy) role.
COPY_GROUP_NAME	SI_347	The copy group name to be used for creating a ShadowImage pair. In the sample coding, a new copy group is created when creating a pair.
COPY_PAIR_NAME	p_347-348	The copy pair name of the ShadowImage pair to be created
PVOL_LDEV_ID	347	The LDEV number of the already created volume to be used as the primary volume
SVOL_LDEV_ID	348	The LDEV number of the already created volume to be used as the secondary volume
FIRST_WAIT_TIME	1	The first interval for collecting the execution result of asynchronous processing. Normally, you do not need to change this value.
MAX_RETRY_COUNT	10	The maximum number of retries for collecting the execution result of asynchronous processing. Normally, you do not need to change this value.

Contents of the sample coding

This subsection explains the sample coding.

1. Import necessary libraries and set parameters.

Before performing operations for the ShadowImage pair, the sample coding imports the required libraries or classes. In addition to the common libraries, the sample coding also imports the BlockStorageAPI class that defines the function that generates URLs.

```
# coding:utf-8

"""
local_copy

This program requires API version 1.9.0 or newer.
"""

import traceback
import requests
import json
import sys
import http.client
import time
import rest_server_param
import storage_param

from block_storage_api import BlockStorageAPI
```

Set parameters to be used in the sample coding.

```
# #####Initialize parameters##### #
# Change the following parameters to fit your environment

# A copy group name
COPY_GROUP_NAME = "SI_347"

# A copy pair name
COPY_PAIR_NAME = "p_347-348"

# A primary volume ID
# Specify already created and allocated volume ID by decimal
PVOL_LDEV_ID = 347

# A secondary volume ID which has the exactly same size
# as the primary volume
# Specify already created and allocated volume ID by decimal
SVOL_LDEV_ID = 348

# This parameter defines the first interval to access
# an asynchronous job. (Unit: Second)
FIRST_WAIT_TIME = 1

# This parameter defines the maximum retry time
# to confirm job status.
MAX_RETRY_COUNT = 10

# An user id and password of the target storage
USER_CREDENTIAL = ("user1", "pass1")

#####
```

2. Define headers.

Define the HTTP request header. Because the REST API only supports JSON format data, the sample coding defines header information so that data is handled in JSON format. In addition, for asynchronous processing, the sample coding specifies the settings of the Response-Job-Status header so that responses are returned after waiting for the completion of the jobs.

```
# ###You don't have to change the following parameters### #
block_storage_api = BlockStorageAPI(
    rest_server_param.REST_SERVER_IP_ADDR,
    rest_server_param.REST_SERVER_PORT,
    storage_param.STORAGE_MODEL,
    storage_param.SERIAL_NUMBER)

headers = {"content-type": "application/json",
          "accept": "application/json",
          "Response-Job-Status": "Completed"}

REQUIRED_MAJOR_VERSION = 1
REQUIRED_MINOR_VERSION = 9

session_id = 0

#####
```

3. Define the function for issuing an HTTP request and for verifying the status of asynchronous processing (the `invoke_async_command` function).

Define the function that issues an HTTP request and verifies the status of asynchronous processing. Call and use this function from the main ShadowImage pair operation. For details on this function, see the section explaining the of functions used in the sample coding.



Tip: To prevent errors that occur when the server certificate used for SSL communication between the REST API client and the storage system is a self-signed certificate, the sample coding specifies `verify=False` in the request message to skip verification of the server certificate.

```

"""
Check whether the asynchronous command was finished.
@param job_id The job ID to identify
               the asynchronous command
@return r.json() The JSON data that contains response data
"""

def check_update(job_id):
    url = block_storage_api.job(str(job_id))
    r = requests.get(url, headers=headers, verify=False)
    return r

"""
Execute the HTTP request (POST or PATCH)
@param method_type HTTP request method (POST or PATCH)
@param url URL to execute HTTP method
@param body The information of a resource
@return job_result.json()["affectedResources"][0]
        URL of an affected resource
"""

def invoke_async_command(method_type, url, body):
    if method_type == "patch":
        r = requests.patch(url, headers=headers,
                          data=json.dumps(body), verify=False)
    elif method_type == "post":
        r = requests.post(
            url,
            headers=headers,
            data=json.dumps(body),
            verify=False)
    if r.status_code != http.client.ACCEPTED:
        raise requests.HTTPError(r)
    print("Request was accepted. JOB URL : " +
          r.json()["self"])
    status = "Initializing"

```

```

job_result = None
retry_count = 1
wait_time = FIRST_WAIT_TIME
while status != "Completed":
    if retry_count > MAX_RETRY_COUNT:
        raise Exception("Timeout Error! "
                        "Operation was not completed.")
    time.sleep(wait_time)
    job_result = check_update(r.json()["jobId"])
    status = job_result.json()["status"]
    double_time = wait_time * 2
    if double_time < 120:
        wait_time = double_time
    else:
        wait_time = 120
    retry_count += 1
if job_result.json()["state"] == "Failed":
    error_obj = job_result.json()["error"]
    if "errorCode" in error_obj:
        if "SSB1" in error_obj["errorCode"]:
            print("Error! SSB code : ",
                  error_obj["errorCode"]["SSB1"],
                  ", ", error_obj["errorCode"]["SSB2"])
        elif "errorCode" in error_obj["errorCode"]:
            print("Error! error code : ",
                  error_obj["errorCode"]["errorCode"])
        raise Exception("Job Error!", job_result.text)
print("Async job was succeeded. affected resource : " +
      job_result.json()["affectedResources"][0])
return job_result.json()["affectedResources"][0]

```

4. Check the version of the REST API.

Get information about the version of the REST API to make sure that the version is supported.

```

"""
Check whether this API version allows the REST
Server to execute this program

@param api_version api version of this REST Server
@param required_major_version the lowest number of
    the major version that this program requires
@param required_minor_version the lowest number of
    the minor version that this program requires

"""

def check_api_version(api_version, required_major_version,
                    required_minor_version):
    version = api_version.split(".")
    major_version = int(version[0])
    minor_version = int(version[1])
    if not ((major_version == required_major_version and
            minor_version >= required_minor_version) or
            major_version >= required_major_version + 1):
        sys.exit(
            "This program requires API Version " +
            str(required_major_version) +
            "." +
            str(required_minor_version) +
            "." +
            "x or newer.\n")

try:
    # step1 Check the API version #
    print("Check the API version")
    url = block_storage_api.api_version()
    r = requests.get(url, headers=headers, verify=False)
    if r.status_code != http.client.OK:
        raise requests.HTTPError(r)
    check_api_version(
        r.json()["apiVersion"],
        REQUIRED_MAJOR_VERSION,
        REQUIRED_MINOR_VERSION)

```

5. Generate a session.

Generate sessions by using the REST API server.

```
# step2 Generate a session #
print("Generate a session")
url = block_storage_api.generate_session()
r = requests.post(url, headers=headers,
                  auth=USER_CREDENTIAL, verify=False)
if r.status_code != http.client.OK:
    raise requests.HTTPError(r)
token = r.json()["token"]
auth = "Session " + token
session_id = r.json()["sessionId"]
```

When a session is generated, a session ID and a token are returned. When running the API, specify the token for the Authentication header as the required authentication information for the subsequent operations. Use the session ID to discard the session after a set of operations is completed.

6. Create a ShadowImage pair.

Use the already created volumes to create a ShadowImage pair. Also create a new copy group. Specify the copy group name, copy pair name, and the LDEV number of the volume to be used that are defined in advance in the parameters. In addition, specify the copy pair type, MU number, and whether to create a copy group, and then issue a request to create a ShadowImage pair. The `block_storage_api` function is used to generate the URL.

```
# step3 Create a local copy pair #
print("Create a local copy pair")
url = block_storage_api.local_copy_pairs()
body = {
    "copyGroupName": COPY_GROUP_NAME,
    "copyPairName": COPY_PAIR_NAME,
    "replicationType": "SI",
    "pvolLdevId": PVOL_LDEV_ID,
    "pvolMuNumber": 0,
    "svolLdevId": SVOL_LDEV_ID,
    "isNewGroupCreation": True,
}
headers["Authorization"] = auth
affected_resource = invoke_async_command("post",
                                        url, body)
pair_url = block_storage_api.affected_resource(
    affected_resource)
```

The `invoke_async_command` function issues the request to create a ShadowImage pair under the specified conditions, checks the execution status of the jobs that were run asynchronously, and then returns the URL of the created pair as the execution result.

7. Split the ShadowImage pair.

In the sample coding, a ShadowImage pair is split by using the action template. First, get the action template for splitting a ShadowImage pair by using the URL of the pair that was obtained when the ShadowImage pair was created.

```
# step4 Split the local copy pair #
print("Split the local copy pair")
url = block_storage_api.split_local_copy_pair_template(
    pair_url)
r = requests.get(url, headers=headers, verify=False)
if r.status_code != http.client.OK:
    raise requests.HTTPError(r)
print("Action template(split):")
print(r.text)
```

Set values in the obtained template, and then issue a request to split the created ShadowImage pair.

```
body = r.json()
body["parameters"]["copyPace"] = 3
split_url = block_storage_api.split_local_copy_pair(
    pair_url)
invoke_async_command("post", split_url, body)
```

8. Get information about the ShadowImage pair.

Get information about the pair by using the URL of the pair that was obtained when the ShadowImage pair was created. In the sample coding, the following items are output: the copy group name, copy pair name, LDEV number and pair volume status for the P-VOL, and the LDEV number and pair volume status for the S-VOL.

```
# step5 Print the pair status #
print("Print the pair status")
r = requests.get(pair_url,
    headers=headers, verify=False)
if r.status_code != http.client.OK:
    raise requests.HTTPError(r)

print("COPY GROUP NAME : " + r.json()["copyGroupName"])
print("COPY PAIR NAME : " + r.json()["copyPairName"])
print("P-VOL LDEV ID : " + str(r.json()["pvolldevId"]))
print("S-VOL LDEV ID : " + str(r.json()["svolldevId"]))
print("P-VOL STATUS : " + r.json()["pvolStatus"])
print("S-VOL STATUS : " + r.json()["svolStatus"])
print("LOCAL CLONE COPY PAIR ID : " +
    r.json()["localCloneCopypairId"])
print()
```

9. Output error messages.

In the sample coding, processing for communication errors, HTTP request errors, and job execution errors is described. If a communication error occurs, an error message is output. If an HTTP request error occurs, the error code, the error message, and the response body are output. If a job execution error occurs, all of the contents included in the job execution result are output.

```
except requests.ConnectionError:
    sys.stderr.write("Connection Error!\n")
    sys.stderr.write(traceback.format_exc())
except requests.HTTPError as he:
    sys.stderr.write("HTTP Error! status code : ")
    sys.stderr.write(str(he.args[0].status_code) + "\n")
    sys.stderr.write(he.args[0].text + "\n")
except Exception as e:
    sys.stderr.write(traceback.format_exc())
    for msg in e.args:
        sys.stderr.write(str(msg) + "\n")
```

10. Discard the session.

After a set of operations is completed, discard the session. Specify the session ID that was obtained when the session was generated. The "finally" statement in the sample coding makes sure that the session will be discarded even if an error occurs while the API is running. After the session is discarded, the processing ends.

```
finally:
    # step6 Discard the session #
    print("Discard the session")
    url = block_storage_api.discard_session(session_id)
    r = requests.delete(url, headers=headers, verify=False)
    try:
        if r.status_code != http.client.OK:
            raise requests.HTTPError(r)
    except requests.HTTPError as he:
        sys.stderr.write("HTTP Error! status code : ")
        sys.stderr.write(str(he.args[0].status_code) + "\n")
        sys.stderr.write(he.args[0].text + "\n")

    print("Operation was completed.")
    sys.exit()
```

Sample coding for registering remote storage system information

This section explains the sample coding for registering remote storage system information.

Sample coding operation flow for registering remote storage system information

The following table shows the sample coding operation flow for registering remote storage system information and the corresponding code constructs.

Step	Sample coding operation flow	Code constructs
1	Import necessary libraries and set parameters.	-
2	Define headers.	Specifying request headers (for the default HTTP headers)
3	Define functions for issuing an HTTP request and for verifying the status of asynchronous processing.	Getting information about the job status by performing a GET operation Setting user authentication information (for authentication by using session-based authentication) Generating a request body in JSON format Getting the job execution results Getting the URLs of the resources to which the operation results have been applied Getting error codes
4	Check the version of the REST API.	Getting information about the version of the REST API by performing a GET operation
5	Generate a session.	Getting the URLs of the resources (when object IDs are not specified) Setting user authentication information (for authentication by using a user ID and a password) Creating objects by performing a POST operation
6	Register information about storage systems.	Getting the URLs of the resources (when object IDs are not specified) Generating a request body in JSON format Operations that require sessions to be generated on multiple devices (remote copy operation) Creating objects by performing a POST operation
7	Get information about storage systems.	Getting the URLs of the resources (when object IDs that are obtained from the operation results are specified)

Step	Sample coding operation flow	Code constructs
		Setting user authentication information (for authentication by using session-based authentication) Getting an object by performing a GET operation Outputting the obtained information
8	Output error messages.	Outputting error messages
9	Discard the session.	Getting the URLs of the resources (when object IDs that are obtained from the operation results are specified) Deleting objects by performing a DELETE operation

Expected system configuration

This sample coding assumes the system configuration is as shown in the following figure.

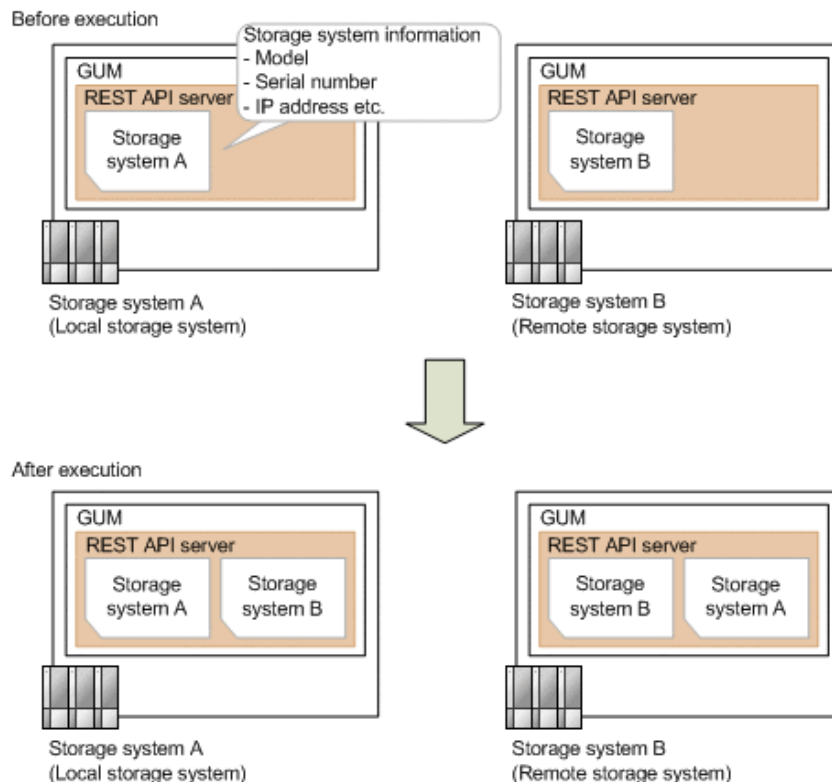

The following table shows the values specified for the parameters in the sample coding. If necessary, change the settings to match the system environment and requirements.

Parameter	Value	Description
LOCAL_USER_CREDENTIAL	("local_user", "local_pass")	This is the authentication information to be used for authentication in the local storage system. The coding sample shows a setting example when the user ID is <code>local_user</code> , and the password is <code>local_pass</code> . The user needs the Storage Administrator (Initial Configuration) role.
REMOTE_USER_CREDENTIAL	("remote_user", "remote_pass")	This is the authentication information to be used for authentication in the remote storage system. The coding sample shows a setting example when the user ID is <code>remote_user</code> , and the password is <code>remote_pass</code> . The user needs the Storage Administrator (Initial Configuration) role.
FIRST_WAIT_TIME	1	The first interval for collecting the execution result of asynchronous processing. Normally, you do not need to change this value.
MAX_RETRY_COUNT	10	The maximum number of retries for collecting the execution result of asynchronous processing. Normally, you do not need to change this value.

The following table shows the parameters and values defined in the `remote_copy_param.py` file, which can be used in coding samples as common variables for the information about the local and the remote storage systems. If necessary, change the settings to match the system environment and requirements.

Parameter	Value	Description
LOCAL_REST_SERVER_IP_ADDR	192.0.2.100	The IP address of the REST API server of the local storage system
LOCAL_PORT	443	The SSL communication port for the REST API server of the local storage system
LOCAL_STORAGE_MODEL	VSP G900	The model name of the local storage system
LOCAL_SERIAL_NUMBER	410000	The serial number of the local storage system
REMOTE_REST_SERVER_IP_ADDR	192.0.2.200	The IP address of the REST API server of the remote storage system

Parameter	Value	Description
REMOTE_PORT	443	The SSL communication port for the REST API server of the remote storage system
REMOTE_STORAGE_MODEL	VSP G900	The model name of the remote storage system
REMOTE_SERIAL_NUMBER	420000	The serial number of the remote storage system

Contents of the sample coding

This subsection explains the sample coding.

1. Import necessary libraries and set parameters.

Before starting the registration processing of remote storage system information, the sample coding imports the required libraries or classes. In addition to the common libraries, the sample coding also imports the BlockStorageAPI class that defines the function that generates URLs.

```
# coding:utf-8

"""
register_remote_storage

This program requires API version 1.9.0 or newer.
"""

import traceback
import requests
import json
import sys
import http.client
import time
import remote_copy_param

from block_storage_api import BlockStorageAPI
```

Set parameters to be used in the sample coding.

```
# #####Initialize parameters##### #
# Change the following parameters to fit your environment

# This parameter defines the first interval to access
# an asynchronous job. (Unit: Second)
FIRST_WAIT_TIME = 1

# This parameter defines the maximum retry time
# to confirm job status.
MAX_RETRY_COUNT = 10

# An user id and password of the local storage
LOCAL_USER_CREDENTIAL = ("local_user", "local_pass")

# An user id and password of the remote storage
REMOTE_USER_CREDENTIAL = ("remote_user", "remote_pass")

#####
```

2. Define headers.

Define the HTTP request header. Because the REST API only supports JSON format data, the sample coding defines header information so that data is handled in JSON format.

```
# ###You don't have to change the following parameters### #
local_storage_api = BlockStorageAPI(
    remote_copy_param.LOCAL_REST_SERVER_IP_ADDR,
    remote_copy_param.LOCAL_PORT,
    remote_copy_param.LOCAL_STORAGE_MODEL,
    remote_copy_param.LOCAL_SERIAL_NUMBER)

remote_storage_api = BlockStorageAPI(
    remote_copy_param.REMOTE_REST_SERVER_IP_ADDR,
    remote_copy_param.REMOTE_PORT,
    remote_copy_param.REMOTE_STORAGE_MODEL,
    remote_copy_param.REMOTE_SERIAL_NUMBER)

local_headers = {"content-type": "application/json",
                 "accept": "application/json",
                 "Response-Job-Status": "Completed"}

remote_headers = {"content-type": "application/json",
                  "accept": "application/json",
                  "Response-Job-Status": "Completed"}

REQUIRED_MAJOR_VERSION = 1
REQUIRED_MINOR_VERSION = 9

local_session_id = 0
remote_session_id = 0

#####
```

3. Define the function for issuing an HTTP request and for verifying the status of asynchronous processing (the `invoke_async_command` function).

Define the function that issues an HTTP request and verifies the status of asynchronous processing. Call and use this function from the main registration operation of the remote storage system information. For details on this function, see the section explaining the functions used in the sample coding.



Tip: To prevent errors that occur when the server certificate used for SSL communication between the REST API client and the storage system is a self-signed certificate, the sample coding specifies `verify=False` in the request message to skip verification of the server certificate.

```
"""
Check whether the asynchronous command was finished.

@param storage_api storage_api
@param job_id the job ID to identify
```



```

the asynchronous command
@param headers the array of the http headers
@return r the response data
"""

def check_update(storage_api, job_id, headers):
    url = storage_api.job(str(job_id))
    r = requests.get(url, headers=headers, verify=False)
    return r

"""
Execute the HTTP request (POST or PATCH)

@param storage_api storage_api
@param method_type HTTP request method (POST or PATCH)
@param headers the array of the http headers
@param url URL to execute HTTP method
@param body The information of a resource
@return job_result.json()["affectedResources"][0]
        URL of an affected resource
"""

def invoke_async_command(storage_api, method_type, headers,
                        url, body):
    if method_type == "patch":
        r = requests.patch(url, headers=headers,
                          data=json.dumps(body), verify=False)
    elif method_type == "post":
        r = requests.post(
            url,
            headers=headers,
            data=json.dumps(body),
            verify=False)
    if r.status_code != http.client.ACCEPTED:
        raise requests.HTTPError(r)
    print("Request was accepted. JOB URL : " +
          r.json()["self"])
    status = "Initializing"
    job_result = None
    retry_count = 1
    wait_time = FIRST_WAIT_TIME
    while status != "Completed":
        if retry_count > MAX_RETRY_COUNT:
            raise Exception("Timeout Error! "
                            "Operation was not completed.")
        time.sleep(wait_time)
        job_result = check_update(storage_api,
                                 r.json()["jobId"], headers)
        status = job_result.json()["status"]

```

```
double_time = wait_time * 2
if double_time < 120:
    wait_time = double_time
else:
    wait_time = 120
retry_count += 1
if job_result.json()["state"] == "Failed":
    error_obj = job_result.json()["error"]
    if "errorCode" in error_obj:
        if "SSB1" in error_obj["errorCode"]:
            print("Error! SSB code : ",
                  error_obj["errorCode"]["SSB1"],
                  ", ", error_obj["errorCode"]["SSB2"])
        elif "errorCode" in error_obj["errorCode"]:
            print("Error! error code : ",
                  error_obj["errorCode"]["errorCode"])
        raise Exception("Job Error!", job_result.text)
    print("Async job was succeeded. affected resource : " +
          job_result.json()["affectedResources"][0])
    return job_result.json()["affectedResources"][0]
```

4. Check the version of the REST API.

Get information about the version of the REST API for both the local and the remote storage systems by using the REST API server of each system to make sure that the version is supported.

```

"""
Check whether this API version allows the REST
Server to execute this program

@param api version api_version of this REST Server
@param required_major_version the lowest number of
the major version that this program requires
@param required_minor_version the lowest number of
the minor version that this program requires

"""

def check_api_version(api_version, required_major_version,
                     required_minor_version):
    version = api_version.split(".")
    major_version = int(version[0])
    minor_version = int(version[1])
    if not ((major_version == required_major_version and
             minor_version >= required_minor_version) or
            major_version >= required_major_version + 1):
        sys.exit("This program requires API Version " +
                str(required_major_version) + "." +
                str(required_minor_version) +
                "." + "x or newer.\n")

try:
    # step1 Check the API version of the local REST API #
    print("Check the API version of the local REST API")
    url = local_storage_api.api_version()
    r = requests.get(url, headers=local_headers,
                    verify=False)
    if r.status_code != http.client.OK:
        raise requests.HTTPError(r)
    check_api_version(r.json()["apiVersion"],
                    REQUIRED_MAJOR_VERSION,
                    REQUIRED_MINOR_VERSION)

    # step1 Check the API version of the remote REST API #
    print("Check the API version of the remote REST API")
    url = remote_storage_api.api_version()
    r = requests.get(url, headers=remote_headers,
                    verify=False)
    if r.status_code != http.client.OK:
        raise requests.HTTPError(r)
    check_api_version(r.json()["apiVersion"],
                    REQUIRED_MAJOR_VERSION,

```

```
REQUIRED_MINOR_VERSION)
```

5. Generate a session.

Generate a session in both the local and the remote storage systems by using the REST API server of each system.

```
# step2 Generate a local session #
print("Generate a local session")
url = local_storage_api.generate_session()
r = requests.post(
    url,
    headers=local_headers,
    auth=LOCAL_USER_CREDENTIAL,
    verify=False)
if r.status_code != http.client.OK:
    raise requests.HTTPError(r)
local_token = r.json()["token"]
local_auth = "Session " + local_token
local_session_id = r.json()["sessionId"]

# step2 Generate a remote session #
print("Generate a remote session")
url = remote_storage_api.generate_session()
r = requests.post(url, headers=remote_headers,
    auth=REMOTE_USER_CREDENTIAL,
    verify=False)
if r.status_code != http.client.OK:
    raise requests.HTTPError(r)
remote_token = r.json()["token"]
remote_auth = "Session " + remote_token
remote_session_id = r.json()["sessionId"]
remote_headers["Authorization"] = remote_auth
```

When a session is generated, a session ID and a token are returned. When running the API, specify the token for the Authentication header as the required authentication information for the subsequent operations. Use the session ID to discard the session after a set of operations is completed.

6. Register information about the remote storage system

Register information about the remote storage system on the REST API server of the local storage system. For the request body, specify information about the remote storage system.

```
# step3 Register a remote storage device #
print("Register a remote storage device")
url = local_storage_api.remote_storage()
body = {
    "storageDeviceId": remote_storage_api.
    get_storage_id(),
    "restServerIp":
        remote_copy_param.REMOTE_REST_SERVER_IP_ADDR,
    "restServerPort": remote_copy_param.REMOTE_PORT
}
local_headers["Authorization"] = local_auth
local_headers["Remote-Authorization"] = remote_auth
affected_resource_path = invoke_async_command(
    local_storage_api, "post",
    local_headers, url, body)
```

The `invoke_async_command` function issues a request for registering information about the remote storage system, verifies the execution status of the jobs that were run asynchronously, and then returns the URL of the registered storage system as the execution result.

7. Get information about the registered remote storage system.

To confirm that information about the remote storage system is correctly registered, get the registered storage information by using the REST API server of the local storage system.

```
# step4 Print the remote storage device #
print("Print the remote storage device")
url = local_storage_api.affected_resource(
    affected_resource_path)
r = requests.get(url, headers=local_headers,
    verify=False)
if r.status_code != http.client.OK:
    raise requests.HTTPError(r)
print("STORAGE DEVICE ID : " +
    str(r.json()["storageDeviceId"]))
print("DKC TYPE : " + str(r.json()["dkcType"]))
print("REST SERVER IP : " + str(r.json()["restServerIp"]))
print("REST SERVER PORT : " +
    str(r.json()["restServerPort"]))
print("MODEL : " + str(r.json()["model"]))
print("SERIAL NUMBER : " +
    str(r.json()["serialNumber"]))
```

In the sample coding, the following items are obtained and output: storage device ID, storage system type, IP address of the REST API server for the remote storage system, port number of the REST API server for the remote storage system, model name, and serial number.

8. Output error messages.

In the sample coding, processing for communication errors, HTTP request errors, and job execution errors is described. If a communication error occurs, an error message is output. If an HTTP request error occurs, the error code, the error message, and the response body are output. If a job execution error occurs, all of the contents included in the job execution result are output.

```
except requests.ConnectionError:
    sys.stderr.write("Connection Error!\n")
    sys.stderr.write(traceback.format_exc())
except requests.HTTPError as he:
    sys.stderr.write("HTTP Error! status code : ")
    sys.stderr.write(str(he.args[0].status_code) + "\n")
    sys.stderr.write(he.args[0].text + "\n")
except Exception as e:
    sys.stderr.write(traceback.format_exc())
    for msg in e.args:
        sys.stderr.write(str(msg) + "\n")
```

9. Discard the session.

After a set of operations is completed, discard the session by using the REST API server of both the local and the remote storage systems. Specify the session ID that was obtained when the session was created. The "finally" statement in the sample coding makes sure that the session will be discarded even if an error occurs while the API is running. After the session is discarded, the processing ends.

```
finally:
    # step5 Discard the local session #
    print("Discard the local session")
    url = local_storage_api.discard_session(
        local_session_id)
    r = requests.delete(url, headers=local_headers,
                        verify=False)
    if r.status_code != http.client.OK:
        raise requests.HTTPError(r)

    # step5 Discard the remote session #
    print("Discard the remote session")
    url = remote_storage_api.discard_session(
        remote_session_id)
    r = requests.delete(url, headers=remote_headers,
                        verify=False)
    if r.status_code != http.client.OK:
        raise requests.HTTPError(r)

    print("Operation was completed.")
    sys.exit()
```

Sample coding for TrueCopy pair operations

This section explains the sample coding for the TrueCopy pair operations.

Sample coding operation flow for TrueCopy pair operations

The following table shows the sample coding operation flow for TrueCopy pair operations and the corresponding code constructs.

Step	Sample coding operation flow	Code constructs
1	Import necessary libraries and set parameters.	-
2	Define headers.	Specifying request headers (for the default HTTP headers)
3	Define the function for getting status changes for asynchronous processing.	Getting information about the job status by performing a GET operation

Step	Sample coding operation flow	Code constructs
		Setting user authentication information (for authentication by using session-based authentication) Getting the job execution results Getting error codes
4	Check the version of the REST API.	Getting information about the version of the REST API by performing a GET operation
5	Generate a session.	Getting the URLs of the resources (when object IDs are not specified) Setting user authentication information (for authentication by using a user ID and a password) Creating objects by performing a POST operation
6	Lock resources.	Getting the URLs of the resources (when object IDs are not specified) Setting user authentication information (for authentication by using session-based authentication) Running actions for services by performing a POST operation
7	Create a TrueCopy pair.	Getting the URLs of the resources (when object IDs are not specified) Getting the URLs of the resources (when object IDs that are obtained from the operation results are specified) Setting user authentication information (for authentication by using session-based authentication) Generating a request body in JSON format Operations that require sessions to be generated on multiple devices (remote copy operation) Creating objects by performing a POST operation
8	Unlock resources.	Getting the URLs of the resources (when object IDs are not specified) Setting user authentication information (for authentication by using session-based authentication)

Step	Sample coding operation flow	Code constructs
		Running actions for services by performing a POST operation
9	Confirm that the pair has been created.	-
10	Get information about a TrueCopy pair.	Getting an object by performing a GET operation Setting user authentication information (for authentication by using session-based authentication) Getting the URLs of the resources to which the operation results have been applied Getting error codes
11	Output error messages.	Outputting error messages
12	Discard the session.	Getting the URLs of the resources (when object IDs that are obtained from the operation results are specified) Setting user authentication information (for authentication by using session-based authentication) Deleting objects by performing a DELETE operation

Expected system configuration

This sample coding assumes the system configuration is as shown in the following figure.

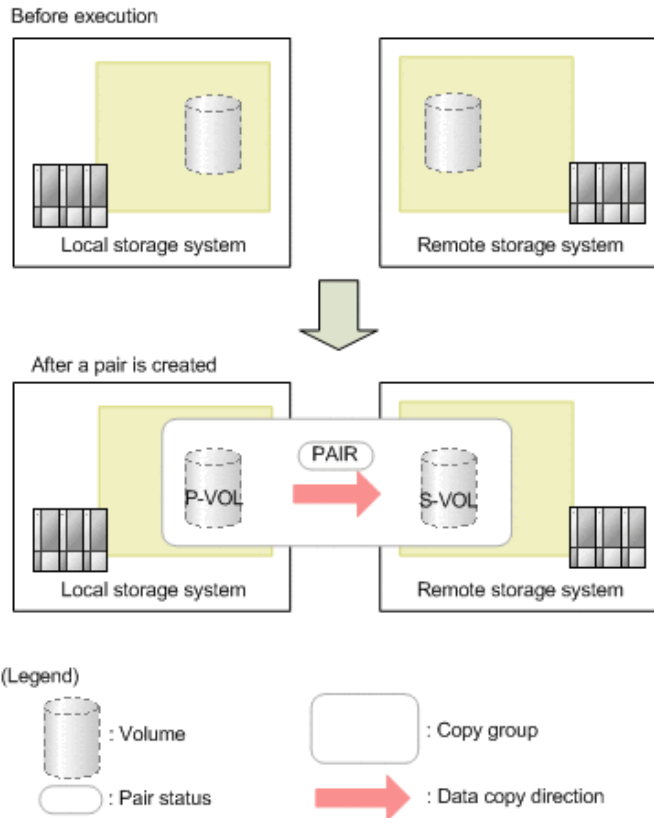

The following table shows the values specified for the parameters in the sample coding. If necessary, change the settings to match the system environment and requirements.

Parameter	Value	Description
LOCAL_USER_CREDENTIAL	("local_copy_user", "local_copy_pass")	This is the authentication information to be used for authentication in the local storage system. The coding sample shows a setting example when the user ID is <code>local_copy_user</code> , and the password is <code>local_copy_pass</code> . The user needs the Storage Administrator (Provisioning) role and the Storage Administrator (Remote Copy) role.
REMOTE_USER_CREDENTIAL	("remote_copy_user", "remote_copy_pass")	This is the authentication information to be used for authentication in the remote storage system. The coding sample shows a setting example when the user ID is <code>remote_copy_user</code> , and the password is <code>remote_copy_pass</code> . The user needs the Storage Administrator (Provisioning) role and the Storage Administrator (Remote Copy) role.

Parameter	Value	Description
COPY_GROUP_NAME	"TC_GROUP"	The copy group name for a TrueCopy pair to be created
COPY_PAIR_NAME	"p_347-348"	The copy pair name for a TrueCopy pair to be created
PVOL_LDEV_ID	347	The number of the already created LDEV to be used for the primary volume
SVOL_LDEV_ID	348	The number of the already created LDEV to be used for the secondary volume
FIRST_WAIT_TIME	1	The first interval for collecting the execution result of asynchronous processing. Normally, you do not need to change this value.
MAX_RETRY_COUNT	10	The maximum number of retries for collecting the execution result of asynchronous processing. Normally, you do not need to change this value.

The following table shows the parameters and values defined in the `remote_copy_param.py` file, which can be used in coding samples as common variables for the information about the local and the remote storage systems. If necessary, change the settings to match the system environment and requirements.

Parameter	Value	Description
LOCAL_REST_SERVER_IP_ADDR	192.0.2.100	The IP address of the REST API server of the local storage system
LOCAL_PORT	443	The SSL communication port for the REST API server of the local storage system
LOCAL_STORAGE_MODEL	VSP G900	The model name of the local storage system
LOCAL_SERIAL_NUMBER	410000	The serial number of the local storage system
REMOTE_REST_SERVER_IP_ADDR	192.0.2.200	The IP address of the REST API server of the remote storage system
REMOTE_PORT	443	The SSL communication port for the REST API server of the remote storage system
REMOTE_STORAGE_MODEL	VSP G900	The model name of the remote storage system

Parameter	Value	Description
REMOTE_SERIAL_NUMBER	420000	The serial number of the remote storage system

Contents of the sample coding

This subsection explains the sample coding.

1. Import necessary libraries and set parameters.

Before starting operations for the TrueCopy pair, the sample coding imports the required libraries or classes. In addition to the common libraries, the sample coding also imports the BlockStorageAPI class that defines the function that generates URLs.

```
# coding:utf-8

"""
synchronous_remote_copy

This program requires API version 1.9.0 or newer.
"""

import traceback
import requests
import json
import sys
import http.client
import time
import remote_copy_param

from block_storage_api import BlockStorageAPI
```

Set parameters to be used in the sample coding.

```
# #####Initialize parameters##### #
# Change the following parameters to fit your environment

# A copy group name
COPY_GROUP_NAME = "TC_GROUP"

# A copy pair name
COPY_PAIR_NAME = "p_347-348"

# A primary volume ID
# Specify already created and allocated volume ID by decimal
PVOL_LDEV_ID = 347

# A secondary volume ID which has the exactly same size
# as the primary volume
# Specify already created and allocated volume ID by decimal
SVOL_LDEV_ID = 348

# This parameter defines the first interval to access
# an asynchronous job. (Unit: Second)
FIRST_WAIT_TIME = 1

# This parameter defines the maximum retry time
# to confirm job status.
MAX_RETRY_COUNT = 10

# An user id and password of the local storage
LOCAL_USER_CREDENTIAL = ("local_copy_user",
                          "local_copy_pass")

# An user id and password of the remote storage
REMOTE_USER_CREDENTIAL = ("remote_copy_user",
                           "remote_copy_pass")

#####
```

2. Define headers.

Define the HTTP request header. Because the REST API only supports JSON format data, the sample coding defines header information so that data is handled in JSON format.

```
# ###You don't have to change the following parameters### #
local_storage_api = BlockStorageAPI(
    remote_copy_param.LOCAL_REST_SERVER_IP_ADDR,
    remote_copy_param.LOCAL_PORT,
    remote_copy_param.LOCAL_STORAGE_MODEL,
    remote_copy_param.LOCAL_SERIAL_NUMBER)

remote_storage_api = BlockStorageAPI(
    remote_copy_param.REMOTE_REST_SERVER_IP_ADDR,
    remote_copy_param.REMOTE_PORT,
    remote_copy_param.REMOTE_STORAGE_MODEL,
    remote_copy_param.REMOTE_SERIAL_NUMBER)

local_headers = {"content-type": "application/json",
                 "accept": "application/json",
                 "Response-Job-Status": "Completed"}

remote_headers = {"content-type": "application/json",
                  "accept": "application/json",
                  "Response-Job-Status": "Completed"}

REQUIRED_MAJOR_VERSION = 1
REQUIRED_MINOR_VERSION = 9

local_session_id = 0
remote_session_id = 0

#####
```

3. Define the function for getting status changes for asynchronous processing. (wait_until_jobstatus_is_changed function)

Define the function for getting status changes for asynchronous processing. Call and use this function from the main TrueCopy pair operation. For details on this function, see the description of functions used in the sample coding.



Tip: To prevent errors that occur when the server certificate used for SSL communication between the REST API client and the storage system is a self-signed certificate, the sample coding specifies `verify=False` in the request message to skip verification of the server certificate.

```

"""
Check whether the asynchronous command was finished.

@param storage_api storage_api
@param job_id the job ID to identify
           the asynchronous command
@param headers the array of the http headers
@return r the response data
"""

def check_update(storage_api, job_id, headers):
    url = storage_api.job(str(job_id))
    r = requests.get(url, headers=headers, verify=False)
    return r

```

```

"""
Wait until the job status is changed

@param storage_api storage_api
@param headers the array of the http headers
@param job_id the job ID to identify
           the asynchronous command
@param changed_status job status after waiting
@param is_retry_count_enabled if true, wait
           until MAX_RETRY_COUNT. if false, wait forever
           until job status is changed.
@return job_result.json()["affectedResources"][0]
           URL of an affected resource
"""

def wait_until_jobstatus_is_changed(
    storage_api,
    headers,
    job_id,
    changed_status,
    is_retry_count_enabled):
    status = "Initializing"
    retry_count = 1
    wait_time = FIRST_WAIT_TIME
    while status != changed_status:
        if status == "Completed":
            print("Status was already changed" +

```

```

        "to Completed.")
    break
    if is_retry_count_enabled and \
        retry_count > MAX_RETRY_COUNT:
        raise Exception("Timeout Error! "
            "Operation was not completed.")
    time.sleep(wait_time)
    job_result = check_update(storage_api,
        job_id, headers)
    status = job_result.json()["status"]
    double_time = wait_time * 2
    if double_time < 120:
        wait_time = double_time
    else:
        wait_time = 120
    retry_count += 1
    if job_result.json()["state"] == "Failed":
        error_obj = job_result.json()["error"]
        if "errorCode" in error_obj:
            if "SSB1" in error_obj["errorCode"]:
                print("Error! SSB code : ",
                    error_obj["errorCode"]["SSB1"],
                    ", ", error_obj["errorCode"]["SSB2"])
            elif "errorCode" in error_obj["errorCode"]:
                print("Error! error code : ",
                    error_obj["errorCode"]["errorCode"])
            raise Exception("Job Error!", job_result.text)
    print("Async job was succeeded. affected resource : " +
        job_result.json()["affectedResources"][0])
    return job_result.json()["affectedResources"][0]

```

4. Check the version of the REST API.

Get information about the version of the REST API for both the local and the remote storage systems by using the REST API server of each system to make sure that the version is supported.

```

"""
Check whether this API version allows the REST
Server to execute this program

@param api_version api version of this REST Server
@param required_major_version the lowest number of
    the major version that this program requires
@param required_minor_version the lowest number of
    the minor version that this program requires

"""

def check_api_version(api_version, required_major_version,
                    required_minor_version):
    version = api_version.split(".")
    major_version = int(version[0])
    minor_version = int(version[1])
    if not ((major_version == required_major_version and
             minor_version >= required_minor_version) or
            major_version >= required_major_version + 1):
        sys.exit(
            "This program requires API Version " +
            str(required_major_version) +
            "." +
            str(required_minor_version) +
            "." +
            "x or newer.\n")

try:
    # step1 Check the API version of the local REST API #
    print("Check the API version of the local REST API")
    url = local_storage_api.api_version()
    r = requests.get(url, headers=local_headers,
                    verify=False)
    if r.status_code != http.client.OK:
        raise requests.HTTPError(r)
    check_api_version(r.json()["apiVersion"],
                    REQUIRED_MAJOR_VERSION,
                    REQUIRED_MINOR_VERSION)

    # step1 Check the API version of the remote REST API #
    print("Check the API version of the remote REST API")
    url = remote_storage_api.api_version()
    r = requests.get(url, headers=remote_headers,
                    verify=False)
    if r.status_code != http.client.OK:

```

```

        raise requests.HTTPError(r)
    check_api_version(r.json()["apiVersion"],
                     REQUIRED_MAJOR_VERSION,
                     REQUIRED_MINOR_VERSION)

```

5. Generate a session.

Generate a session in both the local and the remote storage systems by using the REST API server of each system.

```

# step2 Generate a local session #
print("Generate a local session")
url = local_storage_api.generate_session()
r = requests.post(
    url,
    headers=local_headers,
    auth=LOCAL_USER_CREDENTIAL,
    verify=False)
if r.status_code != http.client.OK:
    raise requests.HTTPError(r)
local_token = r.json()["token"]
local_auth = "Session " + local_token
local_session_id = r.json()["sessionId"]

# step2 Generate a remote session #
print("Generate a remote session")
url = remote_storage_api.generate_session()
r = requests.post(
    url,
    headers=remote_headers,
    auth=REMOTE_USER_CREDENTIAL,
    verify=False)
if r.status_code != http.client.OK:
    raise requests.HTTPError(r)
remote_token = r.json()["token"]
remote_auth = "Session " + remote_token
remote_session_id = r.json()["sessionId"]

```

When a session is generated, a session ID and a token are returned. When running the API, specify the token for the Authentication header as the required authentication information for the subsequent operations. Use the session ID to discard the session after a set of operations is completed.

6. Lock resources.

Obtain a lock to prevent other users from performing operations on the target volume. For the local storage system, lock the resource group to which the LDEV for the primary volume belongs. For the remote storage system, lock the resource group to which the LDEV for the secondary volume belongs.

```
try:
    # step3 Lock the local resource group #
    print("Lock the local resource group")
    url = local_storage_api.lock()
    local_headers["Authorization"] = local_auth
    r = requests.post(url, headers=local_headers,
                      verify=False)
    if r.status_code != http.client.ACCEPTED:
        raise requests.HTTPError(r)
    print("Request was accepted. JOB URL : " +
          r.json()["self"])
    wait_until_jobstatus_is_changed(
        local_storage_api,
        local_headers,
        r.json()["jobId"],
        "Completed",
        True)

    # step3 Lock the remote resource group #
    print("Lock the remote resource group")
    remote_headers["Authorization"] = remote_auth
    url = remote_storage_api.lock()
    r = requests.post(url, headers=remote_headers,
                      verify=False)
    if r.status_code != http.client.ACCEPTED:
        raise requests.HTTPError(r)
    print("Request was accepted. JOB URL : " +
          r.json()["self"])
    wait_until_jobstatus_is_changed(
        remote_storage_api,
        remote_headers,
        r.json()["jobId"],
        "Completed",
        True)
```

The `wait_until_jobstatus_is_changed` function checks the execution status of the jobs that were run asynchronously, and waits until the job status changes to the specified status. In the sample coding, the job execution status is confirmed to have changed to "Completed" and to have been locked.

7. Create a TrueCopy pair.

Use the already created LDEV to create a TrueCopy pair. Also create a new copy group. Specify the copy group name, copy pair name, and the LDEV number of the volume to be used, which are defined in advance in the parameters. In addition, specify items such as the copy pair type, whether to create a copy group, and the fence level, and then issue a request for creating a TrueCopy pair. The `block_storage_api` function is used to generate the URL.

```
# step4 Create a remote copy pair #
print("Create a remote copy pair")
url = local_storage_api.remote_copy_pairs()
body = {
    "copyGroupName": COPY_GROUP_NAME,
    "copyPairName": COPY_PAIR_NAME,
    "replicationType": "TC",
    "remoteStorageDeviceId": remote_storage_api.
get_storage_id(),
    "pvolldevId": PVOL_LDEV_ID,
    "svolldevId": SVOL_LDEV_ID,
    "isNewGroupCreation": "true",
    "fenceLevel": "data",
}
local_headers["Remote-Authorization"] = remote_auth
r = requests.post(
    url,
    headers=local_headers,
    data=json.dumps(body),
    verify=False)
if r.status_code != http.client.ACCEPTED:
    raise requests.HTTPError(r)
print("Create remote copy pair request " +
    "was accepted. JOB URL : " + r.json()["self"])
wait_until_jobstatus_is_changed(
    local_storage_api,
    local_headers,
    r.json()["jobId"],
    "StorageAccepted",
    False)
jobid = r.json()["jobId"]

print("Status changed to StorageAccepted")
```

The `wait_until_jobstatus_is_changed` function checks the execution status of the jobs that were run asynchronously, and waits until the job status changes to the specified status. In the sample coding, it is confirmed that the job execution status has changed to "StorageAccepted" and the request for creating a TrueCopy pair has been received by the storage system.

8. Unlock resources.

After having confirmed that the storage system received processing for creating the pair, cancel the obtained lock. The "finally" statement in the sample coding makes sure that the lock will be canceled even if an error occurs while the API is running.

```
finally:
    # step5 Unlock the local resource group #
    print("Unlock the local resource group")
    url = local_storage_api.unlock()
    r = requests.post(url, headers=local_headers,
                      verify=False)
    if r.status_code != http.client.ACCEPTED:
        raise requests.HTTPError(r)
    print("Request was accepted. JOB URL : " +
          r.json()["self"])
    wait_until_jobstatus_is_changed(
        local_storage_api, local_headers,
        r.json()["jobId"], "Completed", True)

    # step5 Unlock the remote resource group #
    print("Unlock the remote resource group")
    url = remote_storage_api.unlock()
    r = requests.post(url, headers=remote_headers,
                      verify=False)
    if r.status_code != http.client.ACCEPTED:
        raise requests.HTTPError(r)
    print("Request was accepted. JOB URL : " +
          r.json()["self"])
    wait_until_jobstatus_is_changed(
        remote_storage_api,
        remote_headers,
        r.json()["jobId"],
        "Completed",
        True)
```

9. Confirm that the pair has been created.

Confirm that processing for creating the pair is completed in the storage system. Use the `wait_until_jobstatus_is_changed` function to confirm that the job execution status has changed to "Completed".

```
# step6 Wait until the operation is complete #
affected_resource_path = wait_until_jobstatus_is_changed(
    local_storage_api, local_headers,
    jobid, "Completed", False)
```

10. Get information about a TrueCopy pair.

To confirm that the pair has been correctly created, get information about the pair by using the URL of the pair that was obtained when the TrueCopy pair was created. In the sample coding, the following items are output: the copy group name, copy pair name, pair type, LDEV numbers for the P-VOL and S-VOL, pair volume status, and the storage device ID.

```
# step7 Print the remote copy pair #
print("Print the remote copy pair")
url = local_storage_api.affected_resource(
    affected_resource_path)
r = requests.get(url, headers=local_headers,
                verify=False)
if r.status_code != http.client.OK:
    raise requests.HTTPError(r)
print("COPY GROUP NAME : " +
      str(r.json()["copyGroupName"]))
print("COPY PAIR NAME : " +
      str(r.json()["copyPairName"]))
print("REPLICATION TYPE : " +
      str(r.json()["replicationType"]))
print("PVOL LDEV ID : " + str(r.json()["pvolLdevId"]))
print("SVOL LDEV ID : " + str(r.json()["svolLdevId"]))
print("PVOL STATUS : " + str(r.json()["pvolStatus"]))
print("SVOL STATUS : " + str(r.json()["svolStatus"]))
print("PVOL STORAGE DEVICE ID : "
      + str(r.json()["pvolStorageDeviceId"]))
print("SVOL STORAGE DEVICE ID : "
      + str(r.json()["svolStorageDeviceId"]))
print("REMOTE MIRROR COPY PAIR ID : "
      + str(r.json()["remoteMirrorCopyPairId"]))
print()
```

11. Output error messages.

In the sample coding, processing for communication errors, HTTP request errors, and job execution errors is described. If a communication error occurs, an error message is output. If an HTTP request error occurs, the error code, the error message, and the response body are output. If a job execution error occurs, all of the contents included in the job execution result are output.

```
except requests.ConnectionError:
    sys.stderr.write("Connection Error!\n")
    sys.stderr.write(traceback.format_exc())
except requests.HTTPError as he:
    sys.stderr.write("HTTP Error! status code : ")
    sys.stderr.write(str(he.args[0].status_code) + "\n")
    sys.stderr.write(he.args[0].text + "\n")
except Exception as e:
    sys.stderr.write(traceback.format_exc())
    for msg in e.args:
        sys.stderr.write(str(msg) + "\n")
```

12. Discard the session.

After a set of operations is completed, discard the session by using the REST API server of both the local and the remote storage systems. Specify the session ID that was obtained when the session was created. The "finally" statement in the sample coding makes sure that the session will be discarded even if an error occurs while the API is running. After the session is discarded, the processing ends.

```
finally:
    # step8 Discard the local session #
    print("Discard the local session")
    url = local_storage_api. \
        discard_session(local_session_id)
    r = requests.delete(url, headers=local_headers,
                       verify=False)
    if r.status_code != http.client.OK:
        raise requests.HTTPError(r)

    # step8 Discard the remote session #
    print("Discard the remote session")
    url = remote_storage_api.discard_session(
        remote_session_id)
    r = requests.delete(url,
                       headers=remote_headers, verify=False)
    if r.status_code != http.client.OK:
        raise requests.HTTPError(r)

    print("Operation was completed.")
    sys.exit()
```

Sample coding for uploading files (specifying the transfer destinations of audit log files)

This section provides sample code for specifying the transfer destinations of the audit log files of storage systems. This sample coding includes the procedure for uploading the client certificates to a storage system.

Operation flow of the sample code for specifying the transfer destinations of the audit log files of storage systems

The following is the operation flow of the sample code for specifying the transfer destinations of the audit log files of storage systems and the corresponding code constructs.

Step	Sample coding operation flow	Code constructs
1	Import necessary libraries and set parameters.	-
2	Define headers.	Specifying request headers (for the default HTTP headers)
3	Define functions for issuing an HTTP request and for verifying the status of asynchronous processing.	Getting information about the job status by performing a GET operation Setting user authentication information (for authentication by using session-based authentication) Generating a request body in JSON format Getting the job execution results Getting the URLs of the resources to which the operation results have been applied Getting error codes
4	Check the version of the REST API.	Getting information about the version of the REST API by performing a GET operation
5	Generate a session.	Getting the URLs of the resources (when object IDs are not specified) Setting user authentication information (for authentication by using a user ID and a password) Creating objects by performing a POST operation
6	Upload the root certificate of the syslog server to which audit log files are to be transferred.	Getting the URLs of the resources (when object IDs are not specified) Creating form data Running actions for objects by using the POST operation
7	Upload the client certificate of the syslog server to which audit log files are to be transferred.	Getting the URLs of the resources (when object IDs are not specified) Creating form data

Step	Sample coding operation flow	Code constructs
		Running actions for objects by using the POST operation
8	Specify the syslog server to which audit log files are to be transferred.	Getting the URLs of the resources (when fixed object IDs such as those for single instances are specified) Getting the URLs of the resources (for objects of a single instance) Generating a request body in JSON format Changing the attribute of an object by using the PATCH operation
9	Send a test message to the syslog server to which audit log files are to be transferred.	Getting the URLs of the resources (when fixed object IDs such as those for single instances are specified) Running actions for objects by using the POST operation
10	Obtain the configuration information of the transfer destinations of audit log files	Getting the URLs of the resources (when fixed object IDs such as those for single instances are specified) Obtaining an object by using the GET operation (when obtaining a specific object) Outputting obtained information
11	Output error messages.	Outputting error messages
12	Discard the session.	Getting the URLs of the resources (when object IDs that are obtained from the operation results are specified) Deleting objects by performing a DELETE operation

Expected system configuration

The sample code assumes the system configuration in the following figure. Note that the transfer destination is a single syslog server.

Sample coding for uploading files (specifying the transfer destinations of audit log files)

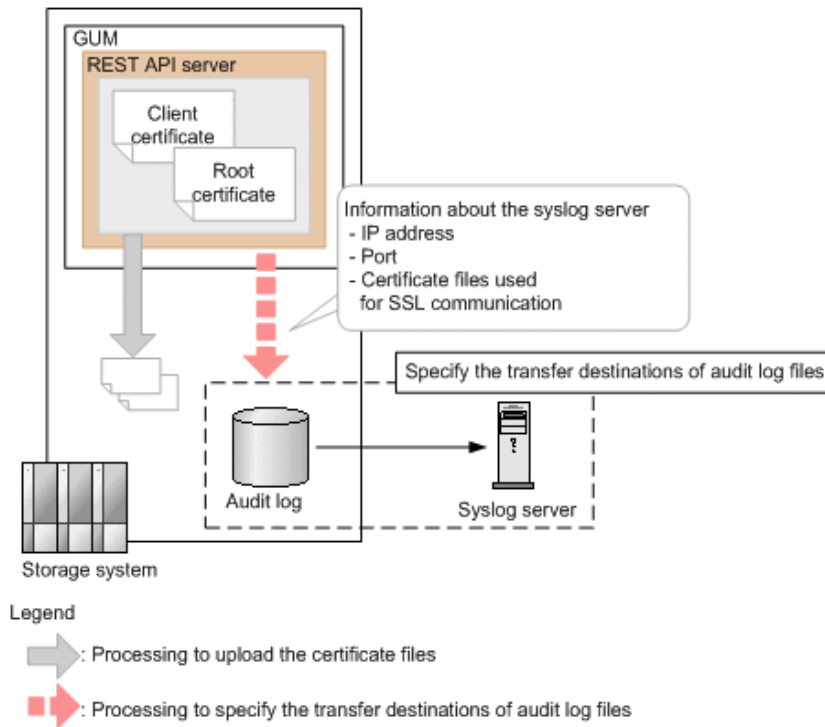

The following table shows the values specified for the parameters in the sample coding. If necessary, change the settings to match the system environment and requirements.

Parameter	Value	Description
USER_CREDENTIAL	("user1", "pass1")	Authentication information used for authentication by the storage system. In the sample code, the user ID is <code>user1</code> and the password is <code>pass1</code> . The user must have the Audit Log Administrator (View & Modify) role.
ROOT_CERT_FILE_PATH	"D:\\cert\\"	The path where the root certificate file of the syslog server (the file to be uploaded to the storage system) is stored. The sample code specifies for SSL communication to be used between the storage system and the syslog server. Prepare the root certificate of the syslog server in advance.
ROOT_CERT_FILE_NAME	"root.crt"	The name of the root certificate file of the syslog server (the file to be uploaded to the storage system).
CLIENT_CERT_FILE_PATH	"D:\\cert\\"	The path where the client certificate file of the syslog server (the file to be uploaded to the storage system) is stored.

Parameter	Value	Description
		The sample code specifies for SSL communication to be used between the storage system and the syslog server. Prepare the client certificate of the syslog server in advance.
CLIENT_CERT_FILE_NAME	"client.pfx"	The name of the client certificate file of the syslog server (the file to be uploaded to the storage system).
TRANSFER_PROTOCOL	"TLS"	The protocol to be used when transferring the audit logs to the syslog server.
LOCATION_NAME	"STORAGE_SYSTEM_1"	The name that identifies the storage system from which the audit logs are to be transferred.
RETRY_INTERVAL	5	The interval (in seconds) between retries when communication with the syslog server fails.
PRIMARY_SYSLOG_SERVER_IP_ADDR	"192.0.1.101"	The IP address of the syslog server.
PRIMARY_SYSLOG_SERVER_PORT	"12345"	The port number used by the syslog server.
CLIENT_CERT_FILE_PASSWORD	"certFilePass"	The password for the client certificate file.
FIRST_WAIT_TIME	1	The first interval (in seconds) for collecting the execution result of asynchronous processing. Normally, you do not need to change this value.
MAX_RETRY_COUNT	6	The maximum number of retries for collecting the execution result of asynchronous processing. Normally, you do not need to change this value.

Contents of the sample coding

This subsection explains the sample coding.

1. Import necessary libraries and set parameters.

Before starting the volume allocation processing, the sample coding imports the required libraries or classes. In addition to the common libraries, the sample coding also imports the BlockStorageAPI class that defines the function that generates URLs.

```
# coding:utf-8

"""
auditlog_syslog_server setting

This program requires API version 1.9.0 or newer.
"""

import requests
import json
import sys
import http.client
import time
import traceback
import rest_server_param
import storage_param

from block_storage_api import BlockStorageAPI
```

Set parameters to be used in the sample coding.

```
# #####Initialize parameters##### #
# Change the following parameters to fit your environment

# A path of root certificate
ROOT_CERT_FILE_PATH = "D:\\cert\\"

# A root certificate name
ROOT_CERT_FILE_NAME = "root.crt"

# A path of client certificate
CLIENT_CERT_FILE_PATH = "D:\\cert\\"

# A client certificate name
CLIENT_CERT_FILE_NAME = "client.pfx"

# A transfer protocol
TRANSFER_PROTOCOL = "TLS"

# A location name
LOCATION_NAME = "STORAGE_SYSTEM_1"

# A retry interval
RETRY_INTERVAL = 5

# A primary syslog server IP address
PRIMARY_SYSLOG_SERVER_IP_ADDR = "192.0.1.101"

# A primary syslog server port number
PRIMARY_SYSLOG_SERVER_PORT = "12345"

# A password of the client certificate
CLIENT_CERT_FILE_PASSWORD = "certFilePass"

# This parameter defines the first interval to access
# an asynchronous job. (Unit: Second)
FIRST_WAIT_TIME = 1

# This parameter defines the maximum retry time
# to confirm job status.
MAX_RETRY_COUNT = 6

# An user id and password of the target storage
USER_CREDENTIAL = ("user1", "pass1")

#####
```

2. Define headers.

Define the HTTP request header. In addition to the JSON format, which is the standard format for the REST API, define the header information so that the form data format, which used in by the API function for uploading the file, can also be handled.

```
# ###You don't have to change the following parameters### #
block_storage_api = BlockStorageAPI(
    rest_server_param.REST_SERVER_IP_ADDR,
    rest_server_param.REST_SERVER_PORT,
    storage_param.STORAGE_MODEL,
    storage_param.SERIAL_NUMBER)

headers = {"content-type": "application/json",
          "accept": "application/json"}
file_upload_headers = {"accept": "application/json",
                      "Expect": ""}

REQUIRED_MAJOR_VERSION = 1
REQUIRED_MINOR_VERSION = 9

session_id = 0

#####
```

3. Define the function for issuing an HTTP request and for verifying the status of asynchronous processing (the `invoke_async_command` function).

Define the function that issues an HTTP request and verifies the status of asynchronous processing. Call and use this function from the main volume allocation operation. For details on this function, see the section explaining the functions used in the sample coding.



Tip: To prevent errors that occur when the server certificate used for SSL communication between the REST API client and the storage system is a self-signed certificate, the sample coding specifies `verify=False` in the request message to skip verification of the server certificate.

```
"""
Check whether the asynchronous command was finished.
@param job_id the job ID to identify
        the asynchronous command
@return r the response data
"""

def check_update(job_id):
    url = block_storage_api.job(str(job_id))
    r = requests.get(url, headers=headers, verify=False)
    return r
```

```
"""
Execute the HTTP request (POST or PATCH)
@param method_type HTTP request method (POST or PATCH)
@param url URL to execute HTTP method
@param body The information of a resource
@return job_result.json()["affectedResources"][0]
        URL of an affected resource
"""

def invoke_async_command(method_type, url, body):
    if method_type == "patch":
        r = requests.patch(url, headers=headers,
                           data=json.dumps(body), verify=False)
    elif method_type == "post":
        if body is None:
            r = requests.post(
                url,
                headers=headers,
                verify=False)
        else:
            r = requests.post(
                url,
                headers=headers,
                data=json.dumps(body),
                verify=False)
    if r.status_code != http.client.ACCEPTED:
        raise requests.HTTPError(r)
    print("Request was accepted. JOB URL : " +
          r.json()["self"])
```

```
if "affectedResources" in job_result.json():
    print("Async job was succeeded." +
          " affected resource : " +
          job_result.json()["affectedResources"][0])
    return job_result.json()["affectedResources"][0]
else:
    print("Async job was succeeded.")
    return None
```

4. Check the version of the REST API.

Get information about the version of the REST API to make sure that the version is supported.

```
"""
Check whether this API version allows the REST
Server to execute this program

@param api_version api version of this REST Server
@param required_major_version the lowest number of
    the major version that this program requires
@param required_minor_version the lowest number of
    the minor version that this program requires

"""

def check_api_version(api_version, required_major_version,
                    required_minor_version):
    version = api_version.split(".")
    major_version = int(version[0])
    minor_version = int(version[1])
    if not ((major_version == required_major_version and
            minor_version >= required_minor_version) or
            major_version >= required_major_version + 1):
        sys.exit("This program requires API Version " +
                str(required_major_version) + "." +
                str(required_minor_version) +
                "." + "x or newer.\n")

try:
    # step1 Check the API version #
    print("Check the API version")
    url = block_storage_api.api_version()
    r = requests.get(url, headers=headers, verify=False)
    if r.status_code != http.client.OK:
        raise requests.HTTPError(r)
    check_api_version(
        r.json()["apiVersion"],
        REQUIRED_MAJOR_VERSION,
        REQUIRED_MINOR_VERSION)
```

5. Generate a session.

Generate sessions by using the REST API server.

```
# step2 Generate a session #
print("Generate a session")
url = block_storage_api.generate_session()
r = requests.post(url, headers=headers, auth=USER_CREDENTIAL,
                  verify=False)
if r.status_code != http.client.OK:
    raise requests.HTTPError(r)
token = r.json()["token"]
auth = "Session " + token
session_id = r.json()["sessionId"]
headers["Authorization"] = auth
file_upload_headers["Authorization"] = auth
```

When a session is generated, a session ID and a token are returned. When running the API, specify the token for the Authentication header as the required authentication information for the subsequent operations. Use the session ID to discard the session after a set of operations is completed.

6. Upload the root certificate of the syslog server to which the audit log files are to be transferred.

As preparation for transferring the audit log files to the syslog server by using SSL communication, upload the root certificate of the syslog server to the storage system.

```
# step3 Upload a root certificate #
print("Upload a root certificate")
url = block_storage_api.file_upload()
files = {"file": (ROOT_CERT_FILE_NAME,
                 open(ROOT_CERT_FILE_PATH + ROOT_CERT_FILE_NAME, "rb"),
                 "application/octet-stream")}
r = requests.post(url, headers=file_upload_headers,
                  data={"fileType": "AuditSyslogPrimaryRootCertFile"},
                  files=files, verify=False)
if r.status_code != http.client.OK:
    raise requests.HTTPError(r)
```

7. Upload the client certificate of the syslog server to which audit log files are to be transferred.

As preparation for transferring the audit log files to the syslog server by using SSL communication, upload the client certificate of the syslog server to the storage system.

```
# step4 Upload a client certificate #
print("Upload a client certificate")
files = {"file": (CLIENT_CERT_FILE_NAME,
                 open(CLIENT_CERT_FILE_PATH + CLIENT_CERT_FILE_NAME,
                     "rb"), "application/octet-stream")}
r = requests.post(url, headers=file_upload_headers,
                 data={"fileType":
                      "AuditSyslogPrimaryClientCertFile"},
                 files=files, verify=False)
if r.status_code != http.client.OK:
    raise requests.HTTPError(r)
```

8. Specify the syslog server to which audit log files are to be transferred.

Specify the settings for transferring audit log files to the syslog server. Because the sample code specifies for SSL communication to be used for communication with the syslog server, in addition to information about the syslog server to which audit log files are to be transferred, the sample code also specifies information about the certificate for SSL communication.

```
# step5 Modify the syslog server #
print("Modify the syslog server")
url = block_storage_api.auditlog_syslog()
body = {
    "transferProtocol": TRANSFER_PROTOCOL,
    "locationName": LOCATION_NAME,
    "retries": True,
    "retryInterval": RETRY_INTERVAL,
    "primarySyslogServer": {
        "isEnabled": True,
        "ipAddress": PRIMARY_SYSLOG_SERVER_IP_ADDR,
        "port": PRIMARY_SYSLOG_SERVER_PORT,
        "clientCertFileName": CLIENT_CERT_FILE_NAME,
        "clientCertFilePassword": CLIENT_CERT_FILE_PASSWORD,
        "rootCertFileName": ROOT_CERT_FILE_NAME
    },
    "secondarySyslogServer": {
        "isEnabled": False
    }
}
invoke_async_command("patch", url, body)
```

The `invoke_async_command` function issues a request to specify the transfer destination of audit log files and checks the execution status of jobs that are executed asynchronously. The function then returns, as the execution result, the URL of information about the transfer destination of audit log files that is specified for the storage system.

9. Send a test message to the syslog server to which audit log files are to be transferred.

Send a test message to check whether the syslog server that is set as the transfer destination of audit log files can correctly receive audit log data.

```
# step6 Send a test message to the syslog server #
print("Send a test message to the syslog server")
url = block_storage_api.auditlog_syslog_send_test()
invoke_async_command("post", url, None)
```

10. Obtain the configuration information of the transfer destinations of audit log files.

To make sure that the operations in the previous steps (operations to set information on the storage system) have been successful, obtain and output the configuration information of the transfer destinations of audit logs. The sample code obtains and outputs the following information: the protocol to be used, the identifier of the storage system from which audit log files are to be transferred, retry settings and the interval for retries when communication fails, and the IP address and port number of the syslog server.

```
# step7 Get the syslog server #
print("get the syslog server")
url = block_storage_api.auditlog_syslog()
r = requests.get(url, headers=headers, verify=False)
if r.status_code != http.client.OK:
    raise requests.HTTPError(r)
print("TRANSFER PROTOCOL : " +
      str(r.json()["transferProtocol"]))
print("LOCATION NAME : " +
      str(r.json()["locationName"]))
print("RETRIES : " +
      str(r.json()["retries"]))
print("RETRY INTERVAL : " +
      str(r.json()["retryInterval"]))
print("PRIMARY SYSLOG SERVER")
print("IP ADDRESS : " +
      str(r.json()["primarySyslogServer"]["ipAddress"]))
print("PORT : " +
      str(r.json()["primarySyslogServer"]["port"]))
```

11. Output error messages.

In the sample coding, processing for communication errors, HTTP request errors, and job execution errors is described. If a communication error occurs, an error message is output. If an HTTP request error occurs, the error code, the error message, and the response body are output. If a job execution error occurs, all of the contents included in the job execution result are output.

```
except requests.ConnectionError:
    sys.stderr.write("Connection Error!\n")
    sys.stderr.write(traceback.format_exc())
except requests.HTTPError as he:
    sys.stderr.write("HTTP Error! status code : ")
    sys.stderr.write(str(he.args[0].status_code) + "\n")
    sys.stderr.write(he.args[0].text + "\n")
except Exception as e:
    sys.stderr.write(traceback.format_exc())
    for msg in e.args:
        sys.stderr.write(str(msg) + "\n")
```

12. Discard the session.

After a set of operations is completed, discard the session. Specify the session ID that was obtained when the session was generated. The "finally" statement in the sample coding makes sure that the session will be discarded even if an error occurs while the API is running. After the session is discarded, the processing ends.

```
finally:
    # step8 Discard the session #
    print("Discard the session")
    url = block_storage_api.discard_session(session_id)
    r = requests.delete(url, headers=headers, verify=False)
    try:
        if r.status_code != http.client.OK:
            raise requests.HTTPError(r)
    except requests.HTTPError as he:
        sys.stderr.write("HTTP Error! status code : ")
        sys.stderr.write(str(he.args[0].status_code) + "\n")
        sys.stderr.write(he.args[0].text + "\n")

    print("Operation was completed.")
    sys.exit()
```

Sample coding for downloading a file (backing up encryption keys)

This section provides the sample coding for backing up encryption keys. This sample coding includes the procedure for downloading an encryption key backup file to a client.

Sample coding operation flow for backing up encryption keys

The following table shows the sample coding operation flow for backing up encryption keys and the corresponding code constructs.

Step	Sample coding operation flow	Code constructs
1	Import necessary libraries and set parameters.	-
2	Define headers.	Specifying request headers (for the default HTTP headers)
3	Check the version of the REST API.	Getting information about the version of the REST API by performing a GET operation
4	Download the encryption key backup file.	Getting the URLs of the resources (when fixed object IDs such as those for single instances are specified) Running actions for objects by using the POST operation
5	Output error messages.	Outputting error messages

Values to be specified for the parameters in the sample coding

The following table shows the values specified for the parameters in the sample coding. If necessary, change the settings to match the system environment and requirements.

Parameter	Value	Description
USER_CREDENTIAL	("user1", "password")	This information is used for authentication by the storage system. In the sample coding, the user ID is <code>user1</code> , and the password is <code>password</code> . The user must have the Security Administrator (View & Modify) role.
BACKUP_PASSWORD	backuppassword	The password for the encryption key backup file
ENCRYPTION_KEY_BACKUP_FILE_PATH	D:\encryption\\	The path where the encryption key backup file is stored
ENCRYPTION_KEY_BACKUP_FILE_NAME	backupfile.ekf	The name of the encryption key backup file

Contents of the sample coding

This subsection explains the sample coding.

1. Import necessary libraries and set parameters.

Before starting the volume allocation processing, the sample coding imports the required libraries or classes. In addition to the common libraries, the sample coding also imports the BlockStorageAPI class that defines the function that generates URLs.

```
# coding:utf-8

"""
backup_encryption_keys

This program requires API version 1.12.0 or newer.
"""

import requests
import json
import sys
import http.client
import traceback
import rest_server_param
import storage_param

from block_storage_api import BlockStorageAPI
```

Set parameters to be used in the sample coding.

```
# #####Initialize parameters##### #
# Change the following parameters to fit your environment

# An user id and password of the target storage
USER_CREDENTIAL = ("user1", "pass1")

# A backup password
BACKUP_PASSWORD = "backuppasword"

# A path of encryption key backup file
ENCRYPTION_KEY_BACKUP_FILE_PATH = "D:\encryption\\"

# A encryption key backup file name
ENCRYPTION_KEY_BACKUP_FILE_NAME = "backupfile.ekf"

#####
```

2. Define headers.

Define the HTTP request header. In addition to the JSON format, which is the standard format for the REST API, define the header information so that the stream data format, which is used in the API function for file downloading, can also be handled.

```
# ###You don't have to change the following parameters### #
block_storage_api = BlockStorageAPI(
    rest_server_param.REST_SERVER_IP_ADDR,
    rest_server_param.REST_SERVER_PORT,
    storage_param.STORAGE_MODEL,
    storage_param.SERIAL_NUMBER)

headers = {"content-type": "application/json",
          "accept": "application/json"}

file_download_headers = {"content-type": "application/json",
                        "accept": "application/octet-stream"}

REQUIRED_MAJOR_VERSION = 1
REQUIRED_MINOR_VERSION = 12

#####
```

3. Check the version of the REST API.

Get information about the version of the REST API to make sure that the version is supported.

```
"""
Check whether this API version allows the REST
Server to execute this program

@param api_version api version of this REST Server
@param required_major_version the lowest number of
    the major version that this program requires
@param required_minor_version the lowest number of
    the minor version that this program requires

"""

def check_api_version(api_version, required_major_version,
                    required_minor_version):
    version = api_version.split(".")
    major_version = int(version[0])
    minor_version = int(version[1])
    if not ((major_version == required_major_version and
            minor_version >= required_minor_version) or
            major_version >= required_major_version + 1):
        sys.exit("This program requires API Version " +
                str(required_major_version) + "." +
```



```

        str(required_minor_version) +
        "." + "x or newer.\n")

try:
    # step1 Check the API version #
    print("Check the API version")
    url = block_storage_api.api_version()
    r = requests.get(url, headers=headers, verify=False)
    if r.status_code != http.client.OK:
        raise requests.HTTPError(r)
    check_api_version(
        r.json()["apiVersion"],
        REQUIRED_MAJOR_VERSION,
        REQUIRED_MINOR_VERSION)

```

4. Download the encryption key backup file.

Download the encryption key backup file to a specified path.

```

# step2 Get the encryption keys backup #
print("Get the encryption keys backup")
url = block_storage_api.encryption_key_file_backup()
body = {
    "parameters": {
        "password": BACKUP_PASSWORD
    }
}
r = requests.post(url, headers=file_download_headers,
                  auth=USER_CREDENTIAL, data=json.dumps(body),
                  verify=False)
if r.status_code != http.client.OK:
    raise requests.HTTPError(r)
with open(ENCRYPTION_KEY_BACKUP_FILE_PATH +
          ENCRYPTION_KEY_BACKUP_FILE_NAME, 'wb') as saveFile:
    saveFile.write(r.content)

```

5. Output error messages.

In the sample coding, processing for communication errors, HTTP request errors, and job execution errors is described. If a communication error occurs, an error message is output. If an HTTP request error occurs, the error code, the error message, and the response body are output. If a job execution error occurs, all of the contents included in the job execution result are output.

```

except requests.ConnectionError:
    sys.stderr.write("Connection Error!\n")
    sys.stderr.write(traceback.format_exc())
except requests.HTTPError as he:
    sys.stderr.write("HTTP Error! status code : ")
    sys.stderr.write(str(he.args[0].status_code) + "\n")
    sys.stderr.write(he.args[0].text + "\n")

```

```

except Exception as e:
    sys.stderr.write(traceback.format_exc())
    for msg in e.args:
        sys.stderr.write(str(msg) + "\n")
finally:
    print("Operation was completed.")
    sys.exit()

```

Sample coding for re-creating a parity group (data encryption)

This section provides the sample coding for re-creating a parity group (encrypting data).



Note:

This operation is performed as part of the procedure for encrypting existing data without changing the drive configuration. For details on the entire procedure, see the description of the flow of data encryption operations.

Before deleting a parity group, be sure to back up the data in the parity group to a volume in another parity group.

Sample coding operation flow for re-creating a parity group

The following table shows the sample coding operation flow for re-creating a parity group and the corresponding code constructs.

Step	Sample coding operation flow	Code constructs
1	Import necessary libraries and set parameters.	-
2	Define headers.	Specifying request headers (for the default HTTP headers)
3	Define functions for issuing an HTTP request and for verifying the status of asynchronous processing.	Getting information about the job status by performing a GET operation Setting user authentication information (for authentication by using session-based authentication) Generating a request body in JSON format Getting the job execution results Getting the URLs of the resources to which the operation results have been applied

Step	Sample coding operation flow	Code constructs
		Getting error codes
4	Check the version of the REST API.	Getting information about the version of the REST API by performing a GET operation
5	Generate a session.	Getting the URLs of the resources (when object IDs are not specified) Setting user authentication information (for authentication by using a user ID and a password) Creating objects by performing a POST operation
6	Get information about the parity group.	Getting objects by performing a GET operation Setting user authentication information (for authentication by using session-based authentication) Outputting the acquired information
7	Get information about drives.	Getting objects by performing a GET operation Setting user authentication information (for authentication by using session-based authentication) Outputting the acquired information
8	Delete the parity group.	Getting the URLs of the resources (when no object ID is specified) Setting user authentication information (for authentication by using session-based authentication) Generating a request body in JSON format Deleting objects by performing a DELETE operation
9	Create a parity group.	Getting the URLs of the resources (when no object ID is specified) Setting user authentication information (for authentication by using session-based authentication) Generating a request body in JSON format Creating objects by performing a POST operation
10	Get information about the parity group.	Getting objects by performing a GET operation

Step	Sample coding operation flow	Code constructs
		Setting user authentication information (for authentication by using session-based authentication) Outputting the acquired information
11	Output error messages.	Outputting error messages
12	Discard the session.	Getting the URLs of the resources (when object IDs that are obtained from the operation results are specified) Deleting objects by performing a DELETE operation

Expected system configuration

This sample coding assumes the system configuration is as shown in the following figure.

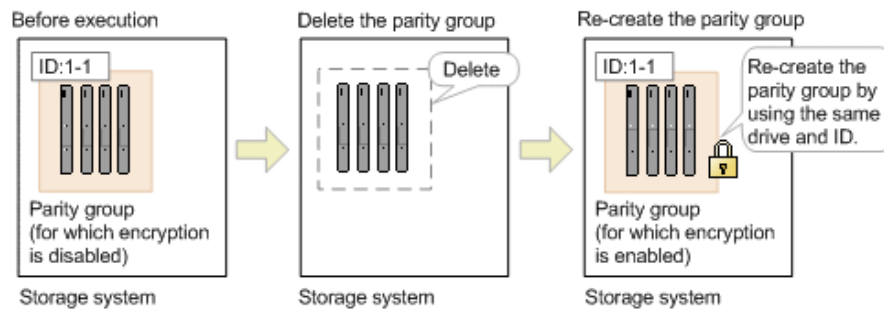

The following table shows the values specified for the parameters in the sample coding. If necessary, change the settings to match the system environment and requirements.

Parameter	Value	Description
USER_CREDENTIAL	("user1", "pass1")	This is the authentication information to be used for authentication in the storage system. The coding sample shows a setting example when the user ID is <code>user1</code> , and the password is <code>pass1</code> . The user needs the Storage Administrator (Provisioning) role.
PARITY_GROUP_ID	1-1	The ID of the parity group to be recreated
FIRST_WAIT_TIME	1	The first interval (seconds) for collecting the execution result of asynchronous processing. Normally, you do not need to change this value.

Parameter	Value	Description
MAX_RETRY_COUNT	6	The maximum number of retries for collecting the execution result of asynchronous processing. Normally, you do not need to change this value.

Contents of the sample coding

This subsection explains the sample coding.

1. Import necessary libraries and set parameters.

Before starting the volume allocation processing, the sample coding imports the required libraries or classes. In addition to the common libraries, the sample coding also imports the BlockStorageAPI class that defines the function that generates URLs.

```
# coding:utf-8

"""
recreate_parity_group

This program requires API version 1.12.0 or newer.
"""

import requests
import json
import sys
import http.client
import time
import traceback
import rest_server_param
import storage_param

from block_storage_api import BlockStorageAPI
```

Set parameters to be used in the sample coding.

```
# #####Initialize parameters##### #
# Change the following parameters to fit your environment

# This parameter defines the first interval to access
# an asynchronous job. (Unit: Second)
FIRST_WAIT_TIME = 1

# This parameter defines the maximum retry time
# to confirm job status.
MAX_RETRY_COUNT = 6
```

```
# An user id and password of the target storage
USER_CREDENTIAL = ("user1", "pass1")

# A parity group id
PARITY_GROUP_ID = "1-1"

#####
```

2. Define headers.

Define the HTTP request header. Because the REST API only supports JSON format data, the sample coding defines header information so that data is handled in JSON format.

```
# ###You don't have to change the following parameters### #
block_storage_api = BlockStorageAPI(
    rest_server_param.REST_SERVER_IP_ADDR,
    rest_server_param.REST_SERVER_PORT,
    storage_param.STORAGE_MODEL,
    storage_param.SERIAL_NUMBER)

headers = {"content-type": "application/json",
          "accept": "application/json",
          "Response-Job-Status": "Completed"}

REQUIRED_MAJOR_VERSION = 1
REQUIRED_MINOR_VERSION = 12

#####
```

3. Define the function for issuing an HTTP request and for verifying the status of asynchronous processing (the `invoke_async_command` function).

Define the function that issues an HTTP request and verifies the status of asynchronous processing. Call and use this function from the main volume allocation operation. For details on this function, see the section explaining the functions used in the sample coding.



Tip: To prevent errors that occur if the server certificate used for SSL communication between the REST API client and the storage system is a self-signed certificate, the sample coding skips the verification of the server certificate by specifying `verify=False` when a request is issued.

```
"""
Check whether the asynchronous command was finished.
@param job_id the job ID to identify
        the asynchronous command
@return r the response data
"""
```

```

def check_update(job_id):
    url = block_storage_api.job(str(job_id))
    r = requests.get(url, headers=headers, verify=False)
    return r

"""
Execute the HTTP request (POST, PUT or DELETE)
@param method_type HTTP request method (POST, PUT or DELETE)
@param url URL to execute HTTP method
@param body The information of a resource
@return job_result.json()["affectedResources"][0]
        URL of an affected resource
"""

def invoke_async_command(method_type, url, body):
    if method_type == "put":
        if body is None:
            r = requests.put(url, headers=headers, verify=False)
        else:
            r = requests.put(url, headers=headers,
                             data=json.dumps(body), verify=False)
    elif method_type == "post":
        r = requests.post(
            url,
            headers=headers,
            data=json.dumps(body),
            verify=False)
    elif method_type == "delete":
        r = requests.delete(
            url,
            headers=headers,
            verify=False)
    if r.status_code != http.client.ACCEPTED:
        raise requests.HTTPError(r)
    print("Request was accepted. JOB URL : " +
          r.json()["self"])
    status = "Initializing"
    job_result = None
    retry_count = 1
    wait_time = FIRST_WAIT_TIME
    while status != "Completed":
        if retry_count > MAX_RETRY_COUNT:
            raise Exception("Timeout Error! "
                             "Operation was not completed.")
        time.sleep(wait_time)
        job_result = check_update(r.json()["jobId"])
        status = job_result.json()["status"]
        double_time = wait_time * 2
        if double_time < 120:

```

```

        wait_time = double_time
    else:
        wait_time = 120
        retry_count += 1
    if job_result.json()["state"] == "Failed":
        error_obj = job_result.json()["error"]
        if "errorCode" in error_obj:
            if "SSB1" in error_obj["errorCode"]:
                print("Error! SSB code : ",
                      error_obj["errorCode"]["SSB1"],
                      ", ", error_obj["errorCode"]["SSB2"])
            elif "errorCode" in error_obj["errorCode"]:
                print("Error! error code : ",
                      error_obj["errorCode"]["errorCode"])
            raise Exception("Job Error!", job_result.text)
        if "affectedResources" in job_result.json():
            print("Async job was succeeded. affected resource : " +
                  job_result.json()["affectedResources"][0])
            return job_result.json()["affectedResources"][0]
        else:
            print("Async job was succeeded.")
            return None

```

4. Check the version of the REST API.

Get information about the version of the REST API to make sure that the version is supported.

```

"""
Check whether this API version allows the REST
Server to execute this program

@param api_version api version of this REST Server
@param required_major_version the lowest number of
    the major version that this program requires
@param required_minor_version the lowest number of
    the minor version that this program requires

"""

def check_api_version(api_version, required_major_version,
                     required_minor_version):
    version = api_version.split(".")
    major_version = int(version[0])
    minor_version = int(version[1])
    if not ((major_version == required_major_version and
             minor_version >= required_minor_version) or
            major_version >= required_major_version + 1):
        sys.exit("This program requires API Version " +

```



```

        str(required_major_version) + "." +
        str(required_minor_version) +
        "." + "x or newer.\n")

try:
    # step1 Check the API version #
    print("Check the API version")
    url = block_storage_api.api_version()
    r = requests.get(url, headers=headers, verify=False)
    if r.status_code != http.client.OK:
        raise requests.HTTPError(r)
    check_api_version(
        r.json()["apiVersion"],
        REQUIRED_MAJOR_VERSION,
        REQUIRED_MINOR_VERSION)

```

5. Generate a session.

Generate sessions by using the REST API server.

```

# step2 Generate a session #
print("Generate a session")
url = block_storage_api.generate_session()
r = requests.post(url, headers=headers,
                  auth=USER_CREDENTIAL, verify=False)
if r.status_code != http.client.OK:
    raise requests.HTTPError(r)
token = r.json()["token"]
auth = "Session " + token
session_id = r.json()["sessionId"]
headers["Authorization"] = auth

```

When you generate a session, a session ID and a token are returned. When running the API, specify the token for the Authentication header as the required authentication information for the subsequent operations. Use the session ID to discard the session after a set of operations is completed.

6. Get information about the parity group.

Get information about the parity group by specifying its parity group number. From the acquired information, the sample coding outputs the following information: number of LDEVs in the parity group, usage rate of the parity group, available capacity, RAID level, RAID type, CLPR number, code indicating the drive type of the drives belonging to the parity group, drive type of the drives that belong to the parity group, rotation speed of the drives belonging to the parity group, value of the encryption setting of the parity group, total logical capacity of the parity group, total physical capacity of the parity group, and value of the accelerated compression setting of the parity group.

```

# step3 Get the parity group #
print("Get the parity group")
url = block_storage_api.parity_group(PARITY_GROUP_ID)

```

```

r = requests.get(url, headers=headers,
                 auth=USER_CREDENTIAL, verify=False)
if r.status_code != http.client.OK:
    raise requests.HTTPError(r)

raidType = r.json()["raidType"]
isCopyBackModeEnabled = r.json()["isEncryptionEnabled"]
isAcceleratedCompressionEnabled = r.json(
["isAcceleratedCompressionEnabled"]
    clprId = r.json()["clprId"]
    print("NUM OF LDEVS : " + str(r.json()["numOfLdevs"]))
    print("USED CAPACITY RATE : " + str(r.json()["usedCapacityRate"]))
    print("AVAILABLE VOLUME CAPACITY : " + str(r.json(
["availableVolumeCapacity"]))
        print("RAID LEVEL : " + str(r.json()["raidLevel"]))
        print("RAID TYPE : " + str(r.json()["raidType"]))
        print("CLPR ID : " + str(r.json()["clprId"]))
        print("DRIVE TYPE : " + r.json()["driveType"])
        print("DRIVE TYPE NAME : " + str(r.json()["driveTypeName"]))
        print("DRIVE SPEED : " + str(r.json()["driveSpeed"]))
        print("IS ENCRYPTION ENABLED : " + str(r.json(
["isEncryptionEnabled"]))
            print("TOTAL CAPACITY : " + str(r.json()["totalCapacity"]))
            print("PHYSICAL TOTAL CAPACITY : " + str(r.json(
["physicalCapacity"]))
                print("IS ACCELERATED COMPRESSION ENABLED : " + str(r.json(
["isAcceleratedCompressionEnabled"]))
                    print()

```

7. Get information about drives.

Get information about drives that belong to a parity group by specifying its parity group number.

```

# step4 Get drives #
print("Get drives")
url = block_storage_api.drives_parity_group(PARITY_GROUP_ID)
r = requests.get(url, headers=headers,
                 auth=USER_CREDENTIAL, verify=False)
if r.status_code != http.client.OK:
    raise requests.HTTPError(r)

drive_ids = []
for d in r.json()["data"]:
    drive_ids.append(d["driveLocationId"])
    print("DRIVE LOCATION ID : " + str(r.json(
["driveLocationId"]))
        print()

```

8. Delete the parity group.

Delete the parity group by specifying its parity group number.

```
# step5 Delete the parity group #
print("Delete the parity group")
url = block_storage_api.parity_group(PARITY_GROUP_ID)
invoke_async_command("delete", url, None)
```

The `invoke_async_command` function issues a request to delete the parity group, checks the execution statuses of the jobs that were executed asynchronously, and then returns the URL of the deleted parity group as the execution result.

9. Create a parity group.

Create a parity group by specifying a parity group number and drive IDs.

```
# step6 Create the parity group #
print("Create the parity group")
url = block_storage_api.parity_groups()
body = {
    "parityGroupId": PARITY_GROUP_ID,
    "driveLocationIds": drive_ids,
    "raidType": raidType,
    "isEncryptionEnabled": True,
    "isCopyBackModeEnabled": isCopyBackModeEnabled,
    "isAcceleratedCompressionEnabled":
isAcceleratedCompressionEnabled,
    "clprId": clprId
}
invoke_async_command("post", url, body)
```

The `invoke_async_command` function issues a request to create a parity group, checks the execution statuses of jobs that were executed asynchronously, and then returns the URL of the created parity group as the execution result.

10. Get information about the parity group.

To check whether the operations up to this step have been correctly applied to the resource, get information about the parity group by specifying the parity group number you acquired when you created the parity group. From the acquired information, the sample coding outputs the following information: number of LDEVs in the parity group, usage rate of the parity group, available capacity, RAID level, RAID type, CLPR number, code indicating the drive type of the drives belonging to the parity group, drive type of the drives that belong to the parity group, rotation speed of the drives belonging to the parity group, value of the encryption setting of the parity group, total logical capacity of the parity group, total physical capacity of the parity group, and value of the accelerated compression setting of the parity group.

```
# step7 Get the parity group #
print("Get the parity group")
```

```

url = block_storage_api.parity_group(PARITY_GROUP_ID)
r = requests.get(url, headers=headers,
                 auth=USER_CREDENTIAL, verify=False)
if r.status_code != http.client.OK:
    raise requests.HTTPError(r)

print("NUM OF LDEVS : " + str(r.json()["numOfLdevs"]))
print("USED CAPACITY RATE : " + str(r.json()["usedCapacityRate"]))
print("AVAILABLE VOLUME CAPACITY : " + str(r.json()
["availableVolumeCapacity"]))
print("RAID LEVEL : " + str(r.json()["raidLevel"]))
print("RAID TYPE : " + str(r.json()["raidType"]))
print("CLPR ID : " + str(r.json()["clprId"]))
print("DRIVE TYPE : " + r.json()["driveType"])
print("DRIVE TYPE NAME : " + str(r.json()["driveTypeName"]))
print("DRIVE SPEED : " + str(r.json()["driveSpeed"]))
print("IS ENCRYPTION ENABLED : " + str(r.json()
["isEncryptionEnabled"]))
print("TOTAL CAPACITY : " + str(r.json()["totalCapacity"]))
print("PHYSICAL TOTAL CAPACITY : " + str(r.json()
["physicalCapacity"]))
print("IS ACCELERATED COMPRESSION ENABLED : " + str(r.json()
["isAcceleratedCompressionEnabled"]))
print()

```

11. Output error messages.

In the sample coding, processing for communication errors, HTTP request errors, and job execution errors is described. If a communication error occurs, an error message is output. If an HTTP request error occurs, the error code, the error message, and the response body are output. If a job execution error occurs, all of the contents included in the job execution result are output.

```

except requests.ConnectionError:
    sys.stderr.write("Connection Error!\n")
    sys.stderr.write(traceback.format_exc())
except requests.HTTPError as he:
    sys.stderr.write("HTTP Error! status code : ")
    sys.stderr.write(str(he.args[0].status_code) + "\n")
    sys.stderr.write(he.args[0].text + "\n")
except Exception as e:
    sys.stderr.write(traceback.format_exc())
    for msg in e.args:
        sys.stderr.write(str(msg) + "\n")

```

12. Discard the session.

After a set of operations is completed, discard the session. Specify the session ID that was obtained when the session was generated. The "finally" statement in the sample coding makes sure that the session will be discarded even if an error occurs while the API is running. After the session is discarded, the processing ends.

```
finally:
    # step8 Discard the session #
    print("Discard the session")
    url = block_storage_api.discard_session(session_id)
    r = requests.delete(url, headers=headers, verify=False)
    try:
        if r.status_code != http.client.OK:
            raise requests.HTTPError(r)
    except requests.HTTPError as he:
        sys.stderr.write("HTTP Error! status code : ")
        sys.stderr.write(str(he.args[0].status_code) + "\n")
        sys.stderr.write(he.args[0].text + "\n")

    print("Operation was completed.")
    sys.exit()
```

Functions used in the sample coding

This section explains the functions used in the sample coding.

Generating a URL

In the sample coding, the functions that generate the URL to be used in the HTTP request are defined in the BlockStorageAPI class, and are called from the main processing when needed. If you specify the required parameters for each target resource or the method to use, these functions generate and return the corresponding URL. The following explains the sample coding for BlockStorageAPI.

In this sample coding, the storage device ID to be used in the URL is generated from the model name and serial number of the storage system specified by the parameters. The storage device ID is generated by replacing the model name specified by the STORAGE_MODEL_DICT parameter with the fixed value of the type of the storage system. If necessary, change the value to match the system environment and requirements.

```
# coding:utf-8
"""
This class creates a URL for the REST API
to manage block storage
"""

# For VSP G350, G370, G700, G900, VSP F350, F370, F700, F900
STORAGE_MODEL_DICT = {
    "VSP G900": "886000",
    "VSP G700": "886000",
    "VSP G370": "886000",
```

```

        "VSP G350": "882000",
        "VSP F900": "886000",
        "VSP F700": "886000",
        "VSP F370": "886000",
        "VSP F350": "882000"}

class BlockStorageAPI():
    # GUM IP address
    gum_ip_addr = None
    # port number
    port = None
    # storage URL
    base_url = None
    # object URL
    object_url = None
    # service URL
    service_url = None
    # storage device ID
    storage_id = None

```

Generate the common part, in the following format, of the requests in the URL:

For the objects domain:

```
protocol://host-name:port-number/ConfigurationManager/version/objects
```

For the services domain:

```
protocol://host-name:port-number/ConfigurationManager/version/
services
```

```

def __init__(self, gum_ip_addr, port, storage_model,
              serial_number):
    self.gum_ip_addr = gum_ip_addr
    self.port = port
    self.storage_id = STORAGE_MODEL_DICT[storage_model] \
        + serial_number
    self.base_url = "https://" + \
        self.gum_ip_addr + ":" + self.port + \
        "/ConfigurationManager/v1"
    self.object_url = "/objects"
    self.service_url = "/services"

```

Next, define the functions according to the target resource and the operation. For example, the URL for creating a volume is generated by the `block_storage_api.ldevs` that corresponds to `ldevs`.

```

def get_storage_id(self):
    return self.storage_id

```

```

def ldevs(self):
    url = self.base_url + self.object_url + "/ldevs"
    return url

def undefined_ldev(self):
    url = self.ldevs() + \
        "?ldevOption=undefined&count=1"
    return url

def ldev(self, object_id):
    url = self.ldevs() + "/" + str(object_id)
    return url

def host_groups(self):
    url = self.base_url + self.object_url + "/host-groups"
    return url

def host_wwns(self):
    url = self.base_url + self.object_url + "/host-wwns"
    return url

def luns(self):
    url = self.base_url + self.object_url + "/luns"
    return url

def local_copy_pairs(self):
    url = self.base_url + self.object_url + \
        "/local-clone-copypairs"
    return url

def split_local_copy_pair_template(self, pair_url):
    url = pair_url + "/actions/split"
    return url

def split_local_copy_pair(self, pair_url):
    url = pair_url + "/actions/split/invoke"
    return url

def generate_session(self):
    url = self.base_url + self.object_url + "/sessions"
    return url

def discard_session(self, object_id):
    url = self.base_url + self.object_url + "/sessions/" + \
        str(object_id)
    return url

def lock(self):
    url = self.base_url + self.service_url + \
        "/resource-group-service/" + \

```

```

        "actions/lock/invoke"
    return url

def unlock(self):
    url = self.base_url + self.service_url + \
        "/resource-group-service/" + \
        "actions/unlock/invoke"
    return url

def remote_storage(self):
    url = self.base_url + self.object_url + \
        "/remote-storages"
    return url

def remote_copy_pairs(self):
    url = self.base_url + self.object_url + \
        "/remote-mirror-coppairs"
    return url

def job(self, object_id):
    url = self.base_url + self.object_url + "/jobs/" + \
        str(object_id)
    return url

def affected_resource(self, affected_resource):
    url = "https://" + self.gum_ip_addr + ":" + \
        self.port \
        + affected_resource
    return url

def api_version(self):
    url = "https://" + self.gum_ip_addr + ":" + \
        self.port \
        + "/ConfigurationManager/configuration/version"
    return url

def file_upload(self):
    url = self.base_url + self.object_url + \
        "/actions/file-upload/invoke"
    return url

def auditlog_syslog(self):
    url = self.base_url + self.object_url + \
        "/auditlog-syslog-servers" + "/instance"
    return url

def auditlog_syslog_send_test(self):
    url = self.auditlog_syslog() + \
        "/actions/send-test/invoke"
    return url

```



```

def drives(self):
    url = self.base_url + self.object_url + "/drives"
    return url

def drives_parity_group(self, parity_group_id):
    url = self.drives() + "?parityGroupId=" + str(parity_group_id)
    return url

def parity_groups(self):
    url = self.base_url + self.object_url + "/parity-groups"
    return url

def parity_group(self, object_id):
    url = self.parity_groups() + "/" + str(object_id)
    return url

def encryption_keys(self):
    url = self.base_url + self.object_url + "/encryption-keys"
    return url

def encryption_key(self, object_id):
    url = self.encryption_keys() + "/" + str(object_id)
    return url

def encryption_key_file(self):
    url = self.encryption_key("file")
    return url

def encryption_key_file_backup(self):
    url = self.encryption_key_file() + "/actions/backup/invoke"
    return url

def encryption_key_file_restore(self):
    url = self.encryption_key_file() + "/actions/restore/invoke"
    return url

```

Issuing an HTTP request and verifying the status of asynchronous processing

In the REST API, operations such as creating an object or changing its attributes are registered as jobs and run asynchronously. For asynchronous processing, you must confirm that the jobs are complete before obtaining the resource to which the request execution result is applied. In the sample coding, the `invoke_async_command` function is used to issue the request and to perform the processing for waiting for the completion of the jobs. After the method type, URL, and request body are specified, the `invoke_async_command` function issues the request according to the specified method, waits for the completion of the job, and then returns the resource information.

The `invoke_async_command` function is defined in the coding samples for volume allocation, ShadowImage pair operation, and registration of remote storage system information. The following examples show the contents of coding samples for the `invoke_async_command` function.

First, define the function that gets the job status. This function is called by using the `invoke_async_command` function.

```
"""
Check whether the asynchronous command was finished.
@param job_id the job ID to identify
        the asynchronous command
@return r the response data
"""

def check_update(job_id):
    url = block_storage_api.job(str(job_id))
    r = requests.get(url, headers=headers, verify=False)
    return r
```

Next, define the `invoke_async_command` function. Specify the settings so that when a request is generated, the request body is generated in JSON format. Specify the authentication information by using the token obtained when a session was generated.

```
"""
Execute the HTTP request (POST or PATCH)
@param method_type HTTP request method (POST or PATCH)
@param url URL to execute HTTP method
@param body The information of a resource
@return job_result.json()["affectedResources"][0]
        URL of an affected resource
"""

def invoke_async_command(method_type, url, body):
    if method_type == "patch":
        r = requests.patch(url, headers=headers,
                           data=json.dumps(body), verify=False)
    elif method_type == "post":
        r = requests.post(
            url,
            headers=headers,
            data=json.dumps(body),
            verify=False)
    if r.status_code != http.client.ACCEPTED:
        raise requests.HTTPError(r)
    print("Request was accepted. JOB URL : " +
          r.json()["self"])
```

After the request is issued, the job status is repeatedly obtained until the job status changes to `Completed`. If the job does not finish before the maximum number of retries specified in the parameter is reached, the processing ends. In addition, if an error occurs for the job, the error code is obtained and the processing ends.

```

status = "Initializing"
job_result = None
retry_count = 1
wait_time = FIRST_WAIT_TIME
while status != "Completed":
    if retry_count > MAX_RETRY_COUNT:
        raise Exception("Timeout Error! "
                        "Operation was not completed.")
    time.sleep(wait_time)
    job_result = check_update(r.json()["jobId"])
    status = job_result.json()["status"]
    double_time = wait_time * 2
    if double_time < 120:
        wait_time = double_time
    else:
        wait_time = 120
    retry_count += 1
if job_result.json()["state"] == "Failed":
    error_obj = job_result.json()["error"]
    if "errorCode" in error_obj:
        if "SSB1" in error_obj["errorCode"]:
            print("Error! SSB code : ",
                  error_obj["errorCode"]["SSB1"],
                  ", ", error_obj["errorCode"]["SSB2"])
        elif "errorCode" in error_obj["errorCode"]:
            print("Error! error code : ",
                  error_obj["errorCode"]["errorCode"])
    raise Exception("Job Error!", job_result.text)

```

After the job is complete and the status changes to `Completed`, the URL of the resource to which the job execution result is applied is obtained. The first result is obtained because only one result is returned to `affectedResources`.

```

print("Async job was succeeded. affected resource : " +
      job_result.json()["affectedResources"][0])
return job_result.json()["affectedResources"][0]

```

Getting status changes for asynchronous processing

The `wait_until_jobstatus_is_changed` function gets the status of the jobs that were asynchronously run by the REST API, waits until the job status changes to the specified execution status, and then returns the resource information. The `wait_until_jobstatus_is_changed` function is defined in the coding samples for a TrueCopy pair operation. The following example shows the contents of coding samples for the `wait_until_jobstatus_is_changed` function.

First, define the function that gets the job status. This function is called by using the `wait_until_jobstatus_is_changed` function.

```
"""
Check whether the asynchronous command was finished.

@param storage_api storage_api
@param job_id the job ID to identify
           the asynchronous command
@param headers the array of the http headers
@return r the response data
"""

def check_update(storage_api, job_id, headers):
    url = storage_api.job(str(job_id))
    r = requests.get(url, headers=headers, verify=False)
    return r
```

Next, define the `wait_until_jobstatus_is_changed` function. For `changed_status`, specify the job status that needs to be detected when a job status has changed to that status. If `True` is specified for `is_retry_count_enabled`, after processing is tried again for the number of times specified in the `MAX_RETRY_COUNT` parameter, a timeout error will be returned. If `False` is specified, processing will wait until a job moves to the specified status.

```
"""
Wait until the job status is changed

@param storage_api storage_api
@param headers the array of the http headers
@param job_id the job ID to identify
           the asynchronous command
@param changed_status job status after waiting
@param is_retry_count_enabled if true, wait
           until MAX_RETRY_COUNT. if false, wait forever
           until job status is changed.
@return job_result.json()["affectedResources"][0]
           URL of an affected resource
"""

def wait_until_jobstatus_is_changed(
    storage_api,
    headers,
    job_id,
    changed_status,
    is_retry_count_enabled):
    status = "Initializing"
    retry_count = 1
```

```

wait_time = FIRST_WAIT_TIME
while status != changed_status:
    if status == "Completed":
        print("Status was already changed" +
              "to Completed.")
        break
    if is_retry_count_enabled and \
        retry_count > MAX_RETRY_COUNT:
        raise Exception("Timeout Error! "
                        "Operation was not completed.")
    time.sleep(wait_time)
    job_result = check_update(storage_api,
                              job_id, headers)
    status = job_result.json()["status"]
    double_time = wait_time * 2
    if double_time < 120:
        wait_time = double_time
    else:
        wait_time = 120
        retry_count += 1
if job_result.json()["state"] == "Failed":
    error_obj = job_result.json()["error"]
    if "errorCode" in error_obj:
        if "SSB1" in error_obj["errorCode"]:
            print("Error! SSB code : ",
                  error_obj["errorCode"]["SSB1"],
                  ", ", error_obj["errorCode"]["SSB2"])
        elif "errorCode" in error_obj["errorCode"]:
            print("Error! error code : ",
                  error_obj["errorCode"]["errorCode"])
        raise Exception("Job Error!", job_result.text)
print("Async job was succeeded. affected resource : " +
      job_result.json()["affectedResources"][0])
return job_result.json()["affectedResources"][0]

```

Appendix A: Notes and restrictions

The following restrictions apply when using the REST API.

Notes and restrictions

Notes on the VSP N series

In this manual, the phrase "VSP Gx00 models, VSP Fx00 models" should be interpreted to also include the following storage system models: VSP N400, VSP N600, VSP N800.

Executing an asynchronous processing API function to the REST API server

When a user executes an asynchronous processing API function job that takes two hours or more to process, the KART30031-E error occurs and the job fails.

This problem occurs if the user executes an API function command to perform one of the following tasks and the job takes two hours or more to complete.

- Deleting a journal volume from a journal
- Formatting a volume
- Shredding a volume
- Formatting a parity group
- Deleting a parity group
- Initializing the capacity-saving function for a pool
- Shrinking a pool
- Restoring a pool
- Relocating a pool

Even though the KART30031-E error occurs, the request might have succeeded. Confirm the status of the resources.

Display of the pair concordance rate and the processing progress rate in the Thin Image pair information

If all of the following conditions are met, the `progressRate` attribute, which indicates the progress of processing, is displayed:

- The `isClone` attribute of the pair is set to `false`.
- The `canCascade` attribute of the pair is set to `false`.
- The pair status is `COPY`, `RCPY`, `SMPP`, or `PSUP`.

In the above case, the value displayed for the `progressRate` attribute is actually the value of the `concordanceRate` attribute.

Problems related to the synchronization of the date and time between the NTP server and the storage system in REST API

A difference of several hours between the storage system's date and time and the NTP server's date and time occurs if all of the following conditions are met:

- A time zone for which daylight saving time is supported is set.
- Automatic adjustment of daylight saving time is enabled.
- You synchronize the storage system with the NTP server during the transition period from standard time to daylight saving time or the transition period from daylight saving time to standard time.

To recover from this problem, synchronize with the NTP server again after the transition period from standard time to daylight saving time or the transition period from daylight saving time to standard time.

Problems related to automatic adjustments for daylight saving time in the date and time of the storage system in REST API

The symptoms of this problem occur if all of the following conditions are met:

- A time zone for which daylight saving time is supported is set.
- Automatic adjustment of daylight saving time is enabled.

Symptom 1:

- An NTP server synchronization time that was set during standard time incorrectly changes to one hour earlier than the actual time when daylight saving time begins.
- An NTP server synchronization time that was set during daylight saving time incorrectly changes to one hour later than the actual time when daylight saving time ends.

To resolve this problem, reset the NTP server synchronization time by re-executing the API function to change the date and time of the storage system after daylight saving time begins or ends.

Symptom 2:

- When the date and time of the REST server is in daylight saving time and the date and time of the storage system is in standard time, a time one hour earlier than the time you request as the time of synchronization with the NTP server is set as the synchronization time for the storage system.
- When the date and time of the REST server is in standard time and the date and time of the storage system is in daylight saving time, a time one hour later than the time you request as the time of synchronization with the NTP server is set as the synchronization time for the storage system.

To resolve this problem, set the same date and time for the REST server and the NTP server, and then re-set the NTP server synchronization time by re-executing the API function to change the date and time of the storage system.

Error on the API which multiple operations are performed internally

If the error occurred by using the following API, a part of the resource might be created.

- HDT pool creation

When the error occurred, check the status of the resource, delete the resource created partially, and perform the API again.

Creating Thin Image pairs

If the following conditions are met, attempts to create Thin Image pairs fail, and the KART00000-E message is output.

1. The specified snapshot group name is already being used for another snapshot group.
2. The API command to create a Thin Image pair is executed when the API command to delete a Thin Image pair is executed at the same time, and both APIs are using the same `pvolLdevId` attribute without `svolLdevId` attribute.

If this problem occurs, re-execute the API command to create a Thin Image pair.

Restriction that applies when the maximum number of storage system resources is exceeded as a result of resource creation

If the maximum number of resources already exist on the storage system and you use one of the following API commands to create a new resource, the job might fail and the KART30013-E message might be output:

- Creating a host group (without specifying `hostGroupNumber`)
- Creating an LU path (without specifying `lun`)

If an error occurs and the KART30013-E message is output, obtain a list of the target resources and then check whether the number of the existing resources has reached the maximum number of resources allowed on the storage system. For details about the maximum number of resources that can be created on a storage system, see the *Provisioning Guide*.

Creating Thin Image pair

Creating Thin Image pair API may fail with KART40188-E or KART4009-E when `clonesAutomation=true` or `autoSplit=true` is specified.

Execute cloning Thin Image pair API or storing snapshot data API after confirming if pair status of Thin Image is "PAIR".

Getting a list of external path groups

When getting a list of external path groups in an environment where number of external path is 10000 or more, all of the information may not be obtained.

Perform the follow actions after checking the `nextPageHeadPathGroupId` in the external path group:

- When the value of `nextPageHeadPathGroupId` is other than `-1`, execute the getting list of external path group API with specifying the value of `nextPageHeadPathGroupId` by the value of the previous `headPathGroupId`, and obtain the list of the external path groups in the range that could not be acquired.
- When the value of `nextPageHeadPathGroupId` is `-1`, no additional action is required.

affectedResources when a job is executed by using the REST API

When any of the following operations is executed, `affectedResources` displays an incorrect URL.

- Unmapping an external volume

```
DELETE base-URL/v1/objects/external-parity-groups/object-ID
```

- Removing an external path from an external path group

```
POST base-URL/v1/objects/external-path-groups/object-ID/actions/remove-path/invoke
```

- Disconnecting from an external volume

```
POST base-URL/v1/objects/external-parity-groups/object-ID/actions/disconnect/invoke
```

- Performing migration

```
POST base-URL/v1/objects/local-clone-coppairs/object-ID/actions/migrate/invoke
```

- Performing migration for an entire copy group

```
POST base-URL/v1/objects/local-clone-copygroups/object-ID/actions/migrate/invoke
```

To check whether the above operations were successful, execute the following APIs.

- Unmapping an external volume

```
GET base-URL/v1/objects/external-path-groups
```

- Removing an external path from an external path group

```
GET base-URL/v1/objects/external-path-groups/object-ID
```

- Disconnecting from an external volume

```
GET base-URL/v1/objects/external-path-groups
```

- Performing migration #

```
GET base-URL/v1/objects/local-clone-coppairs/object-ID
```

- Performing migration for an entire copy group #

```
GET base-URL/v1/objects/local-clone-copygroups/object-ID
```

#: The possible pair statuses are as follows.

If the pair status is PSUS: Migration succeeded.

If the pair status is PSUE: Migration failed.

Device group name

Do not specify "dummydevgroup" as a device group name.

If "dummydevgroup" is specified as a device group name, API response takes much time, or error might occur with KART20022-E message.

Recovery procedure when REST API doesn't respond for a long period

When REST API doesn't respond for a long period, reboot the GUM that the CTL has a problem by using maintenance utility. If REST API still doesn't respond after GUM is rebooted, detailed investigation is required. Collect the normal dump and contact the support center.

Copy group names and device group names for copy groups, and snapshot group IDs for snapshot groups

If any attribute of the following object IDs contains a comma ("," or "%2c"), the KART40014-E error occurs when an API for managing copy groups or snapshot groups is executed:

- pvolDeviceGroupName
- svolDeviceGroupName
- localDeviceGroupName
- remoteDeviceGroupName
- copyGroupName
- copyPairName
- snapshotGroupId

Note that, when an object ID includes commas for combining attribute values, such commas do not cause the KART40014-E error.

Index

A

access control 77
action template object 50
asynchronous processing 26
Authorization header 27

D

data object 41
data type 39

E

error object 45

G

GUM 18

H

HTTP method 26
HTTP status code 34

J

job 42
job object 42
JSON 36, 39

L

locking resources 51

O

object ID 24
output format 40

P

password 79

Q

query parameter 38

R

request header 30
request object 50
response header 34
REST API client 18
REST API server 18

S

session 29
SSL communication 19
synchronous processing 26
system configuration 18

U

user ID 79
user management 77

Hitachi Vantara



Corporate Headquarters
2535 Augustine Drive
Santa Clara, CA 95054 USA
HitachiVantara.com | community.HitachiVantara.com

Contact Information
USA: 1-800-446-0744
Global: 1-858-547-4526
HitachiVantara.com/contact