

Hitachi Virtual Storage Platform E590 and E790

93-05-02

Hardware Reference Guide

This document provides information about the system hardware components and the mechanical and environmental specifications for the VSP E590 and VSP E790 storage systems.

© 2020, 2021 Hitachi, Ltd. All rights reserved.

No part of this publication may be reproduced or transmitted in any form or by any means, electronic or mechanical, including copying and recording, or stored in a database or retrieval system for commercial purposes without the express written permission of Hitachi, Ltd., or Hitachi Vantara LLC (collectively "Hitachi"). Licensee may make copies of the Materials provided that any such copy is: (i) created as an essential step in utilization of the Software as licensed and is used in no other manner; or (ii) used for archival purposes. Licensee may not make any other copies of the Materials. "Materials" mean text, data, photographs, graphics, audio, video and documents.

Hitachi reserves the right to make changes to this Material at any time without notice and assumes no responsibility for its use. The Materials contain the most current information available at the time of publication.

Some of the features described in the Materials might not be currently available. Refer to the most recent product announcement for information about feature and product availability, or contact Hitachi Vantara LLC at https://support.hitachivantara.com/en_us/contact-us.html.

Notice: Hitachi products and services can be ordered only under the terms and conditions of the applicable Hitachi agreements. The use of Hitachi products is governed by the terms of your agreements with Hitachi Vantara LLC.

By using this software, you agree that you are responsible for:

1. Acquiring the relevant consents as may be required under local privacy laws or otherwise from authorized employees and other individuals; and
2. Verifying that your data continues to be held, retrieved, deleted, or otherwise processed in accordance with relevant laws.

Notice on Export Controls. The technical data and technology inherent in this Document may be subject to U.S. export control laws, including the U.S. Export Administration Act and its associated regulations, and may be subject to export or import regulations in other countries. Reader agrees to comply strictly with all such regulations and acknowledges that Reader has the responsibility to obtain licenses to export, re-export, or import the Document and any Compliant Products.

Hitachi and Lumada are trademarks or registered trademarks of Hitachi, Ltd., in the United States and other countries.

AIX, AS/400e, DB2, Domino, DS6000, DS8000, Enterprise Storage Server, eServer, FICON, FlashCopy, GDPS, HyperSwap, IBM, Lotus, MVS, OS/390, PowerHA, PowerPC, RS/6000, S/390, System z9, System z10, Tivoli, z/OS, z9, z10, z13, z14, z/VM, and z/VSE are registered trademarks or trademarks of International Business Machines Corporation.

Active Directory, ActiveX, Bing, Excel, Hyper-V, Internet Explorer, the Internet Explorer logo, Microsoft, the Microsoft Corporate Logo, MS-DOS, Outlook, PowerPoint, SharePoint, Silverlight, SmartScreen, SQL Server, Visual Basic, Visual C++, Visual Studio, Windows, the Windows logo, Windows Azure, Windows PowerShell, Windows Server, the Windows start button, and Windows Vista are registered trademarks or trademarks of Microsoft Corporation. Microsoft product screen shots are reprinted with permission from Microsoft Corporation.

All other trademarks, service marks, and company names in this document or website are properties of their respective owners.

Copyright and license information for third-party and open source software used in Hitachi Vantara products can be found at <https://www.hitachivantara.com/en-us/company/legal.html>.

Contents

Preface	5
Intended audience.....	5
Product version.....	5
Release notes.....	5
Changes in this revision.....	5
Document conventions.....	5
Accessing product documentation.....	7
Getting help.....	7
Comments.....	7
Chapter 1: Introduction	8
Key features.....	8
Storage system specifications.....	9
Chapter 2: Hardware overview	14
Controller chassis.....	14
Controller board.....	17
Front-end modules.....	18
10-Gbps iSCSI board LEDs and connectors (optical).....	19
10-Gbps iSCSI board LEDs and connectors (copper).....	20
16-Gbps or 32-Gbps Fibre Channel (4-port) board LEDs and connectors.....	22
LAN blade LEDs and connectors.....	23
Small form-factor drive tray (DBSE).....	24
SFF with front panel bezel.....	24
SFF front panel without bezel.....	25
SFF rear panel.....	26
AC power supply unit LEDs and connectors.....	27
Small form-factor drive tray (DBS2).....	28
SFF with front panel bezel.....	28
SFF front panel without bezel.....	29
SFF rear panel.....	30
AC power supply unit LEDs and connectors.....	31
Large form-factor drive tray (DBLE).....	31
LFF with front panel bezel.....	32

LFF front panel without bezel.....	33
LFF rear panel.....	34
AC power supply unit LEDs and connectors.....	35
High-density intermix drive tray (DB60).....	35
Dense intermix drive tray with front panel bezel.....	36
Dense intermix drive tray display LEDs.....	37
Dense intermix drive tray rear panel.....	38
Rack support.....	39
Chapter 3: Specifications.....	40
Environmental specifications.....	40
Electrical specifications.....	42
Physical specifications.....	43
Chapter 4: Turning storage system power on and off.....	46
Powering on the storage system.....	46
Powering off the storage system.....	47
Chapter 5: Site preparation.....	48
Site preparation checklist.....	48
Site planning.....	49
Installation site considerations.....	50
Floor cutout and service clearance.....	50
Floor load rating.....	52
Installing anti-tilt bracket for Universal V3 Rack.....	52
Appendix A: Component list.....	54
Component list.....	54

Preface

This guide describes the hardware features and specifications of the VSP E590 and VSP E790 storage systems.

Intended audience

This document is intended for Hitachi Vantara representatives, system administrators, authorized service providers, or customers who configure and operate the VSP E590 and VSP E790 storage systems.

Readers of this document should be familiar with the following:

- Data processing and RAID storage systems and their basic functions
- RAID storage system hardware components and operational specifications

Product version

This document revision applies to VSP E590 and VSP E790 firmware 93-05-02 or later.

Release notes

Read the release notes before installing and using this product. They may contain requirements or restrictions that are not fully described in this document or updates or corrections to this document. Release notes are available on the Hitachi Vantara Support Website: <https://knowledge.hitachivantara.com/Documents>.

Changes in this revision

- Added information and specifications for SAS expansion.



Document conventions

This document uses the following typographic conventions:

Convention	Description
Bold	<ul style="list-style-type: none"> Indicates text in a window, including window titles, menus, menu options, buttons, fields, and labels. Example: Click OK. Indicates emphasized words in list items.
<i>Italic</i>	<ul style="list-style-type: none"> Indicates a document title or emphasized words in text. Indicates a variable, which is a placeholder for actual text provided by the user or for output by the system. Example: <pre>pairdisplay -g group</pre> (For exceptions to this convention for variables, see the entry for angle brackets.)
Monospace	Indicates text that is displayed on screen or entered by the user. Example: <code>pairdisplay -g oradb</code>
< > angle brackets	Indicates variables in the following scenarios: <ul style="list-style-type: none"> Variables are not clearly separated from the surrounding text or from other variables. Example: <pre>Status-<report-name><file-version>.csv</pre> Variables in headings.
[] square brackets	Indicates optional values. Example: [a b] indicates that you can choose a, b, or nothing.
{ } braces	Indicates required or expected values. Example: { a b } indicates that you must choose either a or b.
vertical bar	Indicates that you have a choice between two or more options or arguments. Examples: [a b] indicates that you can choose a, b, or nothing. { a b } indicates that you must choose either a or b.

This document uses the following icons to draw attention to information:

Icon	Label	Description
	Note	Calls attention to important or additional information.

Icon	Label	Description
	Tip	Provides helpful information, guidelines, or suggestions for performing tasks more effectively.
	Caution	Warns the user of adverse conditions and/or consequences (for example, disruptive operations, data loss, or a system crash).
	WARNING	Warns the user of a hazardous situation which, if not avoided, could result in death or serious injury.

Accessing product documentation

Product user documentation is available on the Hitachi Vantara Support Website: <https://knowledge.hitachivantara.com/Documents>. Check this site for the most current documentation, including important updates that may have been made after the release of the product.

Getting help

The [Hitachi Vantara Support Website](https://support.hitachivantara.com/en_us/contact-us.html) is the destination for technical support of products and solutions sold by Hitachi Vantara. To contact technical support, log on to the Hitachi Vantara Support Website for contact information: https://support.hitachivantara.com/en_us/contact-us.html.

[Hitachi Vantara Community](https://community.hitachivantara.com) is a global online community for Hitachi Vantara customers, partners, independent software vendors, employees, and prospects. It is the destination to get answers, discover insights, and make connections. **Join the conversation today!** Go to community.hitachivantara.com, register, and complete your profile.

Comments

Please send us your comments on this document to doc.comments@hitachivantara.com. Include the document title and number, including the revision level (for example, -07), and refer to specific sections and paragraphs whenever possible. All comments become the property of Hitachi Vantara LLC.

Thank you!

Chapter 1: Introduction

The Hitachi Virtual Storage Platform VSP E590 and VSP E790 storage systems are high-performance, large-capacity data storage systems. The VSP E590 and VSP E790 all-flash arrays (AFAs) support NVMe and SAS solid-state drives (SSDs). The VSP E590H and VSP E790H hybrid models can be configured with both SSDs and hard disk drives (HDDs).

- The NVMe flash architecture delivers consistent, low-microsecond latency, which reduces the transaction costs of latency-critical applications and delivers predictable performance to optimize storage resources.
- The hybrid architecture allows for greater scalability and provides data-in-place migration support.

The VSP E590 and VSP E790 storage systems consist of a controller chassis, one or more drive boxes for hybrid models, and internal components such as fans and PCIe switches.

Key features

High performance

- Multiple controller configuration distributes processing across controllers
- High-speed processing facilitated by up to 768 GiB of cache
- I/O processing speed increased by NVMe flash drives
- High-speed front-end data transfer up to 32 Gbps for FC and 10 Gbps for iSCSI
- I/O response times as low as 66 microseconds
- Integrated with Hitachi Ops Center to improve IT operational efficiencies

High reliability

- Service continuity for all main components due to redundant configuration
- RAID 1, RAID 5, and RAID 6 support (RAID 6 including 14D+2P)
- Data security by transferring data to cache flash memory in case of a power outage

Scalability and versatility

- VSP E590: Up to 8.9 PB (internal and SAS expansion), 144 PB (external), and 4M IOPS
- VSP E790: Up to 8.9 PB (internal and SAS expansion), 216 PB (external), and 6.8M IOPS
- Heterogeneous connectivity supporting concurrent attachment to a variety of hosts, including VMware, Linux, UNIX, and Windows

Storage system specifications

The storage systems offer superior performance, resiliency, and agility, featuring response times as low as 64 microseconds, all backed up with the industry's first and most comprehensive 100% data availability guarantee. The following table lists the key operational and performance specifications for the storage system.

Table 1 VSP E790 specifications

Item		Specification	
System	Number of drives	Minimum	4
		Maximum	<ul style="list-style-type: none"> ▪ 24 (internal NVMe) ▪ 240 (SAS SSDs)
	RAID group configuration	RAID 6	<ul style="list-style-type: none"> ▪ 6D+2P ▪ 12D+2P ▪ 14D+2P
		RAID 5	<ul style="list-style-type: none"> ▪ 3D+1P ▪ 4D+1P ▪ 6D+1P ▪ 7D+1P
		RAID 1	<ul style="list-style-type: none"> ▪ 2D+2D ▪ 4D+4D
	Maximum number of spare drives		46 (maximum of 2 internal NVMe)
	Maximum number of volumes		49,152
	Maximum storage system capacity (physical capacity)	30 TB 2.5-inch SSD used	7.9 PB
	Maximum external configuration		192 PiB (216 PB)
Memory	Cache memory capacity	768 GiB	
Storage interface	DKC-drive interface	<ul style="list-style-type: none"> ▪ NVMe/Dual Port ▪ SAS/Dual Port 	
	Data transfer rate	<ul style="list-style-type: none"> ▪ 8 Gbps (NVMe) ▪ Max 12Gbps (SAS) 	

Item		Specification	
Device interface	Supported channel types	<ul style="list-style-type: none"> ▪ Fibre Channel (shortwave, longwave) ▪ iSCSI (optical) 	
	Data transfer rate	Fibre Channel	Up to 32 Gbps
		iSCSI (Optical)	10 Gbps
	Maximum number of front-end modules	<ul style="list-style-type: none"> ▪ 6 (NVMe only) ▪ 4 (with SAS expansion) 	

Table 2 VSP E790H specifications

Item		Specification	
System	Number of drives	Minimum	4
		Maximum	2.5-inch SAS: 240 3.5-inch SAS: 480 2.5-inch NVMe: 24
	RAID group configuration	RAID 6	<ul style="list-style-type: none"> ▪ 6D+2P ▪ 12D+2P ▪ 14D+2P
		RAID 5	<ul style="list-style-type: none"> ▪ 3D+1P ▪ 4D+1P ▪ 6D+1P ▪ 7D+1P
		RAID 1	<ul style="list-style-type: none"> ▪ 2D+2D ▪ 4D+4D
	Maximum number of spare drives		46 (maximum of 2 internal NVMe)
	Maximum number of volumes		49,152
	Maximum storage system capacity (physical capacity)	30 TB 2.5-inch SSD and 14 TB 3.5-inch HDD used	8.9 PB
	Maximum external configuration		192 PiB (216 PB)

Item		Specification	
Memory	Cache memory capacity	768 GiB	
Storage interface	DKC-drive interface	NVMe/Dual Port SAS/Dual Port	
	Data transfer rate	<ul style="list-style-type: none"> ▪ 8 Gbps (NVMe) ▪ Max 12 Gbps (SAS) 	
Device interface	Supported channel types	<ul style="list-style-type: none"> ▪ Fibre Channel (shortwave, longwave) ▪ iSCSI (optical) 	
	Data transfer rate	Fibre Channel	Up to 32 Gbps
		iSCSI (Optical)	10 Gbps
	Maximum number of front-end modules	<ul style="list-style-type: none"> ▪ 6 (NVMe only) ▪ 4 (with SAS expansion) 	

Table 3 VSP E590 specifications

Item		Specification	
System	Number of drives	Minimum	4
		Maximum	<ul style="list-style-type: none"> ▪ 24 (internal NVMe) ▪ 240 (SAS expansion SSDs)
	RAID group configuration	RAID 6	<ul style="list-style-type: none"> ▪ 6D+2P ▪ 12D+2P ▪ 14D+2P
		RAID 5	<ul style="list-style-type: none"> ▪ 3D+1P ▪ 4D+1P ▪ 6D+1P ▪ 7D+1P
		RAID 1	<ul style="list-style-type: none"> ▪ 2D+2D ▪ 4D+4D
	Maximum number of spare drives	46 (maximum of 2 internal NVMe)	
	Maximum number of volumes	32,768	

Item			Specification
	Maximum storage system capacity (physical capacity)	30 TB 2.5-inch SSD used	7.9 PB
	Maximum external configuration		128 PiB (144 PB)
Memory	Cache memory capacity		384 GiB to 768 GiB
Storage interface	DKC-drive interface		<ul style="list-style-type: none"> ▪ NVMe/Dual Port ▪ SAS/Dual Port
	Data transfer rate		Up to 32 Gbps
Device interface	Supported channel types		<ul style="list-style-type: none"> ▪ Fibre Channel (shortwave, longwave) ▪ iSCSI (optical)
	Data transfer rate	Fibre Channel	Up to 32 Gbps
		iSCSI (Optical)	10 Gbps
	Maximum number of front-end modules		<ul style="list-style-type: none"> ▪ 6 (NVMe only) ▪ 4 (with SAS expansion)

Table 4 VSP E590H specifications

Item			Specification
System	Number of drives	Minimum	4
		Maximum	2.5-inch SAS: 240 3.5-inch SAS: 480 2.5-inch NVMe: 24
	RAID group configuration	RAID 6	<ul style="list-style-type: none"> ▪ 6D+2P ▪ 12D+2P ▪ 14D+2P
		RAID 5	<ul style="list-style-type: none"> ▪ 3D+1P ▪ 4D+1P ▪ 6D+1P ▪ 7D+1P

Item		Specification	
	RAID 1	<ul style="list-style-type: none"> ▪ 2D+2D ▪ 4D+4D 	
	Maximum number of spare drives		46 (maximum of 2 internal NVMe)
	Maximum number of volumes		32,768
	Maximum storage system capacity (physical capacity)	30 TB 2.5-inch SSD and 14 TB 3.5-inch HDD used	8.9 PB
	Maximum external configuration		128 PiB (144 PB)
Memory	Cache memory capacity		384 GiB to 768 GiB
Storage interface	DKC-drive interface		NVMe/Dual Port SAS/Dual Port
	Data transfer rate		<ul style="list-style-type: none"> ▪ 8 Gbps (NVMe) ▪ Max 12Gbps (SAS)
Device interface	Supported channel types		<ul style="list-style-type: none"> ▪ Fibre Channel (shortwave, longwave) ▪ iSCSI (optical)
	Data transfer rate	Fibre Channel	Up to 32 Gbps
		iSCSI (Optical)	10 Gbps
	Maximum number of front-end modules		<ul style="list-style-type: none"> ▪ 6 (NVMe only) ▪ 4 (with SAS expansion)

Chapter 2: Hardware overview

The storage system consists of a controller chassis and one or more drive chassis mounted in a 19-inch rack.

Controller chassis

The controller chassis contains the following components:

- Controller boards (CTLs)
- Front-end modules (FEMs), also called channel boards (CHBs)
- Power supply (PS)
- Backup fan module (BKMF)

The CTLs contain the cache memory (CM) and cache flash memory (CFM) for the storage system. The VSP E590 and VSP E790 supports 768 GiB of cache memory.



Number	Item	Description
1	LED (POWER, READY, WARNING, ALARM)	Status LEDs for the controller chassis.
2	POWER ON/OFF (main switch)	Switch that controls power to the storage system.
3	Lock	Use to lock and unlock front bezel.

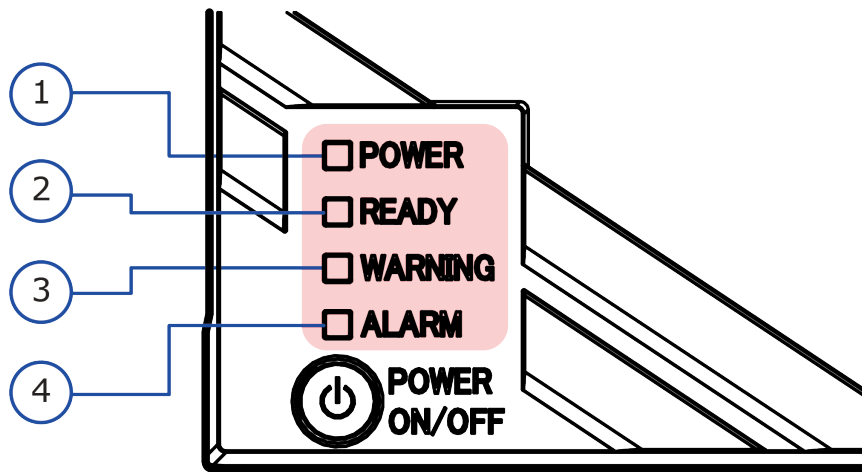

Number	Item	Description
1	POWER LED	Green: Storage system is powered on. Amber: Storage system is receiving power.
2	READY LED	Green: Normal operation.
3	WARNING LED	Off: Normal operation. Amber: Component requires maintenance. Blink: Failure requires maintenance. Note: When system option mode (SOM) 1097 is set to ON, the WARNING LED does not blink, even if the following failure service information messages (SIMs) are issued: 452xxx, 462xxx, 3077xx, 4100xx, and 410100. LED might turn off during user maintenance.
4	ALARM LED	Off: Normal operation. Red: Processor failure (system might be down). For assistance, contact customer support: https://support.hitachivantara.com/en_us/contact-us.html .

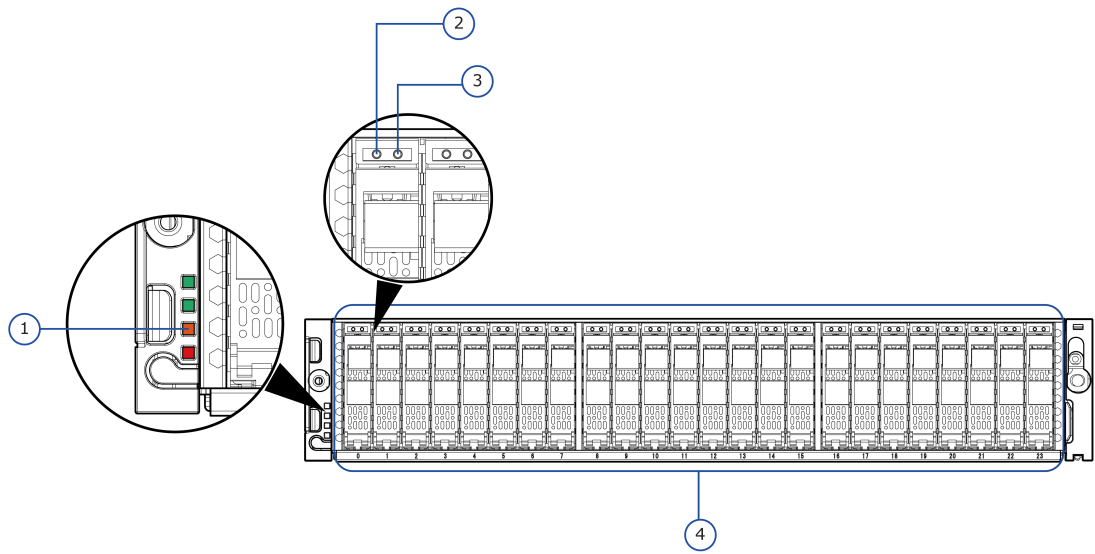

Number	Item	Description
1	LED (POWER, READY, WARNING, ALARM)	Status LEDs for the controller chassis.
2	ALM LED	Red: Drives can be replaced.
3	ACT LED	Green: Normal operation. Green Blinking: The drive is being accessed.
4	Drives	Disk drives

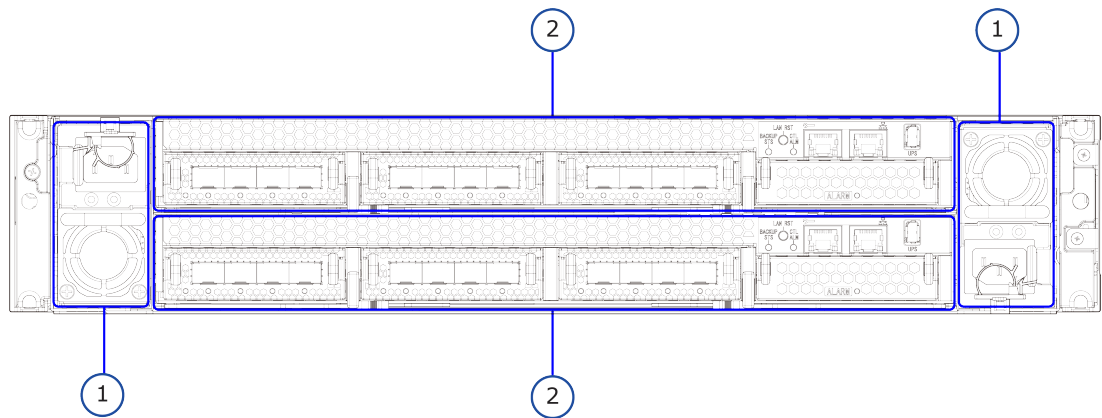

Number	Item	Description
1	Power supply unit	Supplies electric power to the controller components.

Number	Item	Description
2	Controllers	Controller 1 (bottom) and Controller 2 (Top)

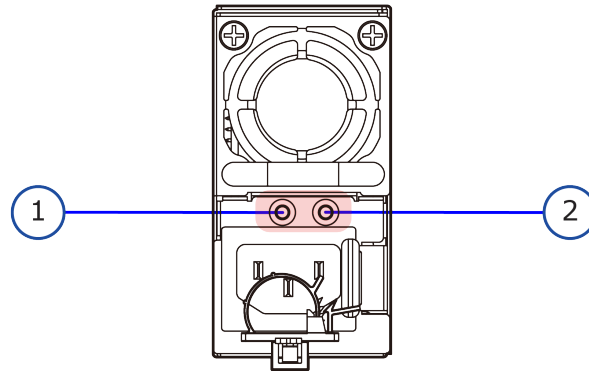

Number	Item	Description
1	RDY LED	On: Normal Operation
2	MAINT LED	On: Power supply unit can be replaced.

Controller board

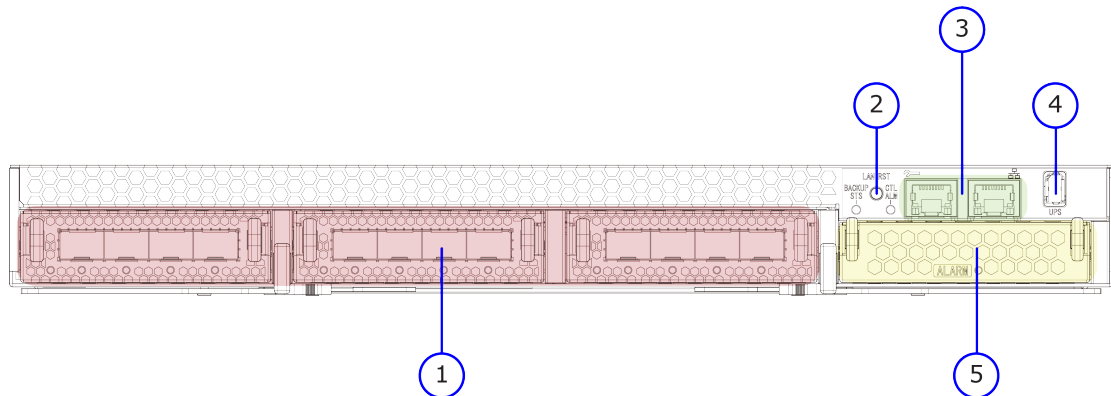

Number	Item	Description
1	Channel board	Channel board component
2	LAN-RST switch	Resets GUM. Use only when instructed by Hitachi Vantara support.
3	LAN port	LAN1: Maintenance LAN port (left) LAN2: User LAN port (right)

Number	Item	Description
4	Uninterruptible power supply port	NA
5	Cache flash memory	NA

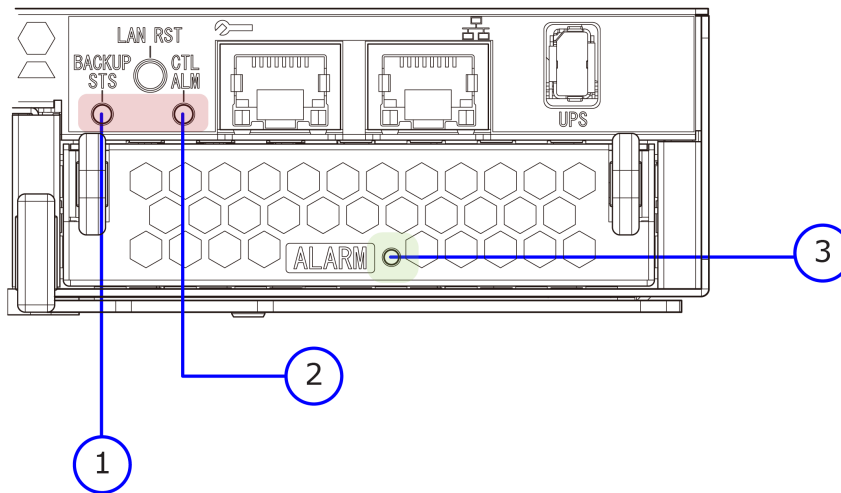

Number	Item	Description
1	BACKUP STS LED	<ul style="list-style-type: none"> ▪ Green: Restoration in progress following power outage. <ul style="list-style-type: none"> • Fast Blink: Restoring. • Slow Blink: Restoring or sequential shutdown in progress.
2	CTL ALM LED	<ul style="list-style-type: none"> ▪ Red: Controller can be removed. <ul style="list-style-type: none"> • Failure with the controller's power supply unit. ▪ Amber: LAN reset switch was pressed.
3	ALARM LED (for CFM)	Red: Cache flash memory can be removed.

Front-end modules

The front-end modules (FEMs), also called channel boards (CHBs), control the transfer of data between the host and cache memory. The storage system supports Fibre Channel (FC) and iSCSI front-end modules (FEMs) for attachment to host servers. The front-end module LEDs indicate the operating status of the module.

Specification		Fibre 32-Gbps Ready	iSCSI 10G	iSCSI 10G BASE-T
Model number		DW-F900-4HF32R	DW-F900-2HS10S	DW-F900-2HS10B
Number of PCBs		1	1	1
Host interface		FCP	iSCSI (optical)	iSCSI (copper)
Data transfer rate (MB/s)		16Gbps: 400/800/1,600 32Gbps: 800/1,600/3,200	1,000	100/1,000
Number of options installed(): DKB slot used		2/4/6/	2/4/6	2/4/6
Number of ports per PCB		4	2	2
Number of ports per storage system(): DKB slot used		8/16/24/	4/8/12	4/8/12
Maximum cable length	Short wave ¹	400m/190m/125m/ 100m	550m	-
	Long wave	10km	-	-
	Copper	-	-	50m (cat 6a)
<p>1. When 50/125mm laser optimized multi-mode Fibre cable (OM3 or OM4) is used. When using other cable types, contact customer support.</p>				

10-Gbps iSCSI board LEDs and connectors (optical)

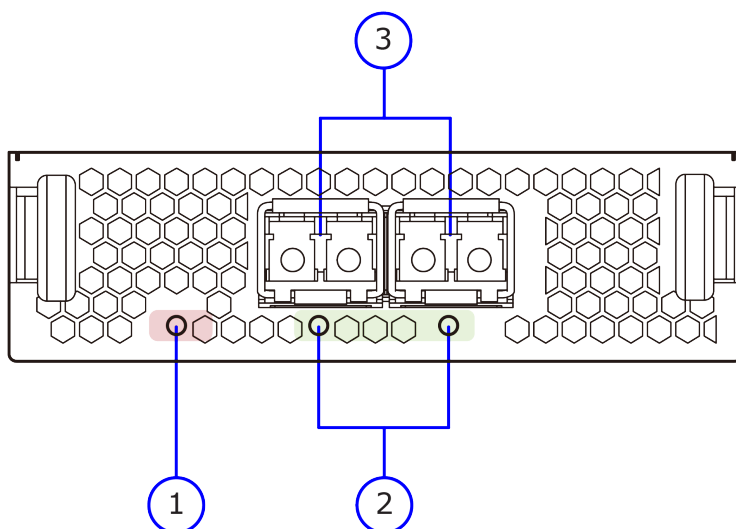

Number	Item	Description
1	STATUS LED	Green: Front-end module is in the power-on state. Red: Front-end module can be removed safely.
2	PORT LED	Red: Small form-factor (SFF) pluggable can be removed. Blue: Normal link status. Blink blue: Front-end module is in communication status.
3	iSCSI connectors	Connect to Ethernet cables.

Table 5 Port assignments

CHB number	Port 1	Port 2
CHB-1A	1A	3A
CHB-1B	1B	3B
CHB-1C	1C	3C
CHB-2A	2A	4A
CHB-2B	2B	4B
CHB-2C	2C	4C

10-Gbps iSCSI board LEDs and connectors (copper)

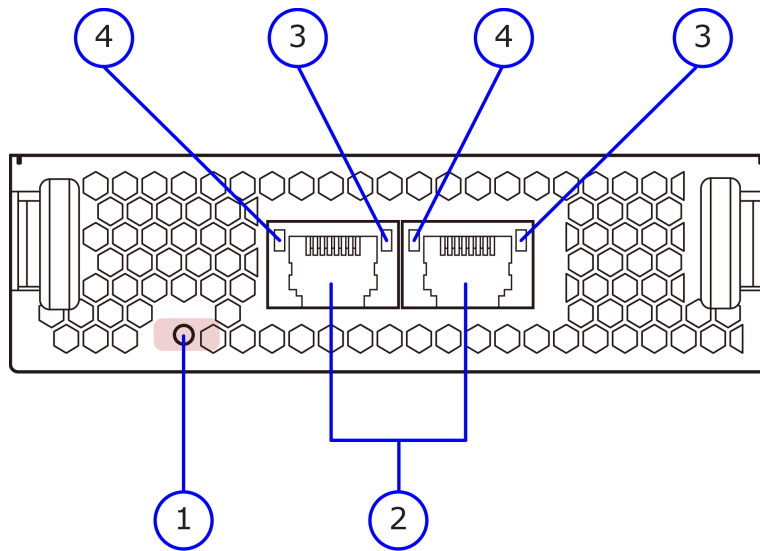

Number	Item	Description
1	STATUS LED	Green: Front-end module is in the power-on state. Red: Front-end module can be removed safely.
2	iSCSI connectors	Connect to Ethernet cables.
3	PORT (Link/Speed) LED	Yellow: 1-Gbps link. Green: 10-Gbps link. Off: No link connection.
4	PORT (Act) LED	Green: Link connection is established. Blinking: Communication is in progress. Off: No link connection or not ready to communicate.

Table 6 Port assignments

CHB number	Port 1	Port 2
CHB-1A	1A	3A
CHB-1B	1B	3B
CHB-1C	1C	3C
CHB-2A	2A	4A
CHB-2B	2B	4B

CHB number	Port 1	Port 2
CHB-2C	2C	4C

16-Gbps or 32-Gbps Fibre Channel (4-port) board LEDs and connectors

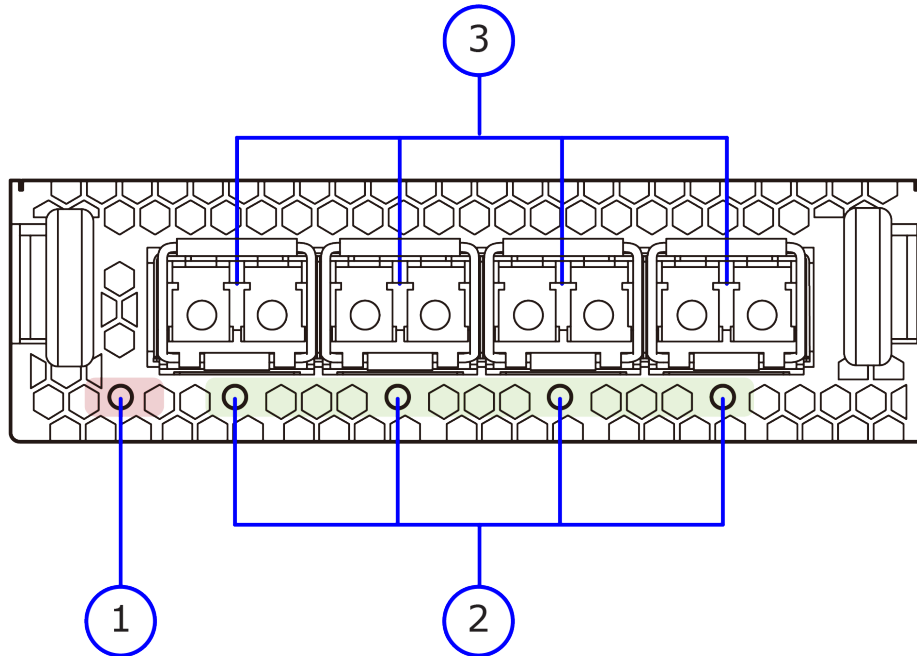

Number	Item	Description
1	STATUS LED	Green: Front-end module is in power-on state. Red: Front-end module can be removed safely.
2	PORT LED	Red: Small form-factor (SFF) pluggable can be removed. Blue: Normal link status at 16-Gbps (16-Gbps). Blue: Normal link status at 32-Gbps (32-Gbps). Green: Normal link status at 4-Gbps or 8-Gbps (16-Gbps). Green: Normal link status at 8-Gbps or 16-Gbps (32-Gbps).

Number	Item	Description
3	Fibre Channel connectors	Connect to Fibre Channel cables.

Table 7 Port assignments

CHB number	8-Gbps, 16-Gbps, or 32-Gbps Fibre Channel ports (left to right)			
	Port 1	Port 2	Port 3	Port 4
CHB-1A	1A	3A	5A	7A
CHB-1B	1B	3B	5B	7B
CHB-1C	1C	3C	5C	7C
CHB-2A	2A	4A	6A	8A
CHB-2B	2B	4B	6B	8B
CHB-2C	2C	4C	6C	8C

LAN blade LEDs and connectors

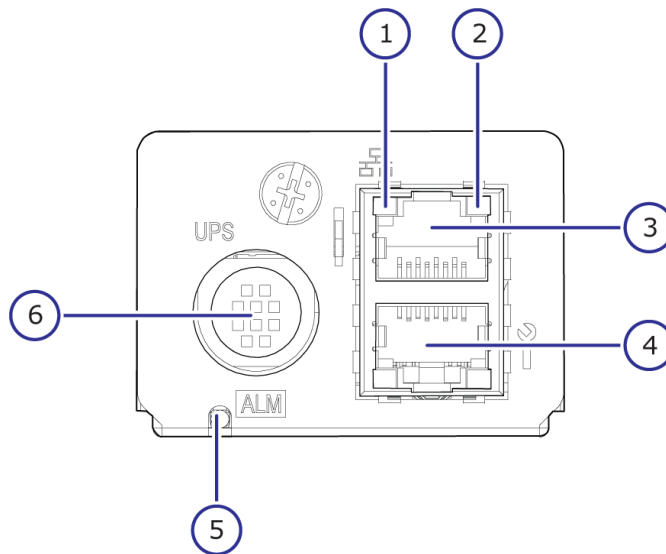

Number	Item	Description
1	LINK LED	Green: Link status is normal.
2	ACT LED	Orange: Data is being transferred.

Number	Item	Description
3	LAN 2	LAN port used by the user.
4	LAN 1	Maintenance LAN port used by service personnel.
5	LAN ALARM LED	Red: LAN blade can be removed.
6	Uninterruptible power supply (UPS) port	N/A

Small form-factor drive tray (DBSE)

The following describes the physical specifications of the small form-factor drive tray.

Name	Model name	Height	Number of drive slots	Drive type
DBSE	DW-F1000-DBSE	2U (88.2 mm)	24	2.5 inch (SFF)

SFF with front panel bezel

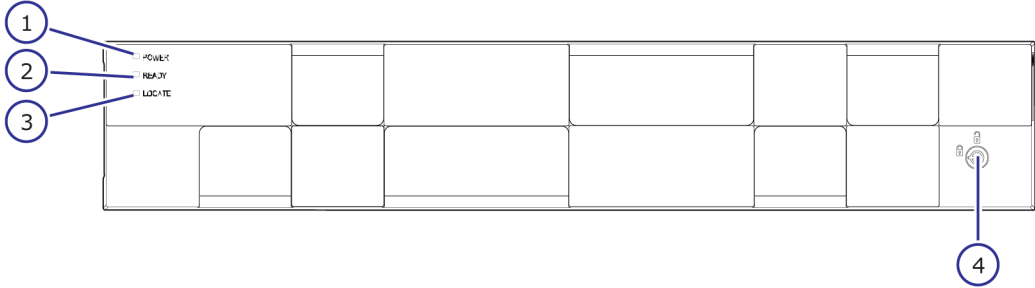

Number	Item	Description
1	POWER LED	Green: Drive tray is powered on.
2	READY LED	Green: Drive tray is operational.

Number	Item	Description
3	Locate LED	Amber: <ul style="list-style-type: none"> Indicates the location of the chassis. Can be turned on or turned off by the maintenance utility.
4	Lock	Locks and unlocks the front panel bezel by using the supplied key.

SFF front panel without bezel

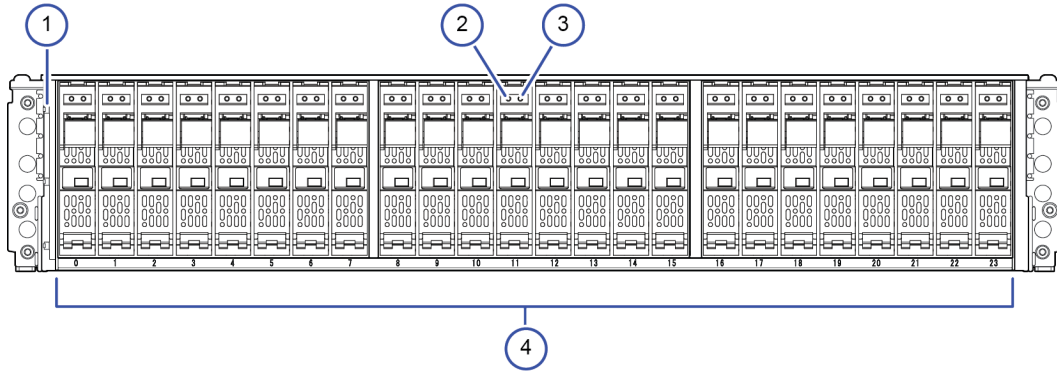

Number	Item	Description
1	POWER, READY, and LOCATE LEDs	Green: Drive tray is powered on.
		Green: Drive tray is operational.
		Amber: <ul style="list-style-type: none"> Indicates the location of the chassis. Can be turned on or turned off by the maintenance utility.
2	ALM LED	Red: Drive stopped due to a failure and can be replaced.
3	ACT LED	Green: Normal operation.

Number	Item	Description
		Blink green: Drive is being accessed.
4	Small form-factor drives	The twenty-four 2.5-inch small form factor drives are positioned vertically. The slots are organized from 0 to 23.

SFF rear panel

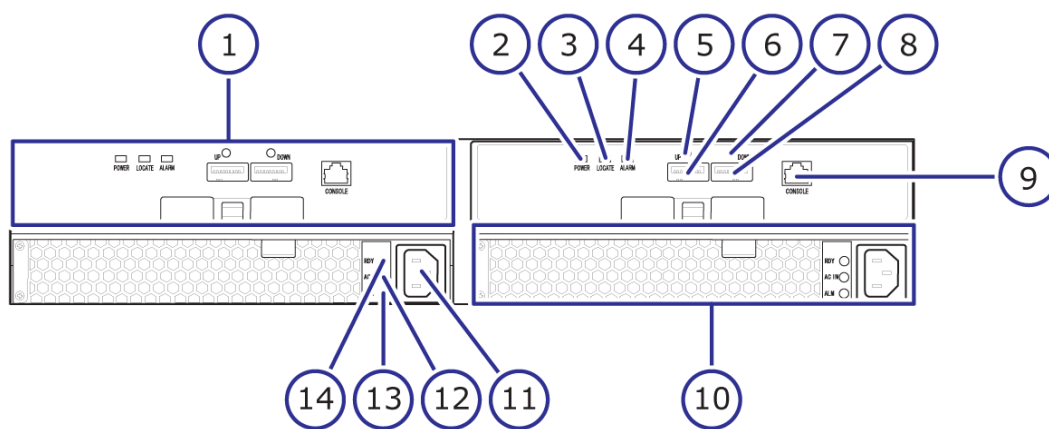

Number	Item	Description
1	ENC	N/A
2	POWER LED	Green: ENC is in the power-on state.
3	Locate LED	Amber: <ul style="list-style-type: none"> Indicates the location of the chassis. Can be turned on or turned off by the maintenance utility.
4	ALARM LED	Red: ENC can be replaced.
5	PATH (IN) LED	Blue: IN side port is linked up.
6	PATH (IN) connector	Connects to a controller or drive tray.

Number	Item	Description
7	PATH (OUT) LED	Blue: OUT side port is linked up.
8	PATH (OUT) connector	Connects to a drive tray.
9	Console	This port is reserved.
10	Power supply unit	N/A
11	Receptacle	Connects to the power cable provided with the storage system.
12	AC IN LED	Green: Normal operation.
13	ALM LED	Red: Power supply unit can be replaced.
14	RDY LED	Green: Normal operation.

AC power supply unit LEDs and connectors

Both SFF and LFF drive trays are equipped with AC power supply units. The AC power supply units include LEDs to display its operating status.



Note: The DBSE and DBLE power supply has a Platinum efficiency rating.

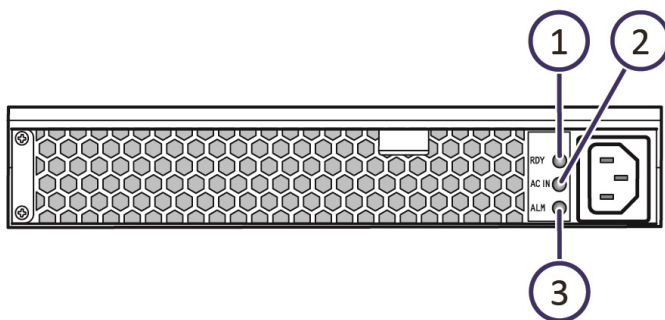

Number	Item	Description
1	RDY LED	Green: Normal operation.
2	ACI IN LED	Green: AC input is operating normally.
3	ALM LED	Red: Power supply unit can be replaced.

Small form-factor drive tray (DBS2)

The following describes the physical specifications of the small form-factor drive tray.

Name	Model name	Height	Number of drive slots	Drive type
DBS2	DW-F1000-DBS2	2U (88.2 mm)	24	2.5 inch (SFF)

SFF with front panel bezel

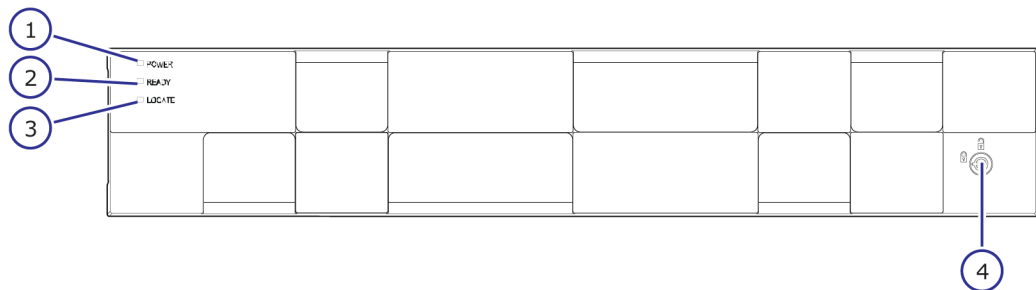

Number	Item	Description
1	POWER LED	Green: Drive tray is powered on.
2	READY LED	Green: Drive tray is operational.
3	Locate LED	Amber: <ul style="list-style-type: none"> Indicates the location of the chassis. Can be turned on or turned off by the maintenance utility.
4	Lock	Locks and unlocks the front panel bezel by using the supplied key.

SFF front panel without bezel

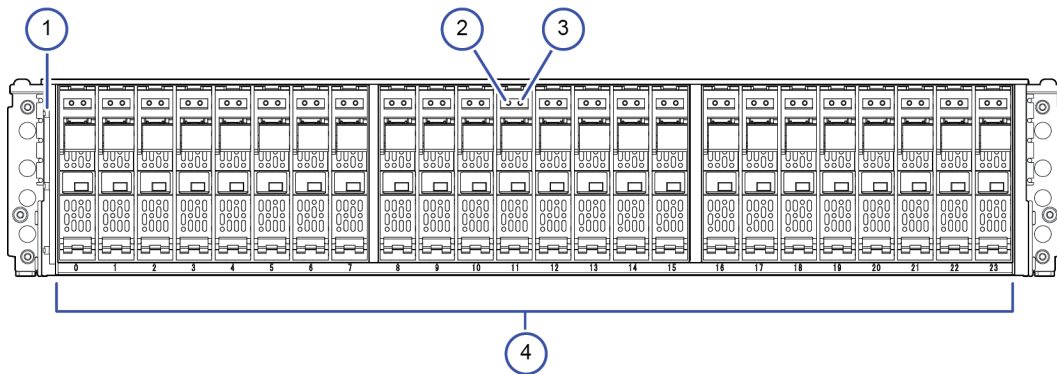

Number	Item	Description
1	POWER, READY, and LOCATE LEDs	Green: Drive tray is powered on.
		Green: Drive tray is operational.
		Amber: <ul style="list-style-type: none"> Indicates the location of the chassis. Can be turned on or turned off by the maintenance utility.
2	ALM LED	Red: Drive stopped due to a failure and can be replaced.
3	ACT LED	Green: Normal operation. Blink green: Drive is being accessed.
4	Small form-factor drives	The twenty-four 2.5-inch small form factor drives are positioned vertically. The slots are organized from 0 to 23.

SFF rear panel

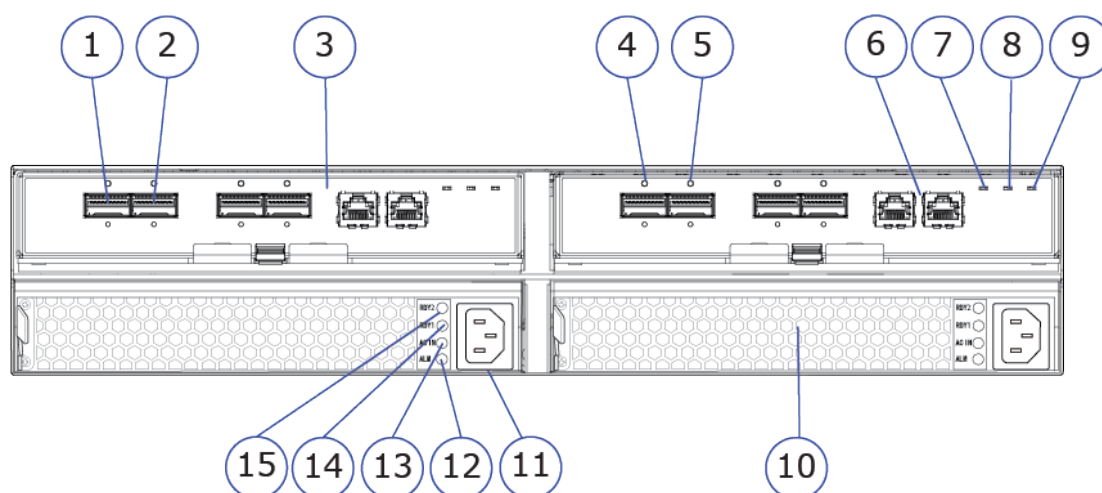

Number	Item	Description
1	PATH (IN) connector	Connects to a controller or drive tray.
2	PATH (OUT) connector	Connects to a drive tray.
3	ENC	N/A
4	PATH (IN) LED	Blue: IN side port is linked up.
5	PATH (OUT) LED	Blue: OUT side port is linked up.
6	Console	These ports are reserved.
7	POWER LED	Green: ENC is in the power-on state.
8	LOCATE LED	Amber: <ul style="list-style-type: none"> Indicates the location of the chassis. Can be turned on or turned off by the maintenance utility.
9	ALARM LED	Red: ENC can be replaced.
10	Power supply unit	N/A
11	Receptacle	Connects to the power cable provided with the storage system.

Number	Item	Description
12	ALM LED	Red: Power supply unit can be replaced.
13	AC IN LED	Green: Normal operation.
14	RDY1 LED	Green: Normal operation.
15	RDY2 LED	Green: Normal operation.

AC power supply unit LEDs and connectors

SFF drive trays are equipped with AC power supply units. The AC power supply units include LEDs to display its operating status.

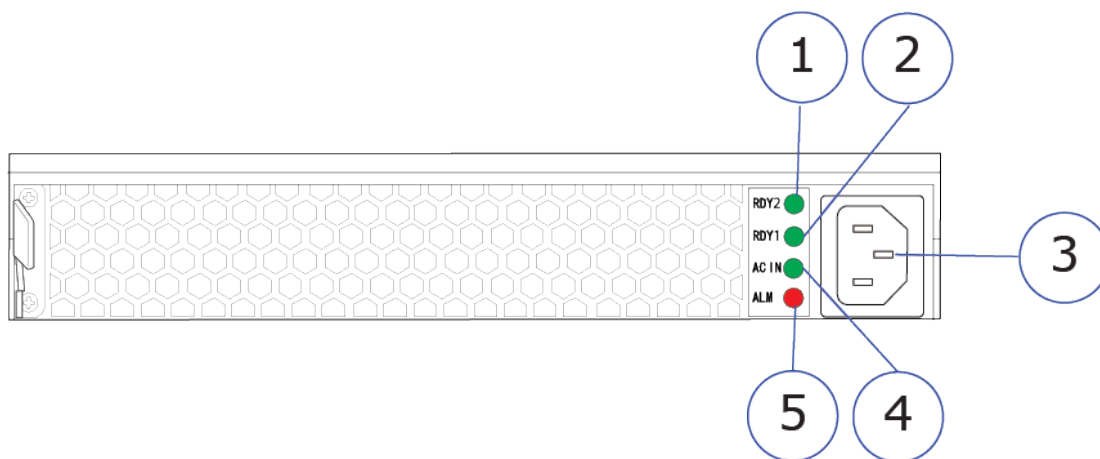

Number	Item	Description
1	RDY2 LED	Green: Normal operation.
2	RDY1 LED	Green: Normal operation.
3	Receptacle	Connects to the power cable provided with the storage system.
4	AC IN LED	Green: Normal operation.
5	ALM LED	Red: Power supply unit can be replaced.

Large form-factor drive tray (DBLE)

The following describes the physical specifications of the large form-factor drive tray.

Name	Model name	Height	Number of drive slots	Drive type
DBLE	DW-F1000-DBLE	2U (88.2 mm)	12	3.5 inch (LFF)

LFF with front panel bezel

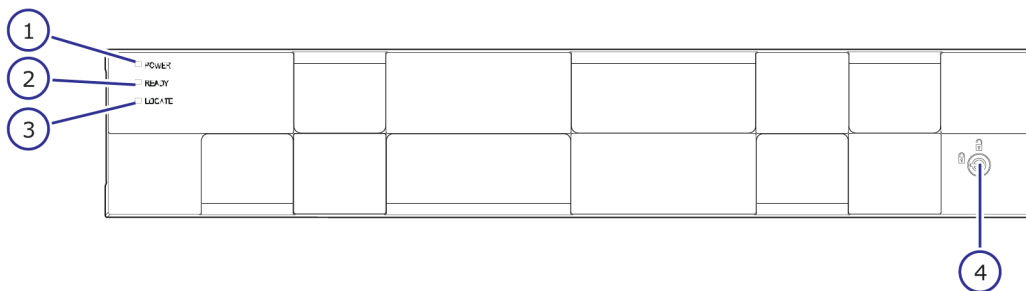

Number	Item	Description
1	POWER LED	Green: Drive tray is powered on.
2	READY LED	Green: Drive tray is operational.
3	Locate LED	Amber: <ul style="list-style-type: none"> Indicates the location of the chassis. Can be turned on or turned off by the maintenance utility.
4	Lock	Locks and unlocks the front panel bezel by using the supplied key.

LFF front panel without bezel

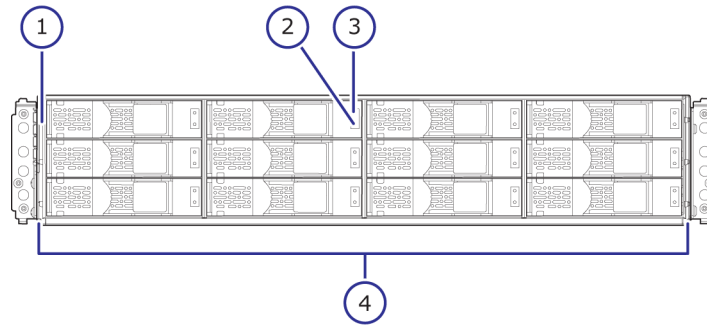

Number	Item	Description												
1	POWER, READY, and LOCATE LEDs	Green: Drive tray is powered on.												
		Green: Drive tray is operational.												
		Amber: <ul style="list-style-type: none"> Indicates the location of the chassis. Can be turned on or turned off by the maintenance utility. 												
2	ACT LED	Green: Normal operation. Blink green: Drive is being accessed.												
3	ALM LED	Red: Drive stopped due to a failure and can be replaced.												
4	Large form-factor drives	The twelve 3.5-inch large form factor drives are positioned horizontally. The slots are organized in the following order: <div style="background-color: #e0e0e0; padding: 5px; margin-top: 10px;"> <table style="width: 100%; border-collapse: collapse;"> <tr> <td style="padding: 2px 10px;">8</td> <td style="padding: 2px 10px;">9</td> <td style="padding: 2px 10px;">10</td> <td style="padding: 2px 10px;">11</td> </tr> <tr> <td style="padding: 2px 10px;">4</td> <td style="padding: 2px 10px;">5</td> <td style="padding: 2px 10px;">6</td> <td style="padding: 2px 10px;">7</td> </tr> <tr> <td style="padding: 2px 10px;">0</td> <td style="padding: 2px 10px;">1</td> <td style="padding: 2px 10px;">2</td> <td style="padding: 2px 10px;">3</td> </tr> </table> </div>	8	9	10	11	4	5	6	7	0	1	2	3
8	9	10	11											
4	5	6	7											
0	1	2	3											

LFF rear panel

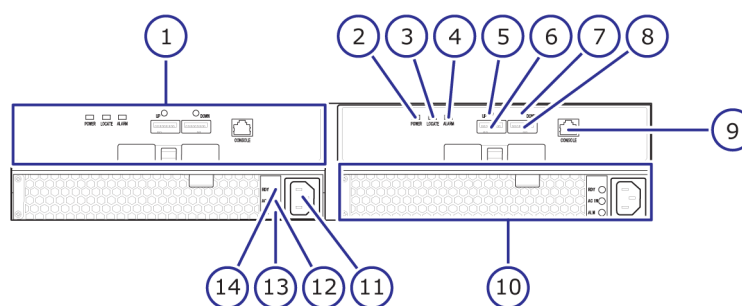

Number	Item	Description
1	ENC	N/A
2	POWER LED	Green: ENC is in the power-on state.
3	Locate LED	Amber: <ul style="list-style-type: none"> Indicates the location of the chassis. Can be turned on or turned off by the maintenance utility.
4	ALARM LED	Red: ENC can be replaced.
5	PATH (IN) LED	Blue: IN side port is linked up.
6	PATH (IN) connector	Connects to a controller or drive tray.
7	PATH (OUT) LED	Blue: OUT side port is linked up.
8	PATH (OUT) connector	Connects to a drive tray.
9	Console	This port is reserved.
10	Power supply unit	N/A
11	Receptacle	Connects to the power cable provided with the storage system.
12	AC IN LED	Green: Normal operation.
13	ALM LED	Red: Power supply unit can be replaced.
14	RDY LED	Green: Normal operation.

AC power supply unit LEDs and connectors

Both SFF and LFF drive trays are equipped with AC power supply units. The AC power supply units include LEDs to display its operating status.



Note: The DBSE and DBLE power supply has a Platinum efficiency rating.

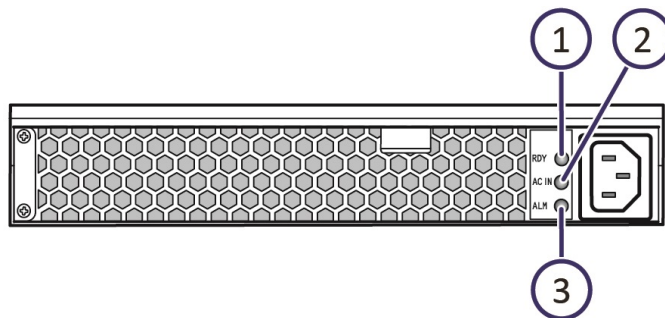

Number	Item	Description
1	RDY LED	Green: Normal operation.
2	ACI IN LED	Green: AC input is operating normally.
3	ALM LED	Red: Power supply unit can be replaced.

High-density intermix drive tray (DB60)

The following describes the physical specifications of the high-density drive tray.

Name	Model name	Height	Number of drive slots	Drive type
DB60	DW-F1000-DB60	4U (176 mm)	60	3.5 inch (LFF)

Dense intermix drive tray with front panel bezel

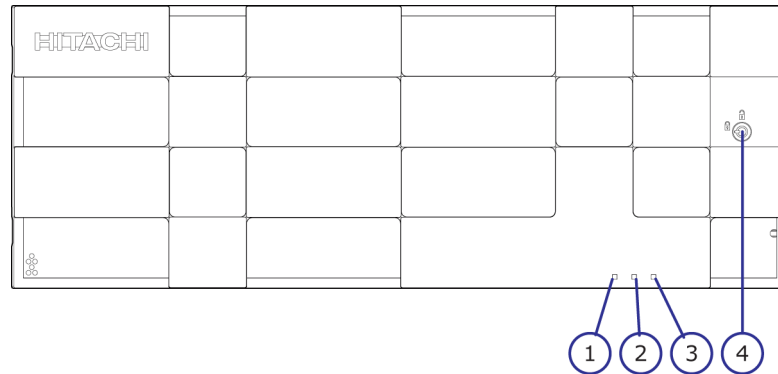

Number	Item	Description
1	POWER LED	Green: Drive tray is powered on.
2	READY LED	Green: Drive tray is operational.
3	Locate LED	Amber: <ul style="list-style-type: none"> Indicates the location of the chassis. Can be turned on or turned off by the maintenance utility.
4	Lock	Locks and unlocks the front panel bezel by using the supplied key.

Dense intermix drive tray display LEDs

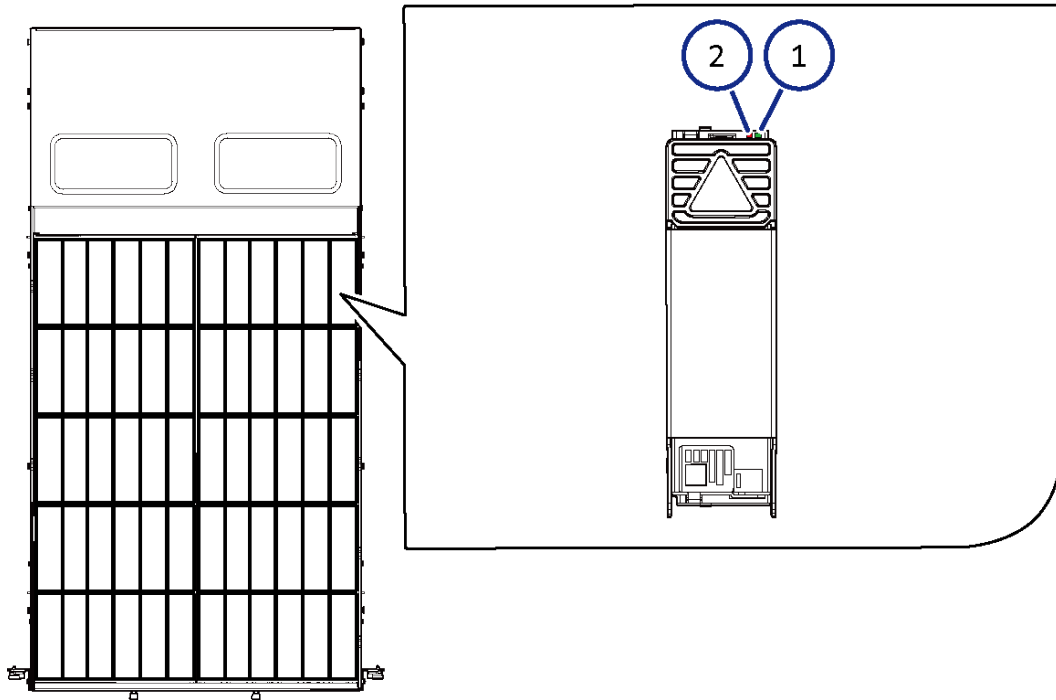

Number	Item	Description
1	ACT	Green: Normal operation. Blink: Drive is being accessed.
2	ALM LED	Red: Drive stopped due to a failure and can be replaced.



Note: At the rear of the drive tray, the drives are organized from left to right. On the left side of the preceding figure, the rear of the drive tray is at the top.

- Rear of drive tray: 48-59
- 36-47
- 24-35
- 12-23
- Front of drive tray: 00-11

Dense intermix drive tray rear panel

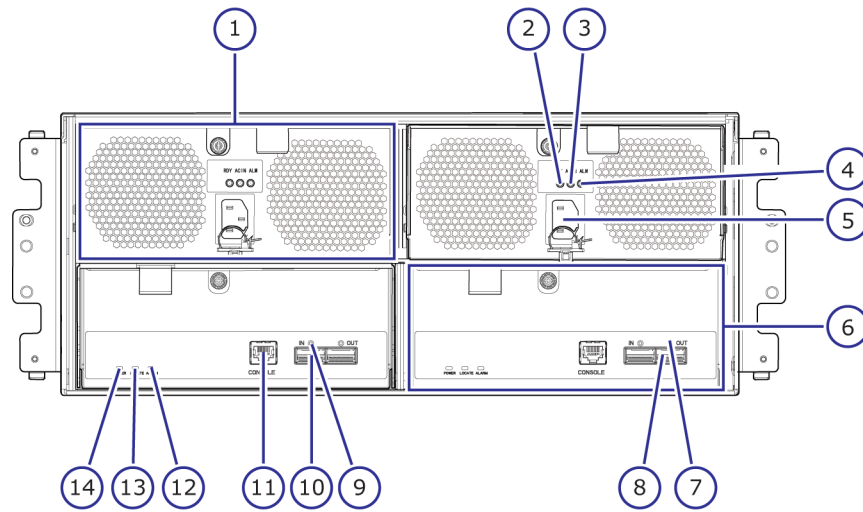

Number	Item	Description
1	Power supply unit	N/A
2	RDY LED	Green: Normal operation.
3	AC IN LED	Green: Normal operation.
4	ALM LED	Red: Power supply unit can be replaced.
5	Receptacle	Connects to the power cable provided with the storage system.
6	ENC	N/A
7	PATH (OUT) LED	Blue: OUT side port is linked up.
8	PATH (OUT) connector	Connects to a drive tray.
9	PATH (IN) LED	Blue: IN side port is linked up.
10	PATH (IN) connector	Connects to a controller or drive tray.
11	Console	This port is reserved.
12	ALARM LED	Red: ENC can be replaced.

Number	Item	Description
13	Locate LED	Amber: <ul style="list-style-type: none"> ▪ Indicates the location of the chassis. ▪ Can be turned on or turned off by the maintenance utility.
14	POWER LED	Green: ENC is in the power-on state.

Rack support

The storage system can be installed in the Hitachi Universal V3 Rack, Universal V2B Rack, or Universal V2 Rack as well as non-Hitachi 19-inch racks that meet the storage system's specifications.

Non-Hitachi racks must be 4-post, EIA 310-D compliant with adequate airflow and weight capacity. The PDUs must be mounted properly to avoid any issues for servicing the storage system. The PDU receptacles must face toward the back (not toward each other). The area behind the storage system and between the vertical 19-inch mounting posts must be free of PDUs and cable loops.

Chapter 3: Specifications

The Hitachi Virtual Storage Platform E590 (VSP E590) and Hitachi Virtual Storage Platform E790 (VSP E790) storage systems are designed to operate in a controlled environment such as a data center. The following tables provide the environmental, electrical, and physical requirements and specifications for the VSP E590 and VSP E790.

Environmental specifications

The following tables provide the environmental specifications, including operating and non-operating values, for the VSP E590 and VSP E790 storage systems.

Table 8 Temperature

State	Specification
Operating	10°C to 35°C (50°F to 95°F)
Non-operating	-10°C to 50°C (14°F to 122°F)
Transport, storage	-30°C to 60°C (-22°F to 140°F)
Temperature change rate	10°C/hr (18°F/hr)

Table 9 Humidity

State	Specification
Operating	8% to 80%
Non-operating	8% to 90%
Transport, storage	8% to 90%
Maximum wet bulb temperature	29°C (84.2°F) (noncondensing)

Table 10 Vibration, shock, and impact

Type	State	Specifications
Vibration	Operating	0.98 m/s ² (0.1 G) or less [frequency component 5 Hz to 100 Hz]
	Non-operating	Same as operating specification
Impact	Operating	No impact
	Non-operating	78.4 m/s ² (8.0 G), 15 ms
Seismic wave	Operating	2.5 m/s ² (0.25 G) (approximately 250 Gal) or less
	Non-operating	3.9 m/s ² (0.4 G) or less: No critical damage for product function (normal operating with part replacement). 9.8 m/s ² (1.0 G) or less: Ensure own safety with fall prevention.

Table 11 Altitude (Temperature range)

State	Specification
Operating	3,050 m (10°C to 28°C) [10,006 ft. (50°F to 82.4°F)] 950 m (10°C to 35°C) [3,116 ft. (50°F to 95°F)]
Non-operating	-60 m to 12,000 m (-196 ft. to 39,370 ft.)

Table 12 Environment/atmosphere

Type	State	Specifications
Dust	Operating	0.15 µg/m ³ or less
	Non-operating	-
Gaseous contaminants	Operating	Within ANSI/ISA S71.04-2013 G1 classification levels.
	Non-operating	Keep data center clean by monitoring and controlling gaseous contamination.

Table 13 Noise level (recommended)

State	Specification
Operating	90 dB or lower*

State	Specification
Non-operating	90 dB or lower*
<p>* Fire suppression systems and acoustic noise: When activated, some inert-gas fire-suppression systems release pressurized gas at high velocity through multiple nozzles in the data center, generating high levels of acoustic noise. Pneumatic sirens can also generate high levels of acoustic noise. High levels of acoustic noise can cause vibrations to the media in the storage system, resulting in I/O errors, performance degradation in the media, and to some extent damage to the drives. Media noise-level tolerance varies among different models, designs, capacities, and manufacturers.</p> <p>The recommended acoustic noise level of 90 dB or less represents the current operating environment guidelines for which the storage systems are designed and manufactured for reliable operation when placed 2 meters or more from the source of the noise.</p> <div data-bbox="349 695 1393 888" style="background-color: #e0f2f1; padding: 10px;"> <p> Note: The storage systems and media are not tested for compatibility with fire-suppression systems or pneumatic sirens. In addition, Hitachi does not recommend or claim compatibility with any fire-suppression systems or pneumatic sirens. The customer is responsible for following applicable regulations.</p> </div> <p>To prevent I/O errors and damage to the storage system due to high levels of acoustic noise:</p> <ul style="list-style-type: none"> ▪ Install noise-reducing baffles to mitigate the noise to the media in the storage system. ▪ Consult the fire-suppression-system manufacturer about noise-reduction nozzles to protect the media in the storage system. ▪ Locate the storage system as far away as possible from noise sources. ▪ If it can be done safely and without risk of personal injury, shut down the storage system before the noise occurs to prevent data loss due to damage to the media in the storage system. <p>DAMAGE TO MEDIA FROM FIRE-SUPPRESSION SYSTEMS OR PNEUMATIC SIRENS VOIDS THE MEDIA WARRANTY.</p>	

Electrical specifications

The VSP E590 and VSP E790 run on single-phase AC power. The AC power input power for the storage systems is duplexed across the PDUs, enabling the equipment installed in the rack to remain powered on if power is removed from one of the two power distribution panels.

The following tables provide the electrical specifications for the VSP E590 and VSP E790 storage systems, including input power and input voltage and frequency requirements.

Table 14 Input power specifications

Item	Component	Specification
Rated power	Controller	1,960 V
Input power ¹	Controller	Single-phase AC 50 Hz/60 Hz 200 V to 240 V
Input current ^{1,2}	Controller	9.8 A
Steady current ³	Controller	4.9 A
Leakage current	Controller	1.75 mA
Inrush current	Controller	1st (0-p): 30 A 2nd (0-p): 20 A 1st (0-p) time: 25 ms
Power cord plug type	Controller	IEC60320 C14 
Notes:		
<ol style="list-style-type: none"> 1. When planning the air-conditioning equipment and power-supply system, use the multiplied value of [Input Power] × [Input Current]. 2. The maximum current of AC input is not a redundant configuration. 3. The maximum current of AC input is a redundant configuration. 		

Table 15 Input voltage and input frequency requirements

Frequency	Input Voltage (AC)	Conditions	Tolerance (%)
60 Hz ±2 Hz	200 V to 240 V	1 phase 2 wire + ground	+10% or -11%
50 Hz ±3 Hz	200 V to 240 V	1 phase 2 wire + ground	+10% or -11%

Physical specifications

The following table provides the physical specifications for the VSP E590 and VSP E790 storage systems, including weight, heat output, power consumption, and air flow specifications.

Table 16 Weight, heat output, power consumption, and air flow specifications

Model number	Weight (kg) ²	Heat output (W) ²	Power consumption (VA) ^{1,2}	Air flow (m ³ /min) ³
DW-F850-CBSFB2	1	-	-	-
DW900-CBSN	11.9	1064	1120	4.0
DW-F1000-DBSE	17	116	126	2.2
DW-F1000-DBS2	17	290	305	2.2
DW-F1000-DBLE	17.4	124	144	2.2
DW-F1000-DB60	36	184	191	5.1
DW-F900-BS12G/ BS12GE	0.5	16	17.8	-
DW-F900-CM32G	0.054	4	4.2	
DW-F900-BM70	0.2	9.7	10.2	-
DW-F900-BM7E	0.2	9.7	10.2	-
DW-F900-4HF32R	0.4	17.9	19.9	-
DW-F900-2HS10S	0.4	18.0	18.9	-
DW-F900-2HS10B	0.4	28.5	30.0	-
DKC-F810I-1PL16	0.02	0.79	0.88	-
DKC-F810I-1PS16	0.02	0.94	1.05	-
DKC-F810I-1PS32	0.02	1.29	1.43	-
DKC-F910I-1R9RVM	0.21	25.0	26.0	-
DKC-F910I-3R8RVM	0.21	25.0	26.0	-
DKC-F910I-7R6RVM	0.21	25.0	26.0	-
DKC-F910I-15RRVM	0.21	25.0	26.0	-
DKC-F910I-30RRVM	0.21	25.0	26.0	-
DKC-F810I-2R4JGM	0.3	13	14	-
DKC-F810I-6R0H9M	0.85	20	21	-

Model number	Weight (kg) ²	Heat output (W) ²	Power consumption (VA) ^{1,2}	Air flow (m ³ /min) ³
DKC-F810I-10RH9M	0.73	20	21	-
DKC-F810I-14RH9M	0.73	20	21	-
DKC-F810I-1T9MGM	0.23	13	14	-
DKC-F810I-3R8MGM	0.23	13	14	-
DKC-F810I-7R6MGM	0.23	13	14	-
DKC-F810I-15RMGM	0.23	13	14	-
DKC-F810I-30RMGM	0.23	13	14	-
DKC-F810I-2R4J8M	0.4	13	14	-
DKC-F810I-6R0HLM	0.96	20	21	-
DKC-F810I-10RHLM	0.84	20	21	-
DKC-F810I-14RHLM	0.73	20	21	-
<ol style="list-style-type: none"> 1. Actual values at a typical I/O condition. (Random Read and Write, 50 IOPSs for HDD, 2500 IOPSs for SSD, Data Length: 8k bytes. All fans rotate at normal.) These values may change for future compatible drives. 2. The value is from the configuration of Model List. 3. The value is MAX level. 				

Chapter 4: Turning storage system power on and off

The storage system can be powered on and off using the power control panel located on the controller chassis during normal operating conditions or in case of a power failure.

Powering on the storage system

Use the following procedure to power on the storage system. The main switch on the controller chassis is used to power on the storage system.

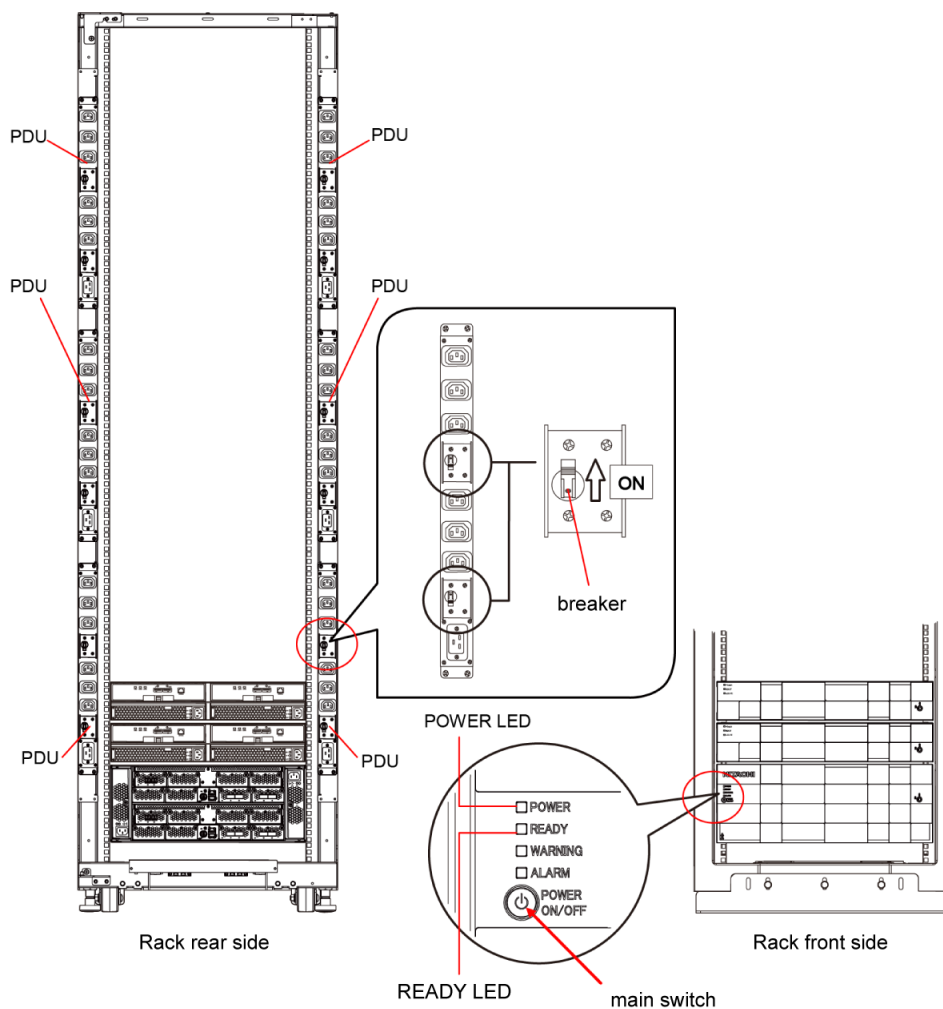

Procedure

1. Turn ON all the breakers to the storage system.
2. Press the main switch on the controller chassis for three seconds until the POWER LED changes from amber to green.



Note: The storage system will take approximately 13 minutes to finish powering on.

3. Wait for the storage system to complete its power-on self-test and bootup processes. When the READY indicator is ON (green LED), the storage system is ready for use.



Caution: If the ALARM indicator is also ON (red LED), or if the READY indicator is not ON after 40 minutes, contact customer support for assistance.

Powering off the storage system

Use the following procedure to power off the storage system. The main switch on the controller chassis is used to power off the storage system.

Before you begin

- Ensure that all software-specific shutdown procedures have been completed. Refer to the applicable user manuals for details.
- Ensure that all I/O activity to the storage system has stopped. You can vary paths offline and shut down the attached hosts.

Procedure

1. Press the main switch on the controller chassis for approximately three seconds until the POWER LED on the front of the chassis changes from solid green to a blinking status.
2. Release the main switch and the POWER LED returns to solid green after blinking for approximately three seconds.
The power-off process begins. The process takes approximately 18 minutes or longer depending on the amount of data that needs to be written. The POWER LED is solid green during the powering off process. The POWER LED changes from green to amber when the process is completed.
3. Verify the POWER LED on the front of the storage system changes from green to amber.
4. To stop the power supply, remove the power cables from the power supply units on the controller chassis and drive box.

If the storage system is connected to a PDU, you can stop the power supply by turning off the PDU breaker.



Note: If the storage system does not receive power for more than six months, the battery can become discharged and possibly damaged. To avoid this situation, charge the battery for more than three hours at least once every six months.

Chapter 5: Site preparation

The delivery and installation site for the storage system must meet certain requirements to ensure successful and efficient installation of the storage system.



Note: The following information is provided to assist in installation planning and is not intended to be complete. The installation and maintenance documents used by Hitachi Vantara personnel contain complete specifications. For further information about site preparation for storage system installation, contact customer support.

Site preparation checklist

Verify the availability of each item in the site preparation checklist.

The responsibilities for installation planning are shared by the customer and the Hitachi Vantara account team. The required installation planning tasks must be scheduled and completed to ensure successful and efficient installation of the storage system.

The following tasks might take several weeks to complete:

- Acquiring required power outlets.
- Adding or modifying air conditioning systems.
- Making room alterations to accommodate the storage system.
- Ordering third-party equipment, such as non-Hitachi racks, network switches, and host servers for the storage system.

The following checklist will assist you as you perform your installation. You can make copies of this checklist for each installation you perform and check each step after it has been performed.

Requirement	Yes	No
Is the data center free of any equipment servicing hazards, such as electrical or data cables that obstruct access?		
Does the data center have a suppression system?		
Does the floor plan meet the service clearance and cutout requirements?		
Does the floor meet the load rating requirements?		

Requirement	Yes	No
Does the data center meet the environmental requirements including temperature, humidity, airflow, and acoustic?		
Is all equipment not supplied by Hitachi (for example, connectors, receptacles, and network switches) on site and ready for use?		
Are the input circuit breakers adequate for equipment loads?		
Are uninterruptible power supplies (UPS) in place?		
Have all sources of electrical interference been addressed?		
Does the site enforce access controls (for example, will Hitachi representatives need an escort)?		
Will the equipment fit through all doors and corridors and in elevators?		

Site planning

All planning activities should be scheduled and completed before the equipment is delivered.

The planning process includes:

- Planning hardware configuration, such as system component layout in the rack and drive allocation.
- Planning for specific network topologies, cabling configurations, network switches, and cabling of connected host computers.
- Ensuring all cables for specific controller and drive tray configurations are properly ordered.
- Verifying all electrical service wiring is installed at the predetermined location.

Complete the suggested tasks before receiving and installing the storage system:

- Prepare a preliminary layout of the installation.
- Review the power and the heating, ventilation, and air-conditioning requirements before ordering any additional support equipment.
- Make a final layout of the installation and review the layout with the Hitachi Vantara representative.
- Verify the installation of electrical service wiring at the predetermined location is proper before installing the storage system.
- Verify all additional equipment, such as switches and host computers, is installed and operational.

Installation site considerations

When planning and preparing for the installation of a storage system, consider the following:

- The delivery area must provide enough space and floor strength to support the packaged equipment cartons for the storage system. Doorways and hallways must provide enough clearance to move the equipment safely from the delivery area to the destination.
- The computer room must have sufficient space to accommodate the storage system and other necessary equipment and provide minimum clearance around the storage system for service access and to verify proper weight distribution on the computer room floor. It must also include correctly positioned floor cutouts for the storage system's power and data cables.
- If the storage system arrives in hot or cold weather or you notice any condensation, do not unpack it until it has been allowed to reach room temperature or the condensation to clear (one to two hours). Immediately exposing the storage system to warm temperature can cause condensation to occur, which could damage the electronics. Maintain recommended humidity level and airflow rates.
- Take the necessary precautions to prevent electrostatic discharge (ESD). Verify that all equipment and flooring are grounded. Store spare electric parts in antistatic bags until you are ready to install them. When handling the storage system, wear protective devices like wrist straps, sole grounders, and conductive shoes.
- Proper environmental conditions for the storage system must be maintained. For optimal performance, storage systems require controlled environmental conditions that are often best facilitated through raised flooring and under-floor air conditioning. It is the responsibility of the customer to monitor this environment and ensure continued conformance with the recommended environmental specifications.
- The computer room must have adequate power facilities for the storage system. Adequate power is necessary to ensure reliable functioning of electronic equipment and for the safety of the customer's installation. The customer is responsible for procuring, installing, and maintaining adequate power to the equipment.

Floor cutout and service clearance

Be sure your site has sufficient space to accommodate the storage system.

When preparing the space required for your storage system, be sure the site:

- Is large enough to hold the new storage system and other equipment.
- Provides minimum clearance around the storage system for service access and to verify proper weight distribution on the computer room floor.
- Includes correctly positioned floor cutouts for the storage system's power and data cables.

To verify there is sufficient space for the storage system, document your site's floor plan, including the locations of:

- Structural support columns and other immovable objects
- Walls
- All existing equipment, cabinets, racks, networking equipment, and other systems
- Where the new storage system will be installed
- Floor and electrical cutouts
- Interconnecting cables and power cords, including lengths
- Floor vents

The space requirements must take into consideration the total floor clearance required for the storage system. This includes:

- The space required by the equipment
- Service clearance - the floor space required to access the storage system.
- Additional space required to distribute the equipment weight on your computer room's raised floor. The amount of additional space required depends on your floor load rating.
- Additional space required to view the storage system LEDs on the front and rear panels.

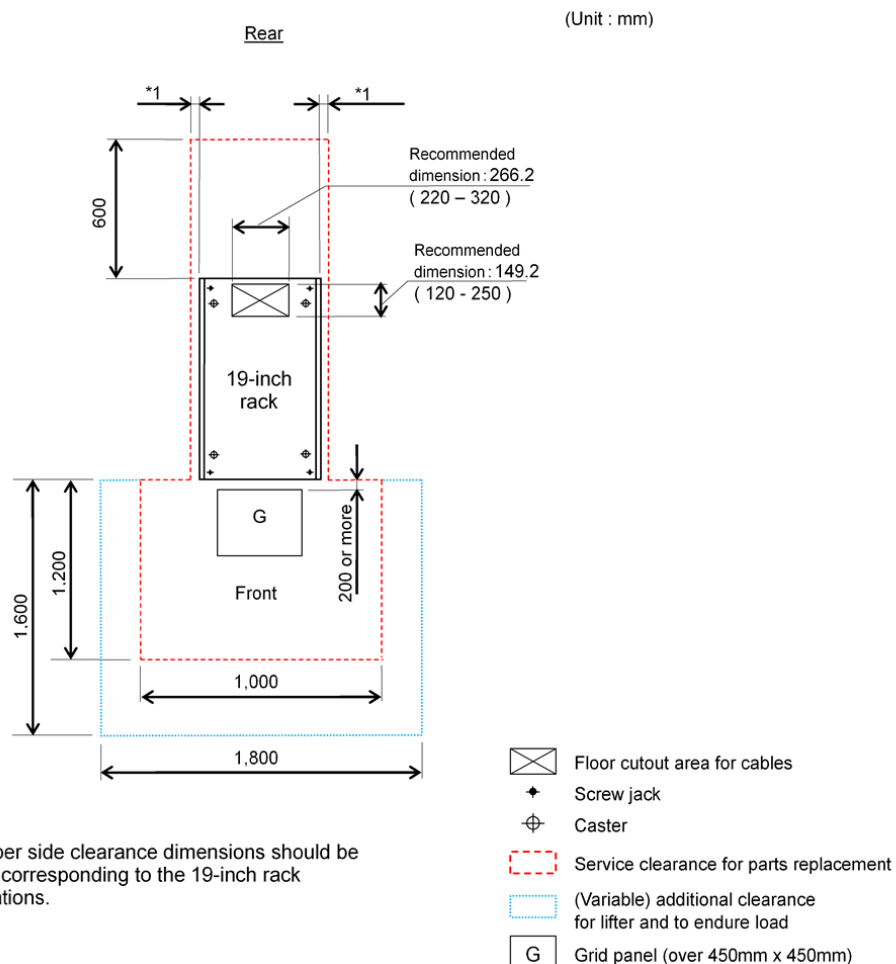

If your computer room uses floor cutouts to route power and data cables, position the cutouts toward the center of the rack. If this is not possible, position the cutouts off-center from the rack as long as the cutout is within the allowable range and allows smooth routing and entrance of cables. Check the relationship between the position of the cutout and the cable openings on the rack.

Floor load rating

The floor space at the installation site must support the combined weight of all associated component and equipment. The maximum load rating is 709 kg.

Installing anti-tilt bracket for Universal V3 Rack

The anti-tilt bracket for the Hitachi Universal V3 Rack must be anchored to a rigid floor capable of holding a minimum of 154 lbs (79 kg).

Before you begin

To install the anti-tilt bracket, you will need the following tools and components:

- T25 screwdriver
- Customer supplied M10 or 3/8" screw capable of holding a minimum 154 lbs (79 kg)

Procedure

1. Adjust the four retractable feet so the rack is level with the ground.

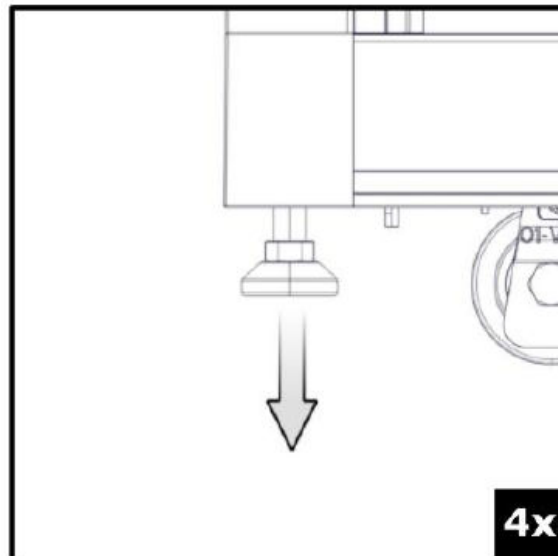

2. Attach two anti-tilt brackets to the feet on the back of the rack.

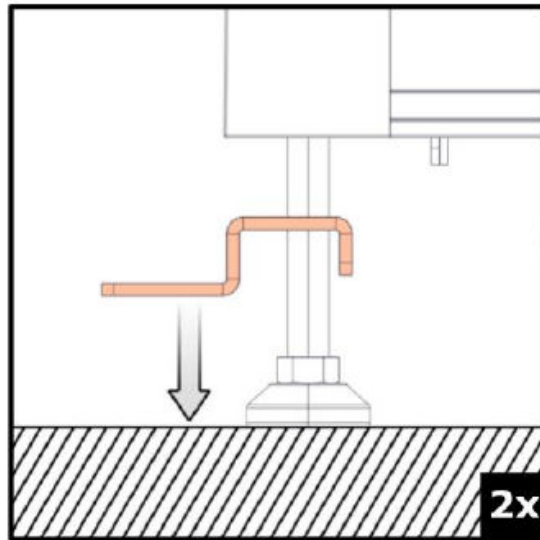
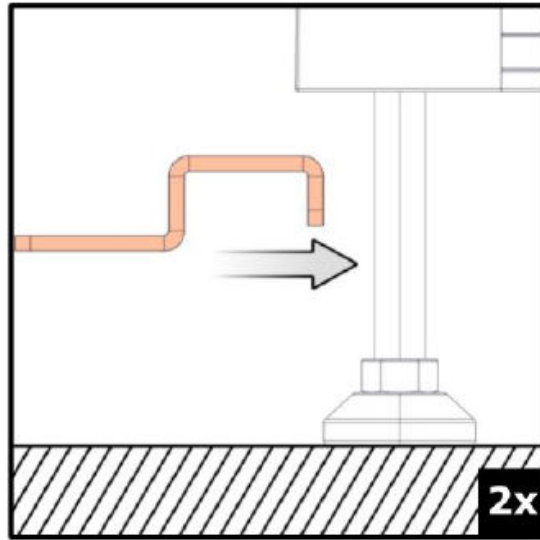

3. Using a minimum size of a M10 or 3/8" screw, fasten the bracket to the floor.

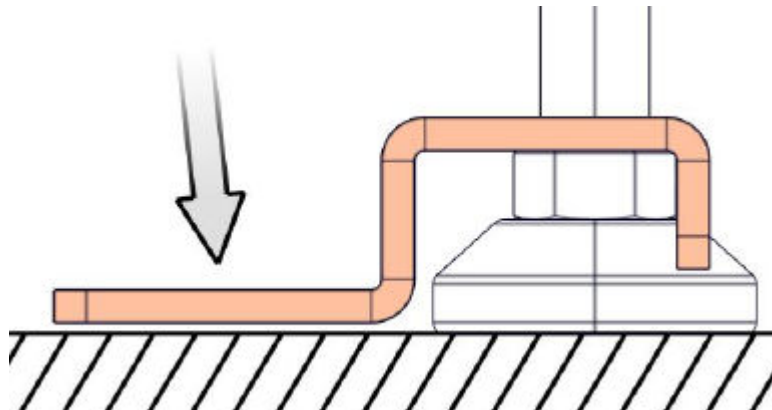

Appendix A: Component list

The following table lists and describes the components of the storage system. For more information, contact your Hitachi Vantara representative or customer support.

Component list

Table 17 CBSN controller components

Model number	Description	Quantity
DW900-CBSN	2U chassis	1
	Binder (two types)	4
DW-F900-EQRR1	Optional Earthquake Resistivity Bracket	1
DW-F850-CBSFB2	Front bezel (2U)	1
DKC-F910I-1R9RVM	1.9 TB, 12 Gbps, SFF, NVMe flash drive	0-24
DKC-F910I-3R8RVM	3.8 TB, 12 Gbps, SFF, NVMe flash drive	0-24
DKC-F910I-7R6RVM	7.6 TB, 12 Gbps, SFF, NVMe flash drive	0-24
DKC-F910I-15RRVM	15 TB, 12 Gbps, SFF, NVMe flash drive	0-24
DKC-F910I-30RRVM	30 TB, 12 Gbps, SFF, NVMe flash drive	0-24
DW-F900-CTLSN	Controller board	2
DW-F900-CTLSNE	Encrypting controller board	2
DW-F900-CTLMN	Controller board	2
DW-F900-CTLMNE	Encrypting controller board	2
DW-F900-CM32G	Cache memory (32 GB)	12-24
DW-F900-BM70	Cache flash memory non-encrypted (CFM)	2
DW-F900-BM7E	Cache flash memory with encryption (CFM)	2

Model number	Description	Quantity
DW-F900-2HS10S	Front-end module (also know as a channel board) (10-Gbps SFP optic-iSCSI)	2-6
DW-F900-2HS10B	Front-end module (10-Gbps copper-iSCSI)	2-6
DW-F900-4HF32R	Front-end module (32/16-Gbps 4port-FC)	2-6
DKC-F810I-1PS16	SFP for 16 Gbps Shortwave	0-24
DKC-F810I-1PL16	SFP for 16 Gbps Longwave	0-24
DKC-F810I-1PS32	SFP for 32 Gbps Longwave	0-24

Table 18 DBSE drive tray components

Model number	Description	Quantity
DW-F1000-DBSE	2U chassis	1
	ENC	2
	Power supply unit ¹	2
	Front bezel (2U)	1
Notes:		
1. DW-F1000-DBSE has an 80 PLUS PLATINUM power supply.		

Table 19 DBSE optional drive tray components

Model number	Description	Quantity
DKC-F810I-2R4JGM	2.4 TB, TLC 8 Gbps, SAS drive	0-24
DKC-F810I-1T9MGM	1.9 TB, TLC 8 Gbps, SAS drive	0-24
DKC-F810I-3R8MGM	3.8 TB, TLC 8 Gbps, SAS drive	0-24
DKC-F810I-7R6MGM	7.6 TB, TLC 8 Gbps, SAS drive	0-24
DKC-F810I-15RMGM	15 TB, TLC 8 Gbps, SAS drive	0-24
DKC-F810I-30RMGM	30 TB, TLC 8 Gbps, SAS drive	0-24

Table 20 DBS2 drive tray components

Model number	Description	Quantity
DW-F1000-DBS2	2U chassis	1
	ENC	2
	Power supply unit ¹	2
	Front bezel (2U)	1
Notes:		
1. DW-F1000-DBS2 has an 80 PLUS GOLD power supply.		

Table 21 DBS2 optional drive tray components

Model number	Description	Quantity
DKC-F810I-2R4JGM	2.4 TB, TLC 8 Gbps, SAS drive	0-24
DKC-F810I-1T9MGM	1.9 TB, TLC 8 Gbps, SAS drive	0-24
DKC-F810I-3R8MGM	3.8 TB, TLC 8 Gbps, SAS drive	0-24
DKC-F810I-7R6MGM	7.6 TB, TLC 8 Gbps, SAS drive	0-24
DKC-F810I-15RMGM	15 TB, TLC 8 Gbps, SAS drive	0-24
DKC-F810I-30RMGM	30 TB, TLC 8 Gbps, SAS drive	0-24

Table 22 DBLE drive tray components

Model number	Description	Quantity
DW-F1000-DBLE	2U chassis	1
	ENC	2
	Power supply unit ¹	2
	Front bezel (2U)	1
Notes:		
1. DW-F1000-DBLE has an 80 PLUS PLATINUM power supply.		

Table 23 DBLE optional drive tray components

Model number	Description	Quantity
DKC-F810I-6R0H9M	6 TB, TLC 8 Gbps, SAS drive	0-12
DKC-F810I-10RH9M	10 TB, TLC 8 Gbps, SAS drive	0-12
DKC-F810I-14RH9M	14 TB, TLC 8 Gbps, SAS drive	0-12

Table 24 DB60 drive tray components

Model number	Description	Quantity
DW-F1000-DB60	4U chassis	1
	ENC	2
	Power supply unit ¹	2
	Front bezel (4U)	1
Notes:		
1. DW-F1000-DB60E has a GOLD power supply.		

Table 25 DB60 optional drive tray components

Model number	Description	Quantity
DKC-F810I-2R4J8M	2.4 TB, TLC 8 Gbps, SAS drive	0-60
DKC-F810I-6R0HLM	6 TB, TLC 8 Gbps, SAS drive	0-60
DKC-F810I-10RHLM	10 TB, TLC 8 Gbps, SAS drive	0-60
DKC-F810I-14RHLM	14 TB, TLC 8 Gbps, SAS drive	0-60

Hitachi Vantara



Corporate Headquarters
2535 Augustine Drive
Santa Clara, CA 95054 USA
HitachiVantara.com | community.HitachiVantara.com

Contact Information
USA: 1-800-446-0744
Global: 1-858-547-4526
HitachiVantara.com/contact