

# Hitachi Virtual Storage Platform G130

88-02-0x

---

## Hardware Reference Guide

This document provides information about the system hardware components and the mechanical and environmental specifications for the Hitachi Virtual Storage Platform G130 storage system.

© 2018 Hitachi, Ltd. All rights reserved.

No part of this publication may be reproduced or transmitted in any form or by any means, electronic or mechanical, including copying and recording, or stored in a database or retrieval system for commercial purposes without the express written permission of Hitachi, Ltd., or Hitachi Vantara Corporation (collectively "Hitachi"). Licensee may make copies of the Materials provided that any such copy is: (i) created as an essential step in utilization of the Software as licensed and is used in no other manner; or (ii) used for archival purposes. Licensee may not make any other copies of the Materials. "Materials" mean text, data, photographs, graphics, audio, video and documents.

Hitachi reserves the right to make changes to this Material at any time without notice and assumes no responsibility for its use. The Materials contain the most current information available at the time of publication.

Some of the features described in the Materials might not be currently available. Refer to the most recent product announcement for information about feature and product availability, or contact Hitachi Vantara Corporation at [https://support.hitachivantara.com/en\\_us/contact-us.html](https://support.hitachivantara.com/en_us/contact-us.html).

**Notice:** Hitachi products and services can be ordered only under the terms and conditions of the applicable Hitachi agreements. The use of Hitachi products is governed by the terms of your agreements with Hitachi Vantara Corporation.

By using this software, you agree that you are responsible for:

1. Acquiring the relevant consents as may be required under local privacy laws or otherwise from authorized employees and other individuals; and
2. Verifying that your data continues to be held, retrieved, deleted, or otherwise processed in accordance with relevant laws.

**Notice on Export Controls.** The technical data and technology inherent in this Document may be subject to U.S. export control laws, including the U.S. Export Administration Act and its associated regulations, and may be subject to export or import regulations in other countries. Reader agrees to comply strictly with all such regulations and acknowledges that Reader has the responsibility to obtain licenses to export, re-export, or import the Document and any Compliant Products.

Hitachi is a registered trademark of Hitachi, Ltd., in the United States and other countries.

AIX, AS/400e, DB2, Domino, DS6000, DS8000, Enterprise Storage Server, eServer, FICON, FlashCopy, IBM, Lotus, MVS, OS/390, PowerPC, RS/6000, S/390, System z9, System z10, Tivoli, z/OS, z9, z10, z13, z/VM, and z/VSE are registered trademarks or trademarks of International Business Machines Corporation.

Active Directory, ActiveX, Bing, Excel, Hyper-V, Internet Explorer, the Internet Explorer logo, Microsoft, the Microsoft Corporate Logo, MS-DOS, Outlook, PowerPoint, SharePoint, Silverlight, SmartScreen, SQL Server, Visual Basic, Visual C++, Visual Studio, Windows, the Windows logo, Windows Azure, Windows PowerShell, Windows Server, the Windows start button, and Windows Vista are registered trademarks or trademarks of Microsoft Corporation. Microsoft product screen shots are reprinted with permission from Microsoft Corporation.

iPad is a trademark of Apple Inc., registered in the U.S. and other countries.

All other trademarks, service marks, and company names in this document or website are properties of their respective owners.

---

# Contents

<b>Preface</b> .....	<b>5</b>
Intended audience.....	5
UEFI Development Kit 2010.....	5
Product version.....	6
Release notes.....	6
Document conventions.....	6
Conventions for storage capacity values.....	7
Accessing product documentation.....	8
Getting help.....	9
Comments.....	9
<b>Chapter 1: Overview</b> .....	<b>10</b>
About Hitachi Virtual Storage Platform G130.....	10
System configurations.....	10
<b>Chapter 2: Hardware components and specifications</b> .....	<b>12</b>
Technical specifications.....	12
VSP G130 controller chassis.....	19
Controller chassis with small form-factor drive bays (CBSS).....	19
Controller chassis with large form-factor drive bays (CBSL).....	26
Drive trays.....	33
Small form-factor drive tray (DBS).....	33
Large form-factor drive tray (DBL).....	39
Service Processor.....	44
SVP front panel.....	45
SVP rear panel.....	46
<b>Chapter 3: Parts list</b> .....	<b>48</b>
Components list.....	48
Data and power cable model list.....	51
<b>Chapter 4: Operational and maintenance considerations</b> .....	<b>55</b>
Network access.....	55
TCP/IP port assignments.....	55
Controller connections.....	58
Physical service processor connections.....	58

Powering off the storage system.....	59
Storing the storage system.....	60
<b>Appendix A: Environmental notices.....</b>	<b>61</b>
<b>Appendix B: Regulatory compliance.....</b>	<b>62</b>

# Preface

This guide describes the hardware features and specifications of the VSP G130 storage system.

## Intended audience

This document is intended for Hitachi Vantara representatives, system administrators, and authorized service providers who install, configure, and operate the VSP G130 storage system.

Readers of this document should be familiar with the following:

- Data processing and RAID storage systems and their basic functions
- RAID storage system hardware components and operational specifications

## UEFI Development Kit 2010

This product includes UEFI Development Kit 2010 written by the UEFI Open Source Community. For more information, see the UEFI Development Kit website:

<http://sourceforge.net/apps/mediawiki/tianocore/index.php?title=UDK2010>

© 2004, Intel Corporation.

All rights reserved.

Redistribution and use in source and binary forms, with or without modification, are permitted provided that the following conditions are met:

Redistributions of source code must retain the above copyright notice, this list of conditions and the following disclaimer.

Redistributions in binary form must reproduce the above copyright notice, this list of conditions and the following disclaimer in the documentation and/or other materials provided with the distribution.

Neither the name of the Intel Corporation nor the names of its contributors might be used to endorse or promote products derived from this software without specific prior written permission.

THIS SOFTWARE IS PROVIDED BY THE COPYRIGHT HOLDERS AND CONTRIBUTORS "AS IS" AND ANY EXPRESS OR IMPLIED WARRANTIES, INCLUDING, BUT NOT LIMITED TO, THE IMPLIED WARRANTIES OF MERCHANTABILITY AND FITNESS FOR A PARTICULAR PURPOSE ARE DISCLAIMED. IN NO EVENT SHALL THE COPYRIGHT OWNER OR CONTRIBUTORS BE LIABLE FOR ANY DIRECT, INDIRECT, INCIDENTAL, SPECIAL, EXEMPLARY, OR CONSEQUENTIAL DAMAGES (INCLUDING, BUT NOT LIMITED TO, PROCUREMENT OF SUBSTITUTE GOODS OR SERVICES; LOSS OF USE, DATA, OR PROFITS; OR BUSINESS INTERRUPTION) HOWEVER CAUSED AND ON ANY THEORY OF LIABILITY, WHETHER IN CONTRACT, STRICT LIABILITY, OR TORT (INCLUDING NEGLIGENCE OR OTHERWISE) ARISING IN ANY WAY OUT OF THE USE OF THIS SOFTWARE, EVEN IF ADVISED OF THE POSSIBILITY OF SUCH DAMAGE.

## Product version

This document revision applies to VSP G130 firmware 88-02-0x or later.

## Release notes

Read the release notes before installing and using this product. They may contain requirements or restrictions that are not fully described in this document or updates or corrections to this document. Release notes are available on Hitachi Vantara Support Connect: <https://knowledge.hitachivantara.com/Documents>.





## Document conventions

This document uses the following typographic conventions:

Convention	Description
<b>Bold</b>	<ul style="list-style-type: none"> <li>Indicates text in a window, including window titles, menus, menu options, buttons, fields, and labels. Example: Click <b>OK</b>.</li> <li>Indicates emphasized words in list items.</li> </ul>
<i>Italic</i>	<ul style="list-style-type: none"> <li>Indicates a document title or emphasized words in text.</li> <li>Indicates a variable, which is a placeholder for actual text provided by the user or for output by the system. Example: <code>pairdisplay -g group</code></li> </ul> <p>(For exceptions to this convention for variables, see the entry for angle brackets.)</p>

Convention	Description
Monospace	Indicates text that is displayed on screen or entered by the user. Example: <code>pairdisplay -g oradb</code>
< > angle brackets	Indicates variables in the following scenarios: <ul style="list-style-type: none"> <li>Variables are not clearly separated from the surrounding text or from other variables. Example: <pre>Status-&lt;report-name&gt;&lt;file-version&gt;.csv</pre> </li> <li>Variables in headings.</li> </ul>
[ ] square brackets	Indicates optional values. Example: [ a   b ] indicates that you can choose a, b, or nothing.
{ } braces	Indicates required or expected values. Example: { a   b } indicates that you must choose either a or b.
vertical bar	Indicates that you have a choice between two or more options or arguments. Examples: [ a   b ] indicates that you can choose a, b, or nothing. { a   b } indicates that you must choose either a or b.

This document uses the following icons to draw attention to information:

Icon	Label	Description
	Note	Calls attention to important or additional information.
	Tip	Provides helpful information, guidelines, or suggestions for performing tasks more effectively.
	Caution	Warns the user of adverse conditions and/or consequences (for example, disruptive operations, data loss, or a system crash).
	WARNING	Warns the user of a hazardous situation which, if not avoided, could result in death or serious injury.

## Conventions for storage capacity values

Physical storage capacity values (for example, disk drive capacity) are calculated based on the following values:

Physical capacity unit	Value
1 kilobyte (KB)	1,000 (10 <sup>3</sup> ) bytes
1 megabyte (MB)	1,000 KB or 1,000 <sup>2</sup> bytes
1 gigabyte (GB)	1,000 MB or 1,000 <sup>3</sup> bytes
1 terabyte (TB)	1,000 GB or 1,000 <sup>4</sup> bytes
1 petabyte (PB)	1,000 TB or 1,000 <sup>5</sup> bytes
1 exabyte (EB)	1,000 PB or 1,000 <sup>6</sup> bytes

Logical capacity values (for example, logical device capacity, cache memory capacity) are calculated based on the following values:

Logical capacity unit	Value
1 block	512 bytes
1 cylinder	Mainframe: 870 KB Open-systems: <ul style="list-style-type: none"> <li>▪ OPEN-V: 960 KB</li> <li>▪ Others: 720 KB</li> </ul>
1 KB	1,024 (2 <sup>10</sup> ) bytes
1 MB	1,024 KB or 1,024 <sup>2</sup> bytes
1 GB	1,024 MB or 1,024 <sup>3</sup> bytes
1 TB	1,024 GB or 1,024 <sup>4</sup> bytes
1 PB	1,024 TB or 1,024 <sup>5</sup> bytes
1 EB	1,024 PB or 1,024 <sup>6</sup> bytes

## Accessing product documentation

Product user documentation is available on Hitachi Vantara Support Connect: <https://knowledge.hitachivantara.com/Documents>. Check this site for the most current documentation, including important updates that may have been made after the release of the product.



## Getting help

[Hitachi Vantara Support Connect](#) is the destination for technical support of products and solutions sold by Hitachi Vantara. To contact technical support, log on to Hitachi Vantara Support Connect for contact information: [https://support.hitachivantara.com/en\\_us/contact-us.html](https://support.hitachivantara.com/en_us/contact-us.html).

[Hitachi Vantara Community](#) is a global online community for Hitachi Vantara customers, partners, independent software vendors, employees, and prospects. It is the destination to get answers, discover insights, and make connections. **Join the conversation today!** Go to [community.hitachivantara.com](https://community.hitachivantara.com), register, and complete your profile.

## Comments

Please send us your comments on this document to [doc.comments@hitachivantara.com](mailto:doc.comments@hitachivantara.com). Include the document title and number, including the revision level (for example, -07), and refer to specific sections and paragraphs whenever possible. All comments become the property of Hitachi Vantara Corporation.

**Thank you!**

---

## Chapter 1: Overview

The following describes hardware components, features, and configurations of the Hitachi Virtual Storage Platform G130.

### About Hitachi Virtual Storage Platform G130

The VSP G130 is comprised of a controller chassis and drive trays. The controller chassis is equipped with a controller board, fans, dual power supply units, and drive bay for small form-factor (SFF) or large form-factor (LFF) SAS disk drives. The controller board is embedded with Fibre Channel interface, cache flash memory (CFM), and battery backup modules.

The storage system supports small form-factor (DBS) and large form-factor (DBL) drive trays. Both drive trays are equipped with an I/O module (ENC) and redundant power supplies with integrated cooling fans. The DBS tray supports SFF SAS disk drives. The DBL tray supports LFF SAS disk drives.

#### Features

- Modular and versatile system configurations
- High reliability and strong performance
- Simple management of array
- Easily expandable storage capacity

#### Scalability and versatility

- One dual controller chassis with on-board SFF or LFF SAS disk drives
- Host interfaces: 16-Gbps FC
- One or more optional drive trays (up to three DBS drive trays or seven DBL drive trays)
- Optional service processor (SVP)

### System configurations

The following table lists the supported system configurations with maximum mountable drive tray and data drives for the VSP G130 storage system.

Controller chassis	Number of mountable drive trays		Maximum number of mountable SAS drives
	Drive tray	Maximum	
CBSS	DBS	3	96
	DBL	6	96
CBSL	DBS	3	84
	DBL	7	96

## Chapter 2: Hardware components and specifications

The following section describes the technical specifications and associated hardware components of the VSP G130 storage system.

### Technical specifications

The following table provides some key technical specifications for VSP G130.

**Table 1 System specifications**

Item		Specification	
System	Number of disk drives (HDD)	Minimum	4 (disk-in model)/0 (diskless model)
		Maximum	96
	RAID level		RAID 6/RAID 5/RAID 1
	RAID group configuration	RAID 6	6D+2P, 14D+2P
		RAID 5	3D+1P, 7D+1P
		RAID 1	2D+2D, 4D+4D
	Maximum number of spare drives		16 <sup>1</sup>
	Maximum number of volumes		2,048
Maximum storage system capacity (physical capacity)		201 TiB (using 2.4 TB, SFF HDD) 854 TiB (using 10 TiB, LFF HDD)	
Memory	Cache memory capacity	32 GiB	
	Cache flash memory capacity	BM05	
Storage interface	Controller/drive chassis interface	SAS/Dual Port	
	Data transfer rate	Maximum 12 Gb/s	
	Maximum number of drives per SAS interface	144	

Item			Specification
Channel interface	Support channel type	Open systems	Fibre Channel Shortwave
		Fibre Channel	400/800/1600 MB/s
	Data transfer rate		
	Maximum number of channel adapters		4
Power	AC Input	Single-phase	50Hz/60Hz : 100V to 120V, 200V to 240V
Acoustic Level 2, 3	Operating	CBSS/CBSL	60dB (32°C)
		DBSC/DBLC	60dB (32°C) <sup>4, 5</sup>
	Standby	CBSS/CBSL	55dB
		DBSC/DBLC	55dB <sup>4, 5</sup>
Non-stop maintenance	Control PCB		Supported
	Cache memory module		Supported
	Cache flash memory		Supported
	Power supply, fan		Supported
	Microcode		Supported
	Drive (2.5-inch/3.5-inch HDD)		Supported
<p><b>Notes:</b></p> <ol style="list-style-type: none"> <li>1. Available as spare drive or data disks.</li> <li>2. The acoustic level is measured under the following conditions in accordance with ISO7779 and the value is declared based on ISO9296. In a normal installation area (data center/general office), the storage system is surrounded by different elements from the following measuring conditions according to ISO, such as noise sources other than the storage system (other devices), the walls and ceilings that reflect the sound. Therefore, the values described in the table do not guarantee the acoustic level in the actual installation area. <ul style="list-style-type: none"> <li>▪ Measurement environment: In a semi-anechoic room whose ambient temperature is 23°C ± 2°C</li> <li>▪ Device installation position: The Controller Chassis is at the bottom of the rack and the Drive Box is at a height of 1.5m in the rack.</li> </ul> </li> </ol>			

Item	Specification
<ul style="list-style-type: none"> <li>■ Measurement position: 1m away from the front, rear, left or right side of the storage system and 1.5m high (at four points).</li> <li>■ Measurement value: Energy average value of the four points (front, rear, left and right).</li> </ul> <p>3. It is recommended to install the Hitachi Vantara storage system into a data center. However, you can install the storage system into an office space but the space should be equipped with proper cooling systems and noise insulation. When you are installing a storage system into a regular office space, observe the following: The cooling fans in the storage system are compact and the high rotational speed of the cooling fan blades causes high-frequency noise.</p> <p>4. Sound pressure level (LA) changes from 66dB to 75dB according to the ambient temperature, drive configuration and operating status. The maximum could be 79dB during maintenance procedure for failed ENC or Power Supply.</p> <p>5. Acoustic power level (LwA) measured by ISO7779 condition is 7.2B. And it changes from 7.2B to 8.1B according to the ambient temperature, drive configuration and operating status.</p>	

### Electrical specifications

The following table describes the electrical specifications for the VSP G130.

Input power specifications	CBSS/CBSL controller chassis	DBS/DBL drive tray
Input voltage (Operable voltage range) (V)	AC 100-120/200-240 +6%/-11%	AC 100-120 / 200-240 +6%/-11%
Frequency (Hz)	50/60 ± 1	
Number of phases, cabling	Single-phase with protective grounding	
Steady-state current 100V/200V (A) <sup>1, 2</sup>	4.0×2/2.0×2	DBS: 2.4×2/1.2×2 DBL: 1.9×2/1.0×2
Current rating of breaker/ fuse (A)	16.0 (each electrical)	16.0 (each electrical)
Heat value (normal) (kJ/h)	1770 or less	DBS: 1120 or less DBL: 940 or less
Steady-state power (VA/W) <sup>3</sup>	800/760 or less	DBS: 480/460 or less DBL: 380/350 or less
Power consumption	490/490 or less	DBS: 320/310 or less

Input power specifications	CBSS/CBSL controller chassis	DBS/DBL drive tray
(VA/W)		DBL: 280/260 or less
<p><b>Note:</b></p> <ol style="list-style-type: none"> <li>1. The power current of N2 described in this table is required for operation by a single power supply unit.</li> <li>2. If one power supply unit fails, another power supply unit requires electric current for the two power supply units. Therefore, plan the power supply facility so the current carrying capacity of one power supply unit can provide a total capacity of the two power supply units.</li> <li>3. Power requirement for the maximum configuration is shown. Value at 100 V/200 V is shown. The actual required power may exceed the value shown in the table when the tolerance is included.</li> </ol>		

### Environmental specifications

The following table describes the environmental specifications for the VSP G130.



**Note:** The VSP G130 storage system components are not supported in high-temperature environments. Do not operate the Hitachi Vantara-provided service processor (SVP) at temperatures of 40°C or higher.

Item		CBSS/CBSL controller chassis	DBS/DBL drive tray	Notes
Temperature	Operating (°C)	10 to 40	10 to 40	-
	Non-operating (°C)	-10 to 50	-10 to 50	
	Transport/storage (°C)	-30 to 60	-30 to 60	
	Temperature change rate (°C)	10 or less	10 or less	
Humidity	Operating (°C)	8 to 80	8 to 80	-
	Non-operating (°C)	8 to 90	8 to 90	
	Transport/storage (°C)	5 to 95	5 to 95	
	Max. wet bulb temperature (°C)	29 (non-condensing)	29 (non-condensing)	
Vibration	Operating (m/s <sup>2</sup> )	2.5 or less (5 to 300Hz)	2.5 or less (5 to 300Hz)	Within 5 seconds (Resonance point: 10Hz or less)
	Non-operating (m/s <sup>2</sup> )	5.0 or less (5 to 300Hz): No critical damage for product. 9.8 (1.0G): Ensure own safety with fall prevention.	5.0 or less (5 to 300Hz): No critical damage for product. 9.8 (1.0G): Ensure own safety with fall prevention.	
	Transport (packed) (m/s <sup>2</sup> )	5.0 or less	5.0 or less	-
Impact	Operating (m/s <sup>2</sup> )	20 or less	20 or less	10ms, half sine wave
	Non-operating (m/s <sup>2</sup> )	50 or less	50 or less	
	Transport (packed) (m/s <sup>2</sup> )	80 or less	80 or less	
Storage system tips over at specific angle (°)		15° or less	15° or less	To be measured when installed on leveling bolts.



Item		CBSS/CBSL controller chassis	DBS/DBL drive tray	Notes
Altitude	Operating (m)	(5) to 3,050 (Environmental temperature: 10°C to 28°C) to 950 (Environmental temperature: 10°C to 40°C)		-
	Non-operating (m)	-60 to 12,000	-60 to 12,000	
Gaseous contaminants <sup>4</sup>	Operating	G1 classification levels	G1 classification levels	-
	Non-operating	G1 classification levels	G1 classification levels	
	Transport/storage	-	-	
Acoustic noise LpAm <sup>6,7</sup> (dB)	Operating	60 (Environmental temperature: 32°C or less) <sup>1</sup>		-
	Standby	55		
Noise level (dB)	Operating (Recommended)	90 or less <sup>3</sup>		-
<b>Notes:</b> <ol style="list-style-type: none"> <li>1. The system internal temperature controls the rotating speed of the fan. This value might be exceeded if the maximum load continues under high temperature environment or if a failure occurs in the system.</li> <li>2. Sound pressure level [LA] changes from 66dB to 75dB according to the ambient temperature, drive configuration, and operating status. The maximum value can reach 79dB during maintenance procedure for failed ENC or power supply unit.</li> <li>3. Fire-suppression systems and pneumatic sirens can generate high levels of acoustic noise and affect system performance. It can also cause vibrations to the hard disk drives (HDD) in the storage systems resulting in I/O errors, performance degradation in and to some extent damage to the HDDs. The noise level tolerance of HDDs may vary among different models, designs, capacities and manufacturers. The recommended acoustic noise level for an operating environment is 90dB or less in order to ensure reliable operations when placing a Hitachi Vantara storage system two meters from the source of the noise.</li> </ol>				

Item	CBSS/CBSL controller chassis	DBS/DBL drive tray	Notes
			<p>Hitachi Vantara does not test storage systems and HDDs for compatibility with fire suppression systems and pneumatic sirens. Hitachi Vantara also does not provide recommendations or claim compatibility with any fire suppression systems and pneumatic sirens. The customer is responsible to follow their local or national regulations.</p> <p>To prevent I/O error or damages to HDDs in the storage systems, Hitachi Vantara recommends the following:</p> <ul style="list-style-type: none"> <li>▪ Install noise-reducing baffles to mitigate the noise to the HDDs in the storage systems.</li> <li>▪ Consult the fire suppression system manufacturers on noise reduction nozzles to reduce the acoustic noise to protect the HDDs in the storage systems.</li> <li>▪ Locate the storage system as far as possible from noise sources such as emergency sirens.</li> <li>▪ If it can be safely done without risk of personal injury, shut down the storage systems to avoid data loss and damages to the HDDs in the storage systems.</li> </ul> <p>Damage to HDDs from fire suppression systems or pneumatic sirens voids the HDD warranty.</p> <ol style="list-style-type: none"> <li>4. See ANSI/ISA-71.04-2013 Environmental Conditions for Process Measurement and Control Systems: Airborne Contaminants.</li> <li>5. Meets the highest allowable temperature conditions and complies with ASHRAE (American Society of Heating, Refrigerating and Air-Conditioning Engineers) 2011 Thermal Guidelines Class A3. The maximum value of the ambient temperature and the altitude is from 40°C at an altitude of 950 meters (3000 feet) to 28°C at an altitude of 3050 meters (10000 feet). The allowable ambient temperature is decreased by 1°C for every 175-meter increase in altitude above 950 meters.</li> <li>6. The acoustic level is measured under the following conditions in accordance with ISO7779 and the value is declared based on ISO9296.</li> </ol>

Item	CBSS/CBSL controller chassis	DBS/DBL drive tray	Notes
			<p>In a normal installation (data center/office), the storage system is surrounded by different elements from the following measuring conditions according to ISO, such as noise sources other than the storage system (other devices), the walls and ceilings that reflect the sound. Therefore, the values described in the table do not guarantee the acoustic level in the actual installation area.</p> <ul style="list-style-type: none"> <li>▪ Measurement environment: In a semi-anechoic room whose ambient temperature is 23°C ±2°C</li> <li>▪ Device installation position: The controller chassis is at the bottom of the rack and the drive tray is at a height of 1.5 meters in the rack.</li> <li>▪ Measurement position: 1 meter away from the front, rear, left, or right side of the storage system and 1.5 meters high (at four points)</li> <li>▪ Measurement value: Energy average value of the four points (front, rear, left, and right)</li> </ul> <p>7. It is recommended to install the Hitachi Vantara storage system into a data center. However, you can install the storage system into an office space but the space should be equipped with proper cooling systems and noise insulation. When you are installing a storage system into a regular office space, observe the following: The cooling fans in the storage system are compact and the high rotational speed of the cooling fan blades causes high-frequency noise.</p>

## VSP G130 controller chassis

Each controller chassis includes dual controllers equipped with internal components such as a processor, single cache memory module (DIMMs), cache flash memory (CFM), battery, fans. The front of the controller chassis provides a drive bay for loading 2.5-inch or 3.5-inch SAS disk drives.

The controller has an Ethernet connection for out-of-band management using Device Manager - Storage Navigator. If the data path through one controller fails, all drives remain available to data hosts using a redundant data path through the other controller. The controller is equipped with LED indicators for monitoring its operating conditions and notifying possible component replacement.

### Controller chassis with small form-factor drive bays (CBSS)

The following describes the CBSS controller board specifications and associated physical features of the controller.

#### CBSS mechanical specifications

The following table provides a description and specifications of the CBSS controller chassis.

Item	Description
Chassis (2U)	DW800-CBSS
Controller board	DW-F850- F850-CTLXSFA
Number of DIMM slot	1
Cache memory DIMM capacity per controller	16 GiB
Total cache memory capacity per system	32 GiB
Control memory	Flash memory: 32 MB L3 cache memory: 4 MB SDRAM: 1 GB
Data assurance method	Data bus: Parity Cache memory: ECC (1-bit correction, 2-bit detection) Drive: Data assurance code
Available drive slots	24
Physical dimension (W x D x H) (mm)	483 × 813 × 88 mm
Weight/Mass (kg) (Approximate)	16.1 kg
Start-up time (min) <sup>1</sup>	5 to 8 (min)
Height (EIA unit) <sup>2</sup>	2U
Heat output (W)	218 W
Power consumption (VA)	226 W
Insulation withstand voltage	AC 1,500 V (100mA, 1min)
Insulation resistance	DC 500 V, 10 MΩ or more
Air flow (m <sup>3</sup> /min) <sup>3</sup>	4.0 (m <sup>3</sup> /min)
<b>Notes:</b>	
<ol style="list-style-type: none"> <li>1. Start-up times might be longer depending on the number of drive trays connected. With a maximum configuration 1 controller chassis and 3 drive trays, start-up time is approximately 8 minutes.</li> <li>2. Can be mounted on the Hitachi Universal V2 rack.</li> </ol>	

Item	Description
3.	Value shown is the maximum value.

### Host interface specifications

The following table lists the specifications of the host interfaces available for the VSP G130 controllers.

Item	Specification
Interface type	16 Gbps FC (Optical)
Data transfer speed (Max. speed for transfer to host)	400 Mbps (FC) 800 Mbps (FC) 1600 Mbps (FC)
Number of ports per controller	16 Gbps FC (Optical): 2
Number of ports per system	4

### Battery life specifications

Storage system intake temperature	CBSS
Up to 75.2° F (24° C)	5 years
Up to 86° F (30° C)	5 years
Up to 93.2° (34° C)	4 years
Up to 104° (40° C)	3 years

### CBSS component LEDs

The following table lists the definitions of the CBSS controller chassis front panel bezel LEDs.

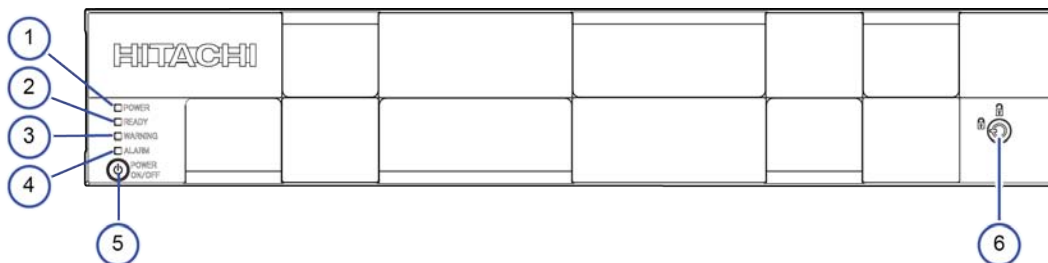

Number	Item	Color	Pattern	Description
1	POWER LED	Green	ON	Storage system is powered on.
		Amber	ON	Storage system is receiving power.
2	READY LED	Green	ON	Storage system is ready for normal operation.
3	WARNING LED	Amber	ON	Component requires maintenance.
			Blink	<p>Failure occurred. Requires maintenance.</p> <p>When the SIM is confirmed, the LED pattern indicates the failure and requires attention.</p> <p><b>Note:</b> When System Option Mode 1097 is set to ON, the WARNING LED does not blink, even if the following failure service information messages (SIM) are issued: 452xxx, 462xxx, 3077xx, 4100xx, and 410100.</p> <p>LED might turn off during user maintenance.</p>
4	ALARM LED	Red	ON	Processor failure (system might be down). For assistance, contact customer support: <a href="https://support.hitachivantara.com/en_us/contact-us.html">https://support.hitachivantara.com/en_us/contact-us.html</a> .
5	POWER ON/OFF (main switch)	-	-	Turns on power to the storage system.
6	Lock	-	-	Locks and unlocks the front panel bezel by using the supplied key.



**Note:** Removing a controller can cause the POWER, READY, WARNING, and ALARM LEDs on the front panel to turn off. These LEDs return to their on state after the storage system recovers from the controller replacement.

The following table describes the definitions of the CBSS controller front panel LEDs without an attached front bezel.

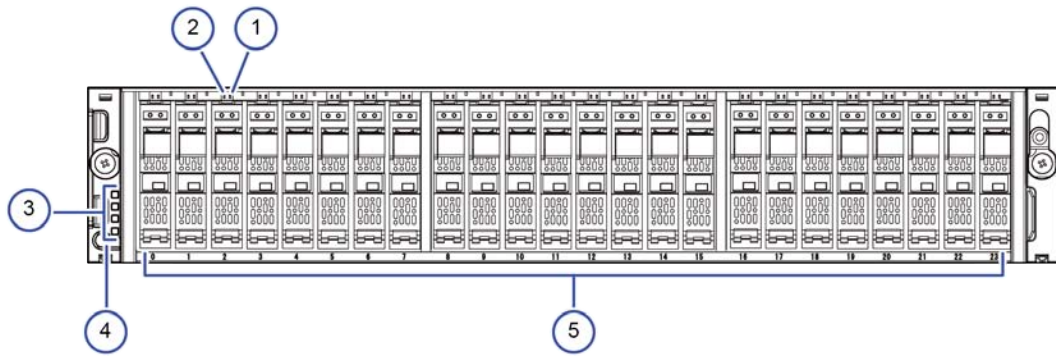

Number	Item	Color	Pattern	Description
1	ACT LED	Green	ON	Normal operation.
			Blink	Drive is being accessed.
2	ALM LED	Red	ON	Drive stopped due to a failure and can be replaced.
3	POWER, READY, WARNING, and ALARM LEDs	-	-	Refer to the previous table. <b>Note:</b> When System Option Mode 1097 is set to ON, the WARNING LED does not blink, even if the following failure service information messages (SIM) are issued: 452xxx, 462xxx, 3077xx, 4100xx, and 410100.
4	POWER ON/OFF (main switch)	-	-	Turns on power to the storage system.
5	Small form-factor drive slots	-	-	Twenty-four 2.5-inch small form-factor drives are positioned vertically in the slots. The slots are arranged from left to right and organized as 0 to 23.

The following table describes the definitions of the CBSS controller real panel LEDs.

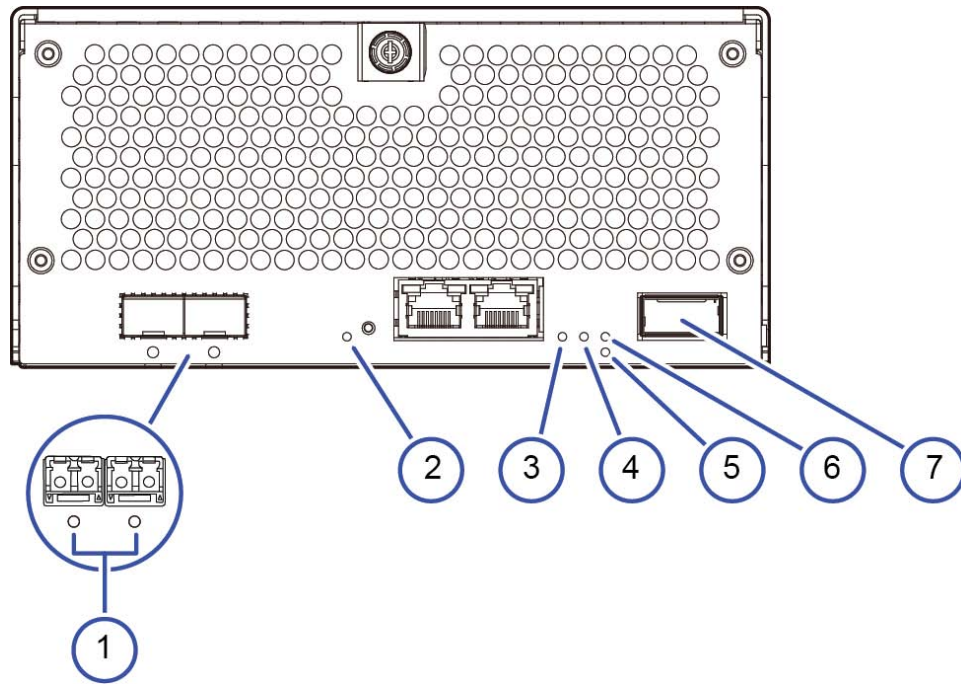



Number	Item	Color	Pattern	Description
1	Port LED	Red	ON	A failure occurred in the small form-factor pluggable (SFP).
		Blue	ON	Normal link status at 16-Gbps (16-Gbps SFP)
		Green	ON	Normal link status at 4-Gbps or 8-Gbps (16-Gbps SFP)
2	LAN LED	Amber	ON	LAN-RST is pressed.
3	Battery status LED	Green	ON	Battery charge is complete.
			Blink	Battery is charging or discharging.
		-	OFF	Battery indicates the following status: <ul style="list-style-type: none"> <li>The battery is not installed.</li> <li>A failure occurred.</li> </ul>
4	Backup status LED	Green	ON	Restoration in progress following loss of power.
			Fast blink	Restoring. Blinking five time per second.
			Slow blink	Restoring or sequential shutdown in progress. Blinking once per second.
5	SAS port LED	Blue	ON	Link to port is established.
6	Controller (CLT) ALM LED	Red	ON	Controller can be removed.
			Blink	Failure occurred to controller power supply.
		Amber	ON	LAN switched is pressed.
7	SAS port			SAS cable port.

The following table describes the definitions of the CBSL controller AC power supply unit LEDs and connectors.

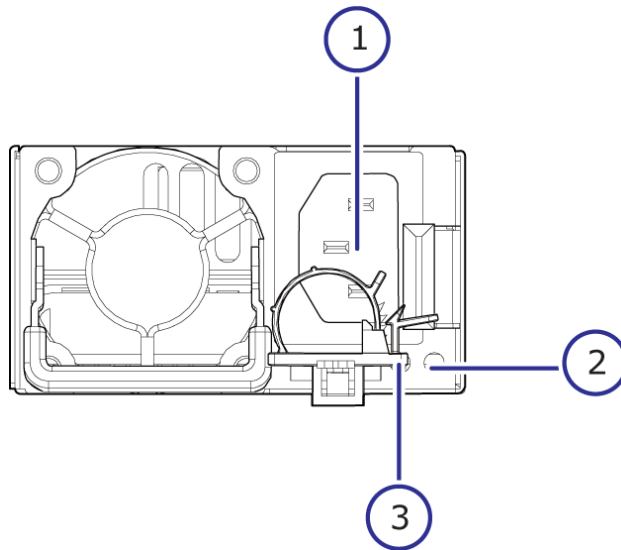

Number	Item	Description
1	Receptacle	Connects to the power cable provided with the storage system.
2	AC IN LED	Blue: AC input is normal.
3	ALM/RDY LED	Red: Power supply unit can be replaced. Green: Normal operation.

## Controller chassis with large form-factor drive bays (CBSL)

The following describes the CBSL controller chassis technical specifications and associated physical features of the controller.

### CBSL mechanical specifications

The following table provides a description and specifications of the CBSL controller chassis.

Item	Description
Chassis (2U)	DW800-CBSL
Controller board	DW-F850- F850-CTLXSFA
Number of DIMM slot	1
Cache memory DIMM capacity per controller	16 GiB
Total cache memory capacity per system	32 GiB
Control memory	Flash memory: 32 MB L3 cache memory: 4 MB SDRAM: 1 GB
Data assurance method	Data bus: Parity Cache memory: ECC (1-bit correction, 2-bit detection) Drive: Data assurance code
Available drive slots	12
Physical dimension (W x D x H) (mm)	483 × 813 × 88 mm
Weight/Mass (kg) (Approximate)	15.9 kg
Start-up time (min) <sup>1</sup>	5 to 8 (min)
Required height (EIA unit) <sup>2</sup>	2U
Heat output (W)	192 W
Power consumption (VA)	200 W
Insulation withstand voltage	AC 1,500 V (100mA, 1min)
Insulation resistance	DC 500 V, 10 MΩ or more
Air flow (m <sup>3</sup> /min) <sup>3</sup>	3.5 (m <sup>3</sup> /min)
<b>Notes:</b>	
<ol style="list-style-type: none"> <li>Start-up times might be longer depending on the number of drive trays connected. With a maximum configuration 1 controller chassis and 7 drive trays, start-up time is approximately 8 minutes.</li> <li>Can be mounted on the Hitachi Universal V2 rack.</li> </ol>	

Item	Description
3.	Value shown is the maximum value.

### Host interface specifications

The following table lists the specifications of the host interfaces available for the VSP G130 controllers.

Item	Specification
Interface type	16 Gbps FC (Optical)
Data transfer speed (Max. speed for transfer to host)	400 Mbps (FC) 800 Mbps (FC) 1600 Mbps (FC)
Number of ports per controller	16 Gbps FC (Optical): 2
Number of ports per system	4

### Battery life specifications

Storage system intake temperature	CBSL
Up to 75.2° F (24° C)	5 years
Up to 86° F (30° C)	4 years
Up to 93.2° (34° C)	3 years
Up to 104° (40° C)	2 years

### CBSL component LEDs

The following table describes the definitions of the CBSL controller front panel bezel LEDs.

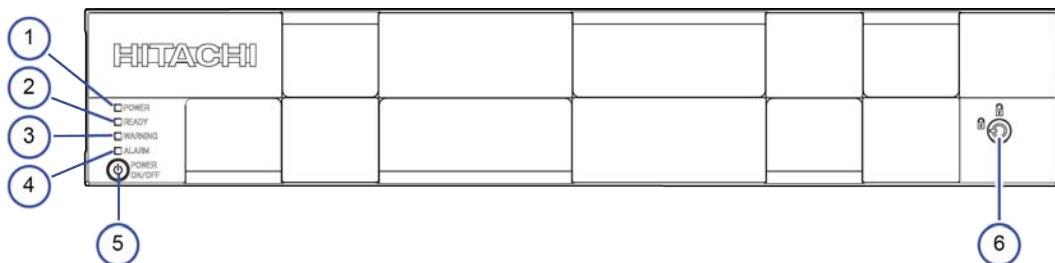

Number	Item	Color	Pattern	Description
1	POWER LED	Green	ON	Storage system is powered on.
		Amber	ON	Storage system is receiving power.
2	READY LED	Green	ON	Storage system is ready for normal operation.
3	WARNING LED	Amber	ON	Component requires maintenance.
			Blink	<p>Failure occurred. Requires maintenance.</p> <p>When the SIM is confirmed, the LED pattern indicates the failure and requires attention.</p> <p><b>Note:</b> When System Option Mode 1097 is set to ON, the WARNING LED does not blink, even if the following failure service information messages (SIM) are issued: 452xxx, 462xxx, 3077xx, 4100xx, and 410100.</p> <p>LED might turn off during user maintenance.</p>
4	ALARM LED	Red	ON	Processor failure (system might be down). For assistance, contact customer support: <a href="https://support.hitachivantara.com/en-us/contact-us.html">https://support.hitachivantara.com/en-us/contact-us.html</a> .
5	POWER ON/OFF (main switch)	-	-	Turns on power to the storage system.
6	Lock	-	-	Locks and unlocks the front panel bezel by using the supplied key.



**Note:** Removing a controller can cause the POWER, READY, WARNING, and ALARM LEDs on the front panel to turn off. These LEDs return to their on state after the storage system recovers from the controller replacement.

The following table describes the definitions of the CBSL controller front panel LEDs without an attached front bezel.

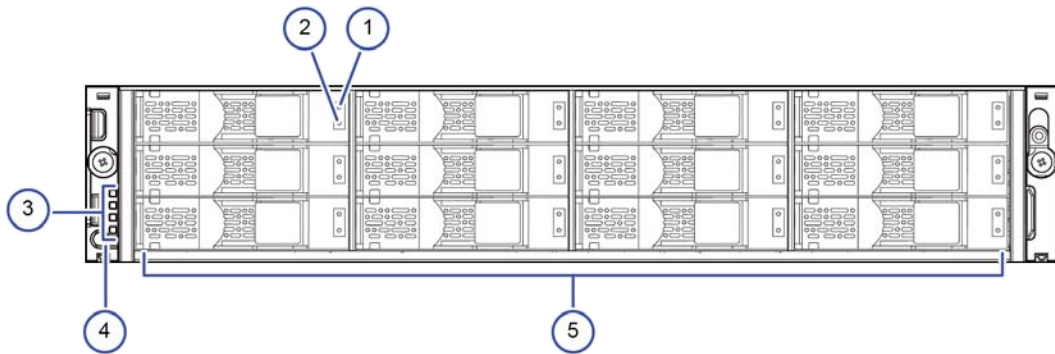

Number	Item	Color	Pattern	Description												
1	ACT LED	Green	ON	Normal operation.												
			Blink	Drive is being accessed.												
2	ALM LED	Red	ON	Drive stopped due to a failure and can be replaced.												
3	POWER, READY, WARNING, and ALARM LEDs	-	-	Refer to the previous table. <b>Note:</b> When System Option Mode 1097 is set to ON, the WARNING LED does not blink, even if the following failure service information messages (SIM) are issued: 452xxx, 462xxx, 3077xx, 4100xx, and 410100.												
4	POWER ON/OFF (main switch)	-	-	Turns on power to the storage system.												
5	Large form-factor drive slots	-	-	Twelve 3.5-inch large form-factor drives are positioned horizontally in the slots. The slots are organized from 0 to 11 in the following order: <table border="1" style="margin-left: 20px;"> <tr> <td>8</td> <td>9</td> <td>10</td> <td>11</td> </tr> <tr> <td>4</td> <td>5</td> <td>6</td> <td>7</td> </tr> <tr> <td>0</td> <td>1</td> <td>2</td> <td>3</td> </tr> </table>	8	9	10	11	4	5	6	7	0	1	2	3
8	9	10	11													
4	5	6	7													
0	1	2	3													

The following table describes the definitions of the CBSL controller real panel LEDs.

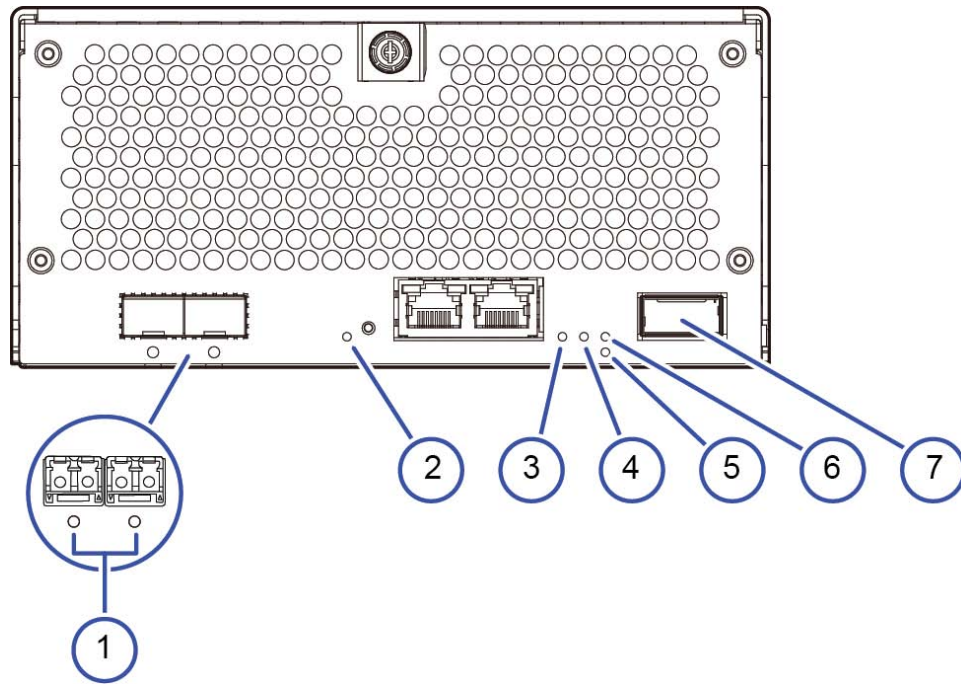

Number	Item	Color	Pattern	Description
1	Port LED	Red	ON	A failure occurred in the small form-factor pluggable (SFP).
		Blue	ON	Normal link status at 16-Gbps (16-Gbps SFP)
		Green	ON	Normal link status at 4-Gbps or 8-Gbps (16-Gbps SFP)
2	LAN LED	Amber	ON	LAN-RST is pressed.
3	Battery status LED	Green	ON	Battery charge is complete.
			Blink	Battery is charging or discharging.
		-	OFF	Battery indicates the following status: <ul style="list-style-type: none"> <li>▪ The battery is not installed.</li> <li>▪ A failure occurred.</li> </ul>
4	Backup status LED	Green	ON	Restoration in progress following loss of power.
			Fast blink	Restoring. Blinking five time per second.
			Slow blink	Restoring or sequential shutdown in progress. Blinking once per second.
5	SAS port LED	Blue	ON	Link to port is established.
6	Controller (CLT) ALM LED	Red	ON	Controller can be removed.
			Blink	Failure occurred to controller power supply.
		Amber	ON	LAN switched is pressed.
7	SAS port			SAS cable port.



The following table describes the definitions of the CBSL controller AC power supply unit LEDs and connectors.

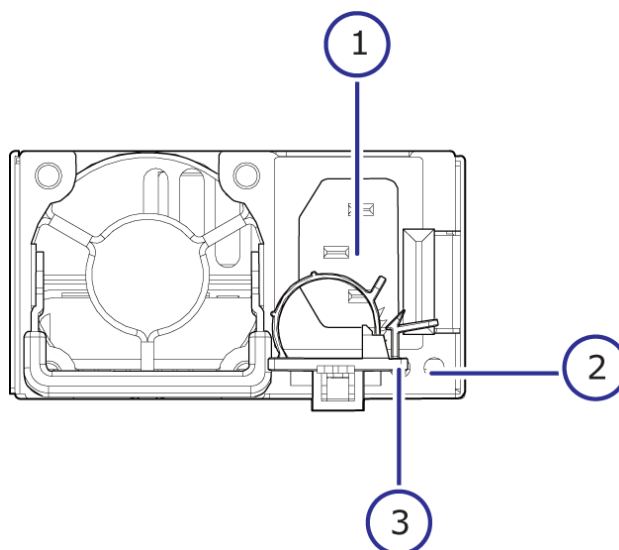

Number	Item	Description
1	Receptacle	Connects to the power cable provided with the storage system.
2	AC IN LED	Blue: AC input is normal.
3	ALM/RDY LED	Red: Power supply unit can be replaced. Green: Normal operation.

## Drive trays

The SFF and LFF drive trays contain disk drives, power supplies, fans, and status LEDs. Each drive tray provides interfaces for connecting to controllers and other drive trays.

### Small form-factor drive tray (DBS)

The following tables provide information about the DBS drive tray specifications and supported configurations for VSP G130 storage system.

Name	Model number	Height	Number of drive slots	Supported drive type
DBS	DW-F800-DBSC	2U (88.2 mm)	24	2.5 inch (SFF)

**Physical specifications**

Item	Specification
Physical dimension (W x D x H) (mm)	482 × 565 × 88.2 mm
Weight/Mass (kg) (Approximate)	17 kg
Start-up time (min) <sup>1</sup>	5 to 8 (min)
Height (EIA unit) <sup>2</sup>	2U
Heat output (W)	116 W
Power consumption (VA)	126 VA
Air flow (m <sup>3</sup> /min) <sup>3</sup>	2.2 (m <sup>3</sup> /min)
<p><b>Notes:</b></p> <ol style="list-style-type: none"> <li>1. Start-up times might be longer depending on the number of drive trays connected. With a maximum configuration 1 controller chassis and 3 drive trays, start-up time is approximately 8 minutes.</li> <li>2. Can be mounted on the Hitachi Universal V2 rack. For the mounting, special rails for the rack and decoration panels are required separately depending on the number of the mounted storage systems.</li> <li>3. Value shown is the maximum value.</li> </ol>	

**Supported drive type**

Item	Specification	
Drive form-factor	2.5-inch HDD	
Supported data capacity	576.39, 1152.79, 2305.58 GB	
Maximum mountable quantity (unit) <sup>1</sup>	24 (total per chassis)	96 (maximum per system)
Maximum number of spare drives <sup>2</sup>	16	
<b>Note:</b>		
<ol style="list-style-type: none"> <li>1. When mounting storage system and DBS drive trays, the maximum mountable quantity may vary.</li> <li>2. Available as spare or data disks.</li> </ol>		

**DBS component LEDs**

The following table lists the definitions of the DBS drive tray front bezel LEDs.

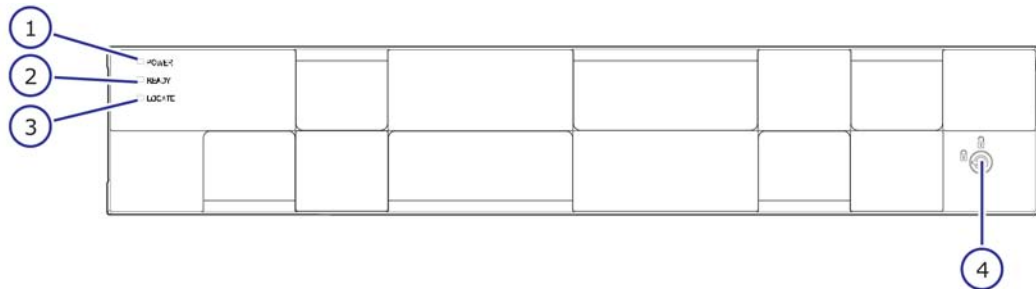

Number	Item	Color	Pattern	Description
1	POWER LED	Green	ON	Drive tray is powered on.
2	READY LED	Green	ON	Drive tray is ready for normal operation.
3	Locate LED	Amber	Blink	Indicates the location of the chassis. Can be turned on or turned off by the maintenance utility.
4	Lock	-	-	Locks or unlocks the front panel bezel by using the supplied key.

The following table lists the definitions of the DBS drive tray front LEDs without an attached bezel.

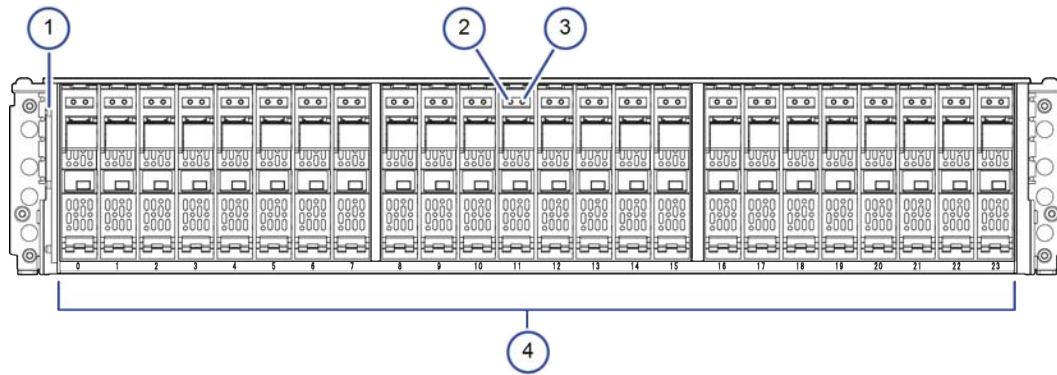

Number	Item	Color	Pattern	Description
1	POWER, READY, and, LOCATE LEDs	Green	ON	Drive tray is powered on. Drive tray is under normal operation.
		Amber	Blink	Indicates the location of the chassis. Can be turned on or turned off by the maintenance utility.
2	ALM LED	Red	ON	Drive stopped due to a failure and can be replaced.
3	ACT LED	Green	ON	Drive tray is under normal operation.
			Blink	Drive is being accessed.
4	SFF drive slots	-	-	Twenty-four 2.5-inch small form-factor drives are positioned vertically.  Twenty-four 2.5-inch small form-factor drives are positioned vertically in the slots. The slots are arranged from left to right and organized as 0 to 23.

The following table lists the definitions of the DBS drive tray rear panel components and LEDs.

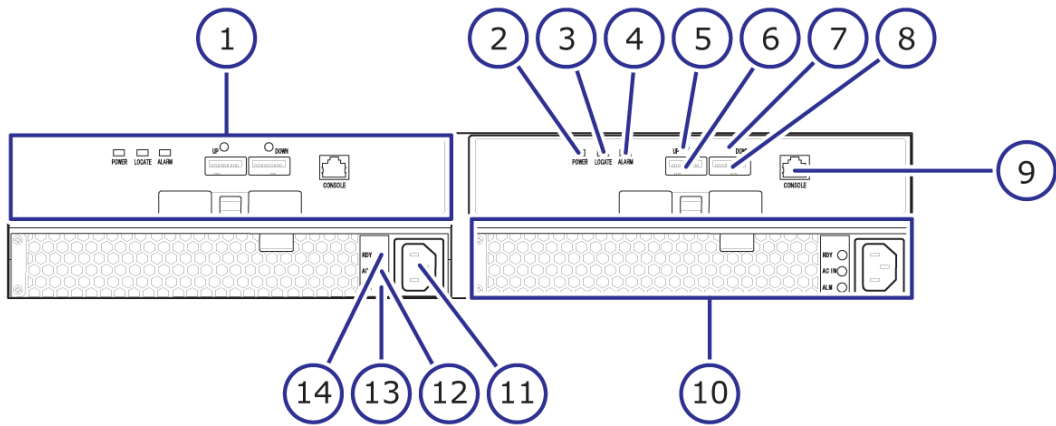

Number	Item	Color	Pattern	Description
1	ENC	-	-	Controller board
2	POWER LED	Green	ON	ENC is powered on.
3	LOCATE LED	Amber	Blink	Indicates the location of the chassis. Can turn on or off by the maintenance utility.
4	ALARM LED	Red	ON	ENC stopped due to a failure and can be replaced.
5	PATH (IN) LED	Blue	ON	IN side port is linked up.
6	PATH (IN) connect or	-	-	Port connects to a controller or drive tray.
7	PATH (OUT) LED	Blue	ON	OUT side port is linked up.
8	PATH (OUT) connect or	-	-	Connects to a drive tray.
9	Console	-	-	This port is reserved.
10	Power supply unit	-	-	Power supply unit
11	Receptacle	-	-	Connects to the power cable provided with the storage system.
12	AC IN LED	Green	ON	Drive tray is under normal operation.
13	ALM LED	Red	ON	Power supply unit stopped due to a failure and can be replaced.
14	RDY LED	Green	ON	Power supply unit is under normal operation.

## Large form-factor drive tray (DBL)

The following tables provide information about the DBL drive tray specifications and supported configurations for VSP G130 storage system.

Name	Model number	Height	Number of drive slots	Supported drive type
DBL	DW-F800-DBLC	2U (88.2 mm)	12	3.5 inch (LFF)

### Physical specifications

Item	Specification
Physical dimension (W x D x H) (mm)	482 × 565 × 88.2 mm
Weight/Mass (kg) (Approximate)	17.4 kg
Start-up time (min) <sup>1</sup>	5 to 8 (min)
Height (EIA unit) <sup>2</sup>	2U
Heat output (W)	124 W
Power consumption (VA)	144 VA
Air flow (m <sup>3</sup> /min) <sup>3</sup>	2.2 (m <sup>3</sup> /min)
<b>Notes:</b> <ol style="list-style-type: none"> <li>1. Start-up times might be longer depending on the number of drive trays connected. With a maximum configuration 1 controller chassis and 7 drive trays, start-up time is approximately 8 minutes.</li> <li>2. Can be mounted on the Hitachi Universal V2 rack. For the mounting, special rails for the rack and decoration panels are required separately depending on the number of the mounted storage systems.</li> <li>3. Value shown is the maximum value.</li> </ol>	

**Supported drive type**

Item	Specification	
Drive form-factor	3.5-inch HDD	
Supported data capacity	5874.22, 9790.36 GB	
Maximum mountable quantity (unit) <sup>1</sup>	12 (total per chassis)	96 (maximum per system)
Maximum number of spare drives <sup>2</sup>	16	
<b>Note:</b>		
<ol style="list-style-type: none"> <li>1. When mounting storage system and DBL drive trays, the maximum mountable quantity may vary.</li> <li>2. Available as spare or data disks.</li> </ol>		

**DBL component LEDs**

The following table lists the definitions of the DBL drive tray front bezel LEDs.

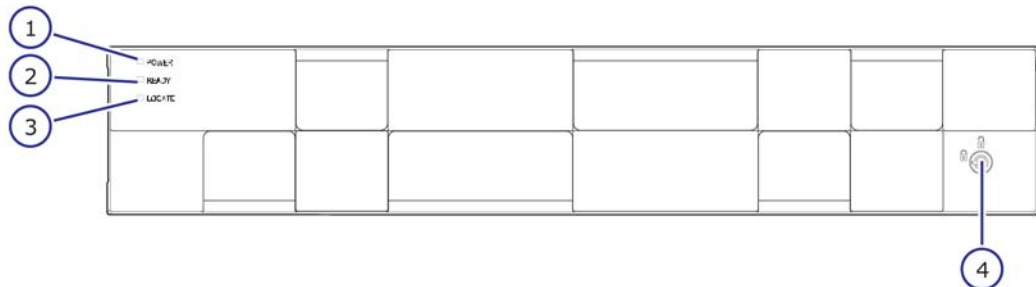

Number	Item	Color	Pattern	Description
1	POWER LED	Green	ON	Drive tray is powered on.
2	READY LED	Green	ON	Drive tray is ready for normal operation.
3	Locate LED	Amber	Blink	Indicates the location of the chassis. Can be turned on or turned off by the maintenance utility.
4	Lock	-	-	Locks or unlocks the front panel bezel by using the supplied key.



The following table lists the definitions of the DBL drive tray front LEDs without an attached bezel.

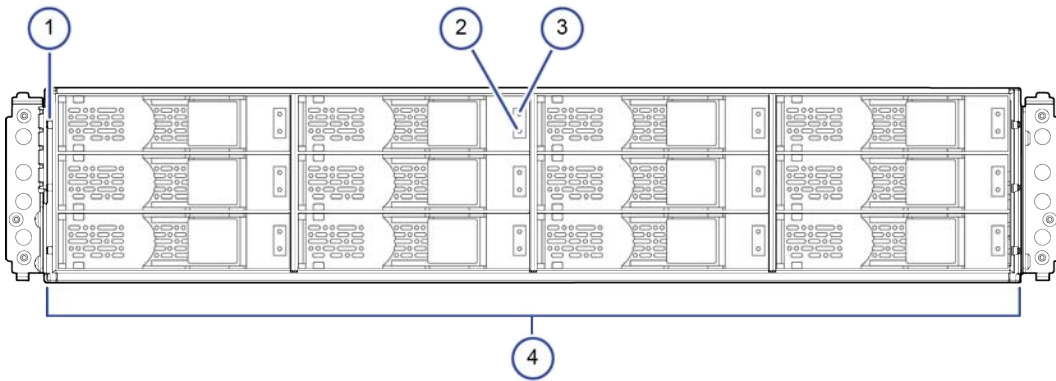

Number	Item	Color	Pattern	Description												
1	POWER, READY, and, LOCATE LEDs	Green	ON	Drive tray is powered on. Drive tray is under normal operation.												
		Amber	Blink	Indicates the location of the chassis. Can be turned on or turned off by the maintenance utility.												
2	ACT LED	Green	ON	Drive tray is under normal operation.												
			Blink	Drive is being accessed.												
3	ALM LED	Red	ON	Drive stopped due to a failure and can be replaced.												
4	LFF drive slots	-	-	Twelve 3.5-inch large form factor drives are positioned horizontally. The slots are organized in the following order: <table border="1" style="margin-left: 20px;"> <tr> <td>8</td> <td>9</td> <td>10</td> <td>11</td> </tr> <tr> <td>4</td> <td>5</td> <td>6</td> <td>7</td> </tr> <tr> <td>0</td> <td>1</td> <td>2</td> <td>3</td> </tr> </table>	8	9	10	11	4	5	6	7	0	1	2	3
8	9	10	11													
4	5	6	7													
0	1	2	3													

The following table lists the definitions of the DBL drive tray rear panel components and LEDs.

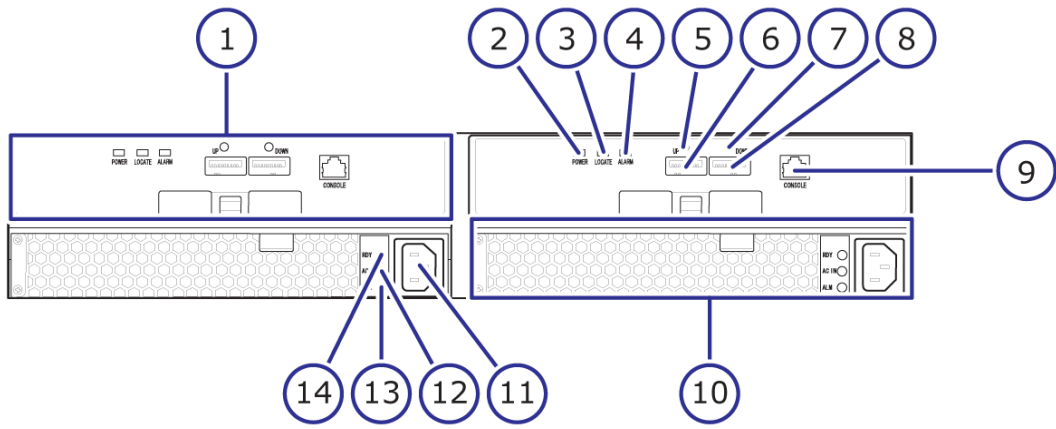

Number	Item	Color	Pattern	Description
1	ENC	-	-	Controller board
2	POWER LED	Green	ON	ENC is powered on.
3	LOCATE LED	Amber	Blink	Indicates the location of the chassis. Can turn on or off by the maintenance utility.
4	ALARM LED	Red	ON	ENC stopped due to a failure and can be replaced.
5	PATH (IN) LED	Blue	ON	IN side port is linked up.
6	PATH (IN) connect or	-	-	Port connects to a controller or drive tray.
7	PATH (OUT) LED	Blue	ON	OUT side port is linked up.
8	PATH (OUT) connect or	-	-	Connects to a drive tray.
9	Console	-	-	This port is reserved.
10	Power supply unit	-	-	Power supply unit
11	Receptacle	-	-	Connects to the power cable provided with the storage system.
12	AC IN LED	Green	ON	Drive tray is under normal operation.
13	ALM LED	Red	ON	Power supply unit stopped due to a failure and can be replaced.
14	RDY LED	Green	ON	Power supply unit is under normal operation.

## Service Processor

The VSP G130 include an optional, separate 1U service processor (SVP) dedicated to host an element manager (Storage Navigator). The SVP operates independently from the CPU of the storage system and operating system, and provides out-of-band configuration and management of the storage system. The SVP also monitors and collects performance data for key components of the storage system to enable diagnostic testing and analysis for customer support.

The SVP provides four RJ-45 ports:

- Two ports connect to the storage system controllers (one port for each controller).
- One port connects to the IP network of the user.
- One port connects to a user-supplied management console PC.



**Note:** This product is also designed for IT power distribution systems with phase-to-phase voltage.

Three of the four RJ-45 ports (which connect to the controllers and the IP network) are configured as a bridge. The SVP can be addressed using the default IP address 192.168.0.15.

In the unlikely event you cannot connect to the SVP using the default IP address, use the following emergency login: `http://<default SVP IP address>/dev/storage/<model number><system serial number>/emergency.do`. For example:

Storage system model number	Storage system serial number	URL
8320004	456789	<code>http://192.168.0.15/dev/storage/8320004456789/emergency.do</code>
8340004	456789	<code>http://192.168.0.15/dev/storage/8340004456789/emergency.do</code>
8360004	456789	<code>http://192.168.0.15/dev/storage/8360004456789/emergency.do</code>

Users are responsible for adopting the appropriate security procedures with the SVP:

- Applying Windows security patches.
- Turning on automatic Windows updates or using the manual Windows update method.
- Installing antivirus software that has been tested and approved by Hitachi.

## SVP specifications

The following table lists the hardware specifications for the service processor (Windows 10 IoT Enterprise) provided by Hitachi Vantara.

Item	Specification
Dimensions	Height: 1.7 inches (43 mm) Width: 17.2 inches (437 mm) Depth: 9.8 inches (249 mm) Weight: 10 lbs (4.5 kg)
Processor	Intel N3710 Pentium processor 4C/4 threads 1.6 GHz 2M cache, 6W
Memory	2 x 4 GB DDR3 1600MHz
Storage media	1 TB 5400 RPM SATA HDD
LAN/Network interface card	1-GbE x 4 ports (on-board NIC) x1 IPMI (BMC) port
Fans	2 x 4028 mm 13KPRM 4-pin PWM fans
Operating system	Windows 10 Enterprise
Maximum temperature	Up to 40° C (104° Fahrenheit)  The SVP is supported in high-temperature environments. Do not operate in any location with temperatures above 40°C (104° Fahrenheit).

## SVP front panel

The front panel of the physical SVP with Windows 10 Enterprise operating system is equipped with LEDs, a reset button, and a power button.

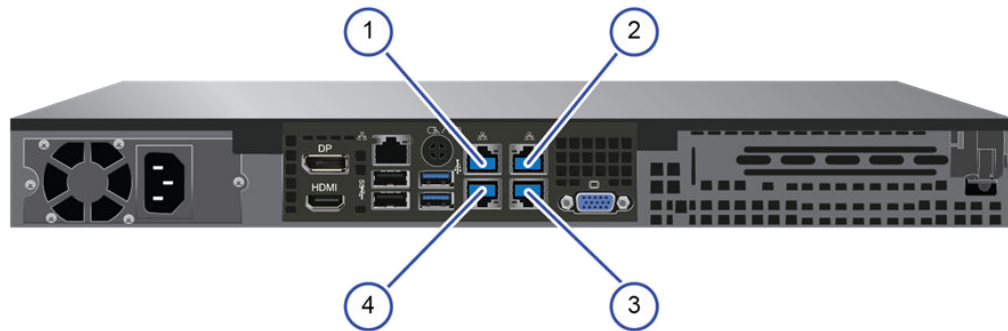

**Table 2 SVP (Windows 10 Enterprise) front panel**

Item	Description
1	LED (Left to Right): <ul style="list-style-type: none"> <li>▪ N/A</li> <li>▪ LAN card 2</li> <li>▪ LAN card 1</li> <li>▪ Hard drive</li> <li>▪ System standby power</li> </ul>
2	Reset button
3	Power button

## SVP rear panel

The only ports used at the rear panel of the physical SVP are the power socket and the four LAN ports. The following ports connect to your IP network, the management console PC, and the user LAN port on each storage system controller.

**Table 3 SVP (Windows 10 Enterprise) rear panel**

Item	Description
1	Management (DKC CTL1) - LAN3 port
2	Management (DKC CTL2) - LAN4 port
3	Maintenance - LAN2 port
4	Management (User) - LAN1 port



**Note:** The SVP running Windows 10 operating system does not provide an option to disable Spanning Tree Protocol (STP). If your network has BPDU enabled to prevent loops, connect the user LAN port on controllers 1 and 2 to an Ethernet switch that is also connected to the LAN1 port on the SVP.



**Note:** After the Initial Startup Wizard is complete, the SVP can be used in non-bridge mode. In this mode, the cables can be removed from SVP ports LAN3 and LAN4 and attached to switches. For more information, contact customer support.

## Chapter 3: Parts list

The VSP G130 storage system includes the following base and optional components.

### Components list

The following tables list the base and optional components available to the storage system.

**Table 4 CBSS controller components**

Model number	Part description	Quantity
DW800-CBSS	2U chassis	1
	AC power supply unit	2
	Front bezel (2U)	1
	Binder (two types)	4
	SAS cable label	2
	Key	2
DW-F800-RRCB	Rail kit	1

**Table 5 CBSS optional controller components**

Model number	Part description	Quantity
DW-F850-CTLXSFA	Controller board (FC 16-Gbps)	2
DKC-F810I-600JCMC	600 GB, 2.5-inch, 10kmin, 12 Gbps, SAS drive	0-24
DKC-F810I-1R2JCMC	1.2 TB, 2.5-inch, 10kmin, 12 Gbps, SAS drive	0-24
DKC-F810I-2R4JGM	2.4 TB, 2.5-inch, 10kmin, 12 Gbps, SAS, drive	0-24



**Table 6 CBSL controller components**

Model number	Part description	Quantity
DW800-CBSL	2U chassis	1
	AC power supply unit	2
	Front bezel (2U)	1
	Binder (two types)	4
	SAS cable label	2
	Key	2
DW-F800-RRCB	Rail kit	1

**Table 7 CBSL optional controller components**

Model number	Part description	Quantity
DW-F850-CTLXSFA	Controller board (FC 16-Gbps)	2
DKC-F810I-6R0H9M	6 TB, 3.5-inch, 7.2kmin, 12 Gbps SAS drive	0-12
DKC-F810I-10RH9M	10 TB, 3.5-inch, 7.2kmin, 12 Gbps SAS drive	0-12

**Table 8 DBS drive tray components**

Model number	Part description	Quantity
DW-F800-DBSC	2U chassis	1
	ENC	2
	AC power supply unit	2
	Front bezel (2U)	1
	Repeat binder (two types)	4
	Omega clip	4
	Bracket (L)	1
	Bracket (R)	1
	Side bezel (L)	1
	Side bezel (R)	1
	Key	2
DW-F800-RRDB	Rail kit	1

**Table 9 DBS optional drive tray components**

Model number	Part description	Quantity
DKC-F810I-600JCMC	600 GB, 2.5-inch, 10kmin, 12 Gbps, SAS drive	0-24
DKC-F810I-1R2JCMC	1.2 TB, 2.5-inch, 10kmin, 12 Gbps, SAS drive	0-24
DKC-F810I-2R4JGM	2.4 TB, 2.5-inch, 10kmin, 12 Gbps, SAS, drive	0-24

**Table 10 DBL drive tray components**

Model number	Part description	Quantity
DW-F800-DBLC	2U chassis	1
	ENC	2
	AC Power supply unit	2
	Front bezel (2U)	1
	Repeat binder (two types)	4
	Omega clip	4
	Bracket (L)	1
	Bracket (R)	1
	Side bezel (L)	1
	Side bezel (R)	1
	Key	2
DW-F800-RRDB	Rail kit	1

**Table 11 DBL optional drive tray components**

Model number	Part description	Quantity
DKC-F810I-6R0H9M	6 TB, 3.5-inch, 7.2kmin, 12 Gbps SAS drive	0-12
DKC-F810I-10RH9M	10 TB, 3.5-inch, 7.2kmin, 12 Gbps SAS drive	0-12

**Table 12 Optional service processor**

Model number	Part description	Quantity
HDW2-F850-SVP.P	Service processor (Windows 10 IoT Enterprise)	1

## Data and power cable model list

The following tables list the data and power cables available to the storage system.

**Table 13 Power cables**

<b>Model number</b>	<b>Specification</b>
DW-F800-J1K	2.5 m, 2-pole power cable with grounding terminal (AC 125 V, 13 A or 15 A)
DW-F800-J2H	2.5 m, 2-pole power cable with grounding terminal (AC 250 V, 13 A or 15 A)
DW-F800-J2H5	5.0 m, 2-pole power cable with grounding terminal (AC 250 V, 13 A or 15 A)
DW-F800-J2H10	10.0 m, 2-pole power cable with grounding terminal (AC 250 V, 13 A or 15 A)
A-F6516-P620	Power cable for PDU (1)
A-F6516-P630	Power cable for PDU (1)

**Table 14 SAS cables**

<b>Model number</b>	<b>Specification</b>
DW-F800-SCQ1	1 m SAS cable, including omega clip (2)
DW-F800-SCQ1F	1.5 m SAS cable, including omega clips (2)
DW-F800-SCQ3	3 m SAS cable, including omega clips (2)
DW-F800-SCQ5	5 m SAS cable, including omega clips (2)
DW-F800-SCQ10A	10 m SAS optical cable
DW-F800-SCQ30A	30 m SAS optical cable
DW-F800-SCQ1HA	100 m SAS optical cable

**Table 15 Optical cables**

<b>Model number</b>	<b>Specification</b>
A-6515-GM5L	5 m LC-LC optical cable for optical
A-6515-GM10L	10 m LC-LC optical cable for optical
A-6515-GM20L	20 m LC-LC optical cable for optical
A-6515-GM30L	30 m LC-LC optical cable for optical
A-6515-GM40L	40 m LC-LC optical cable for optical
A-6515-GM50L	50 m LC-LC optical cable for optical
A-6515-GM1JL	100 m LC-LC optical cable for optical
A-6515-GS10L	10 m LC-LC optical cable for optical
A-6515-GS20L	20 m LC-LC optical cable for optical
A-6515-GS30L	30 m LC-LC optical cable for optical
A-6515-GS50L	50 m LC-LC optical cable for optical
A-6515-GS1JL	100 m LC-LC optical cable for optical
A-6515-HM5L	5 m LC-LC optical cable for optical
A-6515-HM10L	10 m LC-LC optical cable for optical
A-6515-HM20L	20 m LC-LC optical cable for optical
A-6515-HM30L	30 m LC-LC optical cable for optical
A-6515-HM50L	50 m LC-LC optical cable for optical
A-6515-HM100L	100 m LC-LC optical cable for optical
A-6515-HM200L	200 m LC-LC optical cable for optical
A-6515-HM300L	300 m LC-LC optical cable for optical
A-6515-JM5L	5 m LC-LC optical cable for optical
A-6515-JM10L	10 m LC-LC optical cable for optical
A-6515-JM20L	20 m LC-LC optical cable for optical
A-6515-JM30L	30 m LC-LC optical cable for optical
A-6515-JM50L	50 m LC-LC optical cable for optical
A-6515-JM100L	100 m LC-LC optical cable for optical
A-6515-JM200L	200 m LC-LC optical cable for optical

Model number	Specification
A-6515-JM300L	300 m LC-LC optical cable for optical

---

## Chapter 4: Operational and maintenance considerations

Proper operation and ongoing required maintenance continues the reliability of the storage system and its constant availability to all connecting hosts.

### Network access

External Fibre Channel or Ethernet cable connections are completed at the time of installation.

These connections are required to:

- Establish connections from the controllers to the host computers.
- Connect the storage system to the network, enabling storage system management through Hitachi Command Suite or Hitachi Storage Advisor.
- Allow communication to the storage system from the SVP.

### TCP/IP port assignments

When you install your storage system, default ports must be opened to allow for incoming and outgoing requests.

Review the following ports before you install the storage system to avoid conflicts between the TCP/IP port assignments used by the storage system and those used by other devices and applications.

Port number	Usage description
80	Used by the SVP, Hitachi Storage Advisor, and Device Manager - Storage Navigator to communicate through the HTTP protocol.
161	UDP (SNMP uses this port to send traps from the storage system) .
427	Used by SMI-S.
1099	Used by Hitachi Command Suite products JAVA RMI Registry server.
2000	TCP (Device Manager - Storage Navigator: Nonsecure) Cisco Skinny Client Control Protocol (SCCP) uses port 2000 for TCP. If you use Device Manager - Storage Navigator in a network with SCCP, change the TCP port that Device Manager - Storage Navigator uses (refer to the Device Manager - Storage Navigator online help).
5989	Used by SMI-S.
10995	TCP Device Manager - Storage Navigator and Hitachi suite components)
23015	Used for Web browser communications.
23016	Used for Web browser communications via SSL.
28355	TCP (Device Manager - Storage Navigator: Secure)
31001	Used for communication by Hitachi Command Control Interface (CCI) data collection procedures.
34001	Used by RAID Manager.
51099	Used by Device Manager - Storage Navigator for communication.
51100	Used by Device Manager - Storage Navigator for communication.



The following table shows the port number key name for outbound communication between the client PC and SVP.



**Note:** Refer to the following table for port number assignments if the storage system is using a physical service processor.

Port number key name (Windows Firewall Inbound name)	Protocol	Initial value of port number	Can the port be closed?	SVP software version
MAPPWebServer	HTTP	80	Yes	88-02-0x -xx/00 or later
MAPPWebServerHttps	HTTPS	443	No	
RMIClassLoader	RMI	51099	No	
RMIClassLoaderHttps	RMI (SSL)	5443	No	
RMIIFRegist	RMI	1099	No	
PreRMIServer	RMI	51100-51355 <sup>1</sup>	No	
		Automatic allocation		
DKCManPrivate	RMI	11099	N/A	88-02-0x -xx/00 or later
SMI-S (SLP)	SLP	427	Yes, only if SMI-S is not used.	88-02-0x -xx/00 or later
SMIS_CIMOM	SMI-S	5989-6244 <sup>1</sup>	Yes, only if SMI-S is not used.	
		Automatic allocation		
CommonJettyStart	HTTP	8080	N/A	88-02-0x -xx/00 or later
CommonJettyStop	HTTP	8210	N/A	
RestAPIServerStop	HTTP	9210	N/A	
DeviceJettyStart	HTTP	8081	N/A	

Port number key name (Windows Firewall Inbound name)	Protocol	Initial value of port number	Can the port be closed?	SVP software version
		Automatic allocation		88-02-0x -xx/00 or later
DeviceJettyStop	HTTP	8211	N/A	88-02-0x -xx/00 or later
		Automatic allocation		88-02-0x -xx/00 or later
Hi-Track	HTTPS, FTP (SSL)	4431	Yes, only if Hi-Track is not used.	88-02-0x -xx/00 or later



**Note:** Hitachi Command Suite has additional port considerations. For more information, refer to the *Hitachi Command Suite Administrator Guide*.

## Controller connections

The controllers provide the ports that are required to connect to an optional SVP, external drive trays, systems, and other devices.

A controller contains Fibre Channel ports. The number and type of ports available for host connections vary based on the controller model.

- Fibre Channel SFP adapters are used to connect to your Fibre Channel switch and hosts.

Each controller also has:

- A SAS port for connection to an external drive tray.
- An RJ-45 10/100/1000 bps user LAN port for performing management activities.
- An RJ-45 10/100/1000 bps maintenance LAN port for diagnostics.

## Physical service processor connections

The SVP is available as an optional, physical device provided by Hitachi Vantara or as a virtual guest host running on customer-provided ESX servers and VM/OS licenses and media. The SVP provides error detection and reporting and supports diagnostic and maintenance activities involving the storage system.

In a VSP G130 configuration, both the storage system and the SVP reside on the same private network segment of your local-area network (LAN). The management console PC used to administer the system must also reside on the same private network segment.

Physical SVP connectivity requires all of the following:

- A static IP address for the SVP that is on the same network segment as the storage system.
- One Ethernet connection from each controller to separate LAN ports on the SVP.
- One Ethernet connection to your network switch.
- At least one management console PC on the same network segment as the SVP and storage system.



**Note:** The SVP running Windows 10 operating system does not provide a way to disable Spanning Tree Protocol (STP). If your network has BPDU enabled to prevent loops, connect the user LAN port on controllers 1 and 2 to an Ethernet switch instead of connecting them to SVP LAN 3 and LAN 4 ports.

Virtual SVP connectivity requires all of the following:

#### ESX Server

- VMware ESXi server 6.x
- 2 quad core processors, Intel Xeon 2.29 GHz
- 1-port NIC
- SVP guest OS (2 DKCs)
- 32 GB RAM

#### SVP Guest OS (1 DKC)

- Windows 10 IoT Enterprise
- 2 x vCPU
- 1 virtual network adapter
- 4 GB RAM
- 120 GB disk space

## Powering off the storage system

### Procedure

1. Press the main switch on the controller chassis for approximately three seconds until the `POWER` LED on the front of the chassis changes from solid green to a blinking status.
2. Release the main switch and the `POWER` LED returns to solid green after blinking for approximately three seconds.  
The power-off process begins. The process takes approximately 18 minutes or longer depending on the amount of data that needs to be written. The `POWER` LED is solid green during the powering off process. The `POWER` LED changes from green to amber when the process is completed.

3. Verify the `POWER` LED on the front of the storage system changes from green to amber.
4. To stop the power supply, remove the power cables from the power supply units on the controller chassis and drive box.

If the storage system is connected to a PDU, you can stop the power supply by turning off the PDU breaker.



**Note:** If the storage system does not receive power for more than six months, the battery can become discharged and possibly damaged. To avoid this situation, charge the battery for more than three hours at least once every six months.

## Storing the storage system

If the storage system does not receive power for more than six months, the battery can become discharged and possibly damaged. To avoid this situation, charge the battery for more than three hours at least once every six months.



**Note:** Do not store the equipment in an environment with temperatures of 104°F (40°C) or higher because battery life will be shortened.

---

## Appendix A: Environmental notices

### Disposal



This symbol on the product or on its packaging means that your electrical and electronic equipment should be disposed at the end of life separately from your household wastes.

There are separate collection systems for recycling in the European Union. For more information, contact the local authority or the dealer where you purchased the product.

### Recycling

A nickel-metal hydride battery is used in the Cache Backup Battery.

A nickel-metal hydride battery is a resource that can be recycled. When you want to replace the Cache Backup Battery, call the service personnel. They will dispose of it for you. This nickel-metal hydride battery, which is designated as recycling product by a recycling promotion law, must be recycled.

The mark posted on the Cache Backup Battery is a three-arrow mark that indicates a recyclable part.



---

## Appendix B: Regulatory compliance

This equipment has been tested and certified for compliance with the following standards.

## Country Specifications and Certifications

Standard	Specification	Product marking or logo	Country regulation
Electronic emission controls	FCC part 15 Sub B: 2016	FCC	USA and Canada
	ICES-003 Issue 6: 2016	ICES-003	USA and Canada
	AS/NZS CISPR 22: 2009+A1	RCM	Australia and New Zealand
	TP TC 020/2011	EAC	Russia, Belarus, and Kazakhstan
	CNS 13438	BSMI	Taiwan
	KN32	KC	Korea
	KN35		
Electronic emission certifications	EN55022: 2010	CE marking	EU
	EN55024: 2010		
	EN61000-3-2:2006+A1+A2		
	EN61000-3-3:2013		
Safety certifications	UL and CSA 60950-1:2007	cTuVus	United States of America and Canada
	EN60950-1:2006+A1 1+A1+A12+A2	TUV	Germany
	IEC60950-1:2005+A 1+A2	N/A	All CB countries
	IEC60950-1:2005+A 1+A2	S_Mark	Argentina
	TP TC 004/2011	EAC	Russia
	CNS 14336-1	BSMI	Taiwan
	EN60950-1:2006+A1 1+A1+A12+A2	CE marking	EU
	Radio interference voluntary control	VCCI V-3/2015.4	VCCI

**FDA radiation regulation**

The array complies with FDA radiation performance standard 21 CFR subchapter J.

**EMI regulation**

This equipment has been tested and found to comply with the limits for a Class A digital device, pursuant to Part 15 of the FCC Rules. These limits are designed to provide reasonable protection against harmful interference when the equipment is operated in a commercial environment. This equipment generates, uses, and can radiate radio frequency energy and, if not installed and used in accordance with the instruction manual, may cause harmful interference in which case the user will be required to correct the interference at his own expense. Testing was done with shielded cables. Therefore, in order to comply with the FCC regulations, you must use shielded cables with your installation.

This product must not be used in residential areas.

This is a class A product. In a domestic environment this product can cause radio interference in which case the user can be required to take adequate measures.



