

# Hitachi Virtual Storage Platform F800

83-05-2x

---

## Hardware Reference Guide

This document provides information about the system hardware components, mechanical, and environmental specifications for the VSP F800 storage system.

© 2015, 2018 Hitachi, Ltd. All rights reserved.

No part of this publication may be reproduced or transmitted in any form or by any means, electronic or mechanical, including copying and recording, or stored in a database or retrieval system for commercial purposes without the express written permission of Hitachi, Ltd., or Hitachi Vantara Corporation (collectively "Hitachi"). Licensee may make copies of the Materials provided that any such copy is: (i) created as an essential step in utilization of the Software as licensed and is used in no other manner; or (ii) used for archival purposes. Licensee may not make any other copies of the Materials. "Materials" mean text, data, photographs, graphics, audio, video and documents.

Hitachi reserves the right to make changes to this Material at any time without notice and assumes no responsibility for its use. The Materials contain the most current information available at the time of publication.

Some of the features described in the Materials might not be currently available. Refer to the most recent product announcement for information about feature and product availability, or contact Hitachi Vantara Corporation at [https://support.hitachivantara.com/en\\_us/contact-us.html](https://support.hitachivantara.com/en_us/contact-us.html).

**Notice:** Hitachi products and services can be ordered only under the terms and conditions of the applicable Hitachi agreements. The use of Hitachi products is governed by the terms of your agreements with Hitachi Vantara Corporation.

By using this software, you agree that you are responsible for:

1. Acquiring the relevant consents as may be required under local privacy laws or otherwise from authorized employees and other individuals; and
2. Verifying that your data continues to be held, retrieved, deleted, or otherwise processed in accordance with relevant laws.

**Notice on Export Controls.** The technical data and technology inherent in this Document may be subject to U.S. export control laws, including the U.S. Export Administration Act and its associated regulations, and may be subject to export or import regulations in other countries. Reader agrees to comply strictly with all such regulations and acknowledges that Reader has the responsibility to obtain licenses to export, re-export, or import the Document and any Compliant Products.

Hitachi is a registered trademark of Hitachi, Ltd., in the United States and other countries.

AIX, AS/400e, DB2, Domino, DS6000, DS8000, Enterprise Storage Server, eServer, FICON, FlashCopy, IBM, Lotus, MVS, OS/390, PowerPC, RS/6000, S/390, System z9, System z10, Tivoli, z/OS, z9, z10, z13, z/VM, and z/VSE are registered trademarks or trademarks of International Business Machines Corporation.

Active Directory, ActiveX, Bing, Excel, Hyper-V, Internet Explorer, the Internet Explorer logo, Microsoft, the Microsoft Corporate Logo, MS-DOS, Outlook, PowerPoint, SharePoint, Silverlight, SmartScreen, SQL Server, Visual Basic, Visual C++, Visual Studio, Windows, the Windows logo, Windows Azure, Windows PowerShell, Windows Server, the Windows start button, and Windows Vista are registered trademarks or trademarks of Microsoft Corporation. Microsoft product screen shots are reprinted with permission from Microsoft Corporation.

iPad is a trademark of Apple Inc., registered in the U.S. and other countries.

All other trademarks, service marks, and company names in this document or website are properties of their respective owners.

---

# Contents

<b>Preface</b> .....	<b>7</b>
Intended audience.....	7
Product version.....	7
Release notes.....	7
Changes in this revision.....	7
Document conventions.....	7
Conventions for storage capacity values.....	9
Accessing product documentation.....	10
Getting help.....	10
Comments.....	10
<b>Chapter 1: Hitachi Virtual Storage Platform F800 hardware overview</b> .....	<b>11</b>
Block configuration.....	11
Unified configuration.....	12
VSP F800 model.....	12
Features.....	14
Scalability.....	14
Examples of supported VSP F800 configurations.....	14
Maximum number of mounted drive trays.....	15
<b>Chapter 2: Virtual Storage Platform F800 controller</b> .....	<b>16</b>
CBLH controller.....	16
CBLH with front panel bezel.....	16
CBLH front panel LEDs (without bezel).....	17
CBLH rear panel.....	19
CBLH power supply unit LEDs and connectors.....	21
Host, Network, and Drive Tray Ports and LEDs.....	21
Front end module descriptions.....	22

10-Gbps iSCSI board LEDs and connectors (optical).....	22
10-Gbps iSCSI board LEDs and connectors (copper).....	22
8-Gbps, 16-Gbps, or 32-Gbps Fibre Channel (4-port) board LEDs and connectors.....	24
16-Gbps Fibre Channel (2-port) board LEDs and connectors.....	26
LAN blade LEDs and connectors.....	28
Back end module LEDs and connectors.....	28
<b>Chapter 3: Drive trays.....</b>	<b>30</b>
Small form-factor drive tray (DBS).....	30
SFF with front panel bezel.....	30
SFF front panel without bezel.....	31
SFF rear panel.....	32
SFF and LFF AC power supply unit LEDs and connectors.....	33
SFF power supply unit LEDs and connectors.....	34
Flash module drive tray (DBF).....	34
FMD with front panel bezel.....	35
FMD front panel without bezel.....	36
FMD rear panel.....	37
<b>Chapter 4: Host port expansion chassis.....</b>	<b>39</b>
Host port expansion chassis front panel bezel LEDs.....	39
PCIe switchboard.....	39
Host port expansion chassis fan.....	40
PCIe cable connector.....	41
Host port expansion chassis power supply.....	42
<b>Chapter 5: NAS module.....</b>	<b>44</b>
NAS Module Ports and LEDs.....	44
<b>Chapter 6: Service processor.....</b>	<b>46</b>
Service processor hardware specifications.....	46
Service processor description.....	47
SVP front panel.....	48
SVP rear panel.....	49

<b>Chapter 7: Maintaining the storage system.....</b>	<b>50</b>
Storing the storage system.....	50
Powering off the storage system.....	50
<b>Appendix A: Mechanical specifications for VSP F800.....</b>	<b>51</b>
VSP F800 mechanical specifications.....	51
<b>Appendix B: Electrical specifications for VSP F800.....</b>	<b>60</b>
Electrical specifications.....	60
<b>Appendix C: Environmental specifications for VSP F800.....</b>	<b>61</b>
Environmental specifications.....	61
<b>Appendix D: iSCSI standards and specifications.....</b>	<b>64</b>
iSCSI standards.....	64
iSCSI specifications.....	64
<b>Appendix E: Replacement parts.....</b>	<b>69</b>
Battery unit.....	69
<b>Appendix F: Data and power cables.....</b>	<b>70</b>
Required cables.....	70
Fibre Channel cables.....	73
iSCSI cables.....	77
iSCSI standards.....	80
iSCSI specifications.....	80
Managing data cables.....	83
Cable retention.....	85
AC power cables.....	86
Power cable assemblies.....	86
AC connections.....	88
Power cable usage guidelines.....	90
Three-phase power considerations for racks.....	90
Cable management.....	90
Cable retention.....	90
Data and power cable model list.....	91

<b>Appendix G: Port address mapping.....</b>	<b>95</b>
Port address mapping.....	95
<b>Appendix H: Third-party racks.....</b>	<b>96</b>
Third-party rack support .....	96
Hitachi Universal V2 Rack rail kits.....	96
Hitachi Universal V2 Rack accessories.....	97
Third-party rack support for DB60 dense intermix drive trays.....	97
<b>Appendix I: Power distribution units for Hitachi Universal V2 Rack .....</b>	<b>99</b>
Americas single-phase PDU 1P30A-8C13-3C19UL.P.....	99
Americas single-phase PDU 1P30A-15C13-3C19UL.P.....	100
Americas three-phase PDU 3P30A-8C13-3C19UL.P.....	100
Americas three-phase PDU 3P30A-15C13-3C19UL.P.....	101
Americas three-phase PDU 3P30A-24C13-6C19UL.P.....	102
APAC and EMEA single-phase PDU 1P32A-9C13-3C19CE.P.....	103
APAC and EMEA single-phase PDU 1P32A-18C13-3C19CE.P.....	104
APAC and EMEA three-phase PDU 3P16A-9C13-3C19CE.P.....	105
APAC and EMEA three-phase PDU 3P16A-15C13-3C19CE.P.....	106
APAC and EMEA three-phase PDU 3P32A-24C13-6C19CE.P.....	107
<b>Appendix J: Regulatory compliance.....</b>	<b>109</b>
<b>Appendix K: Safety and environmental notices.....</b>	<b>111</b>
<b>Index.....</b>	<b>113</b>

---

## Preface

This guide describes the hardware features and specifications of the Hitachi Virtual Storage Platform F800 all-flash array.

### Intended audience

This document is intended for customers inquiring about the features and specifications of the storage system.

Readers of this document should be familiar with the following:

- Data processing and RAID storage systems and their basic functions.
- The operating system and web browser software on the system hosting the storage management software.

### Product version

This document revision applies to the following product versions:

- VSP F800 firmware 83-05-2x or later
- Hitachi Storage Virtualization Operating System (SVOS) 7.4.0 or later
- Hitachi NAS firmware version 13.1 or later

### Release notes

Read the release notes before installing and using this product. They may contain requirements or restrictions that are not fully described in this document or updates or corrections to this document. Release notes are available on Hitachi Vantara Support Connect: <https://knowledge.hitachivantara.com/Documents>.

### Changes in this revision

- Added support for new 7.6 TB SSD.

### Document conventions



This document uses the following typographic conventions:

Convention	Description
<b>Bold</b>	<ul style="list-style-type: none"> <li>Indicates text in a window, including window titles, menus, menu options, buttons, fields, and labels. Example: Click <b>OK</b>.</li> <li>Indicates emphasized words in list items.</li> </ul>
<i>Italic</i>	<ul style="list-style-type: none"> <li>Indicates a document title or emphasized words in text.</li> <li>Indicates a variable, which is a placeholder for actual text provided by the user or for output by the system. Example: <pre>pairdisplay -g group</pre> (For exceptions to this convention for variables, see the entry for angle brackets.)</li> </ul>
Monospace	Indicates text that is displayed on screen or entered by the user. Example: <code>pairdisplay -g oradb</code>
< > angle brackets	Indicates variables in the following scenarios: <ul style="list-style-type: none"> <li>Variables are not clearly separated from the surrounding text or from other variables. Example: <pre>Status-&lt;report-name&gt;&lt;file-version&gt;.csv</pre></li> <li>Variables in headings.</li> </ul>
[ ] square brackets	Indicates optional values. Example: [ a   b ] indicates that you can choose a, b, or nothing.
{ } braces	Indicates required or expected values. Example: { a   b } indicates that you must choose either a or b.
vertical bar	Indicates that you have a choice between two or more options or arguments. Examples: [ a   b ] indicates that you can choose a, b, or nothing. { a   b } indicates that you must choose either a or b.

This document uses the following icons to draw attention to information:

Icon	Label	Description
	Note	Calls attention to important or additional information.



Icon	Label	Description
	Tip	Provides helpful information, guidelines, or suggestions for performing tasks more effectively.
	Caution	Warns the user of adverse conditions and/or consequences (for example, disruptive operations, data loss, or a system crash).
	WARNING	Warns the user of a hazardous situation which, if not avoided, could result in death or serious injury.

## Conventions for storage capacity values

Physical storage capacity values (for example, disk drive capacity) are calculated based on the following values:

Physical capacity unit	Value
1 kilobyte (KB)	1,000 ( $10^3$ ) bytes
1 megabyte (MB)	1,000 KB or $1,000^2$ bytes
1 gigabyte (GB)	1,000 MB or $1,000^3$ bytes
1 terabyte (TB)	1,000 GB or $1,000^4$ bytes
1 petabyte (PB)	1,000 TB or $1,000^5$ bytes
1 exabyte (EB)	1,000 PB or $1,000^6$ bytes

Logical capacity values (for example, logical device capacity, cache memory capacity) are calculated based on the following values:

Logical capacity unit	Value
1 block	512 bytes
1 cylinder	Mainframe: 870 KB Open-systems: <ul style="list-style-type: none"> <li>▪ OPEN-V: 960 KB</li> <li>▪ Others: 720 KB</li> </ul>
1 KB	$1,024 (2^{10})$ bytes

Logical capacity unit	Value
1 MB	1,024 KB or 1,024 <sup>2</sup> bytes
1 GB	1,024 MB or 1,024 <sup>3</sup> bytes
1 TB	1,024 GB or 1,024 <sup>4</sup> bytes
1 PB	1,024 TB or 1,024 <sup>5</sup> bytes
1 EB	1,024 PB or 1,024 <sup>6</sup> bytes

## Accessing product documentation

Product user documentation is available on Hitachi Vantara Support Connect: <https://knowledge.hitachivantara.com/Documents>. Check this site for the most current documentation, including important updates that may have been made after the release of the product.

## Getting help

[Hitachi Vantara Support Connect](#) is the destination for technical support of products and solutions sold by Hitachi Vantara. To contact technical support, log on to Hitachi Vantara Support Connect for contact information: [https://support.hitachivantara.com/en\\_us/contact-us.html](https://support.hitachivantara.com/en_us/contact-us.html).

[Hitachi Vantara Community](#) is a global online community for Hitachi Vantara customers, partners, independent software vendors, employees, and prospects. It is the destination to get answers, discover insights, and make connections. **Join the conversation today!** Go to [community.hitachivantara.com](https://community.hitachivantara.com), register, and complete your profile.

## Comments

Please send us your comments on this document to [doc.comments@hitachivantara.com](mailto:doc.comments@hitachivantara.com). Include the document title and number, including the revision level (for example, -07), and refer to specific sections and paragraphs whenever possible. All comments become the property of Hitachi Vantara Corporation.

**Thank you!**

---

# Chapter 1: Hitachi Virtual Storage Platform F800 hardware overview

The Hitachi Virtual Storage Platform F800 is a modular, rack-mountable all-flash array storage system, with various fixed storage capacity configurations of FMD DC2 flash storage devices. To deliver consistent low latency host response times and highest IOP performance across all host connection ports, hard-disk drives are supported in an all-flash configuration.

The storage system contains dual controllers, each controller contains its own processor, dual in-line cache memory modules (DIMMs), cache flash memory (CFM), battery, fans and iSCSI and Fibre Channel I/O modules. Each controller also has an Ethernet connection for out-of-band management. If the data path through one controller fails, all data drives remain available to data hosts using a redundant data path through the other controller.

The storage system can be equipped with embedded network-attached storage (NAS) modules. The NAS modules provide file access through CIFS and NFS protocols and block access by using iSCSI protocols.

All storage system models allow defective drives to be replaced without the interruption of data availability to hosts. A hot spare drive can be configured to replace a failed drive automatically, securing the fault-tolerant integrity of the logical drives. Self-contained, hardware-based RAID logical drives provide maximum performance in compact external enclosures.

Essential hardware components are implemented with a redundant configuration so that the storage system can remain operational if a component fails. Adding and replacing components, along with firmware upgrades, can be conducted while the storage system is active.

## Block configuration

A storage system configured for block-level storage provides the ability to access and provision raw storage volumes using protocols such as Fibre Channel and iSCSI.

A block configuration consists of the following:

- Two controllers
- One or more drive trays
- Service processor server (SVP)

## Unified configuration

A unified configuration includes embedded NAS modules that support file system protocols such as CIFS and NFS and operate across a block-level setup using iSCSI or FC connections.

- Two controllers
- Two NAS modules for file operations and storage
- One or more drive trays for block-level storage
- One 1U block service processor server (SVP)

## VSP F800 model

The VSP F800 is a highly reliable all-flash system that offers high storage capacity with full redundancy to better protect data and manage storage operations.

The storage system consists of a 4U enclosure that includes two controllers. Drives are supported using drive trays connected to the controllers.

Controller	Controller chassis	Controller model	Height
CBLH	DW800-CBL	DW-F800-CTLH	4U (174.3 mm)

Drive tray	Drive tray model name	Supported drive type	Number of drives supported	Height
FMD tray	DW-F800-DBF	5.25-inch FMD	12	2U (86.2 mm)
SFF drive tray	<ul style="list-style-type: none"> <li>▪ DW-F800-DBS (power supply, contains BNST)</li> <li>▪ DW-F800-DBSC</li> </ul>	2.5-inch SFF	24	2U (86.2 mm)

### High-speed cache memory

The storage system supports 512 GB of high-speed cache memory. The DIMMs are arranged as 128 GB per controller.

### Flash module drives (FMD)

The VSP F800 storage system supports the listed FMD capacities.

Model number	Drive type	Drive capacity
DKC-F810I-1R6FN	FMD DC2	1.6 TiB
DKC-F810I-3R2FN	FMD DC2	3.2 TiB
DKC-F810I-6R4FN	FMD DC2	6.4 TiB
DKC-F810I-7R0FP	FMD HD	7 TB
DKC-F810I-14RFP	FMD HD	14 TB

### Solid-state drives

The VSP F800 storage system supports the listed SSD capacities.

Model number	Drive type	Drive capacity
DKC-F810I-1R9MGM	SSD	1.9 TB
DKC-F810I-3R8MGM	SSD	3.8 TB
DKC-F810I-7R6MGM	SSD	7.6 TB

### Interface ports

Interface ports for attachment to hosts are provided on the front-end modules. The system supports 24 front-end modules.

Model number	Description	Maximum number of ports supported
DW-F800-2HS10S	10-Gbps iSCSI (optical) front-end module	24
DW-F800-2HS10B	10-Gbps iSCSI (copper) front-end module	24
DW-F800-4HF8	8-Gbps Fibre Channel (4-port) front-end module	48
DW-F800-2HF16	16-Gbps Fibre Channel (2-port) front-end module	24
DW-F800-4HF32R	32/16-Gbps Fibre Channel (4-port) front-end module	48

## Features

The features described in the table are included with VSP F800

Feature		Value
Maximum cache memory supported		512 GB
Maximum number of spare drives		64
Maximum number of RAID groups		480
Maximum volume size		3 TB (4 TB when using the LDEVs of other Storage Systems)
Maximum number of volumes per host groups		2,048
Maximum number of volumes per RAID group		2,048
Maximum number of DP pool volumes		4,096
Maximum number of DP pools		64
Maximum number of iSCSI hosts connected through a network switch		255
Maximum number of Fibre Channel devices connected through a Fibre Channel switch		255
Maximum storage system capacity (physical capacity)	Using 7.6 TB SSD	8,711 TB
	Using 14 TB FMD	8,106 TB

## Scalability

All storage systems offer pay-as-you-grow scalability by allowing you to hot-add drives as you need them.

## Examples of supported VSP F800 configurations

The following table lists the maximum number of drive trays and drives supported in a system configuration. A diskless configuration does not include any drive trays.

Drive tray	Maximum number of drive trays supported	Maximum number of drives supported
SFF drive tray	48	1152 SSDs

Drive tray	Maximum number of drive trays supported	Maximum number of drives supported
FMD drive tray	48	576 HAF flash module drives

## Maximum number of mounted drive trays

The following table lists the maximum number of mountable drive trays and mountable drives for each drive type.



**Note:** If a drive is inserted into a slot of a dense intermix drive tray when the installed number of drives exceeds 240 slots per path, the drive is blocked.

VSP F800 controller	Drive trays	Maximum number of trays	Maximum number of drives
CBLH	FMD	48	576 FMDs (HAF)
	FMD	4	40 FMDs + 2 spares (DC2)
			48 FMDs
	SFF	48	1,152 SSDs

## Chapter 2: Virtual Storage Platform F800 controller

The Virtual Storage Platform F800 model equipped with dual controllers for communicating with a data host.

Each controller includes the following internal components such as a processor, dual in-line cache memory modules (DIMMs), cache flash memory (CFM), battery, and fans. The controller has an Ethernet connection for out-of-band management using Hitachi Device Manager - Storage Navigator. If the data path through one controller fails, all drives remain available to data hosts using a redundant data path through the other controller. The controller is equipped with LED indicators for monitoring its operating conditions and notifying possible component replacement.

### CBLH controller

The CBLH controller includes specific functional LEDs located on the front and rear of controller and power supplies to provide its operating status.

#### CBLH with front panel bezel

The following table describes the definitions of the CBLH controller front panel bezel LEDs.

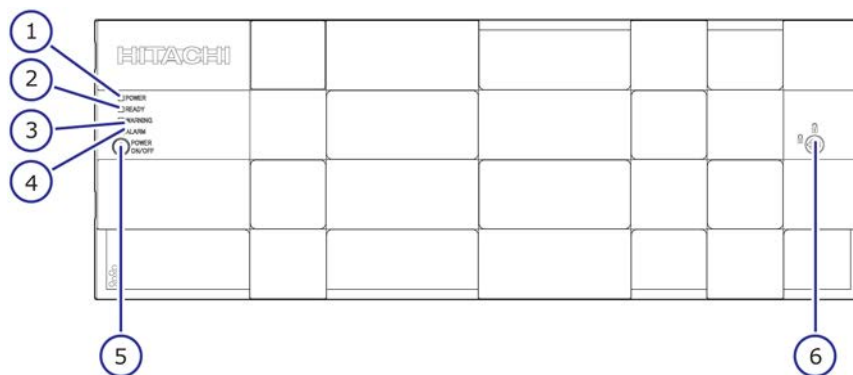

Number	Item	Description
1	POWER LED	Green: Storage system is powered on.



Number	Item	Description
		Amber: Storage system is receiving power.
2	READY LED	Green: Normal operation.
3	WARNING LED	Off: Normal operation. Amber: Component requires maintenance. Blink: Failure requires maintenance. <b>Note:</b> When System Option Mode 1097 is set to ON, the WARNING LED does not blink, even if the following failure service information messages (SIM) are issued: 452xxx, 462xxx, 3077xx, 4100xx, and 410100. LED might turn off during user maintenance.
4	ALARM LED	Off: Normal operation. Red: Processor failure (system might be down). Go to the Customer Contact Us page at <a href="https://support.hds.com/en_us/contact-us.html">https://support.hds.com/en_us/contact-us.html</a> .
5	POWER ON/OFF (main switch)	Powers the storage system.
6	Lock	Locks and unlocks the front panel bezel by using the supplied key.



**Note:** Removing a controller can cause the POWER, READY, WARNING, and ALARM LEDs on the front panel to turn off. These LEDs return to the on status after the storage system recovers from the controller replacement.

## CBLH front panel LEDs (without bezel)

The following table describes the definitions of the CBLH controller front panel LEDs.

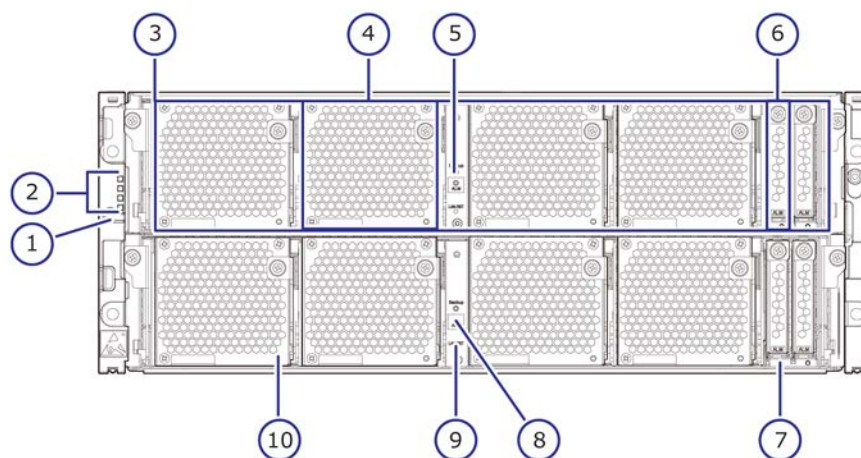

Number	Item	Description
1	POWER ON/OFF (main switch)	Powers the storage system.
2	POWER, READY, WARNING, and ALARM LEDs	<b>Note:</b> When System Option Mode 1097 is set to ON, the WARNING LED does not blink, even if the following failure service information messages (SIM) are issued: 452xxx, 462xxx, 3077xx, 4100xx, and 410100.
3	Controllers	Controller 1 (bottom) and Controller 2 (top).
4	Backup module	N/A
5	BACKUP LED	Green: Power restoration in progress following power outage. Fast blink green: Restoring. Slow blink green: Restoring, or sequential shutdown in progress.
6	Cache flash memory	N/A
7	ALM LED (for cache flash memory)	Red: Cache flash memory can be removed.
8	CTL ALM LED	Red: Controller can be removed.

Number	Item	Description
		<p>Blink red: Failure with the power supply unit of the controller.</p> <p>Amber: LAN reset switch was pressed.</p>
9	LAN-RST switch	Use only when instructed by customer support.
10	STATUS LED (for BKMF)	<p>Green: Charging of the battery in the backup module is complete.</p> <p>Red: Backup module can be removed.</p> <p>Blink red one time: Main battery failure.</p> <p>Blink red two times: Backup battery failure.</p> <p>Blink red three times: Both batteries failed or preventive maintenance replacement of batteries can run.</p> <p>Off: Battery is not mounted, battery-mounting failure occurred, or firmware is being upgraded. Off is normal status for configurations without batteries (for example, BKMF-10 and BKMF-20).</p>

## CBLH rear panel

The following table describes the definitions of the CBLH controller rear panel LEDs.

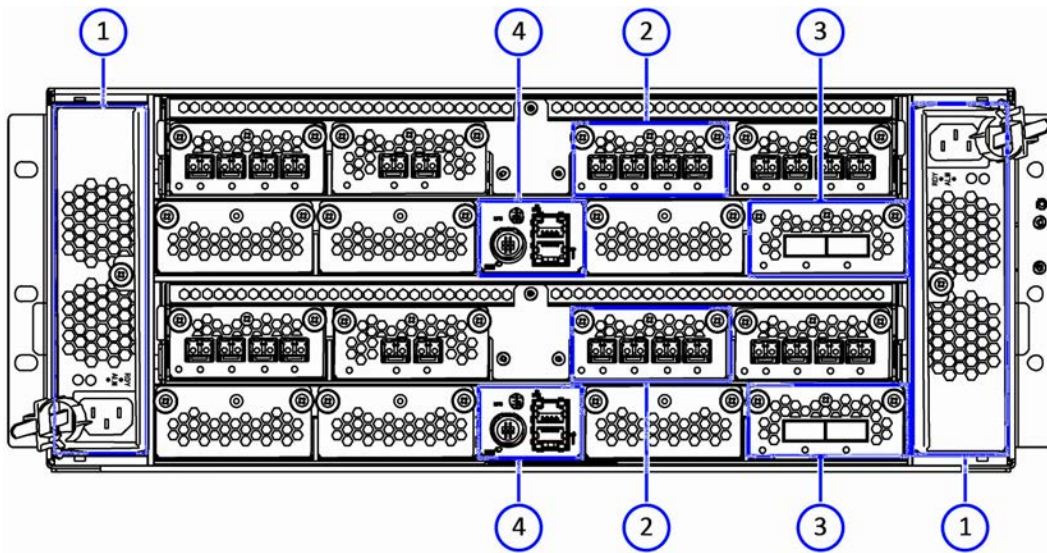

Number	Item
1	Power supply unit
2	Front end module
3	Back end module
4	LAN blade

**Rear view (includes NAS modules)**

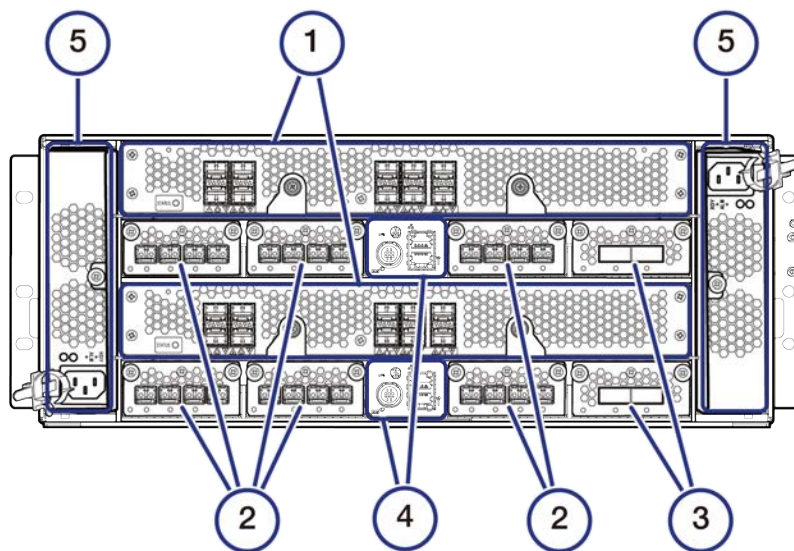

Number	Item
1	NAS module
2	Front end module
3	Back end module
4	LAN blade
5	Power supply unit

## CBLH power supply unit LEDs and connectors

The following table lists the definitions of the CBLH power supply unit LEDs and connectors.

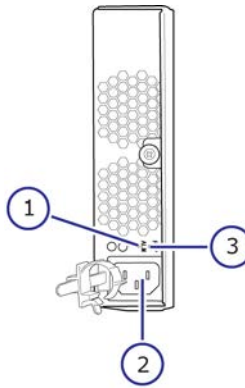

Number	Item	Description
1	ALM/RDY LED	Red: Power supply unit can be replaced.
2	Receptacle	Connects to the power cable provided with the storage system.
3	RDY LED	Green: Normal operation.

## Host, Network, and Drive Tray Ports and LEDs

The controllers are equipped with specific interfaces for connecting, powering, configuring, and managing the storage system. The component LEDs display the operating status of the storage system.

## Front end module descriptions

The following front end modules are available for the controllers. The LEDs display the operating status of the module.

### 10-Gbps iSCSI board LEDs and connectors (optical)

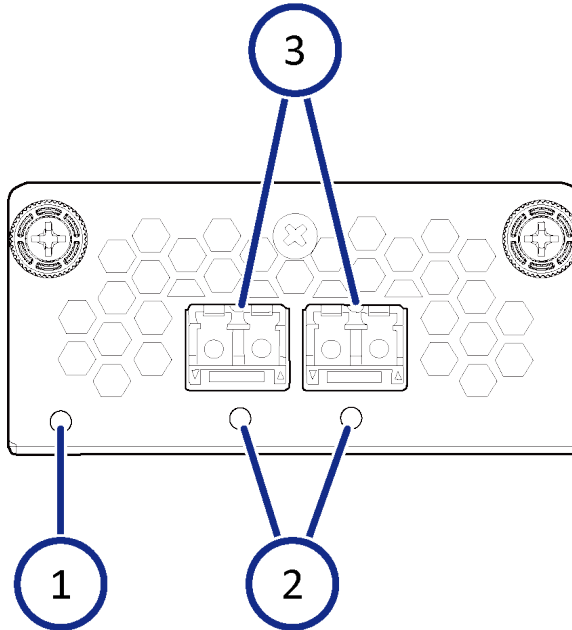

Number	Item	Description
1	STATUS LED	Green: Front end module is in the power-on state. Red: Front end module can be removed safely.
2	PORT LED	Red: Small form factor pluggable can be removed. Blue: Normal link status. Blink blue: Front end module is in communication status.
3	iSCSI connectors	Connect to Ethernet cables.

### 10-Gbps iSCSI board LEDs and connectors (copper)

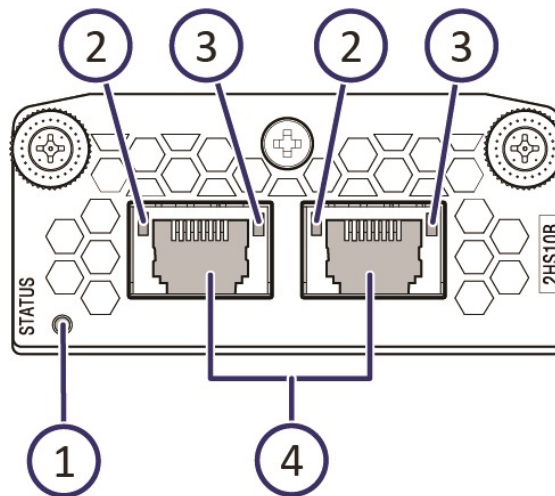

Number	Item	Description
1	STATUS LED	Green: Front end module is in the power-on state. Red: Front end module can be removed safely.
2	PORT (Link/Speed) LED	Yellow: 1-Gbps link. Green: 10-Gbps link. Off: No link connection.
3	PORT LED	Green: Link connection is established. Blinking: Communication is in progress. Off: No link connection or not ready to communicate.
4	iSCSI connectors	Connect to Ethernet cables.

## 8-Gbps, 16-Gbps, or 32-Gbps Fibre Channel (4-port) board LEDs and connectors

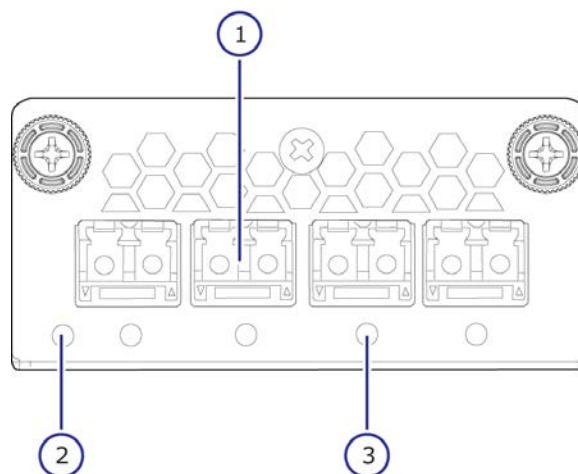

Table 1 8-Gbps Fibre Channel

Number	Item	Description
1	Fibre Channel connectors	Connect to Fibre Channel cables.
2	STATUS LED	Green: Front end module is in power-on state. Red: Front end module can be removed safely.
3	PORT LED	Red: Small form factor pluggable can be removed. Blue: Normal link status at 8-Gbps. Green: Normal link status at 2-Gbps or 4-Gbps.

Table 2 32-Gbps, 16-Gbps Fibre Channel

Number	Item	Description
1	Fibre Channel connectors	Connect to Fibre Channel cables.
2	STATUS LED	Green: Front end module is in power-on state. Red: Front end module can be removed safely.



Number	Item	Description
3	PORT LED	<p>Red: Small form factor pluggable can be removed.</p> <p>Blue: Normal link status at 16-Gbps (16-Gbps).</p> <p>Blue: Normal link status at 32-Gbps (32-Gbps).</p> <p>Green: Normal link status at 4-Gbps or 8-Gbps (16-Gbps).</p> <p>Green: Normal link status at 8-Gbps or 16-Gbps (32-Gbps).</p>

### Port assignments

CHB number	8-Gbps, 16-Gbps, or 32-Gbps Fibre Channel Ports (left to right)			
	Port 1	Port 2	Port 3	Port 4
CHB-1A	1A	3A	5A	7A
CHB-1B	1B	3B	5B	7B
CHB-1C	1C	3C	5C	7C
CHB-1D	1D	3D	5D	7D
CHB-1E	1E	3E	5E	7E
CHB-1F	1F	3F	5F	7F
CHB-1G	1G	3G	5G	7G
CHB-1H	1H	3H	5H	7H
CHB-2A	2A	4A	6A	8A
CHB-2B	2B	4B	6B	8B
CHB-2C	2C	4C	6C	8C
CHB-2D	2D	4D	6D	8D
CHB-2E	2E	4E	6E	8E
CHB-2F	2F	4F	6F	8F
CHB-2G	2G	4G	6G	8G

CHB number	8-Gbps, 16-Gbps, or 32-Gbps Fibre Channel Ports (left to right)			
	Port 1	Port 2	Port 3	Port 4
CHB-2H	2H	4H	6H	8H

16-Gbps Fibre Channel (2-port) board LEDs and connectors

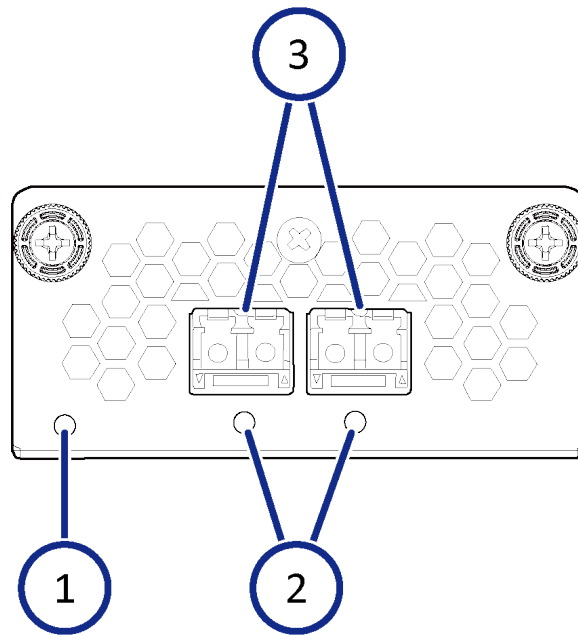

Number	Item	Description
1	STATUS LED	Green: Front end module is in the power-on state. Red: Front end module can be removed safely.
2	PORT LED	Red: Small form factor pluggable can be removed. Blue: Normal link status at 16-Gbps. Green: Normal link status at 4-Gbps or 8-Gbps.
3	Fibre Channel connectors	Connect to Fibre Channel cables.

**Port assignments**

CHB number	16-Gbps Fibre Channel Ports (left to right)	
	Port 1	Port 2
CHB-1A	1A	3A
CHB-1B	1B	3B
CHB-1C	1C	3C
CHB-1D	1D	3D
CHB-1E	1E	3E
CHB-1F	1F	3F
CHB-1G	1G	3G
CHB-1H	1H	3H
CHB-2A	2A	4A
CHB-2B	2B	4B
CHB-2C	2C	4C
CHB-2D	2D	4D
CHB-2E	2E	4E
CHB-2F	2F	4F
CHB-2G	2G	4G
CHB-2H	2H	4H

## LAN blade LEDs and connectors

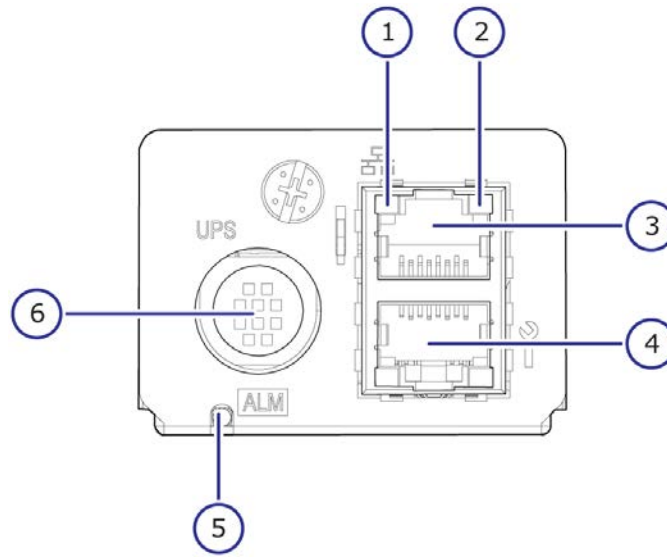

Number	Item	Description
1	ACT LED	Green: Data is being transferred.
2	LINK LED	Green: Link status is normal.
3	LAN 2	LAN port used by the user.
4	LAN 1	Maintenance LAN port used by service personnel.
5	LAN ALARM LED	Red: LAN blade can be removed.
6	Uninterruptible power supply (UPS) port	N/A

## Back end module LEDs and connectors

The back end module LEDs display the operating status of the module.

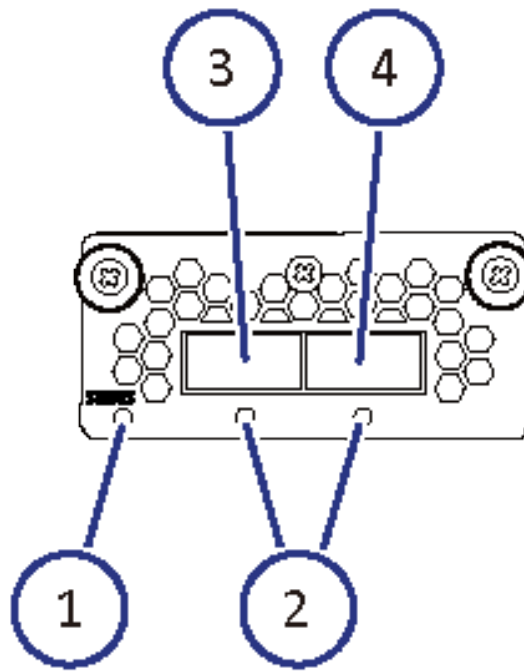

Number	Item	Description
1	STATUS LED	Green: Back end module is in the power-on state. Red: Back end module can be removed safely.
2	Port LED	Blue: Link status is normal.
3	PATH 0 connector	Connect to a drive tray.
4	PATH 1 connector	Connects to a drive tray.

## Chapter 3: Drive trays

The drive tray contains data drives, power supplies, fans, and status LEDs. Each drive tray provides interfaces for connecting to controllers and other drive trays. The all-flash storage arrays have various fixed storage capacity configurations with flash storage devices. To deliver consistent low latency host response times and highest IOP performance across all host connection ports, conventional hard disk drives (HDD) are not included or configurable with all-flash arrays.

### Small form-factor drive tray (DBS)

The following describes the physical specifications of the small form-factor drive tray.

Name	Model name	Height	Number of drive slots	Drive type
DBS	DW-F800-DBSC	2U (88.2 mm)	24	2.5 inch (SFF)

### SFF with front panel bezel

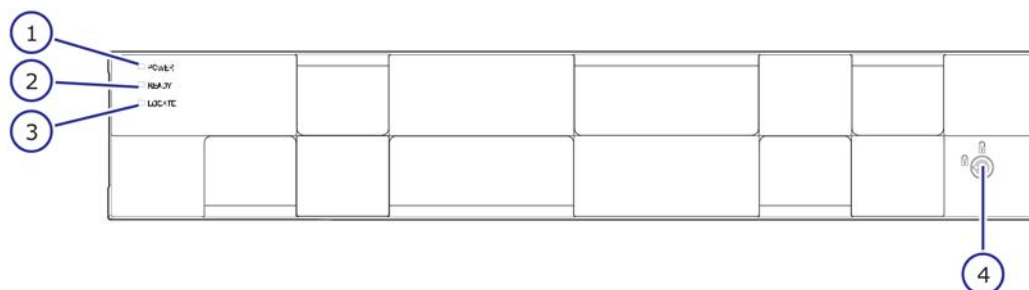

Number	Item	Description
1	POWER LED	Green: Drive tray is powered on.
2	READY LED	Green: Drive tray is operational.

Number	Item	Description
3	LOCATE LED	Amber: <ul style="list-style-type: none"> <li>Indicates the location of the chassis.</li> <li>Can be turned on or turned off by the maintenance utility.</li> </ul>
4	Lock	Locks and unlocks the front panel bezel by using the supplied key.

### SFF front panel without bezel

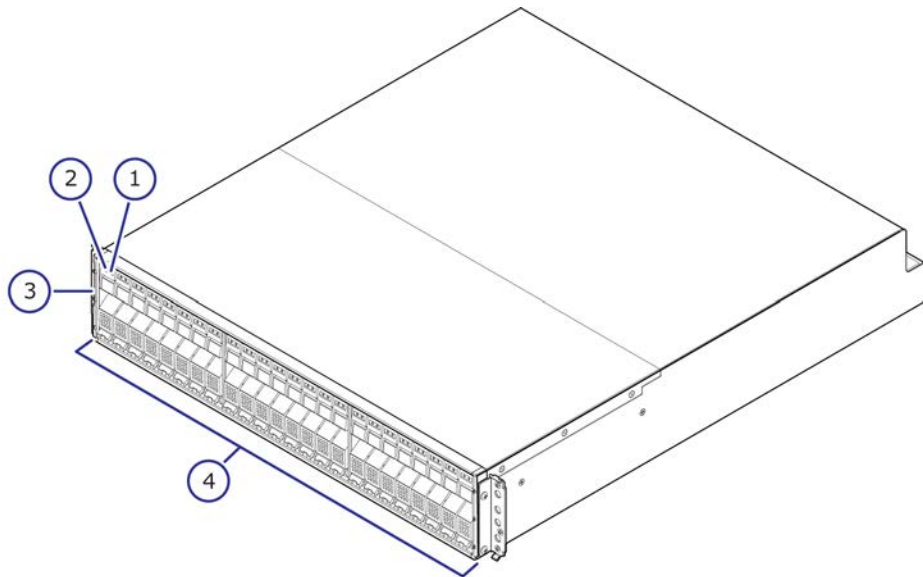

Number	Item	Description
1	ACT LED	Green: Normal operation. Blink green: Drive is being accessed.
2	ALM LED	Red: Drive stopped due to a failure and can be replaced.
3	POWER, READY, and LOCATE LEDs	Green: Drive tray is powered on.

Number	Item	Description
		Green: Drive tray is operational.
		Amber: <ul style="list-style-type: none"> <li>Indicates the location of the chassis.</li> <li>Can be turned on or turned off by the maintenance utility.</li> </ul>
4	Small form factor drives	The twenty-four 2.5-inch small form factor drives are positioned vertically. The slots are organized from 0 to 23.

### SFF rear panel

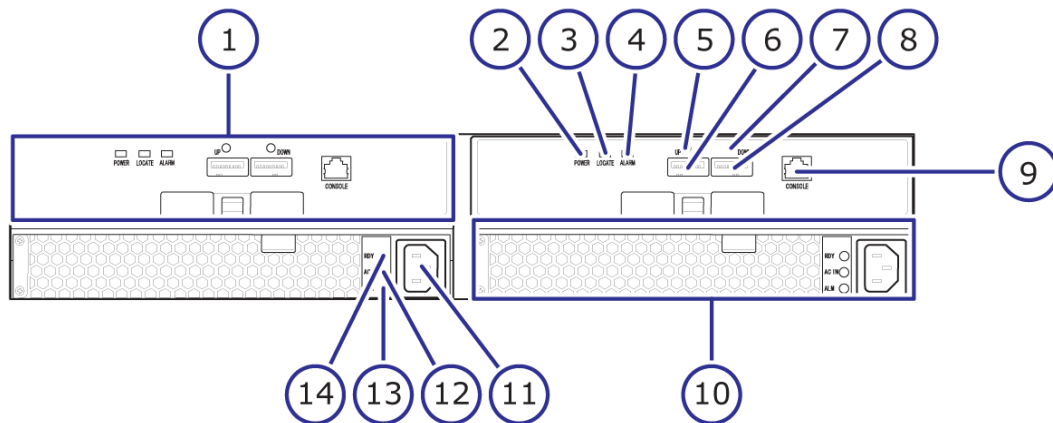

Number	Item	Description
1	ENC	N/A
2	POWER LED	Green: ENC is in the power-on state.
3	LOCATE LED	Amber: <ul style="list-style-type: none"> <li>Indicates the location of the chassis.</li> <li>Can be turned on or turned off by the maintenance utility.</li> </ul>



Number	Item	Description
4	ALARM LED	Red: ENC can be replaced.
5	PATH (IN) LED	Blue: IN side port is linked up.
6	PATH (IN) connector	Connects to a controller or drive tray.
7	PATH (OUT) LED	Blue: OUT side port is linked up.
8	PATH (OUT) connector	Connects to a drive tray.
9	Console	This port is reserved.
10	Power supply unit	N/A
11	Receptacle	Connects to the power cable provided with the storage system.
12	AC IN LED	Green: Normal operation.
13	ALM LED	Red: Power supply unit can be replaced.
14	RDY LED	Green: Normal operation.

## SFF and LFF AC power supply unit LEDs and connectors

Both SFF and LFF drive trays are equipped with AC power supply units. The AC power supply units include LEDs to display its operating status.

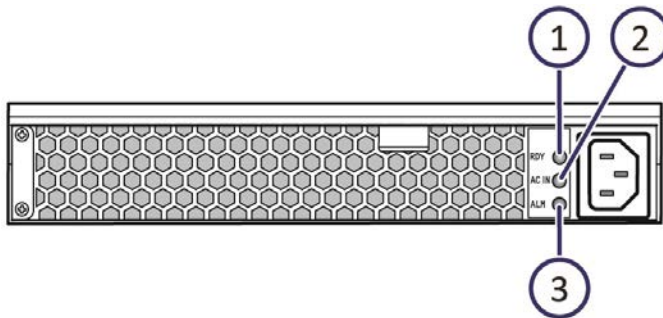

Number	Item	Description
1	RDY LED	Green: Normal operation.

Number	Item	Description
2	AC IN LED	Green: AC input is operating normally.
3	ALM LED	Red: Power supply unit can be replaced.

## SFF power supply unit LEDs and connectors

Both SFF and LFF drive trays are equipped with DC power supply units. The DC power supply units include LEDs to display its operating status.

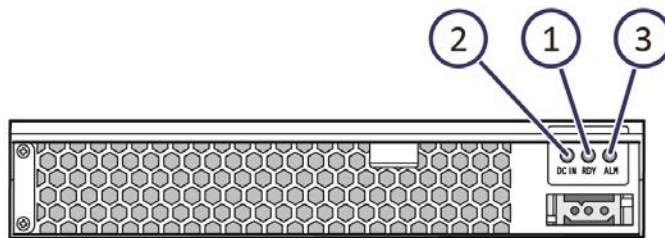

Number	Item	Description
1	RDY LED	Green: Normal operation.
2	DC IN LED	Green: DC input is operating normally.
3	ALM LED	Red: Power supply unit can be replaced.

## Flash module drive tray (DBF)

The following describes the physical specifications of the flash module drive tray.

Name	Model name	Height	Number of drive slots	Drive type
DBF	DW-F800-DBF	2U (87 mm)	12	Flash module drive (FMD)

## FMD with front panel bezel

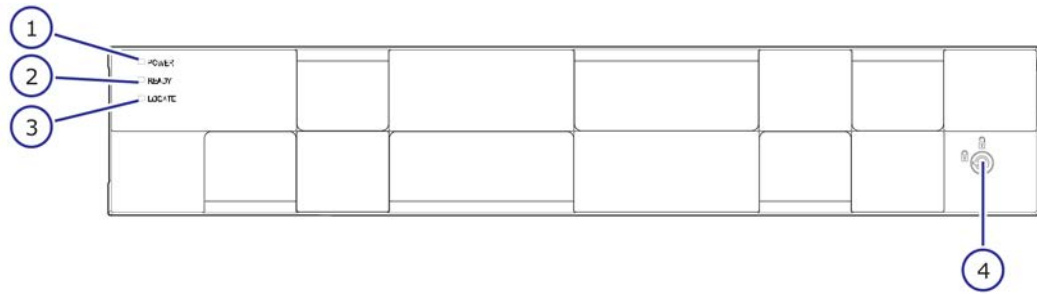

Number	Item	Description
1	POWER LED	Green: Drive tray is powered on.
2	READY LED	Green: Drive tray is operational.
3	LOCATE LED	Amber: <ul style="list-style-type: none"> <li>Indicates the location of the chassis.</li> <li>Can be turned on or turned off by the maintenance utility.</li> </ul>
4	Lock	Locks and unlocks the front panel bezel by using the supplied key.

### FMD front panel without bezel

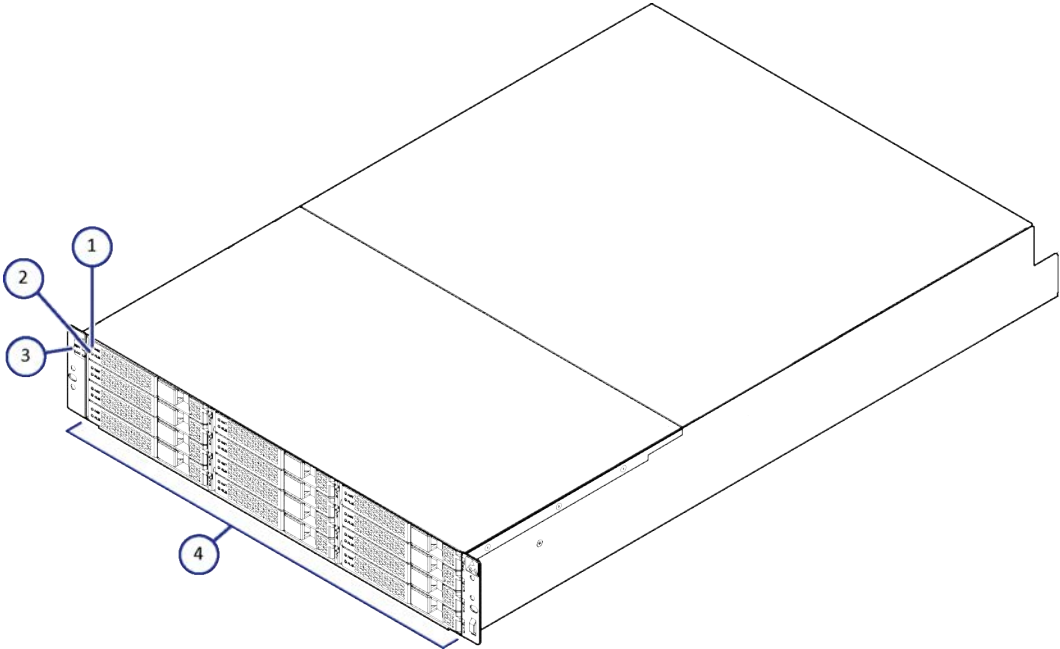

Number	Item	Description
1, 2	ACT LED	Green: Normal operation. Blink: Drive is being accessed. Slow blink indicates the FMD is in the process of startup. When powered, the LED blinks for about two to five minutes until the startup processing is complete.
	ALM LED	Red: Drive stopped due to a failure and can be replaced. <b>Note:</b> ACT indicator is only printed on some types of FMDs.
3	POWER, READY, and LOCATE LEDs	Green: Drive tray is powered on.
		Green: Drive tray is operational.

Number	Item	Description
		Amber: <ul style="list-style-type: none"> <li>Indicates the location of the chassis.</li> <li>Can be turned on or turned off by the maintenance utility.</li> </ul>
4	Flash module drives	Twelve flash module drives. Slots are organized the following way: 9, 10, 11 6, 7, 8 3, 4, 5 0, 1, 2

### FMD rear panel

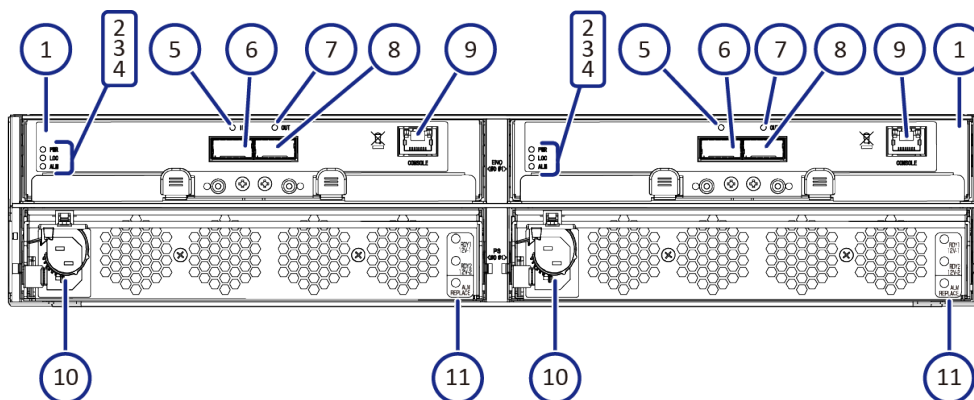

Number	Item	Description
1	ENC	N/A
2	POWER LED	Green: ENC is in the power-on state.
3	LOCATE LED	Amber: <ul style="list-style-type: none"> <li>Indicates the location of the chassis.</li> <li>Can be turned on or turned off by the maintenance utility.</li> </ul>

Number	Item	Description
4	ALARM LED	Red: ENC can be replaced.
5	PATH (IN) LED	Blue: IN side port is linked up.
6	PATH (IN) connector	Connects to a controller or drive tray.
7	PATH (OUT) LED	Blue: OUT side port is linked up.
8	PATH (OUT) connector	Connect to a drive tray.
9	Console	This port is reserved.
10	Receptacle	Connects to the power cable provided with the storage system.
11	Three LEDs, top to bottom: RDY LED AC IN LED ALM REPLACE LED	Green: Power supply unit is operating normally.
		Green: Power supply unit is operating normally.
		Red: Power supply unit can be replaced.

## Chapter 4: Host port expansion chassis

The host port expansion chassis contains various interconnect adapters that connect a host system to storage and other network devices. The interconnect adapters include PCIe boards, iSCSI and FC cards. For more information, contact customer support.

### Host port expansion chassis front panel bezel LEDs

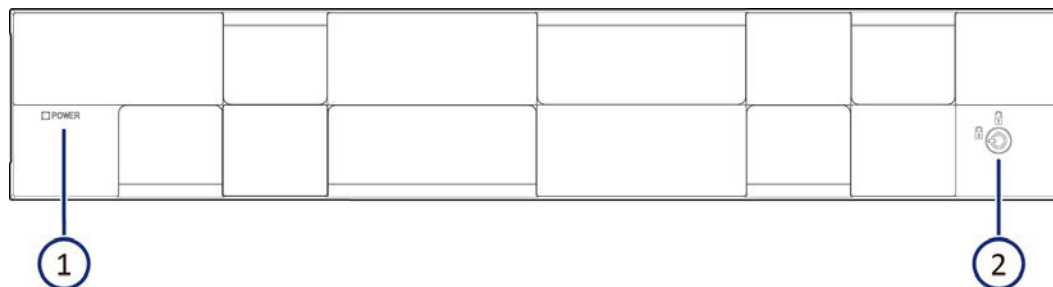

Number	Item	Description
1	POWER LED	Green: Host port expansion is turned on. Amber: PCIe module is turned on. Off: PCIe module is turned off.
2	Safety lock	Lock or unlock the front bezel.

### PCIe switchboard

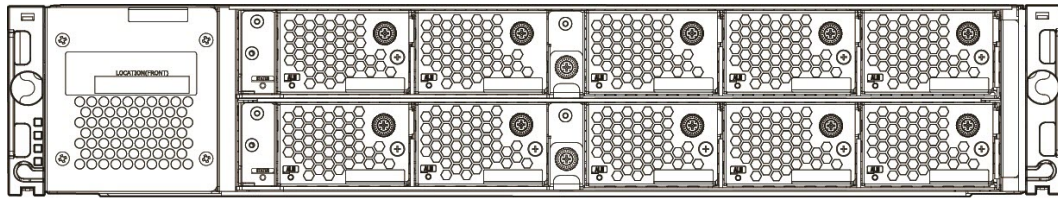

Front view of Expansion Chassis

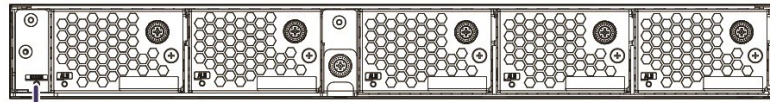

1

PCIe Switchboard

Number	Item	Description
1	STATUS LED	Green: PCIe switchboard is powered on. Red: PCIe switchboard can be replaced safely. Off: PCIe switchboard is powered off.

## Host port expansion chassis fan



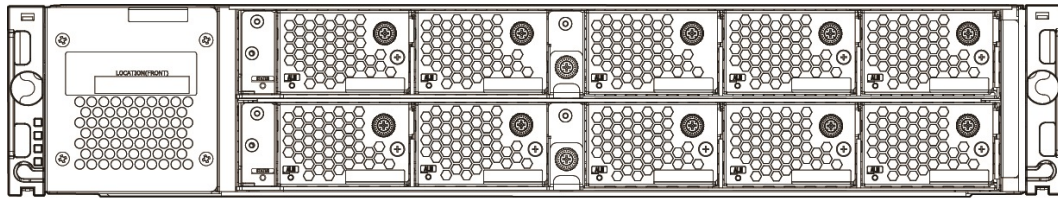

Front View of Expansion Chassis

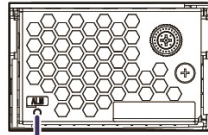

1 Expansion Chassis Fan

Number	Item	Description
1	ALM LED	Red: Fan failure has occurred. Off: Normal operation.

## PCIe cable connector

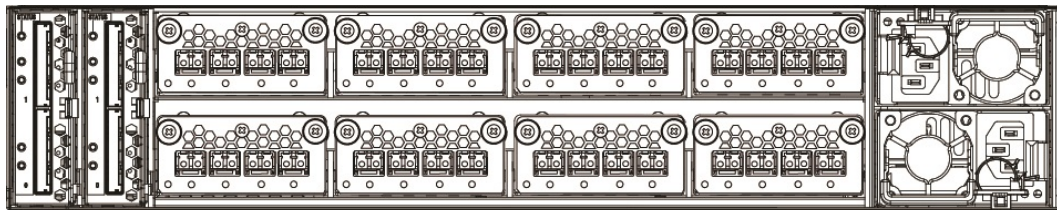

Rear View of Expansion Chassis

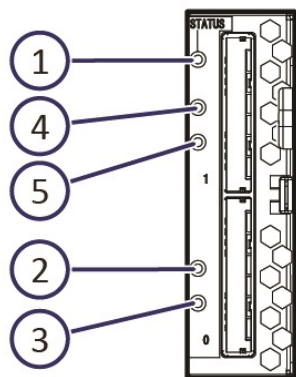

PCIe Cable Connector

Number	Item	Description
1	STATUS LED	<p>Green: PCIe cable connector is powered on.</p> <p>Red: PCIe cable connector can be replaced safely.</p> <p>Off: PCIe cable connector is powered off.</p>
2	Link Basic LED	<p>Green: Basic PCIe Gen-3.0 (8-Gbps) is linked up normally.</p> <p>Off: Basic PCIe is not linked up (PCIe cable might not be connected). If a cable is connected, it can be removed safely.</p>
3	InAct Basic LED	<p>Amber: Basic PCIe status changed from link up to link down and cables. Cables can be removed safely.</p> <p>Off: Basic PCIe is normal or not set.</p>
4	Link Option LED	<p>Green: Option PCIe Gen-3.0 (8-Gbps) is linked up normally.</p> <p>Off: Option PCIe is not linked up (PCIe cable might not be connected). If a cable is connected, it can be removed safely.</p>
5	InAct Option LED	<p>Amber: Option PCIe status changed from link up to link down and cables. Cables can be removed safely.</p> <p>Off: Option PCIe is normal or not set.</p>

## Host port expansion chassis power supply

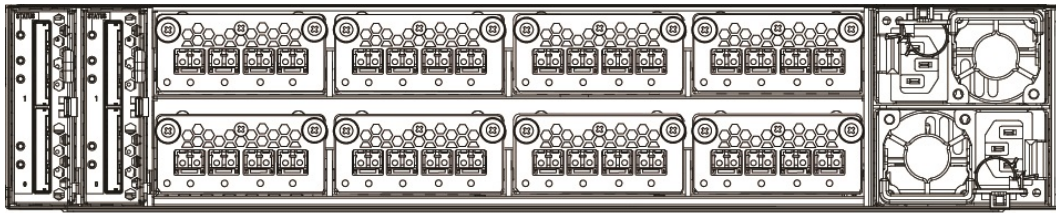

Rear View of the Expansion Chassis

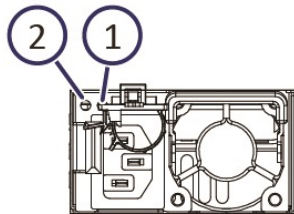

Expansion Chassis Power Supply 2

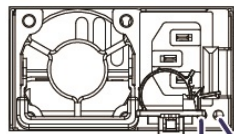

Expansion Chassis Power Supply 1

Number	Item	Description
1	ALM/RDY LED	Red: Host port expansion chassis power supply can be replaced safely. Green: Normal operation.
2	AC IN LED	Blue: AC input is normal.

## Chapter 5: NAS module

The NAS module provides communication ports to support file system protocols in a block- or file-system configuration.

### NAS Module Ports and LEDs

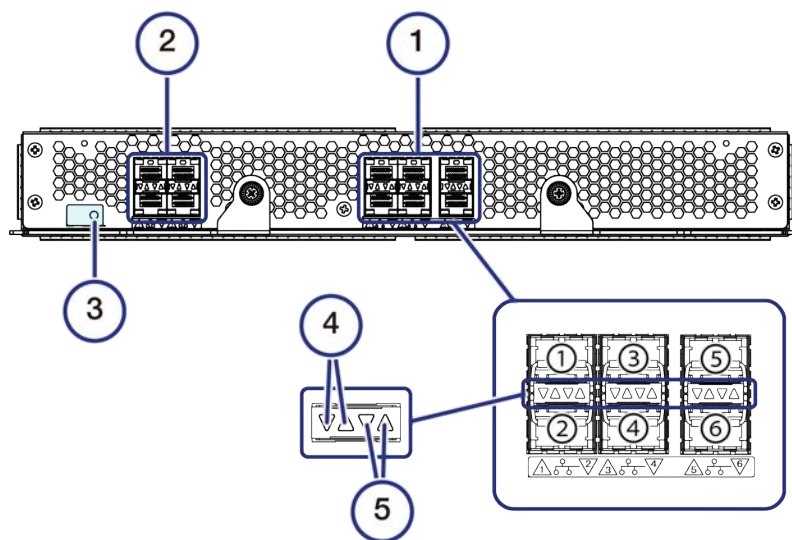

Legend	Name	Color	Description
1	User LAN port	-	This is used with the file level access.

Legend	Name	Color	Description
			<ol style="list-style-type: none"> <li>1. Target group 1</li> <li>2. Target group 2</li> <li>3. Target group 3</li> <li>4. Target group 4</li> <li>5. Target group 5</li> <li>6. Target group 6</li> </ol>
2	Cluster port	-	Reserved for future use
3	Status LED	Green	NAS modules are functioning normally.
		Red	NAS modules can be removed.
4	Link LED	Blue	Displays link status.
5	Fail LED	Red	A failure has occurred.

---

## Chapter 6: Service processor

The VSP Fx00 models include a separate, dedicated 1U service processor (SVP) to host an element manager (Storage Navigator). The SVP (model number 3919435.P) operates independently from the CPU of the storage system and operating system, and provides out-of-band configuration and management of the storage system. The SVP also monitors and collects performance data for key components of the storage system to enable diagnostic testing and analysis for customer support.

The SVP is also available as a 64-bit software application supplied by Hitachi Vantara. For the latest interoperability updates and details, see the *SVP (Service Processor) OS and Hypervisor support for Gx00, Fx00* report at [https://support.hitachivantara.com/en\\_us/interoperability.html](https://support.hitachivantara.com/en_us/interoperability.html).

### Service processor hardware specifications

The following table lists the hardware specifications for the service processor (SVP) provided by Hitachi Vantara.



**Caution:** The SVP is not supported in high-temperature environments. Do not operate it in locations with temperatures of 40°C or higher.

Item	Specification
Dimensions	Height: 1.7 inches (43 mm) Width: 17.2 inches (437 mm) Depth: 14.5 inches (369 mm)

Item	Specification
	Weight: 14 lbs (6.4 kg)
Processor	Celeron G1820 2.7-GHz 2M, 2C, 2T <ul style="list-style-type: none"> <li>▪ Cores: 2</li> <li>▪ Instruction set: 64-bit</li> <li>▪ SmartCache: 2 MB</li> <li>▪ Maximum memory size: 32 GB</li> <li>▪ Memory types: DDR3-1333, DDR3L-1333 @ 1.5V</li> </ul>
Memory	8-GB RAM DDR3
Hard drive	2 TB
Network interface card	x4 ports (on-board NIC) + x1 IPMI (BMC) port
Fans	2 x 4-cm 4-pin PWM fans
Operating system	Windows Embedded Standard 7

## Service processor description

The SVP provides four RJ-45 ports:

- Two ports connect to the storage system controllers (one port for each controller).
- One port connects to the IP network of the user.
- One port connects to a user-supplied management console PC.



**Note:** This product is also designed for IT power distribution systems with phase-to-phase voltage.

Three of the four RJ-45 ports (which connect to the controllers and the IP network) are configured as a bridge. The SVP can be addressed using the default IP address 192.168.0.15.

In the unlikely event you cannot connect to the SVP using the default IP address, use the following emergency login: `http://<default SVP IP address>/dev/storage/<model number><system serial number>/emergency.do`. For example:

Storage system model number	Storage system serial number	URL
8320004	456789	<code>http://192.168.0.15/dev/storage/8320004456789/emergency.do</code>
8340004	456789	<code>http://192.168.0.15/dev/storage/8340004456789/emergency.do</code>
8360004	456789	<code>http://192.168.0.15/dev/storage/8360004456789/emergency.do</code>

Users are responsible for adopting the appropriate security procedures with the SVP, including:

- Applying Windows security patches.
- Turning on automatic Windows updates or using the manual Windows update method.
- Installing antivirus software that has been tested and approved by Hitachi.

## SVP front panel

The front panel of the physical SVP is equipped with LEDs, a reset button, and a power button.

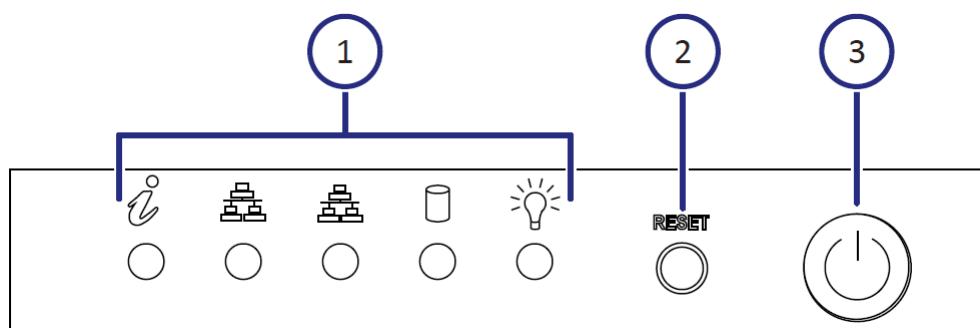

Number	Description
1	LEDs. From left to right, the LEDs are: <ul style="list-style-type: none"> <li>▪ BMC Heartbeat</li> <li>▪ LAN card 2</li> </ul>



Number	Description
	<ul style="list-style-type: none"> <li>▪ LAN card 1</li> <li>▪ Hard drive</li> <li>▪ System standby power</li> </ul>
2	Reset button.
3	Power button. Applies power to or removes power from the SVP.

## SVP rear panel

The only ports used on the rear panel of the physical SVP are the power socket and the four LAN ports.

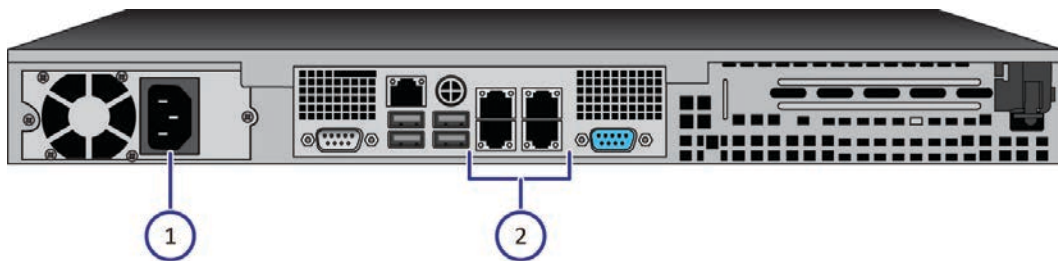

Number	Description
1	Power socket. Attach the power cable supplied with the SVP.
2	<p>Four LAN ports arranged as follows:</p> <p>LAN3 LAN4</p> <p>LAN1 LAN2</p> <p>These ports connect to your IP network, the management console PC, and the user LAN port on each storage system controller.</p>



**Note:** After the Initial Startup Wizard is run, the SVP can be used in non-bridge mode. In this mode, the cables can be removed from SVP ports LAN3 and LAN4 and attached to switches. For more information, contact customer support.

---

## Chapter 7: Maintaining the storage system

Ongoing proper maintenance of the storage system maintains the reliability of the storage system and its constant availability to all hosts connected to it.

For more complex maintenance activities, contact customer support.

### Storing the storage system

If the storage system does not receive power for more than six months, the battery can become discharged and possibly damaged. To avoid this situation, charge the battery for more than three hours at least once every six months.



**Note:** Do not store the equipment in an environment with temperatures of 104°F (40°C) or higher because battery life will be shortened.

### Powering off the storage system

#### Procedure

1. Press the main switch on the controller chassis for approximately three seconds until the `POWER` LED on the front of the chassis changes from solid green to a blinking status.
2. Release the main switch and the `POWER` LED returns to solid green after blinking for approximately three seconds.  
The power-off process begins. The process takes approximately 18 minutes or longer depending on the amount of data that needs to be written. The `POWER` LED is solid green during the powering off process. The `POWER` LED changes from green to amber when the process is completed.
3. Verify the `POWER` LED on the front of the storage system changes from green to amber.
4. To stop the power supply, remove the power cables from the power supply units on the controller chassis and drive box.

If the storage system is connected to a PDU, you can stop the power supply by turning off the PDU breaker.



**Note:** If the storage system does not receive power for more than six months, the battery can become discharged and possibly damaged. To avoid this situation, charge the battery for more than three hours at least once every six months.

---

## Appendix A: Mechanical specifications for VSP F800

The storage system mechanical specifications are described for VSP F800.

### VSP F800 mechanical specifications

#### Controller

Quantity	Component	Description
1	CBLH	A 4U controller chassis consisting of controllers, channel boards, disk boards, NAS module (optional), AC or DC power supplies, and batteries with cooling fans.

#### Drive tray

Quantity	Component	Description
1	SFF drive tray	A drive tray that supports 2.5-inch flash drives. The drive tray consists of an ENC, cooling fans, and AC-DC power supplies or DC-DC power supplies.
1	FMD tray	A drive tray that supports flash module drives and consists of an ENC and AC-DC power supplies equipped with built-in cooling fans.

**NAS module**

Component	Description
NAS module	Optional component for block and file storage configuration

**Drive size**

Component	Specification
2.5-inch drive (SFF)	3.21 x 8.10 x 0.74 inches (81.6 x 205.7 x 18.7 mm)
Flash module drive tray	5.74 x 14.44 x 0.78 inches (146 x 366.8 x 19.8 mm)

**Data capacity (GB)**

Component	Specification
2.5-inch drive (SFF SSD)	196.92, 393.85, 472.61, 945.23, 1890.46, 3780.92, 7561.85 GB
Flash module drive tray	1759.21, 3518.43, 7036.87, 14073.74 GB
*Only available for DB60/DB60C dense intermix drive tray.	

**Maximum mountable quantity**

Component	Specification
SFF	24
Flash module drive tray	12
Maximum number of flash module drives	576
Maximum number of spare drives	64

**Battery specifications**

<b>Storage system intake temperature</b>	<b>CBLH</b>
Up to 75.2° F (24° C)	5 years
Up to 86° F (30° C)	5 years
Up to 93.2° (34° C)	4 years
Up to 104° (40° C)	3 years

**Host interface**

Item	Component	Specification
Interface type	Fibre Channel optical	8-Gbps, 16-Gbps, 32-Gbps
	iSCSI optical	10-Gbps
	iSCSI (Copper)	10-Gbps
	NAS module	10 Gbps (Fibre Channel optical)
Data transfer speed (maximum speed for transfer to host)	Fibre Channel optical	800-Mbps (Fibre Channel)
		1600-Mbps (Fibre Channel)
		3200-Mbps (Fibre Channel)
	iSCSI optical	10-Gbps (iSCSI optical)
	iSCSI (Copper)	10 Gbps (iSCSI copper)
	NAS module (Fibre Channel)	1000 Mbs
VSP G800 maximum number of ports	8 Gbps Fibre Channel (optical)	64
	16 Gbps Fibre Channel (optical 2-port)	32
	16 Gbps Fibre Channel (optical 4-port)	64
	32 Gbps Fibre Channel (optical)	64
	10 Gbps iSCSI optical)	32
	10 Gbps iSCSI (copper)	32
VSP F800 maximum number of ports	8 Gbps Fibre Channel (optical)	48
	16 Gbps Fibre Channel (optical)	24
	32 Gbps Fibre Channel (optical)	48
	10 Gbps iSCSI (optical)	24
	10 Gbps iSCSI (copper)	24

Item	Component	Specification
Maximum number of ports (NAS module installed)	8 Gbps Fibre Channel (optical)	16
	16 Gbps Fibre Channel (optical 2-port)	8
	16 Gbps Fibre Channel (optical 4-port)	16
	32 Gbps Fibre Channel (optical)	16
	10 Gbps iSCSI (optical)	8
	10 Gbps iSCSI (copper)	8
	10 Gbps Fibre Channel (optical)	12
Maximum number of ports (NAS modules not installed)	8 Gbps Fibre Channel (optical)	80
	16 Gbps Fibre Channel (optical 2-port)	40
	16 Gbps Fibre Channel (optical 4-port)	80
	32 Gbps Fibre Channel (optical)	80
	10 Gbps iSCSI (optical)	40
	10 Gbps iSCSI (copper)	40
Maximum number of ports (host port expansion chassis and NAS module installed)	8 Gbps Fibre Channel (optical)	32
	16 Gbps Fibre Channel Optical (2-port)	16
	16 Gbps Fibre Channel Optical (4-port)	32
	32 Gbps Fibre Channel Optical (4-port)	32
	10 Gbps iSCSI (optical)	16
	10 Gbps iSCSI (copper)	16
	10 Gbps Fibre Channel (optical)	12

Item	Component	Specification
Transferred block size		512 bytes
Maximum number of hosts using a Fibre Channel switch		255
Maximum number of hosts using a network switch		255

### RAID specifications

D: Data drive, P: Parity drive.

Although the storage system with a configuration of RAID 1, RAID 5, or RAID 6 provides data reliability enhanced by redundancy, there is a chance that user data could be lost due to an unexpected host, storage system hardware, or software failure. Therefore, users are requested to back up all data.

RAID Level	SAS, SAS 7.2k, flash drives mounted
RAID 1	2D+2D, 4D+4D
RAID 5	3D+1P, 4D+1P, 6D+1P, 7D+1P
RAID 6	6D+2P, 12D+2P, 14D+2P

Item	Specification
Maximum number of RAID groups	480
Maximum volume size	3 TB (or 4 TB when using the LDEVs of other storage systems)
Maximum volumes/host groups and iSCSI targets	2048
Maximum volumes/parity groups	2048

### Shared memory and data assurance



Item	Specification
Flash memory	32 M bytes
L3 Cache memory	4 M bytes
SDRAM	1 G bytes
Data bus	Parity
Cache memory	ECC (1 bit for correction, 2 bits for detection)
Drive	Data assurance code

### Start-up time

Item
Standard: 5-to-10 minutes. The start-up time may be longer in proportion to the number of drive trays connected. With a maximum configuration 1 controller tray and 19 drive trays, start-up time is approximately 10 minutes.

### Chassis size

Component	Specification (W x D x H)
CBLH	19.01 x 35.10 x 6.86 inches (483 x 891.7 x 174.3 mm)
SFF	18.97 x 22.24 x 3.47 inches (482 x 565 x 88.2 mm)
DBF	19.01 x 30 x 3.42 inches (483 x 762 x 87 mm)

### Mass

The table lists the values of a maximum configuration when all controllers and drives are mounted.

Component	Specification
CBLH	187.39 pounds (85 kg)
SFF	Approx 50.70 inches (23 kg)

Component	Specification
DBF	Approx. 83.77 pounds (38 kg)

### Required height

Component	Specification
CBLH	4 U
SFF	2 U
DBF	2 U

### Cache specifications

Item	Specification
Capacity (GB)	512
Control method	Read LRU, Write after
Battery backup	Provided
Backup duration	Unrestricted (saving to a nonvolatile memory)

Data in the cache memory is preserved against power failures. If a power outage occurs, data in cache memory is written to drives.

When the storage system enters Cache Backup mode, the amber **WARNING** LED goes on to when the system starts. This warning indicates that the battery charge has dropped significantly and the remaining battery capacity is not sufficient; the storage system will continue operating with the Write Cache function disabled.

When the battery is charged, the warning indication disappears, and the storage system continues the operation in the Write Cache function.

The warning indication disappears within six hours. Even when the warning is shown, normal operation is assured in Write-Through. Read and write performance is lowered because the Write Cache function is disabled.

If the storage system is not charged for more than six months, the battery can become overcharged and sustain unrecoverable damage. To avoid this situation, charge the battery more than 3 hours every six months.

**Insulation performance**

Item	Specification
Insulation withstand voltage	AC 1,500 V (100 mA, 1 min)
Insulation resistance	DC 500 V, 10 M $\Omega$ or more

## Appendix B: Electrical specifications for VSP F800

The electrical specifications are described for the storage system.

### Electrical specifications

Item	Controller	Drive tray
Frequency (Hz)	50/60 ±1	
Number of phases, cabling	Single-phase with protective grounding	
Steady-state current 100V/ 200V <sup>1, 2</sup>	CBLH: 4.0x2	FMD drive tray: 2.6x2/1.3x2
Current rating of breaker/ fuse (A)	16.0 (each electrical)	
Heat value (normal) (kJ/h)	2810 or less	FMD drive tray: 1520 or less FMD drive tray: 1520 or less
Steady-state power (VA/W) <sup>3</sup>	CBLH: 1600/1560 or less	FMD drive tray: 520/490 or less
Power consumption (VA/W)	CBLH: 840/780 or less	FMD drive tray: 440/420 or less
<p><b>Notes:</b></p> <ol style="list-style-type: none"> <li>1. The power current of Nx2 described in this table is required for a single power unit.</li> <li>2. If one power unit fails, another power unit requires electric current for the two power units. Therefore, plan the power supply facility so that the current-carrying capacity for one power unit can provide the total capacity for two power units.</li> <li>3. This table shows the power requirement (100 V or 200 V) for the maximum configuration . The actual required power might exceed the value shown in the table when the tolerance is included.</li> </ol>		

## Appendix C: Environmental specifications for VSP F800

The environmental specifications are described for the storage system.

### Environmental specifications

#### Temperature

**⚠ Caution:** The following VSP Gx00/Fx00 storage system components are not supported in high-temperature environments. Do not operate the following components at temperatures of 40°C or higher:

- DB60 dense drive tray
- HDS provided service processor (SVP) server
- First-generation FMDs (non-DC2 FMDs)

State	Controller	FMD drive trays
Operating	50°F to 104°F (10°C to 40°C)	DKC-F810I-1R6FN/3R2FN/6R4FN/7R0FP/14RFP drive is installed: 50°F to 104°F (10°C to 40°C)
Non-operating	14°F to 122°F (-10°C to 50°C)	14°F to 95°F (-10°C to 35°C)
Transport, storage	-22°F to 140°F (-30°C to 60°C)	-22°F to 122°F (-30°C to 50°C)
Temperature change rate (°C/h)	10 or less	

#### Humidity

State	Percentage
Operating	8 to 80
Non-operating	8 to 90

State	Percentage
Transport, storage (%)	5 to 95
Maximum wet bulb temperature (°C)	29 (non-condensing)

### Vibration

State	m/s <sup>2</sup>
Operating	2.5 or less Within 5 seconds (resonance point: 10 Hz or less)
Non-operating	5.0 or less at 5 Hz to 300 Hz (no damage to product) 9.8 (1.0 G) Within 5 seconds (resonance point: 10 Hz or less)
Transport (packed)	5.0 or less

### Impact

State	m/s <sup>2</sup>
Operating	20 or less (10 ms, half sine wave)
Non-operating	50 or less (10 ms, half sine wave)
Transport (packed)	80 or less

### Altitude

State	Controller	FMD drive
Operating (m)	3,000 (Environmental temperature: 10°C to 32°C)	3,000 (Environmental temperature: 10°C to 32°C) OR

State	Controller	FMD drive
	900 (Environmental temperature: 10°C to 40°C)	900 (Environmental temperature: 10°C to 40°C) when DKC-F810I-1R6FN/3R2FN/6R4FN/7R0FP/14RFP drive is installed.
Non-operating (m)	-60 to 12,000	N/A

### Atmosphere

Avoid areas exposed to corrosive gas and salty air.

### Acoustic Noise

State	Controller	FMD
Operating	60 dB (Environmental temperature 32°C or less) <sup>1</sup>	60 dB (Environmental temperature 32°C or less) <sup>1, 2, 3</sup>
Non-operating	55 dB (Environmental temperature 32°C or less) <sup>1, 2, 3, 4</sup> 55 dB	

#### Notes:

1. The system's internal temperature controls the rotating speed of the fan module. Therefore, this standard value might be exceeded if the maximum load continues under high-temperature environment or if a failure occurs in the system.
2. Sound pressure level (LA) changes from 66 dB or 75 dB, according to the ambient temperature, drive configuration, and operating status. Maximum volume can reach 79 dB during maintenance procedure for a failed ENC or power supply.
3. Acoustic power level (LwA) measured by the ISO 7779 standard is 7.2 B. This value changes from 7.2 B to 8.1 B, according to the ambient temperature, drive configuration, and operating status.

---

## Appendix D: iSCSI standards and specifications

The following tables describe the standards and specifications for using iSCSI in a hosting environment.

### iSCSI standards

The following standards apply to the management, maintenance, and iSCSI data ports. To configure this system, use switches that comply with the following standards:

- IEEE 802.1D STP
- IEEE 802.1w RSTP
- IEEE 802.3 CSMA/CD
- IEEE 802.3u Fast Ethernet
- IEEE 802.3z 1000 BASE-X
- IEEE 802.1Q Virtual LANs
- IEEE 802.3ae 10 Gigabit Ethernet
- RFC 768 UDP
- RFC 783 TFTP
- RFC 791 IP
- RFC 793 TCP
- RFC 1157 SNMP v1
- RFC 1231 MIB II
- RFC 1757 RMON
- RFC 1901 SNMPv2

### iSCSI specifications

Item	Specification	Comments
iSCSI target function	Supported	N/A
iSCSI target function	Supported	TrueCopy® only



Item	Specification	Comments
iSCSI ports	2 per interface board	VSP Fx00 models: Maximum 24 per iSCSI system
Connection methods	Direct and switch connections	
Host connections	255 (maximum per iSCSI port)	With Linux software initiator, the maximum number decreases.
Path failover	HDLM <sup>1</sup>	Supports Microsoft MPIO (Multi Path I/O)
Link	10 Gbps SFP+	N/A
Transfer speed	10 Gbps	N/A
Connector type	LC	N/A
Cable	Optical OM3, OM2 MMF cable	N/A
Network switch	L2 or L3 switch	Should comply with IEEE802.3ae
Switch cascading	Maximum: 5 switches or fewer	Minimum number of cascading switches is recommended.
MAC address	Per port (fixed value)	Factory setting: World Wide Unique value. Cannot be changed.
Maximum transfer unit (MTU)	1,500, 4,500, 9,000 bytes (Ethernet frame)	Jumbo frame, MTU size greater than 1500
Link aggregation	Not supported	N/A
Tagged VLAN	Supported	N/A
IPv4	Supported	N/A

Item	Specification	Comments
IPv6	Supported	<p>Note the following precautions:</p> <ul style="list-style-type: none"> <li>▪ When iSCSI Port IPv6 is set to Enabled, if the IPv6 global address is set to automatic, the address is determined by acquiring a prefix from an IPv6 router.</li> <li>▪ If the IPv6 router does not exist in the network, the address cannot be determined. As a result, an iSCSI connection might be delayed. When an iSCSI Port IPv6 is set to Enabled, verify the IPv6 router is connected to the same network, and then set IPv6 global address automatically.</li> </ul>
Subnet mask	Supported	N/A
Gateway address	Supported	N/A
DHCP	N/A	N/A
DNS	N/A	N/A
Ping (ICMP ECHO) Transmit, Receive	Supported	N/A
IPsec <sup>2</sup>	N/A	N/A
TCP port number	3260	Changeable among 1 to 65,535. Observe the

Item	Specification	Comments
		following if changing values: <ul style="list-style-type: none"> <li>▪ The setting of the corresponding host should also be changed to log in the new port number.</li> <li>▪ The new port number might conflict with other network communication or be filtered on some network equipment, preventing the storage system from communicating through the new port number.</li> </ul>
iSCSI name	Both iqn <sup>3</sup> and eui <sup>4</sup> types are supported	The unique iqn value is automatically set when a target is made. iSCSI name is configurable.
Error recovery level	0 (zero)	Error recovery by retrying from host. Does not support Level 1 and Level 2.
Header digest	Supported	Detects header error or data error with iSCSI communication. The storage system follows the host's digest setting. If digest is enabled, the performance degrades. The amount of the degradation depends on factors such as host performance of host and transaction pattern.
Data digest	Supported	
Maximum iSCSI connections at one time	255 per iSCSI port	N/A
CHAP	Supported	Authentication: login request is sent properly from host to storage. CHAP is not supported during discovery session.

Item	Specification	Comments
Mutual (2-way) CHAP	Supported (not available if connected to Linux software initiator)	Authentication: login request is sent properly from host to storage.
CHAP user registration	Max 512 users per iSCSI port	N/A
iSNS	Supported	With iSNS (name service), a host can discover a target without knowing the target's IP address.
<p><b>Note:</b></p> <ol style="list-style-type: none"> <li>1. JP1, HiCommand Dynamic Link Manager. Pass switching is achieved. Not supported on Windows Vista and Windows 7 operating systems.</li> <li>2. IP Security. Authentication and encryption of IP packets. The storage system does not support IPsec.</li> <li>3. iqn: iSCSI Qualified Name. The iqn consists of a type identifier, "iqn," a date of domain acquisition, a domain name, and a character string given by the individual who acquired the domain. Example: <u>iqn.1994-04.jp.co.hitachi:rsd.d7m.t.10020.1b000.tar</u></li> <li>4. eui: 64-bit Extended Unique Identifier. The eui consists of a type identifier, "eui," and an ASCII-coded, hexadecimal, EUI-64 identifier. Example: <u>eui.0123456789abcdef</u></li> </ol>		

---

## Appendix E: Replacement parts

Part replacement is essential for maintaining the high performance of the system. Replacing system components is covered by the maintenance service contract.

### Battery unit

#### Battery lifetime

The battery life time is affected by the battery temperature. The battery temperature changes depending on the intake temperature and height of the storage system, the configuration, operation of the controller boards and drives, charge-discharge count and others. The battery lifetime will be three to five years.

#### Treatment

Use the storage system in a place where the ambient temperature is 86°F (30°C) or less on average.

Periodic parts replacement is required. For customers with maintenance service contracts, parts are replaced periodically in keeping with the terms of the contract.



**Note:** The battery protects the data in the cache memory in an emergency, such as a sudden power failure. In these cases, follow the normal power down procedure. If not, the battery might reach its lifespan earlier than expected and become unusable within three years. When replacing the battery, follow the given procedure for disposing a used battery.

#### Replacement period

The battery lifetime (intake temperature is 30 degrees C or less.) in the standard environment is as shown below.

---

## Appendix F: Data and power cables

The storage system supports a variety of data and power cables for specific hosting environments.

### Required cables

The quantities and lengths of the cables required for storage system installation vary according to the specific storage system and network configuration. Fibre Channel and iSCSI cables are used to connect the controllers to a customer switch or host. Serial Attached SCSI (SAS) cables are used to connect drive trays to controllers and other drive trays.

The following table describes the cables required to perform storage system connections at the time of installation.

Interface type	Connector type	Cable requirements
Fibre Channel	LC-LC	Use a Fibre Channel cable to connect the Fibre Channel ports on each controller to a host computer (direct connection), or to or several host computers via a Fibre Channel switch. See the note and table below.
iSCSI (optical)	LC-LC	Use an optical Ethernet cable to connect the iSCSI 10 Gb SFP ports on each controller to a host computer (direct connection), or to several host computers via an Ethernet switch.
iSCSI (copper)	RJ-45	Use a shielded Category 5e or 6a Ethernet cable to connect the iSCSI 10 Gb RJ-45 ports on each controller to a host computer (direct connection), or to several host computers via an Ethernet switch.
SAS	SAS optical	Connects the controller to a drive tray or a drive tray to another drive tray. Two SAS cables are provided with each drive tray. SAS cables are also used to connect NAS modules to switches.
Ethernet	RJ-45	Four shielded Category 5e or 6a Ethernet cables are required for connecting the SVP to the controllers, management console PC, and network switch.



**Note:** The maximum distances in a typical Fibre Channel SAN depend on the kind of optical fiber used and its diameter. The following table lists the maximum supported Fibre Channel cable length based on cable size and port speed.

Cable size	Speed	Maximum cable length
9 micron	1 Gbps	3281 feet (1 km)
	2 Gbps	6562 feet

Cable size	Speed	Maximum cable length
		(2 km)
50 micron	2 Gbps	984.2 feet (300 meters)
	4 Gbps	492.1 feet (150 meters)
	8 Gbps	164 feet (50 meters)
	16 Gbps	115 feet (35 meters)
62.5 micron	2 Gbps	328.1 feet (100 meters)
	4 Gbps	230 feet (70 meters)
	8 Gbps	69 feet (21 meters)



## Fibre Channel cables

When constructing a system with the direct connection or Fibre Channel switch connection, consider the following:

- If you connect a storage system to a FC host adapter through a switch, set Fabric = ON and set to Point-to-Point.
- If you connect a storage system directly to FC host adapter with the following fabric topology:
  - For 2, 4 or 8 Gbps, set the storage port to Fabric = OFF and Connection Type FC-AL (Fibre Channel Arbitrated Loop).
  - For 16 or 32 Gbps, set the storage port to Fabric = OFF and Connection Type P-to-P (Point-to-Point).

For the 8-Gbps Fibre Channel ports, the combinations between data-transfer speeds and connection types are as follows:

Connection type	Data transfer speeds for 8-Gbps ports			
	2 Gbps	4 Gbps	8 Gbps	Auto
FC-AL	Available	Available	Available	Available (default)
P-to-P	Available	Available	Available	Available
Fabric	Available	Available	Available	Available

For the 16-Gbps Fibre Channel ports and for 16-Gbps SFP added to the 4- port FC 32-Gbps package, the combinations between data-transfer speeds and connection types are as follows:

Connection type	Data transfer speeds for 16-Gbps ports/SFPs					
	2 Gbps	4 Gbps	8 Gbps	16 Gbps	32 Gbps	Auto
FC-AL	No available	Available	Available	Not available	Not available	Available <sup>1</sup>
P-to-P	No available	Available	Available	Available	Not available	Available (default <sup>2</sup> )
Fabric	Available	Available	Available	Available	Not available	Available

**Notes:**

1. If this combination is specified, the maximum transfer speed automatically specified is 8 Gbps.
2. If this default value is set, Fabric is set to ON automatically.

**Note:**

To connect to the server by the 16-Gbps direct connection, the Fabric Emulation function of the Hitachi host adapter is required. For the direct connection using the Fabric Emulation function, set the Fabric setting of the Fibre Channel port of the Storage System to ON.

For the 32-Gbps SFP added to the 4-port FC 32-Gbps package, the combinations between data-transfer speeds and connection types are as follows:

Connecti on type	Data transfer speeds for 32-Gbps ports					
	2 Gbps	4 Gbps	8 Gbps	16 Gbps	32 Gbps	Auto
FC-AL	No available	No available	Available	Not available	Not available	Available <sup>1</sup>
P-to-P	No available	No available	Available	Available	Available	Available (default <sup>2</sup> )
Fabric	Available	Available	Available	Available	Available	Available

**Notes:**

1. If this combination is specified, the maximum transfer speed automatically specified is 8 Gbps.
2. If this default value is set, Fabric is set to ON automatically.



**Note:** The five Hitachi FC HBAs also have an alternate option of Fabric Emulation. When the HBA is configured to use this mode, treat it as an attached switch and set the storage port to Fabric = On and Connection Type = P-to-P.

- Due to high-speed serial data transfer is performed via Fibre Channel, use high-quality Fibre Channel cables that comply with the Fibre Channel-PH standard.

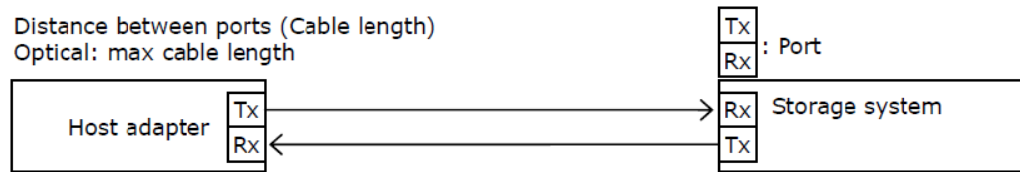

(a) Direct Connection

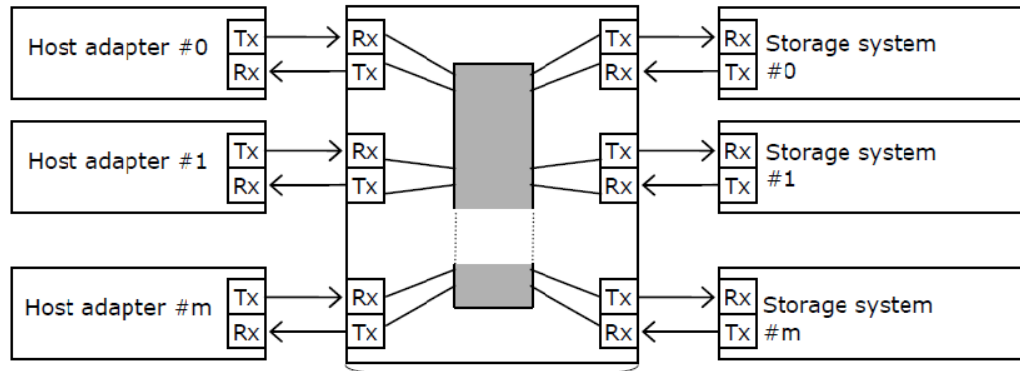

(b) Fibre Channel Switch Connection

Data transfer rate	Maximum length of cable			
	Multimode cable			Single mode cable
	OM2	OM3	OM4	
2 Gbps	984.25 ft (300 m)	1640.4 ft (500 m)	—	3280.8 ft (10 km)
4 Gbps	493 ft (150 m)	1246.72 ft (380 m)	1312.3 ft (400 m)	
8 Gbps	164.04 ft (50 m)	493 ft (150 m)	623.36 ft (190 m)	
16 Gbps	114.8 ft (35 m)	328.08 ft (100 m)	410.1 ft (125 m)	—
32 Gbps	65.62 ft (20 m)	229.7 ft (70 m)	328.08 ft (100 m)	—

The following table lists specifications of the Fibre Channel interface cable.

Cable type	Interface	Cable mode name	Nominal		
			Cable	Connector	
				One side	Other side
LC-LC cable (shortwave)	Optical	Equivalent to DXLC-2P-PC-xxM-GC50, 125-2SR (OMx)	50, 125 $\mu$ m, 62.5, 125 $\mu$ m Multimode Wavelength: 850 nm	LC connector	LC connector
LC-LC cable (longwave)		DXLC-2PS-SPC-xxM-SMC 10/125-2SR	9/125 $\mu$ m Singlemode Wavelength: 1300 nm		

The following figure shows the connector used for optical interfaces.

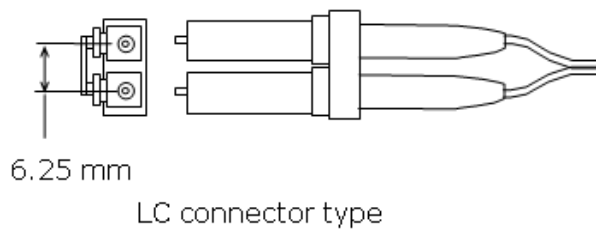

The following figure shows the type of optical connector that connects the storage system Fibre Channel ports.

- LC connector type
- **Connector type:** LC duplex receptacle connector
- **Interval:** 6.25 mm flat type, two rows

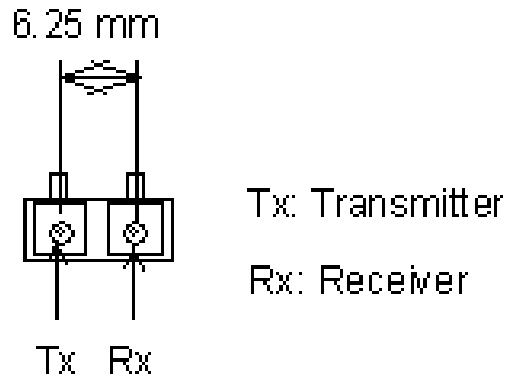

LC connector type

## iSCSI cables

When constructing an iSCSI system with a direct connection or switch connection, consider the following:

Data transfer rate	Maximum length of cable			
	Multimode cable			Single mode cable
	OM2	OM3	OM4	
10 Gbps (FCoE)	269.02 ft (82 m)	984.25 ft (300 m)	1804.46 ft (550 m)	—

### Cable specifications for iSCSI optical interface

Cable type	Interface	Cable mode name	Nominal		
			Cable	Connector	
				One side	Other side
LC-LC cable	Optical	Equivalent to DXLC-2P-PC-xxM-GC50, 125-2SR (OMx)	50, 125 mm Multimode Wavelength: 850 nm	LC connector	LC connector

The following figure shows the connector used for optical interfaces.

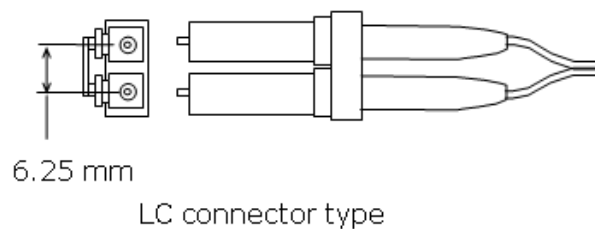

The following figure shows the type of optical connector that connects the storage system optical iSCSI ports.

- LC connector type
- **Connector type:** LC duplex receptacle connector
- **Interval:** 6.25 mm flat type, two rows

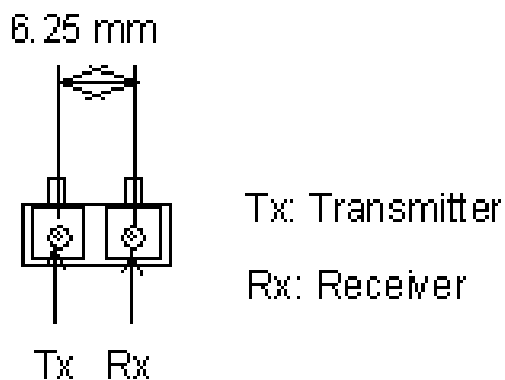

LC connector type

#### Cable specifications for 10 Gbps iSCSI copper interface

Cable type	Maximum cable connection length	Data transfer	Transmission band	Cable	Connector
Category 5e or 6a LAN cable	100 m	1 Gbps	1000BASE-T	STP ( use an STP cable that suppresses radio noise)	RJ-45
Category 6a LAN cable	50 m	10 Gbps	10GBASE-T	STP ( use an STP cable that suppresses radio noise)	RJ-45

The following figure shows a 10 Gbps iSCSI cable.

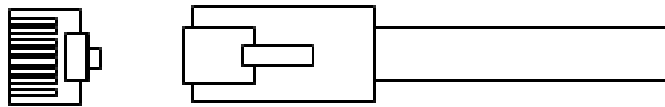

## iSCSI standards

The following standards apply to the management, maintenance, and iSCSI data ports. To configure this system, use switches that comply with the following standards:

- IEEE 802.1D STP
- IEEE 802.1w RSTP
- IEEE 802.3 CSMA/CD
- IEEE 802.3u Fast Ethernet
- IEEE 802.3z 1000 BASE-X
- IEEE 802.1Q Virtual LANs
- IEEE 802.3ae 10 Gigabit Ethernet
- RFC 768 UDP
- RFC 783 TFTP
- RFC 791 IP
- RFC 793 TCP
- RFC 1157 SNMP v1
- RFC 1231 MIB II
- RFC 1757 RMON
- RFC 1901 SNMPv2

## iSCSI specifications

Item	Specification	Comments
iSCSI target function	Supported	N/A
iSCSI target function	Supported	TrueCopy® only
iSCSI ports	2 per interface board	VSP Fx00 models: Maximum 24 per iSCSI system
Connection methods	Direct and switch connections	
Host connections	255 (maximum per iSCSI port)	With Linux software initiator, the maximum number decreases.
Path failover	HDLM <sup>1</sup>	Supports Microsoft MPIO (Multi Path I/O)
Link	10 Gbps SFP+	N/A



Item	Specification	Comments
Transfer speed	10 Gbps	N/A
Connector type	LC	N/A
Cable	Optical OM3, OM2 MMF cable	N/A
Network switch	L2 or L3 switch	Should comply with IEEE802.3ae
Switch cascading	Maximum: 5 switches or fewer	Minimum number of cascading switches is recommended.
MAC address	Per port (fixed value)	Factory setting: World Wide Unique value. Cannot be changed.
Maximum transfer unit (MTU)	1,500, 4,500, 9,000 bytes (Ethernet frame)	Jumbo frame, MTU size greater than 1500
Link aggregation	Not supported	N/A
Tagged VLAN	Supported	N/A
IPv4	Supported	N/A
IPv6	Supported	<p>Note the following precautions:</p> <ul style="list-style-type: none"> <li>▪ When iSCSI Port IPv6 is set to Enabled, if the IPv6 global address is set to automatic, the address is determined by acquiring a prefix from an IPv6 router.</li> <li>▪ If the IPv6 router does not exist in the network, the address cannot be determined. As a result, an iSCSI connection might be delayed. When an iSCSI Port IPv6 is set to Enabled, verify the IPv6 router is connected to the same network, and then set IPv6 global address automatically.</li> </ul>

Item	Specification	Comments
Subnet mask	Supported	N/A
Gateway address	Supported	N/A
DHCP	N/A	N/A
DNS	N/A	N/A
Ping (ICMP ECHO) Transmit, Receive	Supported	N/A
IPsec <sup>2</sup>	N/A	N/A
TCP port number	3260	<p>Changeable among 1 to 65,535. Observe the following if changing values:</p> <ul style="list-style-type: none"> <li>▪ The setting of the corresponding host should also be changed to log in the new port number.</li> <li>▪ The new port number might conflict with other network communication or be filtered on some network equipment, preventing the storage system from communicating through the new port number.</li> </ul>
iSCSI name	Both iqn <sup>3</sup> and eui <sup>4</sup> types are supported	The unique iqn value is automatically set when a target is made. iSCSI name is configurable.
Error recovery level	0 (zero)	Error recovery by retrying from host. Does not support Level 1 and Level 2.
Header digest	Supported	Detects header error or data error with iSCSI communication. The storage system follows the host's digest setting. If digest is enabled, the performance degrades.

Item	Specification	Comments
Data digest	Supported	The amount of the degradation depends on factors such as host performance of host and transaction pattern.
Maximum iSCSI connections at one time	255 per iSCSI port	N/A
CHAP	Supported	Authentication: login request is sent properly from host to storage. CHAP is not supported during discovery session.
Mutual (2-way) CHAP	Supported (not available if connected to Linux software initiator)	Authentication: login request is sent properly from host to storage.
CHAP user registration	Max 512 users per iSCSI port	N/A
iSNS	Supported	With iSNS (name service), a host can discover a target without knowing the target's IP address.
<p><b>Note:</b></p> <ol style="list-style-type: none"> <li>1. JP1, HiCommand Dynamic Link Manager. Pass switching is achieved. Not supported on Windows Vista and Windows 7 operating systems.</li> <li>2. IP Security. Authentication and encryption of IP packets. The storage system does not support IPsec.</li> <li>3. iqn: iSCSI Qualified Name. The iqn consists of a type identifier, "iqn," a date of domain acquisition, a domain name, and a character string given by the individual who acquired the domain. Example: <a href="#">iqn.1994-04.jp.co.hitachi:rsd.d7m.t.10020.1b000.tar</a></li> <li>4. eui: 64-bit Extended Unique Identifier. The eui consists of a type identifier, "eui," and an ASCII-coded, hexadecimal, EUI-64 identifier. Example: <a href="#">eui.0123456789abcdef</a></li> </ol>		

## Managing data cables

Organize data cables to protect the integrity of your connections and allow proper airflow around your storage system.

### Observing bend radius values

Never bend cables beyond their recommended bend radius. The following table provides general guidelines for minimum bend radius values, but you should consult the recommendation of your cable manufacturer.

Cable type	Minimum bend radius values
Fibre Channel	1.73 inch (40 mm)
iSCSI optical	1.73 inch (40 mm)
Category 5 Ethernet	Four times the outside diameter of the cable
SAS	1.73 inch (40 mm)

### Protecting cables

Damage to your Fibre Channel and Ethernet cables can affect the performance of your storage system. Observe the following guidelines to protect the cables:

- Keep cables away from sharp edges or metal corners.
- When bundling cables, do not pinch or constrict the cables.
- Do not use zip ties to bundle cables. Instead, use Velcro hook-and-loop ties that do not have hard edges and which you can remove without cutting.
- Never bundle network cables with power cables. If network and power cables are not bundled separately, electromagnetic interference (EMI) can affect your data stream.
- If you run cables from overhead supports or from below a raised floor, include vertical distances when calculating necessary cable lengths.
- If you use overhead cable supports:
  - Verify that your supports are anchored adequately to withstand the weight of bundled cables.
  - Gravity can stretch and damage cables over time. Therefore, do not allow cables to sag through gaps in your supports.
  - Place drop points in your supports that permit cables to reach racks without bending or pulling.

### Cabling full-width modules

When cabling full-width modules, such as NAS modules as shown in the following figure, route the cables horizontally, so that they do not interfere when replacing a module.

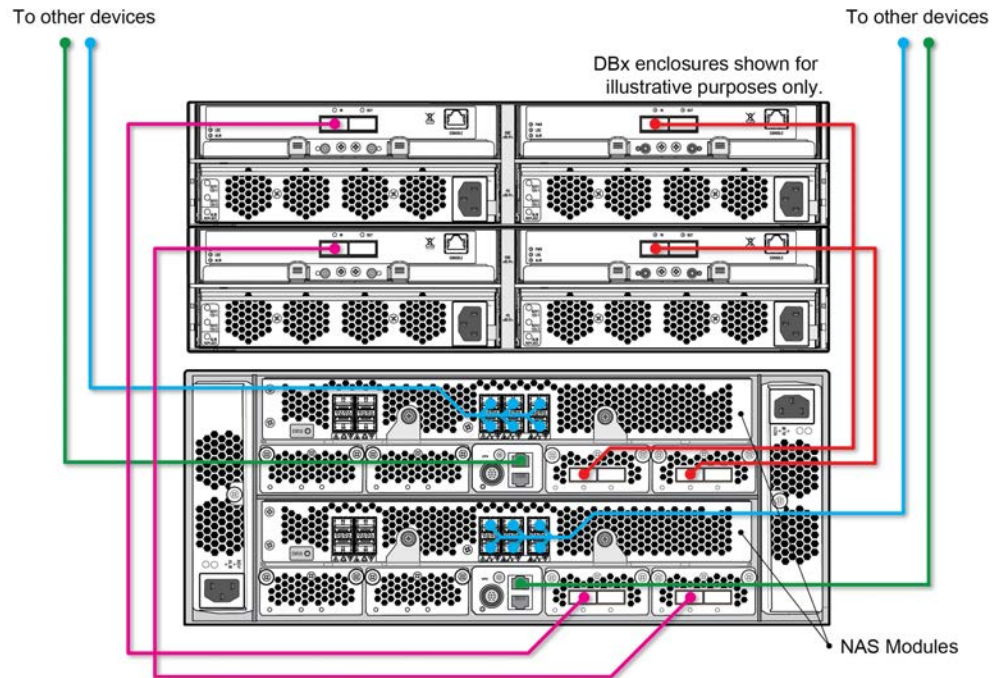

### Ensuring adequate airflow

Bundled cables can obstruct the movement of conditioned air around your storage system.

- Secure cables away from fans.
- Keep cables away from the intake holes at the front of the storage system.
- Use flooring seals or grommets to keep conditioned air from escaping through cable holes.

### Preparing for future maintenance

Design your cable infrastructure to accommodate future work on the storage system. Give thought to future tasks that will be performed on the storage system, such as locating specific pathways or connections, isolating a fault, or adding or removing components.

- Purchase colored cables or apply colored tags.
- Label both ends of every cable to denote the port to which it connects.

## Cable retention

Unintentional unplugging or unseating of a power cable can have a serious impact on the operation of an enterprise storage system. Unlike data cables, power connectors do not have built-in retention mechanisms to prevent this from happening.

To prevent accidental unplugging or unseating of power cables, the storage system includes a rubber cable-retention strap near the AC receptacle on each controller. These straps, shown in the following image, loop around the neck of a power cable connector, and the notched tail is slipped over the hook of the restraining bar fixed to the storage system.

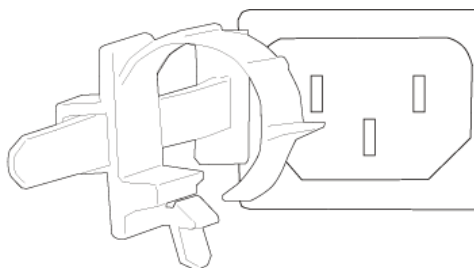

## AC power cables

Utility AC power standards for connector types and voltage levels vary by country. Hitachi provides a variety of power cables that facilitate using storage systems around the world. Hitachi power cables meet the safety standards for the country for which they are intended.

### Power cable assemblies

For information about racks and power distribution units (PDUs), refer to the *Hitachi Universal V2 Rack Reference Guide*.

Hitachi power cables consist of three parts:

- **Plug:** Male connector for insertion into the AC outlet providing power. The physical design and layout of the plug's contact meet a specific standard.
- **Cord:** Main section of insulated wires of varying length, whose thickness is determined by its current rating.
- **Receptacle:** Female connector to which the equipment attaches. The physical design and layout of the receptacle's contacts meet a specific standard. Common standards are the IEC C13 receptacle for loads up to 10 amperes (A) and the IEC C19 receptacle for loads up to 15 A.

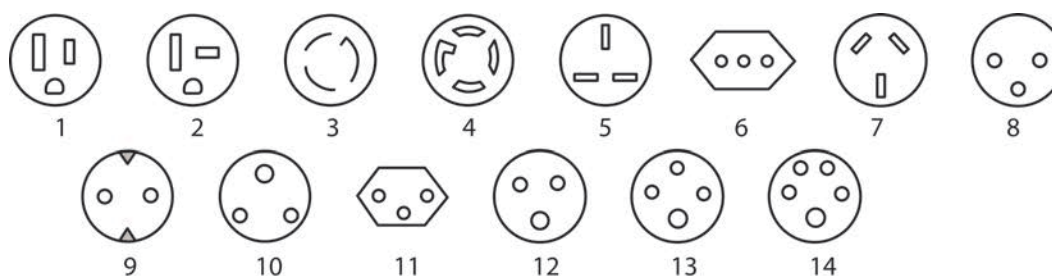

Number	Country or region	Voltage rating (VAC)	Current rating (amperes)	Plug type
1 <sup>1</sup>	North America	100-127	15	NEMA 5-15P
	Brazil	200-240	10, 20	NEMA 5-15P
	Japan	100-127	12	JIS C8303
	Taiwan	100-127	12, 16	CNS 690
2	North America	100-127	20	NEMA 5-20P
3	North America	200-240	20	NEMA L6-20P
3	North America	200-240	30	NEMA L6-30P
4 <sup>2</sup>	North America	200-240	30	NEMA L15-30P
5 <sup>3</sup>	Hong Kong	200-240	13	BS-1363
	Singapore	200-240	13	BS-1363
6	Chile	200-240	10, 16	CEI 23-50
	Italy	200-240	10, 16	CEI 23-50
7	Argentina	200-240	10, 15	IRAM 2073
	Australia	200-240	10, 15	AS-3112
	China	200-240	10, 16	GB-1002
	New Zealand	200-240	10, 15	AS-3112
8	Denmark	200-240	10	DK 2-5
	Israel	200-240	10, 16	SI-32
9 <sup>4</sup>	Europe	200-240	CEE 7, 7	
10 <sup>5</sup>	India	200-240	6, 16	IS-1293
	South Africa	200-240	10, 16	SABS-164
11	Switzerland	200-240	10	SEV 1011
12 <sup>6</sup>	International	200-240	20	IEC 309
13 <sup>7</sup>	United Kingdom	200-240	13	BS-1363
	International	200-240	20	IEC 309
14 <sup>8</sup>	International	200-240	30	IEC 309

Number	Country or region	Voltage rating (VAC)	Current rating (amperes)	Plug type
<b>Notes:</b>				
<ol style="list-style-type: none"> <li>1. Also used for 200-240 VAC applications in Korea and Philippines.</li> <li>2. Three-phase AC.</li> <li>3. Also Malaysia and Ireland.</li> <li>4. Also known as "Schuko" connector and used in Austria, Belgium, Finland, France, Germany, Greece, Hungary, Indonesia, Netherlands, Norway, Poland, Portugal, Russia, Spain, and Sweden.</li> <li>5. Supersedes type BS 546.</li> <li>6. 3-wire (two-phase and earth). Physical variations (connector size and color) indicate amperage rating. Used in Switzerland for a true 16 A application.</li> <li>7. 4-wire (three-phase and earth). Physical variations (connector size and color) indicate amperage rating.</li> <li>8. 5-wire (three-phase, earth and neutral). Physical variations (connector size and color) indicate amperage rating.</li> </ol>				

## AC connections

The following table shows and describes the types of AC connections on your storage system.

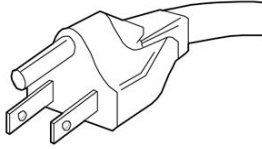
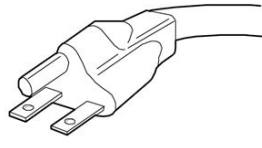
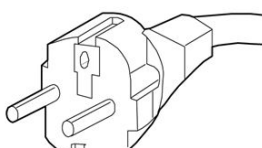
Description	Receptacle	Input rating	Reference standards
NEMA 5-15P		100V-120V (standard attachment)	1 ANSI C73.11 2 NEMA 5-15P 3 IEC 83
NEMA L6-20P		200V-240V	1 ANSI C73.11 2 NEMA 6-15P 3 IEC 83
CEE 7/7		200V-240V	4 CEE (7) II, IV, VII 3 IEC 83

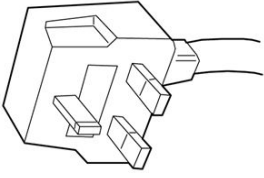
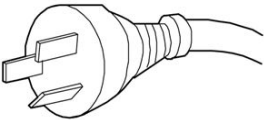

Description	Receptacle	Input rating	Reference standards
BS-1363		200V-240V	5 BS 1365 3 IEC 83
AS-3112		200V-240V	6 AS C112

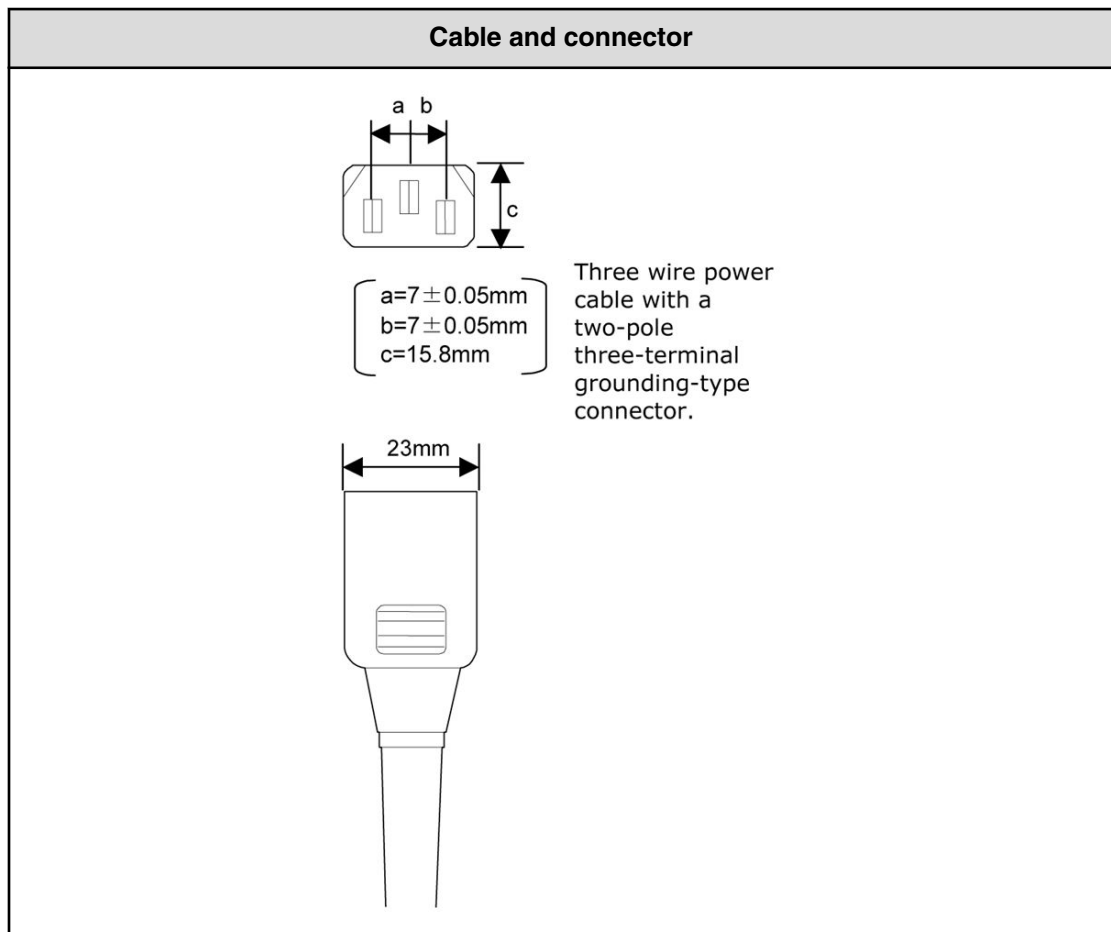

## Power cable usage guidelines

Hitachi storage systems are intended for rack installation and ship with power cords. Installation and service requirements may require additional cords and cables to be ordered. The type of power cable required by a given installation is determined primarily by the:

- Type of AC line feed provided by the facility.
- Type of AC source (wall outlet or modular and monitored PDU) to be used.
- Serviceability of components to be connected.

Storage systems require a country-specific power cable for direct connection to a facility AC feed.

Storage systems are designed to allow replacement of hot-pluggable components without removing the chassis from the rack. As a result, power cables can be short because cable movement is of minimal consideration.

## Three-phase power considerations for racks

Increasing power requirements for racks are making the use of three-phase power at the rack level compelling.

- With single-phase power, at any given time the voltage across the hot and neutral conductors can be anywhere between its peak (maximum) and zero. Electrical conductors must be large to meet high amperage requirements.
- Three-phase power uses three cycles that are 120 degrees out of phase, which never allows the voltage to drop to zero. The more consistent voltage derived from the three hot conductors results in smoother current flow and allows small-gauge conductors to be used to distribute the same amount of AC power. As a result, the load balancing and increased power handling capabilities of three-phase distribution can result in more efficient and less costly installations that require fewer AC cables and PDUs.

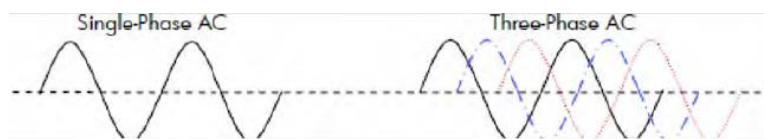

## Cable management

Rack installations should be planned for operational efficiency, ease of maintenance, and safety. Hitachi offers the Backend Configuration Utility (BECK), a graphical, cable-management application that can relieve the typical cable congestion created when populating a rack with storage systems and their accessories.

## Cable retention

Unintentional unplugging or unseating of a power cable can have a serious impact on the operation of an enterprise storage system. Unlike data cables, power connectors do not have built-in retention mechanisms to prevent this from happening.

To prevent accidental unplugging or unseating of power cables, the storage system includes a rubber cable-retention strap near the AC receptacle on each controller. These straps, shown in the following image, loop around the neck of a power cable connector, and the notched tail is slipped over the hook of the restraining bar fixed to the storage system.

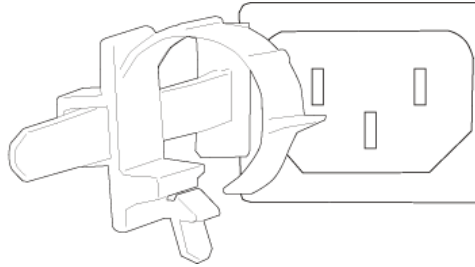

## Data and power cable model list

The following tables list the data and power cables available to the storage system.

**Table 3 Power cables**

Model number	Specification
DW-F800-J1K	2.5 m, 2-pole power cable with grounding terminal (AC 125 V, 13 A or 15 A)
DW-F800-J2H	2.5 m, 2-pole power cable with grounding terminal (AC 250 V, 13 A or 15 A)
DW-F800-J2H5	5.0 m, 2-pole power cable with grounding terminal (AC 250 V, 13 A or 15 A)
DW-F800-J2H10	10.0 m, 2-pole power cable with grounding terminal (AC 250 V, 13 A or 15 A)
A-F6516-P620	Power cable for PDU (1)
A-F6516-P630	Power cable for PDU (1)

**Table 4 SAS cables**

<b>Model number</b>	<b>Specification</b>
DW-F800-SCQ1	1 m SAS cable, including omega clip (2)
DW-F800-SCQ1F	1.5 m SAS cable, including omega clips (2)
DW-F800-SCQ3	3 m SAS cable, including omega clips (2)
DW-F800-SCQ5	5 m SAS cable, including omega clips (2)
DW-F800-SCQ10A	10 m SAS optical cable
DW-F800-SCQ30A	30 m SAS optical cable
DW-F800-SCQ1HA	100 m SAS optical cable

**Table 5 Optical cables**

<b>Model number</b>	<b>Specification</b>
A-6515-GM5L	5 m LC-LC optical cable for optical
A-6515-GM10L	10 m LC-LC optical cable for optical
A-6515-GM20L	20 m LC-LC optical cable for optical
A-6515-GM30L	30 m LC-LC optical cable for optical
A-6515-GM40L	40 m LC-LC optical cable for optical
A-6515-GM50L	50 m LC-LC optical cable for optical
A-6515-GM1JL	100 m LC-LC optical cable for optical
A-6515-GS10L	10 m LC-LC optical cable for optical
A-6515-GS20L	20 m LC-LC optical cable for optical
A-6515-GS30L	30 m LC-LC optical cable for optical
A-6515-GS50L	50 m LC-LC optical cable for optical
A-6515-GS1JL	100 m LC-LC optical cable for optical
A-6515-HM5L	5 m LC-LC optical cable for optical
A-6515-HM10L	10 m LC-LC optical cable for optical
A-6515-HM20L	20 m LC-LC optical cable for optical
A-6515-HM30L	30 m LC-LC optical cable for optical
A-6515-HM50L	50 m LC-LC optical cable for optical
A-6515-HM100L	100 m LC-LC optical cable for optical
A-6515-HM200L	200 m LC-LC optical cable for optical
A-6515-HM300L	300 m LC-LC optical cable for optical
A-6515-JM5L	5 m LC-LC optical cable for optical
A-6515-JM10L	10 m LC-LC optical cable for optical
A-6515-JM20L	20 m LC-LC optical cable for optical
A-6515-JM30L	30 m LC-LC optical cable for optical
A-6515-JM50L	50 m LC-LC optical cable for optical
A-6515-JM100L	100 m LC-LC optical cable for optical
A-6515-JM200L	200 m LC-LC optical cable for optical

<b>Model number</b>	<b>Specification</b>
A-6515-JM300L	300 m LC-LC optical cable for optical

## Appendix G: Port address mapping

### Port address mapping

Each fibre channel port has a default port address (AL\_PA) of EF. You do not have to change this value because the storage system port can connect to the host bus adapter (HBA) with the current setting.

If you want to change the AL\_PA value, however, select a value from the following table.

If you use a value that is not in the following table or is already used by the HBA, the host might not be able to recognize the VOL. If this problem or other problems occur, revert to the default value of EF.

EF*	CD	B2	98	72	55	3A	25
E8	CC	B1	67	7	64	39	23
E4	CB	AE	90	6E	53	36	1F
E2	CA	AD	8F	6D	52	35	1E
E1	C9	AC	88	6C	51	34	1D
E0	C7	AB	84	6B	4E	33	1B
DC	C6	AA	82	6A	4D	32	18
DA	C5	A9	81	69	4C	31	17
D9	C3	A7	80	67	4B	2E	10
D6	BC	A6	7C	66	4A	2D	0F
D5	BA	A5	7A	65	49	2C	08
D4	B9	A3	79	63	47	2B	04
D3	B6	9F	76	5C	46	2A	02
D2	B5	9E	75	5A	45	29	01
D1	B4	9D	74	59	43	27	N/A
CE	B3	9B	73	56	3C	26	N/A

\* A value set as the default value.

## Appendix H: Third-party racks

All VSP F series storage systems can be installed into third-party racks.

The following describes the requirements and guidelines for installing the storage system into a third-party rack.

### Third-party rack support

The storage system supports third-party racks that meet Hitachi Vantara specifications.

Observe the following mounting guidelines for third-party racks:

- The VSP Fx00 models support any 4-post, EIA-310-D compliant rack that has adequate airflow and weight capacity.
- PDUs must be mounted properly, with no serviceability issues. The PDU receptacles must face toward the back (not toward each other). The area behind the storage system and between the vertical 19-inch mounting posts must be free of PDUs and cable loops.

### Hitachi Universal V2 Rack rail kits

Use rail kits to mount the Hitachi Virtual Storage Platform family storage system in a Hitachi Universal V2 Rack.

The following tables list the rail kit information for the specified storage systems.

**Table 6 Rail kits for VSP Fx00 models**

Rail kit	Hitachi Universal V2 Rack	Third-party rack
Controller	UNI <sup>1</sup>	UNI <sup>1</sup>
DBS, DBL, and DBF drive trays	CGR <sup>2</sup>	UNI <sup>1</sup>
DB60 dense intermix drive tray	Use the rail kit supplied with the DB60 dense intermix drive tray.	
SVP server	Use the rail kit supplied with the SVP server.	
<b>Notes:</b>		
1. UNI: Universal rail kit A34V-600-850-UNI.		



Rail kit	Hitachi Universal V2 Rack	Third-party rack
2. CGR: Corner guide rail kit A3BF-HK-GL-740-1.		

## Hitachi Universal V2 Rack accessories

The following table provides rack accessory information for VSP F series storage systems.

**Table 7 Accessories for the Hitachi Universal V2 Rack**

Storage system	Front door	Rear door	Side panels
VSP Fx00 models	Optional, must be ordered separately (A3BF-DR).	Included with rack	Not included with rack, must be ordered separately. A quantity of two must be ordered per rack (A3BF-Z-PAN-1200).

## Third-party rack support for DB60 dense intermix drive trays

Due to the size and weight of the DB60 dense intermix drive trays used with VSP Fx00 models, pay close special attention when mounted in third-party racks.

When mounting DB60 dense intermix drive trays in third-party racks, observe the following guidelines and see the following figure.

- Use anti-tilt floor plates or ceiling-mounted fixing brackets to stabilize the rack.
- Use a rack that is at least 40.94 in. (1040 mm) deep to accommodate the DB60 dense intermix drive tray and cable-management arms.
- Dense tray rail kits require square mounting holed racks.
- Use a ladder to service the DB60 dense intermix drive tray if the drive tray is mounted above shelf height RU32.

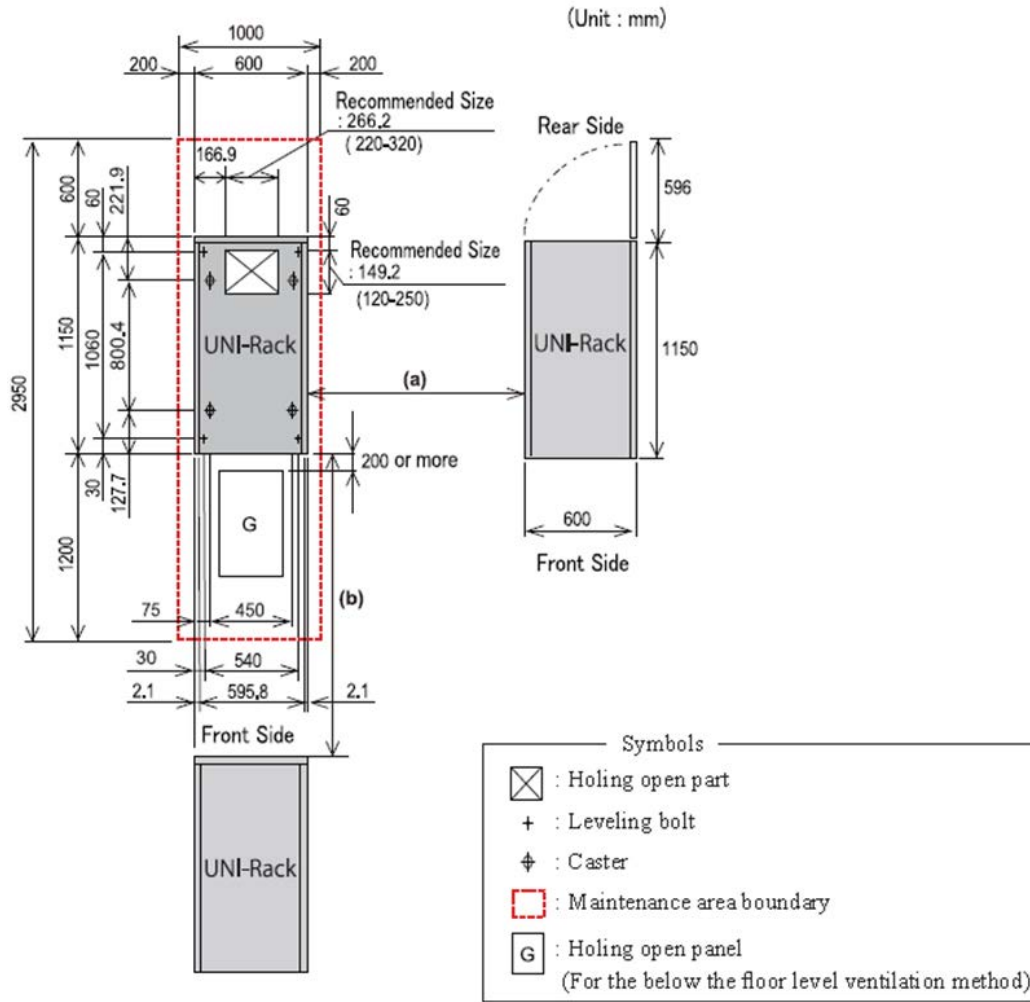

## Appendix I: Power distribution units for Hitachi Universal V2 Rack

The Hitachi Universal V2 Rack is equipped with specific power distribution units (PDU) for Americas, APAC, and EMEA regions. The PDUs can provide electrical power to the storage system in a single-phase or three-phase configuration.



### Caution:

- Before installing third-party devices into the rack, check the electrical current draw of each device. Verify the electrical specifications and allowable current load on each PDU before plugging the device into the PDU.
- Balance the electrical current load between available PDUs.

### Americas single-phase PDU 1P30A-8C13-3C19UL.P

The following figure and table describes the specifications of the PDU.

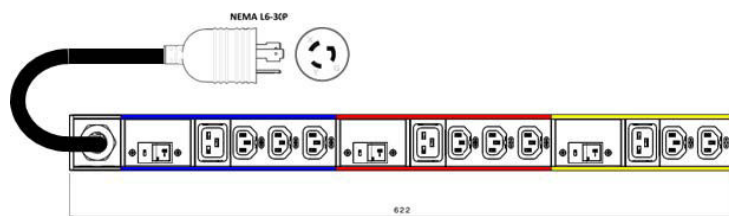
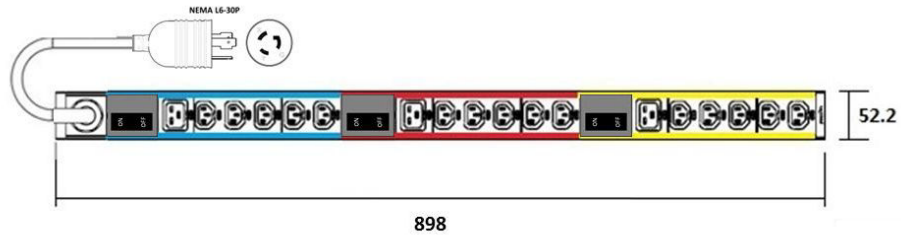

**Figure 1 Americas PDU for the Hitachi Universal V2 Rack (Single-phase PDU 1P30A-8C13-3C19UL.P)**

Part Number	Region	Phase	Description
1P30A-8C13-3C19U L.P	Americas	Single	<ul style="list-style-type: none"> <li>▪ 208V, 30A (24A rated) 60Hz</li> <li>▪ 8 IEC C13 + 3 IEC C19 sockets</li> <li>▪ NEMA L6-30P input power plug</li> <li>▪ 4.5 m (14.76 feet) cable</li> </ul>

## Americas single-phase PDU 1P30A-15C13-3C19UL.P

The following figure and table describes the specifications of the PDU.

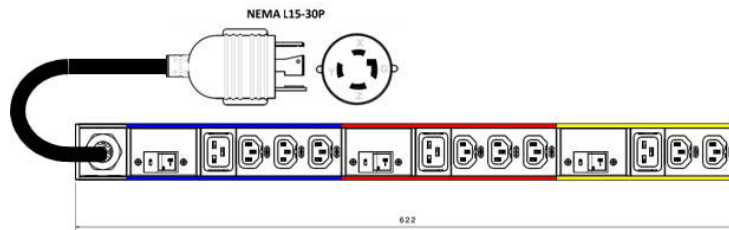

**Figure 2 Americas PDU for the Hitachi Universal V2 Rack (Single-phase PDU 1P30A-15C13-3C19UL.P)**

Part Number	Region	Phase	Description
1P30A-15C13-3C19UL.P	Americas	Single	<ul style="list-style-type: none"> <li>208V, 30A (24A rated) 60Hz</li> <li>15 IEC C13 + 3 IEC C19 sockets</li> <li>NEMA L6-30P input power plug</li> <li>4.5 m (14.76 feet) cable</li> </ul>

## Americas three-phase PDU 3P30A-8C13-3C19UL.P

The following figure and table describes the specifications of the PDU.

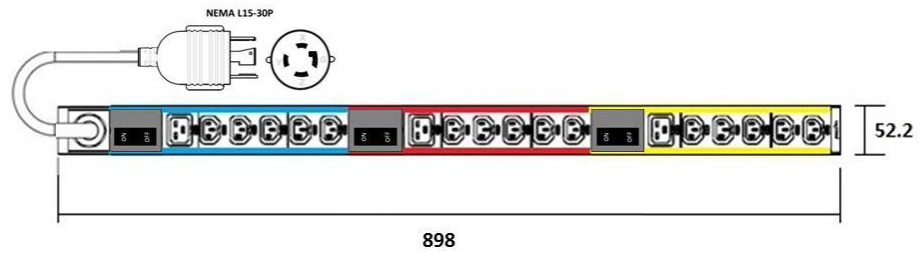

**Figure 3 Americas PDU for the Hitachi Universal V2 Rack (Three-phase PDU 3P30A-8C13-3C19UL.P)**

Part Number	Region	Phase	Description
3P30A-8C13-3C19U L.P	Americas	Three	<ul style="list-style-type: none"> <li>▪ 208V 3P, 30A (24A rated) 60Hz</li> <li>▪ 8 IEC C13 + 3 IEC C19 sockets</li> <li>▪ NEMA L15-30P input power plug</li> <li>▪ 4.5 m (14.76 feet) cable</li> </ul>

## Americas three-phase PDU 3P30A-15C13-3C19UL.P

The following figure and table describes the specifications of the PDU.

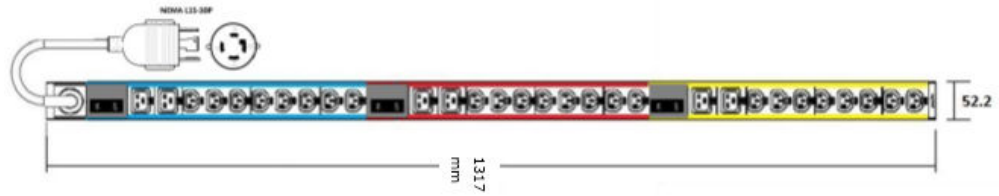

**Figure 4 Americas PDU for the Hitachi Universal V2 Rack (Three-phase PDU 3P30A-15C13-3C19UL.P)**

Part Number	Region	Phase	Description
3P30A-15C13-3C19UL.P	Americas	Three	<ul style="list-style-type: none"> <li>208V 3P, 30A (24A rated) 60Hz</li> <li>15 IEC C13 + 3 IEC C19 sockets</li> <li>NEMA L15-30P input power plug</li> <li>4.5 m (14.76 feet) cable</li> </ul>

## Americas three-phase PDU 3P30A-24C13-6C19UL.P

The following figure and table describes the specifications of the PDU.

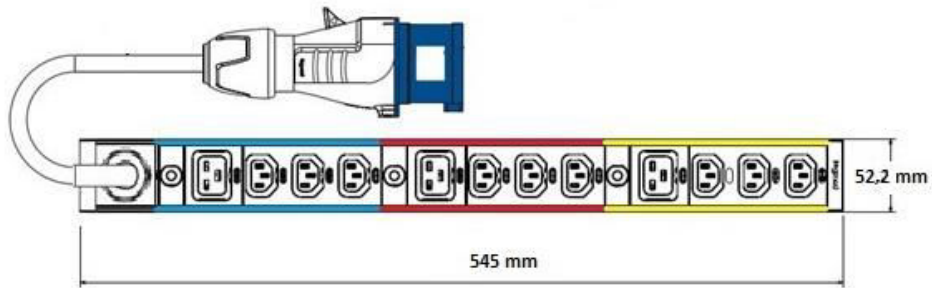

**Figure 5 Americas PDU for the Hitachi Universal V2 Rack (Three-phase PDU 3P30A-24C13-6C19UL.P)**

Part Number	Region	Phase	Description
3P30A-24C13-6C19 UL.P	Americas	Three	<ul style="list-style-type: none"> <li>▪ 208V 3P, 30A (24A rated) 60Hz</li> <li>▪ 24 IEC C13 + 6 IEC C19 sockets</li> <li>▪ NEMA L15-30P input power plug</li> <li>▪ 4.5 m (14.76 feet) cable</li> </ul>

## APAC and EMEA single-phase PDU 1P32A-9C13-3C19CE.P

The following figure and table describes the specifications of the PDU.



**Figure 6 APAC and EMEA PDU for the Hitachi Universal V2 Rack (Single-phase 1P32A-9C13-3C19CE.P)**

Part Number	Region	Phase	Description
1P32A-9C13-3C19C E.P	APAC and EMEA	Single	<ul style="list-style-type: none"> <li>230V max. 32A 50Hz / 60Hz</li> <li>9 IEC C13 + 3 IEC C19 sockets</li> <li>IEC309 Blue 2P + E input power plug</li> <li>4.5 m (14.76 feet) cable</li> </ul>

## APAC and EMEA single-phase PDU 1P32A-18C13-3C19CE.P

The following figure and table describes the specifications of the PDU.



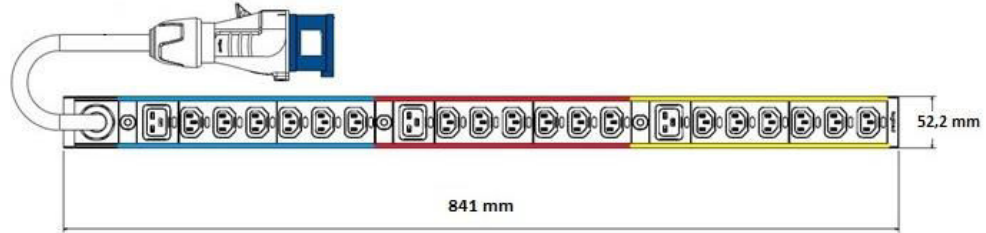
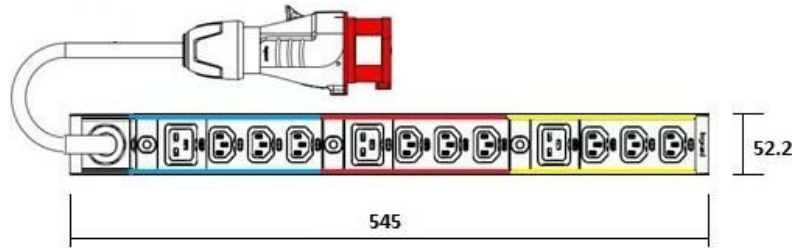

**Figure 7 APAC and EMEA PDU for the Hitachi Universal V2 Rack (Single-phase 1P32A-18C13-3C19CE.P)**

Part Number	Region	Phase	Description
1P32A-18C13-3C19 CE.P	APAC and EMEA	Single	<ul style="list-style-type: none"> <li>▪ 230V max. 32A 50Hz / 60Hz</li> <li>▪ 18 IEC C13 + 3 IEC C19 sockets</li> <li>▪ IEC309 Blue 2P + E input power plug</li> <li>▪ 4.5 m (14.76 feet) cable</li> </ul>

## APAC and EMEA three-phase PDU 3P16A-9C13-3C19CE.P

The following figure and table describes the specifications of the PDU.

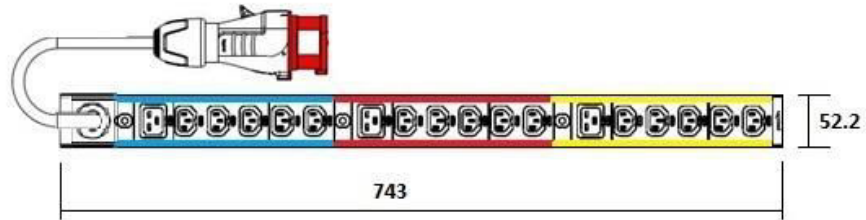

**Figure 8 APAC and EMEA PDU for the Hitachi Universal V2 Rack (Three-phase 3P16A-9C13-3C19CE.P)**

Part Number	Region	Phase	Description
3P16A-9C13-3C19C E.P	APAC and EMEA	Three	<ul style="list-style-type: none"> <li>▪ 400V max. 3x 16A 50Hz / 60Hz</li> <li>▪ 9 IEC C13 + 3 IEC C19 sockets</li> <li>▪ IEC309 Red 3P + N + E input power plug</li> <li>▪ 4.5 m (14.76 feet) cable</li> </ul>

## APAC and EMEA three-phase PDU 3P16A-15C13-3C19CE.P

The following figure and table describes the specifications of the PDU.

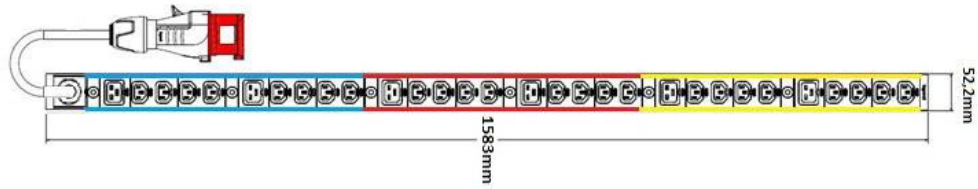

**Figure 9 APAC and EMEA PDU for the Hitachi Universal V2 Rack (Three-phase 3P16A-15C13-3C19CE.P)**

Part Number	Region	Phase	Description
3P16A-15C13-3C19 CE.P	APAC and EMEA	Three	<ul style="list-style-type: none"> <li>▪ 400V max. 3x 16A 50Hz / 60Hz</li> <li>▪ 15 IEC C13 + 3 IEC C19 sockets</li> <li>▪ IEC309 Red 3P + N + E input power plug</li> <li>▪ 4.5 m (14.76 feet) cable</li> </ul>

## APAC and EMEA three-phase PDU 3P32A-24C13-6C19CE.P

The following figure and table describes the specifications of the PDU.



**Figure 10 APAC and EMEA PDU for the Hitachi Universal V2 Rack (Three-phase 3P32A-24C13-6C19CE.P)**

Part Number	Region	Phase	Description
3P32A-24C13-6C19 CE.P	APAC and EMEA	Three	<ul style="list-style-type: none"> <li>▪ 400V max. 3x 32A 50Hz / 60Hz</li> <li>▪ 24 IEC C13 + 6 IEC C19 sockets</li> <li>▪ IEC309 Red 3P + N + E input power plug</li> <li>▪ 4.5 m (14.76 feet) cable</li> </ul>

---

## Appendix J: Regulatory compliance

This equipment has been tested and certified for compliance with the following standards.

**Table 8 Country Specifications and Certifications**

<b>Standard</b>	<b>Specification</b>	<b>Product marking or logo</b>	<b>Country regulation</b>
Electronic emission controls	FCC part 15 Subpart B:2013	FCC	USA and Canada
	ICES-003 Issue 5:2012	ICES-003	USA and Canada
	AS/NZS CISPR 22:2009+A1	RCM	Australia and New Zealand
	TP TC 020/2011	EAC	Russia, Belarus, and Kazakhstan
	CNS 13438	BSMI	Taiwan
	KN22	KC	Korea
	KN24	KC	Korea
Electronic emission certifications	EN5522: 2010	CE	EU
	EN5524: 2010	CE	EU
	EN61000-3.2:2006+A1+A2	CE	EU
	EN61000-3.3:2008	CE	EU
Safety certifications	UL and CSA 60950-1:2007	cTUVus	USA and Canada
	EN60950-1:2006+A1	TUV	Germany
	IEC60950-1:2005+A1	N/A	All CB countries
	IEC60950-1:2005+A1	S-Mark	Argentina
	TP TC 004/2011	EAC	Russia
	CNS 14336-1	BSMI	Taiwan
	EN60950-1:2006+A1	CE	EU
Radio interference voluntary control	VCCI V-3/2013.04	VCCI	Japan

---

## Appendix K: Safety and environmental notices

### Equipment warranty

The term of guarantee of normal operation of the storage system and free service is one year from date of purchase. If a failure occurs multiple times, the storage system might shut off to avoid a serious accident.

### Notice of export controls

Export of technical data contained in this document might require an export license from the United States government, the government of Japan, or both. Contact the Hitachi Legal Department for guidance about any export compliance questions.

### Backup

Hitachi cannot guarantee against data loss due to failures. Therefore, back up your data to minimize chances for data loss.

Data backup is also critical when hardware components are added or replaced, because performing such hardware procedures restores parameter settings that can affect how data is managed on the storage systems.

### Disposal



This symbol on the product or on its packaging means that your electrical and electronic equipment should be disposed at the end of life separately from your household wastes.

There are separate collection systems for recycling in the European Union. For more information, contact the local authority or the dealer where you purchased the product.

### Recycling

A nickel-metal hydride battery is used in the Cache Backup Battery.

A nickel-metal hydride battery is a resource that can be recycled. When you want to replace the Cache Backup Battery, call the service personnel. They will dispose of it for you. This nickel-metal hydride battery, which is designated as recycling product by a recycling promotion law, must be recycled.

The mark posted on the Cache Backup Battery is a three-arrow mark that indicates a recyclable part.



### UEFI Development Kit 2010

This product includes UEFI Development Kit 2010 written by the UEFI Open Source Community. For more information, see the UEFI Development Kit website:

<http://sourceforge.net/apps/mediawiki/tianocore/index.php?title=UDK2010>

© 2004, Intel Corporation.

All rights reserved.

Redistribution and use in source and binary forms, with or without modification, are permitted provided that the following conditions are met:  
Redistributions of source code must retain the above copyright notice, this list of conditions and the following disclaimer.

Redistributions in binary form must reproduce the above copyright notice, this list of conditions and the following disclaimer in the documentation and/or other materials provided with the distribution.

Neither the name of the Intel Corporation nor the names of its contributors might be used to endorse or promote products derived from this software without specific prior written permission.

THIS SOFTWARE IS PROVIDED BY THE COPYRIGHT HOLDERS AND CONTRIBUTORS "AS IS" AND ANY EXPRESS OR IMPLIED WARRANTIES, INCLUDING, BUT NOT LIMITED TO, THE IMPLIED WARRANTIES OF MERCHANTABILITY AND FITNESS FOR A PARTICULAR PURPOSE ARE DISCLAIMED. IN NO EVENT SHALL THE COPYRIGHT OWNER OR CONTRIBUTORS BE LIABLE FOR ANY DIRECT, INDIRECT, INCIDENTAL, SPECIAL, EXEMPLARY, OR CONSEQUENTIAL DAMAGES (INCLUDING, BUT NOT LIMITED TO, PROCUREMENT OF SUBSTITUTE GOODS OR SERVICES; LOSS OF USE, DATA, OR PROFITS; OR BUSINESS INTERRUPTION) HOWEVER CAUSED AND ON ANY THEORY OF LIABILITY, WHETHER IN CONTRACT, STRICT LIABILITY, OR TORT (INCLUDING NEGLIGENCE OR OTHERWISE) ARISING IN ANY WAY OUT OF THE USE OF THIS SOFTWARE, EVEN IF ADVISED OF THE POSSIBILITY OF SUCH DAMAGE.

## **FDA radiation regulation**

The array complies with FDA radiation performance standard 21 CFR subchapter J.

## **EMI regulation**

This equipment has been tested and found to comply with the limits for a Class A digital device, pursuant to Part 15 of the FCC Rules. These limits are designed to provide reasonable protection against harmful interference when the equipment is operated in a commercial environment. This equipment generates, uses, and can radiate radio frequency energy and, if not installed and used in accordance with the instruction manual, may cause harmful interference in which case the user will be required to correct the interference at his own expense. Testing was done with shielded cables. Therefore, in order to comply with the FCC regulations, you must use shielded cables with your installation.

This product must not be used in residential areas.

This is a class A product. In a domestic environment this product can cause radio interference in which case the user can be required to take adequate measures.



---

# Index

## Numerics

- 10-Gbps iSCSI board (copper) 22
- 10-Gbps iSCSI board (optical) 22
- 16-Gbps Fibre Channel board 24, 26
- 32-Gbps Fibre Channel board 24
- 8-Gbps Fibre Channel board 24

## A

- AC
  - connections 88
- AC power cables 86
- AC power supply units
  - large form factor drive tray 33
  - small form factor drive tray 33
- audience 7

## B

- back end module
  - LEDs and connectors 28
- battery
  - unit 69
- bezels
  - CBLH controller 16
  - flash module drive tray 35
  - small form factor drive tray 30
- block 11

## C

- cables
  - AC power 86
  - Fibre Channel 73
  - iSCSI 77
  - managing 83
  - required 70
  - retention 85, 90
- CBLH controller
  - rear panel 19
  - with front panel bezel 16
- CBLM controller

- CBLM controller (*continued*)
  - rear panel 19
- chassis 39
- compliance 109
- configuration 11, 12
- configurations 14
- connections
  - AC 88
- controllerbattery
  - connectors 16
  - drive tray ports 16
  - fan 16
  - LED indicator 16
  - power supply unit 16
- controllers
  - CBLH 16

## D

- data cable 91
- data cables 70
- DC power supply units
  - large form factor drive tray 34
  - small form factor drive tray 34
- drive chassis
  - fan 30
  - LEDs 30
  - power supply 30
- drive trays
  - flash module 34
  - maximum number 15
  - small form-factor 30

## E

- electrical specifications 60
- environmental 61
- environmental specifications 61

## F

- fan

- fan (*continued*)
  - host port expansion chassis 40
- features 14
- Fibre Channel
  - cables 73
- flash module drive tray
  - rear panel 37
  - with front panel bezel 35
  - without front panel bezel 36
- front door 97
- front end modules
  - 10-Gbps iSCSI board (copper) 22
  - 10-Gbps iSCSI board (optical) 22
  - 16-Gbps Fibre Channel board 24, 26
  - 32-Gbps Fibre Channel board 24
  - 8-Gbps Fibre Channel board 24
- front panel bezels
  - CBLH controller 16
  - flash module drive tray 35
  - host port expansion chassis 39
  - small form factor drive tray 30

**H**

- hardware
  - specifications 46
- Hitachi Virtual Storage Platform F800VSP F800 12
- host 21, 46
- host port expansion 39
- host port expansion chassis
  - fan 40
  - front panel bezel LEDs 39
  - power supply 42

**I**

- interconnect adapter
  - Fibre Channel 39
  - iSCSI 39
  - PCIe board 39
- iSCSI
  - cables 77
  - specifications 64, 80
  - standards 64, 80

**L**

- LAN blade LEDs and connectors 28
- large form factor drive tray
  - AC power supply unit 33
  - DC power supply units 34

**M**

- maintaining the storage system 50
- managing cables 83
- maximum
  - number of mounted drives 15
- mechanical 51
- mechanical specifications 51
- module 44
- mounted drive trays 15

**N**

- NAS 44
- network 21
- network device 39
- number of mounted drive trays 15

**O**

- overview 11

**P**

- PCIe cable connector
  - LEDs 41
- PCIe switchboard
  - LED 39
- physical SVP
  - rear panel 49
- Port
  - address mapping 95
- ports 21
- power cable 91
- power cable assemblies 86
- power cables
  - AC 86
- power distribution unit
  - overview 99
  - specifications
    - Americas
      - single-phase 99, 100
      - three-phase 100–102
    - APAC and EMEA
      - single-phase 103, 104
      - three-phase 105–107
- power off 50
- power on 50
- power supply unit 21
- power supply units
  - host port expansion chassis 42
- powering off the storage system 50

product version 7

## R

rack accessories 97

rail kits 96

rear door 97

rear panel of physical SVP 49

rear panels

    CBLH controller 19

    CBLM controller 19

    flash module drive tray 37

    small form factor drive tray 32

regulatory compliance 109

replacement parts

    battery unit 69

required cables 70

retention, cables 85, 90

## S

scalability 14

server 46

service processor 46, 47

side panels 97

small form factor drive tray

    AC power supply unit 33

    DC power supply units 34

    rear panel 32

    with front panel bezel 30

    without bezel 31

small form-factor drive tray 30

specifications

    electrical 60

    environmental 61

    hardware 46

    iSCSI 64, 80

    mechanical 51

standards 64

standards for iSCSI 64, 80

storage 51

storage system

    maintenance 50

    power off 50

    regulatory compliance 109

    storing 50

storage system controllers

    CBLH 16

storage system specifications

    electrical 60

store 50

storing the storage system 50

supported configurations 14

SVP

    hardware specifications 46

## T

third-party rack

    DB60 dense intermix drive tray 97

third-party racks 96

third-party racksmounting guidelines 96

## U

Unified 12

## W

without front panel bezel 17

**Hitachi Vantara Corporation**



Corporate Headquarters

2845 Lafayette Street

Santa Clara, CA 95050-2639 USA

[www.HitachiVantara.com](http://www.HitachiVantara.com) | [community.HitachiVantara.com](http://community.HitachiVantara.com)

Regional Contact Information

Americas: +1 866 374 5822 or [info@hitachivantara.com](mailto:info@hitachivantara.com)

Europe, Middle East, and Africa: +44 (0) 1753 618000 or [info@emea@hitachivantara.com](mailto:info@emea@hitachivantara.com)

Asia Pacific: + 852 3189 7900 or [info.marketing.apac@hitachivantara.com](mailto:info.marketing.apac@hitachivantara.com)