

Hitachi Virtual Storage Platform E990

93-04-01

Hardware Reference Guide

This document provides information about the system hardware components and the mechanical and environmental specifications for the VSP E990 storage system.

© 2020, 2021 Hitachi, Ltd. All rights reserved.

No part of this publication may be reproduced or transmitted in any form or by any means, electronic or mechanical, including copying and recording, or stored in a database or retrieval system for commercial purposes without the express written permission of Hitachi, Ltd., or Hitachi Vantara LLC (collectively "Hitachi"). Licensee may make copies of the Materials provided that any such copy is: (i) created as an essential step in utilization of the Software as licensed and is used in no other manner; or (ii) used for archival purposes. Licensee may not make any other copies of the Materials. "Materials" mean text, data, photographs, graphics, audio, video and documents.

Hitachi reserves the right to make changes to this Material at any time without notice and assumes no responsibility for its use. The Materials contain the most current information available at the time of publication.

Some of the features described in the Materials might not be currently available. Refer to the most recent product announcement for information about feature and product availability, or contact Hitachi Vantara LLC at <https://support.hitachivantara.com/en-us/contact-us.html>.

Notice: Hitachi products and services can be ordered only under the terms and conditions of the applicable Hitachi agreements. The use of Hitachi products is governed by the terms of your agreements with Hitachi Vantara LLC.

By using this software, you agree that you are responsible for:

1. Acquiring the relevant consents as may be required under local privacy laws or otherwise from authorized employees and other individuals; and
2. Verifying that your data continues to be held, retrieved, deleted, or otherwise processed in accordance with relevant laws.

Notice on Export Controls. The technical data and technology inherent in this Document may be subject to U.S. export control laws, including the U.S. Export Administration Act and its associated regulations, and may be subject to export or import regulations in other countries. Reader agrees to comply strictly with all such regulations and acknowledges that Reader has the responsibility to obtain licenses to export, re-export, or import the Document and any Compliant Products.

Hitachi and Lumada are trademarks or registered trademarks of Hitachi, Ltd., in the United States and other countries.

AIX, AS/400e, DB2, Domino, DS6000, DS8000, Enterprise Storage Server, eServer, FICON, FlashCopy, GDPS, HyperSwap, IBM, Lotus, MVS, OS/390, PowerHA, PowerPC, RS/6000, S/390, System z9, System z10, Tivoli, z/OS, z9, z10, z13, z14, z/VM, and z/VSE are registered trademarks or trademarks of International Business Machines Corporation.

Active Directory, ActiveX, Bing, Excel, Hyper-V, Internet Explorer, the Internet Explorer logo, Microsoft, the Microsoft Corporate Logo, MS-DOS, Outlook, PowerPoint, SharePoint, Silverlight, SmartScreen, SQL Server, Visual Basic, Visual C++, Visual Studio, Windows, the Windows logo, Windows Azure, Windows PowerShell, Windows Server, the Windows start button, and Windows Vista are registered trademarks or trademarks of Microsoft Corporation. Microsoft product screen shots are reprinted with permission from Microsoft Corporation.

All other trademarks, service marks, and company names in this document or website are properties of their respective owners.

Copyright and license information for third-party and open source software used in Hitachi Vantara products can be found at <https://www.hitachivantara.com/en-us/company/legal.html>.

Contents

Preface	5
Intended audience.....	5
Product version.....	5
Release notes.....	5
Changes in this revision.....	5
Document conventions.....	5
Accessing product documentation.....	7
Getting help.....	7
Comments.....	7
Chapter 1: Introduction	8
Key features.....	8
Storage system specifications.....	8
Chapter 2: Hardware overview	11
Controller chassis.....	11
Controller board.....	16
Front-end modules.....	18
10-Gbps iSCSI board LEDs and connectors (optical).....	19
10-Gbps iSCSI board LEDs and connectors (copper).....	19
16-Gbps or 32-Gbps Fibre Channel (4-port) board LEDs and connectors.....	21
Back-end modules.....	22
LAN blade LEDs and connectors.....	24
PCIe module.....	24
Drive box.....	25
Host port expansion chassis.....	28
Host port expansion chassis front panel bezel LEDs.....	28
PCIe switchboard.....	29
Host port expansion chassis fan.....	29
PCIe cable connector.....	30
Host port expansion chassis power supply.....	31
Service processor.....	32
Rack support.....	33

Chapter 3: Specifications.....	34
Environmental specifications.....	34
Electrical specifications.....	36
Physical specifications.....	38
Chapter 4: Turning storage system power on and off.....	40
Powering on the storage system.....	40
Powering off the storage system.....	41
Chapter 5: Site preparation.....	42
Site preparation checklist.....	42
Site planning.....	43
Installation site considerations.....	44
Floor cutout and service clearance.....	44
Floor load rating.....	46
Installing anti-tilt bracket for Universal V3 Rack.....	46
Appendix A: Component list.....	48
Component list.....	48

Preface

This guide describes the hardware features and specifications of the VSP E990 storage system.

Intended audience

This document is intended for Hitachi Vantara representatives, system administrators, authorized service providers, or customers who configure and operate the VSP E990 storage system.

Readers of this document should be familiar with the following:

- Data processing and RAID storage systems and their basic functions
- RAID storage system hardware components and operational specifications

Product version

This document revision applies to VSP E990 firmware 93-04-01 or later.

Release notes

Read the release notes before installing and using this product. They may contain requirements or restrictions that are not fully described in this document or updates or corrections to this document. Release notes are available on the Hitachi Vantara Support Website: <https://knowledge.hitachivantara.com/Documents>.

Changes in this revision

- Corrected error in the wording about the SVP.



Document conventions

This document uses the following typographic conventions:

Convention	Description
Bold	<ul style="list-style-type: none"> Indicates text in a window, including window titles, menus, menu options, buttons, fields, and labels. Example: Click OK. Indicates emphasized words in list items.
<i>Italic</i>	<ul style="list-style-type: none"> Indicates a document title or emphasized words in text. Indicates a variable, which is a placeholder for actual text provided by the user or for output by the system. Example: <pre>pairdisplay -g group</pre> (For exceptions to this convention for variables, see the entry for angle brackets.)
Monospace	Indicates text that is displayed on screen or entered by the user. Example: <code>pairdisplay -g oradb</code>
< > angle brackets	Indicates variables in the following scenarios: <ul style="list-style-type: none"> Variables are not clearly separated from the surrounding text or from other variables. Example: <pre>Status-<report-name><file-version>.csv</pre> Variables in headings.
[] square brackets	Indicates optional values. Example: [a b] indicates that you can choose a, b, or nothing.
{ } braces	Indicates required or expected values. Example: { a b } indicates that you must choose either a or b.
vertical bar	Indicates that you have a choice between two or more options or arguments. Examples: [a b] indicates that you can choose a, b, or nothing. { a b } indicates that you must choose either a or b.

This document uses the following icons to draw attention to information:

Icon	Label	Description
	Note	Calls attention to important or additional information.

Icon	Label	Description
	Tip	Provides helpful information, guidelines, or suggestions for performing tasks more effectively.
	Caution	Warns the user of adverse conditions and/or consequences (for example, disruptive operations, data loss, or a system crash).
	WARNING	Warns the user of a hazardous situation which, if not avoided, could result in death or serious injury.

Accessing product documentation

Product user documentation is available on the Hitachi Vantara Support Website: <https://knowledge.hitachivantara.com/Documents>. Check this site for the most current documentation, including important updates that may have been made after the release of the product.

Getting help

The [Hitachi Vantara Support Website](https://support.hitachivantara.com/en_us/contact-us.html) is the destination for technical support of products and solutions sold by Hitachi Vantara. To contact technical support, log on to the Hitachi Vantara Support Website for contact information: https://support.hitachivantara.com/en_us/contact-us.html.

[Hitachi Vantara Community](https://community.hitachivantara.com) is a global online community for Hitachi Vantara customers, partners, independent software vendors, employees, and prospects. It is the destination to get answers, discover insights, and make connections. **Join the conversation today!** Go to community.hitachivantara.com, register, and complete your profile.

Comments

Please send us your comments on this document to doc.comments@hitachivantara.com. Include the document title and number, including the revision level (for example, -07), and refer to specific sections and paragraphs whenever possible. All comments become the property of Hitachi Vantara LLC.

Thank you!

Chapter 1: Introduction

The Hitachi Virtual Storage Platform E990 (VSP E990) storage system is a high-performance, large-capacity data storage system utilizing all-flash NVMe solid-state drives. The storage system consists of a controller chassis, one or more NVMe drive boxes, and internal components such as fans and PCIe switches.

The NVMe architecture delivers consistent, low-microsecond latency which reduces the transaction costs of latency-critical applications and delivers predictable performance to optimize storage resources.

Key features

High performance

- Multiple controller configuration distributes processing to each controller
- High-speed processing facilitated by up to 1,024 GiB of cache
- I/O processing speed increased by NVMe flash drives
- High-speed front-end data transfer up to 3.2 GB/s for FC and 1 GB/s for iSCSI
- Response times as low as 64 microseconds
- Integrated with Hitachi Ops Center to improve IT operational efficiencies

High reliability

- Service continuity by main components in redundant configuration
- RAID 1, RAID 5, and RAID 6 support (RAID 6 including 14D+2P)
- Data security by transferring data to cache flash memory at the time of a power outage

Scalability and versatility

- Scalable capacity up to 2.88 PB (internal), 287 PB (external), and 5.8M IOPS
- Heterogeneous connectivity supporting concurrent attachment to a variety of hosts, including VMware, Linux, UNIX, and Windows

Storage system specifications

The storage system offers superior performance, resiliency, and agility, featuring response times as low as 64 microseconds, all backed up with the industry's first and most comprehensive 100% data availability guarantee. The following table lists the key operational and performance specifications for the storage system.

Table 1 VSP E990 specifications

Item		Specification	
System	Number of NVMe flash drives	Minimum	4
		Maximum	96
	RAID group configuration	RAID 6	<ul style="list-style-type: none"> ▪ 6D+2P ▪ 12D+2P ▪ 14D+2P
		RAID 5	<ul style="list-style-type: none"> ▪ 3D+1P ▪ 4D+1P ▪ 6D+1P ▪ 7D+1P
		RAID 1	<ul style="list-style-type: none"> ▪ 2D+2D ▪ 4D+4D
	Maximum number of spare drives		8
	Maximum number of volumes		65,280
	Maximum storage system capacity (physical capacity)	30 TB 2.5-inch SSD used	2.49 PiB (2.8 PB)
	Maximum external configuration		255 PiB (287 PB)
Memory	Cache memory capacity	256 GiB to 1,024 GiB	
Storage interface	DKC-drive interface	NVMe/Dual Port	
	Data transfer rate	8 Gbps	
	Maximum number of back-end modules	8	
Device interface	Supported channel types	<ul style="list-style-type: none"> ▪ Fibre Channel (shortwave, longwave) ▪ iSCSI (optical) 	
	Data transfer rate	Fibre Channel	up to 3.2 GB/s
		iSCSI (Optical)	10 Gbps

Item		Specification
	Maximum number of front-end modules	16

Chapter 2: Hardware overview

The storage system consists of a controller chassis and one or more drive chassis mounted in a 19-inch rack.

Controller chassis

The controller chassis contains the following components:

- Controller boards (CTLs)
- Front-end modules (FEMs), also called channel boards (CHBs)
- Back-end modules (BEMs), also called disk boards (DKBs)
- Power supply (PS)
- Backup fan module (BKMF)

The storage system's CTLs contain the cache memory (CM) and cache flash memory (CFM) for the storage system. The VSP E990 supports 1,024 GiB of cache memory.



Number	Item	Description
1	LED (POWER, READY, WARNING, ALARM)	Status LEDs for the controller chassis.
2	POWER ON/OFF (main switch)	Switch that controls power to the storage system.
3	Lock	Use to lock and unlock front bezel.

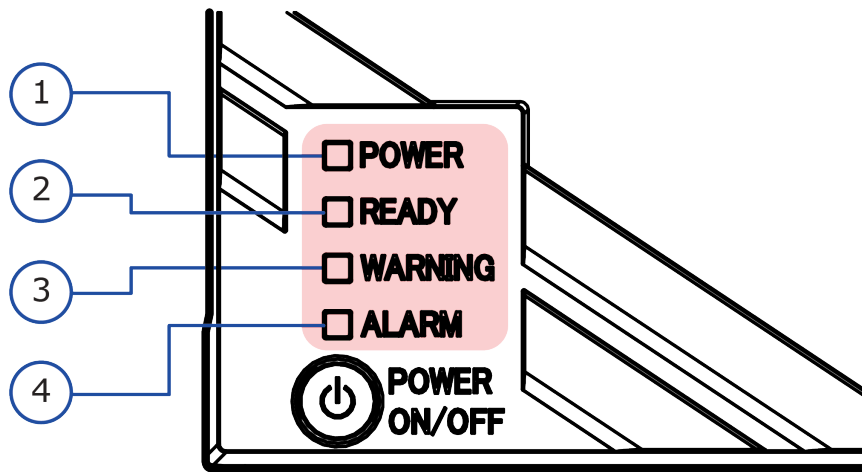

Number	Item	Description
1	POWER LED	Green: Storage system is powered on. Amber: Storage system is receiving power.
2	READY LED	Green: Normal operation.
3	WARNING LED	Off: Normal operation. Amber: Component requires maintenance. Blink: Failure requires maintenance. Note: When system option mode (SOM) 1097 is set to ON, the WARNING LED does not blink, even if the following failure service information messages (SIMs) are issued: 452xxx, 462xxx, 3077xx, 4100xx, and 410100. LED might turn off during user maintenance.
4	ALARM LED	Off: Normal operation. Red: Processor failure (system might be down). For assistance, contact customer support: https://support.hitachivantara.com/en_us/contact-us.html .

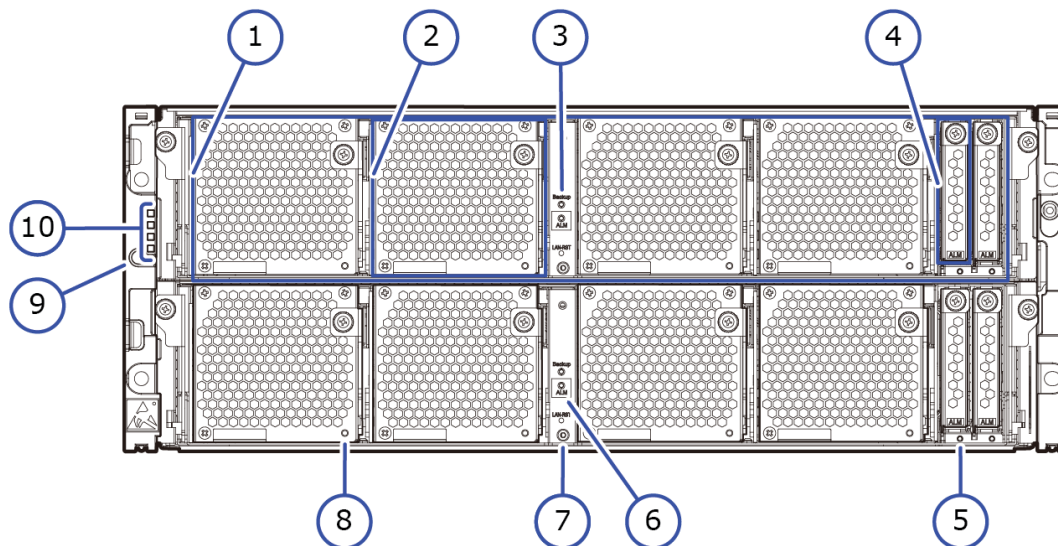

Number	Item	Description
1	Controllers	Controller 1 (bottom) and Controller 2 (top).
2	Backup module	N/A
3	BACKUP LED	Green: Power restoration in progress following power outage. Fast blink green: Restoring. Slow blink green: Restoring, or sequential shutdown in progress.
4	Cache flash memory	N/A
5	ALM LED (for cache flash memory)	Red: Cache flash memory can be removed.
6	CTL ALM LED	Red: Controller can be removed. Blink red: Failure with the power supply unit of the controller. Amber: LAN reset switch was pressed.
7	LAN-RST switch	Use only when instructed by customer support.
8	STATUS LED (for BKMF)	Green: Charging of the battery in the backup module is complete. Red: Backup module can be removed. Blink red one time: Main battery failure. Blink red two times: Backup battery failure.

Number	Item	Description
		<p>Blink red three times: Both batteries failed or preventive maintenance replacement of batteries can run.</p> <p>Off: Battery is not mounted, battery-mounting failure occurred, or firmware is being upgraded. Off is normal status for configurations without batteries.</p>
9	POWER ON/OFF (main switch)	Powers the storage system.
10	POWER, READY, WARNING, and ALARM LEDs	<p>Note: When system option mode (SOM) 1097 is set to ON, the WARNING LED does not blink, even if the following failure service information messages (SIMs) are issued: 452xxx, 462xxx, 3077xx, 4100xx, and 410100.</p>

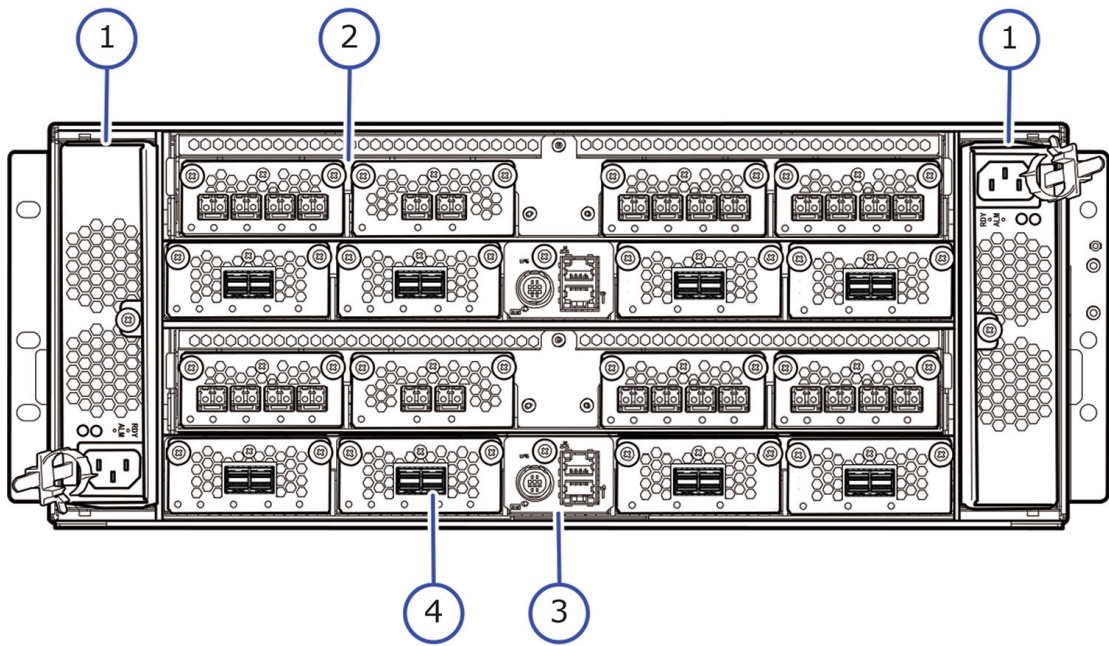

Number	Item
1	Power supply
2	Disk board module
3	LAN board
4	Channel board module

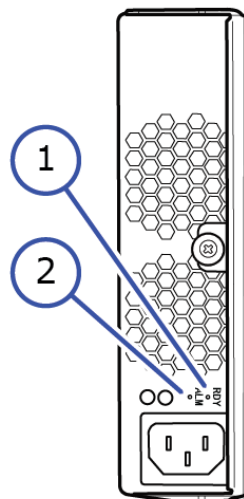

DKCPS1

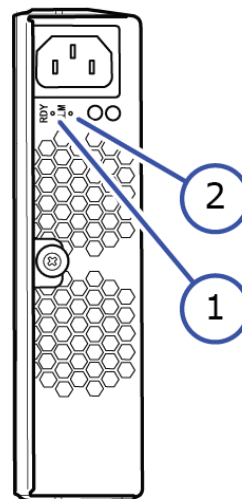

DKCPS2

Number	Item	Description
1	ALM / RDY LED	Red: Power supply unit can be replaced.
2	RDY LED	Green: Normal operation.

Controller board

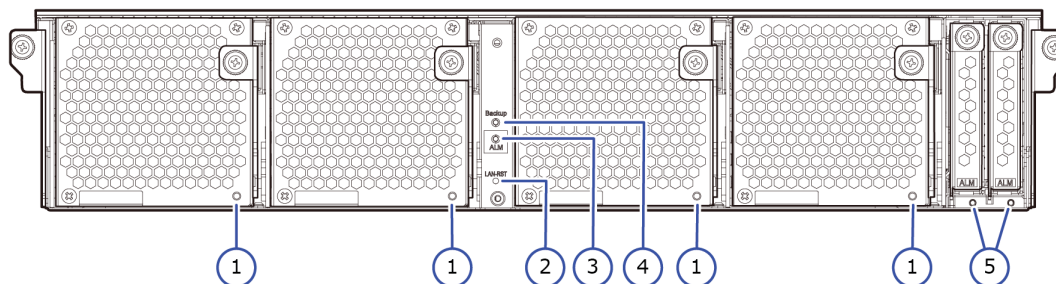

Number	Item	Description
1	STATUS	<p>LED Off: Battery is uninstalled, installed improperly or BKMF firmware is replaced (in case of a configuration with no battery installed, the LEDs for BKMF-10 and BKMF-20 go out).</p> <p>Green On: Battery is fully charged.</p> <p>Green Blinking: Battery is charged or discharged.</p> <p>Red On: BKMF has an error.</p> <p>Red Blinking: BKMF can be removed. A failure occurred in the battery or preventive maintenance replacement of the batteries is possible.</p>
2	LAN-RST	<p>This is a switch for GUM reset.</p> <p>If GUM reboot fails, reset GUM forcibly from the hardware.</p>
3	CTL ALM	<p>Red On: The controller board is ready to be removed (when the maintenance work requiring insertion and removal of the controller board is performed). A failure is detected in the controller board (when the maintenance work mentioned above is not performed).</p> <p>Red Blinking: A failure is detected in the controller board, cache memory, or cache flash memory (CFM).</p> <p>Amber On: Indicates that the LAN RESET switch is pressed.</p>

Number	Item	Description
4	BACKUP STS	Green On : Indicates that power outage has occurred or power restoration is in progress after power outage. <ul style="list-style-type: none"> Fast blinking (On and off are repeated at 0.1-second intervals.): The data is being restored. Slow blinking (On and off are repeated at 0.5-second intervals.): A planned power off is being executed or the data is being stored.
5	ALARM	Red On: Cache Flash Memories are removable.

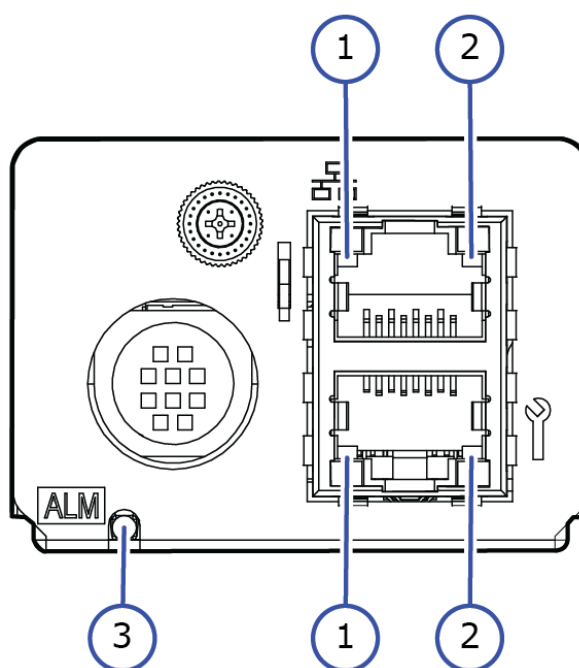

Number	Item	Description
1	ACT/LINK LED	Amber: Link status/data transfer status.
2	SPEED LED	On: Link speed = 1 Gbps. Off: Link speed = 10 Mbps/100 Mbps.
3	LAN ALARM LED	Red: The removal of the LAN Board is possible.

Front-end modules

The front-end modules (FEMs), also called channel boards (CHBs), control the transfer of data between the host and cache memory. The storage system supports Fibre Channel (FC) and iSCSI front-end modules (FEMs) for attachment to host servers. The front-end module LEDs indicate the operating status of the module.

Specification		Fibre 32-Gbps Ready	iSCSI 10G	iSCSI 10G BASE-T
Model number		DW-F800-4HF32R	DW-F800-2HS10S	DW-F800-2HS10B
Number of PCBs		1	1	1
Host interface		FCP	iSCSI (optical)	iSCSI (copper)
Data transfer rate (MB/s)		16Gbps: 400/800/1,600 32Gbps: 800/1,600/3,200	1,000	100/1,000
Number of options installed(): DKB slot used		2/4/6/8/12/14/16 (14/16/18/20)	2/4/6/8/12/14/16 (14/16/18/20)	2/4/6/8/12/14/16 (14/16/18/20)
Number of ports per PCB		4	2	2
Number of ports per storage system(): DKB slot used		8/16/24/32/48/56/64 (56/64/72/80)	4/8/12/16/24/28/32 (28/32/36/40)	4/8/12/16/24/28/32 (28/32/36/40)
Maximum cable length	Short wave ¹	400m/190m/125m/ 100m	550m	-
	Long wave	10km	-	-
	Copper	-	-	50m (cat 6a)
<p>1. When 50/125mm laser optimized multi-mode fibre cable (OM3 or OM4) is used. When using other cable types, contact customer support.</p>				

10-Gbps iSCSI board LEDs and connectors (optical)

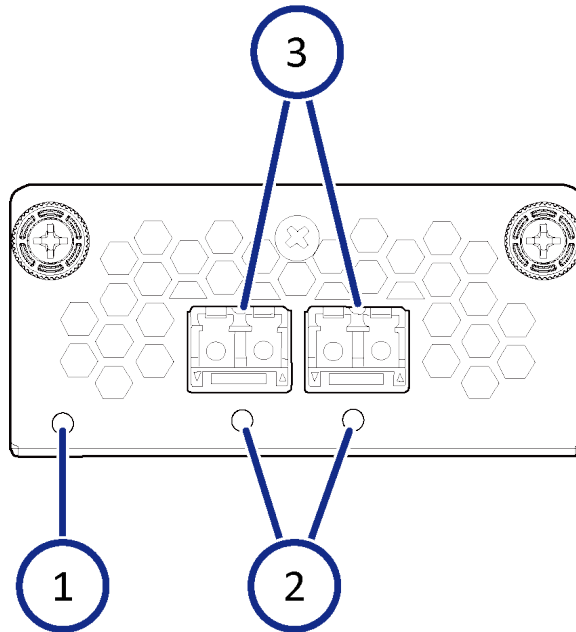

Number	Item	Description
1	STATUS LED	Green: Front-end module is in the power-on state. Red: Front-end module can be removed safely.
2	PORT LED	Red: Small form-factor (SFF) pluggable can be removed. Blue: Normal link status. Blue Blinking: Front-end module is in communication status.
3	iSCSI connectors	Connect to Ethernet cables.

10-Gbps iSCSI board LEDs and connectors (copper)

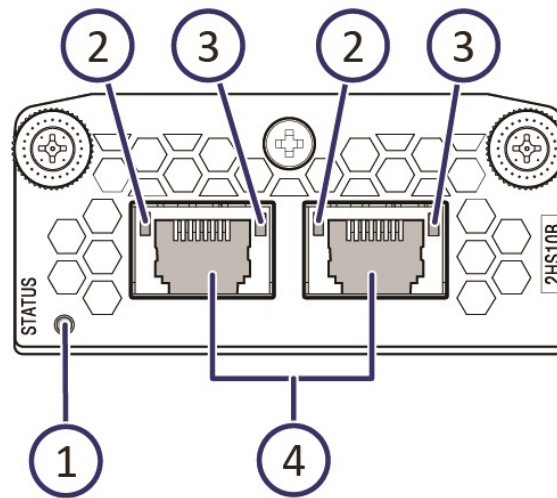

Number	Item	Description
1	STATUS LED	Green: Front-end module is in the power-on state. Red: Front-end module can be removed safely.
2	PORT (Link/Speed) LED	Yellow: 1-Gbps link. Green: 10-Gbps link. Off: No link connection.
3	PORT LED	Green: Link connection is established. Blinking: Communication is in progress. Off: No link connection or not ready to communicate.
4	iSCSI connectors	Connect to Ethernet cables.

16-Gbps or 32-Gbps Fibre Channel (4-port) board LEDs and connectors

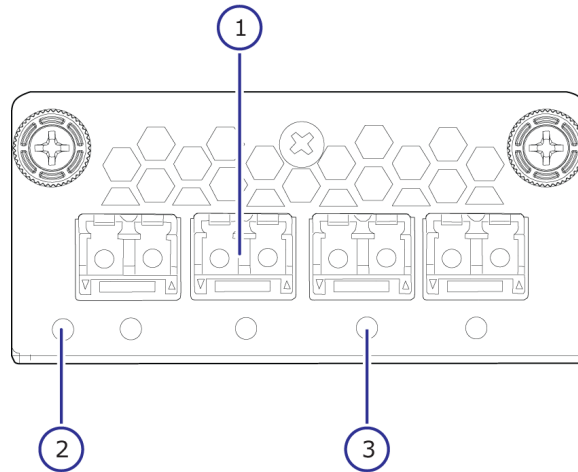

Number	Item	Description
1	Fibre Channel connectors	Connect to Fibre Channel cables.
2	STATUS LED	Green: Front-end module is in power-on state. Red: Front-end module can be removed safely.
3	PORT LED	Red: Small form-factor (SFF) pluggable can be removed. Blue: Normal link status at 16-Gbps (16-Gbps). Blue: Normal link status at 32-Gbps (32-Gbps). Green: Normal link status at 4-Gbps or 8-Gbps (16-Gbps). Green: Normal link status at 8-Gbps or 16-Gbps (32-Gbps).

Table 2 Port assignments

CHB number	8-Gbps, 16-Gbps, or 32-Gbps Fibre Channel ports (left to right)			
	Port 1	Port 2	Port 3	Port 4
CHB-1A	1A	3A	5A	7A

CHB number	8-Gbps, 16-Gbps, or 32-Gbps Fibre Channel ports (left to right)			
	Port 1	Port 2	Port 3	Port 4
CHB-1B	1B	3B	5B	7B
CHB-1C	1C	3C	5C	7C
CHB-1D	1D	3D	5D	7D
CHB-1E	1E	3E	5E	7E
CHB-1F	1F	3F	5F	7F
CHB-1G	1G	3G	5G	7G
CHB-1H	1H	3H	5H	7H
CHB-2A	2A	4A	6A	8A
CHB-2B	2B	4B	6B	8B
CHB-2C	2C	4C	6C	8C
CHB-2D	2D	4D	6D	8D
CHB-2E	2E	4E	6E	8E
CHB-2F	2F	4F	6F	8F
CHB-2G	2G	4G	6G	8G
CHB-2H	2H	4H	6H	8H

Back-end modules

The back-end modules (BEMs), also called disk boards (DKBs), control the transfer of data between the drives and cache memory. The back-end module LEDs indicate the operating status of the module.

Item	Specification
Model number	DKC-F910I-BN8G
Number of PCBs	1
Number of ports per PCB	4
Performance	8 Gbps
Data encryption	Not supported

Item	Specification
Number of PCBs per storage system	4 or 8
Number of NVMe ports per system	8 or 16

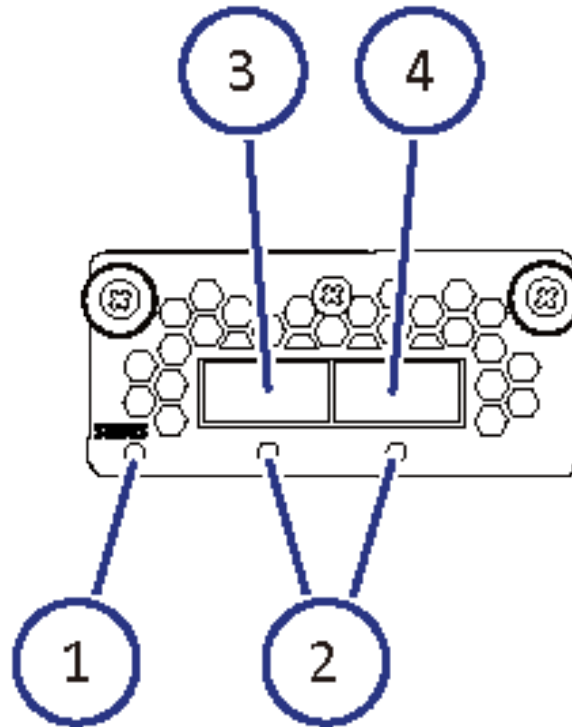

Number	Item	Description
1	STATUS LED	Green: Back-end module is in the power-on state. Red: Back-end module can be removed safely.
2	PORT LED	Blue: Link status is normal.
3	PATH 0 connector	Connect to a drive tray.
4	PATH 1 connector	Connects to a drive tray.

LAN blade LEDs and connectors

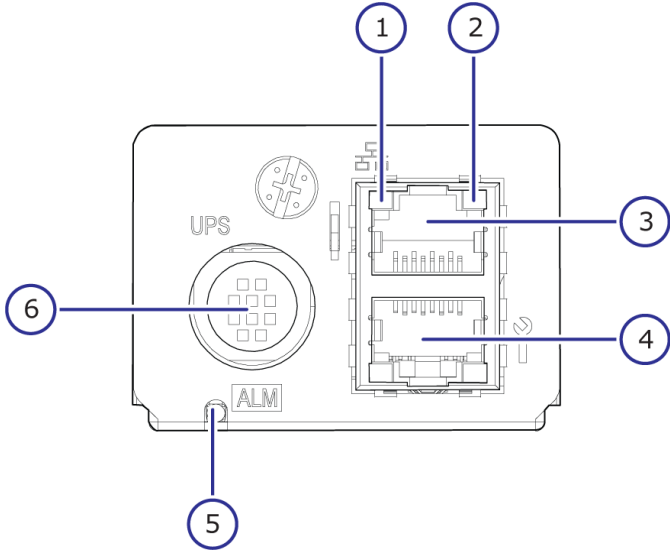

Number	Item	Description
1	LINK LED	Green: Link status is normal.
2	ACT LED	Orange: Data is being transferred.
3	LAN 2	LAN port used by the user.
4	LAN 1	Maintenance LAN port used by service personnel.
5	LAN ALARM LED	Red: LAN blade can be removed.
6	Uninterruptible power supply (UPS) port	N/A

PCIe module

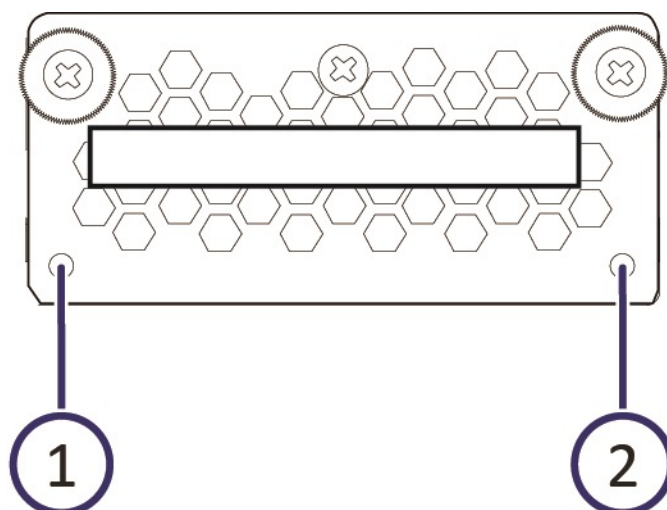

Number	Item	Description
1	STATUS LED	Green: PCIe module is in the power-ON status. Red: PCIe module failure occurred. Off: PCIe module can be removed safely.
2	Link	Green: PCIe is Gen-3 (8-Gbps) and is linked up normally. Off: PCIe is not linked up (PCIe cable might not be connected). If a PCIe cable is connected, it can be removed safely.

Drive box

The storage system can be configured with up to four drive boxes. The drive box for NVMe drives (DBN) contains two enclosures (ENCs) and two power supplies with integrated cooling fans. Up to 24 NVMe drives can be installed in each drive box.

Canister type	Size	Transfer rate	Flash memory type	Capacity
SFF	2.5 in.	8 Gbps	TLC	1.9 TB
				3.8 TB
				7.6 TB
				15 TB
				30 TB

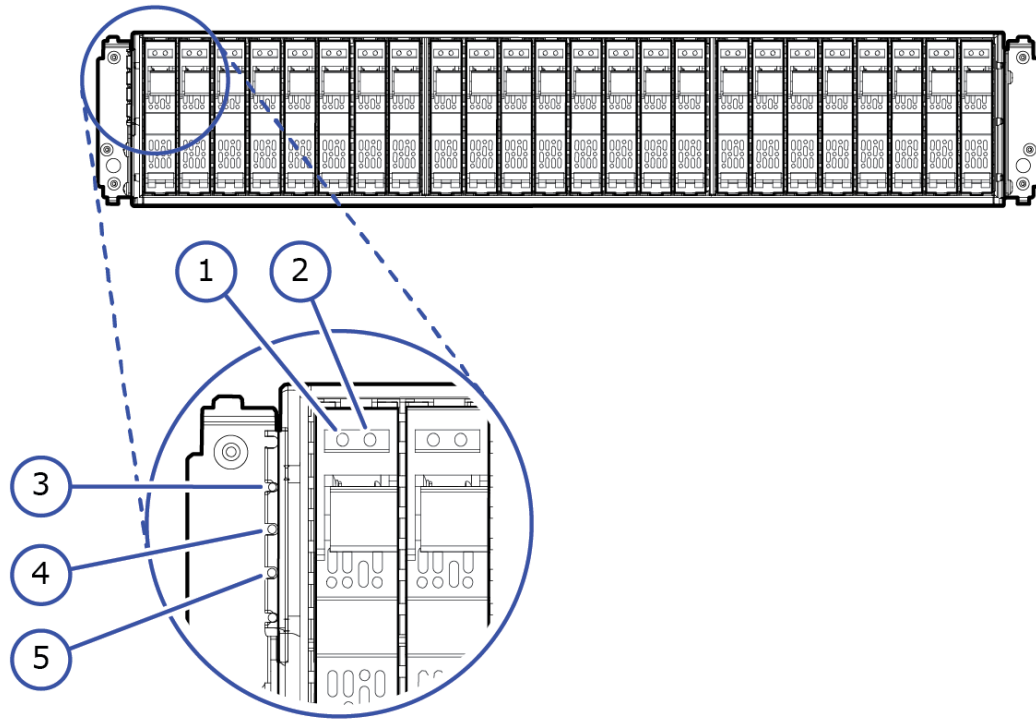

Number	Item	Description
1	ALM	Red: Indicates that the removal of the HDD/SSD is possible when the storage system is powered on.
2	ACT	Green: Indicates that the drives are powered on. Blinking Green: Indicates that the drives are active.
3	POWER	Green: Indicates that power is supplied to the ENC.
4	READY	Green: Indicates that the ENC is operating normally.
5	LOCATE	Amber: An LED to specify the chassis location on the rear of the chassis. The LED can be lit/turned off by Maintenance Utility.

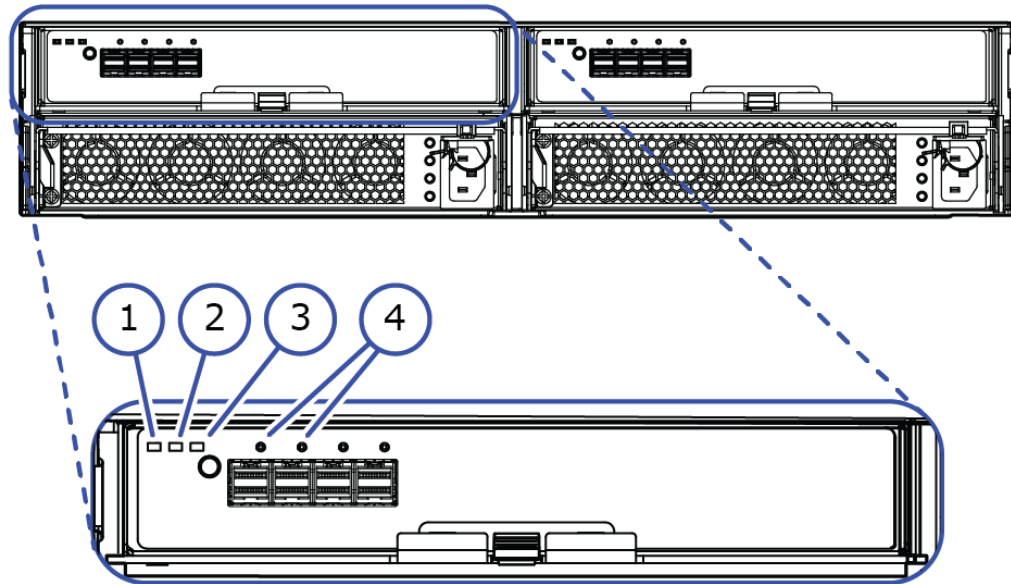

NBX ENC

Number	Item	Description
1	POWER	Green: Indicates that power is supplied to the ENC.
2	LOCATE	Amber: An LED to specify the chassis location on the rear of the chassis. The LED can be lit/turned off by Maintenance Utility.
3	ALARM	Red: Indicates that the removal of the drive is possible when the storage system is powered on.
4	LINK	Blue: Indicates that PCIe between DKBN and ENC is linked up.

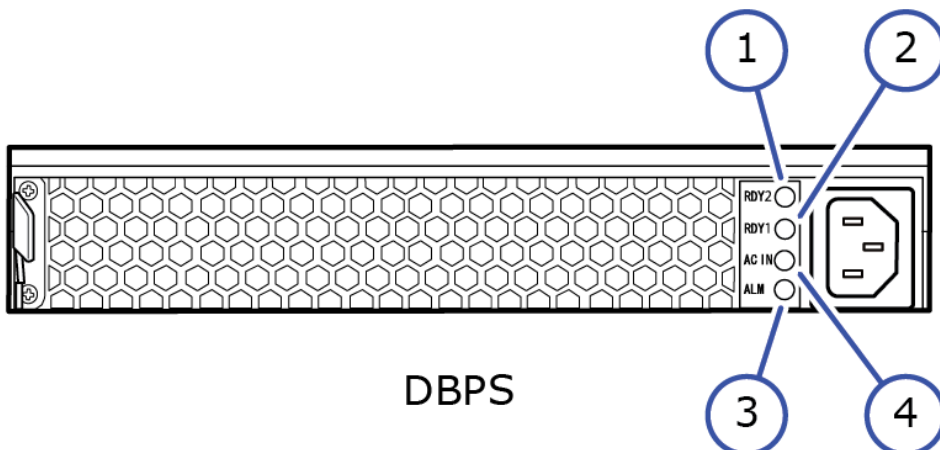

Number	Item	Description
1	RDY2	Green: Normal operation Off: Erroneous operation or out of operation
2	RDY1	Green: Normal operation Off: Erroneous operation or out of operation
3	AC IN	Green: Indicates that AC input is normal.
4	ALM (REPLACE)	Red: Indicates when the power supply can be replaced.

Host port expansion chassis

The host port expansion chassis contains various interconnect adapters that connect a host system to storage and other network devices. The interconnect adapters include PCIe boards and iSCSI and FC cards. For more information, contact customer support.

Host port expansion chassis front panel bezel LEDs

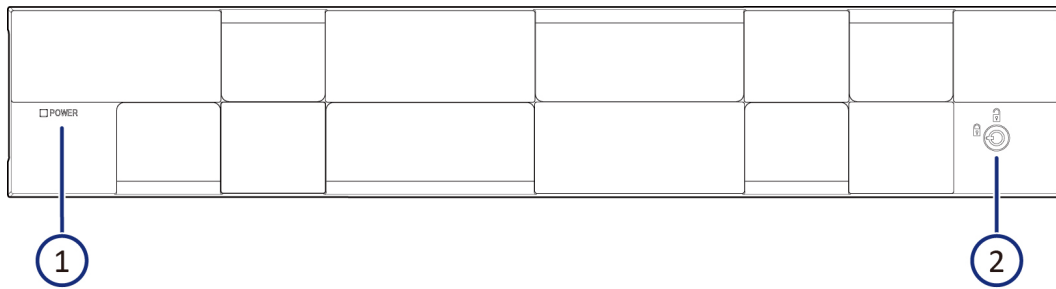

Number	Item	Description
1	POWER LED	Green: Host port expansion is turned on. Amber: PCIe module is turned on. Off: PCIe module is turned off.
2	Safety lock	Lock or unlock the front bezel.

PCIe switchboard

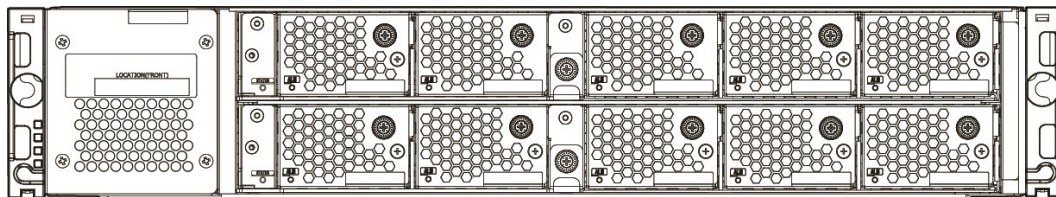

Front view of Expansion Chassis

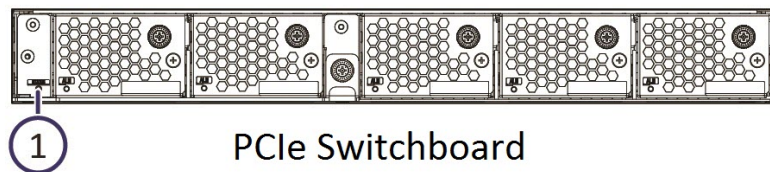

PCIe Switchboard

Number	Item	Description
1	STATUS LED	Green: PCIe switchboard is powered on. Red: PCIe switchboard can be replaced safely. Off: PCIe switchboard is powered off.

Host port expansion chassis fan

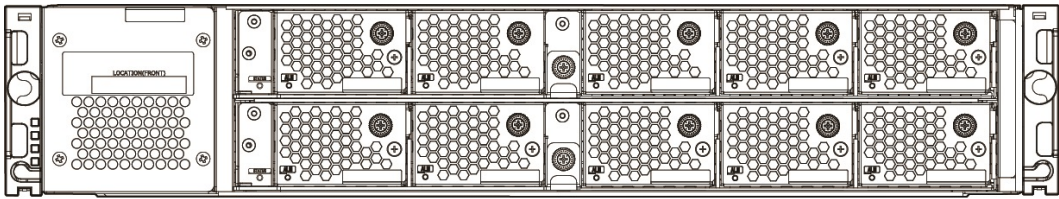

Front View of Expansion Chassis

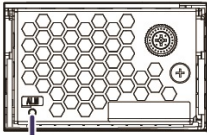

1 Expansion Chassis Fan

Number	Item	Description
1	ALM LED	Red: Fan failure has occurred. Off: Normal operation.

PCIe cable connector

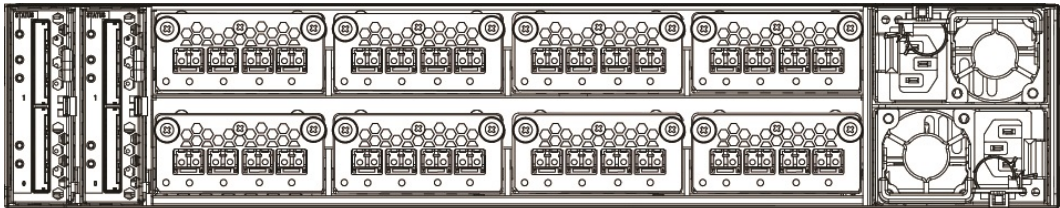

Rear View of Expansion Chassis

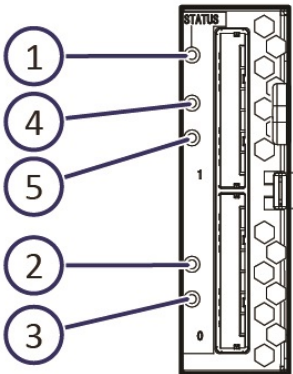

PCIe Cable Connector

Number	Item	Description
1	STATUS LED	Green: PCIe cable connector is powered on. Red: PCIe cable connector can be replaced safely. Off: PCIe cable connector is powered off.
2	Link Basic LED	Green: Basic PCIe Gen-3.0 (8-Gbps) is linked up normally. Off: Basic PCIe is not linked up (PCIe cable might not be connected). If a cable is connected, it can be removed safely.
3	InAct Basic LED	Amber: Basic PCIe status changed from link up to link down and cables. Cables can be removed safely. Off: Basic PCIe is normal or not set.
4	Link Option LED	Green: Option PCIe Gen-3.0 (8-Gbps) is linked up normally. Off: Option PCIe is not linked up (PCIe cable might not be connected). If a cable is connected, it can be removed safely.
5	InAct Option LED	Amber: Option PCIe status changed from link up to link down and cables. Cables can be removed safely. Off: Option PCIe is normal or not set.

Host port expansion chassis power supply

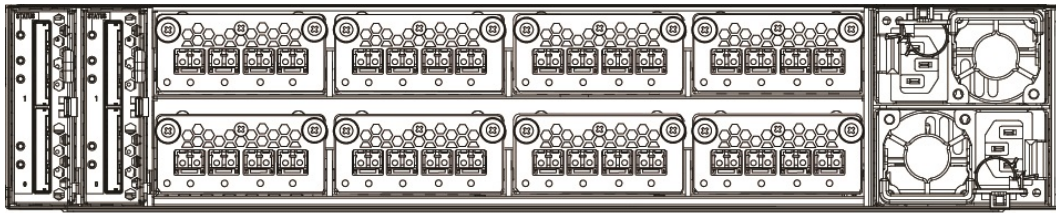

Rear View of the Expansion Chassis

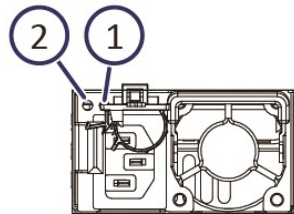

Expansion Chassis Power Supply 2

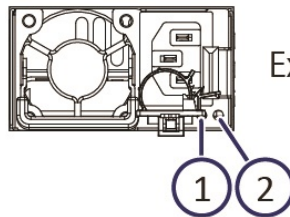

Expansion Chassis Power Supply 1

Number	Item	Description
1	ALM / RDY LED	Red: Host port expansion chassis power supply can be replaced safely. Green: Normal operation.
2	AC IN LED	Blue: AC input is normal.

Service processor

The service processor (SVP) provides out-of-band configuration and management of the storage system, and collects performance data for key components to enable diagnostic testing and analysis.

The SVP enables the Hitachi Vantara representative or authorized service provider to configure, maintain, service, and upgrade the storage system. The SVP also hosts the Hitachi Device Manager - Storage Navigator software, and it collects performance data for key components to enable diagnostic testing and analysis.

The SVP is available as a 1U management server physically installed above the controller and drive trays in the rack or as a 64-bit software application provided by Hitachi Vantara. For the latest interoperability updates and details, see the *SVP (Service Processor) OS and Hypervisor support* report at <https://support.hitachivantara.com/en/user/answers/interoperability.html>.

For more information about the SVP, see the *Service Processor 3 (SVP3) Technical Reference*.

Rack support

The storage system can be installed in the Hitachi Universal V3 Rack, Universal V2B Rack or Universal V2 Rack as well as non-Hitachi 19-inch racks that meet the storage system's specifications.

Non-Hitachi racks must be 4-post, EIA 310-D compliant with adequate airflow and weight capacity. The PDUs must be mounted properly to avoid any issues for servicing the storage system. The PDU receptacles must face toward the back (not toward each other). The area behind the storage system and between the vertical 19-inch mounting posts must be free of PDUs and cable loops.

Chapter 3: Specifications

The Hitachi Virtual Storage Platform E990 (VSP E990) storage system is designed to operate in a controlled environment such as a data center. The following tables provide the environmental, electrical, and physical requirements and specifications for the VSP E990.

Environmental specifications

The following tables provide the environmental specifications, including operating and non-operating, for the Hitachi Virtual Storage Platform E990 (VSP E990) storage system.

Table 3 Temperature

State	Specification
Operating	10°C to 35°C (50°F to 95°F)
Non-operating	-10°C to 50°C (14°F to 122°F)
Transport, storage	-30°C to 60°C (-22°F to 140°F)
Temperature change rate	10°C/hr (18°F/hr)

Table 4 Humidity

State	Specification
Operating	8% to 80%
Non-operating	8% to 90%
Transport, storage	8% to 90%
Maximum wet bulb temperature (°C)	29°C (84.2°F) (noncondensing)

Table 5 Vibration, shock, and impact

Type	State	Specifications
Vibration	Operating	0.98 m/s ² (0.1 G) or less [frequency component 5 Hz to 100 Hz]

Type	State	Specifications
	Non-operating	Same as operating specification
Impact	Operating	No impact
	Non-operating	78.4 m/s ² (8.0 G), 15 ms
Seismic wave	Operating	2.5 m/s ² (0.25 G) (approximately 250 Gal) or less
	Non-operating	3.9 m/s ² (0.4 G) or less: No critical damage for product function (normal operating with part replacement). 9.8 m/s ² (1.0 G) or less: Ensure own safety with fall prevention.

Table 6 Altitude (Temperature range)

State	Specification
Operating (m)	3,050 m (10°C to 28°C) [10,006 ft. (50°F to 82.4°F)] 950 m (10°C to 35°C) [3,116 ft. (50°F to 95°F)]
Non-operating (m)	-60 m to 12,000 m (-196 ft. to 39,370 ft.)

Table 7 Environment/atmosphere

Type	State	Specifications
Dust	Operating	0.15 µg/m ³ or less
	Non-operating	-
Gaseous contaminants	Operating	Within ANSI/ISA S71.04-2013 G1 classification levels.
	Non-operating	Keep data center clean by monitoring and controlling gaseous contamination.

Table 8 Noise level (recommended)

State	Specification
Operating	90 dB or lower*
Non-operating	

State	Specification
	<p>* Fire suppression systems and acoustic noise: When activated, some inert-gas fire-suppression systems release pressurized gas at high velocity through multiple nozzles in the data center, generating high levels of acoustic noise. Pneumatic sirens can also generate high levels of acoustic noise. High levels of acoustic noise can cause vibrations to the media in the storage system, resulting in I/O errors, performance degradation in the media, and to some extent damage to the drives. Media noise-level tolerance varies among different models, designs, capacities, and manufacturers.</p> <p>The recommended acoustic noise level of 90 dB or less represents the current operating environment guidelines for which the storage systems are designed and manufactured for reliable operation when placed 2 meters or more from the source of the noise.</p> <div data-bbox="360 646 1393 827" style="background-color: #e0f2f1; padding: 10px;"> <p> Note: The storage systems and media are not tested for compatibility with fire-suppression systems or pneumatic sirens. In addition, Hitachi does not recommend or claim compatibility with any fire-suppression systems or pneumatic sirens. The customer is responsible for following applicable regulations.</p> </div> <p>To prevent I/O errors and damage to the storage system due to high levels of acoustic noise:</p> <ul style="list-style-type: none"> ▪ Install noise-reducing baffles to mitigate the noise to the media in the storage system. ▪ Consult the fire-suppression-system manufacturer about noise-reduction nozzles to protect the media in the storage system. ▪ Locate the storage system as far away as possible from noise sources. ▪ If it can be done safely and without risk of personal injury, shut down the storage system before the noise occurs to prevent data loss due to damage to the media in the storage system. <p>DAMAGE TO MEDIA FROM FIRE-SUPPRESSION SYSTEMS OR PNEUMATIC SIRENS VOIDS THE MEDIA WARRANTY.</p>

Electrical specifications

The Hitachi Virtual Storage Platform E990 (VSP E990) runs on single-phase AC power. The AC power input for the VSP E990 storage system has a duplex PDU architecture that enables the equipment installed in the rack to remain powered on if power is removed from one of the two power distribution panels.

The following tables provide the electrical specifications for the VSP E990 storage system, including input power and input voltage and frequency requirements.

Table 9 Input power specifications

Item	Component	Specification
Rated power	Controller	1,600 VA
	Drive tray	800 VA
Input power ¹	Controller	Single-phase AC 50 Hz/60 Hz 200 V to 240 V
	Drive tray	
Input current ^{1,2}	Controller	8.0 A
	Drive tray	4.0 A
Steady current ³	Controller	4.0 A
	Drive tray	2.0 A
Leakage current	Controller	1.75 mA
	Drive tray	
Inrush current	Controller	1st (0-p): 30 A 2nd (0-p): 20 A 1st (0-p) time: 25 ms
	Drive tray	1st (0-p): 30 A 2nd (0-p): 25 A 1st (0-p) time: 25 ms
Power cord plug type	Controller	IEC60320 C14 
	Drive tray	
Notes: <ol style="list-style-type: none"> 1. When planning the air-conditioning equipment and power-supply system, use the multiplied value of [Input Power] × [Input Current]. 2. The maximum current of AC input is not a redundant configuration. 3. The maximum current of AC input is a redundant configuration. 		

Table 10 Input voltage and input frequency requirements

Frequency	Input Voltage (AC)	Conditions	Tolerance (%)
60 Hz \pm 2 Hz	200 V to 240 V	1 phase 2 wire + ground	+10% or -11%
50 Hz \pm 3 Hz	200 V to 240 V	1 phase 2 wire + ground	+10% or -11%

Physical specifications

The following table provides the physical specifications for the Hitachi Virtual Storage Platform E990 (VSP E990) storage system, including weight, heat output, power consumption, and air flow specifications.

Table 11 Weight, heat output, power consumption, and air flow specifications

Model number	Weight (kg) ²	Heat output (W) ²	Power consumption (VA) ^{1,2}	Air flow (m ³ /min) ³
DW850-CBL	55.2	453	493	6.0
DW850-CBLA	54.2	453	493	6.0
DW-F850-CBLFB2	-	-	-	-
DW-F850-DBN	14.9	290	305	4.1
DW-F850-DBNFB2	0.6	-	-	-
DW-F800-NMC1F	0.15	-	-	-
DKC-F910I-BN8G	0.5	16.2	17.1	-
DW-F850-CM32G	0.054	4	4.2	-
DW-F850-CM64GL	0.054	4.8	5.0	-
DW-F850-BM55	0.2	5	5.2	-
DW-F850-BM5E	0.2	5	5.2	-
DW-F850-BM65	0.2	6.5	6.8	-
DW-F850-BM6E	0.2	6.5	6.8	-
DW-F900-BM70	0.2	9.7	10.2	-
DW-F900-BM7E	0.2	9.7	10.2	-

Model number	Weight (kg) ²	Heat output (W) ²	Power consumption (VA) ^{1,2}	Air flow (m ³ /min) ³
DW-F800-BAT	0.6	24.4	25.7	-
DW-F800-4HF32R	0.5	17.9	19.9	-
DW-F800-2HS10S	0.5	18.0	18.9	-
DW-F800-2HS10B	0.5	28.5	30.0	-
DKC-F810I-1PL16	0.02	0.79	0.88	-
DKC-F810I-1PS16	0.02	0.94	1.05	-
DKC-F810I-1PS32	0.02	1.29	1.43	-
DW-F800-CHBB	33.2	222	230	2.0
DW-F850-CBSFB2	0.5	-	-	-
DKC-F910I-1R9RVM	0.21	25.0	26.0	-
DKC-F910I-3R8RVM	0.21	25.0	26.0	-
DKC-F910I-7R6RVM	0.21	25.0	26.0	-
DKC-F910I-15RRVM	0.21	25.0	26.0	-
DKC-F910I-30RRVM	0.21	25.0	26.0	-
<p>1. Actual values at a typical I/O condition. (Random Read and Write, 50 IOPSs for HDD, 2500 IOPSs for SSD, Data Length: 8k bytes. All fans rotate at normal.) These values may change for future compatible drives.</p> <p>2. The value is from the configuration of Model List.</p> <p>3. The value is MAX level.</p>				

Chapter 4: Turning storage system power on and off

The storage system can be powered on and off using the power control panel located on the controller chassis during normal operating conditions or in case of a power failure.

Powering on the storage system

Use the following procedure to power on the storage system. The main switch on the controller chassis is used to power on the storage system.

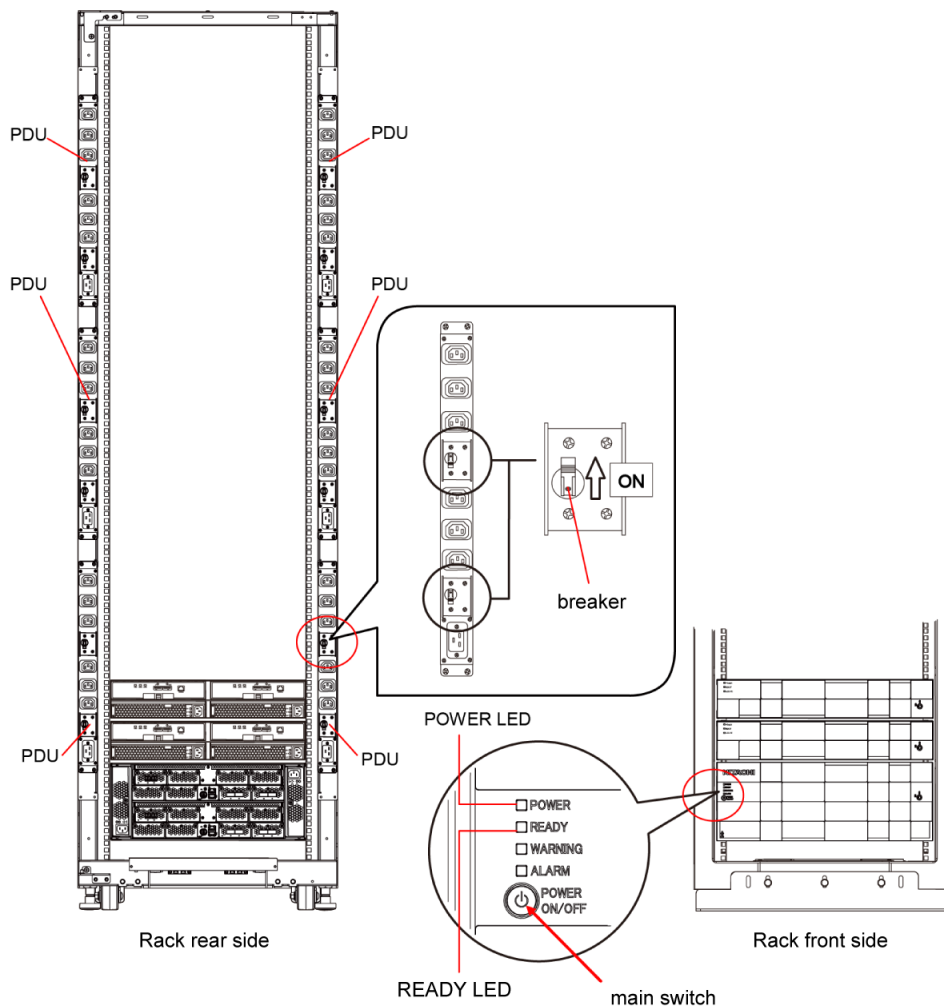

Procedure

1. Turn ON all the breakers to the storage system.
2. Press the main switch on the controller chassis for three seconds until the POWER LED changes from amber to green.



Note: The storage system will take approximately 13 minutes to finish powering on.

3. Wait for the storage system to complete its power-on self-test and bootup processes. When the READY indicator is ON (green LED), the storage system is ready for use.



Caution: If the ALARM indicator is also ON (red LED), or if the READY indicator is not ON after 40 minutes, contact customer support for assistance.

Powering off the storage system

Use the following procedure to power off the storage system. The main switch on the controller chassis is used to power off the storage system.

Before you begin

- Ensure that all software-specific shutdown procedures have been completed. Refer to the applicable user manuals for details.
- Ensure that all I/O activity to the storage system has stopped. You can vary paths offline and shut down the attached hosts.

Procedure

1. Press the main switch on the controller chassis for approximately three seconds until the POWER LED on the front of the chassis changes from solid green to a blinking status.
2. Release the main switch and the POWER LED returns to solid green after blinking for approximately three seconds.
The power-off process begins. The process takes approximately 18 minutes or longer depending on the amount of data that needs to be written. The POWER LED is solid green during the powering off process. The POWER LED changes from green to amber when the process is completed.
3. Verify the POWER LED on the front of the storage system changes from green to amber.
4. To stop the power supply, remove the power cables from the power supply units on the controller chassis and drive box.

If the storage system is connected to a PDU, you can stop the power supply by turning off the PDU breaker.



Note: If the storage system does not receive power for more than six months, the battery can become discharged and possibly damaged. To avoid this situation, charge the battery for more than three hours at least once every six months.

Chapter 5: Site preparation

The delivery and installation site for the storage system must meet certain requirements to ensure successful and efficient installation of the storage system.



Note: The following information is provided to assist in installation planning and is not intended to be complete. The installation and maintenance documents used by Hitachi Vantara personnel contain complete specifications. For further information about site preparation for storage system installation, contact customer support.

Site preparation checklist

Verify the availability of each item in the site preparation checklist.

The responsibilities for installation planning are shared by the customer and the Hitachi Vantara account team. The required installation planning tasks must be scheduled and completed to ensure successful and efficient installation of the storage system.

The following tasks might take several weeks to complete:

- Acquiring required power outlets.
- Adding or modifying air conditioning systems.
- Making room alterations to accommodate the storage system.
- Ordering third-party equipment, such as non-Hitachi racks, network switches, and host servers for the storage system.

The following checklist will assist you as you perform your installation. You can make copies of this checklist for each installation you perform and check each step after it has been performed.

Requirement	Yes	No
Is the data center free of any equipment servicing hazards, such as electrical or data cables that obstruct access?		
Does the data center have a suppression system?		
Does the floor plan meet the service clearance and cutout requirements?		
Does the floor meet the load rating requirements?		

Requirement	Yes	No
Does the data center meet the environmental requirements including temperature, humidity, airflow, and acoustic?		
Is all equipment not supplied by Hitachi (for example, connectors, receptacles, and network switches) on site and ready for use?		
Are the input circuit breakers adequate for equipment loads?		
Are uninterruptible power supplies (UPS) in place?		
Have all sources of electrical interference been addressed?		
Does the site enforce access controls (for example, will Hitachi representatives need an escort)?		
Will the equipment fit through all doors and corridors and in elevators?		

Site planning

All planning activities should be scheduled and completed before the equipment is delivered.

The planning process includes:

- Planning hardware configuration, such as system component layout in the rack and drive allocation.
- Planning for specific network topologies, cabling configurations, network switches, and cabling of connected host computers.
- Ensuring all cables for specific controller and drive tray configurations are properly ordered.
- Verifying all electrical service wiring is installed at the predetermined location.

Complete the suggested tasks before receiving and installing the storage system:

- Prepare a preliminary layout of the installation.
- Review the power and the heating, ventilation, and air-conditioning requirements before ordering any additional support equipment.
- Make a final layout of the installation and review the layout with the Hitachi Vantara representative.
- Verify the installation of electrical service wiring at the predetermined location is proper before installing the storage system.
- Verify all additional equipment, such as switches and host computers, is installed and operational.

Installation site considerations

When planning and preparing for the installation of a storage system, consider the following:

- The delivery area must provide enough space and floor strength to support the packaged equipment cartons for the storage system. Doorways and hallways must provide enough clearance to move the equipment safely from the delivery area to the destination.
- The computer room must have sufficient space to accommodate the storage system and other necessary equipment and provide minimum clearance around the storage system for service access and to verify proper weight distribution on the computer room floor. It must also include correctly positioned floor cutouts for the storage system's power and data cables.
- If the storage system arrives in hot or cold weather or you notice any condensation, do not unpack it until it has been allowed to reach room temperature or the condensation to clear (one to two hours). Immediately exposing the storage system to warm temperature can cause condensation to occur, which could damage the electronics. Maintain recommended humidity level and airflow rates.
- Take the necessary precautions to prevent electrostatic discharge (ESD). Verify that all equipment and flooring are grounded. Store spare electric parts in antistatic bags until you are ready to install them. When handling the storage system, wear protective devices like wrist straps, sole grounders, and conductive shoes.
- Proper environmental conditions for the storage system must be maintained. For optimal performance, storage systems require controlled environmental conditions that are often best facilitated through raised flooring and under-floor air conditioning. It is the responsibility of the customer to monitor this environment and ensure continued conformance with the recommended environmental specifications.
- The computer room must have adequate power facilities for the storage system. Adequate power is necessary to ensure reliable functioning of electronic equipment and for the safety of the customer's installation. The customer is responsible for procuring, installing, and maintaining adequate power to the equipment.

Floor cutout and service clearance

Be sure your site has sufficient space to accommodate the storage system.

When preparing the space required for your storage system, be sure the site:

- Is large enough to hold the new storage system and other equipment.
- Provides minimum clearance around the storage system for service access and to verify proper weight distribution on the computer room floor.
- Includes correctly positioned floor cutouts for the storage system's power and data cables.

To verify there is sufficient space for the storage system, document your site's floor plan, including the locations of:

- Structural support columns and other immovable objects
- Walls
- All existing equipment, cabinets, racks, networking equipment, and other systems
- Where the new storage system will be installed
- Floor and electrical cutouts
- Interconnecting cables and power cords, including lengths
- Floor vents

The space requirements must take into consideration the total floor clearance required for the storage system. This includes:

- The space required by the equipment
- Service clearance - the floor space required to access the storage system.
- Additional space required to distribute the equipment weight on your computer room's raised floor. The amount of additional space required depends on your floor load rating.
- Additional space required to view the storage system LEDs on the front and rear panels.

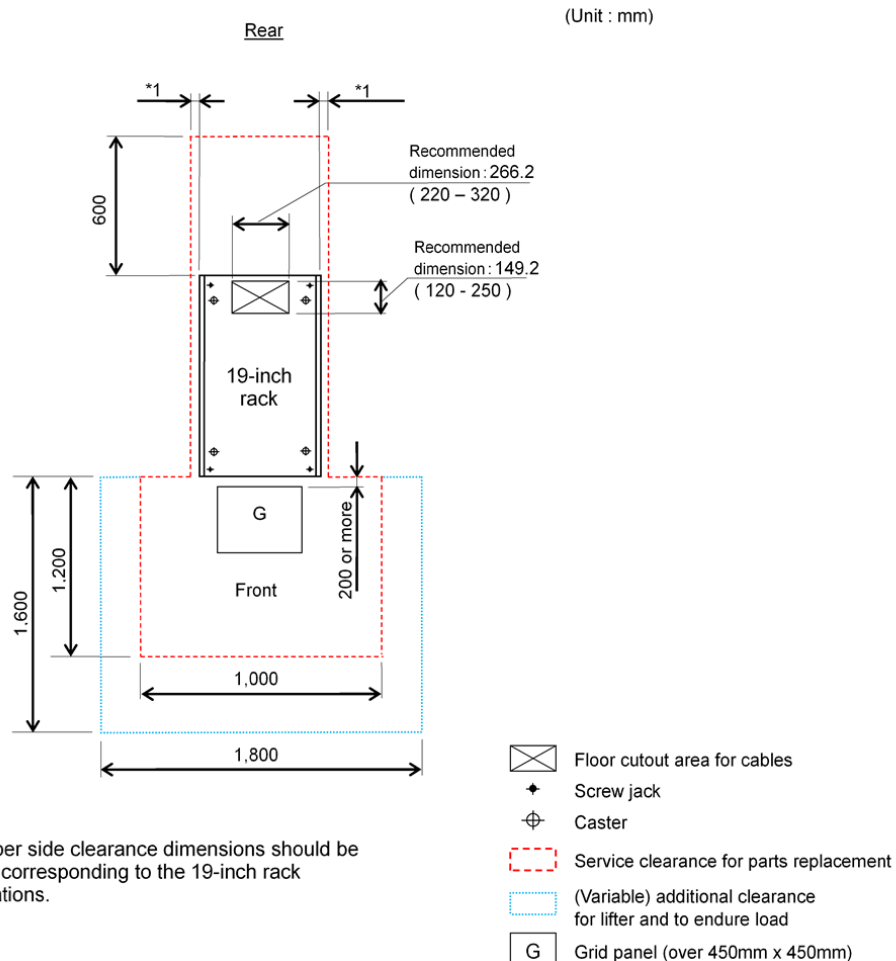

*1: The proper side clearance dimensions should be secured corresponding to the 19-inch rack specifications.

If your computer room uses floor cutouts to route power and data cables, position the cutouts toward the center of the rack. If this is not possible, position the cutouts off-center from the rack as long as the cutout is within the allowable range and allows smooth routing and entrance of cables. Check the relationship between the position of the cutout and the cable openings on the rack.

Floor load rating

The floor space at the installation site must support the combined weight of all associated component and equipment. The maximum load rating is 709 kg.

Installing anti-tilt bracket for Universal V3 Rack

The anti-tilt bracket for the Hitachi Universal V3 Rack must be anchored to a rigid floor capable of holding a minimum of 154 lbs (79 kg).

Before you begin

To install the anti-tilt bracket, you will need the following tools and components:

- T25 screwdriver
- Customer supplied M10 or 3/8" screw capable of holding a minimum 154 lbs (79 kg)

Procedure

1. Adjust the four retractable feet so the rack is level with the ground.

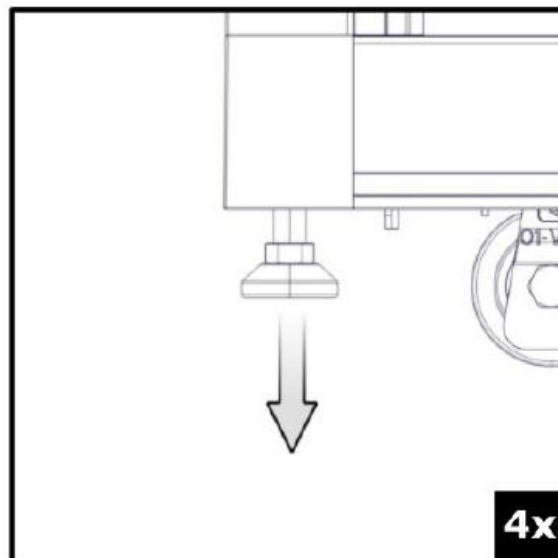

2. Attach two anti-tilt brackets to the feet on the back of the rack.

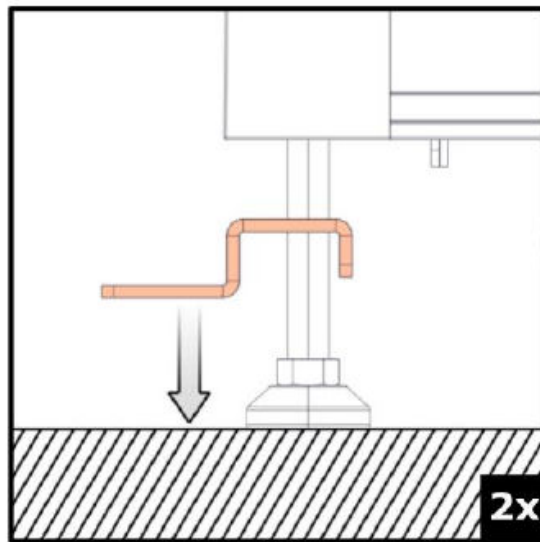
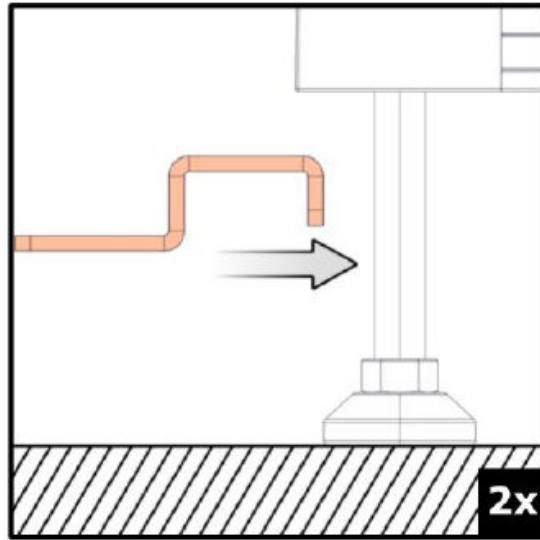

3. Using a minimum size of a M10 or 3/8" screw, fasten the bracket to the floor.

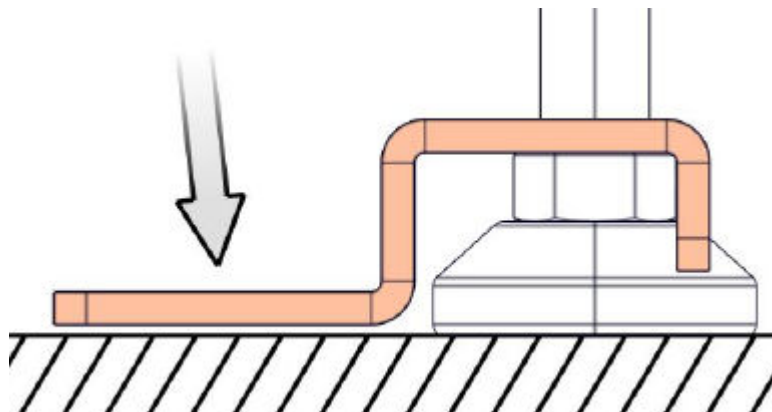

Appendix A: Component list

The following table lists and describes the components of the storage system. For more information, contact your Hitachi Vantara representative or customer support.

Component list

Table 12 CBLA controller components

Model number	Description	Quantity
DW850-CBLA	4U chassis	1
	Power supply unit	2
	LAN board (LAN/UPS)	2
	Backup module (BKM)	8
	Front bezel (4U)	1
	Binder	1
	SAS cable label	2
DW-F800-RRCB	Rail kit	1
DW-F800-BAT	Battery	6

Table 13 CBLA optional controller components

Model number	Description	Quantity
DW-F850-CTLH	Controller board	2
DW-F850-CM32G ¹	Cache memory (32 GB)	8-16
DW-F850-CM64G ¹	Cache memory (64 GB)	8-16
DW-F850-BM35	Cache flash memory (CFM)	2-4
DW-F850-BM45	Cache flash memory (CFM)	2-4

Model number	Description	Quantity
DW-F800-2HS10S	Front-end module (also know as a channel board) (10-Gbps SFP optic-iSCSI)	2-20
DW-F800-2HS10B	Front-end module (10-Gbps copper-iSCSI)	2-20
DW-F800-4HF32R	Front-end module (32/16-Gbps 4port-FC)	2-20
DW-F800-1HP8	PCIe switchboard (also known as a channel board)	2
DW-F800-PC1F	PCIe cable (1.5m)	2
DW-F800-BS12G	Back-end module (also known as disk board)	0-8
DW-F800-BS12GE	Back-end module with encryption	0-8
DW-F800-1PS16	SFP for 16 Gbps Shortwave	0-80
DW-F800-1PL16	SFP for 16 Gbps Longwave	0-80
DW-F800-1PL32	SFP for 32 Gbps Longwave	0-80
DW-F800-BAT	Battery	0-6
Note:		
1. A DIMM of a particular capacity cannot be mixed with different capacities in a storage system configuration.		

Table 14 DBN drive tray components

Model number	Description	Quantity
DW-F850-DBN	2U chassis	1
	ENC	2
	Power supply unit	2
	Front bezel (2U)	1

Table 15 DBF optional drive tray components

Model number	Description	Quantity
DKC-F910I-1R9RVM	1.9 TB, TLC 8 Gbps, flash module drive	0-32
DKC-F910I-3R8RVM	3.8 TB, TLC 8 Gbps, flash module drive	0-32

Model number	Description	Quantity
DKC-F910I-7R6RVM	7.6 TB, TLC 8 Gbps, flash module drive	0-32
DKC-F910I-15RRVM	15 TB, TLC 8 Gbps, flash module drive	0-32
DKC-F910I-30RRVM	30 TB, TLC 8 Gbps, flash module drive	0-32

Table 16 Host port expansion chassis components

Model number	Description	Quantity
DW-F800-CHBB	PCP module	2
	Host port expansion chassis (also known as an I/O expansion box - CHBB chassis)	1
	Power supply unit	2
	PCIe switchboard (fan x 5)	2
	PCIe module	2
	PCIe cable (1.5m)	2
	Front bezel	1
	Accessories kit	1

Table 17 Optional service processor

Model number	Description	Quantity
HDW-F850-SVP.P	Service processor (Windows 10 Enterprise)	1

Hitachi Vantara



Corporate Headquarters
2535 Augustine Drive
Santa Clara, CA 95054 USA
HitachiVantara.com | community.HitachiVantara.com

Contact Information
USA: 1-800-446-0744
Global: 1-858-547-4526
HitachiVantara.com/contact