

Hitachi Virtual Storage Platform 5000 Series

Hitachi Virtual Storage Platform E Series

Hitachi Virtual Storage Platform G130,

G/F350, G/F370, G/F700, G/F900

SVOS RF 9

REST API Reference Guide

This document describes how to use the Web API, which follows the principles of Representational State Transfer (REST), for getting information or changing the configuration of the following storage systems: Hitachi Virtual Storage Platform 5000 series (SVOS RF 9.6.1), Hitachi Virtual Storage Platform E series (SVOS RF 9.6), Hitachi Virtual Storage Platform F350, F370, F700, F900 all-flash arrays and Hitachi Virtual Storage Platform G130, G350, G370, G700, G900 (SVOS RF 9.6).

© 2018, 2021 Hitachi, Ltd. All rights reserved.

No part of this publication may be reproduced or transmitted in any form or by any means, electronic or mechanical, including copying and recording, or stored in a database or retrieval system for commercial purposes without the express written permission of Hitachi, Ltd., or Hitachi Vantara LLC (collectively “Hitachi”). Licensee may make copies of the Materials provided that any such copy is: (i) created as an essential step in utilization of the Software as licensed and is used in no other manner; or (ii) used for archival purposes. Licensee may not make any other copies of the Materials. “Materials” mean text, data, photographs, graphics, audio, video and documents.

Hitachi reserves the right to make changes to this Material at any time without notice and assumes no responsibility for its use. The Materials contain the most current information available at the time of publication.

Some of the features described in the Materials might not be currently available. Refer to the most recent product announcement for information about feature and product availability, or contact Hitachi Vantara LLC at https://support.hitachivantara.com/en_us/contact-us.html.

Notice: Hitachi products and services can be ordered only under the terms and conditions of the applicable Hitachi agreements. The use of Hitachi products is governed by the terms of your agreements with Hitachi Vantara LLC.

By using this software, you agree that you are responsible for:

1. Acquiring the relevant consents as may be required under local privacy laws or otherwise from authorized employees and other individuals; and
2. Verifying that your data continues to be held, retrieved, deleted, or otherwise processed in accordance with relevant laws.

Notice on Export Controls. The technical data and technology inherent in this Document may be subject to U.S. export control laws, including the U.S. Export Administration Act and its associated regulations, and may be subject to export or import regulations in other countries. Reader agrees to comply strictly with all such regulations and acknowledges that Reader has the responsibility to obtain licenses to export, re-export, or import the Document and any Compliant Products.

Hitachi and Lumada are trademarks or registered trademarks of Hitachi, Ltd., in the United States and other countries.

AIX, AS/400e, DB2, Domino, DS6000, DS8000, Enterprise Storage Server, eServer, FICON, FlashCopy, GDPS, HyperSwap, IBM, Lotus, MVS, OS/390, PowerHA, PowerPC, RS/6000, S/390, System z9, System z10, Tivoli, z/OS, z9, z10, z13, z14, z/VM, and z/VSE are registered trademarks or trademarks of International Business Machines Corporation.

Active Directory, ActiveX, Bing, Excel, Hyper-V, Internet Explorer, the Internet Explorer logo, Microsoft, the Microsoft Corporate Logo, MS-DOS, Outlook, PowerPoint, SharePoint, Silverlight, SmartScreen, SQL Server, Visual Basic, Visual C++, Visual Studio, Windows, the Windows logo, Windows Azure, Windows PowerShell, Windows Server, the Windows start button, and Windows Vista are registered trademarks or trademarks of Microsoft Corporation. Microsoft product screen shots are reprinted with permission from Microsoft Corporation.

All other trademarks, service marks, and company names in this document or website are properties of their respective owners.

Copyright and license information for third-party and open source software used in Hitachi Vantara products can be found at <https://www.hitachivantara.com/en-us/company/legal.html>.

EXPORT CONTROLS - Licensee will comply fully with all applicable export laws and regulations of the United States and other countries, and Licensee shall not export, or allow the export or re-export of, the Software, API or Materials in violation of any such laws or regulations. By downloading or using the Software, API, or Materials, Licensee agrees to the foregoing and represents and warrants that Licensee is not located in, under the control of, or a national or resident of any embargoed or restricted country.

Contents

| | |
|---|-----------|
| Preface | 15 |
| Intended audience..... | 15 |
| Product version..... | 15 |
| Document conventions..... | 15 |
| Conventions for storage capacity values..... | 17 |
| Accessing product documentation..... | 18 |
| Getting help..... | 18 |
| Comments..... | 18 |
| Chapter 1: Overview of the REST API | 19 |
| System configuration of the REST API | 19 |
| Notes on backing up and restoring the settings file of a storage system (VSP 5000 series)..... | 20 |
| Requirements for SSL communications..... | 21 |
| Specifying the resource to be managed..... | 22 |
| Specifying an object ID..... | 25 |
| Supported HTTP methods..... | 28 |
| User authentication..... | 29 |
| Session management..... | 31 |
| Request headers..... | 33 |
| Response headers..... | 37 |
| HTTP status codes..... | 37 |
| Request and response formats..... | 39 |
| Query parameters..... | 41 |
| Data type..... | 42 |
| Output format..... | 43 |
| Data object..... | 44 |
| Job object..... | 45 |
| Error object..... | 48 |
| Request object..... | 53 |
| Action template object..... | 53 |
| Locking resources..... | 54 |
| Chapter 2: Common operations in the REST API | 59 |
| Getting the version information..... | 59 |

| | |
|---|------------|
| Getting a list of storage systems..... | 60 |
| Getting information about a specific storage system..... | 62 |
| Getting summary information about storage systems..... | 65 |
| Getting a list of sessions..... | 72 |
| Getting information about a specific session..... | 74 |
| Generating sessions..... | 75 |
| Discarding sessions..... | 77 |
| Getting a list of job information..... | 78 |
| Getting job information..... | 82 |
| Locking a resource group..... | 84 |
| Unlocking a resource group..... | 86 |
| Chapter 3: User management and access control..... | 88 |
| Overview of user management and access control..... | 88 |
| Workflow for user management and access control..... | 89 |
| Input rules for user IDs and passwords..... | 90 |
| Getting a list of resource groups..... | 91 |
| Getting information about a specific resource group..... | 98 |
| Creating a resource group..... | 101 |
| Adding a resource to a resource group..... | 103 |
| Removing a resource from a resource group..... | 106 |
| Deleting a resource group..... | 110 |
| Getting a list of user groups..... | 111 |
| Getting information about a specific user group..... | 113 |
| Creating a user group..... | 115 |
| Changing the user group settings..... | 119 |
| Assigning resource groups to a user group..... | 122 |
| Releasing resource groups assigned to a user group..... | 124 |
| Deleting a user group..... | 126 |
| Getting a list of users..... | 127 |
| Getting information about a specific user..... | 129 |
| Creating a user account..... | 131 |
| Changing the password of the user..... | 133 |
| Adding users to user groups..... | 135 |
| Removing users from user groups..... | 137 |
| Deleting a user account..... | 139 |
| Chapter 4: Parity group management..... | 141 |
| Overview of a parity group..... | 141 |
| Getting information about parity groups..... | 142 |
| Getting information about a specific parity group..... | 149 |
| Getting a list of drive information..... | 153 |

| | |
|---|------------|
| Getting information about a specific drive..... | 161 |
| Creating a parity group..... | 163 |
| Changing the drive settings..... | 167 |
| Changing the accelerated compression setting of a parity group..... | 168 |
| Formatting a parity group..... | 170 |
| Deleting a parity group..... | 172 |
| Chapter 5: Volume allocation..... | 174 |
| Overview of volume allocation..... | 174 |
| Getting information about the capacity of a storage system..... | 175 |
| Getting information about the total efficiency of a storage system..... | 178 |
| Getting volume information..... | 182 |
| Getting information about a specific volume..... | 212 |
| Creating a volume..... | 214 |
| Formatting a volume..... | 219 |
| Expanding the capacity of a volume..... | 222 |
| Changing the volume settings..... | 225 |
| Changing the volume status..... | 232 |
| Shredding a volume..... | 234 |
| Reclaiming zero pages of a DP volume..... | 237 |
| Changing the MP blade assigned to a volume..... | 239 |
| Deleting a volume..... | 241 |
| Getting port information..... | 243 |
| Getting information about a specific port..... | 250 |
| Changing the port attribute..... | 260 |
| Getting information about host groups or iSCSI targets..... | 261 |
| Getting information about a specific host group or iSCSI target..... | 270 |
| Getting a list of host modes and host mode options..... | 273 |
| Creating a host group or an iSCSI target..... | 275 |
| Changing the host group or iSCSI target settings..... | 278 |
| Deleting a host group or the iSCSI target..... | 281 |
| Getting WWN information..... | 282 |
| Getting information about a specific WWN..... | 285 |
| Registering a WWN for the host group..... | 286 |
| Setting the nickname for a WWN..... | 288 |
| Deleting the WWN from a host group..... | 290 |
| Getting iSCSI names..... | 291 |
| Getting information about a specific iSCSI name..... | 294 |
| Registering the iSCSI name for the iSCSI target..... | 296 |
| Setting the nickname for an iSCSI name..... | 298 |
| Deleting the iSCSI name from the iSCSI target..... | 300 |
| Getting information about CHAP users..... | 301 |

| | |
|---|------------|
| Getting information about a specific CHAP user..... | 303 |
| Setting the CHAP user name for the iSCSI target..... | 305 |
| Setting a secret for the CHAP user..... | 306 |
| Deleting the CHAP user from the iSCSI target..... | 308 |
| Getting information about LU paths..... | 310 |
| Getting information about a specific LU path..... | 314 |
| Sending the ping command to a specified host..... | 317 |
| Setting the LU path | 319 |
| Setting the priority levels of ALUA paths..... | 321 |
| Deleting a LU path..... | 322 |
| Setting the command device..... | 324 |
| Getting a list of MP information..... | 327 |
| Releasing the host reservation status by specifying the LU path..... | 329 |
| Releasing the host reservation status by specifying a host group..... | 331 |
| Chapter 6: Pool management..... | 333 |
| Overview of a pool..... | 333 |
| Getting pool information..... | 334 |
| Getting information about a specific pool..... | 370 |
| Creating a pool..... | 385 |
| Changing pool settings..... | 390 |
| Expanding a pool..... | 395 |
| Shrinking a pool..... | 397 |
| Performing performance monitoring of a pool..... | 399 |
| Performing tier relocation..... | 401 |
| Restoring a pool..... | 403 |
| Initializing the capacity saving function for a pool..... | 405 |
| Deleting a pool..... | 406 |
| Chapter 7: Optimizing I/O performance..... | 408 |
| Overview of optimizing I/O performance..... | 408 |
| Getting information about CLPRs..... | 409 |
| Getting information about a specific CLPR..... | 411 |
| Creating a CLPR..... | 413 |
| Changing the settings of a CLPR..... | 415 |
| Deleting a CLPR..... | 417 |
| Assigning LDEVs to a CLPR..... | 418 |
| Assigning parity groups to a CLPR..... | 420 |
| Getting information about external parity groups..... | 422 |
| Getting information about a specific external parity group..... | 425 |
| Assigning external parity groups to a CLPR..... | 428 |
| Changing the MP blade assigned to an external parity group..... | 430 |

| | |
|--|------------|
| Configuring QoS settings for a volume..... | 431 |
| Getting performance information for a volume on which QoS has been set up..... | 435 |
| Managing QoS groups..... | 437 |
| Getting a list of Server Priority Manager information..... | 437 |
| Getting Server Priority Manager information by specifying a volume and the WWN or iSCSI name of an HBA..... | 440 |
| Setting Server Priority Manager information by specifying a volume and the WWN or iSCSI name of the HBA..... | 442 |
| Changing the Server Priority Manager information..... | 445 |
| Deleting Server Priority Manager information..... | 448 |
| Chapter 8: Managing ShadowImage pairs..... | 451 |
| Overview of ShadowImage..... | 451 |
| Workflow for operating ShadowImage pairs..... | 453 |
| Pair status (ShadowImage)..... | 455 |
| Getting a list of copy groups..... | 457 |
| Getting information about a specific copy group..... | 462 |
| Getting a list of ShadowImage pairs..... | 466 |
| Getting information about a specific ShadowImage pair..... | 469 |
| Getting information about all of ShadowImage pairs..... | 472 |
| Creating a ShadowImage pair..... | 475 |
| Splitting ShadowImage pairs in units of copy groups..... | 480 |
| Splitting a ShadowImage pair..... | 483 |
| Resynchronizing ShadowImage pairs in units of copy groups..... | 486 |
| Resynchronizing a ShadowImage pair..... | 488 |
| Restoring ShadowImage pairs in units of copy groups..... | 491 |
| Restoring a ShadowImage pair..... | 493 |
| Deleting a copy group..... | 496 |
| Deleting a ShadowImage pair..... | 497 |
| Chapter 9: Managing Thin Image pairs..... | 500 |
| Overview of Thin Image..... | 500 |
| Workflow for operating Thin Image pairs..... | 503 |
| Pair status (Thin Image)..... | 505 |
| Getting information about Thin Image pairs in units of snapshot groups..... | 508 |
| Getting information about Thin Image pairs in a specified snapshot group..... | 515 |
| Getting information about Thin Image pairs..... | 520 |
| Getting information about a specific Thin Image pair..... | 527 |
| Getting information about all of Thin Image pairs..... | 531 |
| Creating a Thin Image pair..... | 535 |
| Storing snapshot data in units of snapshot groups..... | 540 |
| Storing snapshot data..... | 542 |

| | |
|---|------------|
| Resynchronizing Thin Image pair in units of snapshot groups and deleting snapshot data..... | 543 |
| Resynchronizing a Thin Image pair and deleting snapshot data..... | 546 |
| Restoring snapshot data in units of snapshot groups..... | 548 |
| Restoring snapshot data..... | 550 |
| Assigning a secondary volume to snapshot data..... | 552 |
| Unassigning the secondary volume for snapshot data..... | 554 |
| Deleting Thin Image pairs in units of snapshot groups..... | 556 |
| Deleting a Thin Image pair..... | 557 |
| Deleting Thin Image pairs by snapshot tree..... | 558 |
| Deleting garbage data of all Thin Image pairs in a snapshot tree..... | 560 |
| Cloning pairs in a specified snapshot group..... | 562 |
| Cloning a Thin Image pair..... | 564 |
| Chapter 10: Configuring a remote copy environment..... | 567 |
| Workflow for configuring a remote copy environment..... | 567 |
| Registering and deleting information about remote storage systems..... | 569 |
| Overview of registering and deleting information about remote storage systems..... | 570 |
| Getting a list of remote storage systems..... | 570 |
| Getting information about a specific remote storage system..... | 573 |
| Registering information about remote storage systems..... | 576 |
| Deleting information about remote storage systems..... | 578 |
| Setting remote connections..... | 580 |
| Overview of the remote connection settings..... | 580 |
| Getting a list of remote connections..... | 581 |
| Getting information about a specific remote connection..... | 586 |
| Creating a remote connection..... | 589 |
| Changing the remote connection settings..... | 592 |
| Adding remote paths to a remote connection..... | 595 |
| Deleting a remote path from a remote connection..... | 597 |
| Deleting a remote connection..... | 599 |
| Getting information about iSCSI ports..... | 601 |
| Getting information about a specific iSCSI port..... | 604 |
| Registering an iSCSI port..... | 606 |
| Removing the registration of an iSCSI port..... | 609 |
| Setting journals..... | 611 |
| Getting journal information..... | 611 |
| Getting information about a specific journal..... | 618 |
| Creating a journal..... | 620 |
| The mirror journal status..... | 622 |
| Changing journal settings..... | 623 |

| | |
|---|-----|
| Adding a journal volume..... | 627 |
| Deleting a journal volume from a journal..... | 629 |
| Changing the MP blade assigned to a journal..... | 631 |
| Deleting a journal..... | 632 |
| Setting quorum..... | 633 |
| Getting information about quorum disks..... | 634 |
| Getting information about a specific quorum disk..... | 636 |
| Registering information about a quorum disk..... | 638 |
| Deleting information about a quorum disk..... | 640 |

Chapter 11: Managing TrueCopy pairs or Universal Replicator pairs... 642

| | |
|---|-----|
| Overview of TrueCopy and Universal Replicator..... | 642 |
| Workflow for operating TrueCopy pairs or Universal Replicator pairs..... | 643 |
| Flow of recovery operations to be performed when a failure occurs at the primary site of a Universal Replicator pair..... | 645 |
| Pair status (TrueCopy and Universal Replicator)..... | 648 |
| Getting a list of remote copy groups | 652 |
| Getting information about a specific remote copy group..... | 662 |
| Getting information about a specific remote copy pair..... | 675 |
| Getting TrueCopy or Universal Replicator pair information..... | 682 |
| Getting information about all of remote copy pairs..... | 685 |
| Creating a TrueCopy pair or Universal Replicator pair..... | 692 |
| Splitting TrueCopy pairs or Universal Replicator pairs in units of copy groups..... | 701 |
| Splitting a TrueCopy pair or Universal Replicator pair..... | 706 |
| Resynchronizing TrueCopy pairs or Universal Replicator pairs in units of copy groups..... | 711 |
| Resynchronizing a TrueCopy pair or Universal Replicator pair..... | 718 |
| Deleting TrueCopy pairs or Universal Replicator pairs in units of copy groups..... | 726 |
| Deleting a TrueCopy pair or Universal Replicator pair..... | 727 |
| Enabling volumes at the secondary site to take over work in units of copy groups..... | 729 |
| Enabling volumes at the secondary site to take over work in units of copy pairs..... | 732 |

Chapter 12: Managing global-active device pairs..... 736

| | |
|---|-----|
| Overview of global-active device..... | 736 |
| Workflow for operating global-active device pairs..... | 737 |
| Pair status (global-active device)..... | 739 |
| Getting a list of remote copy groups..... | 744 |
| Getting information about a specific remote copy group..... | 753 |
| Getting information about global-active device pairs..... | 766 |

| | |
|--|------------|
| Getting information about a specific remote copy pair..... | 770 |
| Getting information about all of remote copy pairs..... | 778 |
| Creating a global-active device pair..... | 784 |
| Deleting global-active device pairs in units of copy groups..... | 790 |
| Deleting a global-active device pair..... | 793 |
| Suspending global-active device pairs in units of copy groups..... | 795 |
| Suspending a global-active device pair..... | 799 |
| Resynchronizing global-active device pairs in units of copy groups..... | 802 |
| Resynchronizing a global-active device pair..... | 808 |
| Chapter 13: Performing Volume Migration operations..... | 814 |
| Overview of Volume Migration..... | 814 |
| Workflow for performing Volume Migration..... | 816 |
| Pair status transitions (Volume Migration)..... | 819 |
| Creating a pair to be used for Volume Migration..... | 820 |
| Performing migration for an entire copy group..... | 823 |
| Performing migration..... | 824 |
| Getting a list of copy groups (Volume Migration)..... | 826 |
| Getting information about a specific copy group (Volume Migration)..... | 830 |
| Getting a list of pairs (Volume Migration)..... | 835 |
| Getting information about a specific pair (Volume Migration)..... | 837 |
| Deleting a pair (Volume Migration)..... | 840 |
| Deleting a copy group (Volume Migration)..... | 842 |
| Canceling migration for an entire copy group..... | 843 |
| Canceling migration..... | 845 |
| Chapter 14: Performing Universal Volume Manager operations | 848 |
| Overview of Universal Volume Manager..... | 848 |
| Workflow for Universal Volume Manager..... | 850 |
| Getting information about an iSCSI target of a port on an external storage system..... | 855 |
| Registering an iSCSI name of an external storage system to a port on the local storage system..... | 858 |
| Getting the iSCSI name of an external storage system that is registered to a port on the local storage system..... | 860 |
| Performing a login test on an iSCSI target of an external storage system that is registered to a port on the local storage system..... | 863 |
| Getting a list of ports on an external storage system..... | 865 |
| Getting a list of LUs defined for a port on an external storage system..... | 868 |
| Mapping an external volume..... | 871 |
| Getting a list of external path groups..... | 875 |
| Getting information about a specific external path group..... | 883 |
| Adding an external path to an external path group..... | 889 |

| | |
|--|------------|
| Removing an external path from an external path group..... | 892 |
| Unmapping an external volume..... | 894 |
| Disconnecting from an external volume..... | 896 |
| Deleting an iSCSI name of an external storage system that is registered to a port on the local storage system..... | 897 |
| Chapter 15: Initial settings for a storage system..... | 900 |
| Overview of the initial settings of a storage system..... | 900 |
| Getting the system date and time of a storage system..... | 901 |
| Getting a list of time zones that can be used in a storage system..... | 903 |
| Setting the system date and time of a storage system..... | 905 |
| Uploading the files required for initial configuration..... | 910 |
| Getting information about the transfer destinations of audit log files..... | 912 |
| Specifying the transfer destinations of audit log files..... | 915 |
| Sending test messages to the transfer destinations of audit log files..... | 923 |
| Getting SNMP settings..... | 924 |
| Specifying the SNMP error notification destinations..... | 931 |
| Sending a test SNMP trap..... | 941 |
| Getting information about the error notification email settings..... | 942 |
| Specifying settings for error notification emails..... | 945 |
| Adding a destination address for error notification emails..... | 953 |
| Deleting a destination address for error notification emails..... | 955 |
| Sending a test error notification email..... | 957 |
| Getting a list of license information..... | 958 |
| Getting information about a specific license..... | 962 |
| Installing software..... | 964 |
| Enabling or disabling a license..... | 966 |
| Removing software..... | 967 |
| Changing the user information used in searches of the external authentication server set for a storage system..... | 968 |
| Chapter 16: Encrypting data..... | 972 |
| Overview of data encryption..... | 972 |
| Workflow for operations related to data encryption..... | 973 |
| Getting information about the encryption environment settings..... | 977 |
| Changing the encryption environment settings..... | 979 |
| Getting the number of encryption keys..... | 981 |
| Getting information about a list of encryption keys..... | 982 |
| Getting a specific encryption key..... | 986 |
| Creating encryption keys..... | 988 |
| Deleting an encryption key..... | 990 |
| Backing up encryption keys..... | 991 |

| | |
|---|-------------|
| Restoring encryption keys..... | 993 |
| Chapter 17: Monitoring storage systems..... | 996 |
| Getting a list of alert information..... | 996 |
| Getting information about the hardware installed in a storage system..... | 1000 |
| Getting information about channel boards..... | 1022 |
| Chapter 18: Managing resources by using virtual storage machines. 1025 | |
| Overview of managing resources by using virtual storage machines..... | 1025 |
| Workflow for managing resources by using virtual storage machines..... | 1026 |
| Getting a list of virtual storage machines..... | 1027 |
| Getting information about a specific virtual storage machine..... | 1029 |
| Creating a virtual storage machine..... | 1031 |
| Deleting a virtual storage machine..... | 1034 |
| Getting information about virtual LDEVs..... | 1035 |
| Setting a virtual LDEV number..... | 1043 |
| Deleting a virtual LDEV number..... | 1045 |
| Chapter 19: Sample coding..... | 1048 |
| Overview of sample coding..... | 1048 |
| Sample coding for volume allocation..... | 1057 |
| Sample coding for ShadowImage pair operations..... | 1071 |
| Sample coding for registering remote storage system information..... | 1083 |
| Sample coding for TrueCopy pair operations..... | 1096 |
| Sample coding for uploading files (specifying the transfer destinations of audit log files)..... | 1112 |
| Sample coding for downloading a file (backing up encryption keys)..... | 1126 |
| Sample coding for re-creating a parity group (data encryption)..... | 1131 |
| Functions used in the sample coding..... | 1142 |
| Appendix A: Getting configuration information (including additional information) from the storage system cache..... | 1151 |
| About the acquisition of additional information..... | 1151 |
| Updating the cache of storage system configuration information..... | 1153 |
| Appendix B: Implementing retry processing..... | 1155 |
| Implementing retry processing..... | 1155 |
| Appendix C: Operations performed on QoS groups by using REST API requests that include simple in the request line..... | 1159 |
| Overview of REST API requests that include simple in the request line..... | 1159 |
| Specifying resources to manage (URL)..... | 1159 |
| Specifying an object ID..... | 1161 |
| Supported HTTP methods..... | 1161 |

| | |
|---|-------------|
| Request headers..... | 1162 |
| Response headers..... | 1163 |
| HTTP status codes..... | 1164 |
| Request and response formats..... | 1165 |
| Query parameters..... | 1165 |
| Data type..... | 1166 |
| Output format..... | 1167 |
| Data object..... | 1167 |
| Error object..... | 1167 |
| Operations on QoS groups..... | 1168 |
| Getting a list of QoS groups..... | 1168 |
| Getting information for a specific QoS group..... | 1171 |
| Getting performance information for a specific QoS group..... | 1175 |
| Appendix D: Notes and restrictions..... | 1177 |
| Notes and restrictions..... | 1177 |

Preface

This document provides information and instructions to help you use the REST API.

The REST API provides the Web API, which follows the principles of Representational State Transfer (REST), for getting information about storage systems or changing the configuration of storage systems.

Please read this document carefully to understand how to use the REST API, and keep a copy of this document for reference.

Intended audience

This document is intended for system administrators and authorized service providers who are involved in configuring and operating any of the following storage systems: Hitachi Virtual Storage Platform 5000 series; Hitachi Virtual Storage Platform E series; Hitachi Virtual Storage Platform F350, F370, F700, F900; Hitachi Virtual Storage Platform G350, G370, G700, G900.

Readers of this document should be familiar with the following:

- Data processing, as well as RAID storage systems and their basic functions
- The relevant storage systems of the following: Hitachi Virtual Storage Platform 5000 series; Hitachi Virtual Storage Platform E series; Hitachi Virtual Storage Platform F350, F370, F700, F900; Hitachi Virtual Storage Platform G350, G370, G700, G900.
- Writing programs that use the REST API

Product version

This document revision applies to the following microcode or firmware:

- VSP 5000 series: firmware 90-06-21 or later
- VSP E series: firmware 93-04-02 or later
- VSP F350, F370, F700, F900: firmware 88-08-02 or later
- VSP G350, G370, G700, G900: firmware 88-08-02 or later



Document conventions

This document uses the following typographic conventions:

| Convention | Description |
|---------------------|--|
| Bold | <ul style="list-style-type: none"> Indicates text in a window, including window titles, menus, menu options, buttons, fields, and labels. Example: Click OK. Indicates emphasized words in list items. |
| <i>Italic</i> | <ul style="list-style-type: none"> Indicates a document title or emphasized words in text. Indicates a variable, which is a placeholder for actual text provided by the user or for output by the system. Example: <pre>pairdisplay -g group</pre> <p>(For exceptions to this convention for variables, see the entry for angle brackets.)</p> |
| Monospace | Indicates text that is displayed on screen or entered by the user. Example: <code>pairdisplay -g oradb</code> |
| < > angle brackets | Indicates variables in the following scenarios: <ul style="list-style-type: none"> Variables are not clearly separated from the surrounding text or from other variables. Example: <pre>Status-<report-name><file-version>.csv</pre> Variables in headings. |
| [] square brackets | Indicates optional values. Example: [a b] indicates that you can choose a, b, or nothing. |
| { } braces | Indicates required or expected values. Example: { a b } indicates that you must choose either a or b. |
| vertical bar | Indicates that you have a choice between two or more options or arguments. Examples: [a b] indicates that you can choose a, b, or nothing. { a b } indicates that you must choose either a or b. |

This document uses the following icons to draw attention to information:

| Icon | Label | Description |
|---|-------|---|
|  | Note | Calls attention to important or additional information. |

| Icon | Label | Description |
|---|---------|--|
|  | Tip | Provides helpful information, guidelines, or suggestions for performing tasks more effectively. |
|  | Caution | Warns the user of adverse conditions and/or consequences (for example, disruptive operations, data loss, or a system crash). |
|  | WARNING | Warns the user of a hazardous situation which, if not avoided, could result in death or serious injury. |

Conventions for storage capacity values

Physical storage capacity values (for example, disk drive capacity) are calculated based on the following values:

| Physical capacity unit | Value |
|------------------------|-----------------------------|
| 1 kilobyte (KB) | 1,000 (10^3) bytes |
| 1 megabyte (MB) | 1,000 KB or $1,000^2$ bytes |
| 1 gigabyte (GB) | 1,000 MB or $1,000^3$ bytes |
| 1 terabyte (TB) | 1,000 GB or $1,000^4$ bytes |
| 1 petabyte (PB) | 1,000 TB or $1,000^5$ bytes |
| 1 exabyte (EB) | 1,000 PB or $1,000^6$ bytes |

Logical capacity values (for example, logical device capacity, cache memory capacity) are calculated based on the following values:

| Logical capacity unit | Value |
|-----------------------|--|
| 1 block | 512 bytes |
| 1 cylinder | Mainframe: 870 KB Open-systems: <ul style="list-style-type: none"> ▪ OPEN-V: 960 KB ▪ Others: 720 KB |
| 1 KB | $1,024 (2^{10})$ bytes |
| 1 MB | 1,024 KB or $1,024^2$ bytes |

| Logical capacity unit | Value |
|-----------------------|--------------------------------------|
| 1 GB | 1,024 MB or 1,024 ³ bytes |
| 1 TB | 1,024 GB or 1,024 ⁴ bytes |
| 1 PB | 1,024 TB or 1,024 ⁵ bytes |
| 1 EB | 1,024 PB or 1,024 ⁶ bytes |

Accessing product documentation

Product user documentation is available on the Hitachi Vantara Support Website: <https://knowledge.hitachivantara.com/Documents>. Check this site for the most current documentation, including important updates that may have been made after the release of the product.

Getting help

The [Hitachi Vantara Support Website](https://support.hitachivantara.com/en_us/contact-us.html) is the destination for technical support of products and solutions sold by Hitachi Vantara. To contact technical support, log on to the Hitachi Vantara Support Website for contact information: https://support.hitachivantara.com/en_us/contact-us.html.

[Hitachi Vantara Community](https://community.hitachivantara.com) is a global online community for Hitachi Vantara customers, partners, independent software vendors, employees, and prospects. It is the destination to get answers, discover insights, and make connections. **Join the conversation today!** Go to community.hitachivantara.com, register, and complete your profile.

Comments

Please send us your comments on this document to doc.comments@hitachivantara.com. Include the document title and number, including the revision level (for example, -07), and refer to specific sections and paragraphs whenever possible. All comments become the property of Hitachi Vantara LLC.

Thank you!

Chapter 1: Overview of the REST API

This chapter describes the system configuration for using the REST API, how to specify resources, the format of requests and responses, and descriptions of each object.

System configuration of the REST API

This section explains the basic system configuration for using the REST API.

The following shows the basic system configuration of the REST API.

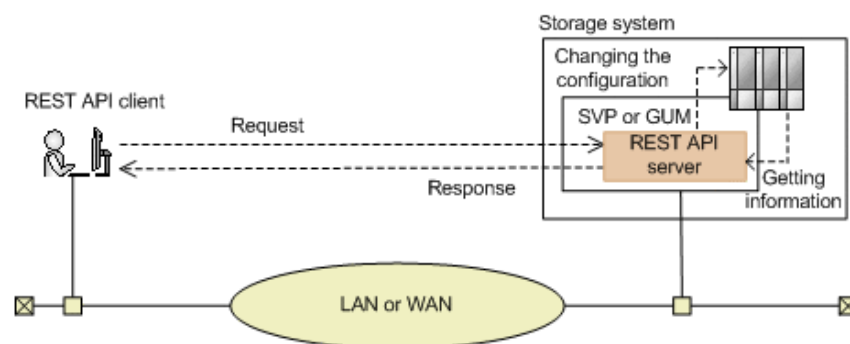

Storage system

By using the REST API, you can get information from the storage system or change the configuration of the storage system. The REST API can perform operations on the following storage systems:

- VSP 5000 series
- VSP E series
- VSP F350, F370, F700, F900
- VSP G350, G370, G700, G900

SVP (Service Processor)

This is a computer that has basic functions for managing storage systems. You can manage a storage system via an external device that communicates with the SVP in the case of a VSP 5000 series storage system.

GUM (Gateway for Unified Management)

This is a computer that has basic functions for managing storage systems. You can manage a storage system via an external device that communicates with the GUM in the case of a VSP E series, VSP G350, G370, G700, G900, VSP F350, F370, F700, F900 storage system.

GUM exists in each controller, CTL1 and CTL2.

REST API server

This is a component that acts as a server to receive REST API requests from REST API clients, issue orders to the storage system, and then return the execution results to the REST API clients.

The REST API server is installed on the storage system's SVP in the case of a VSP 5000 series storage system, and on the storage system's GUM in the case of a VSP E series, VSP G350, G370, G700, G900, VSP F350, F370, F700, F900 storage system.



Note:

In the case of VSP E series, VSP G350, G370, G700, G900, VSP F350, F370, F700, F900 storage systems, the REST API servers that are allocated on the GUM of CTL1 and CTL2 operate independently. Therefore, when a failure occurs in one GUM, the REST API server on the other GUM can be used to run the operation. However, the following information is not inherited by the REST API servers:

- Job information
- Remote storage system information

If necessary, register information about the remote storage systems to the other REST API server.

REST API clients

The REST API clients issue requests to the REST API server. The term "REST API client" refers to software or scripts that use the REST API.

In the case of VSP E series, VSP G350, G370, G700, G900, VSP F350, F370, F700, F900 storage systems, you can use the REST API to run API requests other than those described in this manual, such as API requests that get information in a simple format and API requests that return responses at a high speed. For details about these API requests, see [Hitachi Vantara Knowledge](#).



Note: The REST API server links internally with the CCI of the SVP or the GUM. The maximum number of CCI instances used by the REST API server is 1000, in the range from 1048 to 2047. If you use the CCI of the SVP or the GUM for a purpose other than the REST API, use an instance number that is not in the range from 1048 to 2047.

Notes on backing up and restoring the settings file of a storage system (VSP 5000 series)

You can also use Hitachi Device Manager - Storage Navigator to back up a REST API database file as the settings file of a VSP 5000 series storage system. You can restore the backed up files by using Storage Navigator.

When you use Storage Navigator to back up or restore the settings files, the REST API services automatically stop. If you attempt to use Storage Navigator to back up or restore the settings files when the REST API services cannot be stopped, the operation will fail. For this reason, do not back up or restore the settings files of a storage system if the REST API is performing an operation or has locked a resource.

Requirements for SSL communications

This section describes how to set up SSL communication for the REST API.

With the REST API, you can use SSL communication between the REST API clients and the REST API server.

For SSL communications between REST API clients and the REST API server, the server certificate for HTTPS installed in the SVP or the GUM is used. By default, this server certificate is a self-signed certificate. For this reason, a communication error might occur depending on the client program. To resolve this issue, do one of the following:

- Change the certificate of the storage system to a server certificate trusted by a certificate authority, such as VeriSign.

For details on how to obtain a certificate signed by a certificate authority and how to update the certificate on the SVP or the GUM, see the *System Administrator Guide*.

- Correct the client programs to avoid errors.

The approach taken to correct client programs to avoid errors varies by programming language.

For example, if the Requests library is used with Python, verification of the server certificate can be omitted if `verify=False` is specified when a request is issued.

You can use the following protocol versions and encryption methods (cipher suites) for communication between the REST API clients and the REST API server.

- For VSP 5000 series storage systems:

The TLS versions and encryption methods (cipher suites) that can be used vary depending on the SVP communication settings.

For details on how to configure SVP communication settings, see the *System Administrator Guide*.

- For VSP E series, VSP G350, G370, G700, G900, VSP F350, F370, F700, F900 storage systems:

The following table shows the TLS versions and encryption methods (cipher suites) that can be used.

| TLS | encryption methods (cipher suites) |
|--------|--|
| TLS1.2 | <ul style="list-style-type: none"> ▪ TLS_RSA_WITH_AES_128_CBC_SHA256 (0x00,0x3C) ▪ TLS_RSA_WITH_AES_256_CBC_SHA256 (0x00,0x3D) ▪ TLS_RSA_WITH_AES_128_GCM_SHA256 (0x00,0x9C) ▪ TLS_RSA_WITH_AES_256_GCM_SHA384 (0x00,0x9D) ▪ TLS_ECDHE_RSA_WITH_AES_128_GCM_SHA256 (0xC0,0x2F) ▪ TLS_ECDHE_RSA_WITH_AES_256_GCM_SHA384 (0xC0,0x30) |

Specifying the resource to be managed

In REST API, domains are separated for each type of operation. The URL format differs for each domain. The domains used in REST API and the URL format are as follows:

Objects domain:

A domain for defining operations on each object subject to REST API operations, such as operations on storage system resources (for example, LDEVs or pools). Specify the URL in the following format:

```
protocol://host-name:port-number/ConfigurationManager/version/objects
```

Services domain:

A domain for defining the services provided by the REST API server. Services indicate batch operations for multiple objects, or operations for using or changing the configuration of the REST API server, such as locking or unlocking a resource group. Specify the URL in the following format:

```
protocol://host-name:port-number/ConfigurationManager/version/  
services
```

Configuration domain:

A domain for defining settings related to the REST API server, for example, collecting REST API version information. Specify the URL in the following format:

```
protocol://host-name:port-number/ConfigurationManager/configuration
```

Base URL:

```
protocol://host-name:port-number/ConfigurationManager
```

- Protocol: Specify `https` or `http`. We recommend specifying `https` for security.
- Host name: Specify the IP address of the GUM (SVP) or a host name that can be resolved.
- Port number: Specify the port number to be used for communications with the REST API server. The default port number is 443 for SSL communications, and 80 for non-SSL communications. The port number can be omitted if the default port number is used for communications.
- Version: Specify the version of the REST API. Currently, only `v1` can be specified.

**Tip:**

You can also specify the URL in the same format used for the Configuration Manager REST API. Specify the URL in the following format:

- For the objects domain

```
protocol://host-name:port-number/ConfigurationManager/version/objects/storages/storage-device-ID
```

- For the services domain

```
protocol://host-name:port-number/ConfigurationManager/version/storage-device-ID/services
```

For the storage device ID, specify a 12-digit value consisting of the fixed value designated for the model of the storage system and the storage system's 6-digit serial number. If the serial number is less than six digits, pad it with leading zeros. The fixed value designated for the storage system model is as follows.

| Storage system | Fixed value |
|--|----------------------|
| VSP 5100, VSP 5100H, VSP 5500, VSP 5500H | 900000 ^{#1} |
| VSP E990 | 936000 |
| VSP E590, VSP E790 | 934000 |
| VSP F370, F700, F900 VSP G370, G700, G900 | 886000 |
| VSP F350 VSP G350 | 882000 |
| VSP G130 ^{#2} | 880000 |

^{#1}: These storage systems have serial numbers that are less than 6 digits. Pad the storage device ID with zeros, added after this designated value and before the serial number, to bring the total number of digits for the storage device ID up to 12.

^{#2}: This model is available only in select markets. Contact your local sales representative for availability.

- The following describes the URL formats supported by each domain.

For the objects domain:

| URL formats (excluding the base URL) | HTTP method | Operations |
|--|-------------|---|
| <i>/v1/objects/storages</i> | GET | Obtain general information about the target storage system |
| <i>/v1/objects/storages/instance</i> You can also specify the URL in the following format: <i>/v1/objects/storages/storage-device-ID</i> | GET | Obtain detailed information about the target storage system |
| <i>/v1/objects/object-type</i> You can also specify the URL in the following format: <i>/v1/objects/storages/storage-device-ID/object-type</i> | GET | Obtain a list of multiple objects |
| | POST | Create new objects |
| <i>/v1/objects/object-type/object-ID</i> You can also specify the URL in the following format: <i>/v1/objects/storages/storage-device-ID/object-type/object-ID</i> | GET | Obtain an object |
| | PATCH | Change an attribute of an object |
| | DELETE | Delete an object |
| <i>/v1/objects/object-type/object-ID/actions/action-name</i> You can also specify the URL in the following format: <i>/v1/objects/storages/storage-device-ID/object-type/object-ID/actions/action-name</i> | GET | Obtain the action template for an object |
| <i>/v1/objects/object-type/object-ID/actions/action-name/invoke</i> | POST | Run an action on an object |

| URL formats (excluding the base URL) | HTTP method | Operations |
|---|-------------|------------|
| You can also specify the URL in the following format: <code>/v1/objects/storages/storage-device-ID/object-type/object-ID/actions/action-name/invoke</code> | | |

For the services domain:

| URL formats (excluding the base URL) | HTTP method | Operations |
|---|-------------|--------------------------------------|
| <code>/v1/services/service-name/actions/action-name/invoke</code> You can also specify the URL in the following format: <code>/v1/storage-device-ID/services/service-name/actions/action-name/invoke</code> | POST | Run a specific action of the service |

For the configuration domain:

| URL formats (excluding the base URL) | HTTP method | Operations |
|--------------------------------------|-------------|--|
| <code>configuration/version</code> | GET | Obtain the version information of the REST API |

The following is an example of a URL:

```
https://192.0.2.100/ConfigurationManager/v1/objects/ldevs
```

Specifying an object ID

An object ID is an ID that is used to uniquely identify a resource. An object ID is used when specifying a specific resource in a URL.

You can use the following two methods to specify an object ID:

- (Recommended) Run the GET operation to obtain the object ID from the execution result.

Example: When specifying the object ID of an LDEV

If the object type is `ldevs`, because the object ID of the LDEV is unique in the storage system, use the object ID obtained by running the GET operation without changing the ID.

If the object ID of the LDEV is `100`, specify as follows:

```
ldevs/100
```

- Generate an object ID by using the character string that connects multiple attribute values with commas.

Example: When specifying the object ID of a host group

If the object type is `host-groups`, the object ID of the host group can be generated by connecting, with a comma, the attribute value of the port and the attribute value of the host group that belongs to the port. If the attribute value representing the port is `CL1-A`, and the attribute value representing the host group which belongs to the port is `200`, specify as follows:

```
host-groups/CL1-A,200
```

To generate an object ID by connecting multiple attribute values with commas, the attribute value must be encoded in accordance with the RFC3986 on the REST API client. After all attribute values are encoded, specify the character string that connects multiple attribute values with commas to be the object ID. Typical symbols which need encoding are shown below.

| Pre-Encode | Post-Encode |
|---------------------------|-------------|
| ! (exclamation mark) | %21 |
| # (number sign) | %23 |
| \$ (dollar sign) | %24 |
| % (percent) | %25 |
| & (ampersand) | %26 |
| ' (single quotation mark) | %27 |
| ((left parenthesis) | %28 |
|) (right parenthesis) | %29 |
| * (asterisk) | %2A |
| + (plus sign) | %2B |
| , (comma) | %2C |
| : (colon) | %3A |
| ; (semicolon) | %3B |
| = (equal sign) | %3D |
| ? (question mark) | %3F |
| @ (at sign) | %40 |
| [(left square bracket) | %5B |
|] (right square bracket) | %5D |

Here is an example of specifying the object ID of the ShadowImage pair from the following attribute values:

```
"copyGroupName": "localCopyGroup1"
"pvolDeviceGroupName": "localCopyGroup1P_"
"svolDeviceGroupName": "localCopyGroup1S_"
"copyPairName": "pair_1P,1S"
```

In this example, the comma in `copyPairName` is encoded to `%2C`, and then the values are connected with commas. The resulting object ID is as follows.

```
localCopyGroup1,localCopyGroup1P_,localCopyGroup1S_,pair_1P%2C1S
```

**Note:**

- If the object ID is obtained by performing the GET operation, the REST API server returns an encoded value. To use the object ID obtained by performing the GET operation in a request of another operation, use the object ID without decoding it.
- If you want to create a new object or change an attribute, we recommend that you do not specify values that contain the reserved characters listed above.

Supported HTTP methods

HTTP defines methods, which are operations that can be performed on resources.

The REST API supports the following HTTP methods.

| HTTP method | Description | Processing method |
|-------------|--|--|
| GET | This method gets object information. Alternatively, this method gets a list of objects. For example, this method can obtain a list of pools. | Synchronous |
| POST | <ul style="list-style-type: none"> ▪ This method creates new objects. For example, this method can create pools. ▪ This method can perform specific actions to objects. For example, this method can expand pools. | Asynchronous However, the following APIs are performed in synchronous processing. <ul style="list-style-type: none"> ▪ Generating sessions ▪ Uploading the files required for initial configuration ▪ Getting information about an iSCSI target of a port on an external storage system ▪ Performing a login test on an iSCSI target of an external storage system that is registered to a port on the local storage system ▪ Backing up encryption keys |
| PATCH | This method changes the attributes or the state of an object. For example, this method can change the pool threshold. | Asynchronous |

| HTTP method | Description | Processing method |
|-------------|---|--|
| | | <p>However, the following API is performed in synchronous processing.</p> <ul style="list-style-type: none"> Setting the system date and time of a storage system |
| DELETE | <p>This method deletes objects.</p> <p>For example, this method can delete pools.</p> | <p>Asynchronous</p> <p>However, the following APIs are performed in synchronous processing.</p> <ul style="list-style-type: none"> Discarding sessions |

The following explains the processing method for the REST API (synchronous processing and asynchronous processing):

- For synchronous processing, the processing results are returned in the response.
- For asynchronous processing, the operation on the resource is registered as a job. In addition, the job information and the HTTP status code 202, which indicates that the processing has been accepted, are returned in the response. Subsequently, the registered job runs asynchronously. If registration of a job fails, the HTTP status code 500 is returned.



Tip:

- If you specify `Completed` for the `Response-Job-Status` in the request header (even for asynchronous processing operations), a response will be returned only after the job is complete.
- For pair operations, you can use `Job-Mode-Wait-Configuration-Change` in the request header to specify the time when the job status changes to `Completed`. If you specify `NoWait` in the request header, the job status will change to `Completed` without waiting for data copying to finish.

User authentication

User authentication is required to operate the storage system. To perform user authentication, the Authorization header must be specified.

In the REST API, session-based user authentication is performed. A session is always generated first when a REST API client accesses the REST API server and starts an operation. In the request that generates a session, the user ID and password are used for authentication to access the storage system. After a session is created, specify session information for the Authorization header to perform authentication based on the session information.

Selecting the appropriate user authentication method

When using the REST API, use different authorization methods appropriately, as shown below.

- For session generation: Authorization is based on the user ID and password.
- For operations other than the above: Authorization is based on the session.

The following provides an overview of authentication based on the operation of the REST API.

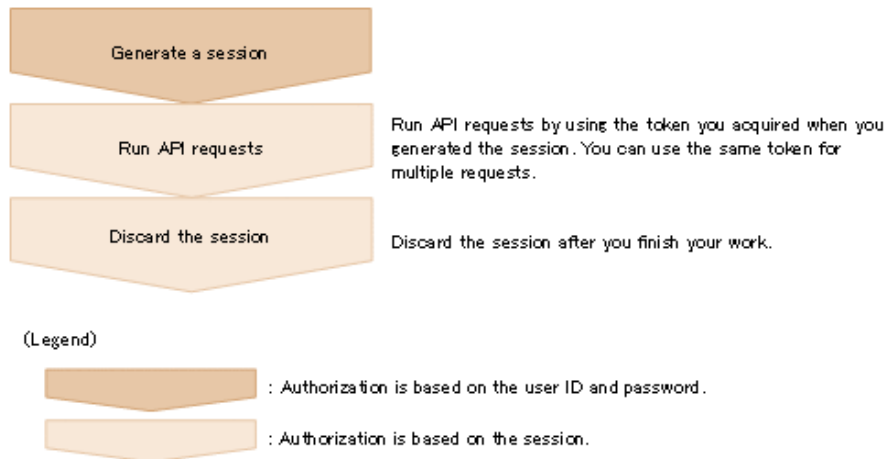

Authentication by the user ID and password

When you create a session, specify authentication information in the following format in the Authorization header:

```
Authorization: Basic authentication-information
```

authentication-information

Specify a base64-encoded character string in which the user ID and password are concatenated with a colon (:). Use the user ID and password of a user account that can perform operations on storage system resources.

When using the REST API, you can use the following characters for the user ID and password.

| Item | Number of characters | Specifiable characters |
|----------|----------------------|--|
| User ID | 1 to 63 characters | <p>You can use the following characters.</p> <ul style="list-style-type: none"> ▪ Alphanumeric characters ▪ The following symbols: ! # \$ % & ' * + - . / = ? @ ^ _ ` { } ~ |
| Password | 6 to 63 characters | <p>You can use the following characters.</p> <ul style="list-style-type: none"> ▪ Alphanumeric characters ▪ ASCII symbols which can be keyed in except space: ! " # \$ % & ' () * + , - . / : ; < = > ? @ [\] ^ _ ` { } ~ |

The following is an example of the Authorization header where the user ID is `sample-user`, and the password is `sample-password`:

```
Authorization: Basic c2FtcGx1LXVzZXI6c2FtcGx1LXBhc3N3b3Jk
```

Authentication by sessions

Specify the token for the session in the following format in the Authorization header:

```
Authorization: Session token
```

Token

A token is authentication information that is returned after a session is created. This information is used to determine whether the request was issued from an authorized user.

Example of the Authorization header:

```
Authorization: Session 550e8400-e29b-41d4-a716-446655440000
```

Session management

In the REST API, a session is used to identify multiple requests as a series of operations to be performed by the same client. For example, if a user wants to use the same account to run two client programs in parallel, the user must generate a session for each client program. On the REST API server, each program is identified based on session information. In addition, when the REST API is used to exclusively lock the resources to be operated, the REST API controls the locks on a session basis.

A session is always generated when a REST API client accesses the REST API server and starts an operation on a storage system. After a session is generated, a session ID and token are returned to the client. In subsequent operations, specify the token for the Authorization header of each request, as authentication information. To terminate operations from a REST API client, discard sessions to prevent sessions that are no longer required from remaining on the server.

Generating a session

A REST API session is created when the user runs the API that generates a session. A user can generate multiple sessions. The maximum number of sessions that can be used is 64 per storage system.

After the session is generated, the following information is returned to the client as a response:

- Session ID

ID used for identifying a session on the REST API server. A session ID is used to check whether the session is valid or to discard the session. The user who created the session, or a user who belongs to the Administrator user group (built-in user group) can view the session ID.

- Token

Information that is used to identify the source that issues requests as a specific user. A token is used to decide whether the request is issued during the same session. Only the user who created the session can view the token.

Running an API request by using a session

To use a session to run an API request, specify a token for the Authorization header of the request as authorization credentials. The requests for which the same token is specified are handled as the operation during the same session. The following is an example of specifying the Authorization header with a token specified.

```
Authorization : Session d7b673af189048468c5af9bcf3b6bb6f
```

If a session goes unused for a certain period of time, it is automatically discarded (session timeout). The time that elapses until a session timeout is the time that has elapsed since the session was generated or the execution result of the request for which the session was specified was returned. The wait time during synchronous processing and the wait time for the response of an asynchronous processing API request are not included in that time. If a request that uses that session is issued during the time that elapses until a session timeout, the time is reset. The time until a session timeout is 300 seconds (5 minutes) by default. However, you can specify the time until a session timeout when a session is generated.

To prevent the session for an operation that is in progress from being discarded by a timeout, periodically issue a request that uses the session.

**Tip:**

If the information (such as the role and resource group) about the user who generated the session is changed while the session is being used, the changes are applied to the operation even while the session is being used. If the password of the user who generated the session is changed, the session might be discarded.

Discarding a session

If you no longer need to manage sessions after finishing a series of operations, discard the sessions. Sessions can be discarded only by the user who generated the sessions, or a user who belongs to the Administrator user group (built-in user group) .

If you have locked the resources by specifying a session, the resources will be unlocked when the session is discarded.

Request headers

This section describes the request headers supported by the REST API.

| Header | Category | Description | Specifiable value |
|----------------|----------|--|--|
| Accept | Optional | Specifies the media type of the response. | */* (json) Default value: */* (json) |
| Content-Type | Optional | Specifies the media type of the request body. If a request body is specified, the Content-Type header is specifiable. If a request body is not specified, this header is ignored even if specified. | application/json Default value: application/json |
| Content-Length | Optional | Specifies the size of the request body. You can specify the Content-Length header when specifying a request body. This header is automatically assigned depending on the specifications of the client software. | Specify the header, in bytes. Default value: None |

| Header | Category | Description | Specifiable value |
|---------------|----------|--|---|
| Authorization | Required | <p>Specifies the authorization method and authorization credentials.</p> <p>You do not need to specify this header for the API function that gets version information or for the API function that gets a list of storage systems.</p> <p>When using the REST API, use different authorization methods appropriately, as shown below.</p> <ul style="list-style-type: none"> ▪ For session generation: Authorization is based on the user ID and password. ▪ For operations other than the above: Authorization is based on the session. | <p>Specify the header in one of the following formats. Specify the appropriate authentication method depending on the API.</p> <ul style="list-style-type: none"> ▪ Authentication based on the user ID and password <ul style="list-style-type: none"> <code>Basic authorization-credentials</code> <p>For the authorization credentials, specify the user ID and password in a character string encoded by using Base64. Use the user ID and password of a user account that can perform operations on storage system resources.</p> ▪ Authentication based on the session <ul style="list-style-type: none"> <code>Session token</code> <p>When the session was generated:</p> <p>Specify a token that was obtained when the session was generated.</p> <p>Default value: None</p> |

| Header | Category | Description | Specifiable value |
|--------------------------|--|--|---|
| Remote- Authorization | Required (for the API for the object types on the right) | <p>Specifies the authorization credentials to be used when accessing the remote storage system. This header is used in the API for the following object types:</p> <ul style="list-style-type: none"> ▪ remote-mirror-copygroups ▪ remote-mirror-copypairs ▪ remote-storages | <p>Specify the header in the following format:</p> <pre>Session token</pre> <p>Specify the token for the session that was generated in the remote storage system.#</p> <p>Default value: None</p> |
| Response-Max-Wait | Optional | <p>Specifies the maximum wait time until a response is returned when an API request for asynchronous processing is issued. A response is returned when the specified time elapses after the REST API server accepted the API request.</p> <p>If the processing finishes before the maximum wait time elapses, a response is returned at the time of completion.</p> <p>Factors such as network status and load of the REST API server can delay acceptance of a response, so the wait time might be longer than the specified maximum time. Take these factors into account when specifying the maximum wait time.</p> | <p>Integers between 0 and 1800</p> <p>Unit: Seconds</p> <p>Default value: None</p> |

| Header | Category | Description | Specifiable value |
|------------------------------------|----------|--|---|
| Response-Job-Status | Optional | Specifies the status of the job that is expected to return a response when an API request for asynchronous processing is issued. A response is returned when the job transits to the specified status or when the processing stops due to an error. | Specify the header in one of the following formats: <i>job-status;</i> or <i>job-status; Job-State=state-of-the-job</i> Default value: None |
| Job-Mode-Wait-Configuration-Change | Optional | Specifies when the job status is to be changed to <code>Completed</code> when an API request for asynchronous processing is issued in pair operations. Use this header for the API functions that meet the following conditions. <ul style="list-style-type: none"> ▪ The object type is one of the following: <ul style="list-style-type: none"> • <code>local-clone-copygroups</code> • <code>local-clone-copypairs</code> • <code>remote-mirror-copygroups</code> • <code>remote-mirror-copypairs</code> ▪ The HTTP method is either of the following: <ul style="list-style-type: none"> • <code>POST</code> • <code>PATCH</code> | Specify either of the following values: <ul style="list-style-type: none"> ▪ <code>Wait</code>: Wait for data copying to finish, and then change the job status to <code>Completed</code>. ▪ <code>NoWait</code>: Change the job status to <code>Completed</code> without waiting for data copying to finish. <p>If you specify <code>NoWait</code>, data copying continues even after the job status changes to <code>Completed</code>. To check whether data copying has finished, check the status of the target resource.</p> <p>Default value: <code>Wait</code></p> |

#: Specify at least 60 seconds for the timeout time of a session generated on the remote storage system. If you specify less than 60 seconds, the session on the remote storage system might time out, causing the execution of a request to fail.

If a header other than the above is specified, the specified header is ignored.

Response-Max-Wait and Response-Job-Status can be specified in combination. If both are specified, a response is returned when either condition is satisfied.

If neither Response-Max-Wait nor Response-Job-Status is specified, a response is returned immediately.

Response headers

This section describes the response headers returned by the REST API server.

| Header | Description | Default |
|-------------------|--|--|
| Content-Type | Indicates the media type of the response data. | <code>application/json; charset=UTF-8</code> |
| Content-Length | Indicates the size of the response data. If the size of the response data is large, instead of this header, <code>Transfer-Encoding: chunked</code> is returned, indicating that the response data has been divided and then transferred. | None |
| Transfer-Encoding | Indicates the encoding format used when the response data was transferred. When a large amount of response data is divided and then transferred, <code>chunked</code> is returned. | None |
| WWW-Authenticate | Indicates that authentication is required when the HTTP status code 401 is returned. | <ul style="list-style-type: none"> ▪ When a session is created: <code>Basic realm="Block storage"</code> ▪ For other cases: <code>Session realm="Block storage"</code> |

HTTP status codes

The REST API uses the following standard HTTP status codes to indicate the processing results.

| Status codes | Description |
|--------------|---|
| 200 | <p>Success</p> <p>The request has been processed properly. Even if the number of results obtained is 0 in a request to get information, this status code will be returned.</p> |
| 202 | <p>Accepted</p> <p>The request for asynchronous processing has been accepted.</p> |
| 400 | <p>Bad request</p> <p>The request header, the query parameter, or the request body is invalid.</p> |
| 401 | <p>Unauthorized</p> <p>The Authorization header is not specified in the request header. Alternatively, authentication using the information specified in the Authorization header has failed.</p> |
| 403 | <p>Forbidden</p> <p>You do not have the permission required to perform the operation.</p> |
| 404 | <p>Not found</p> <p>The resource specified by the URL is not found. Alternatively, you do not have read permission for the resource.</p> |
| 405 | <p>Method not allowed</p> <p>The specified method is not allowed for the resource specified by the URL.</p> |
| 406 | <p>Not acceptable</p> <p>The media type specified in the Accept header is not supported.</p> |
| 409 | <p>Conflict</p> <p>A request is made to change the status of the resource specified by the URL, in a way that the change might cause conflicts or be impossible.</p> <p>Example: A request is made to create one resource that has the same ID as another resource that has already been created.</p> |
| 411 | <p>Length Required</p> <p>The Content-Length header must be specified.</p> |
| 412 | <p>Precondition failed</p> <p>The conditions for running the API request are not met.</p> |
| 415 | <p>Unsupported media type</p> <p>The media type specified in the Content-Type header is not supported.</p> |

| Status codes | Description |
|--------------|--|
| 417 | <p>Expectation Failed</p> <p>The specified Expect header is invalid, or the Expect header is not supported by the web server (For VSP E series, VSP G350, G370, G700, G900, VSP F350, F370, F700, F900).</p> |
| 500 | <p>Server error</p> <p>An internal error has occurred in the REST API server or the storage system that is the operation target.</p> |
| 502 | <p>Proxy Error</p> <p>There is no response from the REST API server.</p> |
| 503 | <p>Service unavailable</p> <p>The request cannot be accepted, because the REST API server or the storage system is busy.</p> <p>If this status code is returned, run the request again.</p> |

API-specific information about status codes is explained in the sections on the specific APIs.

Request and response formats

Use the JSON format to specify attribute values when creating or changing a resource. Also, use the JSON format for the results of resource information acquisition.

When creating or adding a resource by using the POST method, or when changing or editing a resource by using the PATCH method, specify resource attributes in JSON format. When you use the GET method to collect resource information, responses are returned in JSON format.

The supported character encoding is UTF-8.

Request format

- If you specified a null character for a string-type attribute, the value of the attribute is assumed to be null.
- If you specified a null character for an attribute whose type is not string, the attribute is assumed to be unspecified.

- You can use the following characters in attribute values:

Uppercase letters (A-Z), lowercase letters (a-z), numbers (0-9), commas (,), hyphens (-), periods (.), colons (:), at marks (@), and underscores (_)

Allowable characters vary for each API request. For details, refer to individual API command pages.



Note:

- If you specified a character string containing a comma, a colon, or an at mark, you must encode the symbol when generating the object ID. We recommend that you do not use these symbols. If you generate the object ID without encoding these symbols, the URL when an API request is issued might be incorrect and cause an error.
- You cannot specify a hyphen as the first character of the value.

- Do not include backslashes (\) or forward slashes (/) in URLs.
- If you specify an IP address, you cannot use an IPv4-mapped address.

Response format

- If the API processing succeeds, a response is returned in JSON format.
- If the processing fails, depending on the contents of the error, a response in HTML format, instead of JSON format, might be returned.

To resolve the error based on the HTTP status code in the program, check the value of Content-Type in the response header.

**Tip:**

The following example is used to describe how to read the error message that appears if the string specified in the request body contains a syntax error.

Request body:

```
{
  "parameters": {
    "status": blk
  }
}
```

Error message:

```
{
  "errorSource": "/ConfigurationManager/v1/objects/ldevs/5/
actions/change-status/invoke",
  "message": "The format of the string or the content specified
in the request body is invalid. (details = Unexpected character
('b' (code 98)): expected a valid value (number, String, array,
object, 'true', 'false' or 'null')\n at [Source:
java.io.ByteArrayInputStream@10f607b; line: 3, column: 16])",
  "solution": "Check and, if necessary, revise the specified
request body so that the format and content are correct.",
  "messageId": "KART40046-E"
}
```

The location where the error occurred is output after `at` in the message details.

This example indicates the error is in `line: 3, column: 16`.

In column 16 of line 3 in the request body, you can see that the `status` attribute, which should be specified as a string, is specified incorrectly.

Query parameters

If the GET method is used to obtain an object, query parameters can be specified to filter the execution results based on specific conditions.

Query parameters can be specified at the end of the URL in the following format:

```
?parameter=value
```

To specify multiple parameters, concatenate them by using ampersands (&). Multiple parameters are specified in the following example:

```
?parameter=value&parameter=value...
```

For details on parameters that can be specified for queries, see the section describing the specific API request.

Parameters are case sensitive. If you specify a parameter other than those that can be specified for each API, the invalid parameter is ignored, and only the valid parameters are used to filter the execution results.

If a parameter value contains a reserved character defined in RFC 3986, specify an encoded character string. For details about the reserved characters defined in RFC 3986, see the section describing how to specify an object ID.

If you specify an IP address for a parameter value, you cannot use an IPv4-mapped address.



Note:

When you obtain an object by specifying query parameters, if the storage management software or another REST API client is performing a configuration-change operation on the object, you might not be able to obtain the correct information. To obtain the correct information, be sure to obtain a lock before obtaining the object.

Data type

This section describes the data types that can be specified by using the REST API.

The following table shows the data types supported by the REST API and the corresponding JSON data types.

| Data type | JSON type | Description |
|---------------|-----------|---|
| boolean | boolean | A type that represents <code>true</code> or <code>false</code> . Example : <code>true</code> |
| int | number | A type that represents a 32-bit signed integer. Example : <code>100</code> |
| long | number | A type that represents a 64-bit signed integer. Example : <code>1048576</code> |
| string | string | A type that represents a character string. Example : <code>"host_group_1"</code> |
| ISO8601string | string | A type that represents time in the ISO 8601 extended format (YYYY-MM-DDThh:mm:ssZ). The only time zone that you can specify is UTC. Example : <code>"2015-03-20T09:27:35Z"</code> |
| link | string | A type that represents the path of a URL. |

| Data type | JSON type | Description |
|-----------|-----------|---|
| | | <p>The link type indicates a URL for a resource. For example, when a request for asynchronous processing is issued, a URL for the job object is returned by using the link type.</p> <p>The link type data is a character string of the URL from which the protocol, host name, and port number are excluded. If the URL is created based on the link type data, you must add the protocol, host name, and port number.</p> <p>Example :</p> <pre data-bbox="639 625 1284 657">"/ConfigurationManager/v1/objects/ldevs/100"</pre> |

In addition to the preceding data types, the following JSON data types are also used:

- The object type

The character string, in which the attribute and value are connected with a colon (:), is enclosed in { and }. If more than one attribute-value pair exists, the pairs are separated by commas.

- The array type

The character string, in which multiple values are separated by commas, is enclosed in [and].

Output format

After an API request is issued, a response is returned based on the API processing method, the API processing type, and the execution result.

The following table shows the response output formats when the processing of the request is successful.

| API processing method | API processing type | Status code of the execution result | Output format |
|-------------------------|----------------------------------|-------------------------------------|--|
| Synchronous processing | GET (getting a single object) | 200 | See the description in the response message for each API function. |
| | GET (getting multiple objects) | 200 | Data object |
| | GET (getting an action template) | 200 | Action template object |
| | Other than the preceding | 200 | See the description in the response message for each API function. |
| Asynchronous processing | All | 202 | Job object |

If the processing of the request fails, an error object is returned as a response.

Data object

Data object is an object for returning the object list.

The following table shows the data object schema.

| Attribute | Data type | Description |
|-----------|-----------|-------------|
| data | array | Object list |

The following shows an example of a data object:

```
{
  "data": [
    {
      "parityGroupId": "5-2",
      "numOfLdevs": 3,
      "usedCapacityRate": 45,
      "availableVolumeCapacity": 4000,
      "raidLevel": "RAID5",
      "raidType": "2D+2D",
    }
  ]
}
```

```

        "clprId":0,
        "driveType":"DKR5C-J600SS"
    },
    {
        "parityGroupType",
        ...
    },
    ...
]
}

```

Job object

A job object represents job information that is returned when an API request for asynchronous processing is issued.

The following table explains the schema of a job object.

| Attribute | Data type | Description |
|-----------|-----------|--|
| jobId | long | Job object ID. |
| self | link | URL used to access the job information. |
| userId | string | ID of the user who issued the API request that triggered registration of the job. |
| status | string | <p>Status of the job.</p> <p>The following values can be returned:</p> <ul style="list-style-type: none"> ▪ <code>Initializing</code>: The job is being initialized. ▪ <code>Running</code>: The job is running. ▪ <code>Completed</code>: Execution of the job is finished. |
| state | string | <p>State of the job.</p> <p>The following values can be returned:</p> <ul style="list-style-type: none"> ▪ <code>Queued</code>: The job has been queued. ▪ <code>Started</code>: The job has been started. ▪ <code>StorageAccepted</code>: The request was received by the storage system#. ▪ <code>Succeeded</code>: The job finished successfully. |

| Attribute | Data type | Description |
|-------------------|----------------|---|
| | | <ul style="list-style-type: none"> Failed: The job failed. Unknown: The state of the job is unknown. |
| createdTime | ISO8601string | Time when the job was created. |
| updatedAt | ISO8601string | Time when the state of the job was updated. |
| completedTime | ISO8601string | Time when the job ended. |
| request | Request Object | Object that retains information about the request. |
| affectedResources | link[] | <p>URL used to access the resource targeted by the operation.</p> <p>If one API request performs operations on multiple resources, the URLs of all those resources are returned. If a job failed, only the URLs of the resources for which processing is confirmed to have been completed are returned.</p> <p>If the resource is deleted successfully, the URL of the deleted resource is returned. A 404 error occurs if this URL is accessed. This confirms that the resource has been deleted successfully.</p> <p>The attribute affectedResources is also included in the API response that obtains job information. In this case, the URL used to access the resource targeted by the API command that triggered registration of the job is returned.</p> |
| error | Error Object | Object that retains error information. |

#: The state `StorageAccepted` is returned only for a job that creates a remote copy pair.



Note:

The maximum number of instances of job information that can be retained is as follows. If the number of instances of job information exceeds the maximum, the instances of the oldest "createdTime" are deleted first.

- For VSP E series, VSP G350, G370, G700, G900, VSP F350, F370, F700, F900: 3,000
- For VSP 5000 series: 100,000

Example of a job object when the job execution starts:

```
{
  "jobId": 111111,
  "self": "/ConfigurationManager/v1/objects/jobs/111111",
```

```

"userId": "user1",
"status": "Running",
"state": "Started",
"createdTime": "2015-04-01T08:00:00Z",
"updatedAt": "2015-04-01T08:05:00Z",
"request": {
  "requestUrl": "/ConfigurationManager/v1/objects/ldevs",
  "requestMethod": "POST",
  "requestBody": "{\"ldevId\" : 112, \"poolId\" : 100, \"blockCapacity
\" : 1000}"
}
}

```

Example of a job object when the job is finished successfully:

```

{
  "jobId": 222222,
  "self": "/ConfigurationManager/v1/objects/jobs/222222",
  "userId": "user1",
  "status": "Completed",
  "state": "Succeeded",
  "createdTime": "2015-04-01T08:00:00Z",
  "updatedAt": "2015-04-01T08:10:00Z",
  "completedTime": "2015-04-01T08:10:00Z",
  "request": {
    "requestUrl": "/ConfigurationManager/v1/objects/ldevs",
    "requestMethod": "POST",
    "requestBody": "{\"ldevId\" : 112, \"poolId\" : 100, \"blockCapacity
\" : 1000}"
  },
  "affectedResources": [
    "/ConfigurationManager/v1/objects/ldevs/112"
  ]
}

```

Example of a job object when the job failed:

```

{
  "jobId": 333333,
  "self": "/ConfigurationManager/v1/objects/jobs/333333",
  "userId": "user1",
  "status": "Completed",
  "state": "Failed",
  "createdTime": "2015-04-01T07:00:00Z",
  "updatedAt": "2015-04-01T07:01:00Z",
  "completedTime": "2015-04-01T07:01:00Z",
  "request": {
    "requestUrl": "/ConfigurationManager/v1/objects/ldevs",
    "requestMethod": "POST",
    "requestBody": "{\"ldevId\" : 112, \"poolId\" : 100, \"blockCapacity
"

```

```

\" : 1000}"
  },
  "error": {
    "errorSource": "/ConfigurationManager/v1/objects/ldevs",
    "messageId": "KART30000-E",
    "message": "An error occurred in the storage system. (message = The
state of the pool is incorrect.)",
    "cause": "An error occurred during execution of a CCI command.",
    "solution": "See the manual of the CCI and remove the cause of the
error.",
    "solutionType": "SEE_ERROR_DETAIL",
    "errorCode": {
      "SSB1": "2E10",
      "SSB2": "6014"
    },
    "detailCode": "30000E-2-2E10-6014"
  }
}

```

Error object

An error object represents error information that is returned when the request processing fails.

If the API processing fails, an error object is returned as response data. The following explains the schema of an error object.

| Attribute | Data type | Description |
|--------------|-----------|---|
| errorSource | link | URL where the error occurs |
| messageId# | string | Message ID |
| message | string | Content of the error message |
| cause | string | Cause of the error |
| solution | string | Solution to the error |
| solutionType | string | Category of the solution to the error <ul style="list-style-type: none"> ▪ <code>RETRY</code>: Error that can be resolved by retrying the request ▪ <code>SEE_ERROR_DETAIL</code>: Error that must be resolved by taking the action described in the error message If <code>RETRY</code> is returned as the value of this attribute, retry the request that failed. |

| Attribute | Data type | Description |
|-------------------------|-----------|--|
| | | You can check the details of the request by checking the value of <code>request</code> of the job object. |
| <code>errorCode</code> | object | <p>Error code from the storage system</p> <p>A value is returned only if an error occurs in the storage system and thus one of the following error codes is issued.</p> <ul style="list-style-type: none"> ▪ The SSB1 code and SSB2 code of CCI ▪ An error code of CCI <p>Storage system error codes are required for maintenance of the storage system.</p> |
| <code>detailCode</code> | string | <p>Detailed information about the error</p> <p>The information is displayed in the following format:</p> <p><i>nnnnnZ-TYPEoutput-format-for-each-TYPE</i></p> |

| Attribute | Data type | Description |
|-----------|-----------|--|
| | | <p>Example:</p> <p>40097E-1-30000E-2-2EDA-00EE</p> <ul style="list-style-type: none"> ▪ <i>nnnnnZ</i> Displays the message ID of the REST API. <ul style="list-style-type: none"> • <i>nnnnn</i> Serial number of the message • <i>Z</i> Message type I : Information W : Warning E : Error ▪ <i>TYPE</i> Displays the type of the error. <ul style="list-style-type: none"> • 0: An error that occurred on the REST API server side • 1: An error that occurred on the REST API server on the remote storage system side (for remote copy) • Other than the preceding: An error that occurred on the storage system side |

| Attribute | Data type | Description |
|-----------|-----------|--|
| | | <ul style="list-style-type: none"> ▪ <i>output-format-for-each-TYPE</i> The output format varies depending on the value of <i>TYPE</i>. <ul style="list-style-type: none"> • When the value is 0: No information is output. • When the value is 1: The value of the <code>detailCode</code> attribute for the REST API server on the remote storage system side is displayed. • When the value is 2: Information about the CCI error is displayed in the following format: <i>- SSB1-code- SSB2-code</i> For details, see the CCI manual. • When the value is 3: An error code of CCI is displayed. For details, see the CCI manual. • When the value is 4: Information about an error that occurs in the GUM is displayed in the following format: <i>- part-code- error-code</i> For details, see the manual Hitachi Device Manager - Storage Navigator Messages. • When the value is 5: Information about an error that occurs in the SVP is displayed in the following format: <i>- part-code- error-code</i> For details, see the manual Hitachi Device Manager - Storage Navigator Messages. |

#: The name of the attribute is sometimes returned as the `messageID`.

Example of an error object that might be returned if an error occurs in the REST API server:

```
{
  "errorSource": "/ConfigurationManager/v1/objects/ldevs",
  "messageId": "KART20008-E",
  "message": "Required parameters are not specified.",
  "solution": "Check parameters.",
  "solutionType": "SEE_ERROR_DETAIL",
  "detailCode": "20008E-0"
}
```

Example of an error object that might be returned if an error occurs in the storage system:

```
{
  "errorSource": "/ConfigurationManager/v1/objects/ldevs/16",
  "messageId": "KART30000-E",
  "message": "An error occurred in the storage system. (message = The state of the pool is incorrect.)",
  "cause": "An error occurred during execution of a CCI command.",
  "solution": "See the manual of the CCI and remove the cause of the error.",
  "solutionType": "SEE_ERROR_DETAIL",
  "errorCode": {
    "SSB1": "2E10",
    "SSB2": "6014"
  },
  "detailCode": "30000E-2-2E10-6014"
}
```

The following shows an output example of the `detailCode` attribute:

If an error occurs on the REST API server (message ID: KART40231-E)

```
"detailCode": "40231E-0"
```

If an error occurs on the REST API server on the remote storage system side (message ID: KART40097-E, value of the `detailCode` attribute for the REST API server on the remote storage system side: 30000E-2-2EDA-00EE)

```
"detailCode": "40097E-1-30000E-2-2EDA-00EE"
```

If an error occurs on the storage system side (message ID: KART30000-E, SSB1 code: 2EDA, SSB2 code: 00EE)

```
"detailCode": "30000E-2-2EDA-00EE"
```

If an error occurs on the storage system side (message ID: KART30000-E, CCI error code: EX_INVARG)

```
"detailCode": "30000E-3-EX_INVARG"
```

If an error occurs on the storage system side (message ID: KART30007-E, part code: 30762, error code: 204092)

```
"detailCode": "30007E-4-30762-204092"
```

If an error occurs on the storage system side (message ID: KART30005-E, part code: 03005, error code: 078040)

```
"detailCode": "30005E-5-03005-078040"
```

Request object

Request objects are objects for retaining request information.

The following explains the schema of a request object.

| Attribute | Data type | Description |
|---------------|-----------|--|
| requestUrl | link | URL requested by the API for asynchronous processing. If the character string of the URL exceeds 2,048 bytes, the character string will be truncated. |
| requestMethod | string | HTTP method requested by the API for asynchronous processing. |
| requestBody | string | Request body requested by the API for asynchronous processing. If the character string of the request body exceeds 1,024 bytes, the character string will be truncated. |

Action template object

An action template object is a template of request bodies that are required to run actions. Get action template objects by using the GET method. Specify values in the template according to the action that you want to run. Specify the request body, and then run the action.

The following table shows the schema of the action template object.

| Attribute | Data type | Description |
|------------|-----------|---------------------------------------|
| parameters | object | Parameters required for the operation |

The following shows the action template for expanding the volume capacity, as an example of an action template object:

```
{
  "parameters": {
    "additionalBlockCapacity": null
  }
}
```

In an action template, the attributes that must be specified to run an action are written beforehand. For the values, `null` or `[]` is set to indicate that the values are unspecified. Specify a value for these attributes. In the preceding example, the two attributes used to specify the amount of the capacity to be added to a volume are written.

In the following example, values are specified in the collected action template:

```
{
  "parameters": {
    "additionalBlockCapacity": 500
  }
}
```

In the request body, specify an action template in which unnecessary attribute lines have been deleted and attribute values have been set for the remaining necessary attribute lines, and then run the action.

Locking resources

If multiple REST API clients simultaneously attempt to perform operations on the same resource, unexpected configuration changes might be performed, with results other than those anticipated. In the REST API, the user can lock the resource group allocated to them so that other users cannot change the configurations of resources in the locked resource group.

The REST API controls locks on a session basis. All resources of the resource group allocated to the user who generated a session are locked. When the resource group allocated to you is locked by another user, you cannot obtain a lock for the resource group.

Only the session used for the request that locked a resource can run a configuration-change request for the locked resource. If one user account generated multiple sessions, a configuration-change request cannot be run if the specified session is different from the session used to lock the resource. (If the specified session is different, even if it is generated by the same user account, the session cannot run the configuration-change request.)

However, operations that do not change the configurations of the resources on the storage system, such as a change of a pair status and operations for the REST API server, can be run without being affected by exclusive control by locking. The following operations are not affected by locking:

- Generating or discarding a session
- Getting information

Note that, when you obtain information by specifying query parameters, you might not be able to obtain the correct information because the operation might be affected by configuration-change operations performed by other REST API clients or by the storage management software. To obtain the correct information, be sure to lock the relevant resources before performing the operation.

- Sending the ping command to a specified host
- Setting the priority levels of ALUA paths
- Splitting, resynchronizing, or restoring ShadowImage pairs (for each copy pair or in units of copy groups)
- Splitting, resynchronizing, or restoring Thin Image pairs (for each snapshot or in units of snapshot groups)

Creating, deleting, assigning secondary volumes to, or unassigning secondary volumes from Thin Image pairs (including operations in units of snapshot trees)

- Registering or deleting remote storage system information on the REST API server
- Splitting, resynchronizing, or taking over TrueCopy pairs or Universal Replicator pairs (for each copy pair, or in units of copy groups)
- Operations related to information about an iSCSI target of a port on an external storage system (obtaining information, performing a login test)
- Uploading the files required for initial configuration
- Updating the cache of storage system configuration information

When a single user account uses multiple sessions, only one of the sessions can be used to lock resources.

When operations are complete and the resources no longer need to be locked, run the API command for unlocking the resource group. If the session used for locking is discarded, the locked resource group will be unlocked at the same time. If the session is discarded due to a session timeout, the locked resource group will also be unlocked at the same time.

**Tip:**

- A session timeout occurs even when an asynchronous processing API operation is being run. If you want to continue to lock the resources while an asynchronous processing API operation is being run, prevent a session timeout by taking a measure, such as periodically issuing the request that checks the job status.
- If you want to forcibly unlock resources because a REST API client unexpectedly continues to lock the resources or the token is lost, either wait until the session times out or forcibly discard the session by using a user who belongs to the Administrator user group (built-in user group) .
- If the locked user information (such as the role and resource group) is changed while the resource is being locked, the changes are applied to operations after the resource is unlocked.

Operation flow for running API requests by using the lock functionality

The following table describes the operation flow for running API requests by locking resource groups.

| Step | Operation | Item to be specified for the Authorization header |
|------|--|---|
| 1 | Generate a session. | User ID and password |
| 2 | Lock the resource group. | The token of the session generated in step 1 |
| 3 | Perform operations on the locked resource. | The token of the session generated in step 1 |
| 4 | Unlock the resource group. | The token of the session generated in step 1 |
| 5 | Discard the session. | The token of the session generated in step 1 |

Operation flow for running API requests by using the lock functionality (for remote copy)

For copy operations between storage systems (remote copy), to perform operations to change configurations of a copy group or the resources in a copy group by locking the target resources, lock the resources of both the local and remote storage systems. To lock the both resources and perform operations on the locked resources, specify the token of the session of each storage system for the Authorization header and the Remote-Authorization header. Note that the Remote-Authorization header is used only for the API commands that are used for the following object types:

- remote-mirror-copygroups
- remote-mirror-copypairs
- remote-storages

The following table describes the operation flow for when the resources of both the local and remote storage systems are locked.

| Step | Storage system on which operations are performed | Operation | Item to be specified for the Authorization header |
|------|--|--|--|
| 1 | Local storage system | Generate a session. | User ID and password for the local storage system |
| 2 | Remote storage system | Generate a session. Specify at least 60 seconds for the timeout time of a session generated on the remote storage system. | User ID and password for the remote storage system |
| 3 | Local storage system | Lock the resource group. | The token of the session generated in step 1 |
| 4 | Remote storage system | Lock the resource group. | The token of the session generated in step 2 |
| 5 | Local storage system | Perform operations on a copy group or the resources in a copy group. | The token of the session generated in step 1 |

| Step | Storage system on which operations are performed | Operation | Item to be specified for the Authorization header |
|------|--|----------------------------|---|
| | | | Also, specify the token of the session generated in step 2 for the Remote-Authorization header. |
| 6 | Local storage system | Unlock the resource group. | The token of the session generated in step 1 |
| 7 | Remote storage system | Unlock the resource group. | The token of the session generated in step 2 |
| 8 | Local storage system | Discard the session. | The token of the session generated in step 1 |
| 9 | Remote storage system | Discard the session. | The token of the session generated in step 2 |

**Tip:**

If creation of a remote copy pair is run, the initial copy processing for creating a pair on the storage system might take a long time. In this case, if resources are locked until the pair is created, other clients cannot use the resources of the resource group for a long time. Resources do not need to be locked by the REST API after the storage system accepts the request that creates a pair. Therefore, when you create a remote pair, we recommend that you unlock the resources after the job status is changed to "StorageAccepted".

Chapter 2: Common operations in the REST API

This chapter describes the common operations in the REST API, such as how to get information about jobs and generate sessions.

Getting the version information

The following request gets information about the version of the REST API.

Execution permission

No role is required to run this API request.

Request headers

This API request does not require authorization. Therefore, the Authorization header does not need to be specified.

Request line

```
GET base-URL/configuration/version
```

Request message

Object ID

None.

Query parameters

None.

Body

None.

Response message

Body

```
{
  "productName": "Configuration Manager REST API",
  "apiVersion": "1.26.0"
}
```

| Attribute | Type | Description |
|-------------|--------|-------------------------|
| productName | string | Name of the REST API |
| apiVersion | string | Version of the REST API |

Status codes

For details on the status codes of the API, see the description on HTTP status codes.

Coding example

```
curl -v -H "Accept:application/json" -H "Content-Type:application/json" -X
GET https://192.0.2.100/ConfigurationManager/configuration/version
```

Getting a list of storage systems

The following request gets a list of the storage systems that can be operated from the REST API. You can check information about storage systems, such as the storage device ID and the serial number of the storage system.

Execution permission

No role is required to run this API request.

Request headers

This API request does not require authorization. Therefore, the Authorization header does not need to be specified.

Request line

```
GET base-URL/v1/objects/storages
```

Request message**Object ID**

None.

Query parameters

None.

Body

None.

Response message**Body**

```
{
  "data": [
    {
      "storageDeviceId": "886000123456",
      "model": "VSP G700",
      "serialNumber": 123456,
      "ctl1Ip": "192.0.2.100",
      "ctl2Ip": "192.0.2.101"
    }
  ]
}
```

| Attribute | Type | Description |
|-----------------|--------|---|
| storageDeviceId | string | Storage device ID |
| model | string | Model name of the storage system |
| serialNumber | int | Serial number of the storage system |
| svplp | string | IP address of the SVP that manages the storage system This attribute is displayed for storage systems VSP 5000 series. |
| ctl1Ip | string | IP address of controller 1 of the storage system This attribute is displayed for storage systems VSP E series, VSP G350, G370, G700, G900, VSP F350, F370, F700, F900. |
| ctl2Ip | string | IP address of controller 2 of the storage system This attribute is displayed for storage systems VSP E series, VSP G350, G370, G700, G900, VSP F350, F370, F700, F900. |

Status codes

For details on the status codes of the request for this operation, see the description on HTTP status codes.

Coding example

```
curl -v -H "Accept:application/json" -X GET https://192.0.2.100/
ConfigurationManager/v1/objects/storages
```

Getting information about a specific storage system

The following request gets information about the storage system for which an operation is to be performed.

Execution permission

Storage Administrator (View Only)

Request line

```
GET base-URL/v1/objects/storages/instance
```

Request message**Object ID**

Specify a value for *instance*. For objects that have only one instance, the value of *instance* is a fixed value (the object ID).

Query parameters

| Attribute | Type | Filter Condition |
|----------------|--------|---|
| detailInfoType | string | (Optional) Type of detailed information to be obtained <ul style="list-style-type: none"> ▪ version Additional detailed information about the microcode of the storage system, controller 1, and controller 2 is obtained. |

Body

None.

Response message**Body**

```
{
  "storageDeviceId" : "886000123456",
  "model" : "VSP G700",
  "serialNumber" : 123456,
```

```

"ctl1Ip": "192.0.10.10",
"ctl2Ip": "192.0.10.11",
"dkcMicroVersion" : "88-01-01/00",
"communicationModes": [
  {
    "communicationMode": "lanConnectionMode"
  }
],
"isSecure": true
}

```

| Attribute | Type | Description |
|--------------------|----------|---|
| storageDeviceId | string | Storage device ID |
| model | string | Model name of the storage system |
| serialNumber | int | Serial number of the storage system |
| svplp | string | IP address of the SVP This attribute is displayed for storage systems VSP 5000 series |
| ctl1Ip | string | IP address of controller 1 of the storage system This attribute is displayed for storage systems VSP E series, VSP G350, G370, G700, G900, VSP F350, F370, F700, F900 |
| ctl2Ip | string | IP address of controller 2 of the storage system This attribute is displayed for storage systems VSP E series, VSP G350, G370, G700, G900, VSP F350, F370, F700, F900 |
| dkcMicroVersion | string | Microcode version of the storage system |
| communicationModes | object[] | Array of communication modes The following attributes are output for the communication modes between the REST API server and the storage system: <ul style="list-style-type: none"> communicationMode (string) Communication mode lanConnectionMode is displayed. |
| isSecure | boolean | Whether the communication between the REST API server and the storage system is secure. |

| Attribute | Type | Description |
|-----------|------|--|
| | | The default value is <code>true</code> . |

You can obtain detailed information about the microcode of the storage system by executing the request with `version` specified for the `detailInfoType` query parameter.

```
{
  "storageDeviceId": "886000123456",
  "model": "VSP G900",
  "serialNumber": 123456,
  "ctl1Ip" : "192.0.10.10",
  "ctl2Ip" : "192.0.10.11",
  "dkcMicroVersion": "88-01-01/82",
  "detailDkcMicroVersion": "88-01-01-60/82",
  "ctl1MicroVersion" : "88-01-01/81",
  "ctl2MicroVersion" : "88-01-01/81",
  "communicationModes": [
    {
      "communicationMode": "lanConnectionMode"
    }
  ],
  "isSecure": true
}
```

| Attribute | Type | Description |
|------------------------------------|--------|---|
| <code>detailDkcMicroVersion</code> | string | Microcode version of the storage system Model identification information is included. |
| <code>ctl1MicroVersion</code> | string | GUM version of the controller 1 This attribute is displayed for storage systems VSP E series, VSP G350, G370, G700, G900, VSP F350, F370, F700, F900. If a failure has occurred in the GUM of controller 1, this information is not obtained. |
| <code>ctl2MicroVersion</code> | string | GUM version of the controller 2 This attribute is displayed for storage systems VSP E series, VSP G350, G370, G700, G900, VSP F350, F370, F700, F900. If a failure has occurred in the GUM of controller 2, this information is not obtained. |

Status codes

For details on the status codes of the request for this operation, see the description on HTTP status codes.

Coding example

```
curl -v -H "Accept:application/json" -H "Authorization:Session
d7b673af189048468c5af9bcf3bbbb6f" -X GET https://192.0.2.100/
ConfigurationManager/v1/objects/storages/instance
```

Getting summary information about storage systems

This request gets summary information about storage systems.

**Note:**

- You can use this API function for VSP 5000 series.
- To get up-to-date information, you must run the API request that refreshes the storage system's cache before running this request. For details, see "Updating the cache of storage system configuration information".

Execution permission

Storage Administrator (View Only)

Request line

```
GET base-URL/v1/objects/storage-summaries/instance
```

Request message**Object ID**

Specify a value for *instance*. For objects that have only one instance, the value of *instance* is a fixed value (the object ID).

Query parameters

| Parameter | Type | Description |
|----------------|--------|---|
| detailInfoType | string | (Optional) Type of detailed information to be obtained <ul style="list-style-type: none"> ▪ <i>parityGroupCapacity</i> Gets additional capacity information about parity groups. |

Body

None.

Response message**Body**

```

{
  "name" : "VSP 5500",
  "svpMicroVersion" : "90-01-40/02",
  "rmiServerVersion" : "10_00_05",
  "numOfDiskBoards" : 8,
  "cacheMemoryCapacity" : 169984,
  "numOfSpareDrives" : 0,
  "totalOpenVolumeCapacity" : 5487,
  "totalOpenVolumeCapacityInKB" : 5754301448,
  "allocatedOpenVolumeCapacity" : 1853,
  "allocatedOpenVolumeCapacityInKB" : 1943911065,
  "allocatableOpenVolumeCapacity" : 877,
  "allocatableOpenVolumeCapacityInKB" : 919741295,
  "unallocatedOpenVolumeCapacity" : 3633,
  "unallocatedOpenVolumeCapacityInKB" : 3810390383,
  "reservedOpenVolumeCapacity" : 2756,
  "reservedOpenVolumeCapacityInKB" : 2890649088,
  "allocatedOpenVolumePhysicalCapacity" : 760,
  "allocatedOpenVolumePhysicalCapacityInKB" : 797214657,
  "allocatableOpenVolumePhysicalCapacity" : 328,
  "allocatableOpenVolumePhysicalCapacityInKB" : 344242149,
  "reservedOpenVolumePhysicalCapacity" : 1745,
  "reservedOpenVolumePhysicalCapacityInKB" : 1829765120,
  "allocatedMainframeVolumeCapacity" : 10,
  "allocatedMainframeVolumeCapacityInKB" : 11397000,
  "reservedMainframeVolumeCapacity" : 9,
  "reservedMainframeVolumeCapacityInKB" : 9744000,
  "totalAllocatedVolumeCapacity" : 1864,
  "totalAllocatedVolumeCapacityInKB" : 1955308065,
  "totalUnallocatedVolumeCapacity" : 3643,
  "totalUnallocatedVolumeCapacityInKB" : 3820134383,
  "totalReservedVolumeCapacity" : 2766,
  "totalReservedVolumeCapacityInKB" : 2900393088,
  "totalMainframeVolumeCapacity" : 20,
  "totalMainframeVolumeCapacityInKB" : 21141000,
  "totalVolumeCapacity" : 5507,
  "totalVolumeCapacityInKB" : 5775442448,
  "numOfOpenVolumes" : 6502,
  "numOfAllocatedOpenVolumes" : 509,
  "numOfAllocatableOpenVolumes" : 5671,
  "numOfReservedOpenVolumes" : 322
}

```

In the descriptions in this table, the following volumes include internal volumes and external volumes:

- Open system volumes
- Mainframe volumes
- Intermediate volumes

| Attribute | Type | Description |
|---------------------------------|--------|--|
| name | string | Name of the storage system |
| svpMicroVersion | string | Microcode version of the SVP |
| rmiServerVersion | string | Version of the RMI server |
| numOfDiskBoards | int | Number of disk boards |
| cacheMemoryCapacity | long | Current cache capacity (MB) |
| numOfSpareDrives | int | Number of spare drives |
| totalOpenVolumeCapacity | long | The total capacity of the open system volumes (GB) This total capacity includes the capacity of DP volumes and other virtual volumes. |
| totalOpenVolumeCapacityInKB | long | The total capacity of the open system volumes (KB) This total capacity includes the capacity of DP volumes and other virtual volumes. |
| allocatedOpenVolumeCapacity | long | From among the open system volumes, the total capacity of volumes to which paths are allocated (GB) This total capacity includes the capacity of DP volumes and other virtual volumes. |
| allocatedOpenVolumeCapacityInKB | long | From among the open system volumes, the total capacity of volumes to which paths are allocated (KB) This total capacity includes the capacity of DP volumes and other virtual volumes. |
| allocatableOpenVolumeCapacity | long | From among the open system volumes, the total capacity of volumes to which paths can be allocated (GB) This total capacity includes the capacity of DP volumes and other virtual volumes. |

| Attribute | Type | Description |
|---|------|--|
| allocatableOpenVolumeCapacityInKB | long | From among the open system volumes, the total capacity of volumes to which paths can be allocated (KB) This total capacity includes the capacity of DP volumes and other virtual volumes. |
| unallocatedOpenVolumeCapacity | long | From among the open system volumes, the total capacity of volumes to which paths are not allocated (GB) This total capacity includes the capacity of DP volumes and other virtual volumes. |
| unallocatedOpenVolumeCapacityInKB | long | From among the open system volumes, the total capacity of volumes to which paths are not allocated (KB) This total capacity includes the capacity of DP volumes and other virtual volumes. |
| reservedOpenVolumeCapacity | long | From among the open system volumes, the total capacity of reserved volumes, pool volumes, and the S-VOLs of snapshots (GB) This total capacity includes the capacity of DP volumes and other virtual volumes. |
| reservedOpenVolumeCapacityInKB | long | From among the open system volumes, the total capacity of reserved volumes, pool volumes, and the S-VOLs of snapshots (KB) This total capacity includes the capacity of DP volumes and other virtual volumes. |
| allocatedOpenVolumePhysicalCapacity | long | From among the open system volumes, the total capacity of volumes to which paths are allocated (GB) This is the total capacity of physical volumes, excluding the capacity of DP volumes and other virtual volumes. |
| allocatedOpenVolumePhysicalCapacityInKB | long | From among the open system volumes, the total capacity of volumes to which paths are allocated (KB) This is the total capacity of physical volumes, excluding the capacity of DP volumes and other virtual volumes. |

| Attribute | Type | Description |
|---|------|--|
| allocatableOpenVolumePhysicalCapacity | long | From among the open system volumes, the total capacity of volumes to which paths can be allocated (GB) This is the total capacity of physical volumes, excluding the capacity of DP volumes and other virtual volumes. |
| allocatableOpenVolumePhysicalCapacityInKB | long | From among the open system volumes, the total capacity of volumes to which paths can be allocated (KB) This is the total capacity of physical volumes, excluding the capacity of DP volumes and other virtual volumes. |
| reservedOpenVolumePhysicalCapacity | long | From among the open system volumes, the total capacity of reserved volumes and pool volumes (GB) This is the total capacity of physical volumes, excluding the capacity of DP volumes and other virtual volumes. |
| reservedOpenVolumePhysicalCapacityInKB | long | From among the open system volumes, the total capacity of reserved volumes and pool volumes (KB) This is the total capacity of physical volumes, excluding the capacity of DP volumes and other virtual volumes. |
| numOfOpenVolumes | int | Total number of open system volumes |
| numOfAllocatedOpenVolumes | int | Total number of open system volumes to which paths are allocated |
| numOfAllocatableOpenVolumes | int | Total number of open system volumes to which paths are not allocated |
| numOfReservedOpenVolumes | int | From among the open system volumes, the total number of reserved volumes, pool volumes, and the S-VOLs of snapshots |
| allocatedMainframeVolumeCapacity | long | From among the mainframe volumes and intermediate volumes, the total capacity of normal volumes (excluding reserved volumes and pool volumes) (GB) This total capacity includes the capacity of DP volumes and other virtual volumes. |

| Attribute | Type | Description |
|--------------------------------------|------|--|
| allocatedMainframeVolumeCapacityInKB | long | <p>From among the mainframe volumes and intermediate volumes, the total capacity of normal volumes (excluding reserved volumes and pool volumes) (KB)</p> <p>This total capacity includes the capacity of DP volumes and other virtual volumes.</p> |
| reservedMainframeVolumeCapacity | long | <p>From among the mainframe volumes and intermediate volumes, the total capacity of reserved volumes, pool volumes, and the S-VOLs of snapshots (GB)</p> <p>This total capacity includes the capacity of DP volumes and other virtual volumes.</p> |
| reservedMainframeVolumeCapacityInKB | long | <p>From among the mainframe volumes and intermediate volumes, the total capacity of reserved volumes, pool volumes, and the S-VOLs of snapshots (KB)</p> <p>This total capacity includes the capacity of DP volumes and other virtual volumes.</p> |
| totalAllocatedVolumeCapacity | long | <p>Total capacity of the volumes (in GB) to which paths are allocated from among the open system volumes, and normal volumes (excluding reserved volumes and pool volumes) from among the mainframe volumes and intermediate volumes</p> <p>This total capacity includes the capacity of DP volumes and other virtual volumes.</p> |
| totalAllocatedVolumeCapacityInKB | long | <p>Total capacity of the volumes (in KB) to which paths are allocated from among the open system volumes, and normal volumes (excluding reserved volumes and pool volumes) from among the mainframe volumes and intermediate volumes</p> <p>This total capacity includes the capacity of DP volumes and other virtual volumes.</p> |
| totalUnallocatedVolumeCapacity | long | <p>Total capacity of the volumes (in GB) to which paths are not allocated from among the open system volumes, and the reserved volumes, pool volumes, and the S-VOLs of snapshots from among the mainframe volumes and intermediate volumes</p> |

| Attribute | Type | Description |
|------------------------------------|------|--|
| | | This total capacity includes the capacity of DP volumes and other virtual volumes. |
| totalUnallocatedVolumeCapacityInKB | long | Total capacity of the volumes (in KB) to which paths are not allocated from among the open system volumes, and the reserved volumes, pool volumes, and the S-VOLs of snapshots from among the mainframe volumes and intermediate volumes This total capacity includes the capacity of DP volumes and other virtual volumes. |
| totalReservedVolumeCapacity | long | Total number of reserved volumes, pool volumes, and the S-VOLs of snapshots (GB) |
| totalReservedVolumeCapacityInKB | long | Total number of reserved volumes, pool volumes, and the S-VOLs of snapshots (KB) |
| totalMainframeVolumeCapacity | long | Total capacity of the mainframe volumes and intermediate volumes (GB) |
| totalMainframeVolumeCapacityInKB | long | Total capacity of the mainframe volumes and intermediate volumes (KB) |
| totalVolumeCapacity | long | Total capacity of the open system volumes, mainframe volumes, and intermediate volumes (GB) |
| totalVolumeCapacityInKB | long | Total capacity of the open system volumes, mainframe volumes, and intermediate volumes (KB) |

If you run this request with `parityGroupCapacity` specified for the query parameter `detailInfoType`, capacity information about parity groups is also obtained.

| Attribute | Type | Description |
|---------------------------------------|------|---|
| totalAvailableParityGroupCapacity | long | Total free capacity of available parity groups and external parity groups (GB) |
| totalAvailableParityGroupCapacityInKB | long | Total free capacity of available parity groups and external parity groups (KB) |
| largestAvailableParityGroupCapacity | long | Free capacity of the parity group that has the largest available capacity or of external parity groups (KB) |

Status codes

For details on the status codes of the request for this operation, see the description on HTTP status codes.

Coding example

```
curl -v -H "Accept:application/json" -H "Content-Type:application/json" -H
"Authorization:Session d7b673af189048468c5af9bcf3bbbb6f" -X GET https://
192.0.2.100/ConfigurationManager/v1/objects/storage-summaries/instance?
detailInfoType=parityGroupCapacity
```

Getting a list of sessions

The following request gets a list of valid sessions on the REST API server. Only a user who belongs to the Administrator user group (built-in user group) can perform this operation.

Execution permission

Administrator user group (built-in user group)

Request line

```
GET base-URL/v1/objects/sessions
```

Request message**Object ID**

None.

Query parameters

None.

Body

None.

Response message**Body**

```
{
  "data": [
    {
      "sessionId": 8,
      "userId": "rest-user",
      "ipAddress": "192.0.2.100",
      "createdTime": "2015-09-14T01:02:24Z",
```



```

    "lastAccessedTime": "2015-09-14T01:02:24Z"
  },
  {
    "sessionId": 6,
    "userId": "api-user",
    "ipAddress": "192.0.2.100",
    "createdTime": "2015-09-14T00:59:58Z",
    "lastAccessedTime": "2015-09-14T00:59:58Z"
  },
  {
    "sessionId": 5,
    "userId": "admin-user",
    "ipAddress": "192.0.2.100",
    "createdTime": "2015-09-14T00:59:53Z",
    "lastAccessedTime": "2015-09-14T00:59:53Z"
  }
]
}

```

| Attribute | Type | Description |
|------------------|---------------|--|
| sessionId | int | Session ID |
| userId | string | User ID that was used to generate the session |
| ipAddress | string | IP address of the REST API client that was used to generate the session If the REST API client accesses the REST API server via another server, a character string consisting of the concatenated IP addresses of the client and of the server used to access the REST API server (the content of the X-Forwarded-For header received by the REST API server) will be output. |
| createdTime | ISO8601string | Time the session was generated |
| lastAccessedTime | ISO8601string | Time the session was last used |

Status codes

For details on the status codes of the request for this operation, see the description on HTTP status codes.

Coding example

```
curl -v -H "Accept:application/json" -H "Content-Type:application/json" -H
"Authorization:Session d7b673af189048468c5af9bcf3b6bb6f" -X GET https://
192.0.2.100/ConfigurationManager/v1/objects/sessions/
```

Getting information about a specific session

The following request gets information about a valid session on the REST API server by specifying a session ID. For the Authorization header of the request, specify the token of the session.

Execution permission

Storage Administrator (View Only)

Request line

```
GET base-URL/v1/objects/sessions/object-ID
```

Request message**Object ID**

Specify the value of `sessionId` that was obtained when the session was generated.

| Attribute | Type | Description |
|-----------|------|-----------------------|
| sessionId | int | (Required) Session ID |

Query parameters

None.

Body

None.

Response message**Body**

```
{
  "token": "97c13b8082444b36bc2103026205fa64",
  "sessionId": 9
}
```

| Attribute | Type | Description |
|-----------|--------|-------------|
| sessionId | int | Session ID |
| token | string | Token |

Status codes

For details on the status codes of the request for this operation, see the description on HTTP status codes.

Coding example

```
curl -v -H "Accept:application/json" -H "Content-Type:application/json" -H
"Authorization:Session d7b673af189048468c5af9bcf3bbbb6f" -X GET https://
192.0.2.100/ConfigurationManager/v1/objects/sessions/9
```

Generating sessions

The following request generates sessions and manages the sessions on the REST API server. A maximum of 64 sessions can be generated for each storage system. When the number of sessions exceeds the maximum number of sessions, the HTTP status code 503 is returned. In this case, wait a while and then run the request again.



Note: For remote copy, specify at least 60 seconds for the `aliveTime` attribute of the sessions generated on the remote storage system. If you specify less than 60 seconds, the session on the remote storage system might time out, causing the execution of a request to fail.

Execution permission

Storage Administrator (View Only)

Request line

```
POST base-URL/v1/objects/sessions
```

Request message

Object ID

None.

Query parameters

None.

Body

The following coding example specifies the time until a session timeout:

```
{
  "aliveTime": 5
}
```

| Attribute | Type | Description |
|-----------------------|------|--|
| aliveTime | long | (Optional) Session timeout value (in seconds) Specify a value in the range from 1 to 300#. If this attribute is omitted, 300 is assumed. |
| authenticationTimeout | long | (Optional) Timeout value for authentication processing (in seconds) Specify this value if an external authentication server is being used to authenticate users. Change the value according to the external authentication settings of the storage system. Specify a value in the range from 1 to 900. If this attribute is omitted, 120 is assumed. |

#: There might be a delay of up to five seconds after the specified amount of time has elapsed, before the session times out.

Response message**Body**

```
{
  "token": "d7b673af189048468c5af9bcf3b66b6f",
  "sessionId": 3
}
```

| Attribute | Type | Description |
|-----------|--------|--|
| sessionId | int | Session ID An ID that is used to manage sessions. |
| token | string | Token |

| Attribute | Type | Description |
|-----------|------|--|
| | | Information that is used to identify the source that issues requests as a specific user. |

Status codes

For details on the status codes of the request for this operation, see the description on HTTP status codes.

Coding example

```
curl -v -H "Accept:application/json" -H "Content-Type:application/json" -u
rest-test:rest-api -X POST https://192.0.2.100/ConfigurationManager/v1/
objects/sessions/ -d ""
```

Discarding sessions

The following request discards the sessions that are no longer required. If a session is discarded, the lock obtained in that session is unlocked at the same time. For the Authorization header of the request, specify the token for a session to be discarded.

Execution permission

Storage Administrator (View Only)

Request line

```
DELETE base-URL/v1/objects/sessions/object-ID
```

Request message

Object ID

Specify the value of `sessionId` that was obtained when the session was generated. A user who belongs to the Administrator user group (built-in user group) can specify the value of `sessionId` that was obtained by the processing to get information about sessions.

| Attribute | Type | Description |
|-----------|------|-----------------------|
| sessionId | int | (Required) Session ID |

Query parameters

None.

Body

```
{
  "force": true
}
```

| Attribute | Type | Description |
|-----------|---------|--|
| force | boolean | <p>Specify whether to force discarding of the session generated by other users, in addition to the session you generated. Only a user who belongs to the Administrator user group (built-in user group) can specify this attribute.</p> <ul style="list-style-type: none"> ▪ <code>true</code>: Forces discarding of the session generated by other users, in addition to the session you generated. ▪ <code>false</code>: Forces discarding of only the session you generated. <p>If you omit this value, <code>false</code> is used.</p> |

Response message**Body**

None.

Status codes

For details on the status codes of the request for this operation, see the description on HTTP status codes.

Coding example

```
curl -v -H "Accept:application/json" -H "Content-Type:application/json" -H
"Authorization:Session d7b673af189048468c5af9bcf3b6bb6f" -X DELETE --data-
binary @./InputParameters.json https://192.0.2.100/ConfigurationManager/v1/
objects/sessions/1
```

Getting a list of job information

The following request gets a list of information about jobs that were submitted by the user from the REST API. Only a user who belongs to a user group with the Storage Administrator (System Resource Management) role can get information about all the registered jobs. Job

information can be used to check APIs that were issued and to identify the cause of a problem in the storage system.

Execution permission

No role is required to run this API request. Only the users authenticated by the storage system can issue this API request.

Request line

```
GET base-URL/v1/objects/jobs
```

Request message

Object ID

None.

Query parameters

If no query parameters are specified, the request gets information about 100 jobs that can be referenced by the user and were submitted after the other jobs.

| Parameter | Type | Filter Condition |
|------------------|---------------|--|
| startCreatedTime | ISO8601string | (Optional) Specify the submission start time of the jobs for which you want to get information. Specify the time in YYYY-MM-DDThh:mm:ssZ format. The request gets information about jobs that were submitted on and after the specified time. |
| endCreatedTime | ISO8601string | (Optional) Specify the submission end time of the jobs for which you want to get information. Specify the time in YYYY-MM-DDThh:mm:ssZ format. The request gets information about jobs that were submitted before the specified time. |
| count | int | (Optional) Specify a number from 1 to 100 for the number of jobs for which you want to get information. The specified number is the maximum number of jobs for which information will be obtained. If this is omitted, 100 is assumed. |

| Parameter | Type | Filter Condition |
|-----------|--------|--|
| status | string | <p>(Optional) Specify one of the following values for the status of the jobs for which information is to be obtained.</p> <ul style="list-style-type: none"> ▪ Initializing: The jobs are being initialized. If you also need to specify a value for "state", you must specify <code>Queued</code> for "state". ▪ Running: The jobs are running. If you also need to specify a value for "state", you must specify <code>Started</code> for "state". ▪ Completed: The jobs have been completed. If you also need to specify a value for "state", you must specify <code>Succeeded</code>, <code>Failed</code>, or <code>Unknown</code> for "state". |
| state | string | <p>(Optional) Specify one of the following values for the status (state) of the jobs for which information is to be obtained.</p> <ul style="list-style-type: none"> ▪ Queued: The jobs have been queued. ▪ Started: The jobs have been started. ▪ Succeeded: The jobs finished successfully. ▪ Failed: The jobs failed. ▪ Unknown: The state of the jobs is unknown. |

The following example gets information about a maximum of 30 jobs that ended normally and were submitted after other jobs during the period from "2015/05/01 08:00:00" to "2015/05/31 23:59:59".

```
?startCreatedTime=2015-05-01T08:00:00Z&endCreatedTime=2015-05-31T23:59:59Z&count=30&state=Succeeded
```

Body

None.

Response message**Body**

```
{
  "data": [
```



```

{
  "jobId": 2,
  "self": "/ConfigurationManager/v1/objects/jobs/2",
  "userId": "rest-test",
  "status": "Completed",
  "state": "Succeeded",
  "createdTime": "2015-09-14T02:08:13Z",
  "updatedTime": "2015-09-14T02:08:13Z",
  "completedTime": "2015-09-14T02:08:13Z",
  "request": {
    "requestUrl": "/ConfigurationManager/v1/services/resource-
group-service/actions/lock/invoke",
    "requestMethod": "POST",
    "requestBody": {
      "parameters": {
        "waitTime": null
      }
    }
  },
  "affectedResources": [
    "/ConfigurationManager/v1/objects/resource-groups"
  ]
},
{
  "jobId": 1,
  "self": "/ConfigurationManager/v1/objects/jobs/1",
  "userId": "rest-test",
  "status": "Completed",
  "state": "Failed",
  "createdTime": "2015-09-14T02:04:11Z",
  "updatedTime": "2015-09-14T02:04:12Z",
  "completedTime": "2015-09-14T02:04:12Z",
  "request": {
    "requestUrl": "/ConfigurationManager/v1/services/resource-
group-service/actions/lock/invoke",
    "requestMethod": "POST",
    "requestBody": {
      "parameters": {
        "waitTime": null
      }
    }
  },
  "error": {
    "errorSource": "/ConfigurationManager/v1/services/resource-
group-service/actions/lock/invoke",
    "message": "An error occurred in the storage system.
(message = Access denied with Lock/Unlock)",
    "cause": "An error occurred during execution of a CCI
command."
  }
}

```

```

    "solution": "See the manual of the CCI and remove the cause
of the error.",
    "solutionType": "SEE_ERROR_DETAIL",
    "messageId": "KART30000-E",
    "errorCode": {
      "errorCode": "EX_EACCES"
    }
  }
}
]
}

```

| Attribute | Type | Description |
|-----------|----------|--|
| data | object[] | Job information (job objects) created by the user from the REST API. The maximum number of jobs for which you can get information at one time is 100. |

For details on the job object schema, see the section explaining job objects.

Status codes

For details on the status codes of the request for this operation, see the description on HTTP status codes.

Coding example

```

curl -v -H "Accept:application/json" -H "Content-Type:application/json" -H
"Authorization:Session d7b673af189048468c5af9bcf3b6bbb6f" -X GET https://
192.0.2.100/ConfigurationManager/v1/objects/jobs

```

Getting job information

The following request gets, at a specific timing, information about a specified job that was submitted by the user from the asynchronous API. Only a user who belongs to a user group with the Storage Administrator (System Resource Management) role can also obtain information about jobs submitted by other users. The obtained information can be used to check the job status.

Execution permission

No role is required to run this API request. Only the users authenticated by the storage system can issue this API request.

Request line

```
GET base-URL/v1/objects/jobs/object-ID
```

Request message**Object ID**

Specify the `jobId` value obtained by getting information about the job list or the response message of the asynchronous API.

| Attribute | Type | Description |
|-----------|------|--------------------------|
| jobId | long | (Required) Job object ID |

Query parameters

None.

Body

None.

Response message**Body**

```
{
  "jobId": 3,
  "self": "/ConfigurationManager/v1/objects/jobs/3",
  "userId": "rest-test",
  "status": "Completed",
  "state": "Succeeded",
  "createdTime": "2015-09-14T02:08:13Z",
  "updatedTime": "2015-09-14T02:08:13Z",
  "completedTime": "2015-09-14T02:08:13Z",
  "request": {
    "requestUrl": "/ConfigurationManager/v1/services/resource-group-
service/actions/lock/invoke",
    "requestMethod": "POST",
    "requestBody": {
      "parameters": {
        "waitTime": null
      }
    }
  },
  "affectedResources": [
    "/ConfigurationManager/v1/objects/resource-groups"
  ]
}
```

For details on the job object schema, see the description on job objects.

Status codes

The following table describes the meaning of the status code of the request for this operation. For details on other status codes, see the section explaining HTTP status codes.

| Status codes | Message | Description |
|--------------|-----------|--|
| 404 | Not Found | <ul style="list-style-type: none"> There is no information corresponding to the specified job ID. The user who issued the API request is not the user who submitted the job corresponding to the specified job ID. |

Coding example

```
curl -v -H "Accept:application/json" -H "Content-Type:application/json" -H
"Authorization:Session d7b673af189048468c5af9bcf3b6bb6f" -X GET https://
192.0.2.100/ConfigurationManager/v1/objects/jobs/3
```

Locking a resource group

The following request locks resources of a resource group allocated to the user who runs API requests, preventing other users from performing operations on the resources. Exclusive control by locking is performed on a session basis. To run requests on the locked resources, specify as the Authorization header the token of the session that was specified when the resources were locked.

Execution permission

Storage Administrator (View Only)

Request line

```
POST base-URL/v1/services/resource-group-service/actions/lock/invoke
```

Request message

Object ID

None.

Query parameters

None.

Body

```
{
  "parameters": {
    "waitTime": 30
  }
}
```

| Attribute | Type | Description |
|-----------|------|--|
| waitTime | int | The time that elapses before a lock timeout (in seconds) Specify a value from 0 to 7200 for the maximum wait time that elapses before a lock timeout occurs, for cases such as when the target resource is already locked by other sessions. If this value is omitted, 0 is specified. |

Response message**Body**

A job object is returned. For details on attributes other than `affectedResources`, see the description on job objects.

| Attribute | Description |
|-------------------|--|
| affectedResources | URL of the resource group that obtained a lock |

Status codes

For details on the status codes of the request for this operation, see the description on HTTP status codes.

| Status code | Message | Description |
|-------------|---------------------|--|
| 503 | Service unavailable | The operation cannot be performed because an API operation that locks or unlocks resources is being run by using the same session. |

Coding example

```
curl -v -H "Accept:application/json" -H "Content-Type:application/json" -H "Authorization:Session d7b673af189048468c5af9bcf3b66b6f" -X POST --data-
```

```
binary @./InputParameters.json https://192.0.2.100/ConfigurationManager/v1/
services/resource-group-service/actions/lock/invoke
```

Unlocking a resource group

The following request unlocks a resource group. For the Authorization header of the request for releasing the lock, specify the token of the session that got the lock.

Execution permission

Storage Administrator (View Only)

Request line

```
POST base-URL/v1/services/resource-group-service/actions/unlock/invoke
```

Request message

Object ID

None.

Query parameters

None.

Body

None.

Response message

Body

A job object is returned. For details on attributes other than `affectedResources`, see the section explaining job objects.

| Attribute | Description |
|--------------------------------|---|
| <code>affectedResources</code> | URL of the resource group that was unlocked |

Status codes

For details on the status codes of the request for this operation, see the section explaining HTTP status codes.

| Status code | Message | Description |
|-------------|---------------------|--|
| 503 | Service unavailable | The operation cannot be performed because an API operation that locks or unlocks resources is being run by using the same session. |

Coding example

```
curl -v -H "Accept:application/json" -H "Content-Type:application/json" -H "Authorization:Session d7b673af189048468c5af9bcf3b6bb6f" -X POST https://192.0.2.100/ConfigurationManager/v1/services/resource-group-service/actions/unlock/invoke -d ""
```

Chapter 3: User management and access control

This chapter describes how to manage users and control access to storage system resources by using the REST API.

Overview of user management and access control

To perform operations on storage system resources, users must have the appropriate roles (execution permissions) and access permissions for the resources on which the operations are to be performed. Before using the REST API, users with the required roles and access permissions must be created.

For storage systems, resource groups and user groups are used to manage the roles and access permissions of users.

Resource group

Resource groups are used to classify and manage resources in the storage system. Only users who have access permissions for a resource group can perform operations on the resources (such as parity groups, LDEVs, and ports) that are added to that resource group.

User group

User groups are used to group users who have the same roles and access permissions for the resources in the storage system. To specify the operations that users in a user group can perform, assign a role to the user group. To specify the resources that the users in a user group can access, assign a resource group to the user group.

Role

Roles are execution permissions for resources. Roles are already set up, and the operations that users of each role can perform on resources are already defined. For details on the roles required to run a particular API request, see the description on that API request.

Users whose accounts were created by using the maintenance utility or Hitachi Device Manager - Storage Navigator can also execute REST API requests. If you want to use other storage management software to create user accounts that can execute REST API requests, specify the user IDs and passwords in accordance with the rules for the REST API.

If you are using Hitachi Device Manager - Storage Navigator, any users, user groups, and resource groups that were created by using the REST API can also be used from Hitachi Device Manager - Storage Navigator.

For details about user management and access control for storage systems, see the *System Administrator Guide*.



Note:

- If a user uses the REST API to lock the resources of a storage system, operations on the users, user groups, or resource groups will no longer be able to be performed. In such a case, unlock the resources before performing these operations.
- For the VSP 5000 series, it takes several minutes for the latest information to be applied to the cache after you create or delete a resource group or add or delete resources belonging to a resource group. For this reason, if you attempt to perform operations on user groups or users after performing any of these operations related to resource groups, the request might fail. If the request fails, wait for a while, and then run the request again.

Workflow for user management and access control

This section describes the workflow for creating users who will perform operations on storage systems and for setting access permissions for the resources necessary for those operations.

When using the REST API to create a user, specify a user group to which the user will belong. Assign, in advance, resource groups and roles to the user group based on the types of resources on which the users in that user group can operate and the operation permissions of users in that user group.

The following figure shows the workflow for specifying user and access control settings. If you are using the meta_resource group or built-in user group, you do not need to configure the resource group or the user group.

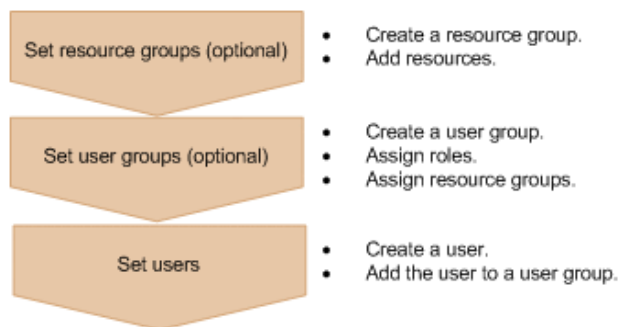

Set resource groups

Create a resource group, and then add resources such as parity groups, LDEVs, and ports. Group resources by business or organization into units for controlling access.

Set user groups

Create a user group. Assign resource groups and roles based on the types of resources on which the users in that user group can operate and the operation permissions of users in that user group.

Set users

Create a user. Specify the user group to which the user will belong, and then add the user to that user group. The user then can use the resources in the resource groups assigned to the user group according to the assigned roles.

Input rules for user IDs and passwords

When creating users who will perform operations on storage systems from the REST API, specify user IDs and passwords consisting of the characters described in the following table.

If you want to include symbols in a request body, be sure to escape the symbols as required for JSON format.

| Item | Number of characters | Specifiable characters |
|----------|----------------------|--|
| User ID | 1 to 63 characters | <p>You can use the following characters.</p> <ul style="list-style-type: none"> ▪ Alphanumeric characters ▪ The following symbols: ! # \$ % & ' * + - . / = ? @ ^ _ ` { } ~ • User IDs that contain forward slashes (/) cannot be used as object IDs. • User IDs that contain percent signs (%) or plus signs (+) cannot be used as object IDs for the following API requests: API request for adding users to user groups API request for removing users from user groups |
| Password | 6 to 63 characters | <p>You can use the following characters.</p> <ul style="list-style-type: none"> ▪ Alphanumeric characters ▪ ASCII symbols which can be keyed in except space: ! # \$ % & ' () * + , - . / : ; < = > ? @ [\] ^ _ ` { } ~ |

**Note:**

- When creating a user account that will not be used for the REST API but will be used for other products such as Storage Navigator, you can use the number of characters in the `userId` and `userPassword` attributes of the API function for creating a user account, and in the `userPassword` attribute of the API function for changing the password of the user. Specify the user ID and password according to input restrictions (specifiable characters and the required number of characters) of the software for which the user account will be used. Note that, if you create an account for which the user ID or password does not adhere to the input restrictions in the preceding table, you will not be able to use the account to run the REST API.
 - The `userId` attribute: 1 to 256 characters
 - The `userPassword` attribute: 6 to 256 characters
- If you use Storage Navigator or another product to create a user account whose password includes a double quotation mark ("), you can use that user account to run the REST API. However, you cannot use the REST API to create a user account whose password includes a double quotation mark or to change a password to one that includes a double quotation mark.

Getting a list of resource groups

The following request gets information about resource groups registered in the storage system. You can also use a query parameter to get information about only certain resources of interest.

**Important:**

For a VSP E series, VSP G350, G370, G700, G900, VSP F350, F370, F700, F900 storage system, pay attention to the number of concurrent executions of this API request. For details, see "Implementing retry processing".

Execution permission

Storage Administrator (View Only)

Request line

```
GET base-URL/v1/objects/resource-groups
```

Request message**Object ID**

None.

Query parameters

To filter execution results:

| Parameter | Type | Filter condition |
|------------|--------|---|
| lockStatus | string | (Optional) Lock status of the resource group <ul style="list-style-type: none"> ▪ Locked: Gets information about the locked resource groups ▪ Unlocked: Gets information about the unlocked resource groups |

To get information about only certain types of resources in resource groups:

If you try to get information for a large number of resource groups, processing might take a long time. You can reduce the request processing time by using the following query parameter to get information about only certain resources of interest.

| Parameter | Type | Filter condition |
|------------|--------|--|
| attributes | string | (Optional) Type of resource for which information is to be obtained Information will be obtained about only resources corresponding to the specified attributes. To specify multiple attributes, separate the attributes by using commas. You can use this parameter in combination with the <code>lockStatus</code> parameter. <ul style="list-style-type: none"> ▪ <code>ldevIds</code>: LDEV numbers ▪ <code>parityGroupIds</code>: Parity group numbers ▪ <code>externalParityGroupIds</code>: External parity group numbers ▪ <code>portIds</code>: Port numbers ▪ <code>hostGroupIds</code>: Object IDs of host groups or iSCSI targets If this parameter is omitted, information will be obtained about all of the attributes listed above. Information about attributes other than those listed above will be obtained regardless of the specification of this parameter. |

The following are examples of how to specify these query parameters in various situations.

To get the LDEV numbers of locked resource groups:

```
?lockStatus=Locked&attributes=ldevIds
```

To get the port numbers, and the object IDs of host groups or iSCSI targets for all resource groups:

```
?attributes=portIds,hostGroupIds
```

Body

None.

Response message**Body**

The following is an example of output when a request is run to get information about all types of resource groups:

```
{
  "data": [
    {
      "resourceGroupId": 4,
      "resourceGroupName": "devResourceGroup",
      "lockStatus": "Locked",
      "lockOwner": "devUser",
      "lockHost": "host01",
      "virtualStorageId": 0,
      "ldevIds": [
        12,
        13
      ],
      "parityGroupIds": [
        "1-1",
        "1-2"
      ],
      "externalParityGroupIds": [
        "1-5",
        "1-6"
      ],
      "portIds": [
        "CL1-A",
        "CL1-B"
      ],
      "hostGroupIds": [
        "CL1-A,4",
        "CL1-A,5",
        "CL1-A,6"
      ]
    },
    {
      "resourceGroupId": 5,
      "resourceGroupName": "sales_group_resource",
      "lockStatus": "Unlocked",
      "virtualStorageId": 0,
      "ldevIds": [
        32,
        33
      ],
      "parityGroupIds": [
        "2-1",
        "2-2"
      ]
    }
  ]
}
```

```
],
  "externalParityGroupIds": [
    "1-7",
    "1-8"
  ],
  "portIds": [
    "CL3-A"
  ],
  "hostGroupIds": [
    "CL3-A,1",
    "CL3-A,2"
  ]
}
]
```

The following is an example of output when a request is run with the `attributes` query parameter specified, to get only information about port numbers and the object IDs of host groups or iSCSI targets:

```
{
  "data": [
    {
      "resourceGroupId": 4,
      "resourceGroupName": "devResourceGroup",
      "lockStatus": "Locked",
      "lockOwner": "devUser",
      "lockHost": "host01",
      "virtualStorageId": 0,
      "portIds": [
        "CL1-A",
        "CL1-B"
      ],
      "hostGroupIds": [
        "CL1-A,4",
        "CL1-A,5",
        "CL1-A,6"
      ]
    },
    {
      "resourceGroupId": 5,
      "resourceGroupName": "sales_group_resource",
      "lockStatus": "Unlocked",
      "virtualStorageId": 0,
      "portIds": [
        "CL3-A"
      ],
      "hostGroupIds": [
        "CL3-A,1",
        "CL3-A,2"
      ]
    }
  ]
}
```

| Attribute | Type | Description |
|-------------------|--------|---------------------|
| resourceGroupName | string | Resource group name |
| resourceGroupId | int | Resource group ID |

| Attribute | Type | Description |
|------------------------|----------|--|
| lockStatus | string | Lock status of the resource group <ul style="list-style-type: none"> Locked: The resource group is locked. Unlocked: The resource group is unlocked. |
| selfLock | boolean | Whether the session specified in the Authorization header locked the resource group <ul style="list-style-type: none"> true: The specified session locked the resource group false: Another session locked the resource group <p>This attribute is output if the resource group is locked by a session that was generated by the same user who runs the API.</p> |
| lockOwner | string | User ID that locked the resource group <p>This attribute is not output if the resource group is unlocked.</p> |
| lockHost | string | IP address or name of the host that locked the resource group <p>If the resource group has been locked by the REST API, IP address or the host name of the SVP or GUM is output.</p> <p>This attribute is output only when the resource group is locked.</p> |
| lockSessionId | int | Session ID that locked the resource group <p>This attribute is output only when the resource group is locked and when a user who belongs to the Administrator user group (built-in user group) runs the API.</p> |
| virtualStorageId | int | ID of the virtual storage machine that corresponds to the resource group |
| ldevIds | int[] | LDEV number |
| parityGroupIds | string[] | Parity group number |
| externalParityGroupIds | string[] | External parity group number |

| Attribute | Type | Description |
|--------------|-----------|---|
| portIds | string[] | Port number |
| hostGroupIds | string[] | Object ID of the host group or iSCSI target |

Status codes

For details on the status codes of the request for this operation, see the description on HTTP status codes.

Coding example

```
curl -v -H "Accept:application/json" -H "Content-Type:application/json" -H "Authorization:Session d7b673af189048468c5af9bcf3bbbb6f" -X GET https://192.0.2.100/ConfigurationManager/v1/objects/resource-groups
```

Getting information about a specific resource group

The following request gets information about the specified resource group. The obtained information can be used to check the lock status of a resource group, the user ID of the user who locked the resource group, or the name of the host that locked the resource group.

Execution permission

Storage Administrator (View Only)

Request line

```
GET base-URL/v1/objects/resource-groups/object-ID
```

Request message

Object ID

Specify the value of `resourceGroupId` that was obtained by the processing to get information about resource groups.

| Attribute | Type | Description |
|-----------------|------|------------------------------|
| resourceGroupId | int | (Required) Resource group ID |

| Attribute | Type | Description |
|-----------|------|---|
| | | Specify a decimal (base 10) number in the range from 0 to 1023. |

Query parameters

None.

Body

None.

Response message**Body**

```

{
  "resourceGroupId": 4,
  "resourceGroupName": "devResourceGroup",
  "lockStatus": "Locked",
  "lockOwner": "devUser",
  "lockHost": "host01",
  "virtualStorageId": 0,
  "ldevIds": [
    12,
    13
  ],
  "parityGroupIds": [
    "1-1",
    "1-2"
  ],
  "externalParityGroupIds": [
    "1-5",
    "1-6"
  ],
  "portIds": [
    "CL1-A",
    "CL1-B"
  ],
  "hostGroupIds": [
    "CL1-A,4",
    "CL1-A,5",
    "CL1-A,6"
  ]
}

```

| Attribute | Type | Description |
|-------------------|----------|---|
| resourceGroupName | string | Resource group name |
| resourceGroupId | int | Resource group ID |
| lockStatus | string | Lock status of the resource group <ul style="list-style-type: none"> Locked: The resource group is locked. Unlocked: The resource group is unlocked. |
| selfLock | boolean | Whether the resource group was locked by the session specified in the Authorization header <ul style="list-style-type: none"> true: The specified session locked the resource group. false: Another session locked the resource group. <p>This attribute is output when the resource group is locked by a session that was generated by the same user who runs the API.</p> |
| lockOwner | string | User ID of the user who locked the resource group <p>This attribute is output only when the resource group is locked.</p> |
| lockHost | string | IP address or name of the host that locked the resource group <p>If the resource group has been locked by the REST API, IP address or the host name of the SVP or GUM is output.</p> <p>This attribute is output only when the resource group is locked.</p> |
| lockSessionId | int | Session ID of the session that locked the resource group <p>This attribute is output only when the resource group is locked and the API was run by one of the following users: the user who belongs to the Administrator user group (built-in user group).</p> |
| virtualStorageId | int | ID of the virtual storage machine that corresponds to the resource group |
| ldevIds | int[] | LDEV number |
| parityGroupIds | string[] | Parity group number |

| Attribute | Type | Description |
|------------------------|----------|---|
| externalParityGroupIds | string[] | External parity group number |
| portIds | string[] | Port number |
| hostGroupIds | string[] | Object ID of the host group or iSCSI target |

Status codes

For details on the status codes of the request for this operation, see the description on HTTP status codes.

Coding example

```
curl -v -H "Accept:application/json" -H "Content-Type:application/json" -H
"Authorization:Session d7b673af189048468c5af9bcf3b6bb6f" -X GET https://
192.0.2.100/ConfigurationManager/v1/objects/resource-groups/4
```

Creating a resource group

The following request creates resource groups. To add a resource group to a virtual storage machine, you must also specify the `virtualStorageDeviceId` attribute.



Note:

If you locked any resources of the target storage system by using the REST API, you will not be able to use this API function. In such cases, unlock the resources before running the API function.

Execution permission

Security Administrator (View & Modify)

Request line

```
POST base-URL/v1/objects/resource-groups
```

Request message

Object ID

None.

Query parameters

None.

Body

```
{
  "resourceGroupName": "devResourceGroup",
  "virtualStorageDeviceId": "900000050001"
}
```

| Attribute | Type | Description |
|------------------------|--------|---|
| resourceGroupName | string | (Required) Resource group name Specify a name consisting of 1 to 32 characters. |
| virtualStorageDeviceId | string | (Optional) Storage device ID of the virtual storage machine This attribute cannot be specified at the same time as the <code>virtualStorageId</code> attribute. If this attribute is omitted, the default storage device ID (the same storage device ID as that of the target physical storage system) will be set. |
| virtualStorageId | int | (Optional) ID of the virtual storage machine that corresponds to the resource group This attribute cannot be specified at the same time as the <code>virtualStorageDeviceId</code> attribute. If this attribute is omitted, 0 will be set. |

Response message**Body**

A job object is returned. For details on attributes other than `affectedResources`, see the description on job objects.

| Attribute | Description |
|-------------------|-----------------------------------|
| affectedResources | URL of the created resource group |

Status codes

For details on the status codes of the request for this operation, see the description on HTTP status codes.

Coding example

```
curl -v -H "Accept:application/json" -H "Content-Type:application/json" -H
"Authorization:Session d7b673af189048468c5af9bcf3b6bb6f" -X POST --data-
binary @./InputParameters.json https://192.0.2.100/ConfigurationManager/v1/
objects/resource-groups
```

Adding a resource to a resource group

The following request adds resources to resource groups.

**Note:**

If you locked any resources of the target storage system by using the REST API, you will not be able to use this API function. In such cases, unlock the resources before running the API function.

Execution permission

Security Administrator (View & Modify)

Request line

```
POST base-URL/v1/objects/resource-groups/object-ID/actions/add-resource/
invoke
```

Request message**Object ID**

Specify the value of `resourceGroupId` that was obtained by the processing to get information about resource groups.

| Attribute | Type | Description |
|-----------------|------|---|
| resourceGroupID | int | (Required) Resource group ID Specify a decimal (base 10) number in the range from 1 to 1023. |

Query parameters

None.

Body

The following coding example shows how to specify an LDEV number:

```
{
  "parameters": {
    "ldevIds": [
      2,
      3
    ],
    "parityGroupIds": [
      "1-1",
      "1-2"
    ],
    "externalParityGroupIds": [
      "1-5",
      "1-6"
    ],
    "portIds": [
      "CL1-A",
      "CL1-B"
    ],
    "hostGroupIds": [
      "CL1-A,4",
      "CL1-A,5",
      "CL1-A,6"
    ]
  }
}
```

The following coding example shows how to specify a range of LDEV numbers:

```
{
  "parameters": {
    "startLdevId": 2,
    "endLdevId": 5,
    "parityGroupIds": [
      "1-1",
      "1-2"
    ],
    "externalParityGroupIds": [
      "1-5",
      "1-6"
    ],
    "portIds": [
      "CL1-A",
      "CL1-B"
    ],
    "hostGroupIds": [
      "CL1-A,4",

```



```

    "CL1-A,5",
    "CL1-A,6"
  ]
}
}

```

| Attribute | Type | Description |
|------------------------|----------|--|
| parityGroupIds | string[] | (Optional) Parity group number |
| externalParityGroupIds | string[] | (Optional) External parity group number |
| portIds | string[] | (Optional) Port number |
| hostGroupIds | string[] | (Optional) Object ID of the host group or iSCSI target Specify the value of <code>hostGroupId</code> that was obtained by the processing to get information about host groups or iSCSI targets. |
| ldevIds | int[] | (Optional) LDEV number Specify a value in the range from 0 to 65279. If you specify this attribute, you cannot specify the <code>startLdevId</code> attribute or the <code>endLdevId</code> attribute. |
| startLdevId | int | (Optional) First LDEV number When specifying a range of LDEVs, specify a value in the range from 0 to 65278. If you specify this attribute, you must also specify the <code>endLdevId</code> attribute. If you specify the <code>ldevId</code> attribute, you cannot specify this attribute. |
| endLdevId | int | (Optional) Last LDEV number When specifying a range of LDEVs, specify a value in the range from 1 to 65279. If you specify this attribute, you must also specify the <code>startLdevId</code> attribute. If you specify the <code>ldevId</code> attribute, you cannot specify this attribute. |

Response message

Body

A job object is returned. For details on attributes other than `affectedResources`, see the description on job objects.

| Attribute | Description |
|-------------------|--|
| affectedResources | URL of the resource group to which resources are added |

Action template

```
GET base-URL/v1/objects/resource-groups/object-ID/actions/add-resource
```

Status codes

For details on the status codes of the request for this operation, see the description on HTTP status codes.

Coding example

To get an action template:

```
curl -v -H "Accept:application/json" -H "Content-Type:application/json" -H "Authorization:Session d7b673af189048468c5af9bcf3b66b6f" -X GET https://192.0.2.100/ConfigurationManager/v1/objects/resource-groups/4/actions/add-resource
```

To run the request after getting an action template:

```
curl -v -H "Accept:application/json" -H "Content-Type:application/json" -H "Authorization:Session d7b673af189048468c5af9bcf3b66b6f" --data-binary @./InputParameters.json -X POST https://192.0.2.100/ConfigurationManager/v1/objects/resource-groups/4/actions/add-resource/invoke
```

Removing a resource from a resource group

The following request removes resources that are no longer necessary from resource groups.



Note:

If you locked any resources of the target storage system by using the REST API, you will not be able to use this API function. In such cases, unlock the resources before running the API function.

Execution permission

Security Administrator (View & Modify)

Request line

```
POST base-URL/v1/objects/resource-groups/object-ID/actions/remove-resource/
invoke
```

Request message**Object ID**

Specify the value of `resourceGroupId` that was obtained by the processing to get information about resource groups.

| Attribute | Type | Description |
|------------------------------|------|---|
| <code>resourceGroupId</code> | int | (Required) Resource group ID Specify a decimal (base 10) number in the range from 1 to 1023. |

Query parameters

None.

Body

The following coding example shows how to specify an LDEV number:

```
{
  "parameters": {
    "ldevIds": [
      2,
      3
    ],
    "parityGroupIds": [
      "1-1",
      "1-2"
    ],
    "externalParityGroupIds": [
      "1-5",
      "1-6"
    ],
    "portIds": [
      "CL1-A",
      "CL1-B"
    ],
    "hostGroupIds": [
      "CL1-A,4",
      "CL1-A,5",
      "CL1-A,6"
    ]
  }
}
```

```

}
}

```

The following coding example shows how to specify a range of LDEV numbers:

```

{
  "parameters": {
    "startLdevId": 2,
    "endLdevId": 5,
    "parityGroupIds": [
      "1-1",
      "1-2"
    ],
    "externalParityGroupIds": [
      "1-7",
      "1-8"
    ],
    "portIds": [
      "CL1-A",
      "CL1-B"
    ],
    "hostGroupIds": [
      "CL1-A,4",
      "CL1-A,5",
      "CL1-A,6"
    ]
  }
}

```

| Attribute | Type | Description |
|------------------------|----------|--|
| parityGroupIds | string[] | (Optional) Parity group number |
| externalParityGroupIds | string[] | (Optional) External parity group number |
| portIds | string[] | (Optional) Port number |
| hostGroupIds | string[] | (Optional) Object ID of the host group or iSCSI target Specify the value of <code>hostGroupId</code> that was obtained by the processing to get information about host groups or iSCSI targets. |
| ldevIds | int[] | (Optional) LDEV number |

| Attribute | Type | Description |
|--------------------------|------|--|
| | | Specify a value in the range from 0 to 65279. If you specify this attribute, you cannot specify the <code>startLdevId</code> attribute or the <code>endLdevId</code> attribute. |
| <code>startLdevId</code> | int | (Optional) First LDEV number When specifying a range of LDEVs, specify a value in the range from 0 to 65278. If you specify this attribute, you must also specify the <code>endLdevId</code> attribute. If you specify the <code>ldevId</code> attribute, you cannot specify this attribute. |
| <code>endLdevId</code> | int | (Optional) Last LDEV number When specifying a range of LDEVs, specify a value in the range from 1 to 65279. If you specify this attribute, you must also specify the <code>startLdevId</code> attribute. If you specify the <code>ldevId</code> attribute, you cannot specify this attribute. |

Response message

Body

A job object is returned. For details on attributes other than `affectedResources`, see the description on job objects.

| Attribute | Description |
|--------------------------------|---|
| <code>affectedResources</code> | URL of the resource group from which resources were removed |

Action template

```
GET base-URL/v1/objects/resource-groups/object-ID/actions/remove-resource
```

Status codes

For details on the status codes of the request for this operation, see the description on HTTP status codes.

Coding example

To get an action template:

```
curl -v -H "Accept:application/json" -H "Content-Type:application/json" -H
"Authorization:Session d7b673af189048468c5af9bcf3b6bb6f" -X GET https://
192.0.2.100/ConfigurationManager/v1/objects/resource-groups/4/actions/
remove-resource
```

To run the request after getting an action template:

```
curl -v -H "Accept:application/json" -H "Content-Type:application/json" -H
"Authorization:Session d7b673af189048468c5af9bcf3b6bb6f" --data-binary @./
InputParameters.json -X POST https://192.0.2.100/ConfigurationManager/v1/
objects/resource-groups/4/actions/remove-resource/invoke
```

Deleting a resource group

The following request deletes unnecessary resource groups.

**Note:**

If you locked any resources of the target storage system by using the REST API, you will not be able to use this API function. In such cases, unlock the resources before running the API function.

Execution permission

Security Administrator (View & Modify)

Request line

```
DELETE base-URL/v1/objects/resource-groups/object-ID
```

Request message**Object ID**

Specify the value of `resourceGroupId` that was obtained by the processing to get information about resource groups.

| Attribute | Type | Description |
|-----------------|------|---|
| resourceGroupID | int | (Required) Resource group ID Specify a decimal (base 10) number in the range from 1 to 1023. |

Query parameters

None.

Body

None.

Response message**Body**

A job object is returned. For details on attributes other than `affectedResources`, see the description on job objects.

| Attribute | Description |
|--------------------------------|-----------------------------------|
| <code>affectedResources</code> | URL of the deleted resource group |

Status codes

For details on the status codes of the request for this operation, see the description on HTTP status codes.

Coding example

```
curl -v -H "Accept:application/json" -H "Content-Type:application/json" -H
"Authorization:Session d7b673af189048468c5af9bcf3bbbb6f" -X DELETE
https://192.0.2.100/ConfigurationManager/v1/objects/resource-groups/4
```

Getting a list of user groups

The following request gets a list of user groups registered in the target storage system.

Execution permission

Security Administrator (View Only)

Request line

```
GET base-URL/v1/objects/user-groups
```

Request message**Object ID**

None.

Query parameters

None.

Body

None.

Response message**Body**

```

{
  "data": [
    {
      "userGroupObjectId": "devGroup",
      "userGroupId": "devGroup",
      "roleNames": [
        "Audit Log Administrator (View & Modify)"
      ],
      "resourceGroupIds": [
        1,
        2,
        3
      ],
      "isBuiltIn": false,
      "hasAllResourceGroup": false
    },
    {
      "userGroupObjectId": "adminGroup",
      "userGroupId": "adminGroup",
      "roleNames": [
        "Audit Log Administrator (View & Modify)",
        "Security Administrator (View & Modify)",
        "Storage Administrator (Initial Configuration)",
        "Storage Administrator (Local Copy)",
        "Storage Administrator (Performance Management)",
        "Storage Administrator (Provisioning)",
        "Storage Administrator (Remote Copy)",
        "Storage Administrator (System Resource Management)"
      ],
      "isBuiltIn": false,
      "hasAllResourceGroup": true
    }
  ]
}

```

| Attribute | Type | Description |
|-------------------|--------|-----------------------------------|
| userGroupObjectId | string | The object ID for a user group ID |

| Attribute | Type | Description |
|---------------------|----------|---|
| | | An encoded character string is output if the user group ID includes reserved characters defined in RFC3986. |
| userGroupId | string | The user group ID |
| roleNames | string[] | The role name assigned to the user group |
| resourceGroupIds | int[] | The IDs of the resource groups assigned to the user group |
| isBuiltIn | boolean | Information about whether the user group is a built-in user group. <ul style="list-style-type: none"> <code>true</code>: A built-in user group. <code>false</code>: A user group created by a user. |
| hasAllResourceGroup | boolean | Information about whether all the resource groups are assigned to the target. <ul style="list-style-type: none"> <code>true</code>: All the resource groups are assigned. <code>false</code>: The specified resource groups are assigned. |

Status codes

For details on the status codes of the request for this operation, see the description on HTTP status codes.

Coding example

```
curl -v -H "Accept:application/json" -H "Content-Type:application/json" -H
"Authorization:Session d7b673af189048468c5af9bcf3b6bb6f" -X GET https://
192.0.2.100/ConfigurationManager/v1/objects/user-groups
```

Getting information about a specific user group

The following request gets information about the specified user group.

Execution permission

Security Administrator (View Only)

Request line

```
GET base-URL/v1/objects/user-groups/object-ID
```

Request message**Object ID**

Set the `userGroupObjectId` value obtained by getting the information about the user group.

| Attribute | Type | Description |
|--------------------------------|--------|--|
| <code>userGroupObjectId</code> | string | (Required) The object ID for a user group ID The object ID is case sensitive. |

Query parameters

None.

Body

None.

Response message**Body**

```
{
  "userGroupObjectId": "devGroup",
  "userGroupId": "devGroup",
  "roleNames": [
    "Security Administrator (View Only)"
  ],
  "resourceGroupIds": [
    1,
    2,
    3
  ],
  "isBuiltIn": false,
  "hasAllResourceGroup": false
}
```

| Attribute | Type | Description |
|--------------------------------|--------|-----------------------------------|
| <code>userGroupObjectId</code> | string | The object ID for a user group ID |

| Attribute | Type | Description |
|---------------------|----------|---|
| | | An encoded character string is output if the user group ID includes reserved characters defined in RFC 3986. |
| userGroupId | string | The user group ID |
| roleNames | string[] | The role name assigned to the user group |
| resourceGroupIds | int[] | The IDs of the resource groups assigned to the user group |
| isBuiltIn | boolean | Information about whether the user group is a built-in user group. <ul style="list-style-type: none"> ▪ <code>true</code>: A built-in user group. ▪ <code>false</code>: A user group created by a user. |
| hasAllResourceGroup | boolean | Information about whether all the resource groups are assigned to the target. <ul style="list-style-type: none"> ▪ <code>true</code>: All the resource groups are assigned. ▪ <code>false</code>: The specified resource groups are assigned. |

Status codes

For details on the status codes of the request for this operation, see the description on HTTP status codes.

Coding example

```
curl -v -H "Accept:application/json" -H "Content-Type:application/json" -H
"Authorization:Session d7b673af189048468c5af9bcf3b6bb6f" -X GET https://
192.0.2.100/ConfigurationManager/v1/objects/user-groups/devGroup
```

Creating a user group

The following request creates a user group and assigns an appropriate role and resource groups.

**Note:**

If you locked any resources of the target storage system by using the REST API, you will not be able to use this API function. In such cases, unlock the resources before running the API function.

Execution permission

Security Administrator (View & Modify)

Request line

POST *base-URL/v1/objects/user-groups*

Request message**Object ID**

None.

Query parameters

None.

Body

```
{
  "userGroupId": "devGroup",
  "roleNames": [
    "Storage Administrator (Provisioning)"
  ],
  "resourceGroupIds": [
    8,
    9
  ],
  "hasAllResourceGroup": false
}
```

| Attribute | Type | Description |
|-------------|----------|--|
| userGroupId | string | (Required) The user group ID Specify an ID consisting of 1 to 64 characters. |
| roleNames | string[] | (Required) The role name Specify one or more of the following role names. The role names are case sensitive. If you specify multiple role names, delimit the names by commas. |

| Attribute | Type | Description |
|---------------------|---------|---|
| | | <p>You must specify Storage Administrator (View Only).</p> <ul style="list-style-type: none"> ▪ Audit Log Administrator (View & Modify)[#] ▪ Audit Log Administrator (View Only)[#] ▪ Security Administrator (View & Modify)[#] ▪ Security Administrator (View Only)[#] ▪ Storage Administrator (Initial Configuration) ▪ Storage Administrator (Local Copy) ▪ Storage Administrator (Performance Management) ▪ Storage Administrator (Provisioning) ▪ Storage Administrator (Remote Copy) ▪ Storage Administrator (System Resource Management) ▪ Storage Administrator (View Only) ▪ Support Personnel[#] ▪ User Maintenance[#] <p>[#]: If you specify this role, be sure to specify <code>true</code> for <code>hasAllResourceGroup</code>.</p> |
| resourceGroupIds | int[] | <p>(Optional) The resource group IDs</p> <p>Specify one or more decimal (base 10) numbers within the range of 0 to 1023. If you specify multiple IDs, delimit the IDs by commas. This cannot be specified if the <code>hasAllResourceGroup</code> attribute is <code>true</code>.</p> |
| hasAllResourceGroup | boolean | <p>(Required) Information about whether all the resource groups are assigned to the target.</p> |

| Attribute | Type | Description |
|-----------|------|---|
| | | <p>If the roles specified for <code>roleNames</code> include any of the following roles, be sure to specify <code>true</code> for this attribute.</p> <ul style="list-style-type: none"> ▪ Audit Log Administrator (View & Modify) ▪ Audit Log Administrator (View Only) ▪ Security Administrator (View & Modify) ▪ Security Administrator (View Only) ▪ Support Personnel ▪ User Maintenance <p>If the roles specified for <code>roleNames</code> does not include any of these roles, be sure to specify <code>false</code> for this attribute.</p> |

Response message

Body

A job object is returned. For details on attributes other than `affectedResources`, see the section explaining job objects.

| Attribute | Description |
|--------------------------------|-------------------------------|
| <code>affectedResources</code> | URL of the created user group |

Status codes

For details on the status codes of the request for this operation, see the description on HTTP status codes.

Coding example

```
curl -v -H "Accept:application/json" -H "Content-Type:application/json" -H
"Authorization:Session d7b673af189048468c5af9bcf3b66b6f" -X POST --data-
binary @./InputParameters.json https://192.0.2.100/ConfigurationManager/v1/
objects/user-groups
```

Changing the user group settings

The following request sets a user group ID and a role of the specified user group.



Note:

If you locked any resources of the target storage system by using the REST API, you will not be able to use this API function. In such cases, unlock the resources before running the API function.

Execution permission

Security Administrator (View & Modify)

Request line

```
PATCH base-URL/v1/objects/user-groups/object-ID
```

Request message

Object ID

Set the `userGroupObjectId` value obtained by getting the information about the user group.

| Attribute | Type | Description |
|--------------------------------|--------|--|
| <code>userGroupObjectId</code> | string | (Required) The object ID for a user group ID The object ID is case sensitive. |

Query parameters

None.

Body

The following coding example shows how to change the user group ID:

```
{
  "userGroupId": "adminGroup"
}
```

The following coding example shows how to change a role:

```
{
  "roleNames": [
    "Storage Administrator (Provisioning)",
    "Storage Administrator (Local Copy)"
  ]
}
```

```

]
}

```

Only one attribute can be specified in one request.

| Attribute | Type | Description |
|---------------------|----------|---|
| userGroupId | string | (Optional) The user group ID Specify an ID consisting of 1 to 64 characters. |
| hasAllResourceGroup | boolean | (Optional) Information about whether all the resource groups are assigned to the target. If the roles specified for <code>roleNames</code> include any of the following roles, be sure to specify <code>true</code> for this attribute. <ul style="list-style-type: none"> ▪ Audit Log Administrator (View & Modify) ▪ Audit Log Administrator (View Only) ▪ Security Administrator (View & Modify) ▪ Security Administrator (View Only) ▪ Support Personnel ▪ User Maintenance If the roles specified for <code>roleNames</code> does not include any of these roles, be sure to specify <code>false</code> for this attribute. |
| roleNames | string[] | (Optional) The role name Specify one or more of the following role names. The role names are case sensitive. If you specify multiple role names, delimit the names by commas. You must specify <code>Storage Administrator (View Only)</code> . <ul style="list-style-type: none"> ▪ Audit Log Administrator (View & Modify)[#] ▪ Audit Log Administrator (View Only)[#] ▪ Security Administrator (View & Modify)[#] |

| Attribute | Type | Description |
|-----------|------|--|
| | | <ul style="list-style-type: none"> ▪ Security Administrator (View Only)[#] ▪ Storage Administrator (Initial Configuration) ▪ Storage Administrator (Local Copy) ▪ Storage Administrator (Performance Management) ▪ Storage Administrator (Provisioning) ▪ Storage Administrator (Remote Copy) ▪ Storage Administrator (System Resource Management) ▪ Storage Administrator (View Only) ▪ Support Personnel[#] ▪ User Maintenance[#] <p>[#]: If you specify this role, be sure to specify <code>true</code> for <code>hasAllResourceGroup</code>.</p> |

Response message

Body

A job object is returned. For details on attributes other than `affectedResources`, see the section explaining job objects.

| Attribute | Description |
|--------------------------------|---|
| <code>affectedResources</code> | URL of the user group on which settings are changed |

Action template

None.

Status codes

For details on the status codes of the request for this operation, see the description on HTTP status codes.

Coding example

```
curl -v -H "Accept:application/json" -H "Content-Type:application/json" -H
"Authorization:Session d7b673af189048468c5af9bcf3b6bb6f" -X PATCH
https://192.0.2.100/ConfigurationManager/v1/objects/user-groups/devGroup
```

Assigning resource groups to a user group

The following request assigns resource groups to a created user group.

**Note:**

If you locked any resources of the target storage system by using the REST API, you will not be able to use this API function. In such cases, unlock the resources before running the API function.

Execution permission

Security Administrator (View & Modify)

Request line

```
POST base-URL/v1/objects/user-groups/object-ID/actions/add-resource-group/
invoke
```

Request message**Object ID**

Set the `userGroupObjectId` value obtained by getting the information about the user group.

| Attribute | Type | Description |
|--------------------------------|--------|--|
| <code>userGroupObjectId</code> | string | (Required) The object ID for a user group ID The object ID is case sensitive. |

Query parameters

None.

Body

```
{
  "parameters": {
    "resourceGroupIds": [
      1,
      2
    ]
  }
}
```

```

    ]
  }
}

```

| Attribute | Type | Description |
|------------------|-------|---|
| resourceGroupIds | int[] | (Required) The resource group IDs Specify one or more decimal (base 10) numbers within the range of 0 to 1023. If you specify multiple IDs, delimit the IDs by commas. |

Response message

Body

A job object is returned. For details on attributes other than `affectedResources`, see the section explaining job objects.

| Attribute | Description |
|-------------------|---|
| affectedResources | URL of the user group to which resource groups are assigned |

Action template

```
GET base-URL/v1/objects/user-groups/object-ID/actions/add-resource-group
```

Status codes

For details on the status codes of the request for this operation, see the description on HTTP status codes.

Coding example

To get an action template:

```
curl -v -H "Accept:application/json" -H "Content-Type:application/json" -H
"Authorization:Session d7b673af189048468c5af9bcf3b6bb6f" -X GET https://
192.0.2.100/ConfigurationManager/v1/objects/user-groups/devGroup/actions/
add-resource-group
```

To run the request after getting an action template:

```
curl -v -H "Accept:application/json" -H "Content-Type:application/json" -H
"Authorization:Session d7b673af189048468c5af9bcf3b6bb6f" --data-binary @./
```

```
InputParameters.json -X POST https://192.0.2.100/ConfigurationManager/v1/objects/user-groups/devGroup/actions/add-resource-group/invoke
```

Releasing resource groups assigned to a user group

The following request releases resource groups assigned to a user group.



Note:

If you locked any resources of the target storage system by using the REST API, you will not be able to use this API function. In such cases, unlock the resources before running the API function.

Execution permission

Security Administrator (View & Modify)

Request line

```
POST base-URL/v1/objects/user-groups/object-ID/actions/remove-resource-group/invoke
```

Request message

Object ID

Set the `userGroupObjectId` value obtained by getting information about the user group.

| Attribute | Type | Description |
|--------------------------------|--------|--|
| <code>userGroupObjectId</code> | string | (Required) The object ID for a user group ID The object ID is case sensitive. |

Query parameters

None.

Body

```
{
  "parameters": {
    "resourceGroupIds": [
      1,
      2
    ]
  }
}
```

```
}
}
```

| Attribute | Type | Description |
|------------------|-------|---|
| resourceGroupIds | int[] | (Required) The resource group IDs Specify one or more decimal (base 10) numbers within the range of 0 to 1023. If you specify multiple IDs, delimit the IDs by commas. |

Response message

Body

A job object is returned. For details on attributes other than `affectedResources`, see the section explaining job objects.

| Attribute | Description |
|-------------------|---|
| affectedResources | URL of the user group where assignment of resource groups is released |

Action template

```
GET base-URL/v1/objects/user-groups/object-ID/actions/remove-resource-group
```

Status codes

For details on the status codes of the request for this operation, see the description on HTTP status codes.

Coding example

To get an action template:

```
curl -v -H "Accept:application/json" -H "Content-Type:application/json" -H
"Authorization:Session d7b673af189048468c5af9bcf3bbbb6f" -X GET https://
192.0.2.100/ConfigurationManager/v1/objects/user-groups/devGroup/actions/
remove-resource-group
```

To run the request after getting an action template:

```
curl -v -H "Accept:application/json" -H "Content-Type:application/json" -H
"Authorization:Session d7b673af189048468c5af9bcf3bbbb6f" --data-binary @./
```

```
InputParameters.json -X POST https://192.0.2.100/ConfigurationManager/v1/objects/user-groups/devGroup/actions/remove-resource-group/invoke
```

Deleting a user group

The following request deletes an unneeded user group. The request cannot delete a user group if the user group is assigned to a user.



Note:

If you locked any resources of the target storage system by using the REST API, you will not be able to use this API function. In such cases, unlock the resources before running the API function.

Execution permission

Security Administrator (View & Modify)

Request line

```
DELETE base-URL/v1/objects/user-groups/object-ID
```

Request message

Object ID

Set the `userGroupObjectId` value obtained by getting the information about the user group.

| Attribute | Type | Description |
|--------------------------------|--------|--|
| <code>userGroupObjectId</code> | string | (Required) The object ID for a user group ID The object ID is case sensitive. |

Query parameters

None.

Body

None.

Response message

Body

A job object is returned. For details on attributes other than `affectedResources`, see the section explaining job objects.

| Attribute | Description |
|-------------------|-------------------------------|
| affectedResources | URL of the deleted user group |

Status codes

For details on the status codes of the request for this operation, see the description on HTTP status codes.

Coding example

```
curl -v -H "Accept:application/json" -H "Content-Type:application/json" -H
"Authorization:Session d7b673af189048468c5af9bcf3bbbb6f" -X DELETE
https://192.0.2.100/ConfigurationManager/v1/objects/user-groups/devGroup
```

Getting a list of users

The following request gets a list of user information registered on the target storage system.

Execution permission

Security Administrator (View Only)

Request line

```
GET base-URL/v1/objects/users
```

Request message**Object ID**

None.

Query parameters

None.

Body

None.

Response message**Body**

```
{
  "data": [
    {
```

```

    "userObjectId": "devUser",
    "userId": "devUser",
    "authentication": "local",
    "userGroupNames": [
      "Audit Log Administrator (View Only) User Group",
      "Storage Administrator (View & Modify) User Group"
    ],
    "isBuiltIn": false,
    "isAccountStatus": true
  },
  {
    "userObjectId": "adminUser",
    "userId": "adminUser",
    "authentication": "local",
    "userGroupNames": [
      "Administrator User Group"
    ],
    "isBuiltIn": false,
    "isAccountStatus": true
  }
]
}

```

| Attribute | Type | Description |
|-----------------|----------|--|
| userObjectId | string | Object ID of the user ID If the user ID contains a reserved character defined in RFC 3986, the encoded character string is output. |
| userId | string | User ID |
| userGroupNames | string[] | User group name |
| isBuiltIn | boolean | Whether the user account is built-in <ul style="list-style-type: none"> ▪ true: Indicates a built-in user account ▪ false: Indicates that the account is created by the user |
| isAccountStatus | boolean | Status of the user account <ul style="list-style-type: none"> ▪ true: The user account is valid ▪ false: The user account is invalid |

| Attribute | Type | Description |
|----------------|--------|--|
| authentication | string | Set authentication <ul style="list-style-type: none"> ▪ <code>local</code>: Authorized by the storage system ▪ <code>external</code>: Authorized by the external authentication server |

Status codes

For details on the status codes of the request for this operation, see the description on HTTP status codes.

Coding example

```
curl -v -H "Accept:application/json" -H "Content-Type:application/json" -H
"Authorization:Session d7b673af189048468c5af9bcf3b66b6f" -X GET https://
192.0.2.100/ConfigurationManager/v1/objects/users
```

Getting information about a specific user

The following request gets information about the specified user.

Execution permission

Security Administrator (View Only)

Request line

```
GET base-URL/v1/objects/users/object-ID
```

Request message

Object ID

Specify the `userObjectId` value obtained by getting information about the user.

| Attribute | Type | Description |
|---------------------------|--------|--|
| <code>userObjectId</code> | string | (Required) Object ID of the user ID The name is case sensitive. |

Query parameters

None.

Body

None.

Response message**Body**

```
{
  "userObjectId": "devUser",
  "userId": "devUser",
  "authentication": "local",
  "userGroupNames": [
    "Audit Log Administrator (View Only) User Group",
    "Storage Administrator (View & Modify) User Group"
  ],
  "isBuiltIn": false,
  "isAccountStatus": true
}
```

| Attribute | Type | Description |
|-----------------|----------|--|
| userObjectId | string | Object ID of the user ID If the user ID contains a reserved character defined in RFC 3986, the encoded character string is output. |
| userId | string | User ID |
| userGroupNames | string[] | User group name |
| isBuiltIn | boolean | Whether the user account is built-in <ul style="list-style-type: none"> ▪ <code>true</code>: Indicates a built-in user account ▪ <code>false</code>: Indicates that the account is created by the user |
| isAccountStatus | boolean | Status of the user account <ul style="list-style-type: none"> ▪ <code>true</code>: The user account is valid ▪ <code>false</code>: The user account is invalid |

| Attribute | Type | Description |
|----------------|--------|--|
| authentication | string | Set authentication <ul style="list-style-type: none"> ▪ <code>local</code>: Authorized by the storage system ▪ <code>external</code>: Authorized by the external authentication server |

Status codes

For details on the status codes of the request for this operation, see the description on HTTP status codes.

Coding example

```
curl -v -H "Accept:application/json" -H "Content-Type:application/json" -H
"Authorization:Session d7b673af189048468c5af9bcf3b66b6f" -X GET https://
192.0.2.100/ConfigurationManager/v1/objects/users/devUser
```

Creating a user account

The following request creates a user account and assigns the user to user groups where appropriate permissions are specified. User accounts created by using the REST API can be used in Hitachi Device Manager - Storage Navigator.



Note:

If you locked any resources of the target storage system by using the REST API, you will not be able to use this API function. In such cases, unlock the resources before running the API function.

Execution permission

Security Administrator (View & Modify)

Request line

```
POST base-URL/v1/objects/users
```

Request message

Object ID

None.

Query parameters

None.

Body

```

{
  "userId": "devUser",
  "authentication": "local",
  "userPassword": "devPassword",
  "userGroupNames": [
    "Audit Log Administrator (View Only) User Group",
    "Storage Administrator (View & Modify) User Group"
  ]
}

```

| Attribute | Type | Description |
|----------------|----------|--|
| userId | string | (Required) User ID For details about the number of characters that can be specified for user IDs and the characters that can be used, see the description about input rules for user IDs and passwords. |
| userPassword | string | (Optional) Password The password cannot be specified if the <code>authentication</code> attribute is <code>external</code> . For details about the number of characters that can be specified for passwords and the characters that can be used, see the description about input rules for user IDs and passwords. |
| userGroupNames | string[] | (Required) User group name Specify a name consisting of 1 to 64 characters. You can specify up to 8 group names. |
| authentication | string | (Required) Set authentication <ul style="list-style-type: none"> ▪ <code>local</code>: Authorized by the storage system ▪ <code>external</code>: Authorized by the external authentication server |

Response message**Body**

A job object is returned. For details on attributes other than `affectedResources`, see the section explaining job objects.

| Attribute | Description |
|--------------------------------|-------------------------|
| <code>affectedResources</code> | URL of the created user |

Status codes

For details on the status codes of the request for this operation, see the description on HTTP status codes.

Coding example

```
curl -v -H "Accept:application/json" -H "Content-Type:application/json" -H
"Authorization:Session d7b673af189048468c5af9bcf3b6bb6f" -X POST --data-
binary @./InputParameters.json https://192.0.2.100/ConfigurationManager/v1/
objects/users/
```

Changing the password of the user

The following request changes the password of a user account that performs operations on the storage system resources. The password cannot be changed for the user who is authorized by the external authentication server.

**Note:**

If you locked any resources of the target storage system by using the REST API, you will not be able to use this API function. In such cases, unlock the resources before running the API function.

Execution permission

Security Administrator (View & Modify)

Request line

```
PATCH base-URL/v1/objects/users/object-ID
```

Request message**Object ID**

Specify the `userObjectId` value obtained by getting information about the user.

| Attribute | Type | Description |
|--------------|--------|--|
| userObjectId | string | (Required) Object ID of the user ID The name is case sensitive. |

Query parameters

None.

Body

```
{
  "userPassword": "userPass"
}
```

| Attribute | Type | Description |
|--------------|--------|--|
| userPassword | string | (Required) New password For details about the number of characters that can be specified for passwords and the characters that can be used, see the description about input rules for user IDs and passwords. |

Response message**Body**

A job object is returned. For details on attributes other than `affectedResources`, see the section explaining job objects.

| Attribute | Description |
|-------------------|--|
| affectedResources | URL of the user whose password was changed |

Action template

None.

Status codes

For details on the status codes of the request for this operation, see the description on HTTP status codes.

Coding example

```
curl -v -H "Accept:application/json" -H "Content-Type:application/json" -H
"Authorization:Session d7b673af189048468c5af9bcf3b6bb6f" -X PATCH
https://192.0.2.100/ConfigurationManager/v1/objects/users/devUser
```

Adding users to user groups

To add a user to a user group, assign the user group to the user object.

**Note:**

If you locked any resources of the target storage system by using the REST API, you will not be able to use this API function. In such cases, unlock the resources before running the API function.

Execution permission

Security Administrator (View & Modify)

Request line

```
POST base-URL/v1/objects/users/object-ID/actions/add-user-group/invoke
```

Request message**Object ID**

Specify the `userObjectId` value obtained by getting information about the user.

| Attribute | Type | Description |
|---------------------------|--------|--|
| <code>userObjectId</code> | string | (Required) Object ID of the user ID The name is case sensitive. |

Query parameters

None.

Body

```
{
  "parameters": {
    "userGroupNames": [
      "System User Group"
    ]
  }
}
```

| Attribute | Type | Description |
|----------------|----------|--|
| userGroupNames | string[] | (Required) User group name Specify a name consisting of 1 to 64 characters. One user can belong to a maximum of You can specify up to 8 user groups. |

Response message

Body

A job object is returned. For details on attributes other than `affectedResources`, see the section explaining job objects.

| Attribute | Description |
|-------------------|---|
| affectedResources | URL of the user who was added to the user group |

Action template

```
GET base-URL/v1/objects/users/object-ID/actions/add-user-group
```

Status codes

For details on the status codes of the request for this operation, see the description on HTTP status codes.

Coding example

To get an action template:

```
curl -v -H "Accept:application/json" -H "Content-Type:application/json" -H
"Authorization:Session d7b673af189048468c5af9bcf3b6bb6f" -X GET https://
192.0.2.100/ConfigurationManager/v1/objects/users/devUser/actions/add-user-
group
```

To run the request after getting an action template:

```
curl -v -H "Accept:application/json" -H "Content-Type:application/json" -H
"Authorization:Session d7b673af189048468c5af9bcf3b6bb6f" --data-binary @./
InputParameters.json -X POST https://192.0.2.100/ConfigurationManager/v1/
objects/users/devUser/actions/add-user-group/invoke
```

Removing users from user groups

To remove a user from a user group, specify the user group that is associated with that user, and then release that user group from the user object. If only one user group is associated with a particular user, the user cannot be removed from that user group.



Note:

If you locked any resources of the target storage system by using the REST API, you will not be able to use this API function. In such cases, unlock the resources before running the API function.

Execution permission

Security Administrator (View & Modify)

Request line

POST *base-URL/v1/objects/users/object-ID/actions/remove-user-group/invoke*

Request message

Object ID

Specify the `userObjectId` value obtained by getting information about the user.

| Attribute | Type | Description |
|---------------------------|--------|--|
| <code>userObjectId</code> | string | (Required) Object ID of the user ID The name is case sensitive. |

Query parameters

None.

Body

```
{
  "parameters": {
    "userGroupNames": [
      "System User Group"
    ]
  }
}
```

| Attribute | Type | Description |
|-----------------------------|----------|----------------------------|
| <code>userGroupNames</code> | string[] | (Required) User group name |

| Attribute | Type | Description |
|-----------|------|--|
| | | Specify a name consisting of 1 to 64 characters. One user can belong to a maximum of You can specify up to 8 user groups. |

Response message

Body

A job object is returned. For details on attributes other than `affectedResources`, see the section explaining job objects.

| Attribute | Description |
|--------------------------------|---|
| <code>affectedResources</code> | URL of the user who was removed from the user group |

Action template

```
GET base-URL/v1/objects/users/object-ID/actions/remove-user-group
```

Status codes

For details on the status codes of the request for this operation, see the description on HTTP status codes.

Coding example

To get an action template:

```
curl -v -H "Accept:application/json" -H "Content-Type:application/json" -H
"Authorization:Session d7b673af189048468c5af9bcf3bbbb6f" -X GET https://
192.0.2.100/ConfigurationManager/v1/objects/users/devUser/actions/remove-
user-group
```

To run the request after getting an action template:

```
curl -v -H "Accept:application/json" -H "Content-Type:application/json" -H
"Authorization:Session d7b673af189048468c5af9bcf3bbbb6f" --data-binary @./
InputParameters.json -X POST https://192.0.2.100/ConfigurationManager/v1/
objects/users/devUser/actions/remove-user-group/invoke
```

Deleting a user account

The following request deletes unnecessary user accounts. Built-in user accounts of the storage system cannot be deleted.



Note:

If you locked any resources of the target storage system by using the REST API, you will not be able to use this API function. In such cases, unlock the resources before running the API function.

Execution permission

Security Administrator (View & Modify)

Request line

```
DELETE base-URL/v1/objects/users/object-ID
```

Request message

Object ID

Specify the `userObjectId` value obtained by getting information about the user.

| Attribute | Type | Description |
|---------------------------|--------|--|
| <code>userObjectId</code> | string | (Required) Object ID of the user ID The name is case sensitive. |

Query parameters

None.

Body

None.

Response message

Body

A job object is returned. For details on attributes other than `affectedResources`, see the section explaining job objects.

| Attribute | Description |
|--------------------------------|---------------------------------|
| <code>affectedResources</code> | URL of the deleted user account |

Status codes

For details on the status codes of the request for this operation, see the description on HTTP status codes.

Coding example

```
curl -v -H "Accept:application/json" -H "Content-Type:application/json" -H  
"Authorization:Session d7b673af189048468c5af9bcf3bbbb6f" -X DELETE  
https://192.0.2.100/ConfigurationManager/v1/objects/users/devUser
```

Chapter 4: Parity group management

This chapter describes how to manage parity groups by using the REST API.

Overview of a parity group

A parity group is a set of physical drives that configure a RAID in a storage system.

A logical storage area extracted from a parity group is used as an LDEV (basic volume). To create an LDEV to be used for operations such as volume allocation or pool creation, you need to create a parity group in advance.

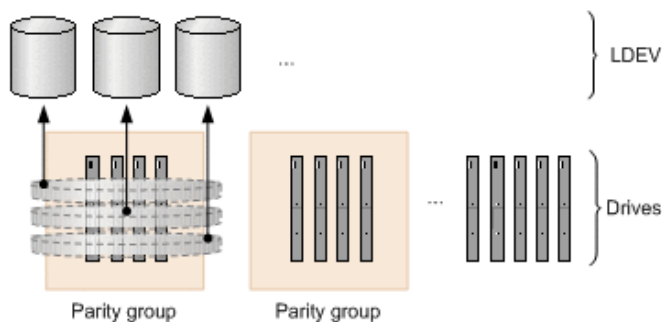

Parity group operations performed by the REST API vary depending on the type of storage system.

For VSP E series

- Creating a parity group

You can create a parity group when installing a new storage system or adding drives. You can configure a distributed parity group, or specify settings to encrypt a parity group or specify copy-back mode.
- Changing the drive settings

You can assign a specified drive as a spare drive, or release the assignment. The spare drive is used when a failure occurs in a drive that configures a parity group.
- Formatting a parity group

You can format all volumes created from a parity group. When you create multiple volumes at the time a new storage system is installed or drives are added, you can collectively format the volumes.
- Deleting a parity group

You can delete a parity group. If the specified parity group is a parity group making up a distributed parity group, all concatenated parity groups are deleted.

For VSP G350, G370, G700, G900, VSP F350, F370, F700, F900

- **Creating a parity group**
You can create a parity group when installing a new storage system or adding drives. You can configure a distributed parity group, or specify settings to encrypt a parity group or specify copy-back mode.
- **Changing the drive settings**
You can assign a specified drive as a spare drive, or release the assignment. The spare drive is used when a failure occurs in a drive that configures a parity group.
- **Changing the accelerated compression setting of a parity group**
You can enable or disable the accelerated compression setting for a parity group for which the accelerated compression function is supported.
- **Formatting a parity group**
You can format all volumes created from a parity group. When you create multiple volumes at the time a new storage system is installed or drives are added, you can collectively format the volumes.
- **Deleting a parity group**
You can delete a parity group. If the specified parity group is a parity group making up a distributed parity group, all concatenated parity groups are deleted.

For VSP 5000 series

- **Changing the accelerated compression setting of a parity group**
You can enable or disable the accelerated compression setting for a parity group for which the accelerated compression function is supported.
- **Formatting a parity group**
You can format all volumes created from a parity group. When you create multiple volumes at the time a new storage system is installed or drives are added, you can collectively format the volumes.

For details on parity groups, see the *Provisioning Guide*, or the *Provisioning Guide for Open Systems*.

Getting information about parity groups

The following request obtains information about all parity groups.

**Note:**

If you are using SCM drives, see the usage notes in the manual for the relevant storage system.

Execution permission

Storage Administrator (View Only)

Request lineGET *base-URL/v1/objects/parity-groups***Request message****Object ID**

None.

Query parameters

You can filter execution results by the specified condition and also collect additional detailed information about parity groups.

- When filtering execution results

| Parameter | Type | Filtering condition |
|---------------|--------|---|
| clprId | int | (Optional) CLPR number |
| driveTypeName | string | (Optional) Drive type For VSP 5000 series: <ul style="list-style-type: none"> ▪ SAS ▪ SSD (MLC) ▪ SSD (FMC) ▪ SSD ▪ SCM For VSP E series: <ul style="list-style-type: none"> ▪ SSD For VSP G350, G370, G700, G900, VSP F350, F370, F700, F900: <ul style="list-style-type: none"> ▪ SAS ▪ SSD (MLC) ▪ SSD (FMC) ▪ SSD (RI) |
| driveSpeed | int | (Optional) Drive rotation speed (rpm) |

- When collecting additional detailed information

| Parameter | Type | Description |
|----------------|--------|--|
| detailInfoType | string | <p>(Optional) Type of information to be collected</p> <p>To specify multiple values, separate the values by using commas.</p> <p>This parameter can be used together with the parameter for filtering execution results.</p> <ul style="list-style-type: none"> ▪ FMC <p>For the parity groups whose drive type is <code>SSD (FMC)</code>, add detailed information about accelerated compression.</p> <ul style="list-style-type: none"> ▪ class <p>Adds additional information from the storage system's cache.</p> <p>You can specify this item for VSP 5000 series.</p> <p>To get up-to-date information, you must run the API request that refreshes the storage system's cache before running this request. For details, see "Updating the cache of storage system configuration information".</p> |

Body

None.

Response message**Body**

```
{
  "data" : [
    {
      "parityGroupId" : "1-1",
      "numOfLdevs" : 267,
      "usedCapacityRate" : 96,
      "availableVolumeCapacity" : 24,
      "raidLevel" : "RAID5",
      "raidType" : "3D+1P",
      "clprId" : 0,
      "driveType" : "DKR5C-K300SS",
      "driveTypeName" : "SAS",
      "driveSpeed" : 15000,
      "totalCapacity" : 805,
    }
  ]
}
```



```

    "physicalCapacity" : 805,
    "availablePhysicalCapacity" : 24,
    "isAcceleratedCompressionEnabled" : false,
    "availableVolumeCapacityInKB" : 26103552
  }, {
    "parityGroupId" : "1-2",
    "numOfLdevs" : 8,
    "usedCapacityRate" : 3,
    "availableVolumeCapacity" : 499,
    "raidLevel" : "RAID1",
    "raidType" : "2D+2D",
    "clprId" : 0,
    "driveType" : "DKR5C-K300SS",
    "driveTypeName" : "SAS",
    "driveSpeed" : 15000,
    "totalCapacity" : 518,
    "physicalCapacity" : 518,
    "availablePhysicalCapacity" : 499,
    "isAcceleratedCompressionEnabled" : false,
    "availableVolumeCapacityInKB" : 523737912
  }, {
    "parityGroupId" : "2-1",
    "numOfLdevs" : 90,
    "usedCapacityRate" : 88,
    "availableVolumeCapacity" : 191,
    "raidLevel" : "RAID6",
    "raidType" : "6D+2P",
    "clprId" : 0,
    "driveType" : "DKR5C-K300SS",
    "driveTypeName" : "SAS",
    "driveSpeed" : 15000,
    "totalCapacity" : 1610,
    "physicalCapacity" : 1610,
    "availablePhysicalCapacity" : 191,
    "isAcceleratedCompressionEnabled" : false,
    "availableVolumeCapacityInKB" : 201149952
  }
]
}

```

| Attribute | Type | Description |
|-------------------------|--------|--------------------------------|
| parityGroupId | string | Parity group number |
| numOfLdevs | int | Number of assigned LDEVs |
| usedCapacityRate | int | Usage rate of the parity group |
| availableVolumeCapacity | long | Available capacity (GB) |

| Attribute | Type | Description |
|-----------------------------|--------|---|
| | | The amount of free space is output. If the capacity is below 1 GB, the value is ignored and 0 is assumed. |
| availableVolumeCapacityInKB | long | Available capacity (KB) The amount of free space is output. |
| raidLevel | string | RAID level |
| raidType | string | RAID type |
| clprId | int | CLPR number |
| driveType | string | Code indicating the drive type of the drive belonging to the parity group |
| driveTypeName | string | Drive type of the drive belonging to the parity group |
| driveSpeed | int | Rotation speed (rpm) of the drive belonging to the parity group |
| totalCapacity | long | Logical capacity of the parity group (GB) If the accelerated compression setting is enabled, the expanded capacity is output. |
| physicalCapacity | long | Physical capacity of the parity group (GB) For this attribute, 1 GB is equal to 1,024 ³ bytes. If the value of this attribute is less than 1 GB, 0 is displayed. |
| availablePhysicalCapacity | long | Total available physical capacity of the parity group (GB) For this attribute, 1 GB is equal to 1,024 ³ bytes. If the value of this attribute is less than 1 GB, 0 is displayed. |

| Attribute | Type | Description |
|---------------------------------|---------|---|
| isAcceleratedCompressionEnabled | boolean | Value of the accelerated compression of the parity group <ul style="list-style-type: none"> ▪ <code>true</code>: Accelerated compression for the parity group is enabled. ▪ <code>false</code>: Accelerated compression for the parity group is disabled. |

If you obtained detailed information about accelerated compression

When the drive type of the parity group is `SSD (FMC)`, if you specify `FMC` for the `detailInfoType` query parameter and then run the request, the following additional information is obtained.

| Attribute | Type | Description |
|-----------------------|---------|---|
| totalPhysicalCapacity | long | An invalid value is displayed. |
| isExpandedSpaceUsed | boolean | Whether LDEVs in parity groups use the expanded area <ul style="list-style-type: none"> ▪ <code>true</code>: LDEVs use the expanded area ▪ <code>false</code>: LDEVs use the physical area or are not implemented |

If you run this request with `class` specified for `detailInfoType` in the query parameters, additional information from the storage system's cache is also obtained.

| Attribute | Type | Description |
|--------------------------|--------|---|
| diskAdapterPairId | int | DKB pair number of the parity group |
| largestAvailableCapacity | long | Maximum capacity of the non-volume areas in the parity group (KB) The maximum capacity of the continuously free areas is output. |
| emulationType | string | Emulation type |
| totalOpenVolumeCapacity | long | Total LDEV capacity of the open volumes in the parity group (KB) |

| Attribute | Type | Description |
|-------------------------------|------|---|
| unallocatedOpenVolumeCapacity | long | From among the open volumes in the parity group, the total capacity of volumes to which paths are not allocated (KB) |
| allocatedOpenVolumeCapacity | long | From among the open volumes in the parity group, the total capacity of volumes to which paths are allocated (KB) |
| allocatableOpenVolumeCapacity | long | From among the open volumes in the parity group, the total capacity of volumes to which paths can be allocated (KB) The total capacity of volumes that meet all of the following conditions is output. <ul style="list-style-type: none"> ▪ No path is allocated to the volume. ▪ The volume is not a pool volume. ▪ The volume is not a system disk. |
| reservedOpenVolumeCapacity | long | From among the open volumes in the parity group, the total capacity of volumes which are reserved (KB) The total capacity of volumes that meet all of the following conditions is output. <ul style="list-style-type: none"> ▪ No path is allocated to the volume. ▪ The volume is either a pool volume or a system disk. |
| totalUsablePhysicalCapacity | long | The capacity of the space that can be used for writing to the parity group or reading from the parity group (KB) This information is output if the accelerated compression function is supported for the parity group. |

Status codes

For details on the status codes of the request for this operation, see the description of HTTP status codes.

Coding example

```
curl -v -H "Accept:application/json" -H "Content-Type:application/json" -H "Authorization:Session d7b673af189048468c5af9bcf3b66b6f" -X GET https://192.0.2.100/ConfigurationManager/v1/objects/parity-groups
```

Getting information about a specific parity group

The following request gets information about a specific parity group by specifying the parity group number. You can get detailed information about individual parity groups.

Execution permission

Storage Administrator (View Only)

Request line

```
GET base-URL/v1/objects/parity-groups/object-ID
```

Request message

Object ID

Specify the `parityGroupId` value obtained by getting information about the parity group.

| Parameter | Type | Description |
|---------------|--------|--|
| parityGroupId | string | <p>(Required) Parity group number</p> <p>Specify concatenated parity groups in the same way as the above.</p> <p>If the concatenated parity groups are 1-3-1, 1-3-2, or 1-3-3, specify as follows:</p> <pre>"parityGroupId": "1-3"</pre> |

Query parameters

None.

Body

None.

Response message

Body

```
{
  "parityGroupId": "1-2",
  "numOfLdevs": 8,
  "usedCapacityRate": 3,
  "availableVolumeCapacity": 499,
  "raidLevel": "RAID1",
```

```

"raidType": "2D+2D",
"clprId": 0,
"driveType": "DKR5C-K300SS",
"driveTypeName": "SAS",
"driveSpeed": 15000,
"isCopyBackModeEnabled": true,
"isEncryptionEnabled": false,
"totalCapacity": 518,
"physicalCapacity": 518,
"availablePhysicalCapacity": 499,
"isAcceleratedCompressionEnabled": false,
"spaces": [
  {
    "partitionNumber": 0,
    "ldevId": 8672,
    "status": "NML",
    "lbaLocation": "0x000000000000",
    "lbaSize": "0x000000039180"
  }, {
    "partitionNumber": 1,
    "ldevId": 8673,
    "status": "NML",
    "lbaLocation": "0x000000039180",
    "lbaSize": "0x0000010a7000"
  }, ...
], ...
"availableVolumeCapacityInKB": 523737912
}

```

| Attribute | Type | Description |
|-----------------------------|--------|---|
| parityGroupId | string | Parity group number |
| numOfLdevs | int | Number of LDEVs in the parity group |
| usedCapacityRate | int | Usage rate of the parity group |
| availableVolumeCapacity | long | Available capacity (GB) The amount of free space is output. If the capacity is below 1 GB, the value is ignored and 0 is assumed. |
| availableVolumeCapacityInKB | long | Available capacity (KB) The amount of free space is output. |
| raidLevel | string | RAID level |
| raidType | string | RAID type |

| Attribute | Type | Description |
|---------------------------|---------|---|
| clprId | int | CLPR number |
| driveType | string | Code indicating the drive type of the drive belonging to the parity group is output. |
| driveTypeName | string | Drive type of the drive that belongs to the parity group |
| driveSpeed | int | Rotation speed (rpm) of the drive belonging to the parity group |
| isCopyBackModeEnabled | boolean | Value of the copy back mode setting of the parity group <ul style="list-style-type: none"> ▪ true: Copy back mode is enabled. ▪ false: Copy back mode is disabled. |
| isEncryptionEnabled | boolean | Value of the encryption setting of the parity group <ul style="list-style-type: none"> ▪ true: Encryption is enabled. ▪ false: Encryption is disabled. |
| totalCapacity | long | Logical capacity of the parity group (GB) |
| physicalCapacity | long | Physical capacity of the parity group (GB) For this attribute, 1 GB is equal to 1,024 ³ bytes. If the value of this attribute is less than 1 GB, 0 is displayed. |
| availablePhysicalCapacity | long | Total available physical capacity of the parity group (GB) For this attribute, 1 GB is equal to 1,024 ³ bytes. If the value of this attribute is less than 1 GB, 0 is displayed. |

| Attribute | Type | Description |
|---------------------------------|----------|--|
| isAcceleratedCompressionEnabled | boolean | Value of the accelerated compression setting of the parity group <ul style="list-style-type: none"> ▪ <code>true</code>: Accelerated compression for the parity group is enabled. ▪ <code>false</code>: Accelerated compression for the parity group is disabled. |
| spaces | object[] | The following attributes related to free space and the LDEV defined in the parity group are output: <ul style="list-style-type: none"> ▪ <code>partitionNumber</code> (long) Partition number of the partition created by partitioning the parity group ▪ <code>ldevId</code> (int) LDEV number ▪ <code>status</code> (string) LDEV status <ul style="list-style-type: none"> • <code>NML</code>: The LDEV is implemented, or the free space is determined. • <code>REG</code>: An LDEV is being created. • <code>DEL</code>: An LDEV is being deleted. ▪ <code>lbaLocation</code> (string) Starting location of the LBA of the partition in the parity group (in a multiple of 512 bytes) ▪ <code>lbaSize</code> (string) Size of the partition in the parity group (in a multiple of 512 bytes) |

Status codes

For details on the status codes of the request for this operation, see the description on HTTP status codes.

Coding example

```
curl -v -H "Accept:application/json" -H "Content-Type:application/json" -H
"Authorization:Session d7b673af189048468c5af9bcf3b6bb6f" -X GET https://
192.0.2.100/ConfigurationManager/v1/objects/parity-groups/1-1
```

Getting a list of drive information

The request below gets a list of drive information.

**Note:**

- If you are using SCM drives, see the usage notes in the manual for the relevant storage system.

Execution permission

Storage Administrator (View Only)

Request line

```
GET base-URL/v1/objects/drives
```

Request message**Object ID**

None.

Query parameters

You can filter the execution results by specifying conditions and obtain additional detailed information about the drive.

- To filter the execution results:

| Parameter | Type | Filter condition |
|---------------|--------|---|
| parityGroupId | string | (Optional) The parity group number of the parity group to which the drive belongs |
| usageType | string | (Optional) Purpose for which the drive is used |

| Parameter | Type | Filter condition |
|---------------|--------|---|
| | | <p>You can specify the following values as filter conditions:</p> <ul style="list-style-type: none"> ▪ DATA: Data drive ▪ SPARE: Spare drive ▪ FREE: Unused drive |
| driveTypeName | string | <p>(Optional) Drive type</p> <p>You can specify the following values as filter conditions:</p> <ul style="list-style-type: none"> ▪ SAS ▪ SSD (MLC) ▪ SSD (FMC) ▪ SSD ▪ SSD (RI) ▪ SCM <p>SSD can be specified only for VSP 5000 series or VSP E series storage systems.</p> <p>SSD (RI) can be specified only for VSP G350, G370, G700, G900 and VSP F350, F370, F700, F900 storage systems. You cannot specify this value for VSP E series.</p> <p>SCM can be specified only for VSP 5000 series storage systems.</p> |
| driveSpeed | int | (Optional) Drive rotation speed (rpm) |
| totalCapacity | long | <p>(Optional) Physical capacity of the drive (GB)</p> <p>For this attribute, 1 GB is equal to 1,000³ bytes.</p> |

- To obtain additional detailed information:

| Attribute | Type | Description |
|----------------|--------|---|
| detailInfoType | string | <p>(Optional) Type of information to be collected</p> <p>To specify multiple drive types, delimit them by using commas.</p> |

| Attribute | Type | Description |
|-----------|------|--|
| | | <p>You can use this parameter in combination with the query parameters that are used to filter the execution results.</p> <ul style="list-style-type: none"> ▪ <code>usedEnduranceIndicator</code> If the drive type is SSD (MLC), SSD (FMC), SSD, SSD (RI), or SCM, additional detailed information about the drive's life expectancy is collected. ▪ <code>usageType</code> Additional detailed information about the usage of the drive is collected. ▪ <code>class</code> Adds additional information from the storage system's cache. You can specify this item for VSP 5000 series. To get up-to-date information, you must run the API request that refreshes the storage system's cache before running this request. For details, see "Updating the cache of storage system configuration information". |

Body

None.

Response message**Body**

```
{
  "data": [
    {
      "driveLocationId": "0-0",
      "driveTypeName": "SAS",
      "driveSpeed": 10000,
      "totalCapacity": 600,
      "driveType": "DKR5D-J600SS",
      "usageType": "DATA",
      "status": "NML",
      "parityGroupId": "1-6",
    }
  ]
}
```

```

    "serialNumber": "123456789012345678901"
  },
  {
    "driveLocationId": "0-1",
    "driveTypeName": "SAS",
    "driveSpeed": 10000,
    "totalCapacity": 600,
    "driveType": "DKR5D-J600SS",
    "usageType": "DATA",
    "status": "NML",
    "parityGroupId": "1-6",
    "serialNumber": "123456789012345678902"
  },
  {
    "driveLocationId": "0-2",
    "driveTypeName": "SAS",
    "driveSpeed": 10000,
    "totalCapacity": 600,
    "driveType": "DKR5D-J600SS",
    "usageType": "DATA",
    "status": "NML",
    "parityGroupId": "1-6",
    "serialNumber": "123456789012345678903"
  },
  {
    "driveLocationId": "0-3",
    "driveTypeName": "SAS",
    "driveSpeed": 10000,
    "totalCapacity": 600,
    "driveType": "DKR5D-J600SS",
    "usageType": "DATA",
    "status": "NML",
    "parityGroupId": "1-6",
    "serialNumber": "123456789012345678904"
  }
]
}

```

| Attribute | Type | Description |
|-----------------|--------|--|
| driveLocationId | string | Drive location (location of the drive box) |
| driveTypeName | string | Drive type |
| driveSpeed | int | Drive rotation speed (rpm) |
| totalCapacity | long | Drive capacity (GB) |

| Attribute | Type | Description |
|---------------|--------|---|
| | | For this attribute, 1 GB is equal to 1,000 ³ bytes. |
| driveType | string | Drive type code |
| usageType | string | Purpose for which the drive is used <ul style="list-style-type: none"> ▪ DATA: Data drive ▪ SPARE: Spare drive ▪ FREE: Unused drive |
| status | string | Status of the drive <ul style="list-style-type: none"> ▪ NML: Normal ▪ WAR: Part of the drive is blocked ▪ CPY: Copying is in progress ▪ CPI: Copying is incomplete ▪ RSV: The spare drive cannot be used ▪ FAI: The drive is blocked because of a failure ▪ BLK: The drive is blocked because maintenance is being performed ▪ Unknown or UNK: The status is unknown |
| parityGroupId | string | Parity group number This item is hidden when the drive does not belong to any parity group. |
| serialNumber | string | Serial number of the drive |

The following is an example of the detailed information that can be output about the drive's life expectancy.

```
{
  "data": [
    {
      "driveLocationId": "4-0",
      "driveTypeName": "SSD(FMC)",
      "totalCapacity": 1600,
      "driveType": "NFHAE-Q1R6SS",
      "usageType": "DATA",
      "status": "NML",

```

```

    "parityGroupId": "3-1",
    "serialNumber": "12345670",
    "usedEnduranceIndicator": 0,
    "usedEnduranceIndicatorThreshold": 99,
    "usedEnduranceIndicatorWarningSIM": 95
  },
  {
    "driveLocationId": "4-1",
    "driveTypeName": "SSD (FMC)",
    "totalCapacity": 1600,
    "driveType": "NFHAE-Q1R6SS",
    "usageType": "DATA",
    "status": "NML",
    "parityGroupId": "3-1",
    "serialNumber": "12345671",
    "usedEnduranceIndicator": 0,
    "usedEnduranceIndicatorThreshold": 99,
    "usedEnduranceIndicatorWarningSIM": 95
  },
  {
    "driveLocationId": "4-2",
    "driveTypeName": "SSD (FMC)",
    "totalCapacity": 1600,
    "driveType": "NFHAE-Q1R6SS",
    "usageType": "DATA",
    "status": "NML",
    "parityGroupId": "3-1",
    "serialNumber": "12345672",
    "usedEnduranceIndicator": 0,
    "usedEnduranceIndicatorThreshold": 99,
    "usedEnduranceIndicatorWarningSIM": 95
  }
]
}

```

To obtain detailed information about the drive's life expectancy:

If the drive type is SSD (MLC), SSD (FMC), SSD, SSD (RI), or SCM, you can obtain the following information by executing the request with `usedEnduranceIndicator` specified for the `detailInfoType` query parameter.

| Attribute | Type | Description |
|-------------------------------------|------|--|
| <code>usedEnduranceIndicator</code> | int | Life expectancy of the drive (%) A value in the range from 0 to 100 is displayed. |

| Attribute | Type | Description |
|----------------------------------|------|--|
| | | A large value indicates that the drive is near the end of its life expectancy. |
| usedEnduranceIndicatorThreshold | int | Threshold value of the drive's life expectancy (%) If the value of the drive's life expectancy exceeds this value, data on the drive will be automatically copied to a spare drive. |
| usedEnduranceIndicatorWarningSIM | int | Threshold value of the warning SIM (%) If the value of the drive's life expectancy exceeds this value, error information (SIM) will be displayed. |

The following is an example of the detailed information that can be output about the drive usage.

```
{
  "data": [
    {
      "driveLocationId": "0-0",
      "driveTypeName": "SAS",
      "driveSpeed": 10000,
      "totalCapacity": 600,
      "driveType": "DKS5H-J600SS",
      "usageType": "DATA",
      "detailUsageType": "DATA",
      "status": "NML",
      "parityGroupId": "1-1",
      "serialNumber": "12345670"
    },
    {
      "driveLocationId": "0-1",
      "driveTypeName": "SAS",
      "driveSpeed": 10000,
      "totalCapacity": 600,
      "driveType": "DKS5H-J600SS",
      "usageType": "DATA",
      "detailUsageType": "DATA",
      "status": "NML",
      "parityGroupId": "1-1",
      "serialNumber": "12345671"
    },
    {
```

```

    "driveLocationId": "0-2",
    "driveTypeName": "SAS",
    "driveSpeed": 10000,
    "totalCapacity": 600,
    "driveType": "DKS5H-J600SS",
    "usageType": "DATA",
    "detailUsageType": "DATA",
    "status": "NML",
    "parityGroupId": "1-1",
    "serialNumber": "12345671"
  },
  {
    "driveLocationId": "0-3",
    "driveTypeName": "SAS",
    "driveSpeed": 10000,
    "totalCapacity": 600,
    "driveType": "DKS5H-J600SS",
    "usageType": "DATA",
    "detailUsageType": "DATA",
    "status": "NML",
    "parityGroupId": "1-1",
    "serialNumber": "12345671"
  }
]
}

```

To obtain detailed information about the drive usage:

You can obtain the following information by specifying `usageType` for the `detailInfoType` query parameter.

| Attribute | Type | Description |
|-----------------|--------|---|
| detailUsageType | string | Details about the usage of the drive <ul style="list-style-type: none"> ▪ DATA: Data drive ▪ SPARE: Spare drive ▪ FREE: Unused drive ▪ SWAP: the drive that is swapped a spare drive for a data drive ▪ RESERVE: the unused drive that is swapped a data drive for a spare drive |

If you run this request with `class` specified for `detailInfoType` in the query parameters, additional information from the storage system's cache is also obtained.

| Attribute | Type | Description |
|----------------------|------|------------------------------------|
| totalLogicalCapacity | long | Logical capacity of the drive (GB) |

Status codes

For details on the status codes of the request for this operation, see the description of HTTP status codes.

Coding example

```
curl -v -H "Accept:application/json" -H "Content-Type:application/json" -H
"Authorization:Session d7b673af189048468c5af9bcf3b6bb6f" -X GET https://
192.0.2.100/ConfigurationManager/v1/objects/drives
```

Getting information about a specific drive

The request below allows you to get information about a specific drive by specifying the drive location (the location of the drive box).

Execution permission

Storage Administrator (View Only)

Request line

```
GET base-URL/v1/objects/drives/object-ID
```

Request message

Object ID

Specify the `driveLocationId` value obtained by getting information about the drive list.

| Attribute | Type | Description |
|-----------------|--------|---|
| driveLocationId | string | (Required) Drive location (location of the drive box) |

Query parameters

None.

Body

None.

Response message**Body**

```
{
  "driveLocationId": "0-0",
  "driveTypeName": "SAS",
  "driveSpeed": 10000,
  "totalCapacity": 600,
  "driveType": "DKR5D-J600SS",
  "usageType": "DATA",
  "status": "NML",
  "parityGroupId": "1-6",
  "serialNumber": "123456789012345678901"
}
```

| Attribute | Type | Description |
|-----------------|--------|---|
| driveLocationId | string | Drive location |
| driveTypeName | string | Drive type |
| driveSpeed | int | Drive rotation speed (rpm) |
| totalCapacity | long | Drive capacity (GB) For this attribute, 1 GB is equal to 1,000 ³ bytes. |
| driveType | string | Drive type code |
| usageType | string | Purpose for which the drive is used <ul style="list-style-type: none"> ▪ DATA: Data drive ▪ SPARE: Spare drive ▪ FREE: Unused drive |
| status | string | Status of the drive <ul style="list-style-type: none"> ▪ NML: Normal ▪ WAR: Part of the drive is blocked ▪ CPY: Copying is in progress ▪ CPI: Copying is incomplete |

| Attribute | Type | Description |
|---------------|--------|--|
| | | <ul style="list-style-type: none"> ▪ RSV: The spare drive cannot be used ▪ FAI: The drive is blocked because of a failure ▪ BLK: The drive is blocked because maintenance is being performed ▪ Unknown or UNK: The status is unknown |
| parityGroupId | string | <p>The parity group number of the parity group to which the drive belongs</p> <p>This item is hidden when the drive does not belong to any parity group.</p> |
| serialNumber | string | Serial number of the drive |

Status codes

For details on the status codes of the request for this operation, see the description of HTTP status codes.

Coding example

```
curl -v -H "Accept:application/json" -H "Content-Type:application/json" -H "Authorization:Session d7b673af189048468c5af9bcf3bbbb6f" -X GET https://192.0.2.100/ConfigurationManager/v1/objects/drives/0-0
```

Creating a parity group

The request below creates a parity group.



Note:

You can use this API function for VSP E series, VSP G350, G370, G700, G900, VSP F350, F370, F700, F900.

Execution permission

Storage Administrator (Provisioning)

Request line

```
POST base-URL/v1/objects/parity-groups
```

Request message**Object ID**

None.

Query parameters

None.

Body

The following coding example creates a parity group:

```
{
  "parityGroupId": "2-10",
  "driveLocationIds": ["1-1", "1-2", "1-3", "1-4"],
  "raidType": "3D+1P",
  "isEncryptionEnabled": false,
  "isCopyBackModeEnabled": true,
  "isAcceleratedCompressionEnabled": true,
  "clprId": 1
}
```

The following coding example creates a distributed parity group by concatenating two parity groups:

```
{
  "concatenatedParityGroupIds": ["2-9", "2-10"],
  "driveLocationIds": ["1-1", "1-2", "1-3", "1-4", "1-5", "1-6", "1-7", "1-8"],
  "raidType": "2D+2D",
  "isEncryptionEnabled": false,
  "isCopyBackModeEnabled": true,
  "isAcceleratedCompressionEnabled": true,
  "clprId": 1
}
```

| Attribute | Type | Description |
|----------------------------|----------|--|
| parityGroupId | string | (Optional) Parity group number Specify the number in <i>gno-sgno</i> format. Be sure to specify the <code>parityGroupId</code> attribute or the <code>concatenatedParityGroupIds</code> attribute. |
| concatenatedParityGroupIds | string[] | (Optional) To configure a distributed parity group, specify the parity group numbers of concatenated parity groups. |

| Attribute | Type | Description |
|----------------------------------|-----------------------|---|
| | | <p>The concatenated parity groups will be created in the order in which the <code>driveLocationIds</code> attribute is specified.</p> <p>Be sure to specify the <code>parityGroupId</code> attribute or the <code>concatenatedParityGroupIds</code> attribute.</p> |
| <code>driveLocationIds</code> | <code>string[]</code> | <p>(Required) Drive location</p> <p>Specify the locations of the drives to be used to create to the parity group.</p> |
| <code>raidType</code> | <code>string</code> | <p>(Required) RAID type</p> <p>Specify one of the following values:</p> <ul style="list-style-type: none"> ▪ 2D+2D ▪ 3D+1P ▪ 4D+1P ▪ 6D+1P ▪ 7D+1P ▪ 6D+2P ▪ 12D+2P ▪ 14D+2P |
| <code>isEncryptionEnabled</code> | <code>boolean</code> | <p>(Optional) Specify whether to enable the encryption function for the parity group.</p> <ul style="list-style-type: none"> ▪ <code>true</code>: Enable the encryption function. ▪ <code>false</code>: Disable the encryption function. <p>You cannot specify <code>true</code> if you specify <code>true</code> for the <code>isAcceleratedCompressionEnabled</code> attribute.</p> <p>If you omit this item, <code>false</code> will be set.</p> |

| Attribute | Type | Description |
|---------------------------------|---------|---|
| isCopyBackModeEnabled | boolean | (Optional) Specify whether to enable copy back mode for the parity group. <ul style="list-style-type: none"> ▪ <code>true</code>: Enable copy back mode. ▪ <code>false</code>: Disable copy back mode. If you omit this item, <code>true</code> will be set. |
| isAcceleratedCompressionEnabled | boolean | (Optional) Specify whether to enable accelerated compression for the parity group. <ul style="list-style-type: none"> ▪ <code>true</code>: Enable accelerated compression. ▪ <code>false</code>: Disable accelerated compression. You cannot specify <code>true</code> if you specify <code>true</code> for the <code>isEncryptionEnabled</code> attribute. If you omit this item, <code>false</code> will be set. |
| clprId | int | (Optional) CLPR number Specify a CLPR number in the range from 0 to 31. If you omit this item, 0 will be set. |

Response message

Body

A job object is returned. For details on the attributes other than `affectedResources`, see the section explaining job objects.

| Attribute | Description |
|--------------------------------|---------------------------------|
| <code>affectedResources</code> | URL of the created parity group |

Status codes

The following table describes the meaning of the status code of the request for this operation. For details on other status codes, see the section explaining HTTP status codes.

| Status codes | Message | Description |
|--------------|----------|---|
| 409 | Conflict | The parity group is already created with the specified parity group number or the concatenated parity group number. |

Coding example

```
curl -v -H "Accept:application/json" -H "Content-Type:application/json" -H "Authorization:Session d7b673af189048468c5af9bcf3bbbb6f" -X POST --data-binary @./InputParameters.json https://192.0.2.100/ConfigurationManager/v1/objects/parity-groups
```

Changing the drive settings

The request below configures a drive. You can use this request to assign a specified drive as a spare drive and to release the assignment of a specified drive.



Note:

You can use this API function for VSP E series, VSP G350, G370, G700, G900, VSP F350, F370, F700, F900.

Execution permission

Storage Administrator (Provisioning)

Request line

```
PATCH base-URL/v1/objects/drives/object-ID
```

Request message

Object ID

Specify the `driveLocationId` value obtained by getting information about the drive list.

| Attribute | Type | Description |
|------------------------------|--------|---|
| <code>driveLocationId</code> | string | (Required) Drive location (location of the drive box) |

Query parameters

None.

Body

```
{
  "isSpareEnabled": false
}
```

| Attribute | Type | Description |
|----------------|---------|--|
| isSpareEnabled | boolean | (Required) Spare drive setting <ul style="list-style-type: none"> ▪ <code>true</code>: Assigns the specified drive as a spare drive. ▪ <code>false</code>: Releases the assignment as a spare drive. |

Response message**Body**

A job object is returned. For details on the attributes other than `affectedResources`, see the section explaining job objects.

| Attribute | Description |
|-------------------|--|
| affectedResources | URL of the drive whose setting was changed |

Status codes

For details on the status codes of the request for this operation, see the description of HTTP status codes.

Action template

None.

Coding example

```
curl -v -H "Accept:application/json" -H "Content-Type:application/json" -H
"Authorization:Session d7b673af189048468c5af9bcf3b6bb6f" -X PATCH --data-
binary @./InputParameters.json https://192.0.2.100/ConfigurationManager/v1/
objects/drives/0-0
```

Changing the accelerated compression setting of a parity group

The request below enables or disables accelerated compression for a parity group. You can use this API request for parity groups for which accelerated compression is supported.

**Note:**

You can use this API function for VSP 5000 series, VSP G350, G370, G700, G900, VSP F350, F370, F700, F900.

Execution permission

Storage Administrator (Provisioning)

Request line

```
PATCH base-URL/v1/objects/parity-groups/object-ID
```

Request message**Object ID**

Specify the `parityGroupId` value obtained by getting information about the parity group.

| Attribute | Type | Description |
|----------------------------|--------|--|
| <code>parityGroupId</code> | string | <p>(Required) Parity group number</p> <p>Specify concatenated parity groups in the same way as the above.</p> <p>If the concatenated parity groups are 1-3-1, 1-3-2, or 1-3-3, specify as follows:</p> <pre>"parityGroupId": "1-3"</pre> |

Query information

None.

Body

```
{
  "isAcceleratedCompressionEnabled": true
}
```

| Attribute | Type | Description |
|---------------------------------|---------|---|
| isAcceleratedCompressionEnabled | boolean | (Required) Specify whether to enable accelerated compression for the parity group. <ul style="list-style-type: none"> ▪ <code>true</code>: Enable accelerated compression. ▪ <code>false</code>: Disable accelerated compression. |

Response message

Body

A job object is returned. For details on the attributes other than `affectedResources`, see the section explaining job objects.

| Attribute | Description |
|--------------------------------|---|
| <code>affectedResources</code> | URL of the parity group whose setting was changed |

Status codes

For details on the status codes of the request for this operation, see the description of HTTP status codes.

Coding example

```
curl -v -H "Accept:application/json" -H "Content-Type:application/json" -H "Authorization:Session d7b673af189048468c5af9bcf3b66b6f" -X PATCH --data-binary @./InputParameters.json https://192.0.2.100/ConfigurationManager/v1/objects/parity-groups/1-7
```

Formatting a parity group

The request below formats all volumes created from a parity group. Before running this request, make sure that the status of each volume in the parity group is blocked (`BLK`).

Execution permission

Storage Administrator (Provisioning)

Request line

```
POST base-URL/v1/objects/parity-groups/object-ID/actions/format/invoke
```

Request message**Object ID**

Specify the `parityGroupId` value obtained by getting information about the parity group.

| Attribute | Type | Description |
|----------------------------|--------|--|
| <code>parityGroupId</code> | string | <p>(Required) Parity group number</p> <p>Specify concatenated parity groups in the same way as the above.</p> <p>If the concatenated parity groups are 1-3-1, 1-3-2, or 1-3-3, specify as follows:</p> <pre>"parityGroupId": "1-3"</pre> |

Query parameters

None.

Body

None.

Response message**Body**

A job object is returned. For details, see the section explaining job objects. This API function does not display the `affectedResources` attribute. Formatting is performed when the `state` attribute of the job object is `Succeeded`. To check whether the formatting of each volume is complete, use the following URL. For *parity-group-number*, specify the parity group number that was specified for the object ID.

```
GET base-URL/v1/objects/ldevs?parityGroupId=parity-group-number
```

If the status of each volume in the specified parity group is normal (NML), formatting is complete.

Action template

None.

Status codes

For details on the status codes of the request for this operation, see the description of HTTP status codes.

Coding example

```
curl -v -H "Accept:application/json" -H "Content-Type:application/json" -H
"Authorization:Session d7b673af189048468c5af9bcf3bbbb6f" -X POST https://
192.0.2.100/ConfigurationManager/v1/objects/parity-groups/1-7/actions/
format/invoke -d ""
```

Deleting a parity group

The request below deletes a parity group. If the specified parity group is concatenated with other parity groups, all of the concatenated parity groups are deleted.

**Note:**

You can use this API function for VSP E series, VSP G350, G370, G700, G900, VSP F350, F370, F700, F900.

Execution permission

Storage Administrator (Provisioning)

Request line

```
DELETE base-URL/v1/objects/parity-groups/object-ID
```

Request message**Object ID**

Specify the `parityGroupId` value obtained by getting information about the parity group.

| Attribute | Type | Description |
|---------------|--------|--|
| parityGroupId | string | <p>(Required) Parity group number</p> <p>Specify concatenated parity groups in the same way as the above.</p> <p>If the concatenated parity groups are 1-3-1, 1-3-2, or 1-3-3, specify as follows:</p> <pre>"parityGroupId": "1-3"</pre> |

Query parameters

None.

Body

None.

Response message**Body**

A job object is returned. For details on the attributes other than `affectedResources`, see the section explaining job objects.

| Attribute | Description |
|--------------------------------|---------------------------------|
| <code>affectedResources</code> | URL of the deleted parity group |

Status codes

For details on the status codes of the request for this operation, see the description of HTTP status codes.

Coding example

```
curl -v -H "Accept:application/json" -H "Content-Type:application/json" -H
"Authorization:Session d7b673af189048468c5af9bcf3b6666f" -X DELETE
https://192.0.2.100/ConfigurationManager/v1/objects/parity-groups/1-1
```

Chapter 5: Volume allocation

This chapter describes how to allocate volumes to hosts by using the REST API.

Overview of volume allocation

Volume allocation means setting LU paths to allow the host to access volumes in the storage system.

In the REST API, allocate a volume by performing the following procedure:

1. Create a volume that meets the host requirements.

You can either use a volume that meets the requirements from an existing LDEV or create an LDEV from the parity group or pool.

When the host is connected to the external storage system by using Universal Volume Manager, you can create an external volume from an existing external parity group (external volume group).

2. Configure a port.

Configure a host group or an iSCSI target for the storage system port. Register information about the host that is to access the LDEV in the host group or the iSCSI target.

Specify the host mode and host mode options according to the host type.

3. Set the LU path.

Setting the LU path between the LDEV and the port's host group or iSCSI target enables access from the host to the LDEV.

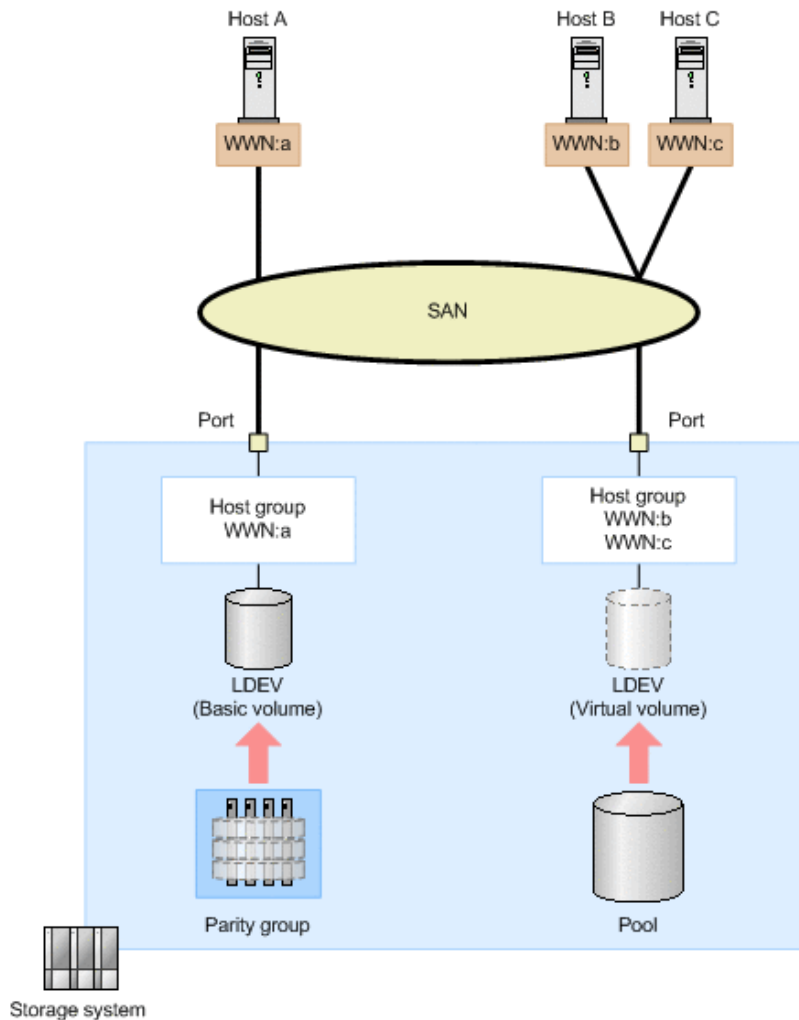

In the preceding figure, an LDEV is created from the parity group, and the LU path is set for the host group in which the WWN of host A is registered. In addition, another LDEV is created from the DP pool, and the LU path is set for the host group in which the WWNs of host B and host C are registered. By registering the WWNs of multiple hosts in the host group, you can apply the same settings for accessing the LDEV to the hosts at the same time.

For details about the requirements for creating volumes and how to specify settings for host groups or iSCSI targets, see the *Provisioning Guide for Open Systems*, or the *Provisioning Guide*.



Note:

For host groups that use external ports or initiator ports, do not run this request from the REST API.

Getting information about the capacity of a storage system

The following request gets information about the total capacity and the size of free space of all parity groups configured in the target storage system.

**Important:**

The size of free space (`freeSpace`) and the total capacity (`totalCapacity`) do not include the size of areas where, because of boundary limitations, volumes cannot be created. For this reason, after certain operations, such as those to create or delete volumes, the total capacity value might change. For details about volume capacity, see the *Provisioning Guide for Open Systems*, or the *Provisioning Guide*.

Execution permission

Storage Administrator (View Only)

Request line

```
GET base-URL/v1/objects/total-capacities/instance
```

Request message**Object ID**

Specify a value for `instance`. For objects that have only one instance, the value of `instance` is a fixed value (the object ID).

Query parameters

None.

Body

None.

Response message**Body**

```
{
  "internal": {
    "freeSpace": 30405195264,
    "totalCapacity": 34921689272
  },
  "external": {
    "freeSpace": 0,
    "totalCapacity": 142606336
  },
  "total": {
    "freeSpace": 30405195264,
    "totalCapacity": 35064295608
  }
}
```

| Attribute | Type | Description |
|-----------|--------|---|
| internal | object | <p>An attribute related to the capacity of internal volumes is output.</p> <ul style="list-style-type: none"> ▪ freeSpace (long) The amount of free space in which users can create volumes (KB) ▪ totalCapacity (long) The sums of the total capacity and the size of free space of all volumes created by the user (KB) |
| external | object | <p>An attribute related to the capacity of external volumes is output.</p> <p>If no external volumes are connected, the value 0 is output.</p> <ul style="list-style-type: none"> ▪ freeSpace (long) The amount of free space in which users can create volumes (KB) ▪ totalCapacity (long) The sums of the total capacity and the size of free space of all volumes created by the user (KB) |
| total | object | <p>An attribute related to the total capacity of internal volumes and external volumes is output.</p> <ul style="list-style-type: none"> ▪ freeSpace (long) The amount of free space in which users can create volumes (KB) ▪ totalCapacity (long) The sums of the total capacity and the size of free space of all volumes created by the user (KB) |

Status codes

For details on the status codes of the request for this operation, see the description on HTTP status codes.

Coding example

```
curl -v -H "Accept:application/json" -H "Content-Type:application/json" -H
"Authorization:Session d7b673af189048468c5af9bcf3b6bb6f" -X GET https://
192.0.2.100/ConfigurationManager/v1/objects/total-capacities/instance
```

Getting information about the total efficiency of a storage system

Obtain information about the saving efficiency for consumption of capacity (total efficiency) achieved by using the functions for increasing the usage efficiency of a storage system such as the capacity saving function (dedupe and compression), the accelerated compression function, the creation of backup data by using snapshots, and the virtualization of capacity by using Dynamic Provisioning.

Execution permission

Storage Administrator (View Only)

Request line

```
GET base-URL/v1/objects/total-efficiencies/instance
```

Request message**Object ID**

Specify *instance*. If an object has only one instance, the value for *instance* is the fixed value that specifies the object ID.

Query parameters

None.

Body

None.

Response message**Body**

```
{
  "isCalculated" : true,
  "totalRatio" : "8.46",
  "compressionRatio" : "1.18",
  "snapshotRatio" : "97.21",
  "provisioningRate" : "85",
  "calculationStartTime" : "2016-07-31T16:55:07Z",
  "calculationEndTime" : "2016-07-31T17:06:35Z",
```

```

"dedupeAndCompression" : {
  "totalRatio" : "1.47",
  "compressionRatio" : "1.08",
  "dedupeRatio" : "1.35",
  "reclaimRatio" : "1.00"
},
"acceleratedCompression" : {
  "totalRatio" : "1.11",
  "compressionRatio" : "1.10",
  "reclaimRatio" : "1.00"
}
}

```

| Attribute | Type | Description |
|----------------------|---------------|---|
| isCalculated | boolean | <p>Calculation status of the total efficiency</p> <p>This attribute indicates whether the total efficiency has been calculated.</p> <ul style="list-style-type: none"> ▪ <code>true</code>: The values have been calculated. ▪ <code>false</code>: The values have not been calculated. <p>Information about the other attributes will only be obtained if the value for this attribute is <code>true</code>.</p> |
| calculationStartTime | ISO8601string | <p>The date and time when the calculation of the total efficiency began (UTC)</p> <p>The local time of the storage system is displayed in YYYY-MM-DDThh:mm:ssZ format.</p> |
| calculationEndTime | ISO8601string | <p>The date and time when the calculation of the total efficiency ended (UTC)</p> <p>The local time of the storage system is displayed in YYYY-MM-DDThh:mm:ssZ format.</p> |
| totalRatio | string | <p>The total efficiency of the entire storage system[#]</p> <p>This does not include the size of metadata, garbage data, and other similar data generated by the storage system.</p> <p>If the volume for which the calculation is to be performed does not exist, a hyphen (-) indicating an invalid value is displayed.</p> <p>If the calculation cannot be performed for the volume because the volume is blocked or some other reason, the value from the previous calculation is displayed.</p> |

| Attribute | Type | Description |
|------------------|--------|---|
| | | After a volume is created from a pool and before data is written to the volume, the maximum value (92233720368547758.07) is displayed. |
| compressionRatio | string | <p>The efficiency of capacity saving performed by using the capacity saving function (dedupe and compression) or accelerated compression[#]</p> <p>This does not include the size of metadata, garbage data, and other similar data generated by the storage system.</p> <p>If the volume for which the calculation is to be performed does not exist, a hyphen (-) indicating an invalid value is displayed.</p> <p>If the calculation cannot be performed for the volume because the volume is blocked or some other reason, the value from the previous calculation is displayed.</p> |
| snapshotRatio | string | <p>The efficiency of capacity saving performed by using snapshots to back up data[#]</p> <p>This does not include the size of metadata, garbage data, and other similar data generated by the storage system.</p> <p>If the volume for which the calculation is to be performed does not exist, a hyphen (-) indicating an invalid value is displayed.</p> <p>If the calculation cannot be performed for the volume because the volume is blocked or some other reason, the value from the previous calculation is displayed.</p> |
| provisioningRate | string | <p>The percentage (%) of saving efficiency for consumption of capacity achieved by using Dynamic Provisioning to virtualize capacity</p> <p>This does not include the size of metadata, garbage data, and other similar data generated by the storage system.</p> <p>If the volume for which the calculation is to be performed does not exist, a hyphen (-) indicating an invalid value is displayed.</p> <p>If the calculation cannot be performed for the volume because the volume is blocked or some other reason, the value from the previous calculation is displayed.</p> |

| Attribute | Type | Description |
|------------------------|--------|---|
| dedupeAndCompression | object | <p>Attributes related to the efficiency of capacity saving performed by using the capacity saving function (dedupe and compression) are displayed.</p> <p>This does not include the size of metadata, garbage data, and other similar data generated by the storage system.</p> <p>If the volume for which the calculation is to be performed does not exist, a hyphen (-) indicating an invalid value is displayed.</p> <p>If the calculation cannot be performed for the volume because the volume is blocked or some other reason, the value from the previous calculation is displayed.</p> <ul style="list-style-type: none"> ▪ totalRatio (string) total efficiency of capacity saving performed by using the capacity saving function[#] ▪ compressionRatio (string) Efficiency of capacity saving performed by using compression[#] ▪ dedupeRatio (string) Efficiency of capacity saving performed by using deduplication (dedupe)[#] ▪ reclaimRatio (string) Efficiency of capacity saving performed by reclaiming the specified data pattern[#] |
| acceleratedCompression | object | <p>Attributes related to the efficiency of capacity saving performed by using accelerated compression are displayed.</p> <p>This does not include the size of metadata, garbage data, and other similar data generated by the storage system.</p> <p>If the volume for which the calculation is to be performed does not exist, a hyphen (-) indicating an invalid value is displayed.</p> |

| Attribute | Type | Description |
|-----------|------|--|
| | | <p>If the calculation cannot be performed for the volume because the volume is blocked or some other reason, the value from the previous calculation is displayed.</p> <ul style="list-style-type: none"> <li data-bbox="781 373 1424 489">▪ totalRatio (string) Total efficiency of capacity saving performed by using accelerated compression[#] <li data-bbox="781 520 1424 636">▪ compressionRatio (string) Efficiency of capacity saving performed by using compression[#] <li data-bbox="781 667 1424 783">▪ reclaimRatio (string) Efficiency of capacity saving performed by reclaiming the specified data pattern[#] |

[#]: This value represents the capacity before reduction as a ratio of the capacity after reduction, where the capacity after reduction is 1.

Status codes

For details on the status codes of the request for this operation, see the section explaining HTTP status codes.

Coding example

```
curl -v -H "Accept:application/json" -H "Content-Type:application/json" -H "Authorization:Session d7b673af189048468c5af9bcf3b66b6f" -X GET https://192.0.2.100/ConfigurationManager/v1/objects/total-efficiencies/instance
```

Getting volume information

The following request obtains information about multiple LDEVs. You can get information about consecutive LDEVs by specifying the number of the first LDEV and the number of LDEVs. You can also get information filtered by LDEV conditions (attributes) or resource group.

Execution permission

Storage Administrator (View Only)

Request lineGET *base-URL*/v1/objects/ldevs**Request message****Object ID**

None.

Query parameters

You can filter the execution result by specifying conditions, or request additional detailed volume information.

- When filtering the execution result

You can obtain information about 100 LDEVs by default, and information about 16,384 LDEVs by specifying the `count` parameter. If information about more than 16,384 LDEVs is obtained by specifying the `ldevOption` parameter or the `poolId` parameter, use the `headLdevId` parameter to obtain information about 16,385 or more LDEVs.

**Tip:**

Of the resources displayed by the filter, you can obtain information only about the resources for which you have been granted access permissions.

For example, if you specify 10 for the `count` parameter and you have permission to access all LDEVs, information about 10 LDEVs will be obtained. If you have permission to access specific LDEVs only, information will be obtained only about LDEVs for which you have been granted access permissions.

**Important:**

For a VSP E series, VSP G350, G370, G700, G900, VSP F350, F370, F700, F900 storage system, pay attention to the number of concurrent executions of this API request. For details, see "Implementing retry processing".

For details on query parameters that can be specified at the same time, see the following table showing the combinations of query parameters that can be specified.

| Parameter | Type | Filter Condition |
|-----------|------|---|
| count | int | (Optional) Specify a value from 1 to 16384 for the number of LDEVs for which information is to be obtained. |

| Parameter | Type | Filter Condition |
|------------|--------|--|
| | | If this parameter is omitted, information about 100 LDEVs will be obtained. |
| headLdevId | int | (Optional) Specify the number of the LDEV from which processing to get information is to start. The request gets information about the LDEVs in the ascending order of LDEV numbers, starting with the specified LDEV number. If this parameter is omitted, 0 is assumed. |
| ldevOption | string | (Optional) LDEV conditions for getting information You can specify the following conditions: <ul style="list-style-type: none"> ▪ <code>defined</code> Gets information about implemented LDEVs. ▪ <code>undefined</code> Gets information about LDEVs that are not implemented. ▪ <code>dpVolume</code> Gets information about DP volumes. ▪ <code>luMapped</code> Gets information about LDEVs for which LU paths are defined. ▪ <code>luUnmapped</code> Gets information about LDEVs for which LU paths are undefined. ▪ <code>externalVolume</code> Gets information about external volumes. If this is omitted, information about all types of LDEVs will be obtained. |
| poolId | int | (Optional) Pool number Gets information about the LDEVs that are associated with the specified pool. |

| Parameter | Type | Filter Condition |
|------------------------------|--------|---|
| | | <p>By using the <code>ldevOption</code> parameter when specifying conditions, the following information will be obtained:</p> <ul style="list-style-type: none"> ▪ If <code>dpVolume</code> is specified for the <code>ldevOption</code> parameter: Gets information about the DP volumes that are associated with the specified pool. ▪ If <code>luMapped</code> is specified for the <code>ldevOption</code> parameter: Gets information about LDEVs that are associated with the specified pool and that have one or more LU paths defined. ▪ If <code>luUnmapped</code> is specified for the <code>ldevOption</code> parameter: Gets information about LDEVs that are associated with the specified pool and that do not have one or more LU paths defined. <p>If you specify this parameter without specifying the <code>ldevOption</code> parameter, the processing gets information about the volumes that make up the pool (pool volumes).</p> <p>If <code>defined</code> or <code>undefined</code> is specified for the <code>ldevOption</code> parameter, you cannot specify this parameter.</p> |
| <code>resourceGroupId</code> | int | (Optional) ID of the resource group to which LDEVs for which information is to be obtained belong |
| <code>journalId</code> | int | (Optional) ID of the journal to which LDEVs for which information is to be obtained belong |
| <code>parityGroupId</code> | string | <p>(Optional) ID of the parity group to which LDEVs for which information is to be obtained belong</p> <p>Specify concatenated parity groups in the same way as the above.</p> <p>If the concatenated parity groups are 1-3-1, 1-3-2, or 1-3-3, specify as follows:</p> <pre>parityGroupId=1-3</pre> |

The following table shows the combinations of query parameters that can be specified.

| Parameter | count | head LdevId | Idev Option | poolId | resourceGroup Id | journal Id | parity Group Id |
|------------------|-------|-------------|-------------|--------|------------------|------------|-----------------|
| count | -- | Y | Y | Y | Y | Y | Y |
| head LdevId | Y | -- | Y | N | N | N | N |
| Idev Option | Y | Y | -- | Y# | Y | N | N |
| poolId | Y | N | Y# | -- | Y | N | N |
| resourceGroup Id | Y | N | Y | Y | -- | Y | Y |
| journal Id | Y | N | N | N | Y | -- | N |
| parity GroupId | Y | N | N | N | Y | N | -- |

#: If defined, undefined, or `externalVolume` is specified as the value of the `IdevOption` parameter, you cannot specify this parameter.

- When requesting additional detailed information

| Parameter | Type | Description |
|-----------------------------|--------|--|
| <code>detailInfoType</code> | string | <p>(Optional) Type of detailed information to be obtained</p> <p>You can use this parameter together with parameters that filter the execution results.</p> <p>The following values can be specified. To specify multiple values, separate the values by using commas.</p> <ul style="list-style-type: none"> ▪ <code>FMC</code> <p>Adds detailed information about accelerated compression for the LDEVs that belong to parity groups with drive type <code>SSD (FMC)</code>.</p> <ul style="list-style-type: none"> ▪ <code>externalVolume</code> <p>Adds detailed information about external volumes.</p> |

| Parameter | Type | Description |
|-----------|------|--|
| | | <ul style="list-style-type: none"> <li data-bbox="743 254 1084 281">▪ <code>virtualSerialNumber</code> Adds detailed information about virtual storage machines. <li data-bbox="743 390 943 417">▪ <code>savingInfo</code> Adds detailed information about the capacity saving function (dedupe and compression). <li data-bbox="743 541 862 569">▪ <code>class</code> Adds additional information from the storage system's cache. You can specify this item for VSP 5000 series. To get up-to-date information, you must run the API request that refreshes the storage system's cache before running this request. For details, see "Updating the cache of storage system configuration information". Immediately after you create an LDEV, if you specify <code>class</code> and at the same time specify <code>defined</code> in the query parameter <code>ldevOption</code> and then run the command, the volume status might be output as unimplemented. In such a case, wait a while and then run this request again. Alternatively, run the API request that updates the cache of storage system configuration information, and then run this request again. <li data-bbox="743 1262 829 1289">▪ <code>qos</code> Adds information about QoS settings. You can specify this item for VSP 5000 series, VSP G350, G370, G700, G900, VSP F350, F370, F700, F900. |

Query parameters can be specified as shown in the following examples.

- The following example retrieves information about 30 LDEVs from LDEV number 1234:

```
?headLdevId=1234&count=30
```

- The following example obtains information about 30 implemented LDEVs that belong to resource group number 5:

```
?ldevOption=defined&count=30&resourceGroupId=5
```

- The following example obtains information about 30 DP volumes that are associated with pool number 7, out of the LDEVs that belong to resource group number 5:

```
?ldevOption=dpVolume&pool=7&count=30&resourceGroupId=5
```

- The following example retrieves information about 30 LDEVs, for which detailed information about accelerated compression is added:

```
?detailInfoType=FMC&count=30
```

Body

None.

Response message

Body

For details on attributes to be obtained in the body of the response message, see the description of the API function for getting information about a specific volume.

```
{
  "data": [
    {
      "ldevId": 0,
      "clprId": 0,
      "emulationType": "OPEN-V-CVS",
      "byteFormatCapacity": "1.00 G",
      "blockCapacity": 2097152,
      "numOfPorts": 2,
      "ports": [
        {
          "portId": "CL1-A",
          "hostGroupNumber": 0,
          "hostGroupName": "1A-G00",
          "lun": 1
        },
        {

```

```

        "portId": "CL2-A",
        "hostGroupNumber": 0,
        "hostGroupName": "2A-G00",
        "lun": 1
    }
],
"attributes": [
    "CVS",
    "HDP"
],
"label": "JH-26216_DP",
"status": "NML",
"mpBladeId": 2,
"ssid": "0012",
"poolId": 63,
"numOfUsedBlock": 86016,
"isFullAllocationEnabled": false,
"resourceGroupId": 0,
"dataReductionStatus": "ENABLED",
"dataReductionMode": "compression_deduplication",
"dataReductionProcessMode": "post_process",
"isAluaEnabled": false
},
{
    "ldevId": 1,
    "clprId": 0,
    "emulationType": "OPEN-V-CVS",
    "byteFormatCapacity": "1.00 G",
    "blockCapacity": 2097152,
    "numOfPorts": 2,
    "ports": [
        {
            "portId": "CL1-A",
            "hostGroupNumber": 0,
            "hostGroupName": "1A-G00",
            "lun": 2
        },
        {
            "portId": "CL2-A",
            "hostGroupNumber": 0,
            "hostGroupName": "2A-G00",
            "lun": 2
        }
    ],
    "attributes": [
        "CVS",
        "HDP"
    ],
    "label": "JH-26216_DP",

```

```

    "status": "NML",
    "mpBladeId": 0,
    "ssid": "0012",
    "poolId": 63,
    "numOfUsedBlock": 0,
    "isFullAllocationEnabled": false,
    "resourceGroupId": 0,
    "dataReductionStatus": "DISABLED",
    "dataReductionMode": "disabled",
    "isAluaEnabled": false
  }
]
}

```

If the LDEV is not implemented:

| Attribute | Type | Description |
|-----------------|--------|--|
| ldevId | int | LDEV number |
| virtualLdevId | int | Virtual LDEV number If the virtual LDEV number is not set, 65534 (FF:FE) is output. If the reserved attribute of global-active device is set, 65535 (FF:FF) is output. |
| emulationType | string | NOT DEFINED (a value that indicates the LDEV is not implemented) is output. |
| ssid | string | SSID This attribute is output only if an SSID has been set. |
| resourceGroupId | int | ID of the resource group to which LDEVs for which information is to be obtained belong |

If the volume is an internal volume:

| Attribute | Type | Description |
|---------------|------|--|
| ldevId | int | LDEV number |
| virtualLdevId | int | Virtual LDEV number If the virtual LDEV number is not set, 65534 (FF:FE) is output. If the reserved attribute of global-active device is set, 65535 (FF:FF) is output. |

| Attribute | Type | Description |
|--------------------|----------|---|
| clprId | int | CLPR number |
| emulationType | string | The LDEV emulation type or the LDEV status information is output by using one of the following values: <ul style="list-style-type: none"> ▪ NOT_DEFINED: The LDEV is not implemented. ▪ DEFINING: The LDEV is being created. ▪ REMOVING: The LDEV is being removed. |
| byteFormatCapacity | string | Capacity of the LDEV The value is output to the second decimal place. |
| blockCapacity | long | Number of blocks of the LDEV |
| numOfPorts | int | Number of ports for which a path to the LDEV is defined |
| ports | object[] | For ports for which a path to the LDEV is defined the following attributes are output: <ul style="list-style-type: none"> ▪ portId (string) Port number ▪ hostGroupNumber (int) Host group number ▪ hostGroupName (string) Host group name <p>This request can obtain host group names that are no more than 16 characters. To obtain a host group name that exceeds 16 characters, run the API function for getting information about the host group or the iSCSI target.</p> <ul style="list-style-type: none"> ▪ lun (int) LUN |
| composingPoolId | int | Pool ID of the pool that includes the LDEV |
| attributes | string[] | LDEV attributes |

| Attribute | Type | Description |
|-------------------|--------|--|
| | | <p>The following attributes are output:</p> <ul style="list-style-type: none"> ▪ CMD: Command device (except for command devices for mainframes) ▪ CLUN: Cache LUN (DCR) ▪ CVS: CVS volume ▪ ALUN: Volume Migration volume ▪ ELUN: External volume ▪ OLG: OpenLDEV Guard volume ▪ VVOL: Virtual volume ▪ HORC: Pair volume (P-VOL or S-VOL) for remote copy (TrueCopy, TrueCopy for Mainframe, Universal Replicator, Universal Replicator for Mainframe) ▪ MRCF: ShadowImage volume (P-VOL or S-VOL) ▪ HTI: Thin Image volume (P-VOL or S-VOL) ▪ JNL: Journal volume ▪ HDP: HDP volume or Dynamic Provisioning for Mainframe volume ▪ HDT: HDT volume ▪ POOL: Pool volume ▪ QRD: Quorum disk ▪ ENCD: Encrypted disk ▪ SYSD: System disk ▪ TSE: HDP volume used for FCSE ▪ GAD: global-active device volume ▪ T10PI: Volume for which the T10 PI attribute is enabled ▪ RCMD: Remote command device |
| raidLevel | string | RAID level |
| raidType | string | Drive configuration |
| numOfParityGroups | int | Number of parity groups to which the LDEV belongs |

| Attribute | Type | Description |
|--------------------------------|----------|--|
| parityGroupIds | string[] | Parity group to which the LDEV belongs |
| driveType | string | Code indicating the drive type of the drive belonging to the LDEV |
| driveByteFormatCapacity | string | Capacity of the HDD The value is output to the second decimal place. |
| driveBlockCapacity | long | Number of blocks of the HDD |
| label | string | Label of the LDEV |
| status | string | Status of the LDEV <ul style="list-style-type: none"> ▪ NML: The LDEV is in normal status. ▪ BLK: The LDEV is blocked. ▪ BSY: The LDEV status is being changed. ▪ Unknown: The LDEV status is unknown (not supported). |
| operationType | string | The operation in progress: <ul style="list-style-type: none"> ▪ FMT: Formatting is in progress. ▪ QFMT: Quick formatting is in progress. ▪ CCOPY: Collection copying is in progress. ▪ CACCS: Collection access is in progress. ▪ SHRD: Shredding is in progress. ▪ ZPD: Pages are being released. ▪ SHRPL: Deletion from the pool is in progress. ▪ RLC: Pools are being reallocated. ▪ RBL: Pools are being rebalanced. |
| preparingOperationProgressRate | int | Progress of formatting or shredding For cases other than above, 100 is output. |
| mpBladeId | int | MP blade ID |
| ssid | string | SSID This attribute is output only if an SSID has been set. |
| resourceGroupId | int | ID of the resource group |

| Attribute | Type | Description |
|---------------|---------|---|
| isAluaEnabled | boolean | Whether the ALUA (Asymmetric Logical Unit Access) attribute is enabled <ul style="list-style-type: none"> <code>true</code>: The ALUA attribute is enabled. <code>false</code>: The ALUA attribute is disabled. |

If the volume is an external volume:

| Attribute | Type | Description |
|--------------------|-----------|---|
| ldevId | int | LDEV number |
| virtualLdevId | int | Virtual LDEV number If the virtual LDEV number is not set, 65534 (FF:FE) is output. If the reserved attribute of global-active device is set, 65535 (FF:FF) is output. |
| clprId | int | CLPR number |
| emulationType | string | The LDEV emulation type or the LDEV status information is output by using one of the following values: <ul style="list-style-type: none"> <code>NOT_DEFINED</code>: The LDEV is not implemented. <code>DEFINING</code>: The LDEV is being created. <code>REMOVING</code>: The LDEV is being removed. |
| byteFormatCapacity | string | Capacity of the LDEV The value is output to the second decimal place. |
| blockCapacity | long | Number of blocks of the LDEV |
| numOfPorts | int | Number of ports for which a path to the LDEV is defined |
| ports | object[] | For ports for which a path to the LDEV is defined the following attributes are output: <ul style="list-style-type: none"> <code>portId</code> (string) Port number <code>hostGroupNumber</code> (int) Host group number |

| Attribute | Type | Description |
|-----------------|----------|---|
| | | <ul style="list-style-type: none"> ▪ hostGroupName (string) Host group name <p>This request can obtain host group names that are no more than 16 characters. To obtain a host group name that exceeds 16 characters, run the API function for getting information about the host group or the iSCSI target.</p> ▪ lun (int) LUN |
| composingPoolId | int | Pool ID of the pool that includes the LDEV |
| attributes | string[] | <p>LDEV attributes</p> <p>The following attributes are output:</p> <ul style="list-style-type: none"> ▪ CMD: Command device (except for command devices for mainframes) ▪ CLUN: Cache LUN (DCR) ▪ CVS: CVS volume ▪ ALUN: Volume Migration volumes ▪ ELUN: External volume ▪ OLG: OpenLDEV Guard volume ▪ VVOL: Virtual volume ▪ HORC: Pair volume (P-VOL or S-VOL) for remote copy (TrueCopy, TrueCopy for Mainframe, Universal Replicator, Universal Replicator for Mainframe) ▪ MRCF: ShadowImage volume (P-VOL or S-VOL) ▪ HTI: Thin Image volume (P-VOL or S-VOL) ▪ JNL: Journal volume ▪ HDP: HDP volume or Dynamic Provisioning for Mainframe volume ▪ HDT: HDT volume ▪ POOL: Pool volume ▪ QRD: Quorum disk ▪ ENCD: Encrypted disk |

| Attribute | Type | Description |
|--------------------------------|--------|--|
| | | <ul style="list-style-type: none"> ▪ SYSD: System disk ▪ TSE: HDP volume used for FCSE ▪ GAD: global-active device volume ▪ MG: Volume used for data migration |
| label | string | Label of the LDEV |
| status | string | Status of the LDEV <ul style="list-style-type: none"> ▪ NML: The LDEV is in normal status. ▪ BLK: The LDEV is blocked. ▪ BSY: The LDEV status is being changed. ▪ Unknown: The LDEV status is unknown (not supported). |
| operationType | string | The operation in progress: <ul style="list-style-type: none"> ▪ FMT: Formatting is in progress. ▪ QFMT: Quick formatting is in progress. ▪ CCOPY: Collection copying is in progress. ▪ CACCS: Collection access is in progress. ▪ SHRD: Shredding is in progress. ▪ ZPD: Pages are being released. ▪ SHRPL: Deletion from the pool is in progress. ▪ RLC: Pools are being reallocated. ▪ RBL: Pools are being rebalanced. |
| preparingOperationProgressRate | int | Progress of formatting or shredding For cases other than above, 100 is output. |
| mpBladeId | int | MP blade ID |
| ssid | string | SSID This attribute is output only if an SSID has been set. |
| resourceGroupId | int | ID of the resource group |
| externalVendorId | string | Vendor information in SCSI information for the external volume |

| Attribute | Type | Description |
|---------------------------|-----------|---|
| externalProductId | string | Storage system that is connected using the external storage connection functionality of Universal Volume Manager |
| externalVolumeId | string | Device identification information in SCSI information for the external volume (output in hexadecimal number format) |
| externalVolumeIdString | string | Device identification information in SCSI information for the external volume (output in ASCII format) |
| numOfExternalPorts | int | Number of alternate paths |
| externalPorts | object[] | For the defined alternate paths, the following attributes are output: <ul style="list-style-type: none"> ▪ portId (string) Port number ▪ hostGroupNumber (int) This attribute is currently not in use. 0 is always displayed for this attribute. ▪ lun (int) LUN ▪ wwn (string) WWN |
| quorumDiskId | int | ID of the Quorum disk This attribute is output only if the external volume is a Quorum disk of the global-active device. |
| quorumStorageSerialNumber | string | Device number of the Quorum disk This attribute is output only if the external volume is a Quorum disk of the global-active device. |
| quorumStorageTypeId | string | ID for identifying the Quorum disk device This attribute is output only if the external volume is a Quorum disk of the global-active device. R7: Virtual Storage Platform R8: VSP G1000, VSP G1500, VSP F1500 R9: VSP 5000 series M7: HUS VM |

| Attribute | Type | Description |
|---------------|---------|---|
| | | M8: VSP E series, VSP Gx00 models, VSP Fx00 models |
| isAluaEnabled | boolean | Whether the ALUA attribute is enabled: <ul style="list-style-type: none"> ▪ <code>true</code>: The ALUA attribute is enabled. ▪ <code>false</code>: The ALUA attribute is disabled. |

If the volume is a virtual volume:

| Attribute | Type | Description |
|--------------------|--------|---|
| ldevId | int | LDEV number |
| virtualLdevId | int | Virtual LDEV number If the virtual LDEV number is not set, 65534 (FF:FE) is output. If the reserved attribute of global-active device is set, 65535 (FF:FF) is output. |
| clprId | int | CLPR number |
| emulationType | string | The LDEV emulation type or the LDEV status information is output by using one of the following values: <ul style="list-style-type: none"> ▪ <code>NOT_DEFINED</code>: The LDEV is not implemented. ▪ <code>DEFINING</code>: The LDEV is being created. ▪ <code>REMOVING</code>: The LDEV is being removed. |
| byteFormatCapacity | string | Capacity of the LDEV The value is output to the second decimal place. |
| blockCapacity | long | Number of blocks of the LDEV |
| numOfPorts | int | Number of ports for which a path to the LDEV is defined |

| Attribute | Type | Description |
|------------|-----------|---|
| ports | object[] | <p>For ports for which a path to the LDEV is defined the following attributes are output:</p> <ul style="list-style-type: none"> ▪ portId (string) Port number ▪ hostGroupNumber (int) Host group number ▪ hostGroupName (string) Host group name <p>This request can obtain host group names that are no more than 16 characters. To obtain a host group name that exceeds 16 characters, run the API function for getting information about the host group or the iSCSI target.</p> <ul style="list-style-type: none"> ▪ lun (int) LUN |
| attributes | string[] | <p>LDEV attributes</p> <p>The following attributes are output:</p> <ul style="list-style-type: none"> ▪ CMD: Command device (except for command devices for mainframes) ▪ CLUN: Cache LUN (DCR) ▪ CVS: CVS volume ▪ ALUN: Volume Migration volume ▪ ELUN: External volume ▪ OLG: OpenLDEV Guard volume ▪ VVOL: Virtual volume ▪ HORC: Pair volume (P-VOL or S-VOL) for remote copy (TrueCopy, TrueCopy for Mainframe , Universal Replicator, Universal Replicator for Mainframe) ▪ MRCF: ShadowImage volume (P-VOL or S-VOL) ▪ HTI: Thin Image volume (P-VOL or S-VOL) ▪ JNL: Journal volume |

| Attribute | Type | Description |
|---------------|--------|--|
| | | <ul style="list-style-type: none"> ▪ HDP: HDP volume or Dynamic Provisioning for Mainframe volume ▪ HDT: HDT volume ▪ POOL: Pool volume ▪ QRD: Quorum disk ▪ ENCD: Encrypted disk ▪ SYSD: System disk ▪ TSE: HDP volume used for FCSE ▪ GAD: global-active device volume ▪ DSD: Deduplication system data volume (fingerprint) ▪ DS: Deduplication system data volume (data store) ▪ MG: Volume used for data migration |
| label | string | Label of the LDEV |
| status | string | Status of the LDEV <ul style="list-style-type: none"> ▪ NML: The LDEV is in normal status. ▪ BLK: The LDEV is blocked. ▪ BSY: The LDEV status is being changed. ▪ Unknown: The LDEV status is unknown (not supported). |
| operationType | string | The operation in progress: <ul style="list-style-type: none"> ▪ FMT: Formatting is in progress. ▪ QFMT: Quick formatting is in progress. ▪ CCOPY: Collection copying is in progress. ▪ CACCS: Collection access is in progress. ▪ SHRD: Shredding is in progress. ▪ ZPD: Pages are being released. ▪ SHRPL: Deletion from the pool is in progress. ▪ RLC: Pools are being reallocated. ▪ RBL: Pools are being rebalanced. |

| Attribute | Type | Description |
|--------------------------------|---------|---|
| preparingOperationProgressRate | int | Progress of formatting or shredding For cases other than above, 100 is output. |
| mpBladeId | int | MP blade ID |
| ssid | string | SSID This attribute is output only if an SSID has been set. |
| poolId | int | ID of the pool with which the LDEV is associated <ul style="list-style-type: none"> ▪ For DP volumes: ID of the associated DP pool ▪ For virtual volumes for Thin Image: ID of the pool in which the snapshot data was created |
| numOfUsedBlock | long | Number of blocks used in the pool. This includes the number of blocks whose pages are reserved by the Full Allocation functionality. |
| resourceGroupId | int | ID of the resource group |
| snapshotPoolId | int | ID of the pool in which the snapshot data was created This attribute is output when the LDEV is both an S-VOL of a Thin Image pair and an HDP volume. |
| isRelocationEnabled | boolean | Status of relocation <ul style="list-style-type: none"> ▪ <code>true</code>: Relocation is enabled. ▪ <code>false</code>: Relocation is stopped. |
| tierLevel | string | Tiering policy used for relocation <ul style="list-style-type: none"> ▪ <code>all</code>: All tiers are used for relocation (level 0) ▪ <code>1 to 5</code>: Relocation is performed by following the tiering policy (levels 1 to 5) ▪ <code>6 to 31</code>: Relocation is performed by following the tiering policy (custom policy) |
| usedCapacityPerTierLevel1 | long | Capacity allocated to tier 1 (in MB) |
| usedCapacityPerTierLevel2 | long | Capacity allocated to tier 2 (in MB) |
| usedCapacityPerTierLevel3 | long | Capacity allocated to tier 3 (in MB) |

| Attribute | Type | Description |
|-------------------------------|---------|--|
| tierLevelForNewPageAllocation | string | <p>New page assignment tier</p> <ul style="list-style-type: none"> ▪ <code>H</code>: The page is allocated to a higher-level tier (High) ▪ <code>M</code>: The page is allocated to a middle-level tier (Middle) ▪ <code>L</code>: The page is allocated to a lower-level tier (Low) |
| tier1AllocationRateMin | int | Minimum capacity of tier 1 of the set tiering policy |
| tier1AllocationRateMax | int | Maximum capacity of tier 1 of the set tiering policy |
| tier3AllocationRateMin | int | Minimum capacity of tier 3 of the set tiering policy |
| tier3AllocationRateMax | int | Maximum capacity of tier 3 of the set tiering policy |
| fullAllocationCapacity | long | Capacity for which pages are reserved by the Full Allocation functionality (in MB) |
| isFullAllocationEnabled | boolean | <p>Whether pages are reserved by the Full Allocation functionality</p> <ul style="list-style-type: none"> ▪ <code>true</code>: The page reservation setting is enabled. ▪ <code>false</code>: The page reservation setting is disabled. |
| dataReductionMode | string | <p>Setting of the capacity saving function (dedupe and compression)</p> <ul style="list-style-type: none"> ▪ <code>compression</code>: The capacity saving function (compression) is enabled. ▪ <code>compression_deduplication</code>: The capacity saving function (compression and deduplication) is enabled. ▪ <code>disabled</code>: The capacity saving function (compression and deduplication) is disabled. |
| dataReductionProcessMode | string | <p>Capacity-saving mode</p> <ul style="list-style-type: none"> ▪ <code>post_process</code>: Post-process mode ▪ <code>inline</code>: Inline mode <p>This attribute is displayed for volumes for which the capacity saving function is enabled.</p> |

| Attribute | Type | Description |
|---------------------------|---------|--|
| dataReductionStatus | string | Status of the capacity saving function <ul style="list-style-type: none"> ENABLED: The capacity saving function is enabled. DISABLED: The capacity saving function is disabled. ENABLING: The capacity saving function is being enabled. REHYDRATING: The capacity saving function is being disabled. DELETING: The volumes for which the capacity saving function is enabled are being deleted. FAILED: An attempt to enable the capacity saving function failed. |
| dataReductionProgressRate | int | Progress rate of the capacity saving function (%) This attribute is output when one of the following is output for the dataReductionStatus attribute. ENABLING, REHYDRATING, DELETING |
| isAluaEnabled | boolean | Whether the ALUA attribute is enabled: <ul style="list-style-type: none"> true: The ALUA attribute is enabled. false: The ALUA attribute is disabled. |

If the volume is a Thin Image P-VOL:

In addition to the attributes output if the volume is an internal volume, the following attribute is obtained.

| Attribute | Type | Description |
|-------------------------------|------|---|
| usedCapacityForSnapshot | long | Capacity used for snapshots in a Thin Image P-VOL (in MB) The snapshot capacity that is allocated from the pool and used as data is output. For the root volume of a snapshot tree, the snapshot capacity of the root volume is output. |
| usedTotalCapacityForSnapshots | long | Capacity of all snapshots that are allocated from the pool used by the root volume (in MB) |

| Attribute | Type | Description |
|--|--------|---|
| | | <p>This attribute is output for VSP 5000 series.</p> <p>This attribute is output when a Thin Image root volume is used.</p> <p>This value includes the volume of metadata and garbage data generated by the storage system.</p> |
| garbageDataCapacityForSnapshot | long | <p>Volume of snapshot garbage data (in MB)</p> <p>This attribute is output for VSP 5000 series.</p> <p>This attribute is output when a Thin Image root volume is used, if the processing to delete snapshot garbage data is not in progress.</p> <p>If the volume is less than 1 MB, this value is rounded up.</p> |
| deletingGarbageDataStatusForSnapshot | string | <p>Deletion status of snapshot garbage data</p> <p>This attribute is output for VSP 5000 series.</p> <p>This attribute is output when a Thin Image root volume is used.</p> <ul style="list-style-type: none"> ▪ PROCESSING: The deletion processing is in progress ▪ STOPPING: The deletion process is stopped ▪ NONE: The deletion processing is not in progress |
| deletingGarbageDataProgressRateForSnapshot | int | <p>Progress of the processing for deleting snapshot garbage data (%)</p> <p>This attribute is output for VSP 5000 series.</p> <p>This attribute is output when a Thin Image root volume is used, if snapshot garbage data is in the process of being deleted.</p> |

If the drive type of the parity group to which the volumes belong is SSD (FMC):

Specify `FMC` for the `detailInfoType` query parameter, and then run the request to obtain additional detailed information for accelerated compression.

```
{
  "data": [
    {
      "ldevId": 280,
      ...
      "isExpandedSpaceUsed": true
    }
  ]
}
```

```

    }
  ]
}

```

| Attribute | Type | Description |
|---------------------|---------|--|
| isExpandedSpaceUsed | boolean | Indicates whether the LDEV uses the expanded area. <ul style="list-style-type: none"> ▪ <code>true</code>: The LDEV uses the expanded area. ▪ <code>false</code>: The LDEV uses the physical area. |

If the volume is an external volume:

Specify `externalVolume` for the `detailInfoType` query parameter, and then run the request to obtain additional detailed information for the external volume.

| Attribute | Type | Description |
|-----------------------------|--------|---|
| externalStorageSerialNumber | string | Serial number of the storage system that is connected using the external storage connection functionality of Universal Volume Manager |

If you execute the request with `virtualSerialNumber` specified for the `detailInfoType` query parameter, the request also obtains detailed information about the virtual storage machines.

| Attribute | Type | Description |
|---------------------|--------|--|
| virtualSerialNumber | string | Serial number of the virtual storage machine |
| virtualModel | string | Model name of the virtual storage machine |

If you run the request with `savingInfo` specified for the `detailInfoType` query parameter, the request also obtains detailed information about the capacity saving function for the volumes for which the capacity saving function is enabled.

```

{
  "data": [
    {
      "ldevId": 12,
      ...
      "dataReductionTotalSavingRatio": "2.44",
      "isDataReductionTotalSavingBlockAvailable": true,
      "dataReductionTotalSavingBlock": 13878844,
    }
  ]
}

```

```

    "dataReductionSavingBlockCompression": 12134812,
    "dataReductionSavingBlockDeduplication": 808078,
    "dataReductionSavingBlockReclaim": 1076144,
    "dataReductionSystemBlock": 140190,
    "dataReductionPreUsedBlock": 23489911,
    "dataReductionPoolBlock": 9611067
  }
]

```

| Attribute | Type | Description |
|--|---------|---|
| dataReductionTotalSavingRatio | string | <p>The ratio of volume capacity reduced by using the capacity reduction function</p> <p>The capacity before data reduction is displayed as a ratio of the capacity after data reduction, where the capacity after data reduction is assigned a value of 1.</p> |
| isDataReductionTotalSavingBlockAvailable | boolean | <p>Whether the size of the data can be reduced</p> <ul style="list-style-type: none"> <code>true</code>: The size of the data can be reduced. <p>If the value of this attribute is <code>true</code>, the size of the data that has been reduced is displayed for the <code>dataReductionTotalSavingBlock</code> attribute.</p> <ul style="list-style-type: none"> <code>false</code>: The size of the data cannot be reduced (for example, if the size of the data after data reduction is greater than the size of the data before data reduction). |
| dataReductionTotalSavingBlock | long | <p>Total number of blocks reduced by using the capacity saving function</p> <p>This value is displayed when the <code>isDataReductionTotalSavingBlockAvailable</code> attribute is set to <code>true</code>.</p> <p>This value includes the amount of zero data that was reduced and the volume of metadata and garbage data generated by the storage system.</p> |
| dataReductionSavingBlockCompression | long | <p>Number of blocks reduced by using the capacity saving function (compression)</p> <p>The value does not include the volume of metadata and garbage data generated by the storage system.</p> |

| Attribute | Type | Description |
|--|------|--|
| dataReductionSavingBlock Deduplication | long | Number of blocks reduced by using the capacity saving function (deduplication) The value does not include the volume of metadata and garbage data generated by the storage system. |
| dataReductionSavingBlock Reclaim | long | Number of blocks reduced by using the capacity saving function (reclaiming of the specified data pattern) The value does not include the volume of metadata and garbage data generated by the storage system. |
| dataReductionSystemBlock | long | Total number of blocks of system data (metadata and garbage data) used by the capacity saving function The value does not include the volume of metadata and garbage data in the deduplication system data volumes. |
| dataReductionPreUsedBlock | long | Number of blocks before data reduction |
| dataReductionPoolBlock | long | Number of blocks in the pool volume used by the volume |

If you run this request with `class` specified for `detailInfoType` in the query parameters, additional information from the storage system's cache is also obtained.

| Attribute | Type | Description |
|-------------------------|---------|---|
| isDataDirectMapping | boolean | Whether the data direct mapping attribute is enabled <ul style="list-style-type: none"> ▪ <code>true</code>: Enabled ▪ <code>false</code>: Disabled |
| dataDirectMappingLdevId | int | LDEV number of the volume mapped by using data direct mapping This information is output if a volume exists that is mapped by using data direct mapping. |

| Attribute | Type | Description |
|------------------------------------|---------|--|
| | | <p>This information is output when the value of the <code>isDataDirectMapping</code> attribute is <code>true</code>.</p> <ul style="list-style-type: none"> If the volume is an HDP volume: LDEV number of the pool volume If the volume is a pool volume: LDEV number of the HDP volume <p>If no volume mapped by using data direct mapping exists, <code>-1</code> is output, indicating an invalid value.</p> |
| <code>slotSize</code> | long | Slot size (KB) |
| <code>cacheResidencyMode</code> | string | <p>Cache residency mode</p> <p>Unknown is always output.</p> |
| <code>readOnly</code> | boolean | This attribute is currently not in use. <code>false</code> is always output. |
| <code>usedCapacity</code> | long | <p>Used capacity of the DP volume (KB)</p> <p>This information is output if the volume is a DP volume.</p> <p>The used capacity that is output includes the capacity for which pages are reserved.</p> |
| <code>relocationPriority</code> | string | <p>Relocation priority</p> <p>This information is output if the volume is an HDT volume.</p> <ul style="list-style-type: none"> Default: No priority is set. Prioritized: Data is relocated preferentially when tier relocation is performed. |
| <code>conglomerateLunDevice</code> | string | <p>Whether the volume is an ALU or an SLU</p> <ul style="list-style-type: none"> ALU SLU Unknown: Status unknown (unsupported) |
| <code>commandDevice</code> | object | Attributes related to the command device |

| Attribute | Type | Description |
|-----------------------|-----------|---|
| | | <p>This information is output when the volume is used as a command device.</p> <ul style="list-style-type: none"> ▪ isSecurityEnabled (boolean) Whether the security setting for the command device is enabled <ul style="list-style-type: none"> • <code>true</code>: Enabled • <code>false</code>: Disabled ▪ isUserAuthenticationEnabled (boolean) Whether the user authentication setting for the command device is enabled <ul style="list-style-type: none"> • <code>true</code>: Enabled • <code>false</code>: Disabled ▪ isDeviceGroupDefinitionEnabled (boolean) Whether the device group information authentication setting for the command device is enabled <ul style="list-style-type: none"> • <code>true</code>: Enabled • <code>false</code>: Disabled |
| externalDriveTypeName | string | <p>Drive type of the external volume</p> <ul style="list-style-type: none"> ▪ SAS ▪ SATA ▪ BD ▪ SSD ▪ SCM ▪ Unknown: Status unknown (unsupported) <p>If the information cannot be obtained, Unknown is output.</p> |
| guardStatuses | string[] | <p>Attribute related to access to the volume</p> <ul style="list-style-type: none"> ▪ Read/Write: The volume can be read and written to from all hosts. ▪ Read Only: The volume can be read, but cannot be written to, from all hosts. ▪ Protect: The volume cannot be read or written to from any host. |

| Attribute | Type | Description |
|-----------|------|---|
| | | <ul style="list-style-type: none"> ▪ <code>S-VOL Disable</code>: Access to the secondary volume is not permitted. ▪ <code>Invisible</code>: Invisible mode (Access via a SCSI command is not permitted.) ▪ <code>Zero Read Capacity</code>: Zero Read Capacity mode (0 is returned as the response to a SCSI command.) ▪ <code>Unknown</code>: Status unknown |

If you run this request with `qos` specified for `detailInfoType` in the query parameters, information about QoS settings is also obtained.

| Attribute | Type | Description |
|------------------|--------|---|
| <code>qos</code> | object | <p>Information about QoS settings</p> <p>If QoS settings are configured, the following information is output.</p> <ul style="list-style-type: none"> ▪ <code>upperIops</code> (long) Upper limit on the IOPS ▪ <code>upperTransferRate</code> (int) Upper limit on the amount of data that can be transferred per second (in MB) ▪ <code>upperAlertAllowableTime</code> (int) Amount of time to wait before issuing an alert when the IOPS or the amount of data transferred per second exceeds the upper limit for a continuous period of time (in seconds) ▪ <code>upperAlertTime</code> (ISO8601string) Time when the last alert was issued because the IOPS or the amount of data transferred per second had exceeded the upper limit for a continuous period of time (UTC) This parameter is output in the format YYYY-MM-DDThh:mm:ssZ. |

| Attribute | Type | Description |
|-----------|------|---|
| | | <ul style="list-style-type: none"> <li data-bbox="781 258 1422 457"> <p>▪ lowerIops (long)</p> <p>Lower limit on the IOPS</p> <p>This parameter is output if the storage system is VSP G350, G370, G700, G900, VSP F350, F370, F700, F900.</p> <li data-bbox="781 489 1422 720"> <p>▪ lowerTransferRate (int)</p> <p>Lower limit on the amount of data that can be transferred per second (in MB)</p> <p>This parameter is output if the storage system is VSP G350, G370, G700, G900, VSP F350, F370, F700, F900.</p> <li data-bbox="781 751 1422 1056"> <p>▪ lowerAlertAllowableTime (int)</p> <p>Amount of time to wait before issuing an alert when the IOPS or the amount of data transferred per second falls below the lower limit for a continuous period of time (in seconds)</p> <p>This parameter is output if the storage system is VSP G350, G370, G700, G900, VSP F350, F370, F700, F900.</p> <li data-bbox="781 1087 1422 1476"> <p>▪ lowerAlertTime (ISO8601string)</p> <p>Time when the last alert was issued because the IOPS or the amount of data transferred per second had fallen below the lower limit for a continuous period of time</p> <p>This parameter is output in the format YYYY-MM-DDThh:mm:ssZ.</p> <p>This parameter is output if the storage system is VSP G350, G370, G700, G900, VSP F350, F370, F700, F900.</p> <li data-bbox="781 1507 1422 1707"> <p>▪ responsePriority (int)</p> <p>Priority level of the I/O processing</p> <p>This parameter is output if the storage system is VSP G350, G370, G700, G900, VSP F350, F370, F700, F900.</p> |

| Attribute | Type | Description |
|-----------|------|--|
| | | <ul style="list-style-type: none"> <li data-bbox="771 252 1427 514"> <p>▪ targetResponseTime (int)</p> <p>Target response time (in milliseconds) based on the priority level (<code>responsePriority</code>)</p> <p>This parameter is output if the storage system is VSP G350, G370, G700, G900, VSP F350, F370, F700, F900.</p> <li data-bbox="771 518 1427 808"> <p>▪ responseAlertAllowableTime (int)</p> <p>Amount of time to wait before issuing an alert when the response time exceeds the target response time for a continuous period of time (in seconds)</p> <p>This parameter is output if the storage system is VSP G350, G370, G700, G900, VSP F350, F370, F700, F900.</p> <li data-bbox="771 812 1427 1209"> <p>▪ responseAlertTime (ISO8601string)</p> <p>Time when the last alert was issued because the response time had exceeded the target response time for a continuous period of time (UTC)</p> <p>This parameter is output in the format YYYY-MM-DDThh:mm:ssZ.</p> <p>This parameter is output if the storage system is VSP G350, G370, G700, G900, VSP F350, F370, F700, F900.</p> |

Status codes

For details on the status codes for the request of this operation, see the section explaining HTTP status codes.

Coding example

```
curl -v -H "Accept:application/json" -H "Content-Type:application/json" -H
"Authorization:Session d7b673af189048468c5af9bcf3b6bb6f" -X GET "https://
192.0.2.100/ConfigurationManager/v1/objects/ldevs?headLdevId=0&count=2"
```

Getting information about a specific volume

The following request gets information about a specific LDEV by specifying the LDEV number.

Execution permission

Storage Administrator (View Only)

Request lineGET *base-URL/v1/objects/ldevs/object-ID***Request message****Object ID**Specify the `ldevId` value obtained by getting information about volumes.

| Attribute | Type | Description |
|---------------------|------|---|
| <code>ldevId</code> | int | (Required) Specify the LDEV number with a decimal (base 10) number. |

Query parameters

None.

Body

None.

Response message**Body**

```
{
  "ldevId": 1,
  "clprId": 0,
  "emulationType": "OPEN-V-CVS",
  "byteFormatCapacity": "1.00 G",
  "blockCapacity": 2097152,
  "numOfPorts": 2,
  "ports": [
    {
      "portId": "CL1-A",
      "hostGroupNumber": 0,
      "hostGroupName": "1A-G00",
      "lun": 1
    },
    {
      "portId": "CL2-A",
      "hostGroupNumber": 0,
      "hostGroupName": "2A-G00",
      "lun": 1
    }
  ]
}
```

```

    }
  ],
  "attributes": [
    "CVS",
    "HDP"
  ],
  "label": "JH-26216_DP",
  "status": "NML",
  "mpBladeId": 2,
  "ssid": "0012",
  "poolId": 63,
  "numOfUsedBlock": 86016,
  "isFullAllocationEnabled": false,
  "resourceGroupId": 0,
  "dataReductionStatus": "ENABLED",
  "dataReductionMode": "compression_deduplication",
  "dataReductionProcessMode": "post_process",
  "isAluaEnabled": false
  "naaId": "60060e8006cf2e000000cf2e00000000"
}

```

The following attribute is output in addition to the attributes output from the API of getting volume information.

| Attribute | Type | Description |
|-----------|--------|---|
| naald | string | The NAA ID of the volume whose LU path was specified is output. |

Status codes

For details on the status codes of the request for this operation, see the section explaining HTTP status codes.

Coding example

```

curl -v -H "Accept:application/json" -H "Content-Type:application/json" -H
"Authorization:Session d7b673af189048468c5af9bcf3b66b6f" -X GET https://
192.0.2.100/ConfigurationManager/v1/objects/ldevs/1

```

Creating a volume

The following request creates a volume by using the specified parity groups or pools. Specify a parity group for creating a basic volume, an external parity group (external volume group) for creating the external volume, and a pool for creating a virtual volume (a DP volume or a virtual volume for Thin Image).

**Tip:**

If you want to simultaneously execute multiple requests for creating DP volumes, we recommend that you execute the corresponding jobs in parallel by specifying `true` for the `isParallelExecutionEnabled` attribute. If you do not specify this setting, the jobs will be executed sequentially, which takes more time than parallel execution.

Execution permission

Storage Administrator (Provisioning)

Request line

```
POST base-URL/v1/objects/ldevs
```

Request message**Object ID**

None.

Query parameters

None.

Body

The following coding example creates an LDEV (basic volume) by specifying the parity group:

```
{
  "ldevId": 0,
  "parityGroupId": "1-1",
  "byteFormatCapacity": "1G"
}
```

The following coding example creates an external volume by specifying an external parity group:

```
{
  "ldevId": 3,
  "externalParityGroupId": "1-1",
  "byteFormatCapacity": "1G"
}
```

The following coding example creates a DP volume for which the capacity saving function (dedupe and compression) is enabled by specifying a pool:

```
{
  "ldevId": 1,
  "poolId": 0,
```

```

"byteFormatCapacity": "1G",
"dataReductionMode": "compression_deduplication"
}

```

| Attribute | Type | Description |
|----------------------------|---------|---|
| ldevId | int | <p>(Optional) Specify an LDEV number that is not implemented with a decimal (base 10) number.</p> <p>This attribute cannot be specified at the same time as the <code>isParallelExecutionEnabled</code> attribute.</p> <p>If this attribute is omitted, the minimum LDEV number that is not implemented is assumed.</p> |
| isParallelExecutionEnabled | boolean | <p>(Optional) If you want to execute multiple requests at the same time, specify whether to execute the corresponding jobs in parallel.</p> <p>You can specify this attribute only when you are creating DP volumes.</p> <ul style="list-style-type: none"> ▪ <code>true</code>: Execute jobs in parallel. ▪ <code>false</code>: Do not execute jobs in parallel. (Execute jobs sequentially.) <p>If this attribute is omitted, the value <code>false</code> is assumed.</p> <p>If you specify the <code>ldevId</code> attribute, <code>parityGroupId</code> attribute, or <code>externalParityGroupId</code> attribute, you cannot specify this attribute.</p> <p>If you specify this attribute, an unused LDEV number is automatically assigned to the created LDEV.</p> <p>If there are LDEV numbers that cannot be used, exclude those numbers by using the <code>startLdevId</code> and <code>endLdevId</code> attributes.</p> |
| startLdevId | int | <p>(Optional) The first LDEV number in the range of LDEV numbers to be automatically assigned, if such a range is specified</p> |

| Attribute | Type | Description |
|------------------------------------|--------|--|
| | | You can specify this attribute if the <code>isParallelExecutionEnabled</code> attribute is set to <code>true</code> . If you specify this attribute, you must also specify the <code>endLdevId</code> attribute. The value of this attribute must be smaller than that of the <code>endLdevId</code> attribute. |
| <code>endLdevId</code> | int | (Optional) The last LDEV number in the range of LDEV numbers to be automatically assigned, if such a range is specified You can specify this attribute if the <code>isParallelExecutionEnabled</code> attribute is set to <code>true</code> . If you specify this attribute, you must also specify the <code>startLdevId</code> attribute. The value of this attribute must be greater than that of the <code>startLdevId</code> attribute. |
| <code>parityGroupId</code> | string | (Optional) Parity group number Be sure to specify this attribute when creating an LDEV (basic volume). Specify concatenated parity groups in the same way as the above. If the concatenated parity groups are 1-3-1, 1-3-2, or 1-3-3, specify as follows: <pre>"parityGroupId": "1-3"</pre> If you specify the <code>isParallelExecutionEnabled</code> attribute, you cannot specify this attribute. |
| <code>externalParityGroupId</code> | string | (Optional) External parity group number Be sure to specify this attribute when creating an external volume. If you specify the <code>isParallelExecutionEnabled</code> attribute, you cannot specify this attribute. |
| <code>poolId</code> | int | (Optional) Pool number |

| Attribute | Type | Description |
|--------------------|--------|--|
| | | <p>Be sure to specify this item when creating a virtual volume from a pool.</p> <ul style="list-style-type: none"> ▪ To create a DP volume: For the DP pool number, specify a decimal (base 10) number equal to or greater than 0. ▪ To create a virtual volume for Thin Image: Specify -1. |
| dataReductionMode | string | <p>(Optional) Whether to enable the capacity saving function (dedupe and compression)</p> <p>If you enable this attribute, a DP volume for which the capacity saving function (compression or deduplication) is enabled is created.</p> <p>The specifiable values are as follows:</p> <ul style="list-style-type: none"> ▪ <code>compression</code>: Enable the capacity saving function (compression) ▪ <code>compression_deduplication</code>: Enable the capacity saving function (compression and deduplication) ▪ <code>disabled</code>: Disable the capacity saving function (compression and deduplication) <p>The values are not case sensitive. If this attribute is omitted, <code>disabled</code> will be set.</p> |
| byteFormatCapacity | string | <p>(Optional) Capacity of the volume to be created, and the unit of the capacity.</p> <p>You must specify either this attribute or the <code>blockCapacity</code> attribute.</p> <p>The following units can be specified:</p> <ul style="list-style-type: none"> ▪ T or t ▪ G or g ▪ M or m ▪ K or k <p>To allocate all free space, specify "all".</p> <p>The following is an example of specifying a capacity of 1 GB:</p> <pre style="background-color: #f0f0f0; padding: 5px;">"byteFormatCapacity": "1G"</pre> |

| Attribute | Type | Description |
|---------------|------|---|
| blockCapacity | long | <p>(Optional) Capacity of the volume to be created in blocks (1 block = 512 bytes).</p> <p>You must specify either this attribute or the <code>byteFormatCapacity</code> attribute.</p> <p>The following is an example of specifying a capacity of 1 GB:</p> <pre>"blockCapacity":2097152</pre> |

Response message

Body

A job object is returned. For details on attributes other than `affectedResources`, see the section explaining job objects.

| Attribute | Description |
|--------------------------------|---------------------------|
| <code>affectedResources</code> | URL of the created volume |

Status codes

For details on the status codes of the request for this operation, see the description on HTTP status codes.

Coding example

```
curl -v -H "Accept:application/json" -H "Content-Type:application/json" -H "Authorization:Session d7b673af189048468c5af9bcf3b6bb6f" -X POST --data-binary @./InputParameters.json https://192.0.2.100/ConfigurationManager/v1/objects/ldevs
```

Formatting a volume

The following request formats an LDEV (basic volume) or DP volume.

Execution permission

Storage Administrator (Provisioning)

Request line

```
POST base-URL/v1/objects/ldevs/object-ID/actions/format/invoke
```

Request message**Object ID**

Specify the `ldevId` value obtained by getting information about volumes.

| Attribute | Type | Description |
|---------------------|------|---|
| <code>ldevId</code> | int | (Required) Specify the LDEV number with a decimal (base 10) number. |

Query parameters

None.

Body

```
{
  "parameters": {
    "operationType": "FMT"
  }
}
```

| Attribute | Type | Description |
|----------------------------|--------|---|
| <code>operationType</code> | string | (Required) Format type. The specifiable types are as follows: FMT: Normal formatting QFMT: Quick formatting For a DP volume for which the capacity saving function (dedupe and compression) is enabled, you must specify <code>FMT</code> . |

Response message**Body**

A job object is returned. For details on attributes other than `affectedResources`, see the section explaining job objects.

| Attribute | Description |
|-------------------|-----------------------------|
| affectedResources | URL of the formatted volume |

Action template

```
GET base-URL/v1/objects/ldevs/object-ID/actions/format
```

Status codes

The following table describes the meaning of the status code of the request for this operation. For details on other status codes, see the description on HTTP status codes.

| Status code | Message | Description |
|-------------|---------------------|--|
| 412 | Precondition Failed | <p>The specified action cannot run because the volume meets one of the following conditions:</p> <ul style="list-style-type: none"> ▪ The LDEV is used as a virtual volume of Thin Image. ▪ The LDEV is used as a Quorum disk. ▪ The LDEV is used as a system disk. ▪ The LDEV is used as a pool volume. |

Coding example

To get an action template:

```
curl -v -H "Accept:application/json" -H "Content-Type:application/json" -H
"Authorization:Session d7b673af189048468c5af9bcf3b66b6f" -X GET https://
192.0.2.100/ConfigurationManager/v1/objects/ldevs/1/actions/format
```

To run the request after getting an action template:

```
curl -v -H "Accept:application/json" -H "Content-Type:application/json" -H
"Authorization:Session d7b673af189048468c5af9bcf3b66b6f" -X POST --data-
binary @./InputParameters.json https://192.0.2.100/ConfigurationManager/v1/
objects/ldevs/1/actions/format/invoke
```

When forcibly formatting the DP volume for which the capacity saving function (dedupe and compression) is enabled:



Note:

The formatting of deduplicated data might take some time. Be sure to take this into account when planning when to format such data. In addition, use the status of the target resource rather than the status of the job to check whether the data has been formatted.

When format the DP volume for which the capacity saving function (compression or deduplication) is enabled, in the request body, specify `FMT` for the `operationType` attribute, and `true` for the `isDataReductionForceFormat` attribute.

The following coding example forcibly formats the DP volume for which the capacity saving function (compression or deduplication) is enabled:

```
{
  "parameters": {
    "operationType": "FMT",
    "isDataReductionForceFormat": true
  }
}
```

| Attribute | Type | Description |
|---|---------|--|
| <code>isDataReductionForceFormat</code> | boolean | (Optional) Specify whether to forcibly format the DP volume for which the capacity saving function (compression or deduplication) is enabled. <ul style="list-style-type: none"> ▪ <code>true</code>: Format forcibly ▪ <code>false</code>: Do not format forcibly When the attribute is omitted, <code>false</code> is assumed. |

Expanding the capacity of a volume

The following request expands the capacity of a DP volume.

Execution permission

Storage Administrator (Provisioning)

Request line

```
POST base-URL/v1/objects/ldevs/object-ID/actions/expand/invoke
```

Request message**Object ID**

Specify the `ldevId` value obtained by getting information about volumes.

| Attribute | Type | Description |
|---------------------|------|---|
| <code>ldevId</code> | int | (Required) Specify the LDEV number with a decimal (base 10) number. |

Query parameters

None.

Body

When specifying in bytes:

```
{
  "parameters": {
    "additionalByteFormatCapacity": "1G"
  }
}
```

When specifying in blocks:

```
{
  "parameters": {
    "additionalBlockCapacity": 2097152
  }
}
```

| Attribute | Type | Description |
|---|--------|--|
| <code>additionalByteFormatCapacity</code> | string | <p>(Optional) The capacity to be added and its unit.</p> <p>You must specify either <code>additionalByteFormatCapacity</code> or <code>additionalBlockCapacity</code>.</p> <p>The specifiable units are as follows:</p> <ul style="list-style-type: none"> ▪ T or t ▪ G or g ▪ M or m ▪ K or k |

| Attribute | Type | Description |
|-------------------------|---------|--|
| | | <p>The following is an example of specifying a capacity of 1 GB:</p> <pre>"additionalByteFormatCapacity": "1G"</pre> |
| additionalBlockCapacity | long | <p>(Optional) The capacity to be added in blocks (1 block = 512 bytes).</p> <p>You must specify either <code>additionalByteFormatCapacity</code> or <code>additionalBlockCapacity</code>.</p> <p>The following is an example of specifying a capacity of 1 GB:</p> <pre>"additionalBlockCapacity": 2097152</pre> |
| enhancedExpansion | boolean | <p>(Optional) Whether to expand the capacity of the volumes used by the copy pair.</p> <ul style="list-style-type: none"> <code>true</code>: Expand the volumes. <code>false</code>: Do not expand the volumes used by the copy pair. <p>If you do not specify a value, <code>false</code> is assumed.</p> <p>The capacity of volumes can be expanded if the status of the pair is PSUS or SSUS. For information on other prerequisite conditions and the workflow, see the manual of each software product.</p> |

Response message

Body

A job object is returned. For details on attributes other than `affectedResources`, see the section explaining job objects.

| Attribute | Description |
|-------------------|-----------------------------|
| affectedResources | URL of the expanded volumes |

Action template

```
GET base-URL/v1/objects/ldevs/object-ID/actions/expand
```

Status codes

The following table describes the meanings of the status codes of the request for this operation. For details on other status codes, see the description on HTTP status codes.

| Status code | Message | Description |
|-------------|---------------------|--|
| 412 | Precondition Failed | The specified LDEV is not a DP volume. |

Coding example

To get an action template:

```
curl -v -H "Accept:application/json" -H "Content-Type:application/json" -H
"Authorization:Session d7b673af189048468c5af9bcf3b6bb6f" -X GET https://
192.0.2.100/ConfigurationManager/v1/objects/ldevs/1/actions/expand
```

To run the request after getting an action template:

```
curl -v -H "Accept:application/json" -H "Content-Type:application/json" -H
"Authorization:Session d7b673af189048468c5af9bcf3b6bb6f" -X POST --data-
binary @./InputParameters.json https://192.0.2.100/ConfigurationManager/v1/
objects/ldevs/1/actions/expand/invoke
```

Changing the volume settings

The following request sets the label for the specified volume, tier relocation of HDT volumes, and whether page reservations are enabled for DP volumes.

Execution permission

Storage Administrator (Provisioning)

Request line

```
PATCH base-URL/v1/objects/ldevs/object-ID
```

Request message**Object ID**

Specify the value of `ldevId` that was obtained by the processing to get information about volumes.

| Attribute | Type | Description |
|-----------|------|---|
| ldevId | int | (Required) Specify the LDEV number with a decimal (base 10) number. |

Query parameters

None.

Body

The following shows an example of code for changing the label for a volume:

```
{
  "label": "REST_API_10GVolume"
}
```

The following shows an example of code for setting tier relocation and the new page assignment tier:

```
{
  "isRelocationEnabled": true,
  "tierLevelForNewPageAllocation": "L"
}
```

The following shows an example of code for setting the tiering policy (already defined):

```
{
  "tieringPolicy": {
    "tierLevel": 2
  }
}
```

The following shows an example of code for setting the tiering policy (custom policy):

```
{
  "tieringPolicy": {
    "tierLevel": 23,
    "tier1AllocationRateMin": 20,
    "tier1AllocationRateMax": 40,
    "tier3AllocationRateMin": 10,
    "tier3AllocationRateMax": 40
  }
}
```

The following shows an example of code for enabling the page reservation setting:

```
{
  "isFullAllocationEnabled": true
}
```

The following shows an example of code for enabling the capacity saving function (dedupe and compression):

```
{
  "dataReductionMode": "compression_deduplication"
}
```

| Attribute | Type | Description |
|-------------------|--------|---|
| label | string | <p>(Optional) Label to be set for the volume</p> <p>Specify a label consisting of 0 to 32 characters. You can use the following characters.</p> <ul style="list-style-type: none"> ▪ Alphanumeric characters ▪ The following symbols: ! # \$ % & ' () + , - . : = @ [] ^ _ ` { } ~ / \ <p>You can specify a hyphen as the first character of the value.</p> <ul style="list-style-type: none"> ▪ Spaces <p>The label cannot start or end with a space.</p> |
| dataReductionMode | string | <p>(Optional) Specify whether to enable the capacity saving function (dedupe and compression)</p> <p>If you enable this attribute, the capacity saving function (compression or deduplication) of the DP volume is enabled.</p> |

| Attribute | Type | Description |
|---------------------------------------|---------|---|
| | | <p>The specifiable values are as follows:</p> <ul style="list-style-type: none"> ▪ <code>compression</code>: Enable the capacity saving function (compression) ▪ <code>compression_deduplication</code>: Enable the capacity saving function (compression and deduplication) ▪ <code>disabled</code>: Disable the capacity saving function (compression and deduplication)^{#1} <p>The values are not case sensitive.</p> <p>If this attribute is changed from <code>disabled</code> to <code>compression</code> or <code>compression_deduplication</code>, the following applicable value is set by default for the <code>dataReductionProcessMode</code> attribute (the capacity-saving mode).</p> <ul style="list-style-type: none"> ▪ <code>inline</code> |
| <code>dataReductionProcessMode</code> | string | <p>(Optional) Specify the capacity-saving mode.</p> <ul style="list-style-type: none"> ▪ <code>post_process</code>: Post-process mode ▪ <code>inline</code>: Inline mode <p>This attribute can be specified when the capacity saving function is enabled.</p> <p>This attribute cannot be specified at the same time as any other attribute.</p> |
| <code>isRelocationEnabled</code> | boolean | <p>(Optional) Specify whether to enable the tier relocation setting for the HDT volume.</p> <ul style="list-style-type: none"> ▪ <code>true</code>: Enable the tier relocation. ▪ <code>false</code>: Disable the tier relocation. |
| <code>tieringPolicy</code> | object | <p>Specify the tiering policy to be assigned to the HDT volume.</p> <p>Specifying this attribute automatically enables tier relocations for the HDT volume.</p> |

| Attribute | Type | Description |
|-----------|------|---|
| | | <p>If you specify <code>false</code> for the <code>isRelocationEnabled</code> attribute, you cannot specify this attribute.</p> <ul style="list-style-type: none"> ▪ (Optional) <code>tierLevel</code> (int) Level of the tiering policy <p>If you specify the tiering policy, you must specify this setting.</p> <p>Specify a value from 0 to 31.</p> <ul style="list-style-type: none"> • 0: All tiers are used for relocations. • 1 to 5: Relocations are performed by following the tiering policy (levels 1 to 5). • 6 to 31: Relocations are performed by following the tiering policy (custom policy). <p>When an HDT volume is created, 0 is set.</p> <p>If you specify a custom policy of 6 to 31 for the <code>tierLevel</code> attribute, you can also specify the percentage of pages to be allocated to each tier.^{#2}</p> <p>There are four attributes for specifying the percentage. If you specify these attributes, you must specify all of them. Specify a value from 1 to 100.^{#3}</p> <p>You can specify the following attributes:</p> <ul style="list-style-type: none"> ▪ (Optional) <code>tier1AllocationRateMin</code> (int) From among the total capacity of the pages to be allocated when tier relocation is performed, the minimum rate (%) of the capacity to be relocated to tier 1 ▪ (Optional) <code>tier1AllocationRateMax</code> (int) From among the total capacity of the pages to be allocated when tier relocation is performed, the maximum rate (%) of the capacity to be relocated to tier 1 |

| Attribute | Type | Description |
|-------------------------------|---------|--|
| | | <ul style="list-style-type: none"> ▪ (Optional) tier3AllocationRateMin (int) From among the total capacity of the pages to be allocated when tier relocation is performed, the minimum rate (%) of the capacity to be relocated to tier 3 ▪ (Optional) tier3AllocationRateMax (int) From among the total capacity of the pages to be allocated when tier relocation is performed, the maximum rate (%) of the capacity to be relocated to tier 3 |
| tierLevelForNewPageAllocation | string | <p>(Optional) Specify which tier of the HDT pool will be prioritized when a new page is allocated.</p> <p>The type is not case sensitive.</p> <ul style="list-style-type: none"> ▪ H: Higher-level tier (High) ▪ M: Middle-level tier (Middle) ▪ L: Lower-level tier (Low) <p>When an HDT volume is created, M is set.</p> |
| isFullAllocationEnabled | boolean | <p>(Optional) Specify whether to reserve pages of the pool associated with the DP volume by using the Full Allocation functionality.</p> <ul style="list-style-type: none"> ▪ true: Enable the page reservation setting. ▪ false: Disable the page reservation setting. <p>When a DP volume is created, false is set.</p> |
| isAluaEnabled | boolean | <p>(Optional) Specify whether to enable the ALUA attribute.</p> <p>You can specify this attribute for a volume used for a global-active device in a cross-path configuration (using a Fibre Channel connection).</p> <ul style="list-style-type: none"> ▪ true: Enable the ALUA attribute. ▪ false: Disable the ALUA attribute. |

#1: If the data of the volume has been deduplicated, disabling the capacity saving function might take time. For details about the task to disable the capacity saving function, see the *Provisioning Guide for Open Systems*, or the *Provisioning Guide*. In addition, use the status of the target resource rather than the status of the job to check whether the settings have been changed.

#2: If you do not specify the percentage, the values stored in the storage system are set.

#3: If you specify the value of each attribute, make sure that the value meets the following conditions:

- The value of the tier1AllocationRateMin attribute is equal to or less than the value of the tier1AllocationRateMax attribute.
- The value of the tier3AllocationRateMin attribute is equal to or less than the value of the tier3AllocationRateMax attribute.
- The sum of the values of the tier1AllocationRateMin and tier3AllocationRateMin attributes is equal to or less than 100.
- The difference between the values of the tier1AllocationRateMax and tier1AllocationRateMin attributes is a multiple of 10.
- The difference between the values of the tier3AllocationRateMax and tier3AllocationRateMin attributes is a multiple of 10.

Response message

Body

A job object is returned. For details on attributes other than `affectedResources`, see the description on job objects.

| Attribute | Description |
|--------------------------------|---|
| <code>affectedResources</code> | URL of the volume whose settings were changed |

Status codes

For details on the status codes of the request for this operation, see the description on HTTP status codes.

Coding example

```
curl -v -H "Accept:application/json" -H "Content-Type:application/json" -H
"Authorization:Session d7b673af189048468c5af9bcf3b6f" -X PATCH --data-
binary @./InputParameters.json https://192.0.2.100/ConfigurationManager/v1/
objects/ldevs/100
```

Changing the volume status

The following request changes the status of a volume. The volume status can be changed to blocked before a volume is shredded or returned to the normal status after shredding is stopped.

Execution permission

Storage Administrator (Provisioning)

Request line

```
POST base-URL/v1/objects/ldevs/object-ID/actions/change-status/invoke
```

Request message

Object ID

Specify the value of `ldevId` that was obtained by the processing to get information about volumes.

| Attribute | Type | Description |
|---------------------|------|---|
| <code>ldevId</code> | int | (Required) Specify the LDEV number with a decimal (base 10) number. |

Query parameters

None.

Body

The following is a coding example for changing the volume status to blocked:

```
{
  "parameters": {
    "status": "blk"
  }
}
```

| Attribute | Type | Description |
|---------------------|--------|---|
| <code>status</code> | string | (Required) Volume status The specifiable values are as follows: <code>blk</code> : Change the status to blocked <code>nm1</code> : Change the status to normal |

Response message**Body**

A job object is returned. For details on attributes other than `affectedResources`, see the section explaining job objects.

| Attribute | Description |
|--------------------------------|--|
| <code>affectedResources</code> | URL of the volume whose status was changed |

Action template

```
GET base-URL/v1/objects/ldevs/object-ID/actions/change-status
```

Status codes

The following table describes the meaning of the status code of the request for this operation. For details on other status codes, see the description on HTTP status codes.

| Status code | Message | Description |
|-------------|---------------------|--|
| 412 | Precondition Failed | <p>The specified action cannot run because the volume meets one of the following conditions:</p> <ul style="list-style-type: none"> ▪ The LDEV is used as a Quorum disk. ▪ The LDEV is used as a system disk. ▪ The LDEV is used as a pool volume. ▪ The LDEV is used as a Volume Migration volume. ▪ The LDEV is used as a pair volume of a global-active device. ▪ The LDEV is used as a pair volume of ShadowImage. ▪ The LDEV is used as a pair volume of TrueCopy or Universal Replicator. ▪ The LDEV is used as a pair volume of Thin Image or Copy-on-Write Snapshot. |

Coding example

To get an action template:

```
curl -v -H "Accept:application/json" -H "Content-Type:application/json" -H
"Authorization:Session d7b673af189048468c5af9bcf3b6bb6f" -X GET https://
192.0.2.100/ConfigurationManager/v1/objects/ldevs/100/actions/change-status
```

To run the request after getting an action template:

```
curl -v -H "Accept:application/json" -H "Content-Type:application/json" -H
"Authorization:Session d7b673af189048468c5af9bcf3b6bb6f" -X POST --data-
binary @./InputParameters.json https://192.0.2.100/ConfigurationManager/v1/
objects/ldevs/100/actions/change-status/invoke
```

Shredding a volume

The following request shreds an LDEV (basic volume) or DP volume. Overwrite the volume three times with dummy data. You can stop shredding before its completion. Change the status of the volume to be shredded to blocked. When shredding is complete, the status of the volume is automatically changed to normal. If you stopped shredding before completion, the status of the volume remains as blocked.

Notes when stopping shredding

If you make a request to stop shredding, all of the volumes that are currently being shredded are stopped.

Shredding might not stop even if you make a request to stop shredding. In such case, make the request according to the progress status of the shredding. The progress of the shredding can be checked from the value of the `preparingOperationProgressRate` attribute that is obtained from the information of the target volume.

- When the value of the attribute is 0, shredding has not started.
 - When the value is 0, shredding is not stopped even if a request is made.
 - Request the stopping of the shredding after the value is greater than or equal to 1.
- When a request for stopping shredding is made but the value of the attribute does not change to 100, shredding is not stopped.
 - In such case, make a request to stop the shredding again.

Execution permission

Storage Administrator (Provisioning)

Request line

```
POST base-URL/v1/objects/ldevs/object-ID/actions/shred/invoke
```

Request message**Object ID**

Specify the value of `ldevId` that was obtained by the processing to get information about volumes.

| Attribute | Type | Description |
|---------------------|------|---|
| <code>ldevId</code> | int | (Required) Specify the LDEV number with a decimal (base 10) number. |

Query parameters

None.

Body

The following is a coding example for performing shredding by specifying the dummy data pattern:

```
{
  "parameters": {
    "operationType": "start",
    "pattern": "F0F0F0"
  }
}
```

The following is a coding example for performing shredding without specifying the dummy data pattern:

```
{
  "parameters": {
    "operationType": "start"
  }
}
```

The following is a coding example for stopping shredding before completion:

```
{
  "parameters": {
    "operationType": "stop"
  }
}
```

| Attribute | Type | Description |
|---------------|--------|--|
| operationType | string | (Required) Run or stop shredding. The specifiable values are as follows: start: Run shredding stop: Stop shredding |
| pattern | string | (Optional) Dummy data pattern to be used for the second overwrite Specify a pattern consisting of 1 to 8 characters in a hexadecimal format. Specification example: 0F0F0F If the value is not specified, the default pattern <code>FFFFFFFF</code> will be used. |

Response message

Body

A job object is returned. For details on attributes other than `affectedResources`, see the section explaining job objects.

| Attribute | Description |
|-------------------|----------------------------|
| affectedResources | URL of the shredded volume |

Action template

```
GET base-URL/v1/objects/ldevs/object-ID/actions/shred
```

Status codes

The following table describes the meaning of the status code of the request for this operation. For details on other status codes, see the description on HTTP status codes.

| Status code | Message | Description |
|-------------|---------------------|---|
| 412 | Precondition Failed | <p>The specified action cannot run because the volume meets one of the following conditions:</p> <ul style="list-style-type: none"> ▪ The LDEV status is normal or the status is being changed. ▪ The LDEV is used as a Quorum disk. ▪ The LDEV is used as a system disk. ▪ The LDEV is used as a pool volume. ▪ The LDEV is used as a deduplication system data volume (fingerprint). ▪ The LDEV is used as a journal volume. ▪ The LDEV is used as a pair volume of a global-active device. ▪ The LDEV is used as a pair volume of ShadowImage. ▪ The LDEV is used as a pair volume of TrueCopy or Universal Replicator. ▪ The LDEV is used as a pair volume of Thin Image or Copy-on-Write Snapshot. |

Coding example

To get an action template:

```
curl -v -H "Accept:application/json" -H "Content-Type:application/json" -H
"Authorization:Session d7b673af189048468c5af9bcf3b66b6f" -X GET https://
192.0.2.100/ConfigurationManager/v1/objects/ldevs/100/actions/shred
```

To run the request after getting an action template:

```
curl -v -H "Accept:application/json" -H "Content-Type:application/json" -H
"Authorization:Session d7b673af189048468c5af9bcf3b66b6f" -X POST --data-
binary @./InputParameters.json https://192.0.2.100/ConfigurationManager/v1/
objects/ldevs/100/actions/shred/invoke
```

Reclaiming zero pages of a DP volume

The following request reclaims zero pages of a DP volume to release the pages. By releasing pages, you can increase the free capacity of a pool.

Execution permission

Storage Administrator (Provisioning)

Request linePOST *base-URL/v1/objects/ldevs/object-ID/actions/discard-zero-page/invoke***Request message****Object ID**

Specify the value of `ldevId` that was obtained by the processing to get information about volumes.

| Attribute | Type | Description |
|---------------------|------|---|
| <code>ldevId</code> | int | (Required) Specify the LDEV number with a decimal (base 10) number. |

Query parameters

None.

Body

None.

Response message

A job object is returned. For details on attributes other than `affectedResources`, see the section explaining job objects.

| Attribute | Description |
|--------------------------------|---|
| <code>affectedResources</code> | URL of the volume for which zero pages were reclaimed |

Action template

None.

Status codes

The following table explains the meanings of the status codes for this API. For details on other status codes, see the section explaining HTTP status codes.

| Status code | Message | Description |
|-------------|---------------------|--|
| 412 | Precondition Failed | <p>The specified action cannot run because the volume meets one of the following conditions:</p> <ul style="list-style-type: none"> ▪ The volume is not a DP volume. ▪ The volume is in the blocked status. ▪ The volume is used as a pair volume of one of the following copy types: <ul style="list-style-type: none"> • ShadowImage • TrueCopy • Universal Replicator • Thin Image • Copy-on-Write Snapshot ▪ The volume is used as a journal volume of Universal Replicator. ▪ The volume is used as a Volume Migration volume. |

Coding example

```
curl -v -H "Accept:application/json" -H "Content-Type:application/json" -H
"Authorization:Session d7b673af189048468c5af9bcf3b6bb6f" -X POST https://
192.0.2.100/ConfigurationManager/v1/objects/ldevs/1/actions/discard-zero-
page/invoke -d ""
```

Changing the MP blade assigned to a volume

The following request changes the MP blade assigned to a volume.



Note:

When changing the MP blade assigned to a volume, make sure to take into account the effect the change will have on I/O performance. For notes on changing the MP blade assigned to a volume, see the *Provisioning Guide for Open Systems* or the *Provisioning Guide* for the storage system.

Execution permission

Storage Administrator (System Resource Management)

Request line

```
POST base-URL/v1/objects/ldevs/object-ID/actions/assign-mp-blade/invoke
```

Request message**Object ID**

Specify the `ldevId` value obtained by getting volume information.

| Attribute | Type | Description |
|---------------------|------|------------------------|
| <code>ldevId</code> | int | (Required) LDEV number |

Query parameters

None.

Body

```
{
  "parameters": {
    "mpBladeId": 1
  }
}
```

| Attribute | Type | Description |
|------------------------|------|---|
| <code>mpBladeId</code> | int | (Required) MP blade number of the MP blade to be assigned to the volume |

Response message**Body**

A job object is returned. For details about attributes other than `affectedResources`, see the description of job objects.

| Attribute | Description |
|--------------------------------|---|
| <code>affectedResources</code> | URL of the volume for which the MP blade number was changed |

Action template

None.

Status codes

For details about the status codes of the request for this operation, see the description of the HTTP status codes.

Coding example

```
curl -v -H "Accept:application/json" -H "Content-Type:application/json" -H
"Authorization:Session d7b673af189048468c5af9bcf3b6666f" -X POST --data-
binary @./InputParameters.json https://192.0.2.100/ConfigurationManager/v1/
objects/ldevs/99/actions/assign-mp-blade/invoke
```

Deleting a volume

The following request deletes an LDEV (basic volume) or a virtual volume (a DP volume or a virtual volume for Thin Image).

Execution permission

Storage Administrator (Provisioning)

Request line

```
DELETE base-URL/v1/objects/ldevs/object-ID
```

Request message**Object ID**

Specify the `ldevId` value obtained by getting information about volumes.

| Attribute | Type | Description |
|-----------|------|---|
| ldevId | int | (Required) Specify the LDEV number with a decimal (base 10) number. |

Query parameters

None.

Body

None.

Response message**Body**

A job object is returned. For details on attributes other than `affectedResources`, see the section explaining job objects.

| Attribute | Description |
|-------------------|---------------------------|
| affectedResources | URL of the deleted volume |

Status codes

For details on the status codes of the request for this operation, see the description on HTTP status codes.

Coding example

```
curl -v -H "Accept:application/json" -H "Content-Type:application/json" -H
"Authorization:Session d7b673af189048468c5af9bcf3b66b6f" -X DELETE
https://192.0.2.100/ConfigurationManager/v1/objects/ldevs/105
```

When forcibly deleting the DP volume for which the capacity saving function (dedupe and compression) is enabled



Important: Deleting data on a DP volume for which the capacity saving function (compression or deduplication) is enabled takes time. Be sure to take this into account when planning when to delete such data. In addition, use the status of the target resource rather than the status of the job to check whether the volume has been deleted.

When deleting the DP volume for which the capacity saving function (compression or deduplication) is enabled, in the request body, specify `true` for the `isDataReductionDeleteForceExecute` attribute.

The following coding example forcibly deletes the DP volume for which the capacity saving function (compression or deduplication) is enabled:

```
{
  "isDataReductionDeleteForceExecute": true
}
```

| Attribute | Type | Description |
|-----------------------------------|---------|---|
| isDataReductionDeleteForceExecute | boolean | (Optional) Specify whether to forcibly delete the DP volume for which the capacity saving function (compression or deduplication) is enabled. <ul style="list-style-type: none"> ▪ <code>true</code>: Forcibly deletes ▪ <code>false</code>: Does not forcibly delete |

| Attribute | Type | Description |
|-----------|------|---|
| | | When the attribute is omitted, <code>false</code> is assumed. |

Getting port information

The following request obtains information about ports.



Important:

If the storage system model is VSP E series, VSP G350, G370, G700, G900, VSP F350, F370, F700, F900, if you execute this API request with `detailInfoType=logins` specified, pay attention to the number of concurrent executions of this API request. For details, see "Implementing retry processing".

Execution permission

Storage Administrator (View Only)

Request line

```
GET base-URL/v1/objects/ports
```

Request message

Object ID

None.

Query parameters

You can filter execution results by specifying conditions, or get additional detailed port information.

When filtering execution results:

| Parameter | Type | Filter condition |
|-----------|--------|--|
| portType | string | (Optional) Port type You can specify the following conditions: <ul style="list-style-type: none"> ▪ FIBRE ▪ SCSI ▪ ISCSI ▪ ENAS |

| Parameter | Type | Filter condition |
|-----------------------------|--------|---|
| | | <ul style="list-style-type: none"> ▪ ESCON ▪ FICON <p>If this parameter is omitted, information about ports of all port types will be obtained.</p> <p>If you specify <code>portId</code>, you cannot specify this parameter.</p> |
| <code>portAttributes</code> | string | <p>(Optional) Port attribute</p> <p>You can specify the following conditions:</p> <ul style="list-style-type: none"> ▪ <code>TAR</code>: Target port (Fibre Target port) ▪ <code>MCU</code>: Initiator port (MCU Initiator port) ▪ <code>RCU</code>: RCU target port (RCU Target port) ▪ <code>ELUN</code>: External port (External Initiator port) <p>If this parameter is omitted, information about all port attributes will be obtained.</p> <p>Information about bidirectional ports will be obtained regardless of which value is specified for this parameter.</p> <p>If you specify <code>portId</code>, you cannot specify this parameter.</p> |
| <code>portId</code> | string | <p>(Optional) Port number</p> <p>If this parameter is omitted, information about all port numbers will be obtained. If you specify this parameter, be sure to specify the <code>detailInfoType</code> parameter. Note that the <code>portType</code> parameter and the <code>portAttributes</code> parameter cannot be specified at the same time.</p> |

When collecting additional detailed information:

| Parameter | Type | Description |
|-----------------------------|--------|---|
| <code>detailInfoType</code> | string | <p>(Optional) Type of detailed information to be obtained</p> <ul style="list-style-type: none"> ▪ <code>logins</code>: Information about logins to a port corresponding to the WWN of an HBA or iSCSI name <p>You can get this information if the port type is <code>FIBRE</code>, or <code>ISCSI</code>.</p> <p>You can use this parameter together with parameters that filter the execution results.</p> |

Body

None.

Response message**Body**

The following is an example of the output when information obtained about all ports:

```
{
  "data": [
    {
      "portId": "CL1-A",
      "portType": "FIBRE",
      "portAttributes": [
        "TAR",
        "MCU",
        "RCU",
        "ELUN"
      ],
      "portSpeed": "AUT",
      "loopId": "EF",
      "fabricMode": true,
      "portConnection": "PtoP",
      "lunSecuritySetting": true,
      "wwn": "50060e80124e3b00"
    },
    {
      "portId": "CL1-B",
      "portType": "ISCSI",
      "portAttributes": [
        "TAR",
        "MCU",
        "RCU",
        "ELUN"
      ],
      "portSpeed": "10G",
      "loopId": "00",
      "fabricMode": false,
      "lunSecuritySetting": true
    }
  ]
}
```

The following is an example of the output when information is obtained about ports by specifying the port type:

```
{
  "data": [
    {
```

```

    "portId": "CL1-B",
    "portType": "ISCSI",
    "portAttributes": [
      "TAR",
      "MCU",
      "RCU",
      "ELUN"
    ],
    "portSpeed": "10G",
    "loopId": "00",
    "fabricMode": false,
    "lunSecuritySetting": true
  }
]
}

```

| Attribute | Type | Description |
|----------------|----------|--|
| portId | string | Port number |
| portType | string | Port type One of the following values is output: FIBRE, SCSI, ISCSI, ENAS, ESCON, FICON |
| portAttributes | string[] | The value set for the port attribute <ul style="list-style-type: none"> TAR: Target port (Fibre Target port) MCU: Initiator port (MCU Initiator port) RCU: RCU target port (RCU Target port) ELUN: External port (External Initiator port) For a bidirectional port, all four attributes are output. |
| portSpeed | string | The value set for the transfer speed <ul style="list-style-type: none"> AUT (AUTO) nG (where <i>n</i> is a number) |
| loopId | string | The value set for the port loop ID (AL_PA) |
| fabricMode | boolean | Fabric mode of the port <ul style="list-style-type: none"> true: Set. false: Not set. |

| Attribute | Type | Description |
|--------------------|---------|---|
| portConnection | string | Topology setting for the port <ul style="list-style-type: none"> FCAL PtoP If the <code>portType</code> attribute is <code>ISCSI</code> , this information is not output. |
| lunSecuritySetting | boolean | LUN security setting for the port <ul style="list-style-type: none"> true: Set. false: Not set. |
| wwn | string | External WWN <p>If the <code>portType</code> attribute is <code>ISCSI</code>, this information is not output.</p> |

The following is an example of the output when requesting additional detailed information:

```
{
  "data" : [
    {
      "portId" : "CL1-A",
      "portType" : "FIBRE",
      "portAttributes" : [ "TAR" ],
      "portSpeed" : "AUT",
      "loopId" : "EF",
      "fabricMode" : true,
      "portConnection" : "PtoP",
      "lunSecuritySetting" : true,
      "wwn" : "50060e8007274300",
      "logins" : [
        {
          "loginWwn" : "C0507603BF0002C",
          "wwnNickName" : "-",
          "isLoggedIn" : false
        },
        {
          "loginWwn" : "C05076087D5A0012",
          "wwnNickName" : "ep22_10_0",
          "hostGroupId" : "CL1-A,9",
          "isLoggedIn" : true
        }
      ]
    }
  ],
}
```

```

{
  "portId" : "CL1-B",
  "portType" : "ISCSI",
  "portAttributes" : [ "TAR" ],
  "portSpeed" : "10G",
  "loopId" : "00",
  "fabricMode" : false,
  "lunSecuritySetting" : true,
  "logins" : [
    {
      "loginIscsiName" : "iqn.1991-05.com.microsoft:hy0295",
      "iscsiNickName" : "hypoi0295",
      "hostGroupId" : "CL1-B,0",
      "iscsiTargetName" : "iqn.1994-
04.jp.co.hitachi:rsd.h8h.t.10011.1d000",
      "isLoggedIn" : false
    },
    {
      "loginIscsiName" : "iqn.1991-05.com.microsoft:hy0295",
      "iscsiNickName" : "hypoi0295",
      "hostGroupId" : "CL1-B,94",
      "iscsiTargetName" : "iqn.1994-
04.jp.co.hitachi:rsd.h8h.t.10011.1d05e",
      "isLoggedIn" : true
    }
  ]
}

```

You can also get the following information by executing the request with `logins` specified for `detailInfoType` in the query parameters.

| Attribute | Type | Description |
|-----------|----------|---|
| logins | object[] | Information about logins to a storage system port corresponding to the WWN of an HBA or iSCSI name For the WWN: <ul style="list-style-type: none"> ▪ loginWwn (string) WWN of the HBA ▪ wwnNickName (string)# WWN nickname |

| Attribute | Type | Description |
|-----------|------|---|
| | | <ul style="list-style-type: none"> ▪ <code>hostGroupId</code> (string)# Object ID of the host group ▪ <code>isLoggedIn</code> (boolean) Login status of the host <ul style="list-style-type: none"> • <code>true</code>: Logged in • <code>false</code>: Not logged in <p>For iSCSI name:</p> <ul style="list-style-type: none"> ▪ <code>loginIscsiName</code> (string) iSCSI name of iSCSI initiator ▪ <code>iscsiNickName</code> (string)# iSCSI nickname ▪ <code>hostGroupId</code> (string)# Object ID of iSCSI target ▪ <code>iscsiTargetName</code> (string) iSCSI name of iSCSI target ▪ <code>isLoggedIn</code> (boolean) Login status of the host <ul style="list-style-type: none"> • <code>true</code>: Logged in • <code>false</code>: Not logged in |

#: For a VSP 5000 series storage system, it might take some time (from about 30 seconds to a few minutes) after the values for these attributes are updated before you can obtain the updated information by using the REST API. Wait a while and then execute the request again.

Status codes

For details on the status codes of the request for this operation, see the description on HTTP status codes.

Coding example

To obtain information about all ports:

```
curl -v -H "Accept:application/json" -H "Content-Type:application/json" -H
"Authorization:Session d7b673af189048468c5af9bcf3b6bb6f" -X GET https://
192.0.2.100/ConfigurationManager/v1/objects/ports
```

To obtain information about ports by specifying the port type:

```
curl -v -H "Accept:application/json" -H "Content-Type:application/json" -H
"Authorization:Session d7b673af189048468c5af9bcf3b6bb6f" -X GET https://
192.0.2.100/ConfigurationManager/v1/objects/ports?portType=ISCSI
```

To obtain information about ports by requesting additional detailed information:

```
curl -v -H "Accept:application/json" -H "Content-Type:application/json" -H
"Authorization:Session d7b673af189048468c5af9bcf3b6bb6f" -X GET https://
192.0.2.100/ConfigurationManager/v1/objects/ports?detailInfoType=logins
```

Getting information about a specific port

The following request gets information about a specific port by specifying the port number. You can use this API to get information about Fibre Channel port, or iSCSI port.

Execution permission

Storage Administrator (View Only)

Request line

```
GET base-URL/v1/objects/ports/object-ID
```

Request message**Object ID**

Specify the `portId` value obtained by getting information about the port.

| Attribute | Type | Description |
|-----------|--------|------------------------|
| portId | string | (Required) Port number |

Query parameters

| Parameter | Type | Description |
|----------------|--------|---|
| detailInfoType | string | <p>(Optional) Type of detailed information to be obtained</p> <ul style="list-style-type: none"> class <p>Adds additional information from the storage system's cache. You can specify this item for VSP 5000 series.</p> <p>To get up-to-date information, you must run the API request that refreshes the storage system's cache before running this request. For details, see "Updating the cache of storage system configuration information".</p> |

Body

None.

Response message**Body**

The following is an example of the output generated when getting Fibre Channel port information:

```
{
  "portId": "CL1-A",
  "portType": "FIBRE",
  "portAttributes": [
    "TAR",
    "MCU",
    "RCU",
    "ELUN"
  ],
  "portSpeed": "AUT",
  "loopId": "EF",
  "fabricMode": true,
  "portConnection": "PtoP",
  "lunSecuritySetting": true,
  "wwn": "50060e80124e3b00"
}
```

For a Fibre Channel port:

| Attribute | Type | Description |
|--------------------|----------|--|
| portId | string | Port number |
| portType | string | Port type One of the following values is output: FIBRE, SCSI, ISCSI, ENAS, ESCON, FICON |
| portAttributes | string[] | The value set for the port attribute <ul style="list-style-type: none"> ▪ TAR: Target port (Fibre Target port) ▪ MCU: Initiator port (MCU Initiator port) ▪ RCU: RCU target port (RCU Target port) ▪ ELUN: External port (External Initiator port) For a bidirectional port, all four attributes are output. |
| portSpeed | string | The value set for the transfer speed <ul style="list-style-type: none"> ▪ AUT (AUTO) ▪ nG (where n is a number) |
| loopId | string | The value set for the port loop ID (AL_PA) |
| fabricMode | boolean | Fabric mode of the port <ul style="list-style-type: none"> ▪ true: Set. ▪ false: Not set. |
| portConnection | string | Topology setting for the port <ul style="list-style-type: none"> ▪ FCAL ▪ PtoP |
| lunSecuritySetting | boolean | LUN security setting for the port <ul style="list-style-type: none"> ▪ true: Set. ▪ false: Not set. |
| wwn | string | External WWN |

| Attribute | Type | Description |
|-----------|----------|---|
| logins | object[] | <p>If there is a currently-connected WWN, the following attributes are output:</p> <ul style="list-style-type: none"> ▪ loginWwn (string) WWN of the host adapter that is logged in to the port ▪ wwnNickName (string) Reserved attribute <p>The version of this API is always displayed as a hyphen (-).</p> |

The following is an example of the output generated when getting iSCSI port information.

```
{
  "portId" : "CL1-A",
  "portType" : "ISCSI",
  "portAttributes" : [ "TAR", "MCU", "RCU", "ELUN" ],
  "portSpeed" : "10G",
  "loopId" : "00",
  "fabricMode" : false,
  "lunSecuritySetting" : true,
  "tcpOption" : {
    "ipv6Mode" : false,
    "selectiveAckMode" : true,
    "delayedAckMode" : true,
    "isnsService" : false,
    "tagVlan" : false
  },
  "tcpMtu" : 1500,
  "iscsiWindowSize" : "64KB",
  "keepAliveTimer" : 60,
  "tcpPort" : "3260",
  "macAddress" : "00:1f:67:1f:14:1d",
  "ipv4Address" : "192.168.0.100",
  "ipv4Subnetmask" : "255.255.255.0",
  "ipv4GatewayAddress" : "0.0.0.0",
  "ipv6LinkLocalAddress" : {
    "status" : "INV",
    "addressingMode" : "AM",
    "address" : "fe80::"
  },
  "ipv6GlobalAddress" : {
    "status" : "INV",
```

```

    "addressingMode" : "AM",
    "address" : "::"
  },
  "ipv6GatewayGlobalAddress" : {
    "status" : "INV",
    "address" : "::",
    "currentAddress" : "::"
  }
}

```

For an iSCSI port:

| Attribute | Type | Description |
|--------------------|----------|--|
| portId | string | Port number |
| portType | string | Port type One of the following values is output: FIBRE, SCSI, ISCSI, ENAS, ESCON, FICON |
| portAttributes | string[] | The value set for the port attribute <ul style="list-style-type: none"> ▪ TAR: Target port (Fibre Target port) ▪ MCU: Initiator port (MCU Initiator port) ▪ RCU: RCU target port (RCU Target port) ▪ ELUN: External port (External Initiator port) For a bidirectional port, all four attributes are output. |
| portSpeed | string | The value set for the transfer speed <ul style="list-style-type: none"> ▪ AUT (AUTO) ▪ nG (where <i>n</i> is a number) |
| loopId | string | The value set for the port loop ID (AL_PA) |
| fabricMode | boolean | Fabric mode of the port <ul style="list-style-type: none"> ▪ true: Set. ▪ false: Not set. |
| lunSecuritySetting | boolean | LUN security setting for the port <ul style="list-style-type: none"> ▪ true: Set. ▪ false: Not set. |

| Attribute | Type | Description |
|--------------------|----------|---|
| logins | object[] | If there is a currently-connected iSCSI name, the following attributes are output: <ul style="list-style-type: none"> loginIscsiName (string) iSCSI name of the host adapter that is logged in to the port |
| vLanId | string | VLAN ID (in decimal number format) |
| tcpOption | object | The following attributes are output: <ul style="list-style-type: none"> ipv6Mode (boolean) IPv6 mode selectiveAckMode (boolean) Selective Ack mode delayedAckMode (boolean) Delayed Ack mode isnsService (boolean) iSNS service tagVlan (boolean) Tag VLAN |
| tcpMtu | int | Value of MTU for iSCSI communication |
| iscsiWindowSize | string | Value of Window Size for iSCSI communication |
| keepAliveTimer | int | Value of Keep Alive Timer for iSCSI communication |
| tcpPort | string | TCP port number for iSCSI communication |
| macAddress | string | MAC address of the port |
| ipv4Address | string | IPv4 address |
| ipv4Subnetmask | string | IPv4 subnet mask |
| ipv4GatewayAddress | string | IPv4 address of the gateway to be used for iSCSI communication |

| Attribute | Type | Description |
|----------------------|--------|--|
| ipv6LinkLocalAddress | object | <p>The following attributes are output:</p> <ul style="list-style-type: none"> ▪ status (string) One of the following values that indicate the status of the IPv6 link local address is output: <ul style="list-style-type: none"> • <code>INV</code>: Invalid • <code>VAL</code>: Valid • <code>ACQ</code>: Acquiring • <code>DUP</code>: Duplicated • <code>Unknown</code>: Undefined value ▪ addressingMode (string) One of the following values that indicate the mode of the IPv6 link local address is output: <ul style="list-style-type: none"> • <code>AM</code>: Auto mode • <code>MM</code>: Manual mode • <code>Unknown</code>: Undefined value ▪ address (string) IPv6 link local address value |

| Attribute | Type | Description |
|-------------------|--------|---|
| ipv6GlobalAddress | object | <p>The following attributes are output:</p> <ul style="list-style-type: none"> ▪ status (string) <p>One of the following values that indicate the status of the IPv6 global address is output:</p> <ul style="list-style-type: none"> • INV: Invalid • VAL: Valid • ACQ: Acquiring • DUP: Duplicated • Unknown: Undefined value ▪ addressingMode (string) <p>One of the following values that indicate the mode of the IPv6 global address is output:</p> <ul style="list-style-type: none"> • AM: Auto mode • MM: Manual mode • Unknown: Undefined value ▪ address (string) <p>IPv6 global address value</p> |

| Attribute | Type | Description |
|----------------------------|--------|--|
| ipv6GatewayGlobalAddresses | object | <p>The following attributes are output:</p> <ul style="list-style-type: none"> ▪ status (string) One of the following values that indicate the status of the IPv6 global address of the gateway to be used for iSCSI communication is output: <ul style="list-style-type: none"> • INV: Invalid • VAL: Valid • ACQ: Acquiring • DUP: Duplicated • Unknown: Undefined value ▪ address (string) IPv6 global address value of the gateway to be used for iSCSI communication ▪ currentAddress (string) IPv6 global current address value of the gateway to be used for iSCSI communication |
| isnsPort | string | TCP port number of the iSNS server |
| isnsAddress | string | Address of the iSNS server |

If you run this request with `class` specified for `detailInfoType` in the query parameters, additional information from the storage system's cache is also obtained.

| Attribute | Type | Description |
|--------------------|--------|--|
| channelBoardId | int | ID of the channel board |
| ipv6GlobalAddress2 | object | Attributes related to IPv6 Global address2 |

| Attribute | Type | Description |
|-------------------------------------|----------------------|--|
| | | <p>This information is output for iSCSI ports.</p> <ul style="list-style-type: none"> ▪ address (string) Address value for IPv6 Global address2 ▪ status (string) Status of IPv6 Global address2 <ul style="list-style-type: none"> • INV: Invalid • VAL: Valid • ACQ: Acquiring • DUP: Duplicated • Unknown: Undefined value <p>This information is not output if <code>iscsiVirtualPortMode</code> is <code>true</code>.</p> |
| <code>ipv6SubnetPrefixLength</code> | <code>int</code> | <p>Length of the IPv6 subnet prefix</p> <p>This information is output for iSCSI ports.</p> <p>If the setting for IPv6 is invalid, -1 is output.</p> <p>This information is not output if <code>iscsiVirtualPortMode</code> is <code>true</code>.</p> |
| <code>iscsiInitiatorName</code> | <code>string</code> | <p>iSCSI name of the storage system port</p> <p>This information is output for iSCSI ports.</p> |
| <code>t10piMode</code> | <code>string</code> | <p>Status of the T10 PI mode of the port</p> <ul style="list-style-type: none"> ▪ Enable: Enabled ▪ Disable: Disabled ▪ Unknown: Status unknown (unsupported) |
| <code>iscsiVirtualPortMode</code> | <code>boolean</code> | <p>Whether iSCSI virtual port mode is enabled</p> <p>This information is output for iSCSI ports.</p> <ul style="list-style-type: none"> ▪ <code>true</code>: Enabled ▪ <code>false</code>: Disabled |

Status codes

For details on the status codes of the request for this operation, see the description on HTTP status codes.

Coding example

```
curl -v -H "Accept:application/json" -H "Content-Type:application/json" -H
"Authorization:Session d7b673af189048468c5af9bcf3b66b6f" -X GET https://
192.0.2.100/ConfigurationManager/v1/objects/ports/CL1-A
```

Changing the port attribute

The request below changes the value of the port attribute.

**Note:**

This API request can be used when the storage system is VSP 5000 series.

Execution permission

Storage Administrator (Provisioning)

Request line

```
PATCH base-URL/v1/objects/ports/object-ID
```

Request message**Object ID**

Specify the value of `portId` that was obtained by the processing to get information about ports.

| Attribute | Type | Description |
|-----------|--------|------------------------|
| portId | string | (Required) Port number |

Query parameters

None.

Body

```
{
  "portAttribute": "TAR"
}
```

| Attribute | Type | Description |
|---------------|--------|---------------------------|
| portAttribute | string | (Required) Port attribute |

| Attribute | Type | Description |
|-----------|------|--|
| | | <p>You can specify the following values:</p> <ul style="list-style-type: none"> TAR: Target port (Fibre Target port) ALL: Bidirectional port <p>This item is not case sensitive.</p> |

Response message

Body

A job object is returned. For details on the attributes other than `affectedResources`, see the section explaining job objects.

| Attribute | Description |
|--------------------------------|-------------------------|
| <code>affectedResources</code> | URL of the changed port |

Action template

None.

Status codes

For details on the status codes of the request for this operation, see the description of HTTP status codes.

Coding example

```
curl -v -H "Accept:application/json" -H "Content-Type:application/json" -H
"Authorization:Session b74777a3-f9f0-4ea8-bd8f-09847fac48d3" -X PATCH --
data-binary @./InputParameters.json https://192.0.2.100/
ConfigurationManager/v1/objects/ports/CL1-A
```

Getting information about host groups or iSCSI targets

The following request gets information about host groups or iSCSI targets of the port.



Important:

If the storage system model is VSP E series, VSP G350, G370, G700, G900, VSP F350, F370, F700, F900, and if `portId` is not specified as a query parameter, pay attention to the number of concurrent executions of this API request. For details, see "Implementing retry processing".

Execution permission

Storage Administrator (View Only)

Request lineGET *base-URL/v1/objects/host-groups***Request message****Object ID**

None.

Query parameters

You can specify conditions to filter the execution results and get information about host groups at high speeds.

- To filter the execution results

| Parameter | Type | Filter Condition |
|-------------|---------|---|
| portId | string | <p>(Optional) Port number</p> <p>Only when this parameter is specified, the following attributes are also obtained:</p> <ul style="list-style-type: none"> ▪ <code>iscsiName</code> ▪ <code>authenticationMode</code> ▪ <code>iscsiTargetDirection</code> ▪ <code>hostModeOptions</code> <p>If this parameter is omitted, information about all ports is obtained.</p> |
| isUndefined | boolean | <p>(Optional) Specify whether to get information even about host group numbers for which no host group or iSCSI target has been created.</p> <ul style="list-style-type: none"> ▪ <code>true</code>: Gets information about host group numbers for which no host group or iSCSI target has been created. ▪ <code>false</code>: Does not get information about host group numbers for which no host group or iSCSI target has been created. <p>You cannot specify this parameter at the same time as the <code>hostGroupNumberList</code> parameter.</p> |

| Parameter | Type | Filter Condition |
|-----------|------|--|
| | | If this parameter is omitted, <code>false</code> is assumed to be specified. |

- When collecting additional detailed information

| Parameter | Type | Description |
|-----------------------------|--------|--|
| <code>detailInfoType</code> | string | <p>(Optional) Type of detailed information to be obtained</p> <ul style="list-style-type: none"> ▪ <code>resourceGroup</code> <p>Gets information about resource groups of host groups or iSCSI targets.</p> <p>If you specify this parameter, also specify the <code>portId</code> parameter.</p> <p>The following parameter settings cannot be specified together with the <code>detailInfoType</code> parameter: <code>storageCache</code> specified for the <code>accessMode</code> parameter, or <code>true</code> specified for the <code>isSimpleMode</code> parameter.</p> |

- To get information about host groups at high speeds

| Parameter | Type | Description |
|-------------------------|--------|---|
| <code>accessMode</code> | string | <p>(Optional) To get information about host groups at high speeds, specify the following value:</p> <ul style="list-style-type: none"> ▪ <code>storageCache</code> <p>You can specify this value if the storage system model is VSP 5000 series.</p> <p>If you specify this parameter, information about host groups is obtained from the cache. For this reason, you can get information more quickly by specifying this parameter than without specifying this parameter. After you use the REST API or CCI to create a host group, it usually takes anywhere from a few minutes to an hour before the latest information is applied to the cache.</p> <p>If you specify <code>portId</code>, you cannot specify this parameter.</p> |

| Parameter | Type | Description |
|-----------|------|---|
| | | If you specify this parameter for VSP E series, VSP G350, G370, G700, G900, VSP F350, F370, F700, F900, the parameter is ignored. |

- To obtain only the attributes that fall under basic information

You can obtain information more quickly than if you were to obtain all attributes.

| Parameter | Type | Description |
|---------------------|---------|--|
| isSimpleMode | boolean | <p>(Optional) Specify whether to obtain only the attributes that fall under basic information.</p> <ul style="list-style-type: none"> ▪ <code>true</code>: Obtain only the attributes that fall under basic information. ▪ <code>false</code>: Obtain all attributes. <p>If you specify the value <code>true</code> for this parameter, be sure to also specify the <code>portId</code> parameter.</p> <p>If this parameter is omitted, the value <code>false</code> is assumed.</p> |
| hostGroupNumberList | string | <p>(Optional) Target IDs of iSCSI targets</p> <p>Specify this parameter to get basic information about the specified iSCSI targets.</p> <p>If you specify this parameter, be sure to specify <code>true</code> for the <code>isSimpleMode</code> parameter.</p> <p>You cannot specify this parameter at the same time as the <code>isUndefined</code> parameter.</p> <p>To specify multiple IDs, delimit each ID by using a comma.</p> |

Body

None.

Response message**Body**

The following coding example obtains only the attributes that fall under basic information:

```
{
  "data": [
    {
      "hostGroupId": "CL1-A,0",
      "portId": "CL1-A",
      "hostGroupNumber": 0,
      "hostGroupName": "hostA"
    },
    {
      "hostGroupId": "CL1-B,0",
      "portId": "CL1-B",
      "hostGroupNumber": 0,
      "hostGroupName": "hostB"
    }
  ]
}
```

The following table describes the attributes that are obtained by a request that gets only attributes that fall under basic information:

| Attribute | Type | Description |
|--------------------|--------|---|
| hostGroupId | string | Object ID for the host group or iSCSI target |
| portId | string | Port number |
| hostGroupNumber | int | Host group number of the port (for the iSCSI target, target ID) |
| hostGroupName | string | Host group name (for the iSCSI target, target ID) If you do not specify the <code>hostGroupNumberList</code> parameter, only the first 16 characters are obtained. |
| iscsiName | string | iSCSI name of the iSCSI target of the port This attribute is obtained only if you specify the <code>hostGroupNumberList</code> parameter. |
| authenticationMode | string | Authentication mode for the iSCSI target |

| Attribute | Type | Description |
|-----------------------------------|--------|--|
| | | <p>This attribute is obtained only if you specify the <code>hostGroupNumberList</code> parameter.</p> <ul style="list-style-type: none"> ▪ CHAP: CHAP-authentication mode ▪ NONE: No-authentication mode ▪ BOTH: Both CHAP-authentication mode and no-authentication mode |
| <code>iscsiTargetDirection</code> | string | <p>Direction of CHAP authentication for the iSCSI target</p> <p>This attribute is obtained only if you specify the <code>hostGroupNumberList</code> parameter.</p> <ul style="list-style-type: none"> ▪ S: One-way (The iSCSI target authenticates the iSCSI initiator.) ▪ D: Mutual (The iSCSI target and the iSCSI initiator authenticate each other.) |

The following coding example obtains all attributes:

The following is an example of the output generated from the processing to get information about host groups or iSCSI targets of all ports:

```
{
  "data": [
    {
      "hostGroupId": "CL1-A,0",
      "portId": "CL1-A",
      "hostGroupNumber": 0,
      "hostGroupName": "hostA",
      "hostMode": "WIN",
      "hostModeOptions": [
        1,
        2
      ]
    },
    {
      "hostGroupId": "CL1-B,0",
      "portId": "CL1-B",
      "hostGroupNumber": 0,
      "hostGroupName": "hostB",
      "hostMode": "LINUX/IRIX"
    }
  ]
}
```

The following is an output example when information about the host group or the iSCSI target created for the specified port number is obtained:

```
{
  "data": [
    {
      "hostGroupId": "CL1-A,0",
      "portId": "CL1-A",
      "hostGroupNumber": 0,
      "hostGroupName": "hostA",
      "hostMode": "WIN",
      "hostModeOptions": [
        1,
        2
      ]
    },
    {
      "hostGroupId": "CL1-A,1",
      "portId": "CL1-A",
      "hostGroupNumber": 1,
      "hostGroupName": "hostB",
      "hostMode": "LINUX/IRIX"
    }
  ]
}
```

The following is an example of the output generated when information about resource groups is obtained:

In this example, information is also obtained about host group numbers for which no host group or iSCSI target has been created.

```
{
  "data": [
    {
      "hostGroupId": "CL1-A,0",
      "portId": "CL1-A",
      "hostGroupNumber": 0,
      "hostGroupName": "hostA",
      "hostMode": "WIN",
      "hostModeOptions": [
        1,
        2
      ],
      "resourceGroupId": 1,
      "isDefined": true
    },
    {
      "hostGroupId": "CL1-A,1",
```

```

    "portId": "CL1-A",
    "hostGroupNumber": 1,
    "hostGroupName": "-",
    "resourceGroupId": 2,
    "isDefined": false
  }
]
}

```

The following table describes the attributes that are obtained by a request that gets all attributes:

| Attribute | Type | Description |
|----------------------|--------|---|
| hostGroupId | string | Object ID for the host group or iSCSI target |
| portId | string | Port number |
| hostGroupNumber | int | Host group number of the port (for the iSCSI target, target ID) |
| hostGroupName | string | Host group name (for the iSCSI target, target ID) |
| iscsiName | string | iSCSI name of the iSCSI target of the port This information is obtained only when the <code>portId</code> parameter is specified. |
| authenticationMode | string | Authentication mode for the iSCSI target This information is obtained only when the <code>portId</code> parameter is specified. <ul style="list-style-type: none"> ▪ CHAP: CHAP-authentication mode ▪ NONE: No-authentication mode ▪ BOTH: Both CHAP-authentication mode and no-authentication mode |
| iscsiTargetDirection | string | Direction of CHAP authentication for the iSCSI target This information is obtained only when the <code>portId</code> parameter is specified. <ul style="list-style-type: none"> ▪ S: One-way (The iSCSI target authenticates the iSCSI initiator.) ▪ D: Mutual (The iSCSI target and the iSCSI initiator authenticate each other.) |

| Attribute | Type | Description |
|-----------------|---------|--|
| hostMode | string | <p>Host mode for setting the host adapter of the host group</p> <p>This attribute is obtained if the host group name is defined.</p> <p>For details on the values to be obtained, see the description of the API function for changing the host group or iSCSI target settings.</p> |
| hostModeOptions | int[] | <p>Number of options for setting the host mode option of the host group</p> <p>This information is obtained only when the <code>portId</code> parameter is specified.</p> <p>This attribute is obtained if the host group name is defined.</p> <p>For details on the number to be obtained, see the <i>Provisioning Guide for Open Systems</i>, or the <i>Provisioning Guide</i>.</p> |
| resourceGroupId | int | <p>ID of the resource group to which the host group or iSCSI target belongs</p> <p>This information is obtained only when <code>detailInfoType=resourceGroup</code> is specified for the query.</p> |
| isDefined | boolean | <p>Whether the host group or iSCSI target has been created</p> <p>This information is obtained only when <code>detailInfoType=resourceGroup</code> is specified for the query.</p> <ul style="list-style-type: none"> ▪ <code>true</code>: The host group or iSCSI target has been created. ▪ <code>false</code>: The host group or iSCSI target has not been created. |

Status codes

For details on the status codes of the request for this operation, see the description on HTTP status codes.

Coding example

When getting information about host groups or iSCSI targets of all ports:

```
curl -v -H "Accept:application/json" -H "Content-Type:application/json" -H
"Authorization:Session d7b673af189048468c5af9bcf3bbbb6f" -X GET https://
192.0.2.100/ConfigurationManager/v1/objects/host-groups
```

When information about the host group or the iSCSI target created for the specified port number is obtained:

```
curl -v -H "Accept:application/json" -H "Content-Type:application/json" -H
"Authorization:Session d7b673af189048468c5af9bcf3bbbb6f" -X GET https://
192.0.2.100/ConfigurationManager/v1/objects/host-groups?portId=CL1-A
```

When obtaining information about resource groups:

In this example, information is also obtained about host group numbers for which no host group or iSCSI target has been created.

```
curl -v -H "Accept:application/json" -H "Content-Type:application/json" -H
"Authorization:Session d7b673af189048468c5af9bcf3bbbb6f" -X GET https://
192.0.2.100/ConfigurationManager/v1/objects/host-groups?portId=CL1-
A&isUndefined=true&detailInfoType=resourceGroup
```

Getting information about a specific host group or iSCSI target

The following request gets information by specifying the host group number of the port or the target ID of the iSCSI target.

Execution permission

Storage Administrator (View Only)

Request line

```
GET base-URL/v1/objects/host-groups/object-ID
```

Request message**Object ID**

Specify the `hostGroupId` value obtained by getting information about the host groups or iSCSI targets. You can also specify the following attributes and connect them with commas:

```
portId,hostGroupNumber
```

| Attribute | Type | Description |
|-----------------|--------|--|
| portId | string | (Required) Port number |
| hostGroupNumber | int | (Required) Host group number of the port (for the iSCSI target, target ID) |

Query parameters

None.

Body

None.

Response message**Body**

The following is an example of the output generated when getting information by specifying the port number and the host group number:

```
{
  "hostGroupId": "CL1-A,0",
  "portId": "CL1-A",
  "hostGroupNumber": 0,
  "hostGroupName": "hostA",
  "hostMode": "WIN",
  "hostModeOptions": [
    1,
    2
  ]
}
```

For an iSCSI target, the following is an example of the output generated when getting information by specifying the port number and the target ID:

```
{
  "hostGroupId": "CL1-A,0",
  "portId": "CL1-A",
  "hostGroupNumber": 0,
  "hostGroupName": "hostA",
  "iscsiName": "iqn.rest.example.of.iqn.host",
  "authenticationMode": "CHAP",
  "iscsiTargetDirection": "S",
  "hostMode": "WIN",
  "hostModeOptions": [
    1,
```

```

2
]
}

```

| Attribute | Type | Description |
|----------------------|--------|---|
| hostGroupId | string | Object ID for the host group or iSCSI target |
| portId | string | Port number |
| hostGroupNumber | int | Host group number of the port (for the iSCSI target, target ID) |
| hostGroupName | string | Host group name (for the iSCSI target, target ID) |
| iscsiName | string | iSCSI name of the iSCSI target of the port This information is obtained in the case of an iSCSI port. |
| authenticationMode | string | Authentication mode for the iSCSI target This information is obtained in the case of an iSCSI port. <ul style="list-style-type: none"> ▪ CHAP: CHAP-authentication mode ▪ NONE: No-authentication mode ▪ BOTH: Both CHAP-authentication mode and no-authentication mode |
| iscsiTargetDirection | string | Direction of CHAP authentication for the iSCSI target This information is obtained in the case of an iSCSI port. <ul style="list-style-type: none"> ▪ S: One-way (The iSCSI target authenticates the iSCSI initiator.) ▪ D: Mutual (The iSCSI target and the iSCSI initiator authenticate each other.) |
| hostMode | string | Host mode for setting the host adapter of the host group For details on the values to be obtained, see the description of the API function for changing the host group or iSCSI target settings. |
| hostModeOptions | int[] | Number of options for setting the host mode option of the host group For details on the number to be obtained, see the <i>Provisioning Guide for Open Systems</i> , or the <i>Provisioning Guide</i> . |

Status codes

For details on the status codes of the request for this operation, see the description on HTTP status codes.

Coding example

```
curl -v -H "Accept:application/json" -H "Content-Type:application/json" -H
"Authorization:Session d7b673af189048468c5af9bcf3bbbb6f" -X GET https://
192.0.2.100/ConfigurationManager/v1/objects/host-groups/CL1-A,0
```

Getting a list of host modes and host mode options

The following request acquires a list of host modes and host mode options used for the storage system.

Execution permission

Storage Administrator (View Only)

Request line

```
GET base-URL/objects/supported-host-modes/instance
```

Request message**Object ID**

Specify *instance*.

If an object has only one instance, *instance* is the fixed value that specifies the object ID.

Query parameters

None.

Body

None.

Response message**Body**

```
{
  "hostModes": [
    {
      "hostModeId": 0,
      "hostModeName": "Standard",
      "hostModeDisplay": "LINUX/IRIX"
    }
  ]
}
```

```

    },
    {
      "hostModeId": 1,
      "hostModeName": "(Deprecated) VMware",
      "hostModeDisplay": "VMWARE"
    }
  ],
  "hostModeOptions": [
    {
      "hostModeOptionId": 2,
      "hostModeOptionDescription": "VERITAS Database Edition/
Advanced Cluster"
    },
    {
      "hostModeOptionId": 6,
      "hostModeOptionDescription": "TPRLO"
    }
  ]
}

```

| Attribute | Type | Description |
|-----------------|----------|--|
| hostModes | object[] | <p>The following attributes related to the host mode are output:</p> <ul style="list-style-type: none"> ▪ hostModeId (int) Host mode number ▪ hostModeName (string) Identification name of the host mode ▪ hostModeDisplay (string) Host mode value Value to be used to specify the host mode |
| hostModeOptions | object[] | <p>The following attributes related to the host mode option are output:</p> <ul style="list-style-type: none"> ▪ hostModeOptionId (int) Host mode option number ▪ hostModeOptionDescription (string) Description of the host mode option |

Status codes

For details on the status codes of the request for this operation, see the description of HTTP status codes.

Coding example

```
curl -v -H "Accept:application/json" -H "Content-Type:application/json" -H
"Authorization:Session d7b673af189048468c5af9bcf3b6666f" -X GET https://
192.0.2.100/ConfigurationManager/v1/objects/supported-host-modes/instance
```

Creating a host group or an iSCSI target

The following request creates a host group for the port. For an iSCSI port, this request creates the iSCSI target and the iSCSI name. The host mode and the host mode option can also be specified at the same time when the host group and the iSCSI target are created.

Execution permission

Storage Administrator (Provisioning)

Request line

```
POST base-URL/v1/objects/host-groups
```

Request message**Object ID**

None.

Query parameters

None.

Body

The following coding example creates a host group:

```
{
  "portId": "CL1-A",
  "hostGroupName": "My_REST_API_HOST",
  "hostModeOptions": [12,33],
  "hostMode": "AIX"
}
```

The following coding example creates an iSCSI target:

```
{
  "portId": "CL1-A",
  "hostGroupName": "My_REST_API_HOST",
  "iscsiName": "iqn.20150908iscsi"
}
```

| Attribute | Type | Description |
|-----------------|--------|---|
| portId | string | (Required) Port number |
| hostGroupNumber | int | (Optional) Host group number Specify a decimal (base 10) number in the range from 0 to 254. If this attribute is omitted, a value is automatically set. For iSCSI ports, this number is called target ID. |
| hostGroupName | string | (Required) Host group name or iSCSI target name <ul style="list-style-type: none"> ▪ To create a host group Specify a host group name consisting of 1 to 64 characters. ▪ To create an iSCSI target Specify the iSCSI target name consisting of 1 to 32 characters. For the iSCSI target, you cannot specify the default name of the iSCSI target whose ID is 0. <p>You can use the following characters.</p> <ul style="list-style-type: none"> ▪ Alphanumeric characters ▪ The following symbols: . @ _ : \ - <p>The label cannot start with a hyphen (-).</p> <p>You cannot create host groups or iSCSI targets that have the same name for a single port.</p> |
| iscsiName | string | (Optional) iSCSI name Specify this item when creating an iSCSI target. If this attribute is omitted, a value is automatically set. |

| Attribute | Type | Description |
|-----------------|---------|---|
| | | <p>Specify this item in the iqn or eui format.</p> <ul style="list-style-type: none"> ▪ iqn format <p>Specify a value in the range from 5 to 223. You can use the following characters:</p> <p>alphanumeric characters (lowercase), periods (.), hyphens (-), and colons (:)</p> <p>Specification example: iqn.rest.example.of.iqn.form</p> ▪ eui format <p>After "eui.", specify a hexadecimal number. Specify a value consisting of 20 characters.</p> <p>Specification example: eui.0900ABDC32598D26</p> |
| hostMode | string | <p>(Optional) Host mode</p> <p>The specifiable values are as follows:</p> <p>HP-UX, SOLARIS, AIX, WIN, LINUX/IRIX, TRU64, OVMS, NETWARE, VMWARE, VMWARE_EX, WIN_EX</p> <p>If this attribute is omitted, LINUX/IRIX is set.</p> |
| hostModeOptions | int[] | <p>(Optional) Number of options for setting host mode options</p> <p>For the specifiable numbers, see the <i>Provisioning Guide for Open Systems</i>, or the <i>Provisioning Guide</i>.</p> <p>When specifying more than one attribute, use a comma to separate the values.</p> <p>When specifying this attribute, make sure to also specify the <code>hostMode</code> attribute.</p> |
| isQuickCreating | boolean | <p>(Optional) When creating a host group by specifying <code>hostGroupNumber</code>, if you want to omit the process of checking whether the host group is created, specify <code>true</code>. If you specify <code>true</code> and a host group or iSCSI target already exists for the specified <code>hostGroupNumber</code>, the setting is overwritten.</p> <ul style="list-style-type: none"> ▪ <code>true</code>: Does not check whether the host group has been created. ▪ <code>false</code>: Checks whether the host group has been created. <p>If this attribute is omitted, <code>false</code> is assumed.</p> |

| Attribute | Type | Description |
|-----------|------|--|
| | | If <code>hostGroupNumber</code> is not specified, this attribute is ignored. |

Response message

Body

A job object is returned. For details on attributes other than `affectedResources`, see the section explaining job objects.

| Attribute | Description |
|--------------------------------|---|
| <code>affectedResources</code> | URL of the created host group or iSCSI target |

Status codes

The following table describes the meaning of the status code of the request for this operation. For details on other status codes, see the section explaining HTTP status codes.

| Status code | Message | Description |
|-------------|----------|--|
| 409 | Conflict | A host group already exists for the specified host group number. |

Coding example

```
curl -v -H "Accept:application/json" -H "Content-Type:application/json" -H
"Authorization:Session d7b673af189048468c5af9bcf3bbbb6f" -X POST --data-
binary @./InputParameters.json https://192.0.2.100/ConfigurationManager/v1/
objects/host-groups
```

Changing the host group or iSCSI target settings

The following request sets the host mode or host mode option for a host group or an iSCSI target. For iSCSI targets, settings related to CHAP authentication can also be specified.

Execution permission

Storage Administrator (Provisioning)

Request line

```
PATCH base-URL/v1/objects/host-groups/object-ID
```

Request message**Object ID**

Specify the `hostGroupId` value obtained by getting information about the host group or the iSCSI target. You can also specify the following attributes and connect them with commas:

```
portId,hostGroupName
```

| Attribute | Type | Description |
|---------------|--------|--|
| portId | string | (Required) Port number |
| hostGroupName | int | (Required) Host group number (target ID for an iSCSI port) |

Query parameters

None.

Body

When setting the host mode option of the host group:

```
{
  "hostMode": "WIN",
  "hostModeOptions": [12,33]
}
```

When resetting the host mode option of the host group:

```
{
  "hostMode": "HP-UX",
  "hostModeOptions": [-1]
}
```

When setting the CHAP authentication mode and CHAP authentication direction for the iSCSI target:

```
{
  "hostMode": "WIN",
  "authenticationMode": "CHAP",
  "iscsiTargetDirection": "D"
}
```

| Attribute | Type | Description |
|----------------------|--------|---|
| hostMode | string | (Required) Host mode The specifiable types are as follows: HP-UX, SOLARIS, AIX, WIN, LINUX/IRIX, TRU64, OVMS, NETWARE, VMWARE, VMWARE_EX, or WIN_EX |
| hostModeOptions | int[] | (Optional) Number of options for setting host mode options The values are updated (overwritten) by the specified values. When specifying values, specify all the numbers for the host mode options that you want to set. For details on the specifiable numbers, see the <i>Provisioning Guide for Open Systems</i> , or the <i>Provisioning Guide</i> . To specify multiple option values, separate the values by commas. If you set -1, the set host mode option will be reset. |
| authenticationMode | string | (Optional) CHAP authentication mode for the iSCSI target The specifiable types are as follows: <ul style="list-style-type: none"> ▪ CHAP: CHAP-authentication mode ▪ NONE: No-authentication mode ▪ BOTH: Both CHAP-authentication mode and no-authentication mode |
| iscsiTargetDirection | string | (Optional) Direction of CHAP authentication for the iSCSI target The specifiable types are as follows: S: Unidirectional authentication mode (The iSCSI target authenticates the iSCSI initiator.) D: Bidirectional authentication mode (The iSCSI target and the iSCSI initiator authenticate each other.) |

Response message**Body**

A job object is returned. For details on attributes other than `affectedResources`, see the section explaining job objects.

| Attribute | Description |
|-------------------|---|
| affectedResources | URL of the changed host group or iSCSI target |

Action template

None.

Status codes

For details on the status codes of the request for this operation, see the description on HTTP status codes.

Coding example

```
curl -v -H "Accept:application/json" -H "Content-Type:application/json" -H
"Authorization:Session d7b673af189048468c5af9bcf3b66b6f" -X PATCH --data-
binary @./InputParameters.json https://192.0.2.100/ConfigurationManager/v1/
objects/host-groups/CL1-A,0
```

Deleting a host group or the iSCSI target

The following request deletes the WWN and LUN settings of a host group or of a host registered in a host group. Alternatively, the request deletes the LUN setting and iSCSI name of an iSCSI target or of a host (iSCSI initiator) registered for the iSCSI target. If the host group number of the host group to be deleted (target ID for the iSCSI port) is 0, the settings for the host group or iSCSI target are returned to their default values.

Execution permission

Storage Administrator (Provisioning)

Request line

```
DELETE base-URL/v1/objects/host-groups/object-ID
```

Request message**Object ID**

Specify the `hostGroupId` value obtained by getting information about the host group or the iSCSI target. You can also specify the following attributes and connect them with commas:

```
portId,hostGroupNumber
```

| Attribute | Type | Description |
|-----------------|--------|--|
| portId | string | (Required) Port number |
| hostGroupNumber | int | (Required) Host group number (target ID for an iSCSI port) |

Query parameters

None.

Body

None.

Response message**Body**

A job object is returned. For details on attributes other than `affectedResources`, see the section explaining job objects.

| Attribute | Description |
|--------------------------------|---|
| <code>affectedResources</code> | URL of the deleted host group or iSCSI target |

Status codes

For details on the status codes of the request for this operation, see the description on HTTP status codes.

Coding example

```
curl -v -H "Accept:application/json" -H "Content-Type:application/json" -H
"Authorization:Session d7b673af189048468c5af9bcf3bbbb6f" -X DELETE
https://192.0.2.100/ConfigurationManager/v1/objects/host-groups/CL1-A,0
```

Getting WWN information

Specifying a port and host group, the following request gets the information about the WWN registered for the host group.

Execution permission

Storage Administrator (View Only)

Request line

```
GET base-URL/v1/objects/host-wwns
```

Request message**Object ID**

None.

Query parameters

| Parameter | Type | Filter Condition |
|---------------------|--------|--|
| portId | string | (Required) Port number |
| hostGroupNumber | int | (Optional) The host group number You must specify one of the following parameters: this parameter, the <code>hostGroupName</code> parameter, or the <code>hostGroupNumberList</code> parameter. |
| hostGroupName | string | (Optional) The host group name You must specify one of the following parameters: this parameter, the <code>hostGroupNumber</code> parameter, or the <code>hostGroupNumberList</code> parameter. |
| hostGroupNumberList | string | (Optional) The host group number You can obtain information quickly by specifying this parameter. To specify multiple IDs, delimit each ID by using a comma. You must specify one of the following parameters: this parameter, the <code>hostGroupNumber</code> parameter, or the <code>hostGroupName</code> parameter. |

Body

None.

Response message**Body**

```
{
  "data": [
    {
      "hostWwnId": "CL1-A,0,000000102ccec9",

```

```

    "portId": "CL1-A",
    "hostGroupNumber": 0,
    "hostGroupName": "my@host999",
    "hostWwn": "000000102cceccc9",
    "wwnNickname": "Myhostwwnsecret"
  },
  {
    "hostWwnId": "CL1-A,0,1111111111111111",
    "portId": "CL1-A",
    "hostGroupNumber": 0,
    "hostGroupName": "my@host999",
    "hostWwn": "1111111111111111",
    "wwnNickname": "formyhost"
  }
]
}

```

| Attribute | Type | Description |
|-----------------|--------|---|
| hostWwnId | string | Object ID for the WWN |
| portId | string | Port number |
| hostGroupNumber | int | Host group number of the port |
| hostGroupName | string | Host group name of the port |
| hostWwn | string | WWN of the host bus adapter registered for the host group |
| wwnNickname | string | WWN nickname |

Status codes

For details on the status codes of the request for this operation, see the section explaining HTTP status codes.

Coding example

```

curl -v -H "Accept:application/json" -H "Content-Type:application/json" -H
"Authorization:Session d7b673af189048468c5af9bcf3b6bb6f" -X GET "https://
192.0.2.100/ConfigurationManager/v1/objects/host-wwns?portId=CL1-
A&hostGroupNumber=0"

```

Getting information about a specific WWN

The following request gets information about the specified WWN.

Execution permission

Storage Administrator (View Only)

Request line

```
GET base-URL/v1/objects/host-wwns/object-ID
```

Request message

Object ID

Specify the `hostWwnId` value obtained by getting information about the WWN. You can also specify the following attributes and connect them with commas:

```
portId,hostGroupNumber,hostWwn
```

| Attribute | Type | Description |
|-----------------|--------|---|
| portId | string | (Required) Port number |
| hostGroupNumber | int | (Required) The host group number |
| hostWwn | string | (Required) The WWN of the host bus adapter Specify the attribute without using colons (:). |

Query parameters

None.

Body

None.

Response message

Body

```
{
  "hostWwnId": "CL1-A,0,000000102ccec9",
  "portId": "CL1-A",
  "hostGroupNumber": 0,
  "hostGroupName": "my@host999",
}
```

```

"hostWwn": "000000102ccec9",
"wwnNickname": "Myhostwwnsecret"
}

```

| Attribute | Type | Description |
|-----------------|--------|---|
| hostWwnId | string | Object ID for the WWN |
| portId | string | Port number |
| hostGroupNumber | int | Host group number of the port |
| hostGroupName | string | Host group name of the port |
| hostWwn | string | WWN of the host bus adapter registered for the host group |
| wwnNickname | string | WWN nickname |

Status codes

For details on the status codes of the request for this operation, see the description on HTTP status codes.

Coding example

```

curl -v -H "Accept:application/json" -H "Content-Type:application/json" -H
"Authorization:Session d7b673af189048468c5af9bcf3b66f" -X GET https://
192.0.2.100/ConfigurationManager/v1/objects/host-wwns/CL1-A,0,
000000102ccec9

```

Registering a WWN for the host group

The following request registers the host bus adapter WWN for the host group of the specified port.

Execution permission

Storage Administrator (Provisioning)

Request line

```
POST base-URL/v1/objects/host-wwns
```

Request message**Object ID**

None.

Query parameters

None.

Body

```
{
  "hostWwn": "210003e08b0256f9",
  "portId": "CL1-A",
  "hostGroupNumber": 5
}
```

| Attribute | Type | Description |
|-----------------|--------|---|
| hostWwn | string | (Required) The WWN of the host bus adapter Specify a hexadecimal number consisting of 16 characters. You can specify the number by using colons (:) as separators. |
| portId | string | (Required) Port number |
| hostGroupNumber | int | (Required) The host group number |

Response message**Body**

A job object is returned. For details on attributes other than `affectedResources`, see the section explaining job objects.

| Attribute | Description |
|-------------------|---------------------------|
| affectedResources | URL of the registered WWN |

Status codes

For details on the status codes of the request for this operation, see the description on HTTP status codes.

Coding example

```
curl -v -H "Accept:application/json" -H "Content-Type:application/json" -H
"Authorization:Session d7b673af189048468c5af9bcf3bbbb6f" -X POST --data-
binary @./InputParameters.json https://192.0.2.100/ConfigurationManager/v1/
objects/host-wwns
```

Setting the nickname for a WWN

The following request sets the nickname for a WWN registered in the host group. You can also delete the nickname that is already set.

Execution permission

Storage Administrator (Provisioning)

Request line

```
PATCH base-URL/v1/objects/host-wwns/object-ID
```

Request message**Object ID**

Specify the value of `hostWwnId` that was obtained by the processing to get information about the WWN. You can also specify the following attributes and connect them with commas:

portId, hostGroupNumber, hostWwn

| Attribute | Type | Description |
|-----------------|--------|---|
| portId | string | (Required) Port number |
| hostGroupNumber | int | (Required) Host group number of the port |
| hostWwn | string | (Required) WWN of the host bus adapter registered in the host group |

Query parameters

None.

Body

When setting the nickname for the WWN:

```
{
  "wwnNickname": "REST_API_Created"
}
```

When deleting the nickname from the WWN:

```
{
  "wwnNickname": ""
}
```

| Attribute | Type | Description |
|-----------------|--------|---|
| wwnNickna me | string | <p>(Required) Specify a WWN nickname consisting of 1 to 64 characters.</p> <p>You can use the following characters.</p> <ul style="list-style-type: none"> ▪ Alphanumeric characters ▪ The following symbols: . @ _ : , \ - <p>The label cannot start with a hyphen (-).</p> <p>You cannot specify the nickname that is used for other WWN of the same port.</p> <p>To delete the nickname from the WWN, specify a null character string.</p> |

Response message**Body**

A job object is returned. For details on attributes other than `affectedResources`, see the description on job objects.

| Attribute | Description |
|-----------------------|--|
| affectedResourc es | URL of the WWN whose settings were changed |

Action template

None.

Status codes

For details on the status codes of the request for this operation, see the description on HTTP status codes.

Coding example

```
curl -v -H "Accept:application/json" -H "Content-Type:application/json" -H
"Authorization:Session d7b673af189048468c5af9bcf3bbbb6f" -X PATCH --data-
binary @./InputParameters.json https://192.0.2.100/ConfigurationManager/v1/
objects/host-wwns/CL1-A,0,1212121212121212
```

Deleting the WWN from a host group

The following request deletes the WWN information registered for the host group of the specified port.

Execution permission

Storage Administrator (Provisioning)

Request line

```
DELETE base-URL/v1/objects/host-wwns/object-ID
```

Request message**Object ID**

Specify the `hostWwnId` value obtained by getting information about the WWN. You can also specify the following attributes and connect them with commas:

```
portId,hostGroupNumber,hostWwn
```

| Attribute | Type | Description |
|-----------------|--------|---|
| portId | string | (Required) Port number |
| hostGroupNumber | int | (Required) The host group number |
| hostWwn | string | (Required) The WWN of the host bus adapter Specify the attribute without using colons (:). |

Query parameters

None.

Body

None.

Response message**Body**

A job object is returned. For details on attributes other than `affectedResources`, see the section explaining job objects.

| Attribute | Description |
|--------------------------------|------------------------|
| <code>affectedResources</code> | URL of the deleted WWN |

Status codes

For details on the status codes of the request for this operation, see the description on HTTP status codes.

Coding example

```
curl -v -H "Accept:application/json" -H "Content-Type:application/json" -H
"Authorization:Session d7b673af189048468c5af9bcf3b66b6f" -X DELETE
https://192.0.2.100/ConfigurationManager/v1/objects/host-wwns/CL1-A,5,
210003e08b0256f9
```

Getting iSCSI names

Specifying a port and iSCSI target, the following request gets the iSCSI name information registered for the iSCSI target.

Execution permission

Storage Administrator (View Only)

Request line

```
GET base-URL/v1/objects/host-iscsis
```

Request message**Object ID**

None.

Query parameters

| Parameter | Type | Filter Condition |
|----------------------|---------|---|
| portId | string | (Required) Port number |
| hostGroupNumber | int | (Optional) Target ID of the iSCSI target You must specify one of the following parameters: this parameter, the <code>hostGroupName</code> parameter, or the <code>hostGroupNumberList</code> parameter. |
| hostGroupName | string | (Optional) Name of the iSCSI target You must specify one of the following parameters: this parameter, the <code>hostGroupNumber</code> parameter, or the <code>hostGroupNumberList</code> parameter. |
| hostGroupNumberList | string | (Optional) Target IDs of iSCSI targets You can obtain information quickly by specifying this parameter. To specify multiple IDs, delimit each ID by using a comma. You must specify one of the following parameters: this parameter, the <code>hostGroupNumber</code> parameter, or the <code>hostGroupName</code> parameter. |
| displayHostGroupName | boolean | (Optional) If you specify the <code>hostGroupNumberList</code> parameter, specify whether to get the names of the iSCSI targets (the values of the <code>hostGroupName</code> attribute). If you specify <code>false</code> , the processing will take shorter than if you were to specify <code>true</code> . <ul style="list-style-type: none"> ▪ <code>true</code>: Obtain the names of the iSCSI targets. ▪ <code>false</code>: Do not obtain the names of the iSCSI targets. If you specify this parameter but do not specify the <code>hostGroupNumberList</code> parameter, this parameter will be ignored. If this parameter is omitted, the value <code>true</code> is assumed. |

Body

None.

Response message**Body**

```
{
  "data": [
    {
      "hostIscsiId": "CL1-D,1,iqn.1994-05.com.redhat%3A496799ba93",
      "portId": "CL1-D",
      "hostGroupNumber": 1,
      "hostGroupName": "1D-G00",
      "iscsiName": "iqn.1994-05.com.redhat:496799ba93",
      "iscsiNickname": "a_a"
    },
    {
      "hostIscsiId": "CL1-D,1,iqn.1994-05.com.redhat
%3Aa7526e46aac.target",
      "portId": "CL1-D",
      "hostGroupNumber": 1,
      "hostGroupName": "1D-G00",
      "iscsiName": "iqn.1994-05.com.redhat:a7526e46aac.target",
      "iscsiNickname": "a_a"
    }
  ]
}
```

| Attribute | Type | Description |
|-----------------|--------|--|
| hostIscsiId | string | Object ID for the iSCSI name |
| portId | string | Port number |
| hostGroupNumber | int | Target ID of the iSCSI target |
| hostGroupName | string | Name of the iSCSI target This attribute will not be obtained if the <code>hostGroupNumberList</code> parameter is specified as a query parameter and <code>false</code> is specified for the <code>displayHostGroupName</code> parameter. |
| iscsiName | string | iSCSI name of the host bus adapter (iSCSI initiator) registered for the iSCSI target |
| iscsiNickname | string | iSCSI nickname |

Status codes

For details on the status codes of the request for this operation, see the section explaining HTTP status codes.

Coding example

```
curl -v -H "Accept:application/json" -H "Content-Type:application/json" -H
"Authorization:Session d7b673af189048468c5af9bcf3b6bb6f" -X GET "https://
192.0.2.100/ConfigurationManager/v1/objects/host-iscsis?portId=CL1-
D&hostGroupNumber=1"
```

Getting information about a specific iSCSI name

If you specify a port, iSCSI target, and iSCSI name, the following request gets information about that specific iSCSI name.

Execution permission

Storage Administrator (View Only)

Request line

```
GET base-URL/v1/objects/host-iscsis/object-ID
```

Request message**Object ID**

Specify the `hostIscsiId` value obtained by getting the iSCSI name. You can also specify the following attributes and connect them with commas:

```
portId,hostGroupNumber,iscsiName
```

| Attribute | Type | Description |
|-----------------|--------|---|
| portId | string | (Required) Port number |
| hostGroupNumber | int | (Required) Target ID of the iSCSI target |
| iscsiName | string | (Required) iSCSI name of the host bus adapter (iSCSI initiator) |

Query parameters

None.

Body

None.

Response message**Body**

```
{
  "hostIscsiId": "CL1-D,1,iqn.1994-05.com.redhat%3A496799ba93",
  "portId": "CL1-D",
  "hostGroupNumber": 1,
  "hostGroupName": "1D-G00",
  "iscsiName": "iqn.1994-05.com.redhat:496799ba93",
  "iscsiNickname": "a_a"
}
```

| Attribute | Type | Description |
|-----------------|--------|--|
| hostIscsiId | string | Object ID for the iSCSI name |
| portId | string | Port number |
| hostGroupNumber | int | Target ID of the iSCSI target |
| hostGroupName | string | Name of the iSCSI target |
| iscsiName | string | iSCSI name of the host bus adapter (iSCSI initiator) registered for the iSCSI target |
| iscsiNickname | string | iSCSI nickname |

Status codes

For details on the status codes of the request for this operation, see the description on HTTP status codes.

Coding example

```
curl -v -H "Accept:application/json" -H "Content-Type:application/json" -H
"Authorization:Session d7b673af189048468c5af9bcf3b66b6f" -X GET https://
192.0.2.100/ConfigurationManager/v1/objects/host-iscsis/CL1-D,1,iqn.1994-
05.com.redhat%3A496799ba93
```

Registering the iSCSI name for the iSCSI target

For the iSCSI target of the specified port, the following request registers the iSCSI name of the host on the initiator side.

Execution permission

Storage Administrator (Provisioning)

Request line

```
POST base-URL/v1/objects/host-iscsis
```

Request message

Object ID

None.

Query parameters

None.

Body

```
{
  "portId": "CL1-D",
  "hostGroupNumber": 1,
  "iscsiName": "iqn.myrestapiiscsi20150907"
}
```

| Attribute | Type | Description |
|-----------|--------|---|
| iscsiName | string | (Required) iSCSI name of the host bus adapter (iSCSI initiator) |

| Attribute | Type | Description |
|-----------------|--------|---|
| | | <p>Specify this item in the iqn or eui format.</p> <ul style="list-style-type: none"> iqn format <p>Specify a value in the range from 5 to 223. You can use the following characters:</p> <p>Alphanumeric characters (lowercase), periods (.), hyphens (-), and colons (:)</p> <p>Specification example: iqn.2014-04.jp.co.hitachi:xxx.h70.i.62510.1a.ff</p> <ul style="list-style-type: none"> eui format <p>After "eui.", specify a hexadecimal number. Specify a value consisting of 20 characters.</p> <p>Specification example: eui.ABCDEF1234567890</p> |
| portId | string | (Required) Port number |
| hostGroupNumber | int | (Required) Target ID of the iSCSI target |

Response message

Body

A job object is returned. For details on attributes other than `affectedResources`, see the section explaining job objects.

| Attribute | Description |
|-------------------|----------------------------------|
| affectedResources | URL of the registered iSCSI name |

Status codes

For details on the status codes of the request for this operation, see the description on HTTP status codes.

Coding example

```
curl -v -H "Accept:application/json" -H "Content-Type:application/json" -H "Authorization:Session d7b673af189048468c5af9bcf3bbbb6f" -X POST --data-binary @./InputParameters.json https://192.0.2.100/ConfigurationManager/v1/objects/host-iscsis
```

Setting the nickname for an iSCSI name

The following request sets the nickname for an iSCSI name registered for the iSCSI target. You can also delete the nickname that is already set.

Execution permission

Storage Administrator (Provisioning)

Request line

```
PATCH base-URL/v1/objects/host-iscsis/object-ID
```

Request message

Object ID

Specify the value of `hostIscsiId` that was obtained by the processing to get information about the iSCSI name. You can also specify the attributes and connect them with commas as follows:

portId, hostGroupNumber, iscsiName

| Attribute | Type | Description |
|-----------------|--------|---|
| portId | string | (Required) Port number |
| hostGroupNumber | int | (Required) Target ID of the iSCSI target |
| iscsiName | string | (Required) iSCSI name of the host bus adapter (iSCSI initiator) registered for the iSCSI target |

Query parameters

None.

Body

When setting the nickname for the iSCSI name

```
{
  "iscsiNickname": "REST_API_Testing"
}
```

When deleting the nickname from the iSCSI name:

```
{
  "iscsiNickname": ""
}
```

| Attribute | Type | Description |
|---------------|--------|--|
| iscsiNickname | string | <p>(Required) Specify a nickname consisting of 1 to 32 characters for the iSCSI name of the host bus adapter.</p> <p>You can use the following characters.</p> <ul style="list-style-type: none"> ▪ Alphanumeric characters ▪ The following symbols: . @ _ \ - <p>The label cannot start with a hyphen (-).</p> <p>To delete the nickname from the iSCSI name, specify a null character string.</p> |

Response message

Body

A job object is returned. For details on attributes other than `affectedResources`, see the description on job objects.

| Attribute | Description |
|-------------------|---|
| affectedResources | URL of the iSCSI name whose settings were changed |

Action template

None.

Status codes

For details on the status codes of the request for this operation, see the description on HTTP status codes.

Coding example

```
curl -v -H "Accept:application/json" -H "Content-Type:application/json" -H
"Authorization:Session d7b673af189048468c5af9bcf3b66b6f" -X PATCH --data-
```

```
binary @./InputParameters.json https://192.0.2.100/ConfigurationManager/v1/objects/host-iscsis/CL1-B,0,iqn.20150907
```

Deleting the iSCSI name from the iSCSI target

The following request deletes the iSCSI name of the host bus adapter (iSCSI initiator) from the iSCSI target of the specified port.

Execution permission

Storage Administrator (Provisioning)

Request line

```
DELETE base-URL/v1/objects/host-iscsis/object-ID
```

Request message

Object ID

Specify the `hostIscsiId` value obtained by getting the iSCSI name. You can also specify the following attributes and connect them with commas:

```
portId,hostGroupNumber,iscsiName
```

| Attribute | Type | Description |
|-----------------|--------|---|
| portId | string | (Required) Port number |
| hostGroupNumber | int | (Required) Target ID of the iSCSI target |
| iscsiName | string | (Required) iSCSI name of the host bus adapter (iSCSI initiator) |

Query parameters

None.

Body

None.

Response message

Body

A job object is returned. For details on attributes other than `affectedResources`, see the section explaining job objects.

| Attribute | Description |
|-------------------|-------------------------------|
| affectedResources | URL of the deleted iSCSI name |

Status codes

For details on the status codes of the request for this operation, see the description on HTTP status codes.

Coding example

```
curl -v -H "Accept:application/json" -H "Content-Type:application/json" -H
"Authorization:Session d7b673af189048468c5af9bcf3bbbb6f" -X DELETE
https://192.0.2.100/ConfigurationManager/v1/objects/host-iscsis/CL1-D,1,
iqn.myrestapiiscsi20150907
```

Getting information about CHAP users

Using the specified port and iSCSI target, the following request gets the CHAP user information that is specified for the iSCSI target. Note that if the iSCSI target name or CHAP user name contains a single-byte space, the CHAP user name cannot be obtained.

Execution permission

Storage Administrator (View Only)

Request line

```
GET base-URL/v1/objects/chap-users
```

Request message

Object ID

None.

Query parameters

| Parameter | Type | Filter Condition |
|-----------------|--------|--|
| portId | string | (Required) Port number |
| hostGroupNumber | int | (Required) Target ID of the iSCSI target |

Body

None.

Response message**Body**

```
{
  "data": [
    {
      "chapUserId": "CL1-D,0,INI,TESTing",
      "portId": "CL1-D",
      "hostGroupNumber": 0,
      "hostGroupName": "1D-G00",
      "chapUserName": "TESTing",
      "wayOfChapUser": "INI"
    },
    {
      "chapUserId": "CL1-D,0,TAR,mychap",
      "portId": "CL1-D",
      "hostGroupNumber": 0,
      "hostGroupName": "1D-G00",
      "chapUserName": "mychap",
      "wayOfChapUser": "TAR"
    }
  ]
}
```

| Attribute | Type | Description |
|-----------------|--------|---|
| chapUserId | string | Object ID for the CHAP user |
| portId | string | Port number |
| hostGroupNumber | int | Target ID of the iSCSI target |
| hostGroupName | string | Name of the iSCSI target |
| chapUserName | string | CHAP user name |
| wayOfChapUser | string | Type of the CHAP user name <ul style="list-style-type: none"> ▪ TAR: The CHAP user name of the iSCSI target side ▪ INI: The CHAP user name of the host bus adapter (iSCSI initiator) side |

Status codes

For details on the status codes of the request for this operation, see the description on HTTP status codes.

Coding example

```
curl -v -H "Accept:application/json" -H "Content-Type:application/json" -H
"Authorization:Session d7b673af189048468c5af9bcf3bbbb6f" -X GET "https://
192.0.2.100/ConfigurationManager/v1/objects/chap-users?portId=CL1-
D&hostGroupNumber=0"
```

Getting information about a specific CHAP user

The following request gets information about the specified CHAP user. Note that if the iSCSI target name or CHAP user name contains a space, the CHAP user name cannot be obtained.

Execution permission

Storage Administrator (View Only)

Request line

```
GET base-URL/v1/objects/chap-users/object-ID
```

Request message**Object ID**

Specify the `chapUserId` value obtained by getting information about the CHAP user. You can also specify the following attributes and connect them with commas:

```
portId,hostGroupNumber,wayOfChapUser,chapUserName
```

| Attribute | Type | Description |
|-----------------|--------|--|
| portId | string | (Required) Port number |
| hostGroupNumber | int | (Required) Target ID of the iSCSI target |
| wayOfChapUser | string | (Required) Type of the CHAP user name <ul style="list-style-type: none"> ▪ TAR: The CHAP user name of the iSCSI target side ▪ INI: The CHAP user name of the host bus adapter (iSCSI initiator) side |

| Attribute | Type | Description |
|--------------|--------|-------------------------------|
| chapUserName | string | (Required) The CHAP user name |

Query parameters

None.

Body

None.

Response message**Body**

```
{
  "chapUserId": "CL1-D,0,INI,mychap",
  "portId": "CL1-D",
  "hostGroupNumber": 0,
  "hostGroupName": "1D-G00",
  "chapUserName": "mychap",
  "wayOfChapUser": "INI"
}
```

| Attribute | Type | Description |
|-----------------|--------|---|
| chapUserId | string | Object ID for the CHAP user |
| portId | string | Port number |
| hostGroupNumber | int | Target ID of the iSCSI target |
| hostGroupName | string | Name of the iSCSI target |
| chapUserName | string | CHAP user name |
| wayOfChapUser | string | Type of the CHAP user name <ul style="list-style-type: none"> ▪ TAR: The CHAP user name of the iSCSI target side ▪ INI: The CHAP user name of the host bus adapter (iSCSI initiator) side |

Status codes

For details on the status codes of the request for this operation, see the description on HTTP status codes.

Coding example

```
curl -v -H "Accept:application/json" -H "Content-Type:application/json" -H
"Authorization:Session d7b673af189048468c5af9bcf3b666f" -X GET https://
192.0.2.100/ConfigurationManager/v1/objects/chap-users/CL1-D,0,INI,mychap
```

Setting the CHAP user name for the iSCSI target

The following request sets the CHAP user name for the iSCSI target. Two types of CHAP user names can be set: the CHAP user name of the iSCSI target side and the CHAP user name of the host (iSCSI initiator) that connects to the iSCSI target.

Execution permission

Storage Administrator (Provisioning)

Request line

```
POST base-URL/v1/objects/chap-users
```

Request message**Object ID**

None.

Query parameters

None.

Body

The following coding example sets the CHAP user name for the iSCSI target side:

```
{
  "chapUserName": "MyRESTChapUser",
  "portId": "CL1-D",
  "hostGroupNumber": 1,
  "wayOfChapUser": "TAR"
}
```

| Attribute | Type | Description |
|--------------|--------|--|
| chapUserName | string | (Required) Specify a CHAP user name consisting of 1 to 223 characters. |
| portId | string | (Required) Port number |

| Attribute | Type | Description |
|-----------------|--------|--|
| hostGroupNumber | int | (Required) Target ID of the iSCSI target |
| wayOfChapUser | string | (Required) Type of the CHAP user name <ul style="list-style-type: none"> ▪ TAR: The CHAP user name of the iSCSI target side ▪ INI: The CHAP user name of the host bus adapter (iSCSI initiator) side |

Response message

Body

A job object is returned. For details on attributes other than `affectedResources`, see the section explaining job objects.

| Attribute | Description |
|-------------------|-----------------------------------|
| affectedResources | URL of the created CHAP user name |

Status codes

For details on the status codes of the request for this operation, see the description on HTTP status codes.

Coding example

```
curl -v -H "Accept:application/json" -H "Content-Type:application/json" -H "Authorization:Session d7b673af189048468c5af9bcf3b66b6f" -X POST --data-binary @./InputParameters.json https://192.0.2.100/ConfigurationManager/v1/objects/chap-users
```

Setting a secret for the CHAP user

The following request sets a secret for the specified CHAP user. If a secret is already set for the specified CHAP user, the current secret is overwritten.

Execution permission

Storage Administrator (Provisioning)

Request line

```
PATCH base-URL/v1/objects/chap-users/object-ID
```

Request message**Object ID**

Specify the `chapUserId` value obtained by getting information about the CHAP user. You can also specify the following attributes and connect them with commas:

```
portId,hostGroupNumber,wayOfChapUser,chapUserName
```

| Attribute | Type | Description |
|-----------------|--------|--|
| portId | string | (Required) Port number |
| hostGroupNumber | int | (Required) Target ID of the iSCSI target |
| wayOfChapUser | string | (Required) Type of the CHAP user name <ul style="list-style-type: none"> ▪ TAR: The CHAP user name of the iSCSI target side ▪ INI: The CHAP user name of the host bus adapter (iSCSI initiator) side |
| chapUserName | string | (Required) The CHAP user name |

Query parameters

None.

Body

When setting the secret password for the CHAP user:

```
{
  "chapPassword": "TopSecretForMyChap"
}
```

When resetting the secret password of the CHAP user:

```
{
  "chapPassword": ""
}
```

| Attribute | Type | Description |
|--------------|--------|--|
| chapPassword | string | Specify a secret consisting of 12 to 32 characters for the specified CHAP user. If you specify a null character, the password is reset. |

Response message**Body**

A job object is returned. For details on attributes other than `affectedResources`, see the section explaining job objects.

| Attribute | Description |
|-------------------|--|
| affectedResources | URL of the CHAP user name for which the secret was set |

Action template

None.

Status codes

For details on the status codes of the request for this operation, see the description on HTTP status codes.

Coding example

```
curl -v -H "Accept:application/json" -H "Content-Type:application/json" -H
"Authorization:Session d7b673af189048468c5af9bcf3b6bb6f" -X PATCH --data-
binary @./InputParameters.json https://192.0.2.100/ConfigurationManager/v1/
objects/chap-users/CL1-D,1,TAR,MyRESTChapUser
```

Deleting the CHAP user from the iSCSI target

The following request deletes the CHAP user name specified for the iSCSI target.

Execution permission

Storage Administrator (Provisioning)

Request line

```
DELETE base-URL/v1/objects/chap-users/object-ID
```

Request message**Object ID**

Specify the `chapUserId` value obtained by getting information about the CHAP user. You can also specify the following attributes and connect them with commas:

portId, hostGroupNumber, wayOfChapUser, chapUserName

| Attribute | Type | Description |
|-----------------|--------|--|
| portId | string | (Required) Port number |
| hostGroupNumber | int | (Required) Target ID of the iSCSI target |
| wayOfChapUser | string | (Required) Type of the CHAP user name <ul style="list-style-type: none"> ▪ TAR: The CHAP user name of the iSCSI target side ▪ INI: The CHAP user name of the host bus adapter (iSCSI initiator) side |
| chapUserName | string | (Required) The CHAP user name |

Query parameters

None.

Body

None.

Response message**Body**

A job object is returned. For details on attributes other than `affectedResources`, see the section explaining job objects.

| Attribute | Description |
|-------------------|-----------------------------------|
| affectedResources | URL of the deleted CHAP user name |

Status codes

For details on the status codes of the request for this operation, see the description on HTTP status codes.

Coding example

```
curl -v -H "Accept:application/json" -H "Content-Type:application/json" -H
"Authorization:Session d7b673af189048468c5af9bcf3b6bb6f" -X DELETE
https://192.0.2.100/ConfigurationManager/v1/objects/chap-users/CL1-D,1,TAR,
MyRESTChapUser
```

Getting information about LU paths

The following request gets information about LU paths defined for the iSCSI target or the host group for the port.

Execution permission

Storage Administrator (View Only)

Request line

```
GET base-URL/v1/objects/luns
```

Request message**Object ID**

None.

Query parameters

| Parameter | Type | Filter Condition |
|-----------------------|---------|---|
| portId | string | (Required) Port number |
| hostGroupNumber | int | (Required) Host group number (for an iSCSI target, this is the target ID) You must specify either this parameter or the <code>hostGroupNumberList</code> parameter. |
| isBasicLunInformation | boolean | (Optional) Specify whether to get only basic information. <ul style="list-style-type: none"> ▪ <code>true</code>: Gets only basic information. (Does not get the host reservation status.) ▪ <code>false</code>: Gets all the items. If this parameter is omitted, <code>false</code> is assumed. |

| Parameter | Type | Filter Condition |
|---------------------|--------|---|
| lunOption | string | <p>(Optional) Specify the type of information you want to get.</p> <ul style="list-style-type: none"> ALUA: Gets information about ALUA settings. <p>If you specify both this parameter and the <code>hostGroupNumberList</code> parameter, this parameter will be ignored.</p> |
| hostGroupNumberList | string | <p>(Optional) Host group number (for an iSCSI target, this is the target ID)</p> <p>You can obtain information quickly by specifying this parameter. If you specify this parameter, the value of the <code>hostModeOptions</code> attribute is not obtained.</p> <p>To specify multiple IDs, delimit each ID by using a comma.</p> <p>You must specify either this parameter or the <code>hostGroupNumber</code> parameter.</p> |

Body

None.

Response message**Body**

The following is an example of the output when only basic information is obtained:

```
{
  "data": [
    {
      "lunId": "CL1-A,1,1",
      "portId": "CL1-A",
      "hostGroupNumber": 1,
      "hostMode": "LINUX/IRIX",
      "lun": 1,
      "ldevId": 1,
      "isCommandDevice": false
    },
    {
      "lunId": "CL1-A,1,2",
      "portId": "CL1-A",
      "hostGroupNumber": 1,
      "hostMode": "LINUX/IRIX",
```

```

    "lun": 2,
    "ldevId": 2,
    "isCommandDevice": false
  }
]
}

```

The following is an example of the output generated when getting information about all items:

```

{
  "data": [
    {
      "lunId": "CL1-A,1,1",
      "portId": "CL1-A",
      "hostGroupNumber": 1,
      "hostMode": "LINUX/IRIX",
      "lun": 1,
      "ldevId": 1,
      "isCommandDevice": false,
      "luHostReserve": {
        "openSystem": false,
        "persistent": false,
        "pgrKey": false,
        "mainframe": false,
        "acaReserve": false
      }
    }
  ]
}

```

| Attribute | Type | Description |
|-----------------|--------|---|
| lunId | string | Object ID for the LUN |
| portId | string | Port number |
| hostGroupNumber | int | Host group number of the port (for an iSCSI target, this is the target ID) |
| hostMode | string | Host mode for setting the host adapter of the host group For details on the values to be obtained, see the description of the API function for changing the host group or iSCSI target settings. |
| lun | int | LUN between the host group and the mapped LDEV |
| ldevId | int | LDEV number |

| Attribute | Type | Description |
|-----------------------|---------|---|
| isCommandDevice | boolean | Gets information about whether the device is a command device. |
| luHostReserve | object | <p>Host reservation status of the LU</p> <p>When <i>false</i> is specified for <i>isBasicLunInformation</i> and the LU is in the reserved status, the following attributes are output:</p> <ul style="list-style-type: none"> ▪ <i>openSystem</i> (boolean) Indicates whether the LU is reserved for open systems. ▪ <i>persistent</i> (boolean) Indicates whether the LU is in the persistent reservation status. ▪ <i>pgrKey</i> (boolean) Indicates whether the LU is reserved by a PGR key. ▪ <i>mainframe</i> (boolean) Indicates whether the LU is reserved for mainframes. ▪ <i>acaReserve</i> (boolean) Indicates whether the LU is in the ACA reservation status. |
| hostModeOptions | int[] | <p>Number of options for setting the host mode option of the host group</p> <p>This attribute is not displayed if <i>hostGroupNumberList</i> is specified as a query parameter.</p> <p>For details on the number to be obtained, see the <i>Provisioning Guide for Open Systems</i> , or the <i>Provisioning Guide</i> .</p> |
| isAluaEnabled | boolean | <p>Whether the ALUA attribute is enabled:</p> <p>This attribute is displayed only if you specified <i>ALUA</i> for <i>lunOption</i> in the query parameters.</p> <ul style="list-style-type: none"> ▪ <i>true</i>: The ALUA attribute is enabled. ▪ <i>false</i>: The ALUA attribute is disabled. |
| asymmetricAccessState | string | Priority level of the ALUA path |

| Attribute | Type | Description |
|-----------|------|--|
| | | <p>This attribute is displayed only if you specified <code>ALUA</code> for <code>lunOption</code> in the query parameters.</p> <ul style="list-style-type: none"> ▪ Active/Optimized: Higher priority ▪ Active/Non-Optimized: Lower priority ▪ Not Supported: Not supported |

Status codes

For details on the status codes of the request for this operation, see the description on HTTP status codes.

Coding example

When getting only basic information:

```
curl -v -H "Accept:application/json" -H "Content-Type:application/json" -H
"Authorization:Session d7b673af189048468c5af9bcf3b6bb6f" -X GET "https://
192.0.2.100/ConfigurationManager/v1/objects/luns?portId=CL1-
A&hostGroupNumber=1&isBasicLunInformation=true"
```

When getting information about all items:

```
curl -v -H "Accept:application/json" -H "Content-Type:application/json" -H
"Authorization:Session d7b673af189048468c5af9bcf3b6bb6f" -X GET "https://
192.0.2.100/ConfigurationManager/v1/objects/luns?portId=CL1-
A&hostGroupNumber=1"
```

Getting information about a specific LU path

The following request gets information about the specified LU path.

Execution permission

Storage Administrator (View Only)

Request line

```
GET base-URL/v1/objects/luns/object-ID
```

Request message**Object ID**

Specify the `lunId` value obtained by getting information about the LU path. You can also specify the following attributes and connect them with commas:

portId, hostGroupNumber, lun

| Attribute | Type | Description |
|-----------------|--------|--|
| portId | string | (Required) Port number |
| hostGroupNumber | int | (Required) Host group number (target ID for an iSCSI port) |
| lun | int | (Required) LUN |

Query parameters

None.

Body

None.

Response message**Body**

```
{
  "lunId": "CL1-A,1,1",
  "portId": "CL1-A",
  "hostGroupNumber": 1,
  "hostMode": "LINUX/IRIX",
  "lun": 1,
  "ldevId": 1,
  "isCommandDevice": false,
  "luHostReserve": {
    "openSystem": false,
    "persistent": false,
    "pgrKey": false,
    "mainframe": false,
    "acaReserve": false
  },
  "hostModeOptions": [
    2,
    6
  ]
}
```

| Attribute | Type | Description |
|-----------------|---------|---|
| lunId | string | Object ID for the LUN |
| portId | string | Port number |
| hostGroupNumber | int | Host group number of the port (for an iSCSI target, this is the target ID) |
| hostMode | string | Host mode for setting the host adapter of the host group For details on the values to be obtained, see <i>Changing the host group or iSCSI target settings</i> . |
| lun | int | LUN between the host group and the mapped LDEV |
| ldevId | int | LDEV number |
| isCommandDevice | boolean | Information about whether the device is a command device is output. |
| luHostReserve | object | Host reservation status of the LU <ul style="list-style-type: none"> ▪ openSystem (boolean) Indicates whether the LU is reserved for open systems. ▪ persistent (boolean) Indicates whether the LU is in the persistent reservation status. ▪ pgrKey (boolean) Indicates whether the LU is reserved by a PGR key. ▪ mainframe (boolean) Indicates whether the LU is reserved for mainframes. ▪ acaReserve (boolean) Indicates whether the LU is in the ACA reservation status. |
| hostModeOptions | int[] | Number of options for setting the host mode option of the host group For details on the number to be obtained, see the <i>Provisioning Guide for Open Systems</i> , or the <i>Provisioning Guide</i> . |

Status codes

For details on the status codes of the request for this operation, see the description on HTTP status codes.

Coding example

```
curl -v -H "Accept:application/json" -H "Content-Type:application/json" -H
"Authorization:Session d7b673af189048468c5af9bcf3bbbb6f" -X GET https://
192.0.2.100/ConfigurationManager/v1/objects/luns/CL1-A,1,1
```

Sending the ping command to a specified host

The request below checks the connection status of a storage system and a host by sending the ping command from a specified iSCSI port on the storage system to the host.

Execution permission

Storage Administrator (View Only)

Request line

```
POST base-URL/v1/objects/ports/object-ID/actions/ping/invoke
```

Request message**Object ID**

Specify the `portId` value obtained by getting information about the port.

| Attribute | Type | Description |
|-----------|--------|------------------------|
| portId | string | (Required) Port number |

Query parameters

None.

Body

```
{
  "parameters" : {
    "ipAddress" : "192.168.0.100"
  }
}
```

| Attribute | Type | Description |
|-----------|--------|--|
| ipAddress | string | (Required) IP address of the target host You can specify an IPv4 address or IPv6 address. |

Response message

Body

```
{
  "transmittedPackets": 5,
  "receivedPackets": 5
}
```

| Attribute | Type | Description |
|--------------------|------|----------------------------|
| transmittedPackets | int | Number of sent packets |
| receivedPackets | int | Number of received packets |

Action template

None.

Status codes

The following table describes the meaning of the status code of the request for this operation. For details on other status codes, see the description on HTTP status codes.

| Status code | Message | Description |
|-------------|---------------------|---|
| 503 | Service unavailable | The port on the storage system is busy. |

Coding example

```
curl -v -H "Accept:application/json" -H "Content-Type:application/json" -H
"Authorization:Session d7b673af189048468c5af9bcf3bbbbb6f" -X POST --data-
binary @./InputParameters.json https://192.0.2.100/ConfigurationManager/v1/
objects/ports/CL1-A/actions/ping/invoke
```

Setting the LU path

The following request sets the LU path by mapping the LDEV with the LUN in the host group or in the iSCSI target of the specified port.

Execution permission

Storage Administrator (Provisioning)

Request line

```
POST base-URL/v1/objects/luns
```

Request message

Object ID

None.

Query parameters

None.

Body

The following coding example sets an LU path by specifying the LUN:

```
{
  "portIds": ["CL1-A","CL2-A"],
  "hostGroupNumber": 1,
  "ldevId": 64,
  "lun": 12
}
```

The following coding example sets an LU path without specifying the LUN:

```
{
  "portId": "CL1-A",
  "hostGroupNumber": 1,
  "ldevId": 64
}
```

| Attribute | Type | Description |
|-----------|--------|---|
| portId | string | (Optional) Port number Specify this attribute when setting the LU path for one port. |

| Attribute | Type | Description |
|------------------------------|--------|---|
| | | This attribute cannot be specified at the same time as the <code>portIds</code> attribute. You must specify either the <code>portId</code> attribute or the <code>portIds</code> attribute. |
| <code>portIds</code> | string | (Optional) Port number Specify this attribute when setting the LU paths for multiple ports at the same time. You can specify up to 6 port numbers. This attribute cannot be specified at the same time as the <code>portId</code> attribute. You must specify either the <code>portId</code> attribute or the <code>portIds</code> attribute. |
| <code>hostGroupNumber</code> | int | (Required) Host group number (target ID for an iSCSI port) |
| <code>lun</code> | int | (Optional) LUN If this attribute is omitted, a value is automatically set. You cannot specify the same LUN for multiple LDEVs. |
| <code>ldevId</code> | int | (Required) Specify the LDEV number with a decimal (base 10) number. An LDEV cannot be mapped to another LUN in the same host group. |

For host groups for which host mode option 60 is enabled, if you specify `portId` but omit `lun`, automatic configuration of LUNs might fail. If this happens, try the operation again, but specify `portIds` instead of `portId`.

Response message

Body

A job object is returned. For details on attributes other than `affectedResources`, see the section explaining job objects.

| Attribute | Description |
|--------------------------------|----------------------------|
| <code>affectedResources</code> | URL of the created LU path |

Status codes

For details on the status codes of the request for this operation, see the description on HTTP status codes.

Coding example

```
curl -v -H "Accept:application/json" -H "Content-Type:application/json" -H
"Authorization:Session d7b673af189048468c5af9bcf3b6bb6f" -X POST --data-
binary @./InputParameters.json https://192.0.2.100/ConfigurationManager/v1/
objects/luns
```

Setting the priority levels of ALUA paths

For a global-active device in a cross-path configuration (using a Fibre Channel connection), by enabling the ALUA attribute, you can set the priority levels of paths between a host and a storage system.

Execution permission

Storage Administrator (Provisioning)

Request line

```
POST base-URL/v1/services/lun-service/actions/change-asymmetric-access-
state/invoke
```

Request message**Object ID**

None.

Query parameters

None.

Body

```
{
  "parameters": {
    "portId" : "CL1-A",
    "hostGroupNumber" : 1,
    "asymmetricAccessState" : "Active/Optimized"
  }
}
```

| Attribute | Type | Description |
|-----------------|--------|------------------------------|
| portId | string | (Required) Port number |
| hostGroupNumber | int | (Required) Host group number |

| Attribute | Type | Description |
|-----------------------|--------|--|
| asymmetricAccessState | string | (Required) Priority level of the ALUA path <ul style="list-style-type: none"> ▪ Active/Optimized: Higher priority ▪ Active/Non-Optimized: Lower priority |

Response message

Body

A job object is returned. For details on attributes other than `affectedResources`, see the section explaining job objects.

| Attribute | Description |
|-------------------|--|
| affectedResources | URL for getting information about LU paths You can get information about the priority level of an ALUA path by specifying <code>lunOption=ALUA</code> in the query parameters of the API function for getting information about LU paths. |

Action template

None.

Status codes

For details on the status codes of the request for this operation, see the description of HTTP status codes.

Coding example

```
curl -v -H "Accept:application/json" -H "Content-Type:application/json" -H "Authorization:Session d7b673af189048468c5af9bcf3b6bb6f" -X POST --data-binary @./InputParameters.json https://192.0.2.100/ConfigurationManager/v1/services/lun-service/actions/change-asymmetric-access-state/invoke
```

Deleting a LU path

The following request deletes the LU path defined for the host group or iSCSI target of the specified port.

Execution permission

Storage Administrator (Provisioning)

Request lineDELETE *base-URL/v1/objects/luns/object-ID***Request message****Object ID**

Specify the `lunId` value obtained by getting information about the LU path. You can also specify the following attributes and connect them with commas:

portId,hostGroupNumber,lun

| Attribute | Type | Description |
|-----------------|--------|--|
| portId | string | (Required) Port number |
| hostGroupNumber | int | (Required) Host group number (target ID for an iSCSI port) |
| lun | int | (Required) LUN |

Query parameters

None.

Body

None.

Response message**Body**

A job object is returned. For details on attributes other than `affectedResources`, see the section explaining job objects.

| Attribute | Description |
|-------------------|----------------------------|
| affectedResources | URL of the deleted LU path |

Status codes

For details on the status codes of the request for this operation, see the description on HTTP status codes.

Coding example

```
curl -v -H "Accept:application/json" -H "Content-Type:application/json" -H
"Authorization:Session d7b673af189048468c5af9bcf3b666f" -X DELETE
https://192.0.2.100/ConfigurationManager/v1/objects/luns/CL1-A,1,64
```

Setting the command device

The following request sets and releases the command device specified for the LDEV. The request also changes the attributes of the command device.

**Note:**

If you do not specify the `isSecurityEnabled` attribute, the `isUserAuthenticationEnabled` attribute, or the `isDeviceGroupDefinitionEnabled` attribute, the settings will be disabled after execution, even if the settings were enabled before execution. If you change a command device attribute, specify this item to prevent the setting from being unexpectedly disabled.

Execution permission

Storage Administrator (Provisioning)

Request line

```
POST base-URL/v1/objects/ldevs/object-ID/actions/set-as-command-device/
invoke
```

Request message**Object ID**

Specify the `ldevId` value obtained by getting information about volumes.

| Attribute | Type | Description |
|---------------------|------|---|
| <code>ldevId</code> | int | (Required) Specify the LDEV number with a decimal (base 10) number. |

Query parameters

None.

Body

The following coding example sets the command device:

```
{
  "parameters": {
    "isCommandDevice": true
  }
}
```

The following coding example sets the command device, security, user authentication, and device group information authentication:

```
{
  "parameters": {
    "isCommandDevice": true,
    "isSecurityEnabled": true,
    "isUserAuthenticationEnabled": true,
    "isDeviceGroupDefinitionEnabled": true
  }
}
```

| Attribute | Type | Description |
|-----------------------------|---------|---|
| isCommandDevice | boolean | (Required) Specify whether to set the specified LDEV for the command device. <ul style="list-style-type: none"> ▪ <code>true</code>: Enables the settings for the command device. ▪ <code>false</code>: Disables the settings for the command device. |
| isSecurityEnabled | boolean | (Optional) Specify whether to enable the security settings for the command device. <ul style="list-style-type: none"> ▪ <code>true</code>: Enables the security settings. ▪ <code>false</code>: Disables the security settings. If this value is omitted, <code>false</code> is assumed. Specify this item to prevent the setting from being unexpectedly disabled. |
| isUserAuthenticationEnabled | boolean | (Optional) Specify whether to enable the user authentication setting for the command device. <ul style="list-style-type: none"> ▪ <code>true</code>: Enables the user authentication setting. ▪ <code>false</code>: Disables the user authentication setting. |

| Attribute | Type | Description |
|---|---------|--|
| | | If this value is omitted, <code>false</code> is assumed. Specify this item to prevent the setting from being unexpectedly disabled. |
| <code>isDeviceGroupDefinitionEnabled</code> | boolean | <p>(Optional) Specify whether to enable the settings for device group information authentication for the command device.</p> <ul style="list-style-type: none"> ▪ <code>true</code>: Enables the settings for device group information authentication. ▪ <code>false</code>: Disables the settings for device group information authentication. <p>If this value is omitted, <code>false</code> is assumed. Specify this item to prevent the setting from being unexpectedly disabled.</p> |

Response message

Body

A job object is returned. For details on attributes other than `affectedResources`, see the section explaining job objects.

| Attribute | Description |
|--------------------------------|---|
| <code>affectedResources</code> | URL of the volume for which the command device attribute has been changed |

Action template

```
GET base-URL/v1/objects/ldevs/object-ID/actions/set-as-command-device
```

Status codes

The following table describes the meanings of the status codes of the request for this operation. For details on other status codes, see the description on HTTP status codes.

| Status code | Message | Description |
|-------------|---------------------|---|
| 412 | Precondition Failed | <p>The LDEV status is inappropriate. The LDEV might be in one of the following statuses:</p> <ul style="list-style-type: none"> ▪ The LDEV is used as a virtual volume of Thin Image. ▪ The LDEV is used as a Quorum disk. ▪ The LDEV is used as a system disk. ▪ The LDEV is used as a deduplication system data volume (fingerprint). ▪ The LDEV is used as a pool volume. ▪ The LDEV is used as a Volume Migration volume. |

Coding example

To get an action template:

```
curl -v -H "Accept:application/json" -H "Content-Type:application/json" -H
"Authorization:Session d7b673af189048468c5af9bcf3b6bb6f" -X GET https://
192.0.2.100/ConfigurationManager/v1/objects/ldevs/1/actions/set-as-command-
device
```

To run the request after getting an action template:

```
curl -v -H "Accept:application/json" -H "Content-Type:application/json" -H
"Authorization:Session d7b673af189048468c5af9bcf3b6bb6f" -X POST --data-
binary @./InputParameters.json https://192.0.2.100/ConfigurationManager/v1/
objects/ldevs/1/actions/set-as-command-device/invoke
```

Getting a list of MP information

The request below obtains a list of MP location information.

Execution permission

Storage Administrator (View Only)

Request line

```
GET base-URL/v1/objects/mps
```

Request message**Object ID**

None.

Query parameters

None.

Body

None.

Response message**Body**

```

{
  "data": [
    {
      "mpId": 0,
      "mpLocationId": "MP10-00",
      "mpUnitId": "MPU-10",
      "ctl": "ctl1"
    },
    {
      "mpId": 1,
      "mpLocationId": "MP10-01",
      "mpUnitId": "MPU-10",
      "ctl": "ctl1"
    },
    {
      "mpId": 4,
      "mpLocationId": "MP20-00",
      "mpUnitId": "MPU-20",
      "ctl": "ctl2"
    },
    {
      "mpId": 5,
      "mpLocationId": "MP20-01",
      "mpUnitId": "MPU-20",
      "ctl": "ctl2"
    }
  ]
}

```

| Attribute | Type | Description |
|-----------|------|-------------|
| mpId | int | MP ID |

| Attribute | Type | Description |
|--------------|--------|--|
| mpLocationId | string | MP location number |
| mpUnitId | string | MP unit ID |
| ctl | string | Controller location information |
| cbx | int | CBX number For the following storage system models, -1 is output to indicate an invalid value: VSP E series, VSP G350, G370, G700, G900 and VSP F350, F370, F700, F900. |

Status codes

For details on the status codes of the request for this operation, see the description of HTTP status codes.

Coding example

```
curl -v -H "Accept:application/json" -H "Content-Type:application/json" -H
"Authorization:Session d7b673af189048468c5af9bcf3b6bb6f" -X GET https://
192.0.2.100/ConfigurationManager/v1/objects/mps
```

Releasing the host reservation status by specifying the LU path

The following request releases the host reservation status of the LU mapped to a specified LU path. Use this API in situations when the host reservation status on the LU could not be released when there is a failure due to a problem on the host side.

Execution permission

Storage Administrator (System Resource Management)

Request line

```
POST base-URL/v1/objects/luns/object-ID/actions/release-lu-host-reserve/
invoke
```

Request message**Object ID**

Specify the `lunId` value from the LU path information. You can also specify a combination of attribute values in the following format:

```
portId, hostGroupNumber, lun
```

| Attribute | Type | Description |
|-----------------|--------|--|
| portId | string | (Required) Port number |
| hostGroupNumber | int | (Required) Host group number (target ID for an iSCSI port) |
| lun | int | (Required) LUN |

Query parameters

None.

Body

None.

Response message**Body**

A job object is returned. For details on attributes other than `affectedResources`, see the section explaining job objects.

| Attribute | Description |
|-------------------|---|
| affectedResources | URL of the path of the LU whose host reservation status is to be released |

Action template

None.

Status codes

For details on the status codes of the request for this operation, see the section explaining HTTP status codes.

Coding example

```
curl -v -H "Content-type:application/json" -H "Accept:application/json" -H
"Authorization:Session d7b673af189048468c5af9bcf3b6bb6f" -X POST https://
192.0.2.100/ConfigurationManager/v1/objects/luns/CL1-A,1,0/actions/release-
lu-host-reserve/invoke -d ""
```

Releasing the host reservation status by specifying a host group

The following request releases the host reservation status for all LUs mapped to the specified host group or iSCSI target. Use this API in situations such as when the host reservation status on LUs could not be released because of some reason, such as a failure.

Execution permission

Storage Administrator (System Resource Management)

Request line

```
POST base-URL/v1/objects/host-groups/object-ID/actions/release-lu-host-
reserves/invoke
```

Request message**Object ID**

Specify the `hostGroupId` value obtained by the processing to obtain information about host groups or about iSCSI targets. You can also specify a combination of attribute values in the following format:

```
portId,hostGroupNumber
```

| Attribute | Type | Description |
|-----------------|--------|---|
| portId | string | (Required) Port number |
| hostGroupNumber | int | (Required) Host group number for the port (For an iSCSI target, this is the target ID.) |

Query parameters

None.

Body

None.

Response message

Body

A job object is returned. See the description for the job object. `affectedResources` is not displayed for this API. To check whether the host reservation status has been released, use the following URL. For *port-number* and *host-group-number*, specify the port number and the host group number (or the target ID) specified for the object ID.

```
GET base-URL/v1/objects/luns?portId=port-number&hostGroupNumber=host-group-number
```

Action template

None.

Status codes

For details on the status codes of the request for this operation, see the section explaining HTTP status codes.

Coding example

```
curl -v -H "Content-type:application/json" -H "Accept:application/json" -H "Authorization:Session d7b673af189048468c5af9bcf3b66b6f" -X POST https://192.0.2.100/ConfigurationManager/v1/objects/host-groups/CL1-A,1/actions/release-lu-host-reserves/invoke -d ""
```

Chapter 6: Pool management

This chapter describes how to manage pools by using the REST API.

Overview of a pool

A pool is a virtual area created by integrating multiple LDEVs. You can create virtual volumes from a pool, and then allocate or pair the volumes.

You can create a virtual volume that has a capacity larger than that of the physical drive, and expand or reduce the size of a virtual volume as necessary. By doing so, you can effectively use the resources of a storage system and reduce the workload of adding and configuring drives. In addition, data is decentralized and stored on multiple drives by integrating multiple physical volumes, thereby improving drive operation efficiency.

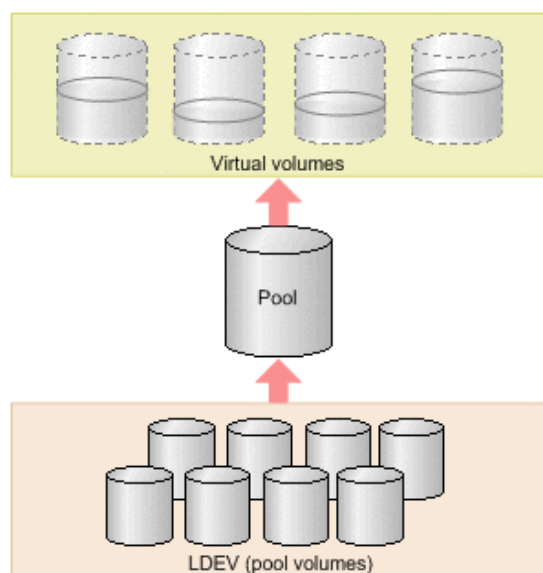

HDP pools, HDT pools, and Thin Image pools are created in the REST API. In this manual, HDP pools and HDT pools are referred to as DP pools when differentiation is unnecessary.

The following is a list of operations that can be performed for pools by using the REST API.

- Create pools

Create DP pools or Thin Image pools by specifying LDEVs. You can also set a threshold value for the pool usage rate to be used for issuing a warning when that value is exceeded. Use DP pools to create virtual volumes, and use Thin Image pools to store snapshot data. You can also store snapshot data in HDP pools.

- Change pool settings

Change the pool type from the HDP pool to the HDT pool, change the threshold usage rate of the DP pool or the Thin Image pool, or change the subscription of a virtual volume to DP pool capacity.

- Expand pools

Expand capacity by adding LDEVs to DP pools or Thin Image pools.

- Shrink pools

Reduce capacity by deleting the LDEVs that compose the DP pools or Thin Image pools.

- Perform performance monitoring of HDT pools

Start or stop monitoring of HDT pools at a specific timing so that HDT pool data is appropriately located.

- Perform tier relocation for HDT pools

Based on the performance monitoring information, relocate HDT pool data to an appropriate tier.

- Restore pools

Unblock DP pools or Thin Image pools that have recovered from a failure or other problem.

- Delete pools

Delete DP pools or Thin Image pools that are no longer necessary.

- Get information about pools

Get information about DP pools or Thin Image pools.

You create pools during the procedure to allocate volumes or create Thin Image pairs. Perform other operations on pools according to the status of the pools.

For details on HDP (Dynamic Provisioning) and HDT (Dynamic Tiering), see the *Provisioning Guide for Open Systems*, or the *Provisioning Guide*.

Getting pool information

The following request gets information items such as the pool status, the pool usage rate, and the pool threshold.

Execution permission

Storage Administrator (View Only)

Request lineGET *base-URL*/v1/objects/pools**Request message****Object ID**

None.

Query parameters

Query parameters can be specified to filter the execution results by the specified condition and also collect additional detailed information about pools.

- When filtering execution results

| Parameter | Type | Filter Condition |
|-----------|--------|---|
| poolType | string | <p>(Optional) The type of pools about which information will be obtained.</p> <p>The specifiable types are as follows:</p> <ul style="list-style-type: none"> ▪ DP: Information about DP pools is obtained. ▪ HTI: Information about Thin Image pools is obtained. <p>If this parameter is omitted, information about all pools will be obtained.</p> |

- When collecting additional detailed information

| Parameter | Type | Description |
|----------------|--------|---|
| detailInfoType | string | <p>(Optional) Type of detailed information to be obtained</p> <p>To specify multiple types, delimit the values by using commas.</p> |

| Parameter | Type | Description |
|-----------|------|--|
| | | <p>This parameter can be used in combination with the parameter to filter execution results.</p> <ul style="list-style-type: none"> ▪ <code>FMC</code> Detailed accelerated compression information of pools that consist of pool volumes belonging to the parity group of SSD (FMC) type drives is added. ▪ <code>tierPhysicalCapacity</code> Additional detailed information about the physical capacity of the HDT pools in each tier is obtained. The obtained information is added to the <code>tiers</code> attribute in the response body that is displayed. ▪ <code>efficiency</code> Additional detailed information is obtained about the saving efficiency for consumption of capacity (total efficiency) achieved by using the functions for increasing the usage efficiency of a pool (namely, the capacity saving function (dedupe and compression), the accelerated compression function, the creation of backup data by using snapshots, and the virtualization of capacity by using Dynamic Provisioning). ▪ <code>formattedCapacity</code> Additional detailed information is obtained about the size of the formatted capacity of the pool. ▪ <code>class</code> Adds additional information from the storage system's cache. You can specify this item for VSP 5000 series. To get up-to-date information, you must run the API request that refreshes the storage system's cache before running this request. For details, see "Updating the cache of storage system configuration information". |

| Parameter | Type | Description |
|-----------|------|---|
| | | <ul style="list-style-type: none"> ▪ autoAddPoolVol Information is added on whether a pool volume is added automatically, depending on the compression rate of the parity group for which accelerated compression is enabled. ▪ tierDiskType The disk type is obtained for each tier. The obtained information is added to the <code>tiers</code> attribute in the response body that is displayed. |

Body

None.

Response message**Body**

The following is an example of the output generated when getting HDP pool information:

```
{
  "data" : [ {
    "poolId" : 5,
    "poolStatus" : "POLN",
    "usedCapacityRate" : 1,
    "usedPhysicalCapacityRate" : 1,
    "snapshotCount" : 0,
    "poolName" : "pool_5",
    "availableVolumeCapacity" : 32042850,
    "availablePhysicalVolumeCapacity" : 20006364,
    "totalPoolCapacity" : 32066496,
    "totalPhysicalCapacity" : 20009724,
    "numOfLdevs" : 11,
    "firstLdevId" : 2304,
    "warningThreshold" : 70,
    "depletionThreshold" : 80,
    "virtualVolumeCapacityRate" : -1,
    "isMainframe" : false,
    "isShrinking" : false,
    "locatedVolumeCount" : 13,
    "totalLocatedCapacity" : 79951368,
    "blockingMode" : "NB",
    "totalReservedCapacity" : 0,
  } ]
}
```

```

"reservedVolumeCount" : 0,
"poolType" : "HDP",
"duplicationLdevIds" : [ 65269, 65268, 65267, 65266, 65265,
65264, 65263, 65262 ],
"duplicationNumber" : 8,
"dataReductionAccelerateCompCapacity" : 206783585,
"dataReductionCapacity" : 205901472,
"dataReductionBeforeCapacity" : 210117216,
"dataReductionAccelerateCompRate" : 87,
"duplicationRate" : 42,
"compressionRate" : 44,
"dataReductionRate" : 97,
"dataReductionAccelerateCompIncludingSystemData" : {
  "isReductionCapacityAvailable" : true,
  "reductionCapacity" : 228372480,
  "isReductionRateAvailable" : true,
  "reductionRate" : 97
},
"dataReductionIncludingSystemData" : {
  "isReductionCapacityAvailable" : true,
  "reductionCapacity" : 186826752,
  "isReductionRateAvailable" : true,
  "reductionRate" : 79
},
"snapshotUsedCapacity" : 0,
"suspendSnapshot" : true,
"capacitiesExcludingSystemData" : {
  "usedVirtualVolumeCapacity" : 235253760,
  "compressedCapacity" : 0,
  "dedupedCapacity" : 101035296,
  "reclaimedCapacity" : 129142560,
  "systemDataCapacity" : 43351104,
  "preUsedCapacity" : 234393600,
  "preCompressedCapacity" : 0,
  "preDedupredCapacity" : 105247408
}
} ]
}

```

For a DP pool:

| Attribute | Type | Description |
|-----------|--------|------------------------|
| poolId | int | Object ID for the pool |
| poolName | string | Pool name |

| Attribute | Type | Description |
|---------------------------------|--------|--|
| poolType | string | Pool type <ul style="list-style-type: none"> HDP: HDP pool HDT: HDT pool RT: active flash pool DM: Data Direct Mapping HDP pool |
| poolStatus | string | One of the following is output as the pool status: <ul style="list-style-type: none"> POLN: Normal (Pool Normal) POLE: The pool is in the overflow status exceeding the threshold. (Pool Full) POLS: The pool is in the overflow status exceeding the threshold and is suspended. (Pool Suspend) POLE: The pool is suspended in the failure status. (Pool failure) <p>If the pool status is POLE, pool information cannot be obtained.</p> |
| usedCapacityRate | int | Usage rate of logical capacity (%) |
| usedPhysicalCapacityRate | int | Usage rate of physical capacity (%) |
| availableVolumeCapacity | long | Free logical capacity (MB) |
| availablePhysicalVolumeCapacity | long | Free physical capacity (MB) For this attribute, 1 MB is equal to 1,024 ² bytes. |
| totalPoolCapacity | long | Total logical capacity (MB) |
| totalPhysicalCapacity | long | Total physical capacity (MB) For this attribute, 1 MB is equal to 1,024 ² bytes. |
| numOfLdevs | int | Number of LDEVs in the pool |
| firstLdevId | int | The first LDEV number of the LDEVs in the pool |

| Attribute | Type | Description |
|---------------------------|---------|--|
| warningThreshold | int | The warning threshold set for the pool |
| depletionThreshold | int | The depletion threshold set for the pool |
| suspendSnapshot | boolean | Whether to suspend Thin Image pairs when the depletion threshold is exceeded <ul style="list-style-type: none"> ▪ <code>true</code>: Thin Image pairs are suspended when the depletion threshold is exceeded. ▪ <code>false</code>: Thin Image pairs are not suspended when the depletion threshold is exceeded. |
| virtualVolumeCapacityRate | int | The maximum subscription limit of a virtual volume relative to pool capacity If unlimited is set, -1 is output. For the following storage system models, -1 is output to indicate an invalid value: VSP G350, G370, G700, G900, VSP F350, F370, F700, F900. |
| isShrinking | boolean | Whether the pool is shrinking is output. <ul style="list-style-type: none"> ▪ <code>true</code>: The pool is shrinking. ▪ <code>false</code>: The pool is not shrinking. |
| locatedVolumeCount | int | Total number of DP volumes mapped to the pool |
| totalLocatedCapacity | long | Total capacity of the DP volumes mapped to the pool (MB) The value of this attribute does not include the control area. |
| snapshotCount | int | Total number of snapshot data items mapped to the pool |
| snapshotUsedCapacity | long | Total size of snapshot data mapped to the pool (MB) |

| Attribute | Type | Description |
|-----------------------|--------|---|
| blockingMode | string | <p>Setting the protection function for a virtual volume</p> <p>When the DP pool is full or when the DP pool volume is blocked, whether the read and write operations can be performed for the DP volume that uses the target DP pool is output.</p> <ul style="list-style-type: none"> ▪ PF: Pool Full <p>If the DP pool is full, read and write operations are not possible.</p> <p>If the DP pool volume is blocked, read and write operations are possible.</p> ▪ PB: Pool vol Blockade <p>If the DP pool volume is blocked, read and write operations are not possible.</p> <p>If the DP pool is full, read and write operations are possible.</p> ▪ FB: Full or Blockade <p>If the DP pool is full or the DP pool volume is blocked, read and write operations are not possible.</p> ▪ NB: No Blocking <p>Even if the DP pool is full or the DP pool volume is blocked, read and write operations are possible for the target DP volume.</p> |
| totalReservedCapacity | long | <p>Total capacity of the reserved page (MB) of the DP volume that is related to the DP pool</p> <p>If the Full Allocation functionality is not supported by the configuration, this attribute is not output.</p> |
| reservedVolumeCount | int | <p>Number of volumes associated with the DP pool for which the page reservation setting is enabled</p> |

| Attribute | Type | Description |
|---------------------|--------|--|
| | | If the Full Allocation functionality is not supported by the configuration, this attribute is not output. |
| poolActionMode | string | Execution mode for the pool <ul style="list-style-type: none"> ▪ DEF: The mode in which the monitor is started or stopped by instructions from the REST API server, and the Tier range is specified by automatic calculation of the DKC. ▪ AUT: The mode in which the monitor is started or stopped at the specified time, and the Tier range is specified by automatic calculation of the DKC (specified by using Storage Navigator). |
| monitoringMode | string | Performance monitoring execution mode (monitor mode) <ul style="list-style-type: none"> ▪ PM: Period mode ▪ CM: Continuous mode |
| tierOperationStatus | string | Operation status of performance monitoring and tier relocation is output. <ul style="list-style-type: none"> ▪ STP: Performance monitoring and tier relocation are both stopped. ▪ RLC: Performance monitoring is stopped and tier relocation is operating. ▪ MON: Performance monitoring is operating and tier relocation is stopped. ▪ RLM: Performance monitoring and tier relocation are both operating. |

| Attribute | Type | Description |
|-----------|----------|---|
| dat | string | Status of monitor information <ul style="list-style-type: none"> ▪ VAL: Valid ▪ INV: Invalid ▪ PND: Pending calculation |
| tiers | object[] | The following attributes about HDT pool tiers are output for each tier. <ul style="list-style-type: none"> ▪ tierNumber (int) Tier number ▪ tierLevelRange (string) Lower limit of the tier The value is output as the number of I/O operations per hour (IOPH). ▪ tierDeltaRange (string) Delta value for the tier The value is output as the number of I/O operations per hour (IOPH). |

| Attribute | Type | Description |
|-----------|------|---|
| | | <ul style="list-style-type: none"> <li data-bbox="982 254 1417 840"> <p>▪ diskType (string)</p> <p>The disk type for each tier</p> <ul style="list-style-type: none"> • SCM • SSD • SAS_7200 • SAS_10000 • SAS_15000 • SATA_7200 • EXTERNAL_LOW • EXTERNAL_MIDDLE • EXTERNAL_HIGH • MIXED <p>This information is displayed if <code>tierDiskType</code> is specified for the <code>detailInfoType</code> query parameter when the request is executed.</p> <li data-bbox="982 1052 1417 1386"> <p>▪ tierUsedPhysicalCapacity (long)</p> <p>Physical capacity used by the tier (MB)</p> <p>This information is displayed if <code>tierPhysicalCapacity</code> is specified for the <code>detailInfoType</code> query parameter when the request is executed.</p> <li data-bbox="982 1409 1417 1743"> <p>▪ tierTotalPhysicalCapacity (long)</p> <p>Total physical capacity of the tier (MB)</p> <p>This information is displayed if <code>tierPhysicalCapacity</code> is specified for the <code>detailInfoType</code> query parameter when the request is executed.</p> |

| Attribute | Type | Description |
|--------------------|-------|--|
| | | <ul style="list-style-type: none"> ▪ tierUsedCapacity (long) Logical capacity used by the tier (MB) ▪ tierTotalCapacity (long) Total logical capacity of the tier (MB) ▪ tablespaceRate (int) Rate of free space to be used for new allocation ▪ performanceRate (int) Performance utilization ▪ progressOfReplacing (int) Relocation progress rate The progress rate of the following tier relocation operation is output as a value from 0 to 99. <ul style="list-style-type: none"> • When the value of the tierOperationStatus attribute is RLC or RLM: Progress rate of relocation (being run). • When the value of the tierOperationStatus attribute is STP or MON: Progress rate of relocation (being suspended). When tier relocation is not run or tier relocation is complete, 100 is output. ▪ bufferRate (int) Buffer area rate for relocation |
| duplicationLdevIds | int[] | LDEV numbers of the deduplication system data volumes |
| duplicationNumber | int | Number of deduplication system data volumes |

| Attribute | Type | Description |
|-------------------------------------|------|--|
| dataReductionAccelerateCompCapacity | long | <p>Size (in blocks) of data reduction through the capacity saving function (dedupe and compression) or the accelerated compression function</p> <p>The size of data after reduction does not include the size of metadata and garbage data generated by the storage system.</p> |
| dataReductionCapacity | long | <p>Size (in blocks) of data reduction through the capacity saving function (compression and deduplication)</p> <p>The size of data after reduction does not include the size of metadata and garbage data generated by the storage system.</p> |
| dataReductionBeforeCapacity | long | <p>Size (in blocks) of data before data reduction was performed by using the capacity saving function (compression and deduplication)</p> |
| dataReductionAccelerateCompRate | int | <p>Percentage (%) of data on which data reduction has been performed by using the capacity saving function (compression and deduplication) or the accelerated compression function</p> <p>The size of data after reduction does not include the size of metadata and garbage data generated by the storage system.</p> |
| dataReductionRate | int | <p>Percentage (%) of data on which data reduction has been performed by using the capacity saving function (compression and deduplication)</p> <p>The size of data after reduction does not include the size of metadata and garbage data generated by the storage system.</p> |

| Attribute | Type | Description |
|---|--------|---|
| dataReductionAccelerateCompIncludSystemData | object | <p>The attributes related to the size of data reduced by using the capacity saving function (compression and deduplication) or the accelerated compression function are displayed.</p> <p>These attributes are calculated based on the size of the data (which includes, in addition to user data, metadata and garbage data generated by the storage system) after data reduction is performed.</p> <ul style="list-style-type: none"> ▪ isReductionCapacityAvailable (boolean) <p>Whether the size of the data can be reduced</p> <ul style="list-style-type: none"> • true: The size of the data can be reduced. <p>If the value of this attribute is true, the size of the data that has been reduced is displayed for the <code>reductionCapacity</code> attribute.</p> • false: The size of the data cannot be reduced (for example, if the size of the data after data reduction is greater than the size of the data before data reduction). ▪ reductionCapacity (long) <p>Size (in blocks) of the data that was reduced</p> <p>This attribute is displayed when the value of the <code>isReductionCapacityAvailable</code> attribute is true.</p> |

| Attribute | Type | Description |
|---|--------|--|
| | | <ul style="list-style-type: none"> <li data-bbox="982 254 1417 955"> <p>▪ <code>isReductionRateAvailable</code> (boolean)</p> <p>Whether the size of the data can be reduced</p> <ul style="list-style-type: none"> <li data-bbox="1023 422 1377 485">• <code>true</code>: The size of the data can be reduced. <p>If the value of this attribute is <code>true</code>, the percentage by which the size of the data has been reduced is displayed for the <code>reductionRate</code> attribute.</p> <ul style="list-style-type: none"> <li data-bbox="1023 751 1390 955">• <code>false</code>: The size of the data cannot be reduced (for example, if the size of the data after data reduction is greater than the size of the data before data reduction). <li data-bbox="982 1010 1417 1291"> <p>▪ <code>reductionRate</code> (int)</p> <p>Percentage (%) by which the size of the data has been reduced</p> <p>This attribute is displayed when the value of the <code>isReductionRateAvailable</code> attribute is <code>true</code>.</p> |
| <code>dataReductionIncludingSystemData</code> | object | The attributes related to the size of data reduced by using the capacity saving function (compression and deduplication) are displayed. |

| Attribute | Type | Description |
|-----------|------|--|
| | | <p>These attributes are calculated based on the size of the data (which includes, in addition to user data, metadata and garbage data generated by the storage system) after data reduction is performed.</p> <ul style="list-style-type: none"> ▪ <code>isReductionCapacityAvailable</code> (boolean) <p>Whether the size of the data can be reduced</p> <ul style="list-style-type: none"> • <code>true</code>: The size of the data can be reduced. <p>If the value of this attribute is <code>true</code>, the size of the data that has been reduced is displayed for the <code>reductionCapacity</code> attribute.</p> <ul style="list-style-type: none"> • <code>false</code>: The size of the data cannot be reduced (for example, if the size of the data after data reduction is greater than the size of the data before data reduction). ▪ <code>reductionCapacity</code> (long) <p>Size (in blocks) of the data that was reduced</p> <p>This attribute is displayed when the value of the <code>isReductionCapacityAvailable</code> attribute is <code>true</code>.</p> |

| Attribute | Type | Description |
|-----------|------|--|
| | | <ul style="list-style-type: none"> <li data-bbox="982 254 1417 955"> <p>▪ <code>isReductionRateAvailable</code> (boolean)</p> <p>Whether the size of the data can be reduced</p> <ul style="list-style-type: none"> <li data-bbox="1023 422 1377 485">• <code>true</code>: The size of the data can be reduced. <p>If the value of this attribute is <code>true</code>, the percentage by which the size of the data has been reduced is displayed for the <code>reductionRate</code> attribute.</p> <ul style="list-style-type: none"> <li data-bbox="1023 751 1390 955">• <code>false</code>: The size of the data cannot be reduced (for example, if the size of the data after data reduction is greater than the size of the data before data reduction). <li data-bbox="982 1010 1417 1283"> <p>▪ <code>reductionRate</code> (int)</p> <p>Percentage (%) by which the size of the data has been reduced</p> <p>This attribute is displayed when the value of the <code>isReductionRateAvailable</code> attribute is <code>true</code>.</p> |

| Attribute | Type | Description |
|-------------------------------|--------|---|
| capacitiesExcludingSystemData | object | <p>Attributes related to the capacity saving achieved by using the capacity saving function (dedupe and compression) are displayed.</p> <ul style="list-style-type: none"> <li data-bbox="982 415 1424 682"> <p>▪ usedVirtualVolumeCapacity (long)</p> <p>The capacity (in blocks) used by virtual volumes</p> <p>This does not include the capacity used by the system data volume for the dedupe function.</p> <li data-bbox="982 720 1424 955"> <p>▪ compressedCapacity (long)</p> <p>The size (in blocks) of data reduced by using compression</p> <p>This does not include the size of metadata and garbage data generated by the storage system.</p> <li data-bbox="982 993 1424 1255"> <p>▪ dedupedCapacity (long)</p> <p>The size (in blocks) of data reduced by using deduplication (dedupe)</p> <p>This does not include the size of metadata and garbage data generated by the storage system.</p> <li data-bbox="982 1293 1424 1556"> <p>▪ reclaimedCapacity (long)</p> <p>The size (in blocks) of data reduced by reclaiming the specified data pattern</p> <p>This does not include the size of metadata and garbage data generated by the storage system.</p> <li data-bbox="982 1593 1424 1829"> <p>▪ systemDataCapacity (long)</p> <p>The size (in blocks) of system data reduced</p> <p>This includes the size of metadata and garbage data generated by the storage system.</p> |

| Attribute | Type | Description |
|-----------------|---------|--|
| | | <ul style="list-style-type: none"> ▪ preUsedCapacity (long) The size (in blocks) of the data before data reduction was performed ▪ preCompressedCapacity (long) The size (in blocks) of the data before compression was performed ▪ preDedupredCapacity (long) The size (in blocks) of the data before dedupe was performed |
| compressionRate | int | Percentage (%) of data on which data reduction has been performed by using the compression function or the accelerated compression function |
| duplicationRate | int | Percentage (%) of data on which data reduction has been performed by using the deduplication function |
| isMainframe | boolean | Displays a pool for the mainframe or the open system <ul style="list-style-type: none"> ▪ true: Pool for the mainframe volume ▪ false: Pool for the open volume |

The following is an example of the output generated when getting Thin Image pool information:

```
{
  "data": [ {
    "poolId" : 35,
    "poolStatus" : "POLN",
    "usedCapacityRate" : 1,
    "usedPhysicalCapacityRate" : 1,
    "snapshotCount" : 2,
    "poolName" : "pool_35",
    "availableVolumeCapacity" : 46704,
    "availablePhysicalVolumeCapacity" : 46704,
    "totalPoolCapacity" : 46998,
  } ]
}
```



```

"totalPhysicalCapacity" : 46998,
"numOfLdevs" : 1,
"firstLdevId" : 18952,
"warningThreshold" : 80,
"virtualVolumeCapacityRate" : -1,
"isMainframe" : false,
"isShrinking" : false,
"poolType" : "HTI",
"capacitiesExcludingSystemData" : {
  "usedVirtualVolumeCapacity" : 602112
}
} ]
}

```

For a Thin Image pool:

| Attribute | Type | Description |
|--------------------------|--------|--|
| poolId | int | Object ID for the pool |
| poolName | string | Pool name |
| poolType | string | Pool type is output. HTI: Thin Image pool |
| poolStatus | string | One of the following is output as the pool status: <ul style="list-style-type: none"> POLN: Normal (Pool Normal) POLF: The pool is in the overflow status exceeding the threshold. (Pool Full) POLS: The pool is in the overflow status exceeding the threshold and is suspended. (Pool Suspend) POLE: The pool is suspended in the failure status. (Pool failure) <p>If the pool status is POLE, pool information cannot be obtained.</p> |
| usedCapacityRate | int | Usage rate of logical capacity (%) |
| usedPhysicalCapacityRate | int | Usage rate of physical capacity (%) |
| snapshotCount | int | Number of volumes in the pool |
| availableVolumeCapacity | long | Free logical capacity (MB) |

| Attribute | Type | Description |
|---------------------------------|---------|---|
| availablePhysicalVolumeCapacity | long | Free physical capacity (MB) For this attribute, 1 MB is equal to 1,024 ² bytes. |
| totalPoolCapacity | long | Total logical capacity (MB) |
| totalPhysicalCapacity | long | Total physical capacity (MB) For this attribute, 1 MB is equal to 1,024 ² bytes. |
| numOfLdevs | int | Number of LDEVs in the pool |
| firstLdevId | int | The first LDEV number of the LDEVs in the pool (Not the first number in ascending order) |
| warningThreshold | int | The warning threshold set for the pool |
| virtualVolumeCapacityRate | int | -1 indicating the invalid value is output. |
| isShrinking | boolean | Whether the pool is shrinking is output. <ul style="list-style-type: none"> ▪ <code>true</code>: The pool is shrinking. ▪ <code>false</code>: The pool is not shrinking. |
| isMainframe | boolean | Displays a pool for the mainframe or the open system <ul style="list-style-type: none"> ▪ <code>true</code>: Pool for the mainframe volume ▪ <code>false</code>: Pool for the open volume |
| capacitiesExcludingSystemData | object | Attributes related to the saving efficiency for consumption of capacity are displayed. <ul style="list-style-type: none"> ▪ <code>usedVirtualVolumeCapacity</code> (long) The capacity (in blocks) used by virtual volumes This does not include the capacity used by the system data volume used for the dedupe function. |

The following example shows the output when the detailed information for accelerated compression is obtained:

```
{
  "data" : [ {
```

```

"poolId" : 40,
"poolStatus" : "POLN",
"usedCapacityRate" : 0,
"usedPhysicalCapacityRate" : 0,
"snapshotCount" : 0,
"poolName" : "pool_40",
"availableVolumeCapacity" : 46998,
"availablePhysicalVolumeCapacity" : 46998,
"usedPhysicalCapacity" : 0,
"totalPoolCapacity" : 46998,
"totalPhysicalCapacity" : 46998,
"numOfLdevs" : 1,
"firstLdevId" : 4095,
"warningThreshold" : 70,
"depletionThreshold" : 80,
"virtualVolumeCapacityRate" : -1,
"isMainframe" : false,
"isShrinking" : false,
"locatedVolumeCount" : 6,
"totalLocatedCapacity" : 21672,
"blockingMode" : "NB",
"totalReservedCapacity" : 0,
"reservedVolumeCount" : 0,
"poolType" : "HDP",
"duplicationNumber" : 0,
"dataReductionAccelerateCompCapacity" : 0,
"dataReductionCapacity" : 0,
"dataReductionBeforeCapacity" : 0,
"dataReductionAccelerateCompRate" : 0,
"duplicationRate" : 0,
"compressionRate" : 0,
"dataReductionRate" : 0,
"dataReductionAccelerateCompIncludingSystemData" : {
  "isReductionCapacityAvailable" : true,
  "reductionCapacity" : 0,
  "isReductionRateAvailable" : false
},
"dataReductionIncludingSystemData" : {
  "isReductionCapacityAvailable" : true,
  "reductionCapacity" : 0,
  "isReductionRateAvailable" : false
},
"snapshotUsedCapacity" : 0,
"suspendSnapshot" : true,
"availablePhysicalFMCPoolVolumesCapacity" : 46998,
"usedPhysicalFMCPoolVolumesCapacity" : 4590,
"availableFMCPoolVolumesCapacity" : 46998,
"usedFMCPoolVolumesCapacity" : 46998,
"fmcPoolVolumesCapacitySaving" : 42407,

```

```

"fmcPoolVolumesCapacitySavingRate" : 90,
"fmcPoolVolumesCapacityExpansionRate" : 100,
"usedFMCLogicalPoolVolumesCapacity" : 0,
"capacitiesExcludingSystemData" : {
  "usedVirtualVolumeCapacity" : 0,
  "compressedCapacity" : 0,
  "dedupedCapacity" : 0,
  "reclaimedCapacity" : 0,
  "systemDataCapacity" : 0,
  "preUsedCapacity" : 0,
  "preCompressedCapacity" : 0,
  "preDedupredCapacity" : 0
}
} ]
}

```

When the detailed information for accelerated compression is obtained:

When the drive type of the pool volumes that make up the pool is `SSD(FMC)`, if you specify `SSD(FMC)` for the `detailInfoType` query parameter and then run the request, the following additional information is obtained.

| Attribute | Type | Description |
|--|------|--|
| <code>usedPhysicalCapacity</code> | long | Total physical capacity usage (MB) When the pool contains pool volumes for which the accelerated compression function is enabled, the compressed data is included in the total usage. |
| <code>availablePhysicalFMCPoolVolumesCapacity</code> | long | Total physical capacity of pool volumes for which the accelerated compression function is enabled (MB) The total capacity of pool volumes for which the accelerated compression function is enabled and writing is reserved is output. |
| <code>usedPhysicalFMCPoolVolumesCapacity</code> | long | Physical capacity usage by pool volumes for which the accelerated compression function is enabled (MB) The used capacity by pool volumes for which the accelerated compression function is enabled after they are compressed is output. |

| Attribute | Type | Description |
|-----------------------------------|------|---|
| usedFMCLogicalPoolVolumesCapacity | long | <p>Logical capacity usage of pool volumes for which the accelerated compression function is enabled (MB)</p> <p>The used capacity by pool volumes for which the accelerated compression function is enabled after they are compressed is output.</p> |
| availableFMCPoolVolumesCapacity | long | <p>Total capacity of pool volumes for which the accelerated compression function is enabled (MB)</p> <p>From among the volumes that make up the pool, the total capacity of pool volumes for which the accelerated compression function is enabled is output.</p> |
| usedFMCPoolVolumesCapacity | long | <p>Capacity usage of pool volumes for which the accelerated compression function is enabled (MB)</p> <p>From among the volumes that make up the pool, the usage of the pool volumes for which the accelerated compression function is enabled is output.</p> |
| fmcPoolVolumesCapacitySaving | long | <p>Data reduction in capacity of pool volume for which the accelerated compression function is enabled (MB)</p> <p>From among volumes that make up the pool, the reduction in the capacity of pool volumes for which the accelerated compression function is enabled, obtained by data compression is output.</p> |
| fmcPoolVolumesCapacitySavingRate | int | <p>Reduction rate of capacity of pool volumes for which the accelerated compression function is enabled (%)</p> |

| Attribute | Type | Description |
|--|------|---|
| | | <p>With regard to the pool volumes for which the accelerated compression function is enabled from among the volumes that make up the pool, the percentage (%) that <code>fmcPoolVolumesCapacitySaving</code> occupies of <code>usedFMCPoolVolumesCapacity</code> is output.</p> |
| <code>fmcPoolVolumesCapacityExpansionRate</code> | int | <p>Capacity expansion rate of pool volumes for which the accelerated compression function is enabled (%)</p> <p>The percentage (%) that <code>availableFMCPoolVolumesCapacity</code> occupies of <code>availablePhysicalFMCPoolVolumesCapacity</code> is output.</p> |

The following example shows the output when detailed information is obtained about the total efficiency.

```
{
  "data" : [ {
    "poolId" : 32,
    "poolStatus" : "POLN",
    "usedCapacityRate" : 49,
    "usedPhysicalCapacityRate" : 49,
    "snapshotCount" : 0,
    "poolName" : "pool_32",
    "availableVolumeCapacity" : 8190,
    "availablePhysicalVolumeCapacity" : 8190,
    "totalPoolCapacity" : 16254,
    "totalPhysicalCapacity" : 16254,
    "numOfLdevs" : 1,
    "firstLdevId" : 2229,
    "warningThreshold" : 70,
    "depletionThreshold" : 80,
    "virtualVolumeCapacityRate" : -1,
    "isMainframe" : false,
    "isShrinking" : false,
    "locatedVolumeCount" : 11,
    "totalLocatedCapacity" : 67173456,
    "blockingMode" : "NB",
    "totalReservedCapacity" : 0,
    "reservedVolumeCount" : 0,
    "poolType" : "HDP",
    "duplicationLdevIds" : [ 49098, 49097, 49096, 49095, 49094,
49093, 49092, 49091 ],
    "duplicationNumber" : 8,
    "dataReductionAccelerateCompCapacity" : 17174250,
    "dataReductionCapacity" : 17174250,
    "dataReductionBeforeCapacity" : 17175552,
    "dataReductionAccelerateCompRate" : 89,
    "duplicationRate" : 5,
    "compressionRate" : 84,
    "dataReductionRate" : 99,
    "dataReductionAccelerateCompIncludingSystemData" : {
      "isReductionCapacityAvailable" : true,
      "reductionCapacity" : 2580480,
      "isReductionRateAvailable" : true,
      "reductionRate" : 13
    },
    "dataReductionIncludingSystemData" : {
      "isReductionCapacityAvailable" : true,
      "reductionCapacity" : 2580480,
      "isReductionRateAvailable" : true,
      "reductionRate" : 14
    }
  } ]
}
```

```

    },
    "snapshotUsedCapacity" : 0,
    "suspendSnapshot" : true,
    "efficiency" : {
      "isCalculated" : true,
      "totalRatio" : "112.52",
      "compressionRatio" : "17.07",
      "snapshotRatio" : "-",
      "provisioningRate" : "84",
      "calculationStartTime" : "2016-07-31T20:32:47Z",
      "calculationEndTime" : "2016-07-31T20:41:09Z",
      "dedupeAndCompression" : {
        "totalRatio" : "18.47",
        "compressionRatio" : "8.61",
        "dedupeRatio" : "2.03",
        "reclaimRatio" : "1.05"
      },
      "acceleratedCompression" : {
        "totalRatio" : "1.00",
        "compressionRatio" : "1.00",
        "reclaimRatio" : "1.00"
      }
    },
    "capacitiesExcludingSystemData" : {
      "usedVirtualVolumeCapacity" : 19095552,
      "compressedCapacity" : 15975441,
      "dedupedCapacity" : 1064681,
      "reclaimedCapacity" : 1021936,
      "systemDataCapacity" : 15481578,
      "preUsedCapacity" : 18063360,
      "preCompressedCapacity" : 17041424,
      "preDedupredCapacity" : 1064982
    }
  }
}

```

When detailed information is obtained about the total efficiency

If you run the request with `efficiency` specified for the query parameter `detailInfoType`, the following information is obtained.

| Attribute | Type | Description |
|------------|--------|--|
| efficiency | object | Attributes related to the total efficiency are displayed. Calculated results for the period from <code>calculationStartTime</code> to <code>calculationEndTime</code> are obtained. |

| Attribute | Type | Description |
|-----------|------|---|
| | | <p>Only When <code>true</code> is specified for the attribute <code>isCalculated</code>, other subordinate attributes are also obtained. If the pool volume for which the calculation is to be performed does not exist, a hyphen (-) indicating an invalid value is displayed for these attributes. If the calculation cannot be performed for the pool because the pool is blocked or some other reason, the value from the previous calculation is displayed.</p> <p>For the attributes that display the total efficiency or the efficiency of capacity saving, these results are displayed as a ratio of the size of data before reduction to the size of data after reduction, where the size of data after reduction is 1.</p> <ul style="list-style-type: none"> ▪ <code>isCalculated</code> (boolean) <ul style="list-style-type: none"> Calculation status of the total efficiency This attribute indicates whether the total efficiency has been calculated. • <code>true</code>: The values have been calculated. • <code>false</code>: The values have not been calculated. ▪ <code>calculationStartTime</code> (ISO8601string) <ul style="list-style-type: none"> The date and time when the calculation of the total efficiency began (UTC) Displayed in the following format: YYYY-MM-DDThh:mm:ssZ ▪ <code>calculationEndTime</code> (ISO8601string) <ul style="list-style-type: none"> The date and time when the calculation of the total efficiency ended (UTC) Displayed in the following format: YYYY-MM-DDThh:mm:ssZ ▪ <code>totalRatio</code> (string) <ul style="list-style-type: none"> The total efficiency of the entire pool This does not include the size of metadata, garbage data, and other similar data generated by the storage system. After a volume is created from pool and before data is written to the volume, the maximum value (92233720368547758.07) is displayed. |

| Attribute | Type | Description |
|-----------|------|--|
| | | <ul style="list-style-type: none"> <li data-bbox="613 289 1424 441"> <p>▪ <code>compressionRatio</code> (string)</p> <p>The efficiency of capacity saving performed by using the capacity saving function (dedupe and compression) or accelerated compression</p> <p>This does not include the size of metadata, garbage data, and other similar data generated by the storage system.</p> <li data-bbox="613 556 1424 707"> <p>▪ <code>snapshotRatio</code> (string)</p> <p>The efficiency of capacity saving performed by using snapshots to back up data</p> <p>This does not include the size of metadata, garbage data, and other similar data generated by the storage system.</p> <li data-bbox="613 802 1424 953"> <p>▪ <code>provisioningRate</code> (string)</p> <p>The percentage (%) of the saving efficiency for consumption of capacity achieved by using Dynamic Provisioning to virtualize capacity</p> <p>This does not include the size of metadata, garbage data, and other similar data generated by the storage system.</p> |

| Attribute | Type | Description |
|-----------|------|---|
| | | <ul style="list-style-type: none"> <li data-bbox="618 289 1040 321">▪ dedupeAndCompression (object) <ul style="list-style-type: none"> <li data-bbox="654 338 1409 436">Attributes related to the efficiency of capacity saving performed by using the capacity saving function (dedupe and compression) are displayed. <li data-bbox="654 457 1382 520">This does not include the size of metadata, garbage data, and other similar data generated by the storage system. <li data-bbox="654 541 1357 657">• totalRatio (string) total efficiency of capacity saving performed by using the capacity saving function <li data-bbox="654 688 1414 772">• compressionRatio (string) Efficiency of capacity saving performed by using compression <li data-bbox="654 804 1256 926">• dedupeRatio (string) Efficiency of capacity saving performed by using deduplication (dedupe) <li data-bbox="654 957 1360 1073">• reclaimRatio (string) Efficiency of capacity saving performed by reclaiming the specified data pattern <li data-bbox="618 1129 1040 1161">▪ acceleratedCompression (object) <ul style="list-style-type: none"> <li data-bbox="654 1178 1393 1241">Attributes related to the efficiency of capacity saving performed by using accelerated compression are displayed. <li data-bbox="654 1262 1382 1325">This does not include the size of metadata, garbage data, and other similar data generated by the storage system. <li data-bbox="654 1346 1312 1461">• totalRatio (string) total efficiency of capacity saving performed by using accelerated compression <li data-bbox="654 1493 1414 1577">• compressionRatio (string) Efficiency of capacity saving performed by using compression <li data-bbox="654 1608 1360 1730">• reclaimRatio (string) Efficiency of capacity saving performed by reclaiming the specified data pattern |

When detailed information is obtained about the formatted capacity of the pool

If you run the request with `formattedCapacity` specified for the query parameter `detailInfoType`, the following information is obtained.

| Attribute | Type | Description |
|--------------------------------|------|--|
| <code>formattedCapacity</code> | long | The formatted capacity of the pool (MB) is displayed. If the information cannot be obtained, <code>-1</code> is displayed, indicating an invalid value. |

When additional detailed information is obtained from the storage system's cache

If you run this request with `class` specified for `detailInfoType` in the query parameters, the following information is obtained.

Immediately after an HDT pool is created, the information under the `tiers` attribute (shown in the following table) might not be output. In this case, wait a while and then run this request again. Alternatively, run the API request that updating the cache of storage system configuration information, and then run this request again.

| Attribute | Type | Description |
|-----------------------------------|------|---|
| <code>usedPhysicalCapacity</code> | long | Used physical capacity (MB) This information is output for DP pools. |

| Attribute | Type | Description |
|-----------|----------|--|
| tiers | object[] | <p>The following attributes related to the tiers of an HDT pool are output for each tier.</p> <ul style="list-style-type: none"> ▪ raidLevel (string) RAID level <ul style="list-style-type: none"> • RAID1 • RAID5 • RAID6 • Unknown <p>Unknown is output if the RAID level is unknown or multiple RAID levels are being used.</p> ▪ raidType (string) The combination of data drives and parity drives in a RAID configuration <ul style="list-style-type: none"> • 2D+2D • 3D+1P • 4D+1P • 6D+1P • 6D+2P • 7D+1P • 12D+2P • 14D+2P • Unknown <p>If any of the following apply, Unknown is output.</p> <ul style="list-style-type: none"> • The combination of data drives and parity drives is unknown. • Multiple combinations of data drives and parity drives are being used. • Multiple RAID levels are being used. |

| Attribute | Type | Description |
|--------------------------------------|----------------------|---|
| | | <ul style="list-style-type: none"> ▪ driveSpeed (int) Drive speed (rpm) If any of the following apply, -1 is output: <ul style="list-style-type: none"> • The combination of data drives and parity drives is unknown. • Multiple combinations of data drives and parity drives are being used. • Multiple RAID levels are being used. This information is not output if <code>driveTypeName</code> is <code>SSD</code> or <code>SCM</code>. ▪ driveTypeName (string) Drive types: <ul style="list-style-type: none"> • <code>SAS</code> • <code>SSD</code> • <code>SCM</code> • <code>Unknown</code> If any of the following apply, <code>Unknown</code> is output: <ul style="list-style-type: none"> • Multiple drive types are being used. • Multiple drives with different speeds are being used. ▪ substance (string) Types of volumes that make up a tier: <ul style="list-style-type: none"> • <code>Internal</code>: Internal volume • <code>External</code>: External volume • <code>Unknown</code>: Unknown or a combination of internal and external volumes |
| <code>hasBlockedPoolVolume</code> | <code>boolean</code> | <p>Whether a blocked pool volume exists</p> <p>This information is output for DP pools, Thin Image pools.</p> <ul style="list-style-type: none"> ▪ <code>true</code>: A blocked pool volume exists ▪ <code>false</code>: A blocked pool volume does not exist. |
| <code>usedLocatedCapacityRate</code> | <code>int</code> | Subscription rate of virtual volumes relative to the pool capacity (%) |

| Attribute | Type | Description |
|--------------------------------|---------|--|
| | | <p>This information is output for DP pools.</p> <p>The ratio of the sum of DP volume capacities to the DP pool capacity is output.</p> <p>The value is rounded down after the decimal point.</p> |
| relocationInterval | int | <p>Execution interval for performance monitoring and tier relocation</p> <p>This information is output for HDT pools.</p> <ul style="list-style-type: none"> ▪ 0: 30 minutes ▪ 1: 1 hour ▪ 2: 2 hours ▪ 4: 4 hours ▪ 8: 8 hours ▪ 24: 24 hours |
| monitoringStartTime | string | <p>Start time for performance monitoring</p> <p>This information is output for HDT pools.</p> <p>If <code>relocationInterval</code> is anything other than 24, a hyphen (-) is output, indicating an invalid value.</p> |
| monitoringEndTime | string | <p>End time for performance monitoring</p> <p>This information is output for HDT pools.</p> <p>If <code>relocationInterval</code> is anything other than 24, a hyphen (-) is output, indicating an invalid value.</p> |
| isExternalMixCompatibleEnabled | boolean | <p>Whether a pool can be configured by using a combination of internal volumes and external volumes</p> <p>This information is output for DP pools.</p> <ul style="list-style-type: none"> ▪ <code>true</code>: The pool can be configured by using a combination of internal and external volumes. ▪ <code>false</code>: The pool cannot be configured by using a combination of internal and external volumes. |
| lastMonitoringStartTime | string | Date and time when performance monitoring started |

| Attribute | Type | Description |
|--|---------|---|
| | | <p>This information is output for HDT pools.</p> <p>This information is output in the format YYYY-MM-DDThh:mm:ss.</p> <p>The local time of the storage system is output.</p> <p>If the value is invalid, a hyphen (-) is output.</p> |
| lastMonitoringEndTime | string | <p>Date and time when performance monitoring ended</p> <p>This information is output for HDT pools.</p> <p>This information is output in the format YYYY-MM-DDThh:mm:ss.</p> <p>The local time of the storage system is output.</p> <p>If the value is invalid, a hyphen (-) is output.</p> |
| relocationSpeed | string | <p>The speed at which tiers are relocated</p> <p>This information is output for HDT pools.</p> <ul style="list-style-type: none"> ▪ Slowest: Slowest ▪ Slow: Slow ▪ Normal: Normal ▪ Fast: Fast ▪ Fastest: Fastest |
| protectsLocatedVolumeOnFullPool | boolean | <p>Whether DP volumes are protected when I/O to a DP volume fails because the pool has been depleted</p> <p>This information is output for DP pools.</p> <ul style="list-style-type: none"> ▪ true: Protected ▪ false: Not protected |
| protectsLocatedVolumeOnBlockedPoolVolume | boolean | <p>Whether DP volumes are protected when I/O to a DP volume fails because the pool is blocked</p> <p>This information is output for DP pools.</p> <ul style="list-style-type: none"> ▪ true: Protected ▪ false: Not protected |
| isDeduplicationEnabled | boolean | <p>Whether deduplication is enabled for the pool</p> |

| Attribute | Type | Description |
|-----------|------|---|
| | | This information is output for DP pools. <ul style="list-style-type: none"> ▪ true: Enabled ▪ false: Disabled |

When detailed information is obtained on whether a pool volume is added automatically:

If you run the request with `autoAddPoolVol` specified for the query parameter `detailInfoType`, the following information is obtained.

| Attribute | Type | Description |
|-----------------------------|--------|---|
| <code>autoAddPoolVol</code> | string | Displays information on whether a pool volume is added automatically, depending on the compression rate of the parity group for which accelerated compression is enabled. <ul style="list-style-type: none"> ▪ Enabled: Added automatically ▪ Disabled: Not added automatically ▪ Not Supported: Not valid for this pool |

Status codes

For details on the status codes of the request for this operation, see the description on HTTP status codes.

Coding example

When getting information about all pools:

```
curl -v -H "Accept:application/json" -H "Content-Type:application/json" -H
"Authorization:Session d7b673af189048468c5af9bcf3b6bb6f" -X GET https://
192.0.2.100/ConfigurationManager/v1/objects/pools
```

When getting information about DP pools:

```
curl -v -H "Accept:application/json" -H "Content-Type:application/json" -H
"Authorization:Session d7b673af189048468c5af9bcf3b6bb6f" -X GET https://
192.0.2.100/ConfigurationManager/v1/objects/pools?poolType=DP
```

Getting information about a specific pool

The following request gets information about a specific pool by specifying the pool number.

Execution permission

Storage Administrator (View Only)

Request line

```
GET base-URL/v1/objects/pools/object-ID
```

Request message

Object ID

Specify the `poolId` value obtained by getting information about the pools.

| Attribute | Type | Description |
|---------------------|------|------------------------|
| <code>poolId</code> | int | (Required) Pool number |

Query parameters

None.

Body

None.

Response message

Body

The following is an example of the output generated when getting HDP pool information:

```
{
  "poolId": 0,
  "poolStatus": "POLN",
  "usedCapacityRate": 14,
  "usedPhysicalCapacityRate": 14,
  "snapshotCount": 0,
  "poolName": "testpool",
  "availableVolumeCapacity": 40320,
  "availablePhysicalVolumeCapacity": 40320,
  "totalPoolCapacity": 46998,
  "totalPhysicalCapacity": 46998,
  "numOfLdevs": 1,
  "firstLdevId": 1,
}
```

```

"warningThreshold": 70,
"depletionThreshold": 80,
"virtualVolumeCapacityRate": -1,
"isMainframe": false,
"isShrinking": false,
"locatedVolumeCount": 9,
"totalLocatedCapacity": 67132128,
"blockingMode": "NB",
"totalReservedCapacity": 0,
"reservedVolumeCount": 0,
"poolType": "HDP",
"duplicationLdevIds": [
    49151,
    49150,
    49149,
    49148,
    49147,
    49146,
    49145,
    49144
],
"duplicationNumber": 8,
"dataReductionAccelerateCompCapacity": 13072996,
"dataReductionCapacity": 13072996,
"dataReductionBeforeCapacity": 13074560,
"dataReductionAccelerateCompRate": 92,
"duplicationRate": 5,
"compressionRate": 86,
"dataReductionRate": 99,
"dataReductionAccelerateCompIncludingSystemData": {
    "isReductionCapacityAvailable": true,
    "reductionCapacity": 430080,
    "isReductionRateAvailable": true,
    "reductionRate": 3
},
"dataReductionIncludingSystemData": {
    "isReductionCapacityAvailable": true,
    "reductionCapacity": 430080,
    "isReductionRateAvailable": true,
    "reductionRate": 3
},
"snapshotUsedCapacity": 0,
"suspendSnapshot": true
}

```

For a DP pool:

| Attribute | Type | Description |
|---------------------------------|--------|--|
| poolId | int | Pool number |
| poolName | string | Pool name |
| poolType | string | Pool type <ul style="list-style-type: none"> ▪ HDP: HDP pool ▪ HDT: HDT pool ▪ RT: active flash pool ▪ DM: Data Direct Mapping HDP pool |
| poolStatus | string | One of the following is output as the pool status: <ul style="list-style-type: none"> ▪ POLN: Normal (Pool Normal) ▪ POLF: The pool is in the overflow status exceeding the threshold. (Pool Full) ▪ POLS: The pool is in the overflow status exceeding the threshold and is suspended. (Pool Suspend) ▪ POLE: The pool is suspended in the failure status. (Pool failure) <p>If the pool status is POLE, pool information cannot be obtained.</p> |
| usedCapacityRate | int | Usage rate of logical capacity (%) |
| usedPhysicalCapacityRate | int | Usage rate of physical capacity (%) |
| availableVolumeCapacity | long | Free logical capacity (MB) |
| availablePhysicalVolumeCapacity | long | Free physical capacity (MB) For this attribute, 1 MB is equal to 1,024 ² bytes. |
| totalPoolCapacity | long | Total logical capacity (MB) |
| totalPhysicalCapacity | long | Total physical capacity (MB) For this attribute, 1 MB is equal to 1,024 ² bytes. |
| numOfLdevs | int | Number of LDEVs in the pool |

| Attribute | Type | Description |
|---------------------------|---------|--|
| firstLdevId | int | The first LDEV number of the LDEVs in the pool |
| warningThreshold | int | The warning threshold set for the pool |
| depletionThreshold | int | The depletion threshold set for the pool |
| suspendSnapshot# | boolean | Whether to suspend Thin Image pairs when the depletion threshold is exceeded <ul style="list-style-type: none"> ▪ <code>true</code>: Thin Image pairs are suspended when the depletion threshold is exceeded. ▪ <code>false</code>: Thin Image pairs are not suspended when the depletion threshold is exceeded. |
| virtualVolumeCapacityRate | int | The maximum subscription limit of a virtual volume relative to pool capacity If unlimited is set, <code>-1</code> is output. For the following storage system models, <code>-1</code> is output to indicate an invalid value: VSP G350, G370, G700, G900, VSP F350, F370, F700, F900. |
| isShrinking | boolean | Whether the pool is shrinking is output. <ul style="list-style-type: none"> ▪ <code>true</code>: The pool is shrinking. ▪ <code>false</code>: The pool is not shrinking. |
| locatedVolumeCount | int | Total number of DP volumes mapped to the pool |
| totalLocatedCapacity | long | Total capacity of the DP volumes mapped to the pool (MB) The value of this attribute does not include the control area. |
| snapshotCount# | int | Total number of snapshot data items mapped to the pool |

| Attribute | Type | Description |
|-----------------------|--------|---|
| snapshotUsedCapacity# | long | Total size of snapshot data mapped to the pool (MB) |
| blockingMode | string | <p>Setting the protection function for a virtual volume</p> <p>When the DP pool is full or when the DP pool volume is blocked, whether the read and write operations can be performed for the DP volume that uses the target DP pool is output.</p> <ul style="list-style-type: none"> ▪ PF: Pool Full <p>If the DP pool is full, read and write operations are not possible.</p> <p>If the DP pool volume is blocked, read and write operations are possible.</p> ▪ PB: Pool vol Blockade <p>If the DP pool volume is blocked, read and write operations are not possible.</p> <p>If the DP pool is full, read and write operations are possible.</p> ▪ FB: Full or Blockade <p>If the DP pool is full or the DP pool volume is blocked, read and write operations are not possible.</p> ▪ NB: No Blocking <p>Even if the DP pool is full or the DP pool volume is blocked, read and write operations are possible for the target DP volume.</p> |
| totalReservedCapacity | long | Total capacity of the reserved page (MB) of the DP volume that is related to the DP pool |

| Attribute | Type | Description |
|---------------------|--------|---|
| | | If the Full Allocation functionality is not supported by the configuration, this attribute is not output. |
| reservedVolumeCount | int | <p>Number of volumes associated with the DP pool for which the page reservation setting is enabled</p> <p>If the Full Allocation functionality is not supported by the configuration, this attribute is not output.</p> |
| poolActionMode | string | <p>Execution mode for the pool</p> <ul style="list-style-type: none"> ▪ DEF: The mode in which the monitor is started or stopped by instructions from the REST API server, and the Tier range is specified by automatic calculation of the DKC. ▪ AUT: The mode in which the monitor is started or stopped at the specified time, and the Tier range is specified by automatic calculation of the DKC (specified by using Storage Navigator). |
| monitoringMode | string | <p>Performance monitoring execution mode (monitor mode)</p> <ul style="list-style-type: none"> ▪ PM: Period mode ▪ CM: Continuous mode |
| tierOperationStatus | string | <p>Operation status of performance monitoring and tier relocation is output.</p> <ul style="list-style-type: none"> ▪ STP: Performance monitoring and tier relocation are both stopped. ▪ RLC: Performance monitoring is stopped and tier relocation is operating. |

| Attribute | Type | Description |
|-----------|-----------|---|
| | | <ul style="list-style-type: none"> ▪ MON: Performance monitoring is operating and tier relocation is stopped. ▪ RLM: Performance monitoring and tier relocation are both operating. |
| dat | string | Status of monitor information <ul style="list-style-type: none"> ▪ VAL: Valid ▪ INV: Invalid ▪ PND: Pending calculation |
| tiers | object[] | The following attributes about HDT pool tiers are output for each tier. <ul style="list-style-type: none"> ▪ tierNumber (int) Tier number ▪ tierLevelRange (string) Lower limit of the tier The value is output as the number of I/O operations per hour (IOPH). ▪ tierDeltaRange (string) Delta value for the tier The value is output as the number of I/O operations per hour (IOPH). ▪ tierUsedCapacity (long) Amount used by the tier (MB) ▪ tierTotalCapacity (long) Total capacity of the tier (MB) ▪ tablespaceRate (int) Rate of free space to be used for new allocation ▪ performanceRate (int) Performance utilization |

| Attribute | Type | Description |
|--|-------|--|
| | | <ul style="list-style-type: none"> ▪ progressOfReplacing (int) Relocation progress rate The progress rate of the following tier relocation operation is output as a value from 0 to 99. <ul style="list-style-type: none"> • When the value of the <code>tierOperationStatus</code> attribute is <code>RLC</code> or <code>RLM</code>: Progress rate of relocation (being run). • When the value of the <code>tierOperationStatus</code> attribute is <code>STP</code> or <code>MON</code>: Progress rate of relocation (being suspended). <p>When tier relocation is not run or tier relocation is complete, 100 is output.</p> <ul style="list-style-type: none"> ▪ bufferSize (int) Buffer area rate for relocation |
| duplicationLdevIds [#] | int[] | LDEV numbers of the deduplication system data volumes |
| duplicationNumber [#] | int | Number of deduplication system data volumes |
| dataReductionAccelerateCompCapacity [#] | long | <p>Size (in blocks) of data reduction through the capacity saving function (dedupe and compression) or the accelerated compression function</p> <p>The size of data after reduction does not include the size of metadata and garbage data generated by the storage system.</p> |
| dataReductionCapacity [#] | long | Size (in blocks) of data reduction through the capacity saving function (compression and deduplication) |

| Attribute | Type | Description |
|---|--------|--|
| | | The size of data after reduction does not include the size of metadata and garbage data generated by the storage system. |
| dataReductionBeforeCapacity# | long | Size (in blocks) of data before data reduction was performed by using the capacity saving function (compression and deduplication) |
| dataReductionAccelerateCompRate# | int | <p>Percentage (%) of data on which data reduction has been performed by using the capacity saving function (compression and deduplication) or the accelerated compression function</p> <p>The size of data after reduction does not include the size of metadata and garbage data generated by the storage system.</p> |
| dataReductionRate# | int | <p>Percentage (%) of data on which data reduction has been performed by using the capacity saving function (compression and deduplication)</p> <p>The size of data after reduction does not include the size of metadata and garbage data generated by the storage system.</p> |
| dataReductionAccelerateCompIncludingSystemData# | object | The attributes related to the size of data reduced by using the capacity saving function (compression and deduplication) or the accelerated compression function are displayed. |

| Attribute | Type | Description |
|-----------|------|--|
| | | <p>These attributes are calculated based on the size of the data (which includes, in addition to user data, metadata and garbage data generated by the storage system) after data reduction is performed.</p> <ul style="list-style-type: none"> ▪ <code>isReductionCapacityAvailable</code> (boolean) <p>Whether the size of the data can be reduced</p> <ul style="list-style-type: none"> • <code>true</code>: The size of the data can be reduced. <p>If the value of this attribute is <code>true</code>, the size of the data that has been reduced is displayed for the <code>reductionCapacity</code> attribute.</p> • <code>false</code>: The size of the data cannot be reduced (for example, if the size of the data after data reduction is greater than the size of the data before data reduction). ▪ <code>reductionCapacity</code> (long) <p>Size (in blocks) of the data that was reduced</p> <p>This attribute is displayed when the value of the <code>isReductionCapacityAvailable</code> attribute is <code>true</code>.</p> |

| Attribute | Type | Description |
|--|--------|---|
| | | <ul style="list-style-type: none"> <li data-bbox="992 254 1416 961"> <p>▪ <code>isReductionRateAvailable</code> (boolean)</p> <p>Whether the size of the data can be reduced</p> <ul style="list-style-type: none"> <li data-bbox="1029 422 1386 485">• <code>true</code>: The size of the data can be reduced. <li data-bbox="1029 506 1416 709">If the value of this attribute is <code>true</code>, the percentage by which the size of the data has been reduced is displayed for the <code>reductionRate</code> attribute. <li data-bbox="1029 751 1403 961">• <code>false</code>: The size of the data cannot be reduced (for example, if the size of the data after data reduction is greater than the size of the data before data reduction). <li data-bbox="992 1010 1416 1304"> <p>▪ <code>reductionRate</code> (int)</p> <p>Percentage (%) by which the size of the data has been reduced</p> <p>This attribute is displayed when the value of the <code>isReductionRateAvailable</code> attribute is <code>true</code>.</p> |
| <code>dataReductionIncludingSystemData</code> [#] | object | The attributes related to the size of data reduced by using the capacity saving function (compression and deduplication) are displayed. |

| Attribute | Type | Description |
|-----------|------|---|
| | | <p>These attributes are calculated based on the size of the data (which includes, in addition to user data, metadata and garbage data generated by the storage system) after data reduction is performed.</p> <ul style="list-style-type: none"> ▪ <code>isReductionCapacityAvailable</code> (boolean) <p>Whether the size of the data can be reduced</p> <ul style="list-style-type: none"> • <code>true</code>: The size of the data can be reduced. If the value of this attribute is <code>true</code>, the size of the data that has been reduced is displayed for the <code>reductionCapacity</code> attribute. • <code>false</code>: The size of the data cannot be reduced (for example, if the size of the data after data reduction is greater than the size of the data before data reduction). ▪ <code>reductionCapacity</code> (long) <p>Size (in blocks) of the data that was reduced</p> <p>This attribute is displayed when the value of the <code>isReductionCapacityAvailable</code> attribute is <code>true</code>.</p> |

| Attribute | Type | Description |
|---|------|--|
| | | <ul style="list-style-type: none"> <li data-bbox="992 254 1416 953"> <p>▪ <code>isReductionRateAvailable</code> (boolean)</p> <p>Whether the size of the data can be reduced</p> <ul style="list-style-type: none"> <li data-bbox="1029 422 1386 485">• <code>true</code>: The size of the data can be reduced. <p>If the value of this attribute is <code>true</code>, the percentage by which the size of the data has been reduced is displayed for the <code>reductionRate</code> attribute.</p> <ul style="list-style-type: none"> <li data-bbox="1029 751 1403 953">• <code>false</code>: The size of the data cannot be reduced (for example, if the size of the data after data reduction is greater than the size of the data before data reduction). <li data-bbox="992 1010 1416 1310"> <p>▪ <code>reductionRate</code> (int)</p> <p>Percentage (%) by which the size of the data has been reduced</p> <p>This attribute is displayed when the value of the <code>isReductionRateAvailable</code> attribute is <code>true</code>.</p> |
| <code>compressionRate</code> [#] | int | Percentage (%) of data on which data reduction has been performed by using the compression function or the accelerated compression function |
| <code>duplicationRate</code> [#] | int | Percentage (%) of data on which data reduction has been performed by using the deduplication function |

| Attribute | Type | Description |
|-------------|---------|---|
| isMainframe | boolean | Displays a pool for the mainframe or the open system <ul style="list-style-type: none"> ▪ true: Pool for the mainframe volume ▪ false: Pool for the open volume |

#: These attributes and those under objects are displayed when the pool type is HDP.

The following is an example of the output generated when getting Thin Image pool information:

```
{
  "poolId": 3,
  "poolStatus": "POLN",
  "usedCapacityRate": 0,
  "usedPhysicalCapacityRate": 0,
  "snapshotCount": 0,
  "poolName": "pool_for_snapshot_data",
  "availableVolumeCapacity": 6006,
  "availablePhysicalVolumeCapacity": 6006,
  "totalPoolCapacity": 6006,
  "totalPhysicalCapacity": 6006,
  "numOfLdevs": 1,
  "firstLdevId": 1026,
  "warningThreshold": 80,
  "virtualVolumeCapacityRate": -1,
  "isMainframe": false,
  "isShrinking": false,
  "poolType": "HTI"
}
```

For a Thin Image pool:

| Attribute | Type | Description |
|-----------|--------|--|
| poolId | int | Pool number |
| poolName | string | Pool name |
| poolType | string | Pool type is output. HTI: Thin Image pool |

| Attribute | Type | Description |
|---------------------------------|--------|---|
| poolStatus | string | <p>One of the following is output as the pool status:</p> <ul style="list-style-type: none"> ▪ POLN: Normal (Pool Normal) ▪ POLF: The pool is in the overflow status exceeding the threshold. (Pool Full) ▪ POLS: The pool is in the overflow status exceeding the threshold and is suspended. (Pool Suspend) ▪ POLE: The pool is suspended in the failure status. (Pool failure) <p>If the pool status is POLE, pool information cannot be obtained.</p> |
| usedCapacityRate | int | Usage rate of logical capacity (%) |
| usedPhysicalCapacityRate | int | Usage rate of physical capacity (%) |
| snapshotCount | int | Number of volumes in the pool |
| availableVolumeCapacity | long | Free logical capacity (MB) |
| availablePhysicalVolumeCapacity | long | Free physical capacity (MB) For this attribute, 1 MB is equal to 1,024 ² bytes. |
| totalPoolCapacity | long | Total logical capacity (MB) |
| totalPhysicalCapacity | long | Total physical capacity (MB) For this attribute, 1 MB is equal to 1,024 ² bytes. |
| numOfLdevs | int | Number of LDEVs in the pool |
| firstLdevId | int | The first LDEV number of the LDEVs in the pool (Not the first number in ascending order) |
| warningThreshold | int | The warning threshold set for the pool |
| virtualVolumeCapacityRate | int | -1 indicating the invalid value is output. |

| Attribute | Type | Description |
|-------------|---------|---|
| isShrinking | boolean | Whether the pool is shrinking is output. <ul style="list-style-type: none"> ▪ <code>true</code>: The pool is shrinking. ▪ <code>false</code>: The pool is not shrinking. |
| isMainframe | boolean | Displays a pool for the mainframe or the open system <ul style="list-style-type: none"> ▪ <code>true</code>: Pool for the mainframe volume ▪ <code>false</code>: Pool for the open volume |

Status codes

For details on the status codes of the request for this operation, see the description on HTTP status codes.

Coding example

```
curl -v -H "Accept:application/json" -H "Content-Type:application/json" -H
"Authorization:Session d7b673af189048468c5af9bcf3b6bb6f" -X GET https://
192.0.2.100/ConfigurationManager/v1/objects/pools/18
```

Creating a pool

The following request creates pools by specifying the LDEV. In the REST API, you can create DP pools and Thin Image pools. You can specify LDEVs by specifying LDEV numbers or a range of consecutive LDEV numbers.



Tip: If you want to store snapshot data in an HDP pool instead of a Thin Image pool, specify `HDP` for the `poolType` attribute when you create the pool.

Execution permission

Storage Administrator (Provisioning)

Request line

```
POST base-URL/v1/objects/pools
```

Request message

Object ID

None.

Query parameters

None.

Body

The following coding example creates an HDP pool by specifying the LDEV number:

```
{
  "poolId": 76,
  "poolName": "pool_for_email_server",
  "ldevIds": [405],
  "poolType": "HDP"
}
```

The following coding example creates an HDP pool by specifying a range of consecutive LDEV numbers:

```
{
  "poolId": 76,
  "poolName": "pool_for_email_server",
  "startLdevId": 101,
  "endLdevId": 105,
  "poolType": "HDP"
}
```

When creating a DP pool:

| Attribute | Type | Description |
|-----------|--------|---|
| poolId | int | (Required) Specify the pool number with a decimal (base 10) number. |
| poolName | string | (Required) Pool name Specify a character string consisting of 1 to 32 characters. |
| poolType | string | (Required) Pool type The specifiable values are as follows: <ul style="list-style-type: none"> ▪ HDP: HDP pools ▪ HDT: HDT pools |
| ldevIds | int[] | (Optional) LDEV number Specify a decimal (base 10) number. Make sure to specify this attribute when specifying LDEV numbers. |

| Attribute | Type | Description |
|---------------------------------|------|--|
| | | You can specify up to 64 digits. This attribute cannot be specified along with the <code>startLdevId</code> and <code>endLdevId</code> attribute. |
| <code>startLdevId</code> | int | <p>(Optional) The first LDEV number in the range of consecutive LDEV numbers, if such a range is specified</p> <p>Make sure to specify this attribute when specifying a range of LDEV numbers.</p> <p>If you specify this attribute, be sure to also specify the <code>endLdevId</code> attribute. The value of this attribute must be smaller than that of <code>endLdevId</code>.</p> <p>Specify a number such that the range indicated by the <code>startLdevId</code> and <code>endLdevId</code> attributes consists of no more than 64 LDEVs.</p> <p>This attribute cannot be specified along with the <code>ldevIds</code> attribute.</p> |
| <code>endLdevId</code> | int | <p>(Optional) The last LDEV number in the range of consecutive LDEV numbers, if such a range is specified</p> <p>Make sure to specify this attribute when specifying a range of LDEV numbers.</p> <p>If you specify this attribute, be sure to also specify the <code>startLdevId</code> attribute. The value of this attribute must be greater than that of <code>startLdevId</code>.</p> <p>Specify a number such that the range indicated by the <code>startLdevId</code> and <code>endLdevId</code> attributes consists of no more than 64 LDEVs.</p> <p>This attribute cannot be specified along with the <code>ldevIds</code> attribute.</p> |
| <code>warningThreshold</code> | int | <p>(Optional) Warning threshold (%)</p> <p>Specify a value in the range from 1 to 100. Specify a value smaller than that of <code>depletionThreshold</code>. If this attribute is omitted, 70 is assumed.</p> |
| <code>depletionThreshold</code> | int | <p>(Optional) Depletion threshold (%)</p> <p>Specify a value in the range from 1 to 100. Specify a value greater than the value of <code>warningThreshold</code>. If this attribute is omitted, 80 is assumed.</p> |

| Attribute | Type | Description |
|-----------------|---------|--|
| suspendSnapshot | boolean | <p>(Optional) Specify whether to suspend Thin Image pairs when the depletion threshold is exceeded.</p> <p>You can specify this attribute if the pool to be created is an HDP pool for storing snapshot data.</p> <ul style="list-style-type: none"> <code>true</code>: Suspend Thin Image pairs when the depletion threshold is exceeded. <code>false</code>: Do not suspend Thin Image pairs when the depletion threshold is exceeded. <p>If you specify <code>HDP</code> for the <code>poolType</code> attribute and omit this attribute, <code>true</code> is assumed.</p> |

The following coding example creates a Thin Image pool:

```
{
  "poolId":76,
  "poolName":"pool_for_snapshot_copy",
  "ldevIds":[405],
  "poolType": "HTI"
}
```

When creating a Thin Image pool:

| Attribute | Type | Description |
|-----------|--------|---|
| poolId | int | (Required) Specify the pool number with a decimal (base 10) number. |
| poolName | string | (Required) Pool name Specify a character string consisting of 1 to 32 characters. |
| poolType | string | (Required) Pool type <code>HTI</code> : Thin Image pools |
| ldevIds | int[] | (Optional) LDEV number Specify a decimal (base 10) number. Make sure to specify this attribute when specifying LDEV numbers. You can specify up to 64 digits. This attribute cannot be specified along with the <code>startLdevId</code> and <code>endLdevId</code> attribute. |

| Attribute | Type | Description |
|------------------|------|--|
| startLdevId | int | <p>(Optional) First LDEV number when specifying a range of consecutive LDEV numbers.</p> <p>Make sure to specify this attribute when specifying a range of LDEV numbers.</p> <p>If you specify this attribute, be sure to also specify the <code>endLdevId</code> attribute. The value of this attribute must be smaller than that of <code>endLdevId</code>.</p> <p>Specify a number such that the range indicated by the <code>startLdevId</code> and <code>endLdevId</code> attributes consists of no more than 64 LDEVs.</p> <p>This attribute cannot be specified along with the <code>ldevIds</code> attribute.</p> |
| endLdevId | int | <p>(Optional) Last LDEV number when specifying a range of consecutive LDEV numbers.</p> <p>Make sure to specify this attribute when specifying a range of LDEV numbers.</p> <p>If you specify this attribute, be sure to also specify the <code>startLdevId</code> attribute. The value of this attribute must be greater than that of <code>startLdevId</code>.</p> <p>Specify a number such that the range indicated by the <code>startLdevId</code> and <code>endLdevId</code> attributes consists of no more than 64 LDEVs.</p> <p>This attribute cannot be specified along with the <code>ldevIds</code> attribute.</p> |
| warningThreshold | int | <p>(Optional) Warning threshold (%)</p> <p>Specify a value in the range from 20 to 95. If this attribute is omitted, 80 is assumed.</p> |

Response message

Body

A job object is returned. For details on attributes other than `affectedResources`, see the section explaining job objects.

| Attribute | Description |
|--------------------------------|-------------------------|
| <code>affectedResources</code> | URL of the created pool |

Status codes

The following table describes the meaning of the status code of the request for this operation. For details on other status codes, see the description on HTTP status codes.

| Status code | Message | Description |
|-------------|----------|---|
| 409 | Conflict | A pool of the specified pool number has already been created. |

Coding example

```
curl -v -H "Accept:application/json" -H "Content-Type:application/json" -H
"Authorization:Session d7b673af189048468c5af9bcf3b66b6f" -X POST --data-
binary @./InputParameters.json https://192.0.2.100/ConfigurationManager/v1/
objects/pools
```

Changing pool settings

The following request changes the pool name, pool type, attributes related to an HDT pool tier, and other settings.

Execution permission

Storage Administrator (Provisioning)

Request line

```
PATCH base-URL/v1/objects/pools/object-ID
```

Request message**Object ID**

Specify the value of `poolId` that was obtained by the processing to get information about pools.

| Attribute | Type | Description |
|-----------|------|------------------------|
| poolId | int | (Required) Pool number |

Query parameters

None.

Body

The following coding example changes the warning threshold and depletion threshold of a DP pool,:

```
{
  "warningThreshold": 75,
  "depletionThreshold": 85
}
```

The following coding example sets the attributes related to a specific tier of an HDT pool:

```
{
  "tier": {
    "tierNumber": 1,
    "tablespaceRate": 30,
    "bufferRate": 30
  }
}
```

| Attribute | Type | Description |
|------------------|--------|--|
| poolName | string | (Optional) Pool name Specify the pool name by using 1 to 32 characters. |
| poolType | string | (Optional) Changes the pool type You can specify the following values: <ul style="list-style-type: none"> ▪ HDP: Changes to an HDP pool You cannot specify this value for pools for active flash. ▪ HDT: Changes to an HDT pool You cannot specify this value for HDP pools for which Thin Image pairs have been created. ▪ RT: Changes to a pool for active flash You cannot specify this value for HDP pools. You cannot specify this attribute for Thin Image pools or for data direct mapping HDP pools. |
| warningThreshold | int | (Optional) New warning threshold (%) |

| Attribute | Type | Description |
|---------------------------|---------|--|
| | | <p>Depending on the pool type, specify the following values:</p> <ul style="list-style-type: none"> ▪ For DP pools: 1 to 100 <p>Specify this attribute together with the <code>depletionThreshold</code> attribute.</p> <ul style="list-style-type: none"> ▪ For Thin Image pools: 20 to 95 <p>You cannot specify this value for data direct mapping HDP pools.</p> |
| depletionThreshold | int | <p>(Optional) New depletion threshold (%)</p> <p>Specify a value in the range from 1 to 100.</p> <p>For DP pools, specify this attribute together with the <code>warningThreshold</code> attribute.</p> <p>You cannot specify this value for Thin Image pools or for data direct mapping HDP pools.</p> |
| suspendSnapshot | boolean | <p>(Optional) Whether to suspend Thin Image pairs when the depletion threshold is exceeded.</p> <p>You can specify this attribute for HDP pools that contain snapshot data.</p> <ul style="list-style-type: none"> ▪ <code>true</code>: Suspend Thin Image pairs when the depletion threshold is exceeded. ▪ <code>false</code>: Do not suspend Thin Image pairs when the depletion threshold is exceeded. |
| virtualVolumeCapacityRate | int | <p>(Optional) The subscription limit of a virtual volume to pool capacity (%)</p> <p>You can use this attribute for VSP 5000 series, VSP E series.</p> <p>Specify a value in the range from 0 to 65534. If you specify <code>-1</code>, the subscription limit is unlimited.</p> <p>You cannot specify this value for Thin Image pools.</p> |
| blockingMode | string | <p>(Optional) Setting the protection function for a virtual volume</p> |

| Attribute | Type | Description |
|-----------|--------|--|
| | | <p>If a DP pool is full or a DP pool volume is blocked, specify whether it is possible to perform read and write operations for a DP volume that uses the target DP pool.</p> <ul style="list-style-type: none"> ▪ PF: Pool Full If the DP pool is full, read and write operations are not possible. If the DP pool volume is blocked, read and write operations are possible. ▪ PB: Pool vol Blockade If the DP pool volume is blocked, read and write operations are not possible. If the DP pool is full, read and write operations are possible. ▪ FB: Full or Blockade If the DP pool is full or the DP pool volume is blocked, read and write operations are not possible. ▪ NB: No Blocking Even if the DP pool is full or the DP pool volume is blocked, read and write operations are possible for the target DP volume. <p>You cannot specify this value for Thin Image pools.</p> |
| tier | object | <p>(Optional) HDT pool tier attribute</p> <ul style="list-style-type: none"> ▪ tierNumber (int) Tier number Specify a number from 1 to 3. This must be specified if you want to change the <code>tablespaceRate</code> attribute or the <code>bufferRate</code> attribute. ▪ tablespaceRate (int) Ratio of free space for new tiering (in percentage) Specify a value from 0 to 50. If you specify this attribute, you must also specify the <code>tierNumber</code> attribute. |

| Attribute | Type | Description |
|----------------|--------|---|
| | | <ul style="list-style-type: none"> bufferRate (int) Ratio of buffer areas for reallocation (in percentage) Specify a value from 2 to 40. If you specify this attribute, you must also specify the tierNumber attribute. |
| monitoringMode | string | (Optional) Execution mode for performance monitoring (monitor mode) If the pool type is HDT, the following values can be specified: <ul style="list-style-type: none"> PM: Periodic mode (Period Mode) CM: Continuous mode (Continuous Mode) |

Response message

Body

A job object is returned. For details on attributes other than `affectedResources`, see the description on job objects.

| Attribute | Description |
|-------------------|---|
| affectedResources | URL of the pool whose settings were changed |

Action template

None.

Status codes

The following table describes the meanings of the status codes of the request for this operation. For details on the other status codes, see the description about HTTP status codes.

| Status code | Message | Description |
|-------------|----------|---|
| 409 | Conflict | The specified pool name already exists. |

Coding example

```
curl -v -H "Accept:application/json" -H "Content-Type:application/json" -H
"Authorization:Session d7b673af189048468c5af9bcf3b66b6f" -X PATCH --data-
binary @./InputParameters.json https://192.0.2.100/ConfigurationManager/v1/
objects/pools/88
```

Expanding a pool

To expand the capacity of a pool, the following request adds LDEVs to the pool.

Execution permission

Storage Administrator (Provisioning)

Request line

```
POST base-URL/v1/objects/pools/object-ID/actions/expand/invoke
```

Request message**Object ID**

Specify the `poolId` value obtained by getting information about pools.

| Attribute | Type | Description |
|-----------|------|------------------------|
| poolId | int | (Required) Pool number |

Query parameters

None.

Body

```
{
  "parameters": {
    "ldevIds": [101,102]
  }
}
```

| Attribute | Type | Description |
|-----------|-------|---|
| ldevIds | int[] | (Optional) Specify the LDEV number with a decimal (base 10) number. |

| Attribute | Type | Description |
|-------------|------|--|
| | | You can specify up to 64 numbers. This attribute cannot be specified along with the startLdevId and endLdevId attribute. |
| startLdevId | int | <p>(Optional) First LDEV number when specifying a range of consecutive LDEV numbers.</p> <p>If you specify this attribute, be sure to also specify the endLdevId attribute. The value of this attribute must be smaller than that of endLdevId.</p> <p>Specify a number such that the range indicated by the startLdevId and endLdevId attributes consists of no more than 64 LDEVs.</p> <p>This attribute cannot be specified along with the ldevIds attribute.</p> |
| endLdevId | int | <p>(Optional) Last LDEV number when specifying a range of consecutive LDEVs.</p> <p>If you specify this attribute, be sure to also specify the startLdevId attribute. The value of this attribute must be greater than that of startLdevId.</p> <p>Specify a number such that the range indicated by the startLdevId and endLdevId attributes consists of no more than 64 LDEVs.</p> <p>This attribute cannot be specified along with the ldevIds attribute.</p> |

Response message

Body

A job object is returned. For details on attributes other than `affectedResources`, see the section explaining job objects.

| Attribute | Description |
|-------------------|--------------------------|
| affectedResources | URL of the expanded pool |

Action template

```
GET base-URL/v1/objects/pools/object-ID/actions/expand
```

Status codes

For details on the status codes of the request for this operation, see the description on HTTP status codes.

Coding example

To get an action template:

```
curl -v -H "Accept:application/json" -H "Content-Type:application/json" -H
"Authorization:Session d7b673af189048468c5af9bcf3b66b6f" -X GET https://
192.0.2.100/ConfigurationManager/v1/objects/pools/3/actions/expand
```

To run the request after getting an action template:

```
curl -v -H "Accept:application/json" -H "Content-Type:application/json" -H
"Authorization:Session d7b673af189048468c5af9bcf3b66b6f" -X POST --data-
binary @./InputParameters.json https://192.0.2.100/ConfigurationManager/v1/
objects/pools/3/actions/expand/invoke
```

Shrinking a pool

The following request removes an LDEV from a pool to decrease the pool capacity. Note that you cannot remove all LDEVs from the pool.

Execution permission

Storage Administrator (Provisioning)

Request line

```
POST base-URL/v1/objects/pools/object-ID/actions/shrink/invoke
```

Request message**Object ID**

Specify the value of `poolId` that was obtained by the processing to get information about pools.

| Attribute | Type | Description |
|-----------|------|------------------------|
| poolId | int | (Required) Pool number |

Query parameters

None.

Body

```
{
  "parameters": {
    "ldevIds": [101,102]
  }
}
```

| Attribute | Type | Description |
|-------------|-------|--|
| ldevIds | int[] | <p>(Optional) Specify the LDEV number with a decimal (base 10) number.</p> <p>You can specify up to 64 numbers. This attribute cannot be specified along with the startLdevId and endLdevId attribute.</p> |
| startLdevId | int | <p>(Optional) First LDEV number when specifying a range of consecutive LDEV numbers.</p> <p>If you specify this attribute, be sure to also specify the endLdevId attribute. The value of this attribute must be smaller than that of endLdevId.</p> <p>Specify a number such that the range indicated by the startLdevId and endLdevId attributes consists of no more than 64 LDEVs.</p> <p>This attribute cannot be specified along with the ldevIds attribute.</p> |
| endLdevId | int | <p>(Optional) Last LDEV number when specifying a range of consecutive LDEVs.</p> <p>If you specify this attribute, be sure to also specify the startLdevId attribute. The value of this attribute must be greater than that of startLdevId.</p> <p>Specify a number such that the range indicated by the startLdevId and endLdevId attributes consists of no more than 64 LDEVs.</p> <p>This attribute cannot be specified along with the ldevIds attribute.</p> |

Response message**Body**

A job object is returned. For details on attributes other than `affectedResources`, see the description on job objects.

| Attribute | Description |
|-------------------|-------------------------|
| affectedResources | URL of the shrunk pools |

Action template

```
GET base-URL/v1/objects/pools/object-ID/actions/shrink
```

Status codes

The following table describes the meaning of the status code of the request for this operation. For details on other status codes, see the description on HTTP status codes.

| Status code | Message | Description |
|-------------|---------------------|--|
| 412 | Precondition Failed | The specified action cannot be run on the specified pool because there is only one LDEV in the pool. |

Coding example

To get an action template:

```
curl -v -H "Accept:application/json" -H "Content-Type:application/json" -H "Authorization:Session d7b673af189048468c5af9bcf3b6bb6f" -X GET https://192.0.2.100/ConfigurationManager/v1/objects/pools/3/actions/shrink
```

To run the request after getting an action template:

```
curl -v -H "Accept:application/json" -H "Content-Type:application/json" -H "Authorization:Session d7b673af189048468c5af9bcf3b6bb6f" -X POST --data-binary @./InputParameters.json https://192.0.2.100/ConfigurationManager/v1/objects/pools/3/actions/shrink/invoke
```

Performing performance monitoring of a pool

The following request starts or ends performance monitoring of an HDT pool. By performing performance monitoring, you can collect the I/O performance on each page of a pool as monitoring information to understand the characteristics of the I/O performance on each page allocated to an HDT volume. Perform performance monitoring before tier relocation.

Execution permission

Storage Administrator (Provisioning)

Request line

```
POST base-URL/v1/objects/pools/object-ID/actions/monitor/invoke
```

Request message**Object ID**

Specify the `poolId` value obtained by getting information about pools.

| Attribute | Type | Description |
|---------------------|------|------------------------|
| <code>poolId</code> | int | (Required) Pool number |

Query parameters

None.

Body

```
{
  "parameters": {
    "operationType": "start"
  }
}
```

| Attribute | Type | Description |
|----------------------------|--------|---|
| <code>operationType</code> | string | (Required) Specify the operation of performance monitoring. <ul style="list-style-type: none"> ▪ <code>start</code>: Start performance monitoring. ▪ <code>stop</code>: End performance monitoring. |

Response message**Body**

A job object is returned. For details on attributes other than `affectedResources`, see the section explaining job objects.

| Attribute | Description |
|--------------------------------|---|
| <code>affectedResources</code> | URL of the pool for which performance monitoring was started or ended |

Action template

```
GET base-URL/v1/objects/pools/object-ID/actions/monitor
```

Status codes

The following table explains the meanings of the status codes for this API. For details on other status codes, see the section explaining HTTP status codes.

| Status code | Message | Description |
|-------------|---------------------|--|
| 412 | Precondition Failed | The specified action cannot be run because the pool meets either of the following conditions: <ul style="list-style-type: none"> The pool is not an HDT pool. The execution mode for the pool is auto (AUT). |

Coding example

To get an action template:

```
curl -v -H "Accept:application/json" -H "Content-Type:application/json" -H
"Authorization:Session d7b673af189048468c5af9bcf3bbbb6f" -X GET https://
192.0.2.100/ConfigurationManager/v1/objects/pools/3/actions/monitor
```

To run the API request after getting an action template:

```
curl -v -H "Accept:application/json" -H "Content-Type:application/json" -H
"Authorization:Session d7b673af189048468c5af9bcf3bbbb6f" -X POST --data-
binary @./InputParameters.json https://192.0.2.100/ConfigurationManager/v1/
objects/pools/3/actions/monitor/invoke
```

Performing tier relocation

The following request relocates HDT pool data (in units of pages) to an appropriate tier, based on the monitoring information collected by performance monitoring. Before performing tier relocation, perform performance monitoring in advance.

Execution permission

Storage Administrator (Provisioning)

Request line

```
POST base-URL/v1/objects/pools/object-ID/actions/relocate/invoke
```

Request message**Object ID**

Specify the `poolId` value obtained by getting information about pools.

| Attribute | Type | Description |
|---------------------|------|------------------------|
| <code>poolId</code> | int | (Required) Pool number |

Query parameters

None.

Body

```
{
  "parameters": {
    "operationType": "start"
  }
}
```

| Attribute | Type | Description |
|----------------------------|--------|--|
| <code>operationType</code> | string | (Required) Specify the operation of tier relocation. <ul style="list-style-type: none"> <code>start</code>: Start tier relocation. <code>stop</code>: End tier relocation. |

Response message**Body**

A job object is returned. For details on attributes other than `affectedResources`, see the section explaining job objects.

| Attribute | Description |
|--------------------------------|--|
| <code>affectedResources</code> | URL of the pool for which tier relocation was started or ended |

Action template

```
GET base-URL/v1/objects/pools/object-ID/actions/relocate
```

Status codes

The following table explains the meanings of the status codes for this API. For details on other status codes, see the section explaining HTTP status codes.

| Status code | Message | Description |
|-------------|---------------------|--|
| 412 | Precondition Failed | The specified action cannot be run because the pool meets either of the following conditions: <ul style="list-style-type: none"> ▪ The pool is not an HDT pool. ▪ The execution mode for the pool is auto (AUT). |

Coding example

To get an action template:

```
curl -v -H "Accept:application/json" -H "Content-Type:application/json" -H
"Authorization:Session d7b673af189048468c5af9bcf3b6bb6f" -X GET https://
192.0.2.100/ConfigurationManager/v1/objects/pools/3/actions/relocate
```

To run the API request after getting an action template:

```
curl -v -H "Accept:application/json" -H "Content-Type:application/json" -H
"Authorization:Session d7b673af189048468c5af9bcf3b6bb6f" -X POST --data-
binary @./InputParameters.json https://192.0.2.100/ConfigurationManager/v1/
objects/pools/3/actions/relocate/invoke
```

Restoring a pool

The following request unblocks a pool after recovery from a failure or other problems.

Execution permission

Storage Administrator (Provisioning)

Request line

```
POST base-URL/v1/objects/pools/object-ID/actions/recover/invoke
```

Request message**Object ID**

Specify the `poolId` value obtained by getting information about pools.

| Attribute | Type | Description |
|-----------|------|------------------------|
| poolId | int | (Required) Pool number |

Query parameters

None.

Body

None.

Response message**Body**

A job object is returned. For details on attributes other than `affectedResources`, see the section explaining job objects.

| Attribute | Description |
|-------------------|---------------------------|
| affectedResources | URL of the recovered pool |

Action template

None.

Status codes

The following table explains the meanings of the status codes for this API. For details on other status codes, see the section explaining HTTP status codes.

| Status code | Message | Description |
|-------------|---------------------|--|
| 412 | Precondition Failed | The specified action cannot be run because the pool meets either of the following conditions: <ul style="list-style-type: none"> ▪ The pool is not in the blocked status. ▪ The pool usage rate is 100%. |

Coding example

```
curl -v -H "Accept:application/json" -H "Content-Type:application/json" -H
"Authorization:Session d7b673af189048468c5af9bcf3bbbb6f" -X POST https://
192.0.2.100/ConfigurationManager/v1/objects/pools/3/actions/recover/invoke
-d ""
```

Initializing the capacity saving function for a pool

The following request initializes, in a batch operation, the capacity saving function (dedupe and compression) for specified pools for which the deduplication function is enabled. This request formats all deduplication system data volumes and volumes for which the capacity saving function (deduplication) is enabled.



Note:

- After running this API function, if necessary, change the `status` attribute to the normal status for the volumes for which the capacity saving function (deduplication) is enabled.

Execution permission

Storage Administrator (Provisioning)

Request line

```
POST base-URL/v1/objects/pools/object-ID/actions/data-reduction-initialize/
invoke
```

Request message

Object ID

Specify the `poolId` value obtained by getting information about the pools.

| Attribute | Type | Description |
|---------------------|------------------|------------------------|
| <code>poolId</code> | <code>int</code> | (Required) Pool number |

Query parameters

None.

Body

None.

Response message

Body

A job object is returned. For details on attributes other than `affectedResources`, see the description of job objects.

| Attribute | Description |
|-------------------|---|
| affectedResources | URL of the pool to which the initialized volumes belong |

Action template

None.

Status codes

For details on the status codes of the request for this operation, see the description on HTTP status codes.

Coding example

```
curl -v -H "Accept:application/json" -H "Content-Type:application/json" -H
"Authorization:Session d7b673af189048468c5af9bcf3bbbb6f" -X POST https://
192.0.2.100/ConfigurationManager/v1/objects/pools/3/actions/data-reduction-
initialize/invoke -d ""
```

Deleting a pool

The following request deletes a pool by specifying the pool number.

Execution permission

Storage Administrator (Provisioning)

Request line

```
DELETE base-URL/v1/objects/pools/object-ID
```

Request message**Object ID**

Specify the `poolId` value obtained by getting information about pools.

| Attribute | Type | Description |
|-----------|------|------------------------|
| poolId | int | (Required) Pool number |

Query parameters

None.

Body

None.

Response message**Body**

A job object is returned. For details on attributes other than `affectedResources`, see the section explaining job objects.

| Attribute | Description |
|--------------------------------|-------------------------|
| <code>affectedResources</code> | URL of the deleted pool |

Status codes

For details on the status codes of the request for this operation, see the description on HTTP status codes.

Coding example

```
curl -v -H "Accept:application/json" -H "Content-Type:application/json" -H
"Authorization:Session d7b673af189048468c5af9bcf3b66b6f" -X DELETE
https://192.0.2.100/ConfigurationManager/v1/objects/pools/3
```

Chapter 7: Optimizing I/O performance

This chapter describes how the REST API can be used to optimize I/O performance between the host and the storage system by using the functions of Virtual Partition Manager, QoS (Quality of Service), and Server Priority Manager, or by changing the assignment of MP blade servers.

Overview of optimizing I/O performance

This section describes optimization of I/O performance between a host and a storage system.

To optimize I/O performance by using the REST API, use one of the following methods:

- Use the Virtual Partition Manager function for dividing the cache to prevent a specific host from monopolizing use of too much cache capacity.
- Use the QoS (Quality of Service) function to restrict the I/O performance of hosts for each volume and thereby prevent the performance of one service from interfering with the performance of another service.
- Use the Server Priority Manager function to prioritize the I/O operations of hosts for which fast processing is required by restricting the I/O performance of lower-priority hosts.
- Assign specific MP blades to resources to distribute the workload of I/O operations.

Managing CLPRs

Use the Virtual Partition Manager function to divide the cache and allocate the resources that use the cache. By doing so, you can prevent a situation in which a specific host monopolizes use of too many cache memory areas and I/O performance deteriorates.

You can use the REST API to create or delete a CLPR, or assign resources.

For details about the CLPR function and notes on using CLPRs, see the manual for Virtual Partition Manager.

Performing QoS operations

Use the QoS function to restrict IOPS, the amount of transferred data, and other parameters for each volume. By doing so, you can ensure the appropriate I/O for each service, thereby maintaining the required performance and quality levels.

By using the REST API, you can set the upper and lower limits on IOPS and the amount of data transferred, as well as the amount of time to wait before issuing an alert. You can also get performance information about volumes for which QoS settings are configured. You can use the API for getting volume information to check the information that is set.

You can get information related to QoS groups by using REST API requests that include simple in the request line. For details how to get information related to QoS groups, see the descriptions about QoS groups.

For details and usage notes related to the QoS function, see the *Performance Guide*.

Using Server Priority Manager

To prevent performance degradation of high-priority hosts, you can use the Server Priority Manager function to restrict the number of times a lower-priority host can access a storage system and the amount of data a lower-priority host can transfer.

You can configure Server Priority Manager by specifying a port and the WWN of the HBA or by specifying a volume (LDEV) and the WWN or iSCSI name of the HBA. You cannot use both specification methods on the same storage system. If you are using the REST API, configure settings by specifying a volume and the WWN or iSCSI name of the HBA.

Use a product such as the Tuning Manager API to check the performance information of hosts for which Server Priority Manager information was set by specifying the volume and WWN or iSCSI name of the HBA in the REST API.



Note:

For storage systems for which the Server Priority Manager function is already being used from a product such as Storage Navigator, you cannot use the Server Priority Manager function from the REST API. To configure Server Priority Manager from the REST API, first delete all Server Priority Manager settings from products such as Storage Navigator.

Assigning MP blades

If you assign specific MP blades to each resource related to the input or output of data (resources such as LDEVs, external parity groups, and journals), those resources have exclusive use of the corresponding MP blades. In addition, if there are many write operations from hosts to a specific MP blade, you can distribute the I/O workload by assigning another MP blade to the resource that is placing a heavy load on the first MP blade.

You can use the REST API to change the MP blade assigned to an LDEV, an external parity group, or a journal. For details, see the descriptions of the API requests for changing the assignment of an MP blade in the following sections:

- For LDEVs: The section explaining the volume allocation
- For external parity groups: The section explaining the optimization of I/O performance
- For journals: The section explaining how to configure a remote copy environment

Getting information about CLPRs

Obtain a list of CLPRs. You can obtain information such as the cache capacity, cache usage rate, and resident cache capacity.

Execution permission

Storage Administrator (View Only)

Request line

```
GET base-URL/v1/objects/clprs
```

Request message**Object ID**

None.

Query parameters

None.

Body

None.

Response message**Body**

```
{
  "data": [
    {
      "clprId": 0,
      "clprName": "CLPR0",
      "cacheMemoryCapacity": 171776,
      "cacheMemoryUsedCapacity": 41055,
      "writePendingDataCapacity": 56,
      "sideFilesCapacity": 0,
      "cacheUsageRate": 24,
      "writePendingDataRate": 1,
      "sideFilesUsageRate": 0
    },
    {
      "clprId": 1,
      "clprName": "CLPR1",
      "cacheMemoryCapacity": 4096,
      "cacheMemoryUsedCapacity": 0,
      "writePendingDataCapacity": 0,
      "sideFilesCapacity": 0,
      "cacheUsageRate": 0,
      "writePendingDataRate": 0,
      "sideFilesUsageRate": 0
    },
    {
      "clprId": 2,
      "clprName": "CLPRDEV",
      "cacheMemoryCapacity": 12288,
      "cacheMemoryUsedCapacity": 0,
      "writePendingDataCapacity": 0,

```

```

    "sideFilesCapacity": 0,
    "cacheUsageRate": 0,
    "writePendingDataRate": 0,
    "sideFilesUsageRate": 0
  }
]
}

```

| Attribute | Type | Description |
|--------------------------|--------|---|
| clprId | int | CLPR ID |
| clprName | string | CLPR name |
| cacheMemoryCapacity | long | Cache size (MB) |
| cacheMemoryUsedCapacity | long | Used cache size (MB) |
| writePendingDataCapacity | long | Amount of data waiting to be written (MB) |
| sideFilesCapacity | long | Size of side files (MB) |
| cacheUsageRate | int | Cache usage rate (%) |
| writePendingDataRate | int | Rate of data waiting to be written (%) |
| sideFilesUsageRate | int | Side file usage rate (%) |

Status codes

For details on the status codes of the request for this operation, see the description of HTTP status codes.

Coding example

```

curl -v -H "Accept:application/json" -H "Content-Type:application/json" -H
"Authorization:Session d7b673af189048468c5af9bcf3b6bb6f" -X GET https://
192.0.2.100/ConfigurationManager/v1/objects/clprs

```

Getting information about a specific CLPR

Obtain information about a specific CLPR by specifying the CLPR ID. You can obtain information such as the cache capacity, cache usage rate, and resident cache capacity.

Execution permission

Storage Administrator (View Only)

Request line

```
GET base-URL/v1/objects/clprs/object-ID
```

Request message**Object ID**

Specify the value of `clprId` that was obtained by the processing to get information about CLPRs.

| Attribute | Type | Description |
|---------------------|------|--------------------|
| <code>clprId</code> | int | (Required) CLPR ID |

Query parameters

None.

Body

None.

Response message**Body**

```
{
  "clprId": 2,
  "clprName": "CLPRGRP",
  "cacheMemoryCapacity": 12288,
  "cacheMemoryUsedCapacity": 0,
  "writePendingDataCapacity": 0,
  "sideFilesCapacity": 0,
  "cacheUsageRate": 0,
  "writePendingDataRate": 0,
  "sideFilesUsageRate": 0
}
```

| Attribute | Type | Description |
|--------------------------------------|--------|----------------------|
| <code>clprId</code> | int | CLPR ID |
| <code>clprName</code> | string | CLPR name |
| <code>cacheMemoryCapacity</code> | long | Cache size (MB) |
| <code>cacheMemoryUsedCapacity</code> | long | Used cache size (MB) |

| Attribute | Type | Description |
|--------------------------|------|---|
| writePendingDataCapacity | long | Amount of data waiting to be written (MB) |
| sideFilesCapacity | long | Size of side files (MB) |
| cacheUsageRate | int | Cache usage rate (%) |
| writePendingDataRate | int | Rate of data waiting to be written (%) |
| sideFilesUsageRate | int | Side file usage rate (%) |

Status codes

For details on the status codes of the request for this operation, see the description of HTTP status codes.

Coding example

```
curl -v -H "Accept:application/json" -H "Content-Type:application/json" -H "Authorization:Session d7b673af189048468c5af9bcf3b6bb6f" -X GET https://192.0.2.100/ConfigurationManager/v1/objects/clprs/2
```

Creating a CLPR

Create a CLPR.



Note:

If you locked any resources of the target storage system by using the REST API, you will not be able to use this API function. In such cases, unlock the resources before running the API function.

Execution permission

Storage Administrator (System Resource Management)

Request line

```
POST base-URL/v1/objects/clprs
```

Request message

Object ID

None.

Query parameters

None.

Body

```
{
  "clprName" : "CLPRDEV",
  "cacheMemoryCapacity" : 12288
}
```

| Attribute | Type | Description |
|---------------------|--------|---|
| clprName | string | (Required) CLPR name Specify a name consisting of 1 to 16 characters. Specify a name that is unique among the CLPRs on the target storage system. |
| cacheMemoryCapacity | long | (Required) Total cache size of the CLPR (MB) For VSP 5000 series storage systems, specify a multiple of 4096. For other storage systems, specify a multiple of 2048. For details on the size that can be specified for the cache, see the Virtual Partition Manager manual. |

Response message**Body**

A job object is returned. For details on attributes other than `affectedResources`, see the description of job objects.

| Attribute | Description |
|-------------------|-------------------------|
| affectedResources | URL of the created CLPR |

Status codes

For details on the status codes of the request for this operation, see the description on HTTP status codes.

Coding example

```
curl -v -H "Accept:application/json" -H "Content-Type:application/json" -H
"Authorization:Session d7b673af189048468c5af9bcf3b6bb6f" -X POST --data-
binary @./InputParameters.json https://192.0.2.100/ConfigurationManager/v1/
objects/clprs
```

Changing the settings of a CLPR

Change the name, cache size, and other settings of a CLPR.

**Note:**

If you locked any resources of the target storage system by using the REST API, you will not be able to use this API function. In such cases, unlock the resources before running the API function.

Execution permission

Storage Administrator (System Resource Management)

Request line

```
PATCH base-URL/v1/objects/clprs/object-ID
```

Request message**Object ID**

Specify the value of `clprId` that was obtained by the processing to get information about CLPRs.

| Attribute | Type | Description |
|---------------------|------|--------------------|
| <code>clprId</code> | int | (Required) CLPR ID |

Query parameters

None.

Body

The following is a coding example for changing the name of a CLPR:

```
{
  "clprName" : "CLPRGRP"
}
```

The following is a coding example for changing the total cache size of a CLPR:

```
{
  "cacheMemoryCapacity" : 24576
}
```

The following is a coding example for changing the name and total cache size of a CLPR:

```
{
  "clprName" : "CLPRGRP",
  "cacheMemoryCapacity" : 24576
}
```

| Attribute | Type | Description |
|---------------------|--------|---|
| clprName | string | (Optional) CLPR name Specify a name consisting of 1 to 16 characters. Specify a name that is unique among the CLPRs on the target storage system. |
| cacheMemoryCapacity | long | (Optional) Total cache size of the CLPR (MB) For VSP 5000 series storage systems, specify a multiple of 4096. For other storage systems, specify a multiple of 2048. For details on the size that can be specified for the cache, see the Virtual Partition Manager manual. |

Response message

Body

A job object is returned. For details on attributes other than `affectedResources`, see the description of job objects.

| Attribute | Description |
|-------------------|---|
| affectedResources | URL of the CLPR whose settings were changed |

Action template

None.

Status codes

For details on the status codes of the request for this operation, see the description on HTTP status codes.

Coding example

```
curl -v -H "Accept:application/json" -H "Content-Type:application/json" -H
"Authorization:Session d7b673af189048468c5af9bcf3b66b6f" -X PATCH --data-
binary @./InputParameters.json https://192.0.2.100/ConfigurationManager/v1/
objects/clprs/2
```

Deleting a CLPR

Delete a CLPR. Before deleting a CLPR, move any resources that are currently allocated to the CLPR to be deleted to other CLPRs.

**Note:**

If you locked any resources of the target storage system by using the REST API, you will not be able to use this API function. In such cases, unlock the resources before running the API function.

Execution permission

Storage Administrator (System Resource Management)

Request line

```
DELETE base-URL/v1/objects/clprs/object-ID
```

Request message**Object ID**

Specify the value of `clprId` that was obtained by the processing to get information about CLPRs.

| Attribute | Type | Description |
|-----------|------|--------------------|
| clprId | int | (Required) CLPR ID |

Query parameters

None.

Body

None.

Response message**Body**

A job object is returned. For details on attributes other than `affectedResources`, see the description of job objects.

| Attribute | Description |
|--------------------------------|-------------------------|
| <code>affectedResources</code> | URL of the deleted CLPR |

Status codes

For details on the status codes of the request for this operation, see the description on HTTP status codes.

Coding example

```
curl -v -H "Accept:application/json" -H "Content-Type:application/json" -H
"Authorization:Session d7b673af189048468c5af9bcf3bbbb6f" -X DELETE --data-
binary @./InputParameters.json https://192.0.2.100/ConfigurationManager/v1/
objects/clprs/3
```

Assigning LDEVs to a CLPR

The following request assigns LDEVs to a CLPR. You can use this API function to assign LDEVs to a created CLPR or to move an already assigned LDEV to a different CLPR.

**Note:**

If you want to assign external volumes to a CLPR, see the description of how to assign external parity groups to a CLPR.

Execution permission

Storage Administrator (System Resource Management)

Request line

```
POST base-URL/v1/objects/ldevs/object-ID/actions/assign-clpr/invoke
```

Request message**Object ID**

Specify the value of `ldevId` that was obtained by the processing to get information about volumes.

| Attribute | Type | Description |
|---------------------|------|---|
| <code>ldevId</code> | int | (Required) Specify the LDEV number as a decimal (base 10) number. |

Query parameters

None.

Body

```
{
  "parameters": {
    "clprId": 2
  }
}
```

| Attribute | Type | Description |
|---------------------|------|---|
| <code>clprId</code> | int | (Required) CLPR ID of the CLPR to which the LDEV is to be assigned Specify a decimal (base 10) number in the range from 0 to 31. |

Response message**Body**

A job object is returned. For details on attributes other than `affectedResources`, see the description of job objects.

| Attribute | Description |
|--------------------------------|---|
| <code>affectedResources</code> | URL of the LDEV that was assigned to the CLPR |

Action template

```
GET base-URL/v1/objects/ldevs/object-ID/actions/assign-clpr
```

Status codes

For details on the status codes of the request for this operation, see the description on HTTP status codes.

Coding example

To get an action template:

```
curl -v -H "Accept:application/json" -H "Content-Type:application/json" -H
"Authorization:Session d7b673af189048468c5af9bcf3b6bb6f" -X GET https://
192.0.2.100/ConfigurationManager/v1/objects/ldevs/100/actions/assign-clpr
```

To run the request after getting an action template:

```
curl -v -H "Accept:application/json" -H "Content-Type:application/json" -H
"Authorization:Session d7b673af189048468c5af9bcf3b6bb6f" -X POST --data-
binary @./InputParameters.json https://192.0.2.100/ConfigurationManager/v1/
objects/ldevs/100/actions/assign-clpr/invoke
```

Assigning parity groups to a CLPR

The following request assigns parity groups to a CLPR. You can use this API function to assign parity groups to a created CLPR or to move an already assigned parity group to a different CLPR.

Execution permission

Storage Administrator (System Resource Management)

Request line

```
POST base-URL/v1/objects/parity-groups/object-ID/actions/assign-clpr/invoke
```

Request message**Object ID**

Specify the value of `parityGroupId` that was obtained by the processing to get information about parity groups.

| Attribute | Type | Description |
|-------------------|--------|---|
| parityGroupI d | string | (Required) Parity group number Specify concatenated parity groups in the same way. |

| Attribute | Type | Description |
|-----------|------|---|
| | | For 1-3-1, 1-3-2, and 1-3-3 concatenated parity groups, specify as follows: "parityGroupId": "1-3" |

Query parameters

None.

Body

```
{
  "parameters": {
    "clprId": 2
  }
}
```

| Attribute | Type | Description |
|-----------|------|---|
| clprId | int | (Required) CLPR ID of the CLPR to which the parity group is to be assigned Specify a decimal (base 10) number in the range from 0 to 31. |

Response message**Body**

A job object is returned. For details on attributes other than `affectedResources`, see the description of job objects.

| Attribute | Description |
|-------------------|---|
| affectedResources | URL of the parity group that was assigned to the CLPR |

Action template

```
GET base-URL/v1/objects/parity-groups/object-ID/actions/assign-clpr
```

Status codes

For details on the status codes of the request for this operation, see the description of HTTP status codes.

Coding example

To get an action template:

```
curl -v -H "Accept:application/json" -H "Content-Type:application/json" -H
"Authorization:Session d7b673af189048468c5af9bcf3bbbb6f" -X GET https://
192.0.2.100/ConfigurationManager/v1/objects/parity-groups/1-1/actions/
assign-clpr
```

To run the request after getting an action template:

```
curl -v -H "Accept:application/json" -H "Content-Type:application/json" -H
"Authorization:Session d7b673af189048468c5af9bcf3bbbb6f" -X POST --data-
binary @./InputParameters.json https://192.0.2.100/ConfigurationManager/v1/
objects/parity-groups/1-1/actions/assign-clpr/invoke
```

Getting information about external parity groups

The following request gets a list of information about external parity groups. You can get the information such as the number of LDEVs allocated to external parity groups and the usage rate of external parity groups.

Execution permission

Storage Administrator (View Only)

Request line

```
GET base-URL/v1/objects/external-parity-groups
```

Request message**Object ID**

None.

Query parameters

| Parameter | Type | Description |
|----------------|--------|---|
| detailInfoType | string | <p>(Optional) Type of detailed information to be obtained</p> <ul style="list-style-type: none"> class <p>Adds additional information from the storage system's cache. You can specify this item for VSP 5000 series.</p> <p>To get up-to-date information, you must run the API request that refreshes the storage system's cache before running this request. For details, see "Updating the cache of storage system configuration information".</p> |

Body

None.

Response message**Body**

```
{
  "data": [
    {
      "externalParityGroupId": "1-1",
      "numOfLdevs": 1,
      "usedCapacityRate": 100,
      "availableVolumeCapacity": 0,
      "emulationType": "OPEN-V",
      "clprId": 0,
      "externalProductId": "OPEN-V",
      "availableVolumeCapacityInKB": 0
    },
    {
      "externalParityGroupId": "1-2",
      "numOfLdevs": 0,
      "usedCapacityRate": 0,
      "availableVolumeCapacity": 40,
      "emulationType": "OPEN-V",
      "clprId": 0,
      "externalProductId": "OPEN-V",
      "availableVolumeCapacityInKB": 41943040
    }
  ]
}
```

| Attribute | Type | Description |
|-----------------------------|--------|---|
| externalParityGroupId | string | External parity group number |
| numOfLdevs | int | Number of LDEVs allocated to the external parity group |
| usedCapacityRate | int | Usage rate of the external parity group |
| availableVolumeCapacity | long | Available capacity (GB) The amount of free space is output. If the capacity is below 1 GB, the value is ignored and 0 is assumed. |
| availableVolumeCapacityInKB | long | Available capacity (KB) The amount of free space is output. |
| emulationType | string | Emulation type of the external parity group |
| clprId | int | Number of CLPR to which the external parity group belongs |
| externalProductId | string | Storage system that is connected using the external storage connection functionality of Universal Volume Manager |

If you run this request with `class` specified for `detailInfoType` in the query parameters, additional information from the storage system's cache is also obtained.

| Attribute | Type | Description |
|-------------------------------|------|--|
| largestAvailableCapacity | long | Maximum capacity of the non-volume areas in the external parity group (KB) The maximum capacity of the continuously free areas is output. |
| totalOpenVolumeCapacity | long | Total volume capacity of the open volumes in the external parity group (KB) |
| unallocatedOpenVolumeCapacity | long | From among the open volumes in the external parity group, the total capacity of volumes to which paths are not allocated (KB) |
| allocatedOpenVolumeCapacity | long | From among the open volumes in the external parity group, the total capacity of volumes to which paths are allocated (KB) |

| Attribute | Type | Description |
|-------------------------------|------|---|
| allocatableOpenVolumeCapacity | long | <p>From among the open volumes in the external parity group, the total capacity of volumes to which paths can be allocated (KB)</p> <p>The total capacity of volumes that meet all of the following conditions is output.</p> <ul style="list-style-type: none"> ▪ No path is allocated to the volume. ▪ The volume is not a pool volume. ▪ The volume is not a system disk. |
| reservedOpenVolumeCapacity | long | <p>From among the open volumes in the external parity group, the total capacity of volumes which are reserved (KB)</p> <p>The total capacity of volumes that meet all of the following conditions is output.</p> <ul style="list-style-type: none"> ▪ No path is allocated to the volume. ▪ The volume is either a pool volume or a system disk. |

Status codes

For details on the status codes of the request for this operation, see the description on HTTP status codes.

Coding example

```
curl -v -H "Accept:application/json" -H "Content-Type:application/json" -H
"Authorization:Session d7b673af189048468c5af9bcf3bbbb6f" -X GET https://
192.0.2.100/ConfigurationManager/v1/objects/external-parity-groups
```

Getting information about a specific external parity group

The following request gets information about a specific external parity group by specifying the external parity group number.

Execution permission

Storage Administrator (View Only)

Request line

```
GET base-URL/v1/objects/external-parity-groups/object-ID
```

Request message**Object ID**

Specify the value of `externalParityGroupId` that was obtained by the processing to get information about the external parity group.

| Attribute | Type | Description |
|------------------------------------|--------|---|
| <code>externalParityGroupId</code> | string | (Required) External parity group number |

Query parameters

None.

Body

None.

Response message**Body**

```
{
  "externalParityGroupId": "1-2",
  "numOfLdevs": 1,
  "usedCapacityRate": 100,
  "availableVolumeCapacity": 0,
  "emulationType": "OPEN-V",
  "clprId": 0,
  "externalProductId": "OPEN-V",
  "spaces": [
    {
      "partitionNumber": 0,
      "ldevId": 49153,
      "status": "NML",
      "lbaLocation": "0x000000000000",
      "lbaSize": "0x000001e00000"
    }
  ],
  "availableVolumeCapacityInKB": 0
}
```

| Attribute | Type | Description |
|------------------------------------|--------|--|
| <code>externalParityGroupId</code> | string | External parity group number |
| <code>numOfLdevs</code> | int | Number of LDEVs allocated to the external parity group |

| Attribute | Type | Description |
|-----------------------------|------------|--|
| usedCapacityRate | int | Usage rate of the external parity group |
| availableVolumeCapacity | long | Available capacity (GB) The amount of free space is output. If the capacity is below 1 GB, the value is ignored and 0 is assumed. |
| availableVolumeCapacityInKB | long | Available capacity (KB) The amount of free space is output. |
| emulationType | string | Emulation type of the external parity group |
| clprId | int | Number of CLPR to which the external parity group belongs |
| externalProductId | string | Storage system that is connected using the external storage connection functionality of Universal Volume Manager |
| spaces | objects[] | For the free space and the LDEV defined in the specified external parity group, the following attributes are output: <ul style="list-style-type: none"> ▪ partitionNumber (long) Number of a partition created as a result of partitioning of an external parity group ▪ ldevId (int) LDEV number ▪ status (string) LDEV status <ul style="list-style-type: none"> • NML: The LDEV is implemented, or the free space is determined. • REG: The LDEV is being created. • DEL: The LDEV is being deleted. ▪ lbaLocation (string) Starting location of the LBA of the partition in the external parity group (in a multiple of 512 bytes) ▪ lbaSize (string) Size of the partition in the external parity group (in a multiple of 512 bytes) |

Status codes

For details on the status codes of the request for this operation, see the description on HTTP status codes.

Coding example

```
curl -v -H "Accept:application/json" -H "Content-Type:application/json" -H
"Authorization:Session d7b673af189048468c5af9bcf3bbbb6f" -X GET https://
192.0.2.100/ConfigurationManager/v1/objects/external-parity-groups/1-1
```

Assigning external parity groups to a CLPR

The following request assigns external parity groups to a CLPR. You can use this API function to assign external parity groups to a created CLPR or to move an already assigned external parity group to a different CLPR.

Execution permission

Storage Administrator (System Resource Management)

Request line

```
POST base-URL/v1/objects/external-parity-groups/object-ID/actions/assign-
clpr/invoke
```

Request message**Object ID**

Specify the value of `externalParityGroupId` that was obtained by the processing to get information about external parity groups.

| Attribute | Type | Description |
|-----------------------|--------|---|
| externalParityGroupId | string | (Required) External parity group number |

Query parameters

None.

Body

```
{
  "parameters": {
    "clprId": 2
  }
}
```

```
}
}
```

| Attribute | Type | Description |
|-----------|------|--|
| clprId | int | (Required) CLPR ID of the CLPR to which the external parity group is to be assigned Specify a decimal (base 10) number in the range from 0 to 31. |

Response message

Body

A job object is returned. For details on attributes other than `affectedResources`, see the description of job objects.

| Attribute | Description |
|-------------------|--|
| affectedResources | URL of the external parity group that was assigned to the CLPR |

Action template

```
GET base-URL/v1/objects/external-parity-groups/object-ID/actions/assign-clpr
```

Status codes

For details on the status codes of the request for this operation, see the description of HTTP status codes.

Coding example

To get an action template:

```
curl -v -H "Accept:application/json" -H "Content-Type:application/json" -H
"Authorization:Session d7b673af189048468c5af9bcf3bbbb6f" -X GET https://
192.0.2.100/ConfigurationManager/v1/objects/external-parity-groups/1-1/
actions/assign-clpr
```

To run the request after getting an action template:

```
curl -v -H "Accept:application/json" -H "Content-Type:application/json" -H
"Authorization:Session d7b673af189048468c5af9bcf3bbbb6f" -X POST --data-
```

```
binary @./InputParameters.json https://192.0.2.100/ConfigurationManager/v1/objects/external-parity-groups/1-1/actions/assign-clpr/invoke
```

Changing the MP blade assigned to an external parity group

The following request changes the MP blade assigned to an external parity group.

Execution permission

Storage Administrator (System Resource Management)

Request line

```
POST base-URL/v1/objects/external-parity-groups/object-ID/actions/assign-mp-blade/invoke
```

Request message

Object ID

Specify the `externalParityGroupId` value obtained by getting information about the external parity group.

| Attribute | Type | Description |
|-----------------------|--------|---|
| externalParityGroupId | string | (Required) External parity group number |

Query parameters

None.

Body

```
{
  "parameters": {
    "mpBladeId": 1
  }
}
```

| Attribute | Type | Description |
|-----------|------|---|
| mpBladeId | int | (Required) The blade number of the MP blade to be assigned to the external parity group |

Response message**Body**

A job object is returned. For details about attributes other than `affectedResources`, see the description of job objects.

| Attribute | Description |
|--------------------------------|--|
| <code>affectedResources</code> | <p>URL of the external parity group for which the MP blade was changed</p> <p>To check changed setting values, execute the API request for getting information about the external path groups.</p> |

Action template

None.

Status codes

For details about the status codes of the request for this operation, see the description of the HTTP status codes.

Coding example

```
curl -v -H "Accept:application/json" -H "Content-Type:application/json" -H "Authorization:Session d7b673af189048468c5af9bcf3b66b6f" -X POST --data-binary @./InputParameters.json https://192.0.2.100/ConfigurationManager/v1/objects/external-parity-groups/3-1/actions/assign-mp-blade/invoke
```

Configuring QoS settings for a volume

The following request configures the QoS settings (such as the upper and lower limits on IOPS and on the amount of data that can be transferred, and the amount of time to wait before issuing related alerts) for a specified volume.

**Note:**

- You can use QoS to control I/O between a host and the volumes of a storage system. You can configure QoS settings for volumes that are directly connected to the host.
- This API request can be used when the storage system is VSP 5000 series, VSP G350, G370, G700, G900, VSP F350, F370, F700, F900.

Execution permission

Storage Administrator (System Resource Management)

Request line

```
POST base-URL/v1/objects/ldevs/object-ID/actions/set-qos/invoke
```

Request message**Object ID**

Specify the value of `ldevId` that was obtained by the processing to get information about volumes.

| Attribute | Type | Description |
|---------------------|------|---|
| <code>ldevId</code> | int | (Required) Specify the LDEV number as a decimal (base 10) number. |

Query parameters

None.

Body

```
{
  "parameters": {
    "upperIops": 100
  }
}
```

You can specify only one attribute each time you run this API request.

| Attribute | Type | Description |
|--------------------------------|------|---|
| <code>upperIops</code> | long | (Optional) Upper limit on the IOPS Specify a value in the range from 100 to 2147483647. If the <code>lowerIops</code> attribute is set, the value specified for this attribute must be greater than the value of the <code>lowerIops</code> attribute. To disable this setting, specify 0. If you disable both the <code>upperIops</code> attribute and the <code>upperTransferRate</code> attribute, the <code>upperAlertAllowableTime</code> attribute will also be disabled. |
| <code>upperTransferRate</code> | int | (Optional) Upper limit on the amount of data that can be transferred per second (in MB) |

| Attribute | Type | Description |
|-------------------------|------|---|
| | | <p>Specify a value in the range from 1 to 2097151. If the <code>lowerTransferRate</code> attribute is set, the value specified for this attribute must be greater than the value of the <code>lowerTransferRate</code> attribute.</p> <p>To disable this setting, specify 0. If you disable both the <code>upperIops</code> attribute and the <code>upperTransferRate</code> attribute, the <code>upperAlertAllowableTime</code> attribute will also be disabled.</p> |
| upperAlertAllowableTime | int | <p>(Optional) Amount of time to wait before issuing an alert when the IOPS or the amount of data transferred per second exceeds the upper limit for a continuous period of time (in seconds)</p> <p>Specify a value in the range from 1 to 600. You can specify this attribute only if one or both of the <code>upperIops</code> and <code>upperTransferRate</code> attributes are already set.</p> <p>To disable this setting, specify 0.</p> |
| lowerIops | long | <p>(Optional) Lower limit on the IOPS</p> <p>Specify a value in the range from 10 to 2147483647. If the <code>upperIops</code> attribute is set, the value specified for this attribute must be less than the value of the <code>upperIops</code> attribute.</p> <p>To disable this setting, specify 0. If you disable both the <code>lowerIops</code> attribute and the <code>lowerTransferRate</code> attribute, the <code>lowerAlertAllowableTime</code> attribute will also be disabled.</p> <p>You can specify this parameter if the storage system model is VSP G350, G370, G700, G900, VSP F350, F370, F700, F900.</p> |
| lowerTransferRate | int | <p>(Optional) Lower limit on the amount of data that can be transferred per second (in MB)</p> <p>Specify a value in the range from 1 to 2097151. If the <code>upperTransferRate</code> attribute is set, the value specified for this attribute must be less than the value of the <code>upperTransferRate</code> attribute.</p> |

| Attribute | Type | Description |
|----------------------------|------|---|
| | | <p>To disable this setting, specify 0. If you disable both the <code>lowerIops</code> attribute and the <code>lowerTransferRate</code> attribute, the <code>lowerAlertAllowableTime</code> attribute will also be disabled.</p> <p>You can specify this parameter if the storage system model is VSP G350, G370, G700, G900, VSP F350, F370, F700, F900.</p> |
| lowerAlertAllowableTime | int | <p>(Optional) Amount of time to wait before issuing an alert when the IOPS or the amount of data transferred per second falls below the lower limit for a continuous period of time (in seconds)</p> <p>Specify a value in the range from 1 to 600. You can specify this attribute only if one or both of the <code>lowerIops</code> and <code>lowerTransferRate</code> attributes are already set.</p> <p>To disable this setting, specify 0.</p> <p>You can specify this parameter if the storage system model is VSP G350, G370, G700, G900, VSP F350, F370, F700, F900.</p> |
| responsePriority | int | <p>(Optional) Priority level of the I/O processing</p> <p>Specify a value in the range from 1 to 3. A larger value indicates a higher level of priority. If you specify this attribute, a target response time will be set, based on the priority level you set.</p> <p>To disable this setting, specify 0. If you disable the <code>responsePriority</code> attribute, the <code>responseAlertAllowableTime</code> attribute will also be disabled.</p> <p>You can specify this parameter if the storage system model is VSP G350, G370, G700, G900, VSP F350, F370, F700, F900.</p> |
| responseAlertAllowableTime | int | <p>(Optional) Amount of time to wait before issuing an alert when the response time exceeds the target response time for a continuous period of time (in seconds)</p> <p>Specify a value in the range from 1 to 600.</p> |

| Attribute | Type | Description |
|-----------|------|--|
| | | To disable this setting, specify 0. You can specify this parameter if the storage system model is VSP G350, G370, G700, G900, VSP F350, F370, F700, F900. |

Response message**Body**

A job object is returned. For details on attributes other than `affectedResources`, see the description of job objects.

| Attribute | Description |
|--------------------------------|--|
| <code>affectedResources</code> | URL of the LDEV for which QoS settings were configured |

Action template

None.

Status codes

For details about the status codes of the request for this operation, see the description of the HTTP status codes.

Coding example

```
curl -v -H "Accept:application/json" -H "Content-Type:application/json" -H
"Authorization:Session d7b673af189048468c5af9bcf3b6bb6f" -X POST --data-
binary @./InputParameters.json https://192.0.2.100/ConfigurationManager/v1/
objects/ldevs/100/actions/set-qos/invoke
```

Getting performance information for a volume on which QoS has been set up

This request specifies the LDEV number of a volume on which QoS has been set up, and gets performance information about that volume. You can check the average performance of the volume over the last second. Use this request to check the performance of volumes during operations or when an alert is issued. You can concurrently run multiple instances of this request, but we recommend running no more than five instances at one time.

**Note:**

This API request can be used when the storage system is VSP 5000 series, VSP G350, G370, G700, G900, VSP F350, F370, F700, F900.

Execution permission

Storage Administrator (View Only)

Request line

```
GET base-URL/v1/objects/qos-monitor-ldevs/object-ID
```

Request message**Object ID**

Specify the `ldevId` value obtained by getting information about volumes.

| Attribute | Type | Description |
|-----------|------|---|
| ldevId | int | (Required) Specify the LDEV number with a decimal (base 10) number. |

Query parameters

None.

Body

None.

Response message**Body**

```
{
  "ldevId": 200,
  "receivedCommands": 3840,
  "transferRateOfReceivedCommands": 15000,
  "iops": 2650,
  "transferRate": 10000,
  "responseTime": 5,
  "monitorTime": "2020-01-01T23:59:59Z"
}
```

| Attribute | Type | Description |
|-----------|------|-------------|
| ldevId | int | LDEV number |

| Attribute | Type | Description |
|--------------------------------|---------------|--|
| receivedCommands | long | Number of commands received from hosts over the last second (IOPS) |
| transferRateOfReceivedCommands | long | Amount of transferred data received from hosts over the last second (KBps) |
| iops | long | Number of commands processed by the storage system over the last second (IOPS) |
| transferRate | long | Amount of transferred data processed by the storage system over the last one second (KBps) |
| responseTime | int | Average response time (μ s) |
| monitorTime | ISO8601string | Time at which the performance information was collected (UTC) This parameter is output if the storage system is VSP G350, G370, G700, G900, VSP F350, F370, F700, F900. |

Status codes

For details on the status codes of the request for this operation, see the section explaining HTTP status codes.

Coding example

```
curl -v -H "Accept:application/json" -H "Content-Type:application/json" -H
"Authorization:Session d7b673af189048468c5af9bcf3b66b6f" -X GET https://
192.0.2.100/ConfigurationManager/v1/objects/qos-monitor-ldevs/1
```

Managing QoS groups

When the storage system is VSP 5000 series, you can get information related to QoS groups by using REST API requests that include simple in the request line. For details how to get information related to QoS groups, see the descriptions on *Operations on QoS groups*.

Getting a list of Server Priority Manager information

The following request gets a list of Server Priority Manager information for which operations can be performed by using the REST API. You can check the Server Priority Manager

information of hosts for which the LDEV numbers of volumes and the WWNs or iSCSI names of the HBAs have been set.

Execution permission

Storage Administrator (View Only)

Request line

```
GET base-URL/v1/objects/io-control-ldev-wwns-iscsis
```

Request message

Object ID

None.

Query parameters

| Parameter | Type | Filter Condition |
|-----------|--------|--|
| ldevId | int | (Optional) Specify the LDEV number as a decimal (base 10) number. |
| hostWwn | string | (Optional) WWN of the HBA Specify a hexadecimal number consisting of 16 characters. |
| iscsiName | string | (Optional) iSCSI name of the HBA (iSCSI initiator) Specify the name in iqn format or eui format. <ul style="list-style-type: none"> ▪ iqn format Specify a value consisting of 5 to 223 characters. You can use the following characters: Alphanumeric characters, hyphens (-), periods (.), and colons (:) Specification example: <code>iqn.rest.example.of.iqn.form</code> ▪ eui format Specify eui. followed by a hexadecimal number. The specified value must consist of a total of 20 characters. Specification example: <code>eui.0900ABDC32598D26</code> |

Body

None.

Response message**Body**

```
{
  "data" : [ {
    "ioControlLdevWwnIscsiId" : "0,210003e08b0256f9",
    "ldevId" : 0,
    "hostWwn" : "210003e08b0256f9",
    "priority" : "NonPrioritize",
    "upperLimitForIops" : 9999
  }, {
    "ioControlLdevWwnIscsiId" : "1,210003e08b0256f9",
    "ldevId" : 1,
    "hostWwn" : "210003e08b0256f9",
    "priority" : "NonPrioritize",
    "upperLimitForIops" : 9999
  }, {
    "ioControlLdevWwnIscsiId" : "2,iqn.myrestapiiscsi20150907",
    "ldevId" : 2,
    "iscsiName" : "iqn.myrestapiiscsi20150907",
    "priority" : "NonPrioritize",
    "upperLimitForTransferRate" : 30
  }, {
    "ioControlLdevWwnIscsiId" : "3,iqn.myrestapiiscsi20150907",
    "ldevId" : 3,
    "iscsiName" : "iqn.myrestapiiscsi20150907",
    "priority" : "NonPrioritize",
    "upperLimitForTransferRate" : 30
  } ]
}
```

| Attribute | Type | Description |
|-------------------------|--------|---|
| ioControlLdevWwnIscsiId | string | Object ID of the SPM information |
| ldevId | int | LDEV number |
| hostWwn | string | WWN of the HBA |
| iscsiName | string | iSCSI name of the HBA (iSCSI initiator) |
| priority | string | Prioritized or not prioritized The value of the SPM setting is output. <ul style="list-style-type: none"> ▪ Prioritize: Prioritized ▪ NonPrioritize: Not prioritized |
| upperLimitForIops | int | Upper limit on IOPS |

| Attribute | Type | Description |
|---------------------------|------|---|
| upperLimitForTransferRate | int | Upper limit on the transfer rate (MBps) |

Status codes

For details on the status codes of the request for this operation, see the description of HTTP status codes.

Coding example

```
curl -v -H "Accept:application/json" -H "Content-Type:application/json" -H "Authorization:Session d7b673af189048468c5af9bcf3b66b6f" -X GET https://192.0.2.100/ConfigurationManager/v1/objects/io-control-ldev-wwns-iscsis/
```

Getting Server Priority Manager information by specifying a volume and the WWN or iSCSI name of an HBA

The following request allows you to get Server Priority Manager information by specifying the LDEV number of a volume and the WWN or iSCSI name of an HBA.

Execution permission

Storage Administrator (View Only)

Request line

```
GET base-URL/v1/objects/io-control-ldev-wwns-iscsis/object-ID
```

Request message

Object ID

Specify the value of `ioControlLdevWwnIscsiId` that was obtained by the processing to get the Server Priority Manager list. You can also specify the following attributes, delimited by commas:

For the WWN:

```
ldevId,hostWwn
```

For the iSCSI name:

```
ldevId,iscsiName
```

| Attribute | Type | Description |
|-----------|--------|---|
| ldevId | int | (Required) Specify the LDEV number as a decimal (base 10) number. |
| hostWwn | string | (Optional) WWN of the HBA Specify a hexadecimal number consisting of 16 characters. You must specify either the <code>hostWwn</code> attribute or the <code>iscsiName</code> attribute. |
| iscsiName | string | (Optional) iSCSI name of the iSCSI initiator Specify the name in iqn format or eui format. <ul style="list-style-type: none">iqn format Specify a value consisting of 5 to 223 characters. You can use the following characters: Alphanumeric characters, hyphens (-), periods (.), and colons (:) Specification example: <code>iqn.rest.example.of.iqn.form</code>eui format Specify eui. followed by a hexadecimal number. The specified value must consist of a total of 20 characters. Specification example: <code>eui.0900ABDC32598D26</code> You must specify either the <code>hostWwn</code> attribute or the <code>iscsiName</code> attribute. |

Query parameters

None.

Body

None.

Response message

Body

```
{
  "ioControlLdevWwnIscsiId" : "0,210003e08b0256f9",
  "ldevId" : 0,
  "hostWwn" : "210003e08b0256f9",
  "priority" : "NonPrioritize",
```

```
"upperLimitForTransferRate" : 30  
}
```

| Attribute | Type | Description |
|---------------------------|--------|--|
| ioControlLdevWwnIscsId | string | Object ID of the SPM information |
| ldevId | int | LDEV number |
| hostWwn | string | WWN of the HBA |
| iscsiName | string | iSCSI name of the HBA (iSCSI initiator) |
| priority | string | Prioritized or not prioritized The value of the SPM setting is output. <ul style="list-style-type: none">▪ <code>Prioritize</code>: Prioritized▪ <code>NonPrioritize</code>: Not prioritized |
| upperLimitForIops | int | Upper limit on IOPS |
| upperLimitForTransferRate | int | Upper limit on the transfer rate (MBps) |

Status codes

For details on the status codes of the request for this operation, see the description of HTTP status codes.

Coding example

```
curl -v -H "Accept:application/json" -H "Content-Type:application/json" -H  
"Authorization:Session d7b673af189048468c5af9bcf3b6bb6f" -X GET https://  
192.0.2.100/ConfigurationManager/v1/objects/io-control-ldev-wwns-iscsis/0,  
210003e08b0256f9
```

Setting Server Priority Manager information by specifying a volume and the WWN or iSCSI name of the HBA

The following request sets, in Server Priority Manager, the upper limit on the transfer rate or IOPS of a low-priority host by specifying the LDEV number of the volume and the WWN or iSCSI name of the HBA.



Note:

If the number of volumes for which Server Priority Manager has been configured exceeds 4,096, the hosts of volumes configured after the 4,096th volume will have lower I/O response be lower than the hosts of the first 4,096 volumes to be configured.

Make sure the number of volumes for which Server Priority Manager has been configured does not exceed 4,096.

Execution permission

Storage Administrator (System Resource Management)

Request line

```
POST base-URL/v1/objects/io-control-ldev-wwns-iscsis
```

Request message

Object ID

None.

Query parameters

None.

Body

The following coding example sets the upper limit on IOPS:

```
{
  "ldevId" : 0,
  "hostWwn" : "210003e08b0256f9",
  "upperLimitForIops" : 9999
}
```

The following coding example sets the upper limit on the transfer rate:

```
{
  "ldevId" : 0,
  "iscsiName" : "iqn.myrestapiiscsi20150907",
  "upperLimitForTransferRate" : 30
}
```

| Attribute | Type | Description |
|-----------|--------|---|
| ldevId | int | (Required) Specify the LDEV number as a decimal (base 10) number. |
| hostWwn | string | (Optional) WWN of the HBA |

| Attribute | Type | Description |
|---------------------------|--------|---|
| | | <p>Specify a hexadecimal number consisting of 16 characters.</p> <p>You must specify either the <code>hostWwn</code> attribute or the <code>iscsiName</code> attribute.</p> |
| iscsiName | string | <p>(Optional) iSCSI name of the HBA (iSCSI initiator)</p> <p>Specify the name in iqn format or eui format.</p> <ul style="list-style-type: none"> ▪ iqn format <p>Specify a value consisting of 5 to 223 characters. You can use the following characters:</p> <p>Alphanumeric characters, hyphens (-), periods (.), and colons (:)</p> <p>Specification example: iqn.rest.example.of.iqn.form</p> ▪ eui format <p>Specify eui. followed by a hexadecimal number. The specified value must consist of a total of 20 characters.</p> <p>Specification example: eui.0900ABDC32598D26</p> <p>You must specify either the <code>hostWwn</code> attribute or the <code>iscsiName</code> attribute.</p> |
| upperLimitForIops | int | <p>(Optional) Upper limit on the IOPS (IOPS)</p> <p>Specify a value in the range from 1 to 65535.</p> <p>You must specify either the <code>upperLimitForIops</code> attribute or the <code>upperLimitForTransferRate</code> attribute.</p> |
| upperLimitForTransferRate | int | <p>(Optional) Upper limit on the transfer rate (MBps)</p> <p>Specify a value in the range from 1 to 31.</p> <p>You must specify either the <code>upperLimitForIops</code> attribute or the <code>upperLimitForTransferRate</code> attribute.</p> |

Response message**Body**

A job object is returned. For details on attributes other than `affectedResources`, see the description of job objects.

| Attribute | Description |
|--------------------------------|--------------------------------------|
| <code>affectedResources</code> | URL of the specified SPM information |

Status codes

For details on the status codes of the request for this operation, see the description of HTTP status codes.

Coding example

```
curl -v -H "Accept:application/json" -H "Content-Type:application/json" -H
"Authorization:Session d7b673af189048468c5af9bcf3bbbb6f" -X POST --data-
binary @./InputParameters.json https://192.0.2.100/ConfigurationManager/v1/
objects/io-control-ldev-wwns-iscsis/
```

Changing the Server Priority Manager information

The following request changes the upper limit on the transfer rate or IOPS for hosts for which the LDEV number of a volume and the WWN or iSCSI name of the HBA are already specified in Server Priority Manager.

Execution permission

Storage Administrator (System Resource Management)

Request line

```
PATCH base-URL/v1/objects/io-control-ldev-wwns-iscsis/object-ID
```

Request message**Object ID**

Specify the value of `ioControlLdevWwnIscsiId` that was obtained by the processing to get the Server Priority Manager list. You can also specify the following attributes, delimited by commas:

For the WWN:

```
ldevId,hostWwn
```

For the iSCSI name:

```
ldevId,iscsiName
```

| Attribute | Type | Description |
|-----------|--------|--|
| ldevId | int | (Required) Specify the LDEV number as a decimal (base 10) number. |
| hostWwn | string | (Optional) WWN of the HBA Specify a hexadecimal number consisting of 16 characters. You must specify either the <code>hostWwn</code> attribute or the <code>iscsiName</code> attribute. |
| iscsiName | string | (Optional) iSCSI name of the iSCSI initiator Specify the name in iqn format or eui format. <ul style="list-style-type: none"> ▪ iqn format Specify a value consisting of 5 to 223 characters. You can use the following characters: Alphanumeric characters, hyphens (-), periods (.), and colons (:) Specification example: <code>iqn.rest.example.of.iqn.form</code> ▪ eui format Specify eui. followed by a hexadecimal number. The specified value must consist of a total of 20 characters. Specification example: <code>eui.0900ABDC32598D26</code> You must specify either the <code>hostWwn</code> attribute or the <code>iscsiName</code> attribute. |

Query parameters

None.

Body

The following coding example changes the upper limit on IOPS:

```
{
  "upperLimitForIops" : 9999
}
```

The following coding example changes the upper limit on the transfer rate:

```
{
  "upperLimitForTransferRate": 30
}
```

| Attribute | Type | Description |
|---------------------------|------|---|
| upperLimitForIops | int | (Optional) Upper limit (IOPS) Specify a value in the range from 1 to 65535. You must specify either the <code>upperLimitForIops</code> attribute or the <code>upperLimitForTransferRate</code> attribute. |
| upperLimitForTransferRate | int | (Optional) Upper limit (transfer rate in MBps) Specify a value in the range from 1 to 31. You must specify either the <code>upperLimitForIops</code> attribute or the <code>upperLimitForTransferRate</code> attribute. |

Response message

Body

A job object is returned. For details on attributes other than `affectedResources`, see the description of job objects.

| Attribute | Description |
|--------------------------------|------------------------------------|
| <code>affectedResources</code> | URL of the changed SPM information |

Action template

None.

Status codes

For details on the status codes of the request for this operation, see the description of HTTP status codes.

Coding example

```
curl -v -H "Accept:application/json" -H "Content-Type:application/json" -H "Authorization:Session d7b673af189048468c5af9bcf3b66b6f" -X PATCH --data-
```

```
binary @./InputParameters.json https://192.0.2.100/ConfigurationManager/v1/objects/io-control-ldev-wwns-iscsis/0,210003e08b0256f9
```

Deleting Server Priority Manager information

The following request allows you to remove the currently set upper limit on the transfer rate or IOPS of a host by specifying the LDEV number of a volume and the WWN or iSCSI name of the HBA, to remove the host from the management targets of Server Priority Manager.

Execution permission

Storage Administrator (System Resource Management)

Request line

```
DELETE base-URL/v1/objects/io-control-ldev-wwns-iscsis/object-ID
```

Request message

Object ID

Specify the value of `ioControlLdevWwnIscsiId` that was obtained by the processing to get the Server Priority Manager list. You can also specify the following attributes, delimited by commas:

For the WWN:

```
ldevId,hostWwn
```

For the iSCSI name:

```
ldevId,iscsiName
```

| Attribute | Type | Description |
|------------------------|--------|---|
| <code>ldevId</code> | int | (Required) Specify the LDEV number as a decimal (base 10) number. |
| <code>hostWwn</code> | string | (Optional) WWN of the HBA Specify a hexadecimal number consisting of 16 characters. You must specify either the <code>hostWwn</code> attribute or the <code>iscsiName</code> attribute. |
| <code>iscsiName</code> | string | (Optional) iSCSI name of the HBA (iSCSI initiator) |

| Attribute | Type | Description |
|-----------|------|--|
| | | <p>Specify the name in iqn format or eui format.</p> <ul style="list-style-type: none"> iqn format <p>Specify a value consisting of 5 to 223 characters. You can use the following characters:</p> <p>Alphanumeric characters, hyphens (-), periods (.), and colons (:)</p> <p>Specification example: iqn.rest.example.of.iqn.form</p> <ul style="list-style-type: none"> eui format <p>Specify eui. followed by a hexadecimal number. The specified value must consist of a total of 20 characters.</p> <p>Specification example: eui.0900ABDC32598D26</p> <p>You must specify either the <code>hostWwn</code> attribute or the <code>iscsiName</code> attribute.</p> |

Query parameters

None.

Body

None.

Response message**Body**

A job object is returned. For details on attributes other than `affectedResources`, see the description of job objects.

| Attribute | Description |
|--------------------------------|------------------------------------|
| <code>affectedResources</code> | URL of the deleted SPM information |

Status codes

For details on the status codes of the request for this operation, see the description of HTTP status codes.

Coding example

```
curl -v -H "Accept:application/json" -H "Content-Type:application/json" -H
"Authorization:Session d7b673af189048468c5af9bcf3bbbb6f" -X DELETE
```

```
https://192.0.2.100/ConfigurationManager/v1/objects/io-control-ldev-wwns-iscsis/0,210003e08b0256f9
```

Chapter 8: Managing ShadowImage pairs

This chapter describes how to perform operations on ShadowImage pairs by using the REST API.

Overview of ShadowImage

ShadowImage creates a copy of a data volume in the same storage system as the copy source.

You can create a ShadowImage pair or manage the pair status by issuing an API from a REST API client. You can also operate ShadowImage pairs in units of copy groups. In addition, if you define a consistency group, the pair statuses of all pairs in the group are transited at the same time.

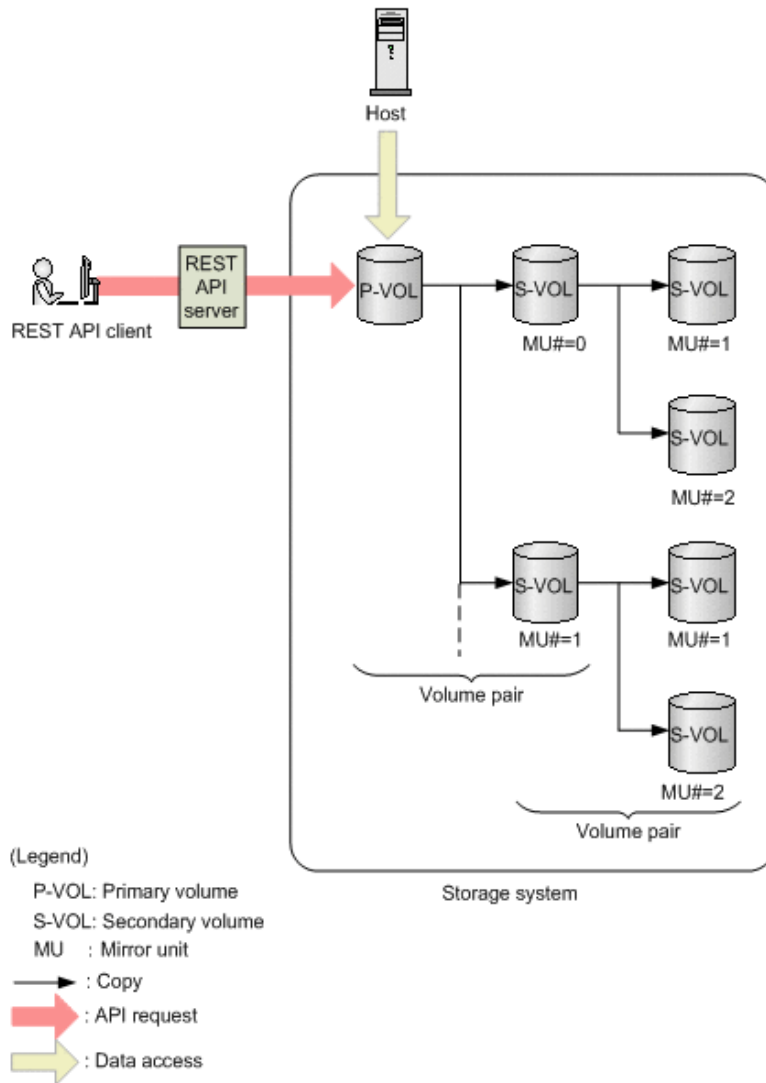

A ShadowImage pair consists of a primary volume (P-VOL) and a secondary volume (S-VOL). The primary volume can be paired with more than one secondary volume. Each secondary volume is managed according to the MU (mirror unit) number.

For details about ShadowImage, see the *Hitachi ShadowImage® User Guide*.

Workflow for operating ShadowImage pairs

The following shows the ShadowImage functions that can be run by the REST API:

- Getting information about copy groups

Obtains a list of copy groups registered in the target storage system. You can also obtain information about a specific copy group.

- Getting pair status and configuration information

Obtains a ShadowImage pair status and configuration information. You can check if a pair operation is complete. You can also obtain pair information in units of copy groups.

If the copy group in which the target ShadowImage pair is registered contains a ShadowImage pair that was created or deleted by using another REST API server or software other than the REST API, correct information about that pair might not be obtained. In such a case, update the information about the pairs to the most recent information before you obtain information.

- Creating a pair

Creates a new ShadowImage pair in a copy group of the target storage system. A copy group is a group made up of copy pairs. Each copy group consists of a device group made up of primary volumes, and a device group made up of secondary volumes. If the copy group is not already created, the copy group and its corresponding device groups are automatically created. You will be able to perform operations in units of copy groups by registering ShadowImage pairs in a copy group.

To create a pair in a new copy group:

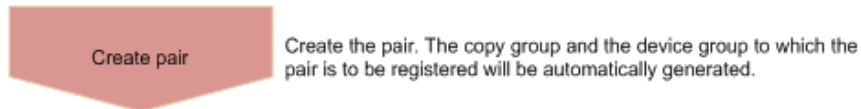

To create a pair in an existing copy group:

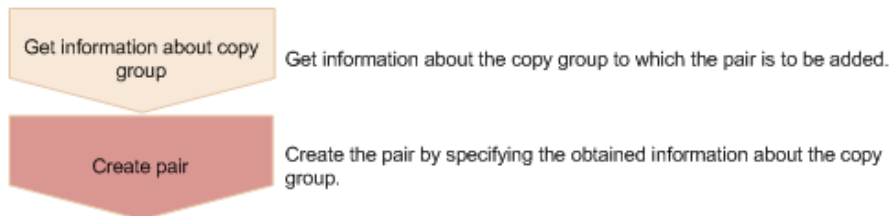

- Splitting a pair

Splits a ShadowImage pair and enables read and write access for a secondary volume. You can also split pairs in units of copy groups.

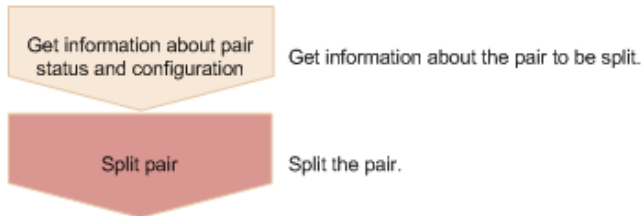

- Resynchronizing a pair

Resynchronizes a split ShadowImage pair based on the primary volume. Even during resynchronization, you can access the P-VOL. You can also resynchronize pairs in units of copy groups.

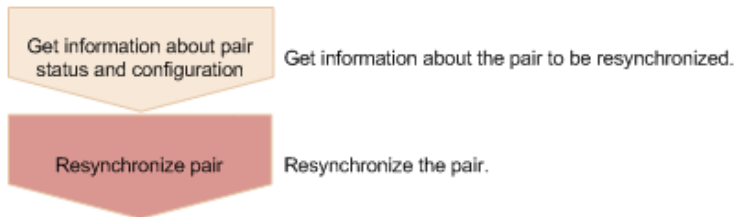

- Resynchronizing a pair by a restore

Resynchronizes a split ShadowImage pair based on a secondary volume. During resynchronization by a restore, you cannot access the P-VOL. You can also perform a restore in units of copy groups.

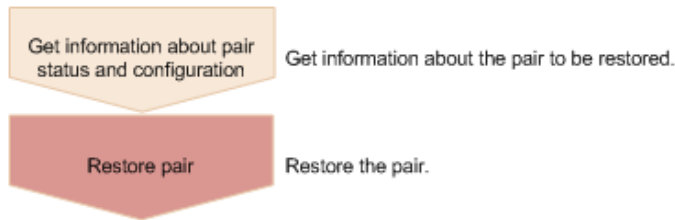

- Deleting a pair

Deletes a ShadowImage pair that is unnecessary. If you delete a pair, the pair is dissolved. The data in the primary volume and secondary volume remains unchanged. In addition, if you delete all the ShadowImage pairs in a copy group, the copy group and the device group included in the copy group are automatically deleted. You can also delete pairs in units of copy groups.

You can delete a pair at any time regardless of the pair status. However, if you delete a pair while the pair status is being changed, the pair might be deleted before its status is changed, and the request to change the pair status might time out.

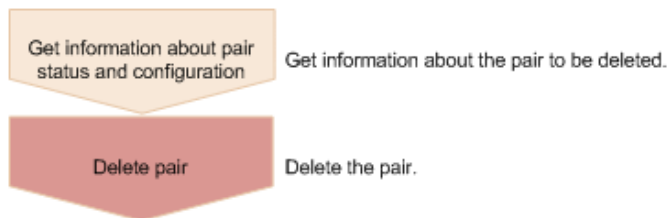



Specifying Job-Mode-Wait-Configuration-Change in the request header

During the creation, splitting, and resynchronizing of pairs, if multiple asynchronous processing requests are issued at the same time, jobs might get stuck and the job status might not change to `Completed` because data copying takes a long time. In such cases, specify `Job-Mode-Wait-Configuration-Change:NoWait` in the request header so that the job status changes to `Completed` without waiting for data copying to finish, and the next job starts. At this time, data copying continues even after job execution ends. To check whether data copying has finished, check the pair status of the target resource instead of the job status. For details about the pair status, see the description of the pair status transitions.

Pair status (ShadowImage)

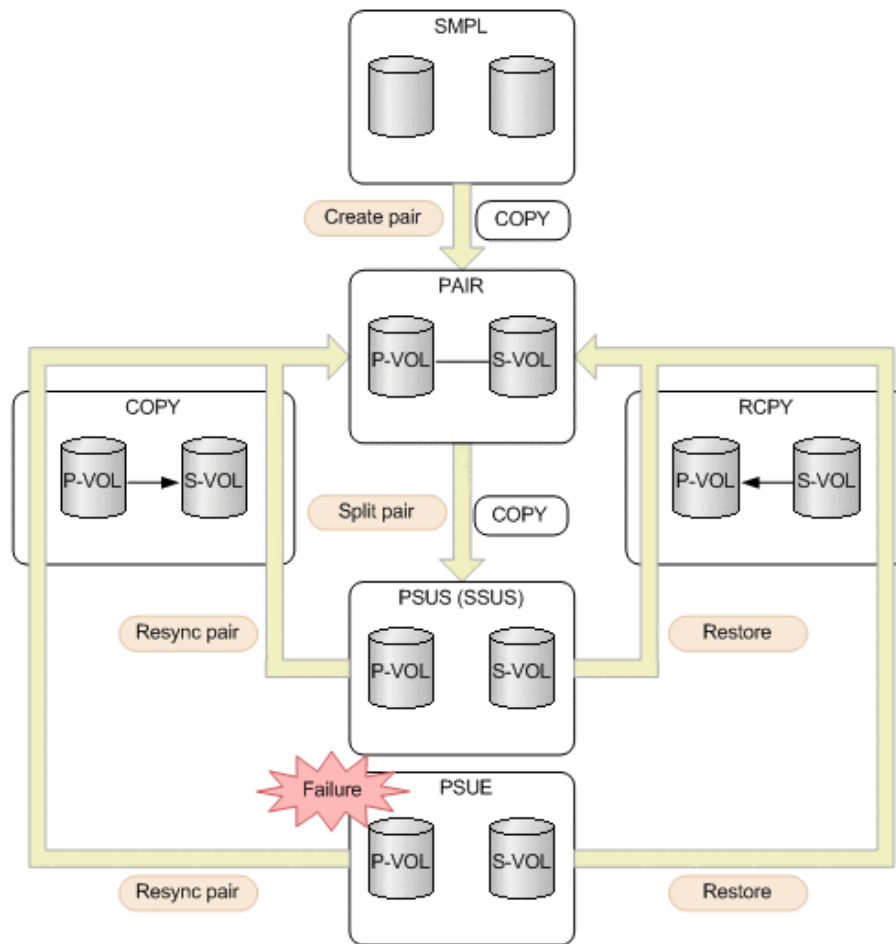
The following explains the operations and status transitions for pairs.



(Legend)
P-VOL: Primary volume
S-VOL: Secondary volume
 : Indicates a pair operation performed from the REST API
 : Indicates the pair status

| Pair status | Description | Access to the P-VOL | Access to the S-VOL |
|-------------|--|---------------------|---------------------|
| SMPL | Unpaired volumes | - | - |
| COPY | The pair is being created. An initial copy or resynchronization is being performed. | R/W enabled | R enabled |
| PAIR | Paired volumes The initial copy is complete. The update data of the P-VOL will be asynchronously copied to the S-VOL. | R/W enabled | R enabled |

| Pair status | Description | Access to the P-VOL | Access to the S-VOL |
|-------------|--|---------------------|---------------------|
| PSUS | The pair is being split by operation. (This value is output for the P-VOL.) | R/W enabled | R/W enabled |
| SSUS | The pair is being split by operation. (This value is output for the S-VOL when the P-VOL is PSUS.) | R/W enabled | R/W enabled |
| PSUE | The pairing is suspended due to a failure. The P-VOL and the S-VOL are not synchronized. | R/W enabled | R enabled |
| RCPY | A restore operation is being performed. (Data is being copied from the S-VOL to the P-VOL.) | Not enabled | R enabled |

If you delete a pair, the pair status changes to SMPL.



Note:

In the following cases, if you perform an operation on a pair, the request successfully returns a response, but the details specified in the request body are not actually applied:

- When you perform a pair splitting operation on a pair for which the status is PSUS or SSUS
- When you perform a pair resynchronization operation on a pair for which the status is COPY, PAIR, or RCPY

Getting a list of copy groups

The following request gets information about the copy groups containing ShadowImage pairs in the storage system.



Important:

If the copy group name or device group name contains spaces, the copy group information cannot be obtained.

Execution permission

Storage Administrator (View Only)

Request line

```
GET base-URL/v1/objects/local-clone-copygroups
```

Request message**Object ID**

None.

Query parameters

| Parameter | Type | Description |
|----------------|--------|--|
| detailInfoType | string | <p>(Optional) Type of detailed information to be obtained</p> <ul style="list-style-type: none"> pair <p>Specify this parameter to get detailed information about the pairs in each copy group in addition to a list of copy groups.</p> <p>You can specify this item for VSP 5000 series.</p> <p>To get up-to-date information, you must run the API request that refreshes the storage system's cache before running this request. For details, see "Updating the cache of storage system configuration information".</p> |

Body

None.

Response message**Body**

```
{
  "data": [
    {
      "copyGroupName": "localCopyGroup1",
      "pvolDeviceGroupName": "localCopyGroup1P_",
      "svolDeviceGroupName": "localCopyGroup1S_",
      "localCloneCopygroupId": "localCopyGroup1,localCopyGroup1P_,
localCopyGroup1S_"
    },
    {
      "copyGroupName": "localCopyGroup2",
      "pvolDeviceGroupName": "localCopyGroupppvol",
      "svolDeviceGroupName": "localCopyGroupsvol",
      "localCloneCopygroupId": "localCopyGroup2,localCopyGroupppvol,
localCopyGroupsvol"
    }
  ]
}
```

```
]
}
```

| Attribute | Type | Description |
|-----------------------|--------|---|
| copyGroupName | string | Copy group name |
| pvolDeviceGroupName | string | Device group name for the P-VOL |
| svolDeviceGroupName | string | Device group name for the S-VOL |
| localCloneCopygroupId | string | Object ID of the copy group that contains a ShadowImage pair The following attributes are output, separated by commas: <ul style="list-style-type: none"> ▪ copyGroupName ▪ pvolDeviceGroupName ▪ svolDeviceGroupName |

If you run the request with `pair` specified for the query parameter `detailInfoType`, you can get the following information, in addition to a list of copy groups:

| Attribute | Type | Description |
|-----------|----------|---|
| copyPairs | object[] | The following attributes about the ShadowImage pairs included in the copy group: If information cannot be acquired, the attributes under the <code>copyPairs</code> object are not output. <ul style="list-style-type: none"> ▪ copyGroupName (string) Copy group name ▪ copyPairName (string) Copy pair name ▪ replicationType (string) Pair type Outputs <code>SI</code> (ShadowImage). |

| Attribute | Type | Description |
|-----------|------|--|
| | | <ul style="list-style-type: none"> <li data-bbox="813 254 1424 386">▪ copyMode (string)# Copy mode Outputs NotSnapshot. <li data-bbox="813 422 1424 499">▪ pvolDevId (int) LDEV number of the P-VOL <li data-bbox="813 535 1424 613">▪ svolDevId (int) LDEV number of the S-VOL <li data-bbox="813 648 1424 726">▪ pvolMuNumber (int) MU number of the P-VOL <li data-bbox="813 762 1424 1056">▪ pvolStatus (string)# Pair volume status of the P-VOL For details, see the section describing the pair status (ShadowImage). This attribute is not output if no information can be obtained or if the status of the ShadowImage pair in transition is <i>Deleting</i>. <li data-bbox="813 1092 1424 1386">▪ svolStatus (string)# Pair volume status of the S-VOL For details, see the section describing the pair status (ShadowImage). This attribute is not output if no information can be obtained or if the status of the ShadowImage pair in transition is <i>Deleting</i>. <li data-bbox="813 1421 1424 1583">▪ consistencyGroupId (int) Consistency group ID This attribute is not output if no consistency group consists. |

| Attribute | Type | Description |
|-----------|------|---|
| | | <ul style="list-style-type: none"> ▪ <code>localCloneCopypairId</code> (string) Object ID of the ShadowImage pair The following attributes are output, separated by commas: <ul style="list-style-type: none"> ▪ <code>copyGroupName</code> ▪ <code>pvolDeviceGroupName</code> ▪ <code>svolDeviceGroupName</code> ▪ <code>copyPairName</code> ▪ <code>transitionStatus</code> (string) The status of the ShadowImage pair in transition <ul style="list-style-type: none"> • <code>None</code>: The pair is not in transition • <code>Deleting</code>: The pair is being deleted |

#: Immediately after the ShadowImage pair is created, pair information might be output as follows:

- The `copyMode` attribute is `NotSynchronized`.
- The `pvolStatus` attribute is `SMPL`.
- The `svolStatus` attribute is `SMPL`.

If this occurs, either run the API again after execution of the API for updating the cache of the storage system configuration information is complete, or run the API for getting information about specific copy groups to get correct information.

Status codes

For details on the status codes of the request for this operation, see the section explaining HTTP status codes.

Coding example

```
curl -v -H "Accept: application/json" -H "Authorization:Session
d7b673af189048468c5af9bcf3bbbb6f" -X GET https://192.0.2.100/
ConfigurationManager/v1/objects/local-clone-copygroups
```

Getting information about a specific copy group

The following request gets information about the specified copy group. This request also gets information about ShadowImage pairs included in the copy group. The request can be used to check the pair status or get configuration information about the pairs.



Important:

- If the target copy group contains a ShadowImage pair that was created or deleted by using another REST API server or software other than the REST API, correct information about that pair might not be obtained. To obtain the most recent information about such pairs, use the API for obtaining a list of ShadowImage pairs.
- If the copy group name, device group name, or copy pair name contains spaces, the information cannot be obtained.

Execution permission

Storage Administrator (View Only)

Request line

```
GET base-URL/v1/objects/local-clone-copygroups/object-ID
```

Request message

Object ID

Specify the `localCloneCopygroupId` value obtained by getting the list of copy groups. You can also specify the following attributes and connect them with commas:

```
copyGroupName, pvolDeviceGroupName, svolDeviceGroupName
```

| Attribute | Type | Description |
|---------------------|--------|--|
| copyGroupName | string | (Required) Specify the copy group name. Value should not exceed 31 characters. The name is case sensitive. |
| pvolDeviceGroupName | string | (Required) Specifies the device group name for the P-VOL. Value should not exceed 31 characters. The name is case sensitive. |
| svolDeviceGroupName | string | (Required) Specifies the device group name for the S-VOL. Value should not exceed 31 characters. The name is case sensitive. |

Query parameters

None.

Body

None.

Response message**Body**

```

{
  "localCloneCopygroupId" : "localCopyGroup1,localCopyGroup1P_,
localCopyGroup1S_",
  "copyGroupName" : "localCopyGroup1",
  "pvolDeviceGroupName" : "localCopyGroup1P_",
  "svolDeviceGroupName" : "localCopyGroup1S_",
  "copyPairs" : [ {
    "localCloneCopypairId" : "localCopyGroup1,localCopyGroup1P_,
localCopyGroup1S_,pair1",
    "copyGroupName" : "localCopyGroup1",
    "copyPairName" : "pair1",
    "replicationType" : "SI",
    "copyMode" : "NotSnapshot",
    "copyProgressRate" : 100,
    "pvolLdevId" : 10,
    "pvolStatus" : "PAIR",
    "svolLdevId" : 20,
    "svolStatus" : "PAIR",
    "pvolMuNumber" : 0,
    "pvolProcessingStatus": "N",
    "svolProcessingStatus": "N"
  }, {
    "localCloneCopypairId" : "localCopyGroup1,localCopyGroup1P_,
localCopyGroup1S_,pair2",
    "copyGroupName" : "localCopyGroup1",
    "copyPairName" : "pair2",
    "replicationType" : "SI",
    "copyMode" : "NotSnapshot",
    "copyProgressRate" : 100,
    "pvolLdevId" : 30,
    "pvolStatus" : "PAIR",
    "svolLdevId" : 40,
    "svolStatus" : "PAIR",
    "pvolMuNumber" : 0,
    "pvolProcessingStatus": "N",
    "svolProcessingStatus": "N"
  } ]
}

```

| Attribute | Type | Description |
|-----------------------|----------|---|
| copyGroupName | string | Copy group name |
| pvolDeviceGroupName | string | Device group name for the P-VOL |
| svolDeviceGroupName | string | Device group name for the S-VOL |
| localCloneCopygroupId | string | Object ID of the copy group that contains a ShadowImage pair The following attributes are output, separated by commas: <ul style="list-style-type: none"> ▪ copyGroupName ▪ pvolDeviceGroupName ▪ svolDeviceGroupName |
| copyPairs | object[] | The following attributes about the ShadowImage pairs included in the copy group: <ul style="list-style-type: none"> ▪ copyGroupName (string) Copy group name ▪ copyPairName (string) Copy pair name ▪ replicationType (string) Pair type Outputs <code>SI</code> (ShadowImage). ▪ copyMode (string) Copy mode Outputs <code>NotSnapshot</code>. ▪ copyProgressRate (int) Copy progress rate (%) This attribute is not output if no information can be obtained. ▪ pvolLdevId (int) LDEV number of the P-VOL |

| Attribute | Type | Description |
|-----------|------|--|
| | | <ul style="list-style-type: none"> <li data-bbox="813 254 1409 331">▪ <code>svolDevId</code> (int) LDEV number of the S-VOL <li data-bbox="813 369 1409 447">▪ <code>pvolMuNumber</code> (int) MU number of the P-VOL <li data-bbox="813 485 1409 737">▪ <code>pvolStatus</code> (string) Pair volume status of the P-VOL For details, see the section describing the pair status (ShadowImage). This attribute is not output if no information can be obtained. <li data-bbox="813 774 1409 1026">▪ <code>svolStatus</code> (string) Pair volume status of the S-VOL For details, see the section describing the pair status (ShadowImage). This attribute is not output if no information can be obtained. <li data-bbox="813 1064 1409 1226">▪ <code>consistencyGroupId</code> (int) Consistency group ID This attribute is not output if no consistency group consists. <li data-bbox="813 1264 1409 1625">▪ <code>localCloneCopypairId</code> (string) Object ID of the ShadowImage pair The following attributes are output, separated by commas: <ul style="list-style-type: none"> <li data-bbox="850 1446 1097 1474">▪ <code>copyGroupName</code> <li data-bbox="850 1497 1192 1524">▪ <code>pvolDeviceGroupName</code> <li data-bbox="850 1547 1192 1575">▪ <code>svolDeviceGroupName</code> <li data-bbox="850 1598 1081 1625">▪ <code>copyPairName</code> |

| Attribute | Type | Description |
|-----------|------|--|
| | | <ul style="list-style-type: none"> ▪ pvolProcessingStatus (string) Processing status of the pair <ul style="list-style-type: none"> • E: The expansion processing is in progress. • N: The expansion processing is not in progress. <p>The same value as that of <code>svolProcessingStatus</code> is output.</p> ▪ svolProcessingStatus (string) Processing status of the pair <ul style="list-style-type: none"> • E: The expansion processing is in progress. • N: The expansion processing is not in progress. <p>The same value as that of <code>pvolProcessingStatus</code> is output.</p> |

Status codes

The following table describes the meaning of the status code of the request for this operation. For details on other status codes, see the section explaining HTTP status codes.

| Status code | Message | Description |
|-------------|-----------|---|
| 404 | Not Found | No copy group can be obtained, or no pair was included in the copy group that was obtained. |

Coding example

```
curl -v -H "Accept: application/json" -H "Authorization:Session
d7b673af189048468c5af9bcf3bbbb6f" -X GET https://192.0.2.100/
ConfigurationManager/v1/objects/local-clone-copygroups/localCopyGroup1,
localCopyGroup1P_,localCopyGroup1S_
```

Getting a list of ShadowImage pairs

The following request obtains information about the ShadowImage pairs in a copy group specified by using query parameters. You can also update the pair information when you obtain information about ShadowImage pairs.

**Important:**

- If the target copy group contains a ShadowImage pair that was created or deleted by using another REST API server or software other than the REST API, information about that pair might not be obtained. To obtain the most recent information about such pairs, run the API with `refresh=true` specified for the query parameter. Note that such processing takes time because the information about the pairs in the specified copy group is updated, and then information is obtained.
- If the copy group name, device group name, or copy pair name contains spaces, the information cannot be obtained.

Execution permission

Storage Administrator (View Only)

Request lineGET *base-URL*/v1/objects/local-clone-copypairs**Request message****Object ID**

None.

Query parameters

| Parameter | Type | Filter condition |
|-----------------------|--------|---|
| localCloneCopyGroupId | string | (Required) Object ID of the copy group that contains a pair |

| Parameter | Type | Filter condition |
|----------------------|---------|---|
| | | <p>Specify the <code>localCloneCopygroupId</code> value obtained by getting the list of copy groups. You can also specify the following attributes separated by a comma:</p> <p><i>copyGroupName, pvolDeviceGroupName, svolDeviceGroupName</i></p> <ul style="list-style-type: none"> ▪ <code>copyGroupName</code> (string) Copy group name Value should not exceed 31 characters. ▪ <code>pvolDeviceGroupName</code> (string) Device group name for the P-VOL Value should not exceed 31 characters. ▪ <code>svolDeviceGroupName</code> (string) Device group name for the S-VOL Value should not exceed 31 characters. |
| <code>refresh</code> | boolean | <p>(Optional) Whether to update the pair information to the most recent:</p> <ul style="list-style-type: none"> ▪ <code>true</code>: Pair information will be updated. ▪ <code>false</code>: Pair information will not be updated. <p>If you specify <code>true</code>, processing takes time because the information about the pairs in the specified copy group is updated and then information is obtained. If this parameter is omitted, <code>false</code> is assumed.</p> |

Body

None.

Response message**Body**

Information about the pairs in the specified copy group is obtained in a list. For details about the response body, see the section describing the API for obtaining information about specific ShadowImage pairs.

Status codes

For details on the status codes of the request for this operation, see the section explaining HTTP status codes.

Coding example

```
curl -v -H "Accept: application/json" -H "Authorization:Session
d7b673af189048468c5af9bcf3bbbbb6f" -X GET "https://192.0.2.100/
ConfigurationManager/v1/objects/local-clone-coppairs?
localCloneCopyGroupId=localCopyGroup1,localCopyGroup1P_,
localCopyGroup1S_&refresh=true"
```

Getting information about a specific ShadowImage pair

The following request gets information about the specified ShadowImage pair. This request can confirm whether a pair operation is finished based on the pair status, and can get configuration information such as the consistency group ID used when adding a pair.

**Important:**

- If the target ShadowImage pair was created or deleted by using another REST API server or software other than the REST API, correct information about that pair might not be obtained. To obtain the most recent information about the pairs, use the API for obtaining a list of ShadowImage pairs.
- If the copy group name, device group name, or copy pair name contains spaces, information cannot be obtained.

Execution permission

Storage Administrator (View Only)

Request line

```
GET base-URL/v1/objects/local-clone-coppairs/object-ID
```

Request message**Object ID**

Specify the `localCloneCoppairId` value obtained by getting the ShadowImage pair information. You can also specify the following attributes and connect them with commas:

```
copyGroupName,pvolDeviceGroupName,svolDeviceGroupName,copyPairName
```

| Attribute | Type | Description |
|---------------------|--------|--|
| copyGroupName | string | (Required) Specify the copy group name. Value should not exceed 31 characters. The name is case sensitive. |
| pvolDeviceGroupName | string | (Required) Specify the P-VOL device group name. Value should not exceed 31 characters. The name is case sensitive. |
| svolDeviceGroupName | string | (Required) Specify the S-VOL device group name. Value should not exceed 31 characters. The name is case sensitive. |
| copyPairName | string | (Required) Specify the name of the copy pair. Value should not exceed 31 characters. The name is case sensitive. |

Query parameters

None.

Body

None.

Response message**Body**

```
{
  "localCloneCopypairId" : "localCopyGroup1,localCopyGroup1P_,
localCopyGroup1S_,pair1",
  "copyGroupName" : "localCopyGroup1",
  "copyPairName" : "pair1",
  "replicationType" : "SI",
  "copyMode" : "NotSnapshot",
  "copyProgressRate" : 100,
  "pvolLdevId" : 10,
  "pvolStatus" : "PAIR",
  "svolLdevId" : 20,
  "svolStatus" : "PAIR",
  "pvolMuNumber" : 0,
  "pvolProcessingStatus": "N",
  "svolProcessingStatus": "N"
}
```

| Attribute | Type | Description |
|-------------------------|--------|--|
| copyGroupName | string | Copy group name |
| copyPairName | string | Copy pair name |
| replicationType | string | Pair type SI: ShadowImage |
| copyMode | string | Copy mode Outputs NotSnapshot. |
| copyProgressRate | int | Copy progress rate (%) This attribute is not output if no information can be obtained. |
| pvolLdevId | int | LDEV number of the P-VOL |
| svolLdevId | int | LDEV number of the S-VOL |
| pvolMuNumber | int | MU number of the P-VOL |
| pvolStatus | string | Pair volume status of the P-VOL For details, see the section describing the pair status (ShadowImage). This attribute is not output if no information can be obtained. |
| svolStatus | string | Pair volume status of the S-VOL For details, see the section describing the pair status (ShadowImage). This attribute is not output if no information can be obtained. |
| consistencyGroupI d | int | Consistency group ID This attribute is not output if no consistency group consists. |
| localCloneCoppai rId | string | Object ID of the ShadowImage pair The following attributes are output, separated by commas: <ul style="list-style-type: none"> ▪ copyGroupName ▪ pvolDeviceGroupName ▪ svolDeviceGroupName ▪ copyPairName |

| Attribute | Type | Description |
|----------------------|--------|---|
| pvolProcessingStatus | string | Processing status of the pair <ul style="list-style-type: none"> E: The expansion processing is in progress. N: The expansion processing is not in progress. The same value as that of <code>svolProcessingStatus</code> is output. |
| svolProcessingStatus | string | Processing status of the pair <ul style="list-style-type: none"> E: The expansion processing is in progress. N: The expansion processing is not in progress. The same value as that of <code>pvolProcessingStatus</code> is output. |

Status codes

For details on the status codes of the request for this operation, see the section explaining HTTP status codes.

Coding example

```
curl -v -H "Accept: application/json" -H "Authorization:Session
d7b673af189048468c5af9bcf3bbbbb6f" -X GET https://192.0.2.100/
ConfigurationManager/v1/objects/local-clone-coppairs/localCopyGroup1,
localCopyGroup1P_,localCopyGroup1S_,pair1
```

Getting information about all of ShadowImage pairs

The following request gets information about the ShadowImage pairs registered in the target storage system. You can obtain information about all such pairs from the cache of the storage system, regardless of whether they are managed by using copy groups.



Note:

- This API can be used when the storage system is the VSP 5000 series.
- To get up-to-date information, you must run the API request that refreshes the storage system's cache before running this request. For details, see "Updating the cache of storage system configuration information".

Execution permission

Storage Administrator (View Only)

Request line

```
GET base-URL/v1/objects/local-replications
```

Request message**Object ID**

None.

Query parameters

| Parameter | Type | Description |
|-----------------|------|--|
| startPvolLdevId | int | <p>(Optional) To specify a range of LDEVs, specify the LDEV number of the first LDEV in the range.</p> <p>The P-VOLs in the specified range of LDEVs are searched, and information about the relevant pairs is obtained.</p> <p>Specify a value in the range from 0 to 65279.</p> <p>The value of this parameter must be smaller than that of the endPvolLdevId parameter.</p> <p>If this attribute is omitted, 0 is set.</p> |
| endPvolLdevId | int | <p>(Optional) To specify a range of LDEVs, specify the LDEV number of the last LDEV in the range.</p> <p>The P-VOLs in the specified range of LDEVs are searched, and information about the relevant pairs is obtained.</p> <p>Specify a value in the range from 0 to 65279.</p> <p>The value of this parameter must be greater than that of the startPvolLdevId parameter.</p> <p>If this attribute is omitted, the maximum LDEV number in the storage system is set.</p> |

Body

None.

Response message**Body**

```
{
  "data": [
    {
      "localReplicationId": "474,475",
```

```

    "replicationType": "SI",
    "copyMode": "NotSnapshot",
    "pvolLdevId": 474,
    "svolLdevId": 475,
    "pvolMuNumber": 0,
    "pvolStatus": "PAIR",
    "svolStatus": "PAIR",
    "consistencyGroupId": -1,
    "transitionStatus": "None"
  },
  {
    "localReplicationId": "476,487",
    "replicationType": "SI",
    "copyMode": "NotSnapshot",
    "pvolLdevId": 476,
    "svolLdevId": 487,
    "pvolMuNumber": 0,
    "pvolStatus": "PAIR",
    "svolStatus": "PAIR",
    "consistencyGroupId": -1,
    "transitionStatus": "None"
  }
]
}

```

| Attribute | Type | Description |
|--------------------|--------|---|
| localReplicationId | string | Object ID of the copy pair The following attributes are output, separated by commas: <ul style="list-style-type: none"> ▪ pvolLdevId ▪ svolLdevId |
| replicationType | string | Pair type Outputs <code>SI</code> (ShadowImage). |
| copyMode | string | Copy mode For ShadowImage, <code>NotSnapshot</code> is output. If Volume Migration operations have already been performed for the pair, <code>VolumeMigration</code> is output. |
| pvolLdevId | int | LDEV number of the P-VOL |
| svolLdevId | int | LDEV number of the S-VOL |

| Attribute | Type | Description |
|--------------------|--------|---|
| pvolMuNumber | int | MU number of the P-VOL |
| pvolStatus | string | Pair volume status of the P-VOL For details, see the section describing the pair status (ShadowImage). This attribute is not output if no information can be obtained or if the status of the ShadowImage pair in transition is <code>Deleting</code> . |
| svolStatus | string | Pair volume status of the S-VOL For details, see the section describing the pair status (ShadowImage). This attribute is not output if no information can be obtained or if the status of the ShadowImage pair in transition is <code>Deleting</code> . |
| consistencyGroupID | int | Consistency group ID This attribute is not output if no consistency group consists. |
| transitionStatus | string | The status of the ShadowImage pair in transition <ul style="list-style-type: none"> ▪ <code>None</code>: The pair is not in transition ▪ <code>Deleting</code>: The pair is being deleted |

Status codes

For details on the status codes for the request that performs this operation, see the description of HTTP status codes.

Coding example

```
curl -v -H "Accept: application/json" -H "Authorization:Session
d7b673af189048468c5af9bcf3b6bb6f" -X GET https://192.0.2.100/
ConfigurationManager/v1/objects/local-replications
```

Creating a ShadowImage pair

The following request creates a ShadowImage pair in the target storage system. The ShadowImage pair is either added to a newly created copy group or to an existing copy group.



Tip: We recommend specifying `Job-Mode-Wait-Configuration-Change:NoWait` in the request header of this API function. For details, see the description of the flow of operations for the pairs.

Execution permission

Storage Administrator (Provisioning) and Storage Administrator (Local Copy)

Request line

POST *base-URL*/v1/objects/local-clone-copypairs

Request message

Object ID

None.

Query parameters

None.

Body

```
{
  "copyGroupName": "localCopyGroup1",
  "copyPairName": "pair1",
  "replicationType": "SI",
  "pvolLdevId": 10,
  "pvolMuNumber": 0,
  "svolLdevId": 20,
  "pvolDeviceGroupName": "localCopyGroup1P_",
  "svolDeviceGroupName": "localCopyGroup1S_",
  "isNewGroupCreation": true,
  "copyPace": 1,
  "isConsistencyGroup": true,
  "consistencyGroupId": 1,
  "quickMode": false,
  "autoSplit": false,
  "isDataReductionForceCopy": true
}
```

| Attribute | Type | Description |
|---------------|--------|--|
| copyGroupName | string | (Required) Specify the copy group name. Value should not exceed 29 characters. The name is case sensitive. |

| Attribute | Type | Description |
|---------------------|---------|---|
| copyPairName | string | (Required) Specify the copy pair name. Value should not exceed 31 characters. The name is case sensitive. |
| replicationType | string | (Required) Specify <code>SI</code> (ShadowImage) as the pair type. |
| pvolDevId | int | (Required) Specify the LDEV number of the P-VOL with a decimal (base 10) number. |
| svolDevId | int | (Required) Specify the LDEV number of the S-VOL with a decimal (base 10) number. |
| pvolDeviceGroupName | string | (Optional) Specify the device group name for the P-VOL. Value should not exceed 31 characters. The name is case sensitive. Specify a device group name that differs from the device group name for the S-VOL. In addition, to add a ShadowImage pair to an existing copy group, specify the device group name for an existing P-VOL. If this value is omitted, <code>copyGroupNameP_</code> is assumed. |
| svolDeviceGroupName | string | (Optional) Specify the device group name for the S-VOL. Value should not exceed 31 characters. The name is case sensitive. Specify a device group name that differs from the device group name for the P-VOL. To add a ShadowImage pair to an existing copy group, specify the device group name for an existing S-VOL. If this value is omitted, <code>copyGroupNameS_</code> is assumed. |
| isNewGroupCreation | boolean | (Required) Depending on the value, this attribute specifies whether to add a ShadowImage pair to a newly created copy group or to an existing copy group. |

| Attribute | Type | Description |
|--------------------|---------|--|
| | | <p>Make sure that the ShadowImage pair is not added to a copy group that includes Volume Migration pairs.</p> <ul style="list-style-type: none"> ▪ <code>true</code>: Adds the ShadowImage pair to a newly created copy group. ▪ <code>false</code>: Adds the ShadowImage pair to an existing copy group. |
| pvolMuNumber | int | <p>(Optional) Specify the MU number of the P-VOL.</p> <p>If you specify <code>true</code> for the <code>isNewGroupCreation</code> attribute, make sure to specify this attribute. If you specify <code>false</code> for the <code>isNewGroupCreation</code> attribute, you cannot specify this attribute.</p> <ul style="list-style-type: none"> ▪ If the S-VOL is in layer 1, specify a value in the range from 0 to 2. ▪ If the S-VOL is in layer 2, specify 1 or 2. |
| copyPace | int | <p>(Optional) Specify a value in the range from 1 to 15 to be the copy speed. The larger the value, the higher the speed.</p> <p>If this value is omitted, 3 is assumed.</p> |
| isConsistencyGroup | boolean | <p>(Optional) Depending on the value, this attribute specifies whether to register the new pair in a consistency group. If a pair that is already registered in the consistency group exists in the copy group, you can register the new pair in the same consistency group.</p> <ul style="list-style-type: none"> ▪ <code>true</code>: Registers the pair in a consistency group. ▪ <code>false</code>: Does not register the pair in a consistency group. <p>When the value of the <code>autoSplit</code> attribute is <code>true</code>, you cannot specify <code>true</code> for this item.</p> <p>If this value is omitted, <code>false</code> is assumed.</p> |

| Attribute | Type | Description |
|--------------------------|---------|---|
| consistencyGroupId | int | <p>(Optional) To register the new pair in the consistency group, specify the consistency group ID (0 to 127). If a pair is already registered in a consistency group in a copy group, specify the ID of the consistency group to which the existing pair belongs.</p> <p>If you specify <code>true</code> for the <code>isConsistencyGroup</code> attribute and do not specify this attribute, a new consistency group ID is assigned.</p> |
| autoSplit | boolean | <p>(Optional) Depending on the value, this attribute specifies whether to split the pair automatically after the operation finishes.</p> <ul style="list-style-type: none"> ▪ <code>true</code>: Splits the pair after the operation finishes ▪ <code>false</code>: Does not split the pair after the operation finishes <p>When the value of the <code>isConsistencyGroup</code> attribute is <code>true</code>, you cannot specify <code>true</code> for this item.</p> <p>If this value is omitted, <code>false</code> is assumed.</p> |
| quickMode | boolean | <p>(Optional) Specify whether to run in quick mode.</p> <ul style="list-style-type: none"> ▪ <code>true</code>: Performs execution in quick mode. ▪ <code>false</code>: Performs execution in normal mode. <p>You can specify <code>true</code> for this item only when the value of the <code>autoSplit</code> attribute is <code>true</code>.</p> <p>If this value is omitted, <code>false</code> is assumed.</p> |
| isDataReductionForceCopy | boolean | <p>(Optional) Specify whether to forcibly create a pair for a volume for which the capacity saving function (dedupe and compression) is enabled.</p> <p>When creating a pair for a volume for which the capacity saving function is enabled, always specify <code>true</code>.</p> <ul style="list-style-type: none"> ▪ <code>true</code>: Forcibly create a pair# ▪ <code>false</code>: Do not forcibly create a pair |

| Attribute | Type | Description |
|-----------|------|---|
| | | When the attribute is omitted, <code>false</code> is assumed. |

#: If you create a pair by using volumes for which the capacity saving function (compression or deduplication) is enabled, data that has been compressed or deduplicated will be copied and, as a result, the performance of the copying processing or the I/O performance of the host might decrease.

Response message

Body

A job object is returned. For details on attributes other than `affectedResources`, see the section explaining job objects.

| Attribute | Description |
|--------------------------------|-------------------------------------|
| <code>affectedResources</code> | URL of the created ShadowImage pair |

Status codes

For details on the status codes of the request for this operation, see the description on HTTP status codes.

Coding example

```
curl -v -H "Accept: application/json" -H "Content-Type: application/json" -H "Authorization:Session d7b673af189048468c5af9bcf3bbbb6f" -X POST --data-binary @./InputParameters.json https://192.0.2.100/ConfigurationManager/v1/objects/local-clone-coppairs
```

Splitting ShadowImage pairs in units of copy groups

The following request splits the ShadowImage pairs included in the specified copy group. If the pair is split, data can be read from or written to the secondary volume.



Tip: We recommend specifying `Job-Mode-Wait-Configuration-Change:NoWait` in the request header of this API function. For details, see the description of the flow of operations for the pairs.



Note: The `forceSplit` attribute in the action template is unnecessary. When using the action template, remove this attribute before creating a request.

Execution permission

Storage Administrator (Local Copy)

Request line

```
POST base-URL/v1/objects/local-clone-copygroups/object-ID/actions/split/
invoke
```

Request message**Object ID**

Specify the `localCloneCopygroupId` value obtained by getting the list of copy groups. You can also specify the following attributes and connect them with commas:

```
copyGroupName,pvolDeviceGroupName,svolDeviceGroupName
```

| Attribute | Type | Description |
|----------------------------------|--------|--|
| <code>copyGroupName</code> | string | (Required) Specify the copy group name. Value should not exceed 31 characters. The name is case sensitive. |
| <code>pvolDeviceGroupName</code> | string | (Required) Specify the P-VOL device group name. Value should not exceed 31 characters. The name is case sensitive. |
| <code>svolDeviceGroupName</code> | string | (Required) Specify the S-VOL device group name. Value should not exceed 31 characters. The name is case sensitive. |

Query parameters

None.

Body

```
{
  "parameters": {
    "quickMode": true,
    "copyPace": 10,
    "forceSuspend": false
  }
}
```

| Attribute | Type | Description |
|--------------|---------|---|
| quickMode | boolean | (Optional) Specify whether to run in quick mode. <ul style="list-style-type: none"> <code>true</code>: Performs execution in quick mode. <code>false</code>: Performs execution in normal mode. If this value is omitted, <code>false</code> is assumed. |
| copyPace | int | (Optional) Specify a value in the range from 1 to 15 to be the copy speed. The larger the value, the higher the speed. If you specify <code>true</code> for the <code>forceSuspend</code> attribute, you cannot specify this attribute. |
| forceSuspend | boolean | (Optional) Specify whether to force splitting of the pair. <ul style="list-style-type: none"> <code>true</code>: Forces splitting of the pair. <code>false</code>: Does not force splitting of the pair. If this value is omitted, <code>false</code> is assumed. If you specify <code>true</code> for this attribute, you cannot specify the <code>copyPace</code> attribute. |

Response message

Body

A job object is returned. For details on attributes other than `affectedResources`, see the section explaining job objects.

| Attribute | Description |
|--------------------------------|-----------------------------|
| <code>affectedResources</code> | URL of the split copy group |

Action template

```
GET base-URL/v1/objects/local-clone-copygroups/object-ID/actions/split
```

Status codes

The following table describes the meaning of the status code of the request for this operation. For details on other status codes, see the description on HTTP status codes.

| Status code | Message | Description |
|-------------|---------------------|--|
| 412 | Precondition Failed | The action template cannot be obtained, because the object is incorrect. |

Coding example

To get an action template:

```
curl -v -H "Accept: application/json" -H "Authorization:Session
d7b673af189048468c5af9bcf3bbbbb6f" -X GET https://192.0.2.100/
ConfigurationManager/v1/objects/local-clone-copygroups/localCopyGroup1,
localCopyGroup1P_,localCopyGroup1S_/actions/split
```

To run the request after getting an action template:

```
curl -v -H "Accept: application/json" -H "Content-Type: application/json" -
H "Authorization:Session d7b673af189048468c5af9bcf3bbbbb6f" -X POST --data-
binary @./InputParameters.json https://192.0.2.100/ConfigurationManager/v1/
objects/local-clone-copygroups/localCopyGroup1,localCopyGroup1P_,
localCopyGroup1S_/actions/split/invoke
```

Splitting a ShadowImage pair

The following request splits the specified ShadowImage pair. If the pair is split, data can be read from or written to the secondary volume.



Tip: We recommend specifying `Job-Mode-Wait-Configuration-Change:NoWait` in the request header of this API function. For details, see the description of the flow of operations for the pairs.



Note: The `forceSplit` attribute in the action template is unnecessary. When using the action template, remove this attribute before creating a request.

Execution permission

Storage Administrator (Local Copy)

Request line

```
POST base-URL/v1/objects/local-clone-copypairs/object-ID/actions/split/
invoke
```

Request message**Object ID**

Specify the `localCloneCopypairId` value obtained by getting the ShadowImage pair information. You can also specify the following attributes and connect them with commas:

```
copyGroupName,pvolDeviceGroupName,svolDeviceGroupName,copyPairName
```

| Attribute | Type | Description |
|---------------------|--------|--|
| copyGroupName | string | (Required) Specify the copy group name. Value should not exceed 31 characters. The name is case sensitive. |
| pvolDeviceGroupName | string | (Required) Specify the P-VOL device group name. Value should not exceed 31 characters. The name is case sensitive. |
| svolDeviceGroupName | string | (Required) Specify the S-VOL device group name. Value should not exceed 31 characters. The name is case sensitive. |
| copyPairName | string | (Required) Specify the name of the copy pair. Value should not exceed 31 characters. The name is case sensitive. |

Query parameters

None.

Body

```
{
  "parameters": {
    "quickMode": true,
    "copyPace": 10,
    "forceSuspend": false
  }
}
```

| Attribute | Type | Description |
|-----------|---------|---|
| quickMode | boolean | (Optional) Specify whether to run in quick mode. <ul style="list-style-type: none"> ▪ <code>true</code>: Performs execution in quick mode. ▪ <code>false</code>: Performs execution in normal mode. |

| Attribute | Type | Description |
|-----------------------------|----------------------|---|
| | | If this value is omitted, <code>false</code> is assumed. |
| <code>copyPace</code> | <code>int</code> | (Optional) Specify a value in the range from 1 to 15 to be the copy speed. The larger the value, the higher the speed. If you specify <code>true</code> for the <code>forceSuspend</code> attribute, you cannot specify this attribute. |
| <code>forceSuspended</code> | <code>boolean</code> | (Optional) Specify whether to force splitting of the pair. <ul style="list-style-type: none"> <code>true</code>: Forces splitting of the pair. <code>false</code>: Does not force splitting of the pair. If this value is omitted, <code>false</code> is assumed. If you specify <code>true</code> for this attribute, you cannot specify the <code>copyPace</code> attribute. |

Response message

Body

A job object is returned. For details on attributes other than `affectedResources`, see the section explaining job objects.

| Attribute | Description |
|--------------------------------|-----------------------------------|
| <code>affectedResources</code> | URL of the split ShadowImage pair |

Action template

```
GET base-URL/v1/objects/local-clone-copypairs/object-ID/actions/split
```

Status codes

The following table describes the meaning of the status code of the request for this operation. For details on other status codes, see the description on HTTP status codes.

| Status code | Message | Description |
|-------------|---------------------|--|
| 412 | Precondition Failed | The action template cannot be obtained, because the object is incorrect. |

Coding example

To get an action template:

```
curl -v -H "Accept: application/json" -H "Authorization:Session
d7b673af189048468c5af9bcf3bbbb6f" -X GET https://192.0.2.100/
ConfigurationManager/v1/objects/local-clone-copypairs/localCopyGroup1,
localCopyGroup1P_,localCopyGroup1S_,pair1/actions/split
```

To run the request after getting an action template:

```
curl -v -H "Accept: application/json" -H "Content-Type: application/json" -
H "Authorization:Session d7b673af189048468c5af9bcf3bbbb6f" -X POST --data-
binary @./InputParameters.json https://192.0.2.100/ConfigurationManager/v1/
objects/local-clone-copypairs/localCopyGroup1,localCopyGroup1P_,
localCopyGroup1S_,pair1/actions/split/invoke
```

Resynchronizing ShadowImage pairs in units of copy groups

The following HTTP request resynchronizes ShadowImage pairs that were split in the specified copy group in the normal direction (from primary volumes to secondary volumes).



Tip: We recommend specifying `Job-Mode-Wait-Configuration-Change:NoWait` in the request header of this API function. For details, see the description of the flow of operations for the pairs.

Execution permission

Storage Administrator (Local Copy)

Request line

```
POST base-URL/v1/objects/local-clone-copygroups/object-ID/actions/resync/
invoke
```

Request message**Object ID**

Specify the `localCloneCopygroupId` value obtained by getting the list of copy groups. You can also specify the following attributes and connect them with commas:

```
copyGroupName, pvolDeviceGroupName, svolDeviceGroupName
```

| Attribute | Type | Description |
|---------------------|--------|--|
| copyGroupName | string | (Required) Specify the copy group name. Value should not exceed 31 characters. The name is case sensitive. |
| pvolDeviceGroupName | string | (Required) Specify the P-VOL device group name. Value should not exceed 31 characters. The name is case sensitive. |
| svolDeviceGroupName | string | (Required) Specify the S-VOL device group name. Value should not exceed 31 characters. The name is case sensitive. |

Query parameters

None.

Body

```
{
  "parameters": {
    "quickMode": true,
    "copyPace": 10
  }
}
```

| Attribute | Type | Description |
|-----------|---------|--|
| quickMode | boolean | (Optional) Specify whether to run in quick mode. <ul style="list-style-type: none"> ▪ <code>true</code>: Performs execution in quick mode. ▪ <code>false</code>: Performs execution in normal mode. If this value is omitted, <code>false</code> is assumed. |
| copyPace | int | (Optional) Specify a value in the range from 1 to 15 to be the copy speed. The larger the value, the higher the speed. |

Response message**Body**

A job object is returned. For details on attributes other than `affectedResources`, see the section explaining job objects.

| Attribute | Description |
|-------------------|--------------------------------------|
| affectedResources | URL of the resynchronized copy group |

Action template

```
GET base-URL/v1/objects/local-clone-copygroups/object-ID/actions/resync
```

Status codes

The following table describes the meaning of the status code of the request for this operation. For details on other status codes, see the description on HTTP status codes.

| Status code | Message | Description |
|-------------|---------------------|--|
| 412 | Precondition Failed | The action template cannot be obtained, because the object is incorrect. |

Coding example

To get an action template:

```
curl -v -H "Accept: application/json" -H "Authorization:Session d7b673af189048468c5af9bcf3bbbbb6f" -X GET https://192.0.2.100/ConfigurationManager/v1/objects/local-clone-copygroups/localCopyGroup1,localCopyGroup1P_,localCopyGroup1S_/actions/resync
```

To run the request after getting an action template:

```
curl -v -H "Accept: application/json" -H "Content-Type: application/json" -H "Authorization:Session d7b673af189048468c5af9bcf3bbbbb6f" -X POST --data-binary @./InputParameters.json https://192.0.2.100/ConfigurationManager/v1/objects/local-clone-copygroups/localCopyGroup1,localCopyGroup1P_,localCopyGroup1S_/actions/resync/invoke
```

Resynchronizing a ShadowImage pair

The following HTTP request resynchronizes a split ShadowImage pair in the normal direction (from the primary volume to the secondary volume).



Tip: We recommend specifying `Job-Mode-Wait-Configuration-Change:NoWait` in the request header of this API function. For details, see the description of the flow of operations for the pairs.

Execution permission

Storage Administrator (Local Copy)

Request line

```
POST base-URL/v1/objects/local-clone-copypairs/object-ID/actions/resync/
invoke
```

Request message**Object ID**

Specify the `localCloneCopypairId` value obtained by getting the ShadowImage pair information. You can also specify the following attributes and connect them with commas:

```
copyGroupName,pvolDeviceGroupName,svolDeviceGroupName,copyPairName
```

| Attribute | Type | Description |
|----------------------------------|--------|--|
| <code>copyGroupName</code> | string | (Required) Specify the copy group name. Value should not exceed 31 characters. The name is case sensitive. |
| <code>pvolDeviceGroupName</code> | string | (Required) Specify the P-VOL device group name. Value should not exceed 31 characters. The name is case sensitive. |
| <code>svolDeviceGroupName</code> | string | (Required) Specify the S-VOL device group name. Value should not exceed 31 characters. The name is case sensitive. |
| <code>copyPairName</code> | string | (Required) Specify the name of the copy pair. Value should not exceed 31 characters. The name is case sensitive. |

Query parameters

None.

Body

```
{
  "parameters": {
    "quickMode": true,
    "copyPace": 10
  }
}
```

| Attribute | Type | Description |
|-----------|---------|--|
| quickMode | boolean | (Optional) Specify whether to run in quick mode. <ul style="list-style-type: none"> <code>true</code>: Performs execution in quick mode. <code>false</code>: Performs execution in normal mode. If this value is omitted, <code>false</code> is assumed. |
| copyPace | int | (Optional) Specify a value in the range from 1 to 15 to be the copy speed. The larger the value, the higher the speed. |

Response message

Body

A job object is returned. For details on attributes other than `affectedResources`, see the section explaining job objects.

| Attribute | Description |
|--------------------------------|--|
| <code>affectedResources</code> | URL of the resynchronized ShadowImage pair |

Action template

```
GET base-URL/v1/objects/local-clone-copypairs/object-ID/actions/resync
```

Status codes

The following table describes the meaning of the status code of the request for this operation. For details on other status codes, see the description on HTTP status codes.

| Status code | Message | Description |
|-------------|---------------------|--|
| 412 | Precondition Failed | The action template cannot be obtained, because the object is incorrect. |

Coding example

To get an action template:

```
curl -v -H "Accept: application/json" -H "Authorization:Session
d7b673af189048468c5af9bcf3b6bb6f" -X GET https://192.0.2.100/
ConfigurationManager/v1/objects/local-clone-copypairs/localCopyGroup1,
localCopyGroup1P_,localCopyGroup1S_,pair1/actions/resync
```

To run the request after getting an action template:

```
curl -v -H "Accept: application/json" -H "Content-Type: application/json" -H "Authorization:Session d7b673af189048468c5af9bcf3b66b6f" -X POST --data-binary @./InputParameters.json https://192.0.2.100/ConfigurationManager/v1/objects/local-clone-copypairs/localCopyGroup1,localCopyGroup1P_,localCopyGroup1S_,pair1/actions/resync/invoke
```

Restoring ShadowImage pairs in units of copy groups

The following HTTP request resynchronizes ShadowImage pairs that were split in the specified copy group in the reverse direction (from secondary volumes to the primary volumes).



Tip: We recommend specifying `Job-Mode-Wait-Configuration-Change:NoWait` in the request header of this API function. For details, see the description of the flow of operations for the pairs.

Execution permission

Storage Administrator (Local Copy)

Request line

```
POST base-URL/v1/objects/local-clone-copygroups/object-ID/actions/restore/invoke
```

Request message

Object ID

Specify the `localCloneCopygroupId` value obtained by getting the list of copy groups. You can also specify the following attributes and connect them with commas:

```
copyGroupName,pvolDeviceGroupName,svolDeviceGroupName
```

| Attribute | Type | Description |
|---------------------|--------|--|
| copyGroupName | string | (Required) Specify the copy group name. Value should not exceed 31 characters. The name is case sensitive. |
| pvolDeviceGroupName | string | (Required) Specify the P-VOL device group name. Value should not exceed 31 characters. The name is case sensitive. |

| Attribute | Type | Description |
|---------------------|--------|--|
| svolDeviceGroupName | string | (Required) Specify the S-VOL device group name. Value should not exceed 31 characters. The name is case sensitive. |

Query parameters

None.

Body

```
{
  "parameters": {
    "quickMode": true,
    "copyPace": 10
  }
}
```

| Attribute | Type | Description |
|-----------|---------|--|
| quickMode | boolean | (Optional) Specify whether to run in quick mode. <ul style="list-style-type: none"> ▪ <code>true</code>: Performs execution in quick mode. ▪ <code>false</code>: Performs execution in normal mode. If this value is omitted, <code>false</code> is assumed. |
| copyPace | int | (Optional) Specify a value in the range from 1 to 15 to be the copy speed. The larger the value, the higher the speed. |

Response message**Body**

A job object is returned. For details on attributes other than `affectedResources`, see the section explaining job objects.

| Attribute | Description |
|--------------------------------|--------------------------------|
| <code>affectedResources</code> | URL of the restored copy group |

Action template

```
GET base-URL/v1/objects/local-clone-copygroups/object-ID/actions/restore
```

Status codes

The following table describes the meaning of the status code of the request for this operation. For details on other status codes, see the description on HTTP status codes.

| Status code | Message | Description |
|-------------|---------------------|--|
| 412 | Precondition Failed | The action template cannot be obtained, because the object is incorrect. |

Coding example

To get an action template:

```
curl -v -H "Accept: application/json" -H "Authorization:Session
d7b673af189048468c5af9bcf3bbbb6f" -X GET https://192.0.2.100/
ConfigurationManager/v1/objects/local-clone-copygroups/localCopyGroup1,
localCopyGroup1P_,localCopyGroup1S_/actions/restore
```

To run the request after getting an action template:

```
curl -v -H "Accept: application/json" -H "Content-Type: application/json" -
H "Authorization:Session d7b673af189048468c5af9bcf3bbbb6f" -X POST --data-
binary @./InputParameters.json https://192.0.2.100/ConfigurationManager/v1/
objects/local-clone-copygroups/localCopyGroup1,localCopyGroup1P_,
localCopyGroup1S_/actions/restore/invoke
```

Restoring a ShadowImage pair

The following HTTP request resynchronizes a split ShadowImage pair in the reverse direction (from the secondary volume to the primary volume).



Tip: We recommend specifying `Job-Mode-Wait-Configuration-Change:NoWait` in the request header of this API function. For details, see the description of the flow of operations for the pairs.

Execution permission

Storage Administrator (Local Copy)

Request line

```
POST base-URL/v1/objects/local-clone-copypairs/object-ID/actions/restore/
invoke
```

Request message**Object ID**

Specify the `localCloneCopypairId` value obtained by getting the ShadowImage pair information. You can also specify the following attributes and connect them with commas:

```
copyGroupName, pvolDeviceGroupName, svolDeviceGroupName, copyPairName
```

| Attribute | Type | Description |
|----------------------------------|--------|--|
| <code>copyGroupName</code> | string | (Required) Specify the copy group name. Value should not exceed 31 characters. The name is case sensitive. |
| <code>pvolDeviceGroupName</code> | string | (Required) Specify the P-VOL device group name. Value should not exceed 31 characters. The name is case sensitive. |
| <code>svolDeviceGroupName</code> | string | (Required) Specify the S-VOL device group name. Value should not exceed 31 characters. The name is case sensitive. |
| <code>copyPairName</code> | string | (Required) Specify the name of the copy pair. Value should not exceed 31 characters. The name is case sensitive. |

Query parameters

None.

Body

```
{
  "parameters": {
    "quickMode": true,
    "copyPace": 10
  }
}
```

| Attribute | Type | Description |
|------------------------|---------|--|
| <code>quickMode</code> | boolean | (Optional) Specify whether to run in quick mode. <ul style="list-style-type: none"> ▪ <code>true</code>: Performs execution in quick mode. ▪ <code>false</code>: Performs execution in normal mode. If this value is omitted, <code>false</code> is assumed. |

| Attribute | Type | Description |
|-----------|------|--|
| copyPace | int | (Optional) Specify a value in the range from 1 to 15 to be the copy speed. The larger the value, the higher the speed. |

Response message

Body

A job object is returned. For details on attributes other than affectedResources, see the section explaining job objects.

| Attribute | Description |
|-------------------|--------------------------------------|
| affectedResources | URL of the restored ShadowImage pair |

Action template

```
GET base-URL/v1/objects/local-clone-coppairs/object-ID/actions/restore
```

Status codes

The following table describes the meaning of the status code of the request for this operation. For details on other status codes, see the section explaining HTTP status codes.

| Status code | Message | Description |
|-------------|---------------------|--|
| 412 | Precondition Failed | The action template cannot be obtained, because the object is incorrect. |

Coding example

To get an action template:

```
curl -v -H "Accept: application/json" -H "Authorization:Session d7b673af189048468c5af9bcf3bbbb6f" -X GET https://192.0.2.100/ConfigurationManager/v1/objects/local-clone-coppairs/localCopyGroup1,localCopyGroup1P_,localCopyGroup1S_,pair1/actions/restore
```

To run the request after getting an action template:

```
curl -v -H "Accept: application/json" -H "Content-Type: application/json" -H "Authorization:Session d7b673af189048468c5af9bcf3bbbb6f" -X POST --data-binary @./InputParameters.json https://192.0.2.100/ConfigurationManager/v1/
```

```
objects/local-clone-copypairs/localCopyGroup1,localCopyGroup1P_,
localCopyGroup1S_,pair1/actions/restore/invoke
```

Deleting a copy group

The following request deletes ShadowImage pairs by using the specified copy group. When the pairs are all deleted, the device groups are also deleted.

Execution permission

Storage Administrator (Provisioning) and Storage Administrator (Local Copy)

Request line

```
DELETE base-URL/v1/objects/local-clone-copygroups/object-ID
```

Request message

Object ID

Specify the `localCloneCopygroupId` value obtained by getting the list of copy groups. You can also specify the following attributes and connect them with commas:

```
copyGroupName,pvolDeviceGroupName,svolDeviceGroupName
```

| Attribute | Type | Description |
|---------------------|--------|--|
| copyGroupName | string | (Required) Specify the copy group name. Value should not exceed 31 characters. The name is case sensitive. |
| pvolDeviceGroupName | string | (Required) Specify the P-VOL device group name. Value should not exceed 31 characters. The name is case sensitive. |
| svolDeviceGroupName | string | (Required) Specify the S-VOL device group name. Value should not exceed 31 characters. The name is case sensitive. |

Query parameters

None.

Body

None.

Response message**Body**

A job object is returned. For details on attributes other than `affectedResources`, see the section explaining job objects.

| Attribute | Description |
|--------------------------------|-------------------------------|
| <code>affectedResources</code> | URL of the deleted copy group |

Coding example

```
curl -v -H "Accept: application/json" -H "Content-Type: application/json" -
H "Authorization:Session d7b673af189048468c5af9bcf3b66b6f" -X DELETE --
data-binary @./InputParameters.json https://192.0.2.100/
ConfigurationManager/v1/objects/local-clone-copygroups/localCopyGroup1,
localCopyGroup1P_,localCopyGroup1S_
```

When forcibly deleting a copy group

When a copy group cannot be deleted because the device group in a local storage system remains or because the configuration is not normal, you can forcibly delete the copy group by specifying the `forceDelete` attribute for the request body. The following shows a coding example of using the `forceDelete` attribute:

```
{
  "forceDelete" : true
}
```

| Attribute | Type | Description |
|--------------------------|---------|--|
| <code>forceDelete</code> | boolean | (Optional) Specify whether to delete the copy group forcibly. <ul style="list-style-type: none"> ▪ <code>true</code>: Forcibly delete the copy group. ▪ <code>false</code>: Do not forcibly delete the copy group. When the attribute is omitted, <code>false</code> is assumed. |

Deleting a ShadowImage pair

The following request deletes the specified ShadowImage pair. If there is no ShadowImage pair in the copy group, the copy group and the device group that makes up of the copy group are also deleted.

Execution permission

Storage Administrator (Provisioning) and Storage Administrator (Local Copy)

Request line

```
DELETE base-URL/v1/objects/local-clone-copypairs/object-ID
```

Request message**Object ID**

Specify the `localCloneCopypairId` value obtained by getting the ShadowImage pair information. You can also specify the following attributes and connect them with commas:

```
copyGroupName, pvolDeviceGroupName, svolDeviceGroupName, copyPairName
```

| Attribute | Type | Description |
|----------------------------------|--------|--|
| <code>copyGroupName</code> | string | (Required) Specify the copy group name. Value should not exceed 31 characters. The name is case sensitive. |
| <code>pvolDeviceGroupName</code> | string | (Required) Specify the P-VOL device group name. Value should not exceed 31 characters. The name is case sensitive. |
| <code>svolDeviceGroupName</code> | string | (Required) Specify the S-VOL device group name. Value should not exceed 31 characters. The name is case sensitive. |
| <code>copyPairName</code> | string | (Required) Specify the name of the copy pair. Value should not exceed 31 characters. The name is case sensitive. |

Query parameters

None.

Body

None.

Response message**Body**

A job object is returned. For details on attributes other than `affectedResources`, see the section explaining job objects.

| Attribute | Description |
|-------------------|-------------------------------------|
| affectedResources | URL of the deleted ShadowImage pair |

Status codes

For details on the status codes of the request for this operation, see the description on HTTP status codes.

Coding example

```
curl -v -H "Accept: application/json" -H "Authorization:Session  
d7b673af189048468c5af9bcf3bbbb6f" -X DELETE https://192.0.2.100/  
ConfigurationManager/v1/objects/local-clone-copypairs/localCopyGroup1,  
localCopyGroup1P_,localCopyGroup1S_,pair1
```

Chapter 9: Managing Thin Image pairs

This chapter describes how to perform operations on Thin Image pairs by using the REST API.

Overview of Thin Image

Thin Image creates a copy of a primary volume in a storage system by storing only the differential data for the primary volume.

When updating the primary volume, Thin Image stores the differential data in a Thin Image pool or an HDP pool as snapshot data. If a failure occurs in the data in the storage system, the data can be restored by using the snapshot data. A REST API client issues an API to perform operations for Thin Image.

- When a Thin Image pair without a secondary volume is created:

If a problem occurs in the primary volume data, the primary volume can be restored by using the snapshot data. A secondary volume can be allocated later to the snapshot data when the secondary volume becomes necessary.

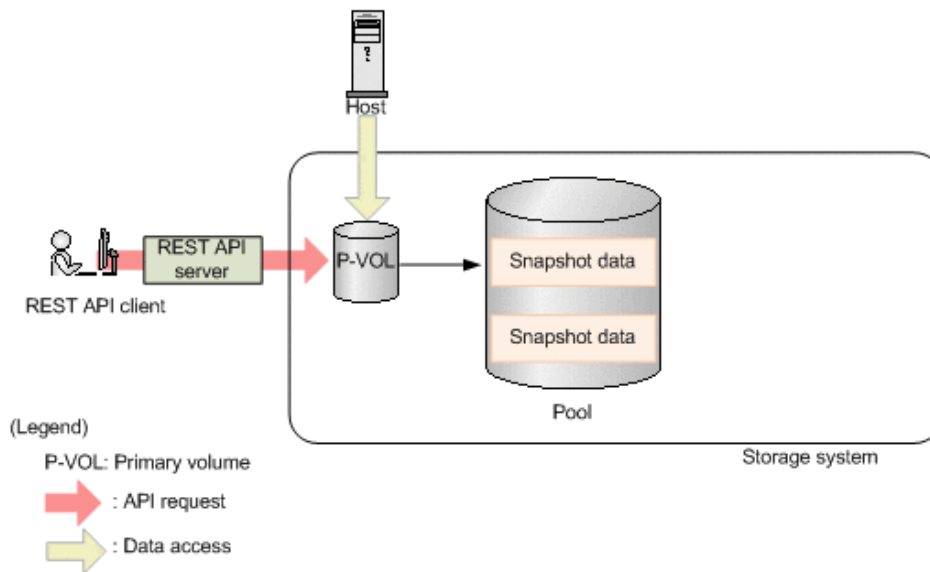

- When a Thin Image pair with a secondary volume is created:

The primary volume can be restored by using the snapshot data. In addition, a copy of the primary volume from when the snapshot data was stored can be viewed from the secondary volume. The following figure shows an example of obtaining a snapshot of a Thin Image pair.

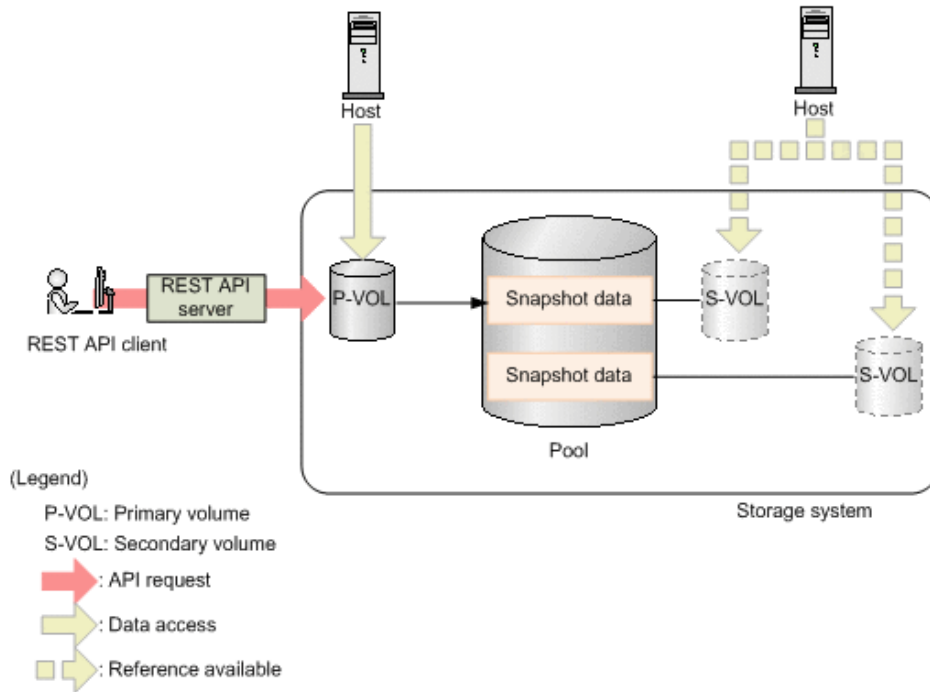

To store snapshot data, create a Thin Image pair where an LDEV or a DP volume is used as a primary volume, and a virtual volume for Thin Image or a DP volume is used as a secondary volume. If the created pair is registered to a snapshot group or a consistency group, processing can be performed by group. If a consistency group is defined, the snapshot data from when the storage system received a request can be stored for all the primary volumes in that consistency group.

You can create a cascade configuration by creating a Thin Image pair for another Thin Image pair. You can also create a clone of a Thin Image pair and use the created clone as DP volumes.

If you clone a Thin Image pair that has the clone attribute, the volume that was specified as the secondary volume can be used as a DP volume.

For details about Thin Image, see the *Hitachi Thin Image User Guide*.

Workflow for operating Thin Image pairs

The following shows the Thin Image functions that can be run by the REST API:

- Getting information about snapshot groups
Obtains a list of snapshot groups registered in the target storage system.
- Getting pair status and configuration information
Obtains a Thin Image pair status and configuration information. You can check if a pair operation is complete. You can also obtain pair information in units of snapshot groups.
- Creating a pair
Creates a new Thin Image pair in a snapshot group of the target storage system. If the snapshot group is not created, the snapshot group is automatically created. You will be able to perform operations in units of snapshot groups by creating Thin Image pairs in a snapshot group.

To create a pair in a new snapshot group:



To create a pair in an existing snapshot group:

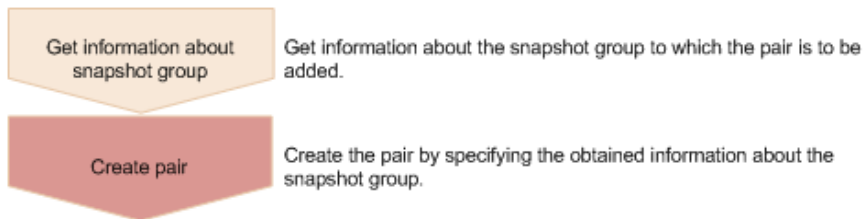

When creating a pair, you can specify whether the clone attribute can be set and whether a cascade configuration is possible.

- Storing snapshot data
Splits a Thin Image pair, and then stores snapshot data, after the primary volume is updated.

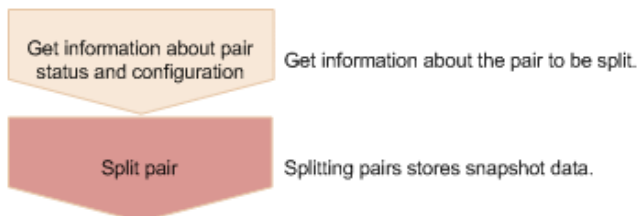

- Resynchronizing a pair

Deletes old snapshot data by resynchronizing a pair. You can perform pair resynchronization if the pair status is PSUS. When pair resynchronization is complete, new snapshot data can be automatically stored again.

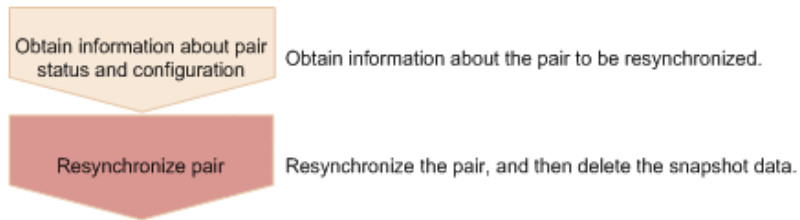

- Recovering a pair by a restore

If you restore a split Thin Image pair, data of the primary volume is restored to the data from when the snapshot data was stored. You can also perform a restore in units of snapshot groups. You can perform a restore if the pair status is PSUS.

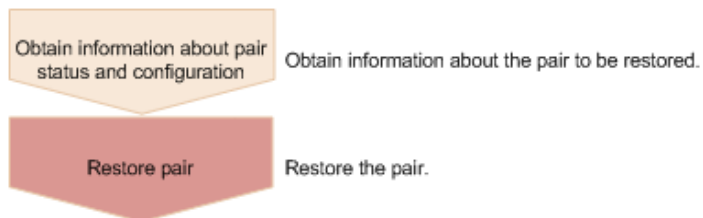

- Assigning a secondary volume to snapshot data

Assigns a secondary volume to the snapshot data of the specified Thin Image pair. Create in advance a virtual volume for Thin Image to be used as the secondary volume. If you assign a secondary volume, you can view the snapshots.

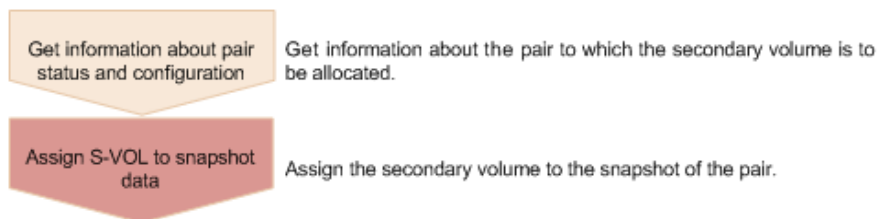

- Unallocating the secondary volume for snapshot data

Unallocates the secondary volume of the specified Thin Image pair.

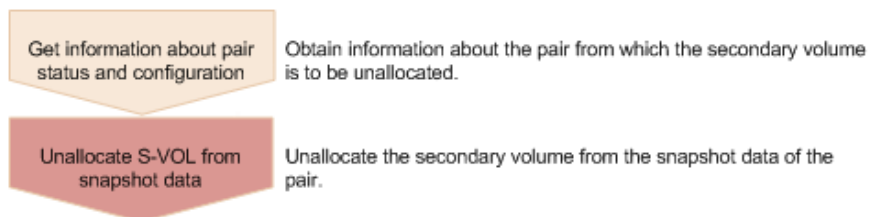

- Deleting a pair

Deletes a Thin Image pair that is unnecessary. If you delete a pair, the snapshot data is deleted from the Thin Image pool or the HDP pool. In addition, if the specified Thin Image pair is the last one in a snapshot group, the snapshot group is also deleted. You can also delete pairs in units of snapshot groups or snapshot trees.

You can delete a pair at any time regardless of the pair status. However, if you delete a pair while the pair status is being changed, the pair might be deleted before its status is changed, and the request to change the pair status might time out.

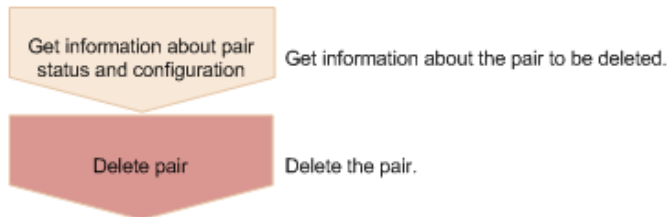

- Cloning

After all the data of the primary volume of a Thin Image pair that has the clone attribute is copied to the secondary volume, the pair is deleted.

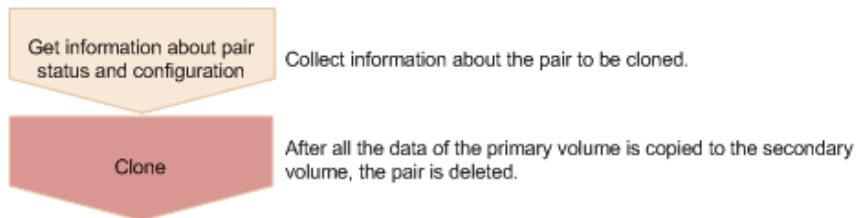

Pair status (Thin Image)

Pair status changes according to the pair operation.

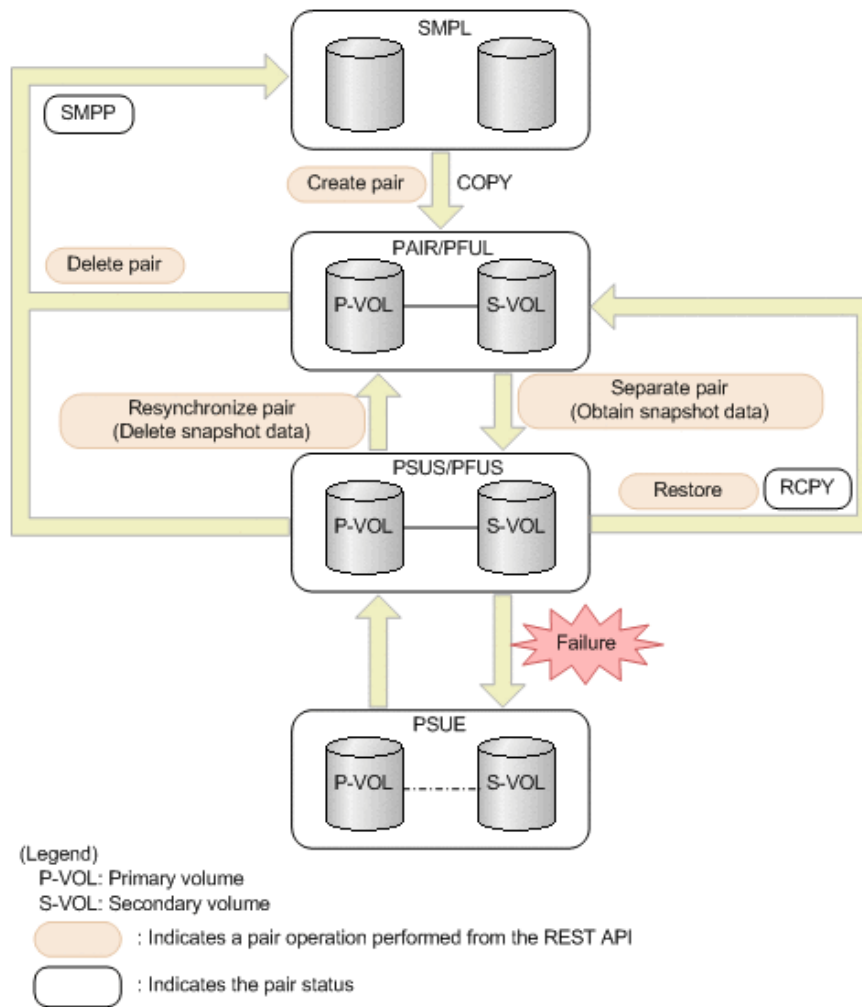

| Pair status | Description | Access to the P-VOL | Access to the S-VOL |
|-------------|--|---------------------|---------------------|
| SMPL | Unpaired volumes | - | - |
| SMPP | A pair was deleted and differential data is now being deleted [#] | R/W enabled | Not enabled |
| COPY | A pair is being created | R/W enabled | Not enabled |
| PAIR | Paired volumes | R/W enabled | Not enabled |
| PFUL | The volumes are paired, and the threshold of a Thin Image pool or an HDP pool is exceeded. | R/W enabled | Not enabled |
| PSUS | The pair has been split. | R/W enabled | R/W enabled |

| Pair status | Description | Access to the P-VOL | Access to the S-VOL |
|-------------|---|---------------------|---------------------|
| PFUS | The pair is split and the threshold of a Thin Image pool or an HDP pool is exceeded. | R/W enabled | R/W enabled |
| RCPY | A restore operation is being performed. (Data is being copied from the S-VOL to the P-VOL.) | R/W enabled | Not enabled |
| PSUE | The pairing is suspended. | R/W enabled | Not enabled |

#: When a pair is in the SMPP status, the volumes that made up the pair cannot be deleted.

When a Universal Replicator pair is made up of volumes with the SLU attribute, if a REST API request whose object type is `snapshot-groups` or `snapshots` is run on the pair, the CPYD status might be output. CPYD indicates the same status as PSUS, PSUP, and PFUS.

The following figure shows the pair status changes when cloning is performed.

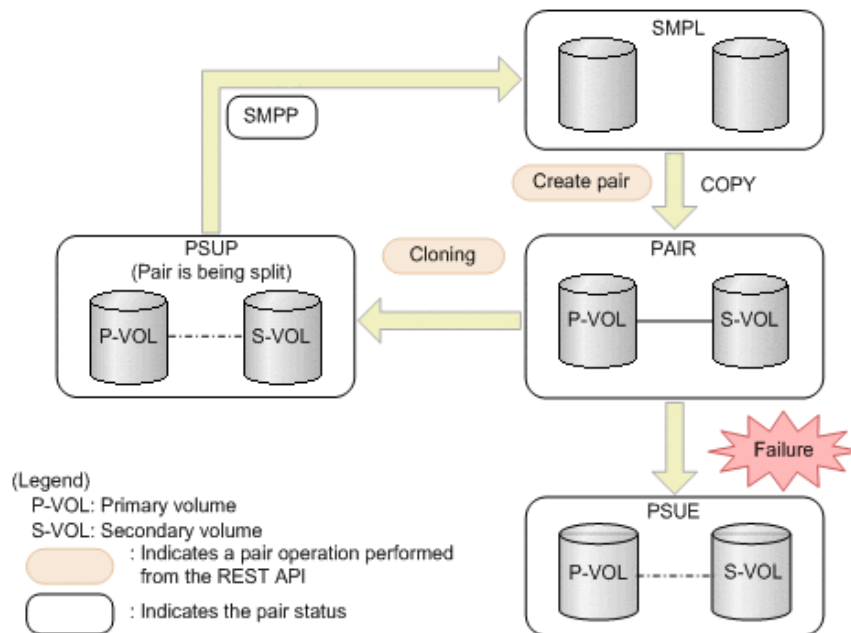

| Pair status | Description | Access to the P-VOL | Access to the S-VOL |
|-------------|--|---------------------|---------------------|
| SMPL | Unpaired volumes | - | - |
| SMPP | A pair was deleted and differential data is now being deleted [#] | R/W enabled | R/W enabled |
| COPY | A pair is being created | R/W enabled | Not enabled |

| Pair status | Description | Access to the P-VOL | Access to the S-VOL |
|-------------|---------------------------|---------------------|---------------------|
| PAIR | Paired volumes | R/W enabled | Not enabled |
| PSUP | A pair is being split | R/W enabled | R/W enabled |
| PSUE | The pairing is suspended. | R/W enabled | Not enabled |

#: When a pair is in the SMPP status, the volumes that made up the pair cannot be deleted.

Getting information about Thin Image pairs in units of snapshot groups

The following request gets a list of information about Thin Image pairs in units of snapshot groups. Use this information to check the information that is necessary for performing pair operations (for example, the pair status).

Execution permission

Storage Administrator (View Only)

Request line

```
GET base-URL/v1/objects/snapshot-groups
```

Request message

Object ID

None.

Query parameters

You can get a list of information about pairs in a snapshot group, as well as detailed information about a pair in a snapshot group.

| Parameter | Type | Description |
|-------------------|--------|---|
| snapshotGroupName | string | (Optional) Specify the name of the snapshot group that contains the Thin Image pairs. Specify a character string consisting of 1 to 32 characters. |

| Parameter | Type | Description |
|-----------------------------|--------|--|
| | | <p>Specify this parameter to get a list of information about pairs in the target snapshot group.</p> <p>If this parameter is omitted, this request gets a list of snapshot groups.</p> <p>You cannot specify both this parameter and the <code>detailInfoType</code> parameter.</p> |
| <code>detailInfoType</code> | string | <p>(Optional) Type of detailed information to be obtained</p> <ul style="list-style-type: none"> ▪ <code>pair</code> <p>Gets detailed information about the pairs in each snapshot group in addition to a list of snapshot groups.</p> <p>You can specify this item for VSP 5000 series.</p> <p>To get up-to-date information, you must run the API request that refreshes the storage system's cache before running this request. For details, see "Updating the cache of storage system configuration information".</p> <p>You cannot specify both this parameter and the <code>snapshotGroupName</code> parameter.</p> |

Body

None.

Response message**Body**

The following is an example of the output generated when getting a list of snapshot groups:

```
{
  "data": [
    {
      "snapshotGroupName": "snapshotGroup",
      "snapshotGroupId": "snapshotGroup"
    },
    {
      "snapshotGroupName": "snapshotGroup2",
      "snapshotGroupId": "snapshotGroup2"
    }
  ]
}
```

```
]
}
```

| Attribute | Type | Description |
|-------------------|--------|---|
| snapshotGroupName | string | Name of the snapshot group that contains the Thin Image pairs. If the name of the snapshot group contains spaces, information about that snapshot group is not output. |
| snapshotGroupId | string | Object ID of the snapshot group. |

The following is an example of the output when the request for getting a list of information about pairs in a snapshot group is executed with `snapshotGroupName` specified as the query parameter. If multiple pairs exist, the information is output in ascending order of the LDEV number and MU number of the primary volume.

```
{
  "data": [
    {
      "snapshotGroupName": "snapshotGroup",
      "primaryOrSecondary": "P-VOL",
      "status": "PSUS",
      "pvolLdevId": 100,
      "muNumber": 3,
      "svolLdevId": 101,
      "snapshotPoolId": 10,
      "concordanceRate": 100,
      "isConsistencyGroup": true,
      "isWrittenInSvol": false,
      "isClone": false,
      "canCascade": false,
      "splitTime": "2015-03-20T09:27:35",
      "snapshotId": "100,3",
      "pvolProcessingStatus": "N",
      "snapshotDataReadOnly": false
    },
    {
      "snapshotGroupName": "snapshotGroup",
      "primaryOrSecondary": "P-VOL",
      "status": "PSUS",
      "pvolLdevId": 100,
      "muNumber": 4,
      "snapshotPoolId": 10,
      "concordanceRate": 100,
      "isConsistencyGroup": true,
      "isWrittenInSvol": false,

```

```

    "isClone": false,
    "canCascade": false,
    "splitTime": "2015-03-20T09:27:35",
    "snapshotId": "100,4",
    "pvolProcessingStatus": "N",
    "snapshotDataReadOnly": false
  }
]
}

```

| Attribute | Type | Description |
|--------------------|--------|---|
| snapshotGroupName | string | Name of the snapshot group that contains the Thin Image pairs. If the name of the snapshot group contains spaces, information about pairs is not output. |
| primaryOrSecondary | string | Attribute of the LDEV |
| status | string | Pair status For details, see the section explaining on pair status (Thin Image). |
| pvolLdevId | int | LDEV number of P-VOL |
| muNumber | int | MU number of the P-VOL |
| svolLdevId | int | LDEV number of S-VOL |
| snapshotPoolId | int | ID of the pool in which the snapshot data is created |
| concordanceRate | int | Concordance rate for pairs This attribute is output when any of the following conditions are met: <ul style="list-style-type: none"> ▪ The value of the <code>isClone</code> attribute is <code>false</code>, and the value of the <code>canCascade</code> attribute is also <code>false</code>. ▪ The value of the <code>isClone</code> attribute is <code>true</code>, and the value of the <code>status</code> attribute is not <code>COPY</code>, <code>RCPY</code>, <code>SMPP</code>, or <code>PSUP</code>. ▪ The value of the <code>canCascade</code> attribute is <code>true</code>, and the value of <code>status</code> attribute is not <code>COPY</code>, <code>RCPY</code>, <code>SMPP</code>, or <code>PSUP</code>. |
| progressRate | int | Progress of the processing |

| Attribute | Type | Description |
|---------------------------------|---------|---|
| | | <p>This attribute is output when either of the following conditions is met:</p> <ul style="list-style-type: none"> ▪ The value of the <code>isClone</code> attribute is <code>true</code>, and the value of the <code>status</code> attribute is <code>COPY</code>, <code>RCPY</code>, <code>SMPP</code>, or <code>PSUP</code>. ▪ The value of the <code>canCascade</code> attribute is <code>true</code>, and the value of the <code>status</code> attribute is <code>COPY</code>, <code>RCPY</code>, <code>SMPP</code>, or <code>PSUP</code>. |
| <code>isConsistencyGroup</code> | boolean | <p>Returns whether the pair was created in the consistency group mode (CTG mode).</p> <ul style="list-style-type: none"> ▪ <code>true</code>: The pair was created in the CTG mode. ▪ <code>false</code>: The pair was not created in the CTG mode. |
| <code>isWrittenInSvol</code> | boolean | <p>Returns whether data was written to the S-VOL from the host when the pair status was <code>PSUS/PFUS</code>.</p> <ul style="list-style-type: none"> ▪ <code>true</code>: Data was written to the S-VOL ▪ <code>false</code>: Data was not written to the S-VOL <p>If the target pair is a Thin Image pair that does not have an S-VOL, <code>false</code> is displayed.</p> |
| <code>isClone</code> | boolean | <p>Returns whether the pair has the clone attribute.</p> <ul style="list-style-type: none"> ▪ <code>true</code>: The pair has the clone attribute. ▪ <code>false</code>: The pair does not have the clone attribute. |
| <code>canCascade</code> | boolean | <p>Returns whether the pair can be a cascaded pair.</p> <ul style="list-style-type: none"> ▪ <code>true</code>: The pair can be a cascaded pair. ▪ <code>false</code>: The pair cannot be a cascaded pair. |
| <code>splitTime</code> | string | <p>Time when snapshot data was created</p> <p>The local time of the storage system is returned in YYYY-MM-DDThh:mm:ss format.</p> |
| <code>snapshotId</code> | string | <p>Object ID of the Thin Image pair</p> <p>The following attributes are output, separated by commas:</p> <ul style="list-style-type: none"> ▪ <code>pvolLdevId</code> ▪ <code>muNumber</code> |

| Attribute | Type | Description |
|----------------------|---------|---|
| pvolProcessingStatus | string | Processing status of the pair <ul style="list-style-type: none"> E: The expansion processing is in progress. N: The expansion processing is not in progress. This attribute is output when the value of the <code>primaryOrSecondary</code> attribute is P-VOL. |
| svolProcessingStatus | string | Processing status of the pair <ul style="list-style-type: none"> E: The expansion processing is in progress. N: The expansion processing is not in progress. This attribute is output when the value of the <code>primaryOrSecondary</code> attribute is S-VOL. |
| snapshotDataReadOnly | boolean | Returns whether the snapshot data is a pair that has the read-only attribute <ul style="list-style-type: none"> true: Read-only false: Not read-only |

If you run the request with `pair` specified for the query parameter `detailInfoType`, you can get the following information, in addition to a list of snapshot groups. If multiple pairs exist, the information is output in ascending order of the LDEV number and MU number of the primary volume.

| Attribute | Type | Description |
|-----------|----------|---|
| snapshots | object[] | Outputs the following attributes related to Thin Image pairs contained in the snapshot group. <ul style="list-style-type: none"> snapshotGroupName (string) Name of the snapshot group status (string) Pair status For details, see the section explaining on pair status (Thin Image). pvolLdevId (int) LDEV number of P-VOL muNumber (int) MU number of the P-VOL |

| Attribute | Type | Description |
|-----------|------|--|
| | | <ul style="list-style-type: none"> <li data-bbox="792 254 1424 422"> <p>▪ <code>svolDevId</code> (int) LDEV number of S-VOL This attribute is displayed if the target pair is a Thin Image pair that has an S-VOL.</p> <li data-bbox="792 436 1424 548"> <p>▪ <code>snapshotPoolId</code> (int) ID of the pool in which the snapshot data is created</p> <li data-bbox="792 562 1424 737"> <p>▪ <code>concordanceRate</code> (int) Concordance rate for pairs This attribute is displayed if the pair status is not SMPL.</p> <li data-bbox="792 751 1424 1010"> <p>▪ <code>isConsistencyGroup</code> (boolean) Returns whether the pair was created in the consistency group mode (CTG mode).</p> <ul style="list-style-type: none"> <li data-bbox="829 898 1424 926">• <code>true</code>: The pair was created in the CTG mode. <li data-bbox="829 947 1424 1010">• <code>false</code>: The pair was not created in the CTG mode. <li data-bbox="792 1024 1424 1283"> <p>▪ <code>isWrittenInSvol</code> (boolean) Returns whether data was written to the S-VOL from the host when the pair status was <code>PSUS/</code> <code>PFUS</code>.</p> <ul style="list-style-type: none"> <li data-bbox="829 1213 1424 1241">• <code>true</code>: Data was written to the S-VOL <li data-bbox="829 1262 1424 1283">• <code>false</code>: Data was not written to the S-VOL <p>If the target pair is a Thin Image pair that does not have an S-VOL, <code>false</code> is displayed.</p> <li data-bbox="792 1297 1424 1598"> <p>▪ <code>isClone</code> (boolean) Returns whether the pair has the clone attribute.</p> <ul style="list-style-type: none"> <li data-bbox="829 1507 1424 1535">• <code>true</code>: The pair has the clone attribute. <li data-bbox="829 1556 1424 1598">• <code>false</code>: The pair does not have the clone attribute. <li data-bbox="792 1612 1424 1808"> <p>▪ <code>canCascade</code> (boolean) Returns whether the pair can be a cascaded pair.</p> <ul style="list-style-type: none"> <li data-bbox="829 1745 1424 1772">• <code>true</code>: The pair can be a cascaded pair. <li data-bbox="829 1793 1424 1808">• <code>false</code>: The pair cannot be a cascaded pair. |

| Attribute | Type | Description |
|-----------|------|---|
| | | <ul style="list-style-type: none"> <li data-bbox="792 254 1414 541"> ▪ splitTime (string) Time when snapshot data was created This attribute is displayed if the pair status is PSUS, PFUS, or PSUP. The storage system time in Greenwich Mean Time (GMT) is displayed in the YYYY-MM-DDThh:mm:ss format. <li data-bbox="792 562 1414 829"> ▪ snapshotId (string) Object ID of the Thin Image pair The following attributes are output, separated by commas: <ul style="list-style-type: none"> <li data-bbox="829 745 1031 772">• pvolldevId <li data-bbox="829 793 998 821">• muNumber |

Status codes

For details on the status codes of the request for this operation, see the description on HTTP status codes.

Coding example

```
curl -v -H "Accept: application/json" -H "Authorization:Session
d7b673af189048468c5af9bcf3bbbb6f" -X GET https://192.0.2.100/
ConfigurationManager/v1/objects/snapshot-groups
```

Getting information about Thin Image pairs in a specified snapshot group

The following request gets information about Thin Image pairs in units of snapshot groups. Use this information to check the information that is necessary for performing pair operations (for example, the pair status).

Execution permission

Storage Administrator (View Only)

Request line

```
GET base-URL/v1/objects/snapshot-groups/object-ID
```

Request message**Object ID**

Specify the `snapshotGroupId` value obtained by getting information about the snapshot groups.

| Attribute | Type | Description |
|-----------------|--------|---|
| snapshotGroupId | string | (Required) Object ID of the snapshot group. Specify a character string consisting of 1 to 32 characters. The name is case sensitive. |

Query parameters

None.

Body

None.

Response message**Body**

```
{
  "snapshotGroupName" : "snapshotGroup",
  "snapshotGroupId" : "snapshotGroup",
  "snapshots" : [ {
    "snapshotGroupName": "snapshotGroup",
    "primaryOrSecondary": "P-VOL",
    "status": "PSUS",
    "pvolLdevId": 100,
    "muNumber": 3,
    "svolLdevId": 101,
    "snapshotPoolId": 10,
    "concordanceRate": 100,
    "isConsistencyGroup": true,
    "isWrittenInSvol": false,
    "isClone": false,
    "canCascade": false,
    "splitTime": "2015-03-20T09:27:35",
    "snapshotId": "100,3",
    "pvolProcessingStatus": "N",
    "snapshotDataReadOnly": false
  }, {
    "snapshotGroupName": "snapshotGroup",
    "primaryOrSecondary": "P-VOL",
    "status": "PSUS",
    "pvolLdevId": 100,
```

```

"muNumber": 4,
"snapshotPoolId": 10,
"concordanceRate": 100,
"isConsistencyGroup": true,
"isWrittenInSvol": false,
"isClone": false,
"canCascade": false,
"splitTime": "2015-03-20T09:27:35",
"snapshotId": "100,4",
"pvolProcessingStatus": "N",
"snapshotDataReadOnly": false
} ]
}

```

| Attribute | Type | Description |
|-------------------|----------|--|
| snapshotGroupName | string | Name of the snapshot group that contains the Thin Image pairs. If the name of the snapshot group contains spaces, information about pairs is not output. |
| snapshotGroupId | string | Object ID of the snapshot group |
| snapshots | object[] | Outputs the following attributes related to Thin Image pairs contained in the snapshot group. <ul style="list-style-type: none"> ▪ snapshotGroupName (string) Name of the snapshot group ▪ primaryOrSecondary (string) Attribute of the LDEV ▪ status (string) Pair status For details, see the section explaining on pair status (Thin Image). ▪ pvolLdevId (int) LDEV number of P-VOL ▪ muNumber (int) MU number of the P-VOL ▪ svolLdevId (int) LDEV number of S-VOL |

| Attribute | Type | Description |
|-----------|------|--|
| | | <ul style="list-style-type: none"> <li data-bbox="792 254 1425 365"> <p>▪ snapshotPoolId (int) ID of the pool in which the snapshot data is created</p> <li data-bbox="792 390 1425 926"> <p>▪ concordanceRate (int) Concordance rate for pairs This attribute is output when any of the following conditions are met:</p> <ul style="list-style-type: none"> <li data-bbox="829 575 1425 674">• The value of the <code>isClone</code> attribute is <code>false</code>, and the value of the <code>canCascade</code> attribute is also <code>false</code>. <li data-bbox="829 699 1425 798">• The value of the <code>isClone</code> attribute is <code>true</code>, and the value of the <code>status</code> attribute is not <code>COPY</code>, <code>RCPY</code>, <code>SMPP</code>, or <code>PSUP</code>. <li data-bbox="829 823 1425 921">• The value of the <code>canCascade</code> attribute is <code>true</code>, and the value of <code>status</code> attribute is not <code>COPY</code>, <code>RCPY</code>, <code>SMPP</code>, or <code>PSUP</code>. <li data-bbox="792 951 1425 1633"> <p>▪ progressRate (int) Progress of the processing This attribute is output when either of the following conditions is met:</p> <ul style="list-style-type: none"> <li data-bbox="829 1136 1425 1234">▪ The value of the <code>isClone</code> attribute is <code>true</code>, and the value of the <code>status</code> attribute is <code>COPY</code>, <code>RCPY</code>, <code>SMPP</code>, or <code>PSUP</code>. <li data-bbox="829 1260 1425 1358">▪ The value of the <code>canCascade</code> attribute is <code>true</code>, and the value of the <code>status</code> attribute is <code>COPY</code>, <code>RCPY</code>, <code>SMPP</code>, or <code>PSUP</code>. <p>▪ isConsistencyGroup (boolean) Returns whether the pair was created in the consistency group mode (CTG mode).</p> <ul style="list-style-type: none"> <li data-bbox="829 1522 1425 1549">▪ <code>true</code>: The pair was created in the CTG mode. <li data-bbox="829 1575 1425 1633">▪ <code>false</code>: The pair was not created in the CTG mode. |

| Attribute | Type | Description |
|-----------|------|--|
| | | <ul style="list-style-type: none"> <li data-bbox="792 254 1414 506"> <p>▪ <code>isWrittenInSvol</code> (boolean)</p> <p>Returns whether data was written to the S-VOL from the host when the pair status was <code>PSUS/ PFUS</code>.</p> <ul style="list-style-type: none"> <li data-bbox="829 428 1305 453">▪ <code>true</code>: Data was written to the S-VOL <li data-bbox="829 478 1365 504">▪ <code>false</code>: Data was not written to the S-VOL <p>If the target pair is a Thin Image pair that does not have an S-VOL, <code>false</code> is displayed.</p> <li data-bbox="792 617 1398 835"> <p>▪ <code>isClone</code> (boolean)</p> <p>Returns whether the pair has the clone attribute.</p> <ul style="list-style-type: none"> <li data-bbox="829 720 1321 745">▪ <code>true</code>: The pair has the clone attribute. <li data-bbox="829 770 1349 835">▪ <code>false</code>: The pair does not have the clone attribute. <li data-bbox="792 856 1409 1041"> <p>▪ <code>canCascade</code> (boolean)</p> <p>Returns whether the pair can be a cascaded pair.</p> <ul style="list-style-type: none"> <li data-bbox="829 959 1333 984">▪ <code>true</code>: The pair can be a cascaded pair. <li data-bbox="829 1010 1386 1035">▪ <code>false</code>: The pair cannot be a cascaded pair. <li data-bbox="792 1062 1393 1226"> <p>▪ <code>splitTime</code> (string)</p> <p>Time when snapshot data was created</p> <p>The local time of the storage system is returned in <code>YYYY-MM-DDThh:mm:ss</code> format.</p> <li data-bbox="792 1247 1403 1516"> <p>▪ <code>snapshotId</code> (string)</p> <p>Object ID of the Thin Image pair</p> <p>The following attributes are output, separated by commas:</p> <ul style="list-style-type: none"> <li data-bbox="829 1434 1029 1459">▪ <code>pvolLdevId</code> <li data-bbox="829 1484 997 1509">▪ <code>muNumber</code> <li data-bbox="792 1537 1382 1839"> <p>▪ <code>pvolProcessingStatus</code> (string)</p> <p>Processing status of the pair</p> <ul style="list-style-type: none"> <li data-bbox="829 1640 1382 1665">• <code>E</code>: The expansion processing is in progress. <li data-bbox="829 1690 1305 1755">• <code>N</code>: The expansion processing is not in progress. <p>This attribute is output when the value of the <code>primaryOrSecondary</code> attribute is <code>P-VOL</code>.</p> |

| Attribute | Type | Description |
|-----------|------|--|
| | | <ul style="list-style-type: none"> ▪ <code>svolProcessingStatus</code> (string) Processing status of the pair <ul style="list-style-type: none"> • <code>E</code>: The expansion processing is in progress. • <code>N</code>: The expansion processing is not in progress. <p>This attribute is output when the value of the <code>primaryOrSecondary</code> attribute is <code>S-VOL</code>.</p> ▪ <code>snapshotDataReadOnly</code> (boolean) Returns whether the snapshot data is a pair that has the read-only attribute <ul style="list-style-type: none"> • <code>true</code>: Read-only • <code>false</code>: Not read-only |

Status codes

For details on the status codes of the request for this operation, see the description on HTTP status codes.

Coding example

```
curl -v -H "Accept: application/json" -H "Authorization:Session
d7b673af189048468c5af9bcf3bbbbb6f" -X GET https://192.0.2.100/
ConfigurationManager/v1/objects/snapshot-groups/snapshotGroup
```

Getting information about Thin Image pairs

The following request gets a list of information about Thin Image pairs. Use this information to check the information that is necessary for performing pair operations (for example, the pair status).

Execution permission

Storage Administrator (View Only)

Request line

```
GET base-URL/v1/objects/snapshots
```

Request message**Object ID**

None.

Query parameters

| Parameter | Type | Filter Condition |
|-------------------|--------|--|
| snapshotGroupName | string | (Optional) Specify the name of the snapshot group that contains the Thin Image pairs. Specify a character string consisting of 1 to 32 characters. |
| pvolLdevId | int | (Optional) Specify the LDEV number of the P-VOL of the Thin Image pair. Specify a decimal (base 10) number equal to or greater than 0. |
| svolLdevId | int | (Optional) Specify the LDEV number of the S-VOL of the Thin Image pair. If the S-VOL exists, specify a decimal (base 10) number equal to or greater than 0. |
| muNumber | int | (Optional) Specify the MU number of the P-VOL of the Thin Image pair. Specify a value in the range from 0 to 1023. |

The following shows how to specify parameters:

- The LDEV number of the P-VOL and the snapshot group name
- The LDEV number and the MU number of the P-VOL
- Only the LDEV number of the P-VOL
- If the secondary volume exists, only the LDEV number of the S-VOL

If no parameters are specified, an error occurs.

Body

None.

Response message**Body**

If information about multiple Thin Image pairs is obtained, the information is output in ascending order of the LDEV number and MU number of the primary volume.

The following is an output example of Thin Image pair information obtained by specifying the LDEV number of the primary volume and the snapshot group name:

```
{
  "data": [
    {
      "snapshotGroupName": "snapshotGroup",
      "primaryOrSecondary": "P-VOL",
      "status": "PSUS",
      "pvolLdevId": 100,
      "muNumber": 3,
      "svolLdevId": 101,
      "snapshotPoolId": 10,
      "concordanceRate": 100,
      "isConsistencyGroup": true,
      "isWrittenInSvol": false,
      "isClone": false,
      "canCascade": false,
      "splitTime": "2015-03-20T09:27:35",
      "snapshotId": "100,3",
      "pvolProcessingStatus": "N",
      "snapshotDataReadOnly": false
    },
    {
      "snapshotGroupName": "snapshotGroup",
      "primaryOrSecondary": "P-VOL",
      "status": "PSUS",
      "pvolLdevId": 100,
      "muNumber": 4,
      "snapshotPoolId": 10,
      "concordanceRate": 100,
      "isConsistencyGroup": true,
      "isWrittenInSvol": false,
      "isClone": false,
      "canCascade": false,
      "splitTime": "2015-03-20T09:27:35",
      "snapshotId": "100,4",
      "pvolProcessingStatus": "N",
      "snapshotDataReadOnly": false
    }
  ]
}
```

The following is an output example of Thin Image pair information obtained by specifying the LDEV number and the MU number of the primary volume:

```
{
  "data": [
    {
```

```

    "snapshotGroupName": "snapshotGroup",
    "primaryOrSecondary": "P-VOL",
    "status": "PSUS",
    "pvolLdevId": 100,
    "muNumber": 3,
    "svolLdevId": 101,
    "snapshotPoolId": 10,
    "concordanceRate": 100,
    "isConsistencyGroup": true,
    "isWrittenInSvol": false,
    "isClone": false,
    "canCascade": false,
    "splitTime": "2015-03-20T09:27:35",
    "snapshotId": "100,3",
    "pvolProcessingStatus": "N",
    "snapshotDataReadOnly": false
  }
]
}

```

The following is an output example of Thin Image pair information obtained by specifying the LDEV number of the primary volume:

```

{
  "data": [
    {
      "snapshotGroupName": "snapshotGroup",
      "primaryOrSecondary": "P-VOL",
      "status": "PSUS",
      "pvolLdevId": 100,
      "muNumber": 3,
      "svolLdevId": 101,
      "snapshotPoolId": 10,
      "concordanceRate": 100,
      "isConsistencyGroup": true,
      "isWrittenInSvol": false,
      "isClone": false,
      "canCascade": false,
      "splitTime": "2015-03-20T09:27:35",
      "snapshotId": "100,3",
      "pvolProcessingStatus": "N",
      "snapshotDataReadOnly": false
    },
    {
      "snapshotGroupName": "snapshotGroup",
      "primaryOrSecondary": "P-VOL",
      "status": "PSUS",
      "pvolLdevId": 100,
      "muNumber": 4,

```

```

    "snapshotPoolId": 10,
    "concordanceRate": 100,
    "isConsistencyGroup": true,
    "isWrittenInSvol": false,
    "isClone": false,
    "canCascade": false,
    "splitTime": "2015-03-20T09:27:35",
    "snapshotId": "100,4",
    "pvolProcessingStatus": "N",
    "snapshotDataReadOnly": false
  }
]
}

```

The following is an output example of Thin Image pair information obtained by specifying the LDEV number of the secondary volume:

```

{
  "data": [
    {
      "snapshotGroupName": "snapshotGroup",
      "primaryOrSecondary": "P-VOL",
      "status": "PSUS",
      "pvolLdevId": 100,
      "muNumber": 3,
      "svolLdevId": 101,
      "snapshotPoolId": 10,
      "concordanceRate": 100,
      "isConsistencyGroup": true,
      "isWrittenInSvol": false,
      "isClone": false,
      "canCascade": false,
      "splitTime": "2015-03-20T09:27:35",
      "snapshotId": "100,3",
      "pvolProcessingStatus": "N",
      "snapshotDataReadOnly": false
    }
  ]
}

```

| Attribute | Type | Description |
|-----------------------|--------|---|
| snapshotGroupNa me | string | Name of the snapshot group that contains the Thin Image pairs. If the name of the snapshot group contains spaces, information about pairs is not output. |

| Attribute | Type | Description |
|--------------------|---------|---|
| primaryOrSecondary | string | Attribute of the LDEV |
| status | string | Pair status For details, see the section explaining on pair status (Thin Image). |
| pvolLdevId | int | LDEV number of P-VOL |
| muNumber | int | MU number of the P-VOL |
| svolLdevId | int | LDEV number of S-VOL |
| snapshotPoolId | int | ID of the pool in which the snapshot data is created |
| concordanceRate | int | Concordance rate for pairs This attribute is output when any of the following conditions are met: <ul style="list-style-type: none"> The value of the <code>isClone</code> attribute is <code>false</code>, and the value of the <code>canCascade</code> attribute is also <code>false</code>. The value of the <code>isClone</code> attribute is <code>true</code>, and the value of the <code>status</code> attribute is not <code>COPY</code>, <code>RCPY</code>, <code>SMPP</code>, or <code>PSUP</code>. The value of the <code>canCascade</code> attribute is <code>true</code>, and the value of <code>status</code> attribute is not <code>COPY</code>, <code>RCPY</code>, <code>SMPP</code>, or <code>PSUP</code>. |
| progressRate | int | Progress of the processing This attribute is output when either of the following conditions is met: <ul style="list-style-type: none"> The value of the <code>isClone</code> attribute is <code>true</code>, and the value of the <code>status</code> attribute is <code>COPY</code>, <code>RCPY</code>, <code>SMPP</code>, or <code>PSUP</code>. The value of the <code>canCascade</code> attribute is <code>true</code>, and the value of the <code>status</code> attribute is <code>COPY</code>, <code>RCPY</code>, <code>SMPP</code>, or <code>PSUP</code>. |
| isConsistencyGroup | boolean | Returns whether the pair was created in the consistency group mode (CTG mode). <ul style="list-style-type: none"> <code>true</code>: The pair was created in the CTG mode. <code>false</code>: The pair was not created in the CTG mode. |

| Attribute | Type | Description |
|----------------------|---------|---|
| isWrittenInSvol | boolean | Returns whether data was written to the S-VOL from the host when the pair status was <code>PSUS/PFUS</code> . <ul style="list-style-type: none"> <code>true</code>: Data was written to the S-VOL <code>false</code>: Data was not written to the S-VOL If the target pair is a Thin Image pair that does not have an S-VOL, <code>false</code> is displayed. |
| isClone | boolean | Returns whether the pair has the clone attribute. <ul style="list-style-type: none"> <code>true</code>: The pair has the clone attribute. <code>false</code>: The pair does not have the clone attribute. |
| canCascade | boolean | Returns whether the pair can be a cascaded pair. <ul style="list-style-type: none"> <code>true</code>: The pair can be a cascaded pair. <code>false</code>: The pair cannot be a cascaded pair. |
| splitTime | string | Time when snapshot data was created The local time of the storage system is returned in YYYY-MM-DDThh:mm:ss format. |
| snapshotId | string | Object ID of the Thin Image pair The following attributes are output, separated by commas: <ul style="list-style-type: none"> <code>pvolLdevId</code> <code>muNumber</code> |
| pvolProcessingStatus | string | Processing status of the pair <ul style="list-style-type: none"> <code>E</code>: The expansion processing is in progress. <code>N</code>: The expansion processing is not in progress. This attribute is output when the value of the <code>primaryOrSecondary</code> attribute is <code>P-VOL</code> . |
| svolProcessingStatus | string | Processing status of the pair <ul style="list-style-type: none"> <code>E</code>: The expansion processing is in progress. <code>N</code>: The expansion processing is not in progress. This attribute is output when the value of the <code>primaryOrSecondary</code> attribute is <code>S-VOL</code> . |

| Attribute | Type | Description |
|-----------------------|---------|--|
| snapshotDataRead Only | boolean | Returns whether the snapshot data is a pair that has the read-only attribute <ul style="list-style-type: none"> ▪ true: Read-only ▪ false: Not read-only |

Status codes

For details on the status codes of the request for this operation, see the description on HTTP status codes.

Coding example

When the LDEV number of the P-VOL and the snapshot group name are specified:

```
curl -v -H "Accept: application/json" -H "Authorization:Session
d7b673af189048468c5af9bcf3bbbb6f" -X GET "https://192.0.2.100/
ConfigurationManager/v1/objects/snapshots?
pvolldevId=100&snapshotGroupName=snapshotGroup"
```

When the LDEV number and the MU number of the P-VOL are specified:

```
curl -v -H "Accept: application/json" -H "Authorization:Session
d7b673af189048468c5af9bcf3bbbb6f" -X GET "https://192.0.2.100/
ConfigurationManager/v1/objects/snapshots?pvolldevId=100&muNumber=3"
```

When only the LDEV number of the P-VOL is specified:

```
curl -v -H "Accept: application/json" -H "Authorization:Session
d7b673af189048468c5af9bcf3bbbb6f" -X GET https://192.0.2.100/
ConfigurationManager/v1/objects/snapshots?pvolldevId=100
```

If the secondary volume exists, when only the LDEV number of the S-VOL is specified:

```
curl -v -H "Accept: application/json" -H "Authorization:Session
d7b673af189048468c5af9bcf3bbbb6f" -X GET https://192.0.2.100/
ConfigurationManager/v1/objects/snapshots?svolldevId=101
```

Getting information about a specific Thin Image pair

The following request gets information about the specified Thin Image pair. Use this information to check the information that is necessary for performing pair operations (for example, the pair status).

Execution permission

Storage Administrator (View Only)

Request lineGET *base-URL/v1/objects/snapshots/object-ID***Request message****Object ID**

Specify the `snapshotId` value obtained by getting information about Thin Image pairs. You can also specify the following attributes and connect them with commas:

pvolLdevId,muNumber

| Attribute | Type | Description |
|------------|------|---|
| pvolLdevId | int | (Required) Specify the LDEV number of the P-VOL of the Thin Image pair. Specify a decimal (base 10) number equal to or greater than 0. |
| muNumber | int | (Required) Specify the MU number of the P-VOL of the Thin Image pair. Specify a value in the range from 0 to 1023. |

Query parameters

None.

Body

None.

Response message**Body**

```
{
  "snapshotGroupName": "snapshotGroup",
  "primaryOrSecondary": "P-VOL",
  "status": "PSUS",
  "pvolLdevId": 100,
  "muNumber": 3,
  "svolLdevId": 101,
  "snapshotPoolId": 10,
  "concordanceRate": 100,
  "isConsistencyGroup": true,
```



```

"isWrittenInSvol": false,
"isClone": false,
"canCascade": false,
"splitTime": "2015-03-20T09:27:35",
"snapshotId": "100,3",
"pvolProcessingStatus": "N",
"snapshotDataReadOnly": false
}

```

| Attribute | Type | Description |
|--------------------|--------|---|
| snapshotGroupName | string | Name of the snapshot group that contains the Thin Image pairs. If the name of the snapshot group contains spaces, information about pairs is not output. |
| primaryOrSecondary | string | Attribute of the LDEV |
| status | string | Pair status For details, see the section explaining on pair status (Thin Image). |
| pvolLdevId | int | LDEV number of P-VOL |
| muNumber | int | MU number of the P-VOL |
| svolLdevId | int | LDEV number of S-VOL |
| snapshotPoolId | int | ID of the pool in which the snapshot data is created |
| concordanceRate | int | Concordance rate for pairs This attribute is output when any of the following conditions are met: <ul style="list-style-type: none"> ▪ The value of the <code>isClone</code> attribute is <code>false</code>, and the value of the <code>canCascade</code> attribute is also <code>false</code>. ▪ The value of the <code>isClone</code> attribute is <code>true</code>, and the value of the <code>status</code> attribute is not <code>COPY</code>, <code>RCPY</code>, <code>SMPP</code>, or <code>PSUP</code>. ▪ The value of the <code>canCascade</code> attribute is <code>true</code>, and the value of <code>status</code> attribute is not <code>COPY</code>, <code>RCPY</code>, <code>SMPP</code>, or <code>PSUP</code>. |
| progressRate | int | Progress of the processing |

| Attribute | Type | Description |
|---------------------------------|---------|---|
| | | <p>This attribute is output when either of the following conditions is met:</p> <ul style="list-style-type: none"> The value of the <code>isClone</code> attribute is <code>true</code>, and the value of the <code>status</code> attribute is <code>COPY</code>, <code>RCPY</code>, <code>SMPP</code>, or <code>PSUP</code>. The value of the <code>canCascade</code> attribute is <code>true</code>, and the value of the <code>status</code> attribute is <code>COPY</code>, <code>RCPY</code>, <code>SMPP</code>, or <code>PSUP</code>. |
| <code>isConsistencyGroup</code> | boolean | <p>Returns whether the pair was created in the consistency group mode (CTG mode).</p> <ul style="list-style-type: none"> <code>true</code>: The pair was created in the CTG mode. <code>false</code>: The pair was not created in the CTG mode. |
| <code>isWrittenInSvol</code> | boolean | <p>Returns whether data was written to the S-VOL from the host when the pair status was <code>PSUS/PFUS</code>.</p> <ul style="list-style-type: none"> <code>true</code>: Data was written to the S-VOL <code>false</code>: Data was not written to the S-VOL <p>If the target pair is a Thin Image pair that does not have an S-VOL, <code>false</code> is displayed.</p> |
| <code>isClone</code> | boolean | <p>Returns whether the pair has the clone attribute.</p> <ul style="list-style-type: none"> <code>true</code>: The pair has the clone attribute. <code>false</code>: The pair does not have the clone attribute. |
| <code>canCascade</code> | boolean | <p>Returns whether the pair can be a cascaded pair.</p> <ul style="list-style-type: none"> <code>true</code>: The pair can be a cascaded pair. <code>false</code>: The pair cannot be a cascaded pair. |
| <code>splitTime</code> | string | <p>Time when snapshot data was created</p> <p>The local time of the storage system is returned in YYYY-MM-DDThh:mm:ss format.</p> |
| <code>snapshotId</code> | string | <p>Object ID of the Thin Image pair</p> <p>The following attributes are output, separated by commas:</p> <ul style="list-style-type: none"> <code>pvolDevId</code> <code>muNumber</code> |

| Attribute | Type | Description |
|----------------------|---------|---|
| pvolProcessingStatus | string | Processing status of the pair <ul style="list-style-type: none"> E: The expansion processing is in progress. N: The expansion processing is not in progress. This attribute is output when the value of the <code>primaryOrSecondary</code> attribute is P-VOL. |
| svolProcessingStatus | string | Processing status of the pair <ul style="list-style-type: none"> E: The expansion processing is in progress. N: The expansion processing is not in progress. This attribute is output when the value of the <code>primaryOrSecondary</code> attribute is S-VOL. |
| snapshotDataReadOnly | boolean | Returns whether the snapshot data is a pair that has the read-only attribute <ul style="list-style-type: none"> true: Read-only false: Not read-only |

Status codes

For details on the status codes of the request for this operation, see the description on HTTP status codes.

Coding example

```
curl -v -H "Accept: application/json" -H "Authorization:Session
d7b673af189048468c5af9bcf3bbbbb6f" -X GET https://192.0.2.100/
ConfigurationManager/v1/objects/snapshots/100,3
```

Getting information about all of Thin Image pairs

The following request gets information about the Thin Image pairs registered in the target storage system. You can obtain information about all such pairs from the cache of the storage system regardless of whether they are managed by using snapshot groups.



Note:

- This API can be used when the storage system is the VSP 5000 series.
- To get up-to-date information, you must run the API request that refreshes the storage system's cache before running this request. For details, see "Updating the cache of storage system configuration information".

Execution permission

Storage Administrator (View Only)

Request lineGET *base-URL/v1/objects/snapshot-replications***Request message****Object ID**

None.

Query parameters

| Parameter | Type | Description |
|-----------------|------|--|
| startPvolLdevId | int | <p>(Optional) To specify a range of LDEVs, specify the LDEV number of the first LDEV in the range.</p> <p>The P-VOLs in the specified range of LDEVs are searched, and information about the relevant pairs is obtained.</p> <p>Specify a value in the range from 0 to 65279.</p> <p>The value of this parameter must be smaller than that of the endPvolLdevId parameter.</p> <p>If this attribute is omitted, 0 is set.</p> |
| endPvolLdevId | int | <p>(Optional) To specify a range of LDEVs, specify the LDEV number of the last LDEV in the range.</p> <p>The P-VOLs in the specified range of LDEVs are searched, and information about the relevant pairs is obtained.</p> <p>Specify a value in the range from 0 to 65279.</p> <p>The value of this parameter must be greater than that of the startPvolLdevId parameter.</p> <p>If this attribute is omitted, the maximum LDEV number in the storage system is set.</p> |

Body

None.

Response message**Body**

```

{
  "data": [
    {
      "snapshotReplicationId": "20900,3",
      "pvolLdevId": 20900,
      "svolLdevId": 20904,
      "snapshotPoolId": 103,
      "status": "PAIR",
      "concordanceRate": 100,
      "muNumber": 3,
      "isClone": false,
      "canCascade": false
    },
    {
      "snapshotReplicationId": "20912,3",
      "pvolLdevId": 20912,
      "svolLdevId": 20905,
      "snapshotPoolId": 104,
      "status": "PAIR",
      "concordanceRate": 90,
      "muNumber": 3,
      "isClone": false,
      "canCascade": false
    },
    {
      "snapshotReplicationId": "20912,4",
      "pvolLdevId": 20912,
      "svolLdevId": 20906,
      "snapshotPoolId": 104,
      "status": "PAIR",
      "concordanceRate": 80,
      "muNumber": 4,
      "isClone": false,
      "canCascade": false
    }
  ]
}

```

| Attribute | Type | Description |
|-----------------------|--------|----------------------------------|
| snapshotReplicationId | string | Object ID of the Thin Image pair |

| Attribute | Type | Description |
|--------------------|--------|---|
| | | The following attributes are output, separated by commas: <ul style="list-style-type: none"> pvolldevId muNumber |
| snapshotGroupName | string | Name of the snapshot group This attribute is output if the target pair belongs to a snapshot group. |
| pvolldevId | int | LDEV number of P-VOL |
| snapshotPoolId | int | ID of the pool in which the snapshot data was created |
| svolldevId | int | LDEV number of S-VOL This attribute is displayed if the target pair is a Thin Image pair that has an S-VOL. |
| status | string | Pair status <ul style="list-style-type: none"> SMPP COPY PAIR PSUS PFUL PSUE PFUS RCPY PSUP OTHER |
| consistencyGroupId | int | Consistency group ID If no consistency group consists, information is not output. |
| concordanceRate | int | Concordance rate for pairs |
| muNumber | int | MU number of the P-VOL |
| splitTime | string | Time when snapshot data was created The local time of the storage system is returned in YYYY-MM-DDThh:mm:ss format. |

| Attribute | Type | Description |
|------------|---------|--|
| | | This attribute is output if the pair status is PSUS or PSUP. |
| isClone | boolean | Returns whether the pair has the clone attribute. <ul style="list-style-type: none"> ▪ <code>true</code>: The pair has the clone attribute. ▪ <code>false</code>: The pair does not have the clone attribute. |
| canCascade | boolean | Returns whether the pair can be a cascaded pair. <ul style="list-style-type: none"> ▪ <code>true</code>: The pair that is or can be used in a cascade configuration. ▪ <code>false</code>: The pair cannot be a cascaded pair. |

Status codes

For details on the status codes for the request that performs this operation, see the description of HTTP status codes.

Coding example

```
curl -v -H "Accept: application/json" -H "Authorization:Session
d7b673af189048468c5af9bcf3bbbbb6f" -X GET https://192.0.2.100/
ConfigurationManager/v1/objects/snapshot-replications
```

Creating a Thin Image pair

The following request creates a Thin Image pair in the specified snapshot group. After the pair is created, you can get snapshot data or clone the pair.

Execution permission

Storage Administrator (Local Copy)

Request line

```
POST base-URL/v1/objects/snapshots
```

Request message

Object ID

None.

Query parameters

None.

Body

The following is an example of coding used for creating a Thin Image pair.

If the secondary volume does not exist :

```
{
  "snapshotGroupName": "snapshotGroup",
  "snapshotPoolId": 13,
  "pvolLdevId": 100,
  "isConsistencyGroup": true,
  "autoSplit": true,
  "isDataReductionForceCopy": true
}
```

If the secondary volume exists:

```
{
  "snapshotGroupName": "snapshotGroup",
  "snapshotPoolId": 13,
  "pvolLdevId": 100,
  "svolLdevId": 101,
  "isConsistencyGroup": true,
  "autoSplit": true,
  "isDataReductionForceCopy": true
}
```

| Attribute | Type | Description |
|-------------------|--------|---|
| snapshotGroupName | string | (Required) Specify the name of the snapshot group for which the Thin Image pair is to be created. Specify a character string consisting of 1 to 32 characters. The name is case sensitive. If you specify a new group name, a snapshot group is also created at the same time. |
| snapshotPoolId | int | (Required) Specify the ID of the pool in which snapshot data is to be created. Specify the ID of a Thin Image pool or an HDP pool by using a decimal (base 10) number equal to or greater than 0. |
| pvolLdevId | int | (Required) Specify the LDEV number of the P-VOL of the Thin Image pair to be created. |

| Attribute | Type | Description |
|--------------------|---------|--|
| | | Specify a decimal (base 10) number equal to or greater than 0. |
| svollDevId | int | <p>(Optional) Specify the LDEV number of the S-VOL of the Thin Image pair to be created.</p> <p>This item is required when <code>true</code> is specified for the <code>isClone</code> attribute.</p> <p>If you specified <code>true</code> for the <code>isClone</code> attribute or the <code>canCascade</code> attribute, specify the LDEV number of the DP volume.</p> <p>Specify a decimal (base 10) number equal to or greater than 0.</p> <p>If you do not specify this item, a Thin Image pair that does not have the S-VOL will be created.</p> |
| isConsistencyGroup | boolean | <p>(Optional) Regarding the snapshot group for which the Thin Image pair is to be created, specify whether the snapshot group is to be created in the consistency group mode (CTG mode).</p> <ul style="list-style-type: none"> ▪ <code>true</code>: Creates the snapshot group in the CTG mode. ▪ <code>false</code>: Does not create the snapshot group in the CTG mode. <p>If you do not specify this item, <code>false</code> will be set.</p> |
| autoSplit | boolean | <p>(Optional) Specify whether the Thin Image pair is to be split after it is created.</p> <ul style="list-style-type: none"> ▪ <code>true</code>: Splits the pair. ▪ <code>false</code>: Does not split the pair. <p>If you specify <code>true</code>, the pair is split and snapshot data is stored.</p> <p>If you specify <code>true</code> for this attribute, you cannot specify <code>true</code> for the <code>isClone</code> attribute.</p> <p>If you do not specify this item, <code>false</code> will be set.</p> |

| Attribute | Type | Description |
|------------------|---------|--|
| canCascade | boolean | <p>(Optional) Specify whether the pair can be cascaded.</p> <ul style="list-style-type: none"> ▪ <code>true</code>: The pair can be cascaded. ▪ <code>false</code>: The pair cannot be cascaded. <p>If you specify <code>true</code> for the <code>isClone</code> attribute, also specify <code>true</code> for this attribute.</p> <p>If you do not specify this item, the same value as for the <code>isClone</code> attribute will be set.</p> |
| isClone | boolean | <p>(Optional) Specify whether to create a pair that has the clone attribute specified.</p> <ul style="list-style-type: none"> ▪ <code>true</code>: Creates a pair that has the clone attribute specified. ▪ <code>false</code>: Creates a pair that does not have the clone attribute specified. <p>If you specify <code>true</code> for this attribute, do not specify the <code>autoSplit</code> attribute.</p> <p>If you specify <code>true</code> for this attribute, specify <code>true</code> for the <code>canCascade</code> attribute.</p> <p>If you do not specify this item, <code>false</code> will be set.</p> |
| clonesAutomation | boolean | <p>(Optional) Specify whether the pair is to be cloned after the pair is created.</p> <p>You can specify this item when <code>true</code> is specified for the <code>isClone</code> attribute.</p> <ul style="list-style-type: none"> ▪ <code>true</code>: Clones the pair. ▪ <code>false</code>: Does not clone the pair. <p>If you do not specify this item, <code>false</code> will be set.</p> |
| copySpeed | string | <p>(Optional) Specify the copy speed at which the created pair is to be cloned.</p> |

| Attribute | Type | Description |
|--------------------------|---------|--|
| | | <p>You can specify this item when <code>true</code> is specified for both the <code>isClone</code> attribute and the <code>clonesAutomation</code> attribute.</p> <ul style="list-style-type: none"> ▪ <code>slower</code>: Low speed ▪ <code>medium</code>: Medium speed ▪ <code>faster</code>: High speed <p>This item is not case sensitive.</p> <p>If you do not specify this item, <code>medium</code> will be set.</p> |
| isDataReductionForceCopy | boolean | <p>(Optional) Specify whether to forcibly create a pair for a volume for which the capacity saving function (dedupe and compression) is enabled.</p> <p>When creating a pair for a volume for which the capacity saving function is enabled, always specify <code>true</code>.</p> <ul style="list-style-type: none"> ▪ <code>true</code>: Forcibly create a pair for data reduplication volumes.# ▪ <code>false</code>: Do not forcibly create a pair for data reduplication volumes. <p>If you do not specify this item, <code>false</code> will be set.</p> |
| muNumber | int | <p>(Optional) Specify the MU number of the P-VOL of the Thin Image pair to be created.</p> <p>Specify a value in the range from 0 to 1023. You cannot specify a MU number that is already in use.</p> <p>If you do not specify this item, an available MU number will be assigned.</p> |

#: If you create a pair by using volumes for which the capacity saving function (compression or deduplication) is enabled, data that has been compressed or deduplicated will be copied and, as a result, the performance of the copying processing or the I/O performance of the host might decrease. In addition, if `false` is specified for the `autoSplit` attribute, use the status of the target resource rather than the status of the job to check whether the pair has been created.

Response message**Body**

A job object is returned. For details on attributes other than `affectedResources`, see the section explaining job objects.

| Attribute | Description |
|--------------------------------|------------------------------------|
| <code>affectedResources</code> | URL of the created Thin Image pair |

Status codes

For details on the status codes of the request for this operation, see the description on HTTP status codes.

Coding example

```
curl -v -H "Accept: application/json" -H "Content-Type: application/json" -
H "Authorization:Session d7b673af189048468c5af9bcf3b66b6f" -X POST --data-
binary @./InputParameters.json https://192.0.2.100/ConfigurationManager/v1/
objects/snapshots
```

Storing snapshot data in units of snapshot groups

The following request splits the Thin Image pairs in the specified snapshot group. You can split all pairs in that snapshot group and store snapshot data in a batch operation.

Execution permission

Storage Administrator (Local Copy)

Request line

```
POST base-URL/v1/objects/snapshot-groups/object-ID/actions/split/invoke
```

Request message**Object ID**

Specify the `snapshotGroupId` value obtained by getting information about the snapshot groups.

| Attribute | Type | Description |
|------------------------------|--------|--|
| <code>snapshotGroupId</code> | string | (Required) Object ID of the snapshot group to which the Thin Image pairs to be split belong. |

| Attribute | Type | Description |
|-----------|------|--|
| | | Specify a character string consisting of 1 to 32 characters. The name is case sensitive. |

Query parameters

None.

Body

None.

Response message**Body**

A job object is returned. For details on attributes other than `affectedResources`, see the section explaining job objects.

| Attribute | Description |
|--------------------------------|---------------------------------|
| <code>affectedResources</code> | URL of the split snapshot group |

Action template

```
GET base-URL/v1/objects/snapshot-groups/object-ID/actions/split
```

Status codes

The following table describes the meaning of the status code of the request for this operation. For details on other status codes, see the description on HTTP status codes.

| Status codes | Message | Description |
|--------------|---------------------|--|
| 412 | Precondition Failed | This object indicates that the following actions cannot run: actions specified when pairs are split in units of snapshot groups. |

Coding example

To get an action template:

```
curl -v -H "Accept: application/json" -H "Authorization:Session d7b673af189048468c5af9bcf3bbbbb6f" -X GET https://192.0.2.100/ConfigurationManager/v1/objects/snapshot-groups/snapshotGroup/actions/split
```

To run the request after getting an action template:

```
curl -v -H "Content-type: application/json" -H "Accept: application/json" -
H "Authorization:Session d7b673af189048468c5af9bcf3b6bb6f" -X POST
https://192.0.2.100/ConfigurationManager/v1/objects/snapshot-groups/
snapshotGroup/actions/split/invoke -d ""
```

Storing snapshot data

The following request splits the specified Thin Image pair. When the pair is split, snapshot data at the time of the split is stored.

Execution permission

Storage Administrator (Local Copy)

Request line

```
POST base-URL/v1/objects/snapshots/object-ID/actions/split/invoke
```

Request message

Object ID

Specify the `snapshotId` value obtained by getting information about Thin Image pairs. You can also specify the following attributes and connect them with commas:

```
pvolLdevId,muNumber
```

| Attribute | Type | Description |
|-------------------------|------|---|
| <code>pvolLdevId</code> | int | (Required) Specify the LDEV number of the P-VOL of the Thin Image pair to be split. Specify a decimal (base 10) number equal to or greater than 0. |
| <code>muNumber</code> | int | (Required) Specify the MU number of the P-VOL of the Thin Image pair to be split. Specify a value in the range from 0 to 1023. |

Query parameters

None.

Body

None.

Response message**Body**

A job object is returned. For details on attributes other than `affectedResources`, see the section explaining job objects.

| Attribute | Description |
|--------------------------------|----------------------------------|
| <code>affectedResources</code> | URL of the split Thin Image pair |

Action template

```
GET base-URL/v1/objects/snapshots/object-ID/actions/split
```

Status codes

The following table describes the meaning of the status code of the request for this operation. For details on other status codes, see the description on HTTP status codes.

| Status codes | Message | Description |
|--------------|---------------------|--|
| 412 | Precondition Failed | This object indicates that the following actions cannot run: actions specified when pairs are split. |

Coding example

To get an action template:

```
curl -v -H "Accept: application/json" -H "Authorization:Session d7b673af189048468c5af9bcf3bbbb6f" -X GET https://192.0.2.100/ConfigurationManager/v1/objects/snapshots/100,3/actions/split
```

To run the request after getting an action template:

```
curl -v -H "Content-type: application/json" -H "Accept: application/json" -H "Authorization:Session d7b673af189048468c5af9bcf3bbbb6f" -X POST https://192.0.2.100/ConfigurationManager/v1/objects/snapshots/100,3/actions/split/invoke -d ""
```

Resynchronizing Thin Image pair in units of snapshot groups and deleting snapshot data

The following request resynchronizes the Thin Image pairs in the specified snapshot group. When pairs are resynchronized, all snapshot data will be deleted. You can store new snapshot data by specifying the setting to split the resynchronized pair.

Execution permission

Storage Administrator (Local Copy)

Request linePOST *base-URL/v1/objects/snapshot-groups/object-ID/actions/resync/invoke***Request message****Object ID**

Specify the `snapshotGroupId` value obtained by getting information about the snapshot groups.

| Attribute | Type | Description |
|-----------------|--------|---|
| snapshotGroupId | string | (Required) Object ID of the snapshot group to which the Thin Image pairs to be resynchronized belong. Specify a character string consisting of 1 to 32 characters. The name is case sensitive. |

Query parameters

None.

Body

```
{
  "parameters": {
    "autoSplit": false
  }
}
```

| Attribute | Type | Description |
|-----------|---------|--|
| autoSplit | boolean | (Optional) After resynchronization of the Thin Image pairs is complete, specify whether to split the pairs. <ul style="list-style-type: none"> ▪ <code>true</code>: Splits the pair. ▪ <code>false</code>: Does not split the pair. <p>If you specify <code>true</code>, the pairs are split in units of snapshot groups and snapshot data is stored. If you do not specify this item, <code>false</code> will be set.</p> |

Response message**Body**

A job object is returned. For details on attributes other than `affectedResources`, see the section explaining job objects.

| Attribute | Description |
|--------------------------------|--|
| <code>affectedResources</code> | URL of the resynchronized snapshot group |

Action template

```
GET base-URL/v1/objects/snapshot-groups/object-ID/actions/resync
```

Status codes

The following table describes the meaning of the status code of the request for this operation. For details on other status codes, see the description on HTTP status codes.

| Status codes | Message | Description |
|--------------|---------------------|---|
| 412 | Precondition Failed | This object indicates that the following actions cannot run: actions specified during the resynchronization of pairs in units of snapshot groups. |

Coding example

To get an action template:

```
curl -v -H "Accept: application/json" -H "Authorization:Session d7b673af189048468c5af9bcf3bbbb6f" -X GET https://192.0.2.100/ConfigurationManager/v1/objects/snapshot-groups/snapshotGroup/actions/resync
```

To run the request after getting an action template:

```
curl -v -H "Accept: application/json" -H "Content-Type: application/json" -H "Authorization:Session d7b673af189048468c5af9bcf3bbbb6f" -X POST --data-binary @./InputParameters.json https://192.0.2.100/ConfigurationManager/v1/objects/snapshot-groups/snapshotGroup/actions/resync/invoke
```

Resynchronizing a Thin Image pair and deleting snapshot data

The following request uses the specified snapshot data to resynchronize a Thin Image pair. When the pair is resynchronized, all snapshot data will be deleted. You can store new snapshot data by specifying the setting to split the resynchronized pair.

Execution permission

Storage Administrator (Local Copy)

Request line

```
POST base-URL/v1/objects/snapshots/object-ID/actions/resync/invoke
```

Request message

Object ID

Specify the `snapshotId` value obtained by getting information about Thin Image pairs. You can also specify the following attributes and connect them with commas:

```
pvolLdevId, muNumber
```

| Attribute | Type | Description |
|-------------------------|------|--|
| <code>pvolLdevId</code> | int | (Required) LDEV number of the P-VOL of the Thin Image pair to be resynchronized. Specify a decimal (base 10) number equal to or greater than 0. |
| <code>muNumber</code> | int | (Required) MU number of the P-VOL of the Thin Image pair to be resynchronized. Specify a value in the range from 0 to 1023. |

Query parameters

None.

Body

```
{
  "parameters": {
    "autoSplit": false
  }
}
```

| Attribute | Type | Description |
|-----------|---------|---|
| autoSplit | boolean | <p>(Optional) After resynchronization of the Thin Image pairs is complete, specify whether to split the pairs.</p> <ul style="list-style-type: none"> ▪ <code>true</code>: Splits the pair. ▪ <code>false</code>: Does not split the pair. <p>If you specify <code>true</code>, the pair is split and snapshot data is stored. If you do not specify this item, <code>false</code> will be set.</p> |

Response message

Body

A job object is returned. For details on attributes other than `affectedResources`, see the section explaining job objects.

| Attribute | Description |
|--------------------------------|--|
| <code>affectedResources</code> | URL of the resynchronized Thin Image pairs |

Action template

```
GET base-URL/v1/objects/snapshots/object-ID/actions/resync
```

Status codes

The following table describes the meaning of the status code of the request for this operation. For details on other status codes, see the description on HTTP status codes.

| Status codes | Message | Description |
|--------------|---------------------|---|
| 412 | Precondition Failed | This object indicates that the following actions cannot run: actions specified during pair resynchronization. |

Coding example

To get an action template:

```
curl -v -H "Accept: application/json" -H "Authorization:Session d7b673af189048468c5af9bcf3b6bb6f" -X GET https://192.0.2.100/ConfigurationManager/v1/objects/snapshots/100,3/actions/resync
```

To run the request after getting an action template:

```
curl -v -H "Accept: application/json" -H "Content-Type: application/json" -H "Authorization:Session d7b673af189048468c5af9bcf3b66b6f" -X POST --data-binary @./InputParameters.json https://192.0.2.100/ConfigurationManager/v1/objects/snapshots/100,3/actions/resync/invoke
```

Restoring snapshot data in units of snapshot groups

The following request restores the Thin Image pairs contained in the specified snapshot group. When the pairs are restored, the snapshot data for the primary volume is overwritten in units of the specified snapshot group.

Execution permission

Storage Administrator (Local Copy)

Request line

```
POST base-URL/v1/objects/snapshot-groups/object-ID/actions/restore/invoke
```

Request message

Object ID

Specify the `snapshotGroupId` value obtained by getting information about the snapshot groups.

| Attribute | Type | Description |
|-----------------|--------|---|
| snapshotGroupId | string | (Required) Object ID of the snapshot group to which the Thin Image pairs to be restored belong. Specify a character string consisting of 1 to 32 characters. The name is case sensitive. |

Query parameters

None.

Body

```
{
  "parameters": {
    "autoSplit": false
  }
}
```

| Attribute | Type | Description |
|-----------|---------|---|
| autoSplit | boolean | <p>(Optional) After the restore of the Thin Image pairs is complete, specify whether to split the pairs.</p> <ul style="list-style-type: none"> ▪ <code>true</code>: Splits the pair. ▪ <code>false</code>: Does not split the pair. <p>If you specify <code>true</code>, the pairs are split in units of snapshot groups and snapshot data is stored. If you do not specify this item, <code>false</code> will be set.</p> |

Response message

Body

A job object is returned. For details on attributes other than `affectedResources`, see the section explaining job objects.

| Attribute | Description |
|--------------------------------|------------------------------------|
| <code>affectedResources</code> | URL of the restored snapshot group |

Action template

```
GET base-URL/v1/objects/snapshot-groups/object-ID/actions/restore
```

Status codes

The following table describes the meaning of the status code of the request for this operation. For details on other status codes, see the description on HTTP status codes.

| Status codes | Message | Description |
|--------------|---------------------|---|
| 412 | Precondition Failed | This object indicates that the following actions cannot run: actions specified during a restore of pairs in units of snapshot groups. |

Coding example

To get an action template:

```
curl -v -H "Accept: application/json" -H "Authorization:Session d7b673af189048468c5af9bcf3bbbbb6f" -X GET https://192.0.2.100/
```

```
ConfigurationManager/v1/objects/snapshot-groups/snapshotGroup/actions/restore
```

To run the request after getting an action template:

```
curl -v -H "Accept: application/json" -H "Content-Type: application/json" -H "Authorization:Session d7b673af189048468c5af9bcf3b666f" -X POST --data-binary @./InputParameters.json https://192.0.2.100/ConfigurationManager/v1/objects/snapshot-groups/snapshotGroup/actions/restore/invoke
```

Restoring snapshot data

The following request restores a Thin Image pair by using the specified snapshot data. When the pair is restored, the data of the snapshot specified for the primary volume is overwritten.

Execution permission

Storage Administrator (Local Copy)

Request line

```
POST base-URL/v1/objects/snapshots/object-ID/actions/restore/invoke
```

Request message

Object ID

Specify the `snapshotId` value obtained by getting information about Thin Image pairs. You can also specify the following attributes and connect them with commas:

```
pvolLdevId,muNumber
```

| Attribute | Type | Description |
|-------------------------|------|---|
| <code>pvolLdevId</code> | int | (Required) LDEV number of the P-VOL of the Thin Image pair to be restored Specify a decimal (base 10) number equal to or greater than 0. |
| <code>muNumber</code> | int | (Required) MU number of the P-VOL of the Thin Image pair to be restored Specify a value in the range from 0 to 1023. |

Query parameters

None.

Body

```
{
  "parameters": {
    "autoSplit": false
  }
}
```

| Attribute | Type | Description |
|-----------|---------|--|
| autoSplit | boolean | (Optional) After a restore of the Thin Image pairs is complete, specify whether to split the pairs. <ul style="list-style-type: none"> ▪ <code>true</code>: Splits the pair. ▪ <code>false</code>: Does not split the pair. If you specify <code>true</code> , the pair is split and snapshot data is stored. If you do not specify this item, <code>false</code> will be set. |

Response message**Body**

A job object is returned. For details on attributes other than `affectedResources`, see the section explaining job objects.

| Attribute | Description |
|-------------------|-------------------------------------|
| affectedResources | URL of the restored Thin Image pair |

Action template

```
GET base-URL/v1/objects/snapshots/object-ID/actions/restore
```

Status codes

The following table describes the meaning of the status code of the request for this operation. For details on other status codes, see the description on HTTP status codes.

| Status codes | Message | Description |
|--------------|---------------------|---|
| 412 | Precondition Failed | This object indicates that the following actions cannot run: actions specified during a restore of pairs. |

Coding example

To get an action template:

```
curl -v -H "Accept: application/json" -H "Authorization:Session
d7b673af189048468c5af9bcf3b6bb6f" -X GET https://192.0.2.100/
ConfigurationManager/v1/objects/snapshots/100,3/actions/restore
```

To run the request after getting an action template:

```
curl -v -H "Accept: application/json" -H "Content-Type: application/json" -
H "Authorization:Session d7b673af189048468c5af9bcf3b6bb6f" -X POST --data-
binary @./InputParameters.json https://192.0.2.100/ConfigurationManager/v1/
objects/snapshots/100,3/actions/restore/invoke
```

Assigning a secondary volume to snapshot data

The following request assigns a secondary volume to snapshot data of a Thin Image pair.

Execution permission

Storage Administrator (Local Copy)

Request line

```
POST base-URL/v1/objects/snapshots/object-ID/actions/assign-volume/invoke
```

Request message**Object ID**

Specify the `snapshotId` value obtained by getting information about Thin Image pairs. You can also specify the following attributes and connect them with commas:

```
pvolLdevId,muNumber
```

| Attribute | Type | Description |
|-------------------------|------|---|
| <code>pvolLdevId</code> | int | (Required) LDEV number of the P-VOL of a Thin Image pair that has snapshot data Specify a decimal (base 10) number equal to or greater than 0. |
| <code>muNumber</code> | int | (Required) MU number of the P-VOL of a Thin Image pair that has snapshot data Specify a value in the range from 0 to 1023. |

Query parameters

None.

Body

```
{
  "parameters": {
    "svolLdevId": 101
  }
}
```

| Attribute | Type | Description |
|------------|------|---|
| svolLdevId | int | (Required) LDEV number of the S-VOL to be assigned to the snapshot data Specify a decimal (base 10) number equal to or greater than 0. For the S-VOL, specify a virtual volume for Thin Image that was created beforehand. |

Response message**Body**

A job object is returned. For details on attributes other than `affectedResources`, see the section explaining job objects.

| Attribute | Description |
|-------------------|---|
| affectedResources | URL of the Thin Image pair whose S-VOL was assigned |

Action template

```
GET base-URL/v1/objects/snapshots/object-ID/actions/assign-volume
```

Status codes

The following table describes the meaning of the status code of the request for this operation. For details on other status codes, see the description on HTTP status codes.

| Status codes | Message | Description |
|--------------|---------------------|---|
| 412 | Precondition Failed | This object indicates that the following actions cannot run: actions specified during S-VOL assignment. |

Coding example

To get an action template:

```
curl -v -H "Accept: application/json" -H "Authorization:Session
d7b673af189048468c5af9bcf3bbbbb6f" -X GET https://192.0.2.100/
ConfigurationManager/v1/objects/snapshots/100,3/actions/assign-volume
```

To run the request after getting an action template:

```
curl -v -H "Accept: application/json" -H "Content-Type: application/json" -
H "Authorization:Session d7b673af189048468c5af9bcf3bbbbb6f" -X POST --data-
binary @./InputParameters.json https://192.0.2.100/ConfigurationManager/v1/
objects/snapshots/100,3/actions/assign-volume/invoke
```

Unassigning the secondary volume for snapshot data

The following request unassigns the secondary volume for the snapshot data of Thin Image pairs.

Execution permission

Storage Administrator (Local Copy)

Request line

```
POST base-URL/v1/objects/snapshots/object-ID/actions/unassign-volume/invoke
```

Request message**Object ID**

Specify the `snapshotId` value obtained by getting information about Thin Image pairs. You can also specify the following attributes and connect them with commas:

```
pvolLdevId,muNumber
```

| Attribute | Type | Description |
|-------------------------|------|---|
| <code>pvolLdevId</code> | int | (Required) LDEV number of the P-VOL of a Thin Image pair that has snapshot data Specify a decimal (base 10) number equal to or greater than 0. |
| <code>muNumber</code> | int | (Required) MU number of the P-VOL of a Thin Image pair that has snapshot data Specify a value in the range from 0 to 1023. |

Query parameters

None.

Body

None.

Response message**Body**

A job object is returned. For details on attributes other than `affectedResources`, see the section explaining job objects.

| Attribute | Description |
|--------------------------------|---|
| <code>affectedResources</code> | URL of the Thin Image pair whose S-VOL was unassigned |

Action template

```
GET base-URL/v1/objects/snapshots/object-ID/actions/unassign-volume
```

Status codes

The following table describes the meaning of the status code of the request for this operation. For details on other status codes, see the description on HTTP status codes.

| Status codes | Message | Description |
|--------------|---------------------|---|
| 412 | Precondition Failed | This object indicates that the following actions cannot run: actions specified when an S-VOL is unassigned. |

Coding example

To get an action template:

You can check whether the secondary volume of a Thin Image pair that has a specified object ID can be unassigned.

```
curl -v -H "Accept: application/json" -H "Authorization:Session d7b673af189048468c5af9bcf3bbbbb6f" -X GET https://192.0.2.100/ConfigurationManager/v1/objects/snapshots/100,3/actions/unassign-volume
```

To run the request after getting an action template:

```
curl -v -H "Content-type: application/json" -H "Accept: application/json" -H "Authorization:Session d7b673af189048468c5af9bcf3bbbbb6f" -X POST
```

```
https://192.0.2.100/ConfigurationManager/v1/objects/snapshots/100,3/
actions/unassign-volume/invoke -d ""
```

Deleting Thin Image pairs in units of snapshot groups

The following request deletes the Thin Image pairs contained in the specified snapshot group. When the pairs are deleted, all snapshot data is also deleted.

Execution permission

Storage Administrator (Local Copy)

Request line

```
DELETE base-URL/v1/objects/snapshot-groups/object-ID
```

Request message

Object ID

Specify the `snapshotGroupId` value obtained by getting information about the snapshot groups.

| Attribute | Type | Description |
|------------------------------|--------|--|
| <code>snapshotGroupId</code> | string | (Required) Object ID of the snapshot group to which the Thin Image pairs to be deleted belong. Specify a character string consisting of 1 to 32 characters. The name is case sensitive. |

Query parameters

None.

Body

None.

Response message

Body

A job object is returned. For details on attributes other than `affectedResources`, see the section explaining job objects.

| Attribute | Description |
|--------------------------------|-----------------------------------|
| <code>affectedResources</code> | URL of the deleted snapshot group |

Status codes

For details on the status codes of the request for this operation, see the description on HTTP status codes.

Coding example

```
curl -v -H "Accept: application/json" -H "Authorization:Session
d7b673af189048468c5af9bcf3bbbb6f" -X DELETE https://192.0.2.100/
ConfigurationManager/v1/objects/snapshot-groups/snapshotGroup
```

Deleting a Thin Image pair

The following request deletes the specified Thin Image pair. When the pair is deleted, the snapshot data is also deleted.

Execution permission

Storage Administrator (Local Copy)

Request line

```
DELETE base-URL/v1/objects/snapshots/object-ID
```

Request message**Object ID**

Specify the `snapshotId` value obtained by getting information about a Thin Image pair. You can also specify the following attributes and connect them with commas:

```
pvolLdevId,muNumber
```

| Attribute | Type | Description |
|-------------------------|------|---|
| <code>pvolLdevId</code> | int | (Required) Specify the LDEV number of the P-VOL of the Thin Image pair to be deleted. Specify a decimal (base 10) number equal to or greater than 0. |
| <code>muNumber</code> | int | (Required) Specify the MU number of the P-VOL of the Thin Image pair to be deleted. Specify a value in the range from 0 to 1023. |

Query parameters

None.

Body

None.

Response message**Body**

A job object is returned. For details on attributes other than `affectedResources`, see the section explaining job objects.

| Attribute | Description |
|--------------------------------|------------------------------------|
| <code>affectedResources</code> | URL of the deleted Thin Image pair |

Status codes

For details on the status codes of the request for this operation, see the description on HTTP status codes.

Coding example

```
curl -v -H "Accept: application/json" -H "Authorization:Session
d7b673af189048468c5af9bcf3bbbb6f" -X DELETE https://192.0.2.100/
ConfigurationManager/v1/objects/snapshots/100,3
```

Deleting Thin Image pairs by snapshot tree

Forcibly delete all Thin Image pairs in the snapshot tree where the cascade attribute for the pair is enabled. When the pairs are deleted, the snapshot data will also be deleted. Before running this API, we recommend that you check information about the pairs within the snapshot tree to confirm that all pairs within the snapshot tree have been deleted.

**Tip:**

If you use a configuration in which multiple snapshot trees are connected through pairs whose clone attribute is enabled, specify the root volume of the top snapshot tree first and run the API request. This action does not delete pairs in the snapshot trees under the secondary volumes of pairs whose clone attribute is enabled, but changes the statuses of pairs in those snapshot trees to `PSUE`.

Then, specify the root volume of the snapshot tree under the secondary volume, and run the API request.

Execution permission

Storage Administrator (Local Copy)

Request line

```
POST base-URL/v1/services/snapshot-tree/actions/delete/invoke
```

Request message**Object ID**

None.

Query parameters

None.

Body

```
{
  "parameters": {
    "ldevId": 1
  }
}
```

| Attribute | Type | Description |
|-----------|------|---|
| ldevId | int | (Required) LDEV number of the root volume |

Response message**Body**

A job object is returned. For details on attributes other than `affectedResources`, see the section that explains job objects.

| Attribute | Description |
|-------------------|--|
| affectedResources | <p>URL of the root volume</p> <p>By referring to the <code>attributes</code> attribute value, confirm that this is no longer a Thin Image volume.</p> <p>To verify that all pairs within the snapshot tree have been deleted, obtain the pair statuses and volume attributes based on the pair information you confirmed in advance.</p> |

Action template

None.

Status codes

For details about the status codes issued in response to requests for this operation, see the description of HTTP status codes.

Code example

```
curl -v -H "Accept:application/json" -H "Content-Type:application/json" -H
"Authorization:Session d7b673af189048468c5af9bcf3bbbb6f" -X POST --data-
binary @./InputParameters.json https://192.0.2.100/ConfigurationManager/v1/
services/snapshot-tree/actions/delete/invoke
```

Deleting garbage data of all Thin Image pairs in a snapshot tree

You can delete garbage data (defragment the snapshot data area) by specifying the root volume of a snapshot tree. You can stop the processing before the deletion processing is complete. Before running this API request, we recommend that you get volume information to check the usage status of snapshots and the volume of garbage data.

**Note:**

You can use this API request for VSP 5000 series storage systems.

Execution permission

Storage Administrator (Local Copy)

Request line

```
POST base-URL/v1/services/snapshot-tree/actions/delete-garbage-data/invoke
```

Request message**Object ID**

None.

Query parameters

None.

Body

```
{
  "parameters": {
    "ldevId": 66,
    "operationType": "start"
  }
}
```

| Attribute | Type | Description |
|---------------|--------|---|
| ldevId | int | (Required) LDEV number of the root volume |
| operationType | string | (Required) Starts or stops the deletion of garbage data. The following values can be specified: <ul style="list-style-type: none"> ▪ <code>start</code>: Starts the processing for deleting garbage data ▪ <code>stop</code>: Stops the processing for deleting garbage data |

Response message

Body

A job object is returned. For details on attributes other than `affectedResources`, see the section that explains job objects.

| Attribute | Description |
|--------------------------------|--|
| <code>affectedResources</code> | URL of the root volume To check whether garbage data has been deleted from a snapshot tree, do not check the job status. Instead, get the attributes of the volume to check the status of the processing for deleting the garbage data. |

The processing to delete garbage data stops automatically when the remaining amount of garbage data is less than 1 GB.

In some cases, the processing to delete garbage data stops even if the remaining amount of garbage data is 1 GB or more. In such cases, rerun the processing to delete garbage data, so that the remaining amount of garbage data becomes less than 1 GB.

Action template

None.

Status codes

For details about the status codes issued in response to requests for this operation, see the description of HTTP status codes.

Code example

```
curl -v -H "Accept:application/json" -H "Content-Type:application/json" -H "Authorization:Session d7b673af189048468c5af9bcf3b6bb6f" -X POST --data-
```

```
binary @./InputParameters.json https://192.0.2.100/ConfigurationManager/v1/
services/snapshot-tree/actions/delete-garbage-data/invoke
```

Cloning pairs in a specified snapshot group

The following request clones the Thin Image pairs in a specified snapshot group. You can use this request to clone all of the pairs in a snapshot group in a batch operation.

Execution permission

Storage Administrator (Local Copy)

Request line

```
POST base-URL/v1/objects/snapshot-groups/object-ID/actions/clone/invoke
```

Request message

Object ID

Specify the `snapshotGroupId` value obtained by getting information about the snapshot groups.

| Attribute | Type | Description |
|-----------------|--------|--|
| snapshotGroupId | string | (Required) Object ID of the snapshot group to which the Thin Image pairs to be cloned belong Specify a character string consisting of 1 to 32 characters. The name is case sensitive. |

Query parameters

None.

Body

```
{
  "parameters": {
    "copySpeed": "medium"
  }
}
```

| Attribute | Type | Description |
|-----------|--------|------------------------------------|
| copySpeed | string | (Optional) Specify the copy speed. |

| Attribute | Type | Description |
|-----------|------|---|
| | | <p>You can specify the following values:</p> <ul style="list-style-type: none"> ▪ slower: Low speed ▪ medium: Medium speed ▪ faster: High speed <p>This item is not case sensitive.</p> <p>If you do not specify this item, <code>medium</code> will be set.</p> |

Response message

Body

A job object is returned. For details on attributes other than `affectedResources`, see the section explaining job objects.

| Attribute | Description |
|--------------------------------|---|
| <code>affectedResources</code> | URL of the snapshot group that was cloned |

Action template

```
GET base-URL/v1/objects/snapshot-groups/object-ID/actions/clone
```

Status codes

The following table describes the meaning of the status code of the request for this operation. For details on other status codes, see the description on HTTP status codes.

| Status codes | Message | Description |
|--------------|---------------------|--|
| 412 | Precondition Failed | This indicates that the specified snapshot group cannot be cloned. |

Coding example

To get an action template:

```
curl -v -H "Accept: application/json" -H "Authorization:Session
d7b673af189048468c5af9bcf3b6bb6f" -X GET https://192.0.2.100/
ConfigurationManager/v1/objects/snapshot-groups/snapshotGroup/actions/clone
```

To run the request after getting an action template:

```
curl -v -H "Accept: application/json" -H "Authorization:Session
d7b673af189048468c5af9bcf3bbbbb6f" --data-binary @./InputParameters.json -X
POST https://192.0.2.100/ConfigurationManager/v1/objects/snapshot-groups/
snapshotGroup/actions/clone/invoke
```

Cloning a Thin Image pair

The following request clones the specified Thin Image pair.

Execution permission

Storage Administrator (Local Copy)

Request line

```
POST base-URL/v1/objects/snapshots/object-ID/actions/clone/invoke
```

Request message

Object ID

Specify the `snapshotId` value obtained by getting information about Thin Image pairs. You can also specify the following attributes and connect them with commas:

```
pvolLdevId,muNumber
```

| Attribute | Type | Description |
|-------------------------|------|---|
| <code>pvolLdevId</code> | int | (Required) LDEV number of the P-VOL of the Thin Image pair to be cloned Specify a decimal (base 10) number equal to or greater than 0. |
| <code>muNumber</code> | int | (Required) MU number of the P-VOL of the Thin Image pair to be cloned Specify a value in the range from 0 to 1023. |

Query parameters

None.

Body

```
{
  "parameters": {
```

```
"copySpeed": "medium"
}
}
```

| Attribute | Type | Description |
|-----------|--------|---|
| copySpeed | string | <p>(Optional) Specify the copy speed.</p> <p>You can specify the following values:</p> <ul style="list-style-type: none"> ▪ slower: Low speed ▪ medium: Medium speed ▪ faster: High speed <p>This item is not case sensitive.</p> <p>If you do not specify this item, <code>medium</code> will be set.</p> |

Response message

Body

A job object is returned. For details on attributes other than `affectedResources`, see the section explaining job objects.

| Attribute | Description |
|-------------------|--|
| affectedResources | URL of the Thin Image pair that was cloned |

Action template

```
GET base-URL/v1/objects/snapshots/object-ID/actions/clone
```

Status codes

The following table describes the meaning of the status code of the request for this operation. For details on other status codes, see the description on HTTP status codes.

| Status codes | Message | Description |
|--------------|---------------------|--|
| 412 | Precondition Failed | This indicates that the specified pair cannot be cloned. |

Coding example

To get an action template:

```
curl -v -H "Accept: application/json" -H "Authorization:Session  
d7b673af189048468c5af9bcf3bbbb6f" -X GET https://192.0.2.100/  
ConfigurationManager/v1/objects/snapshots/100,3/actions/clone
```

To run the request after getting an action template:

```
curl -v -H "Accept: application/json" -H "Authorization:Session  
d7b673af189048468c5af9bcf3bbbb6f" --data-binary @./InputParameters.json -X  
POST https://192.0.2.100/ConfigurationManager/v1/objects/snapshots/100,3/  
actions/clone/invoke
```

Chapter 10: Configuring a remote copy environment

This chapter describes how to configure a remote copy environment by using the REST API.

Workflow for configuring a remote copy environment

The following describes the workflow for configuring an environment required to use TrueCopy, Universal Replicator, or global-active device (GAD).

The following figure shows the workflow for configuring an environment.

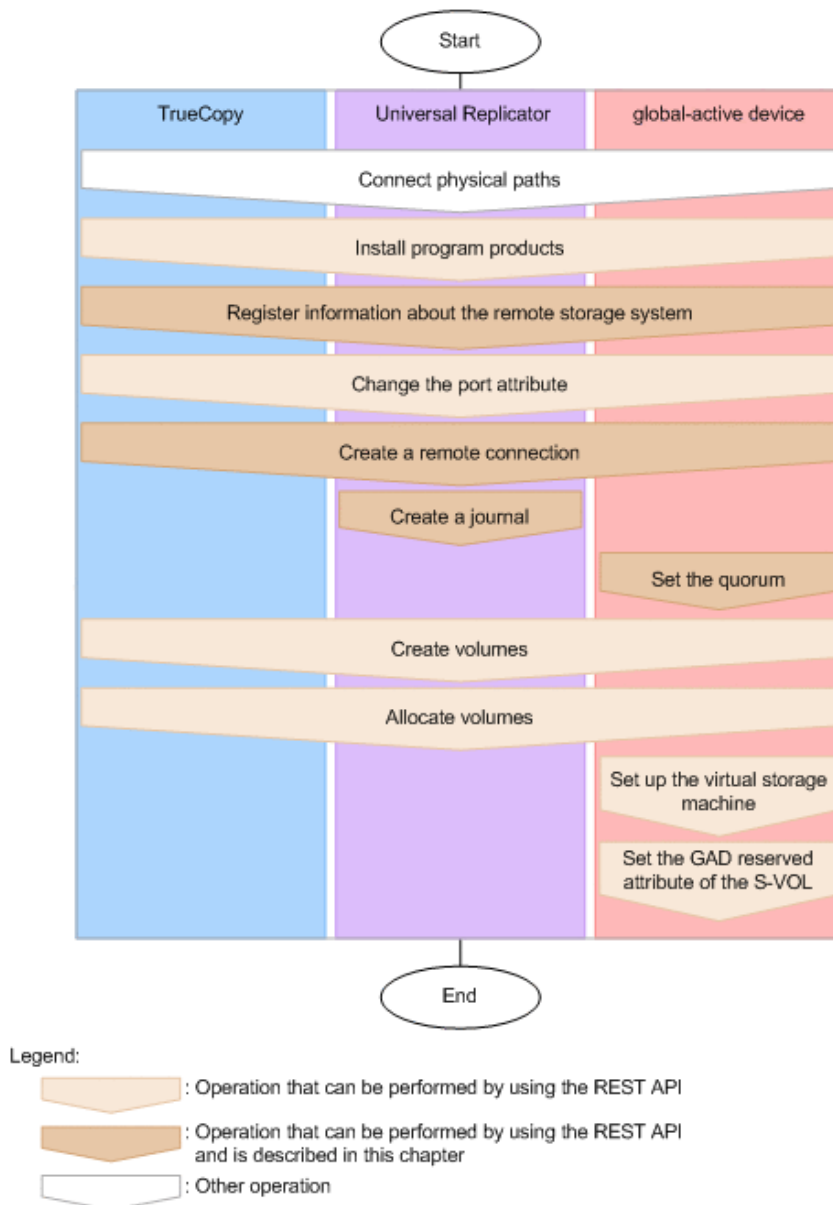

Connecting physical paths

Use cables to connect between hardware objects according to the configuration required for the operation, such as between the host and the storage system, and between the primary site and the secondary site.

Installing software products

Install software products that are required for remote copy operations.

Registering information about the remote storage system

Register information about the remote storage system on the REST API server of the local storage system. At the same time, information about the local storage system can be registered, as the remote storage system, to the REST API server of the remote storage system.

Changing the port attribute

For VSP 5000 series storage systems, you will need to change target ports to bidirectional ports. For VSP E series, VSP G350, G370, G700, G900 storage systems and VSP F350, F370, F700, F900 storage systems, you do not need to change the port attribute.

Creating a remote connection

Create a remote connection by specifying a remote path. If you use an iSCSI port, register in advance the information about the iSCSI port of the remote storage system for the iSCSI port of the local storage system.

Creating a journal

Create a journal by specifying a journal volume.

Setting the quorum

Specify settings related to the quorum.

When creating a global-active device pair, you must configure a quorum regardless of whether you are using configuration where volumes are set for quorum disks or not.

For configurations where volumes are set for quorum disks, first make sure that the following conditions have been met.

- The two storage systems on which the global-active device environment is to be built and the external storage system for the quorum disks are connected by a physical path.
- The volumes on the external storage system for the quorum disks are mapped to the two storage systems on which the global-active device environment is to be built.

Creating volumes

Create volumes to be used for a pair.

Allocating volumes

Set LU paths so that the host can access the volumes in the storage system.

Setting up the virtual storage machine

Create a virtual storage machine in the storage system, and then specify the required settings.

Setting the GAD reserved attribute of S-VOL

For the virtual LDEV number of S-VOL, set the GAD reserved attribute number.

For details on configuring a remote copy environment, see the manual of each software product or *System Administrator Guide*.

Registering and deleting information about remote storage systems

This section describes how to register and delete information about remote storage systems by using the REST API.

Overview of registering and deleting information about remote storage systems

For remote copy, by registering in advance the information about storage systems that are remotely connected to the REST API server, you no longer need to specify the remotely-connected storage system information when the remote copy operation is performed.

Register the following storage system information: model name of the remotely-connected storage system, and the controller IP address and communication mode. The information about the remote storage system will be registered to the REST API server of the local storage system while the information about the local storage system will be registered to the REST API server of the remote storage system.

You can use the following API commands for registering and deleting the information about remote storage systems:

- Registering information about remote storage systems to the REST API server
- Deleting information about remote storage systems from the REST API server
- Obtaining information about remote storage systems registered on the REST API server

Getting a list of remote storage systems

The following request gets a list of information about the storage systems registered on the REST API server.

Execution permission

Storage Administrator (View Only)

Request line

```
GET base-URL/v1/objects/remote-storages
```

Request message

Object ID

None.

Query parameters

None.

Body

None.

Response message**Body**

```

{
  "data": [
    {
      "storageDeviceId": "886000123456",
      "dkcType": "Local",
      "restServerIp": "192.0.2.100",
      "restServerPort": 443,
      "model": "VSP G900",
      "serialNumber": 123456,
      "ctl1Ip": "192.0.10.10",
      "ctl2Ip": "192.0.10.11",
      "communicationModes": [
        {
          "communicationMode": "lanConnectionMode"
        }
      ]
    },
    {
      "storageDeviceId": "886000123457",
      "dkcType": "Remote",
      "restServerIp": "192.0.2.101",
      "restServerPort": 443,
      "model": "VSP G900",
      "serialNumber": 123457,
      "ctl1Ip": "192.0.10.20",
      "ctl2Ip": "192.0.10.21",
      "communicationModes": [
        {
          "communicationMode": "lanConnectionMode"
        }
      ]
    }
  ]
}

```

| Attribute | Type | Description |
|-----------------|--------|-------------------|
| storageDeviceId | string | Storage device ID |

| Attribute | Type | Description |
|--------------------|----------|--|
| dkcType | string | Type of storage system <ul style="list-style-type: none"> ▪ Local: Local storage system (The storage system where the REST API server that received the request exists.) ▪ Remote: Remote storage system (The storage system registered on the REST API server of the local storage system.) |
| restServerIp | string | IP address used by the REST API server of the remote storage system |
| restServerPort | int | Port number used for SSL communication by the REST API server of the remote storage system |
| model | string | Model name of the storage system |
| serialNumber | int | Serial number of the storage system |
| ctl1Ip | string | IP address of controller board 1 This attribute is output for VSP E series, VSP G350, G370, G700, G900, VSP F350, F370, F700, F900. |
| ctl2Ip | string | IP address of controller board 2 This attribute is output for VSP E series, VSP G350, G370, G700, G900, VSP F350, F370, F700, F900. |
| communicationModes | object[] | The following attributes related to the communication mode between the REST API server and the storage system are output: |

| Attribute | Type | Description |
|-----------|------|---|
| | | <p>If multiple communication modes are output, the mode that is output at the top will be prioritized in communication.</p> <ul style="list-style-type: none"> ▪ communicationMode (string) Communication mode ▪ proxyMode ▪ lanConnectionMode ▪ proxies (object[]) The following attributes about the relay server are output: <ul style="list-style-type: none"> ▪ proxyIp (string) IP address ▪ proxyPort (int) Port number |

Status codes

For details on the status codes of the request for this operation, see the description on HTTP status codes.

Coding example

```
curl -v -H "Accept: application/json" -H "Authorization:Session
d7b673af189048468c5af9bcf3bbbbb6f" -X GET https://192.0.2.100/
ConfigurationManager/v1/objects/remote-storages
```

Getting information about a specific remote storage system

The following request gets information about a specific remote storage system registered on the REST API server.

Execution permission

Storage Administrator (View Only)

Request line

```
GET base-URL/v1/objects/remote-storages/object-ID
```

Request message**Object ID**

Specify the `storageDeviceId` value obtained by getting information about the storage systems.

| Attribute | Type | Description |
|------------------------------|--------|------------------------------|
| <code>storageDeviceId</code> | string | (Required) Storage device ID |

Query parameters

None.

Body

None.

Response message**Body**

```
{
  "storageDeviceId": "886000123456",
  "dkcType": "Local",
  "restServerIp": "192.0.2.100",
  "restServerPort": 443,
  "model": "VSP G900",
  "serialNumber": 123456,
  "ctl1Ip": "192.0.10.10",
  "ctl2Ip": "192.0.10.11",
  "communicationModes": [
    {
      "communicationMode": "lanConnectionMode"
    }
  ]
}
```

| Attribute | Type | Description |
|------------------------------|--------|-------------------|
| <code>storageDeviceId</code> | string | Storage device ID |

| Attribute | Type | Description |
|--------------------|----------|--|
| dkcType | string | Type of storage system <ul style="list-style-type: none"> ▪ Local: Local storage system (The storage system where the REST API server that received the request exists.) ▪ Remote: Remote storage system (The storage system registered on the REST API server of the local storage system.) |
| restServerIp | string | IP address used by the REST API server of the remote storage system |
| restServerPort | int | Port number used for SSL communication by the REST API server of the remote storage system |
| model | string | Model name of the storage system |
| serialNumber | int | Serial number of the storage system |
| ctl1Ip | string | IP address of controller board 1 This attribute is output for VSP E series, VSP G350, G370, G700, G900, VSP F350, F370, F700, F900. |
| ctl2Ip | string | IP address of controller board 2 This attribute is output for VSP E series, VSP G350, G370, G700, G900, VSP F350, F370, F700, F900. |
| communicationModes | object[] | The following attributes related to the communication mode between the REST API server and the storage system are output: |

| Attribute | Type | Description |
|-----------|------|---|
| | | <p>If multiple communication modes are output, the mode that is output at the top will be prioritized in communication.</p> <ul style="list-style-type: none"> ▪ communicationMode (string) Communication mode <ul style="list-style-type: none"> ▪ proxyMode ▪ lanConnectionMode ▪ proxies (object[]) The following attributes about the relay server are output: <ul style="list-style-type: none"> ▪ proxyIp (string) IP address ▪ proxyPort (int) Port number |

Status codes

For details on the status codes of the request for this operation, see the description on HTTP status codes.

Coding example

```
curl -v -H "Accept: application/json" -H "Authorization:Session
d7b673af189048468c5af9bcf3bbbbb6f" -X GET https://192.0.2.100/
ConfigurationManager/v1/objects/remote-storages/886000123456
```

Registering information about remote storage systems

The following request registers information about the remote storage system on the REST API server of the local storage system. At the same time, information about the local storage system can be registered, as the remote storage system, to the REST API server of the remote storage system.

Execution permission

Storage Administrator (Initial Configuration)

Request linePOST *base-URL/v1/objects/remote-storages***Request message****Object ID**

None.

Query parameters

None.

Body

```
{
  "storageDeviceId": "886000123457",
  "restServerIp": "192.0.2.101",
  "restServerPort": 443,
  "isMutualDiscovery": true
}
```

| Attribute | Type | Description |
|-------------------|---------|--|
| storageDeviceId | string | (Required) Storage device ID of the remote storage system |
| restServerIp | string | (Required) IP address used by the REST API server of the remote storage system You can specify an IPv4 address, IPv6 address, or a host name. |
| restServerPort | int | (Required) Port number used for SSL communication by the REST API server of the remote storage system |
| isMutualDiscovery | boolean | (Optional) Specify whether to perform a mutual registration operation. You can specify whether to register information about the local storage system on the REST API server of the remote storage system. <ul style="list-style-type: none"> ▪ <code>true</code>: Perform a mutual registration operation. ▪ <code>false</code>: Do not perform a mutual registration operation. If this value is omitted, <code>true</code> is specified. |

Response message**Body**

A job object is returned. For details on attributes other than `affectedResources`, see the section explaining job objects.

| Attribute | Description |
|--------------------------------|---|
| <code>affectedResources</code> | URL of the registered remote storage system |

Status codes

For details on the status codes of the request for this operation, see the description on HTTP status codes.

Coding example

```
curl -v -H "Accept:application/json" -H "Content-Type:application/json" -H
"Remote-Authorization:Session 10399a1ffce3489b9c3a823017462396" -H
"Authorization:Session d7b673af189048468c5af9bcf3b6bb6f" -X POST --data-
binary @./InputParameters.json https://192.0.2.100/ConfigurationManager/v1/
objects/remote-storages
```

Deleting information about remote storage systems

The following request deletes information about the remote storage system that is registered on the REST API server of the local storage system and information about the local storage system that is registered on the REST API server of the remote storage system. Alternatively, you can delete the information that is registered in the local storage system only. To change information about storage systems registered on the REST API server, delete the information about the storage systems, and then register information again.

Execution permission

Storage Administrator (Initial Configuration)

Request line

```
DELETE base-URL/v1/objects/remote-storages/object-ID
```

Request message**Object ID**

Specify the `storageDeviceId` value obtained by getting information about the storage systems.

| Attribute | Type | Description |
|------------------------------|--------|------------------------------|
| <code>storageDeviceId</code> | string | (Required) Storage device ID |

Query parameters

None.

Body

```
{
  "isMutualDeletion": true
}
```

| Attribute | Type | Description |
|-------------------------------|---------|---|
| <code>isMutualDeletion</code> | boolean | <p>(Optional) Specify whether to perform a mutual deletion operation.</p> <p>You can specify whether to delete information about the local storage system registered on the REST API server of the remote storage system.</p> <ul style="list-style-type: none"> ▪ <code>true</code>: Perform a mutual deletion operation. ▪ <code>false</code>: Do not perform a mutual deletion operation. <p>If this value is omitted, <code>true</code> is specified.</p> |

Response message**Body**

A job object is returned. For details on attributes other than `affectedResources`, see the section explaining job objects.

| Attribute | Description |
|--------------------------------|-----------------------------------|
| <code>affectedResources</code> | URL of the deleted storage system |

Status codes

For details on the status codes of the request for this operation, see the description on HTTP status codes.

Coding example

```
curl -v -H "Accept:application/json" -H "Content-Type:application/json" -H
"Remote-Authorization:Session 10399a1ffce3489b9c3a823017462396" -H
"Authorization:Session d7b673af189048468c5af9bcf3b66b6f" -X DELETE --data-
binary @./InputParameters.json https://192.0.2.100/ConfigurationManager/v1/
objects/remote-storages/886000123457
```

Setting remote connections

This section describes how to specify settings of remote connections used for remote copy operations by using the REST API.

Overview of the remote connection settings

Remote connections are used to connect storage systems used in remote copy operations for TrueCopy, Universal Replicator, and global-active device.

In this manual, the storage system that receives requests from the REST API clients is called a local storage system, and the storage system that is remotely connected to the local storage system is called a remote storage system.

The following figure shows an example of a remote connection:

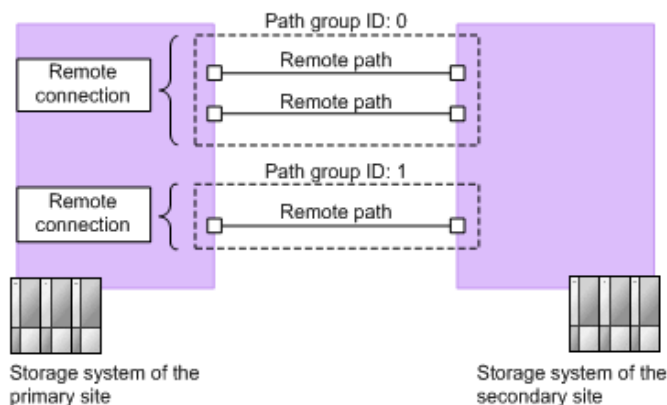

Remote path

A logical path that connects storage systems on the primary site and the secondary site is called a remote path.

A combination of port numbers that a logical path consists of is defined as a remote path.

Remote connections

A remote connection consists of a group of remote paths that connect the storage system on the primary site (MCU) and the storage system on the secondary site (RCU).

A remote connection consists of one or more remote paths, and a unique path group ID is assigned to each remote connection for management.

To set a remote connection by using the copy direction from the remote storage system to the local storage system, specify settings from a REST API client of the remote storage system.

The following is a list of operations that can be performed for remote connections by using the REST API.

- Create remote connections
- Change remote connection settings
- Add remote paths to remote connections
- Delete remote paths from remote connections
- Delete remote connections
- Get information about remote connections

To create a remote path for an iSCSI port, register in advance information about the iSCSI port of the remote storage system to the iSCSI port of the local storage system.

The following is a list of operations that can be performed for iSCSI ports by using the REST API.

- Register iSCSI ports
- Delete iSCSI ports
- Get information about iSCSI ports

Getting a list of remote connections

The following request gets a list of remote connections.

Execution permission

Storage Administrator (View Only)

Request line

```
GET base-URL/v1/objects/remotepath-groups
```

Request message**Object ID**

None.

Query parameters

None.

Body

None.

Response message**Body**

The following is an example of the output when information about the remote storage system is not registered on the REST API server:

```
{
  "data": [
    {
      "remotepathGroupId": "492015,M8,0",
      "remoteSerialNumber": "492015",
      "remoteStorageTypeId": "M8",
      "pathGroupId": 0,
      "cuType": "REMOTE",
      "portType": "FIBRE",
      "cuStatus": "NML",
      "minNumOfPaths": 1,
      "numOfPaths": 1,
      "timeoutValueForRemoteIOInSeconds": 15,
      "roundTripTimeInMilliseconds": 1
    }
  ]
}
```

The following is an example of the output when information about the remote storage system is registered on the REST API server:

```
{
  "data": [
    {
      "remotepathGroupId": "492015,M8,0",
      "remoteStorageDeviceId": "886000492015",
      "remoteSerialNumber": "492015",
      "remoteStorageModel": "VSP G900",
      "remoteStorageTypeId": "M8",
      "pathGroupId": 0,
      "cuType": "REMOTE",
      "portType": "FIBRE",
    }
  ]
}
```

```

    "cuStatus": "NML",
    "minNumOfPaths": 1,
    "numOfPaths": 1,
    "timeoutValueForRemoteIOInSeconds": 15,
    "roundTripTimeInMilliseconds": 1
  }
]
}

```

| Attribute | Type | Description |
|-----------------------|--------|--|
| remotepathGroupld | string | Object ID for the remote connection |
| remoteStorageDeviceId | string | Storage device ID of the remote storage system This attribute is output when information about the remote storage system is registered on the REST API server. |
| remoteSerialNumber | string | Serial number of the remote storage system |
| remoteStorageModel | string | Model type of the remote storage system This attribute is output when information about the remote storage system is registered on the REST API server. |
| remoteStorageTypeId | string | ID that indicates the model of the remote storage system <ul style="list-style-type: none"> ▪ R8: VSP G1000, VSP G1500, or VSP F1500 ▪ R9: VSP 5000 series ▪ M8: VSP E series, VSP Gx00 models or VSP Fx00 models |
| pathGroupld | int | Path group ID If the connection setting for the remote path is CU specific, this information is not output. |
| localCuNumber | string | CU number of the local storage system (MCU) This item is hidden when the value of the connection setting of the remote path is CU Free or when the value of the <code>cuType</code> attribute is LOCAL. |

| Attribute | Type | Description |
|----------------|--------|--|
| remoteCuNumber | string | CU number of the remote storage system (RCU) This item is hidden when the value of the connection setting of the remote path is CU Free or when the value of the <code>cuType</code> attribute is LOCAL. |
| portType | string | Port type of the remote path <ul style="list-style-type: none"> ▪ FIBRE: All the ports are Fibre Channel ports ▪ ESCON: All the ports are ESCON ports ▪ ISCSI: All the ports are iSCSI ports ▪ MIXED: Multiple port types from among these three types This item is hidden when the value of the <code>cuType</code> attribute is LOCAL. |
| cuType | string | CU type <ul style="list-style-type: none"> ▪ REMOTE: If a remote path is set from the local storage system to the remote storage system ▪ LOCAL: If a remote path is set from the remote storage system to the local storage system |
| cuStatus | string | CU status <ul style="list-style-type: none"> ▪ NML: Normal ▪ WAR: Warning ▪ ERR: Failing ▪ Unknown: Unknown. This is output if the <code>cuType</code> attribute is LOCAL. |
| minNumOfPaths | int | Minimum number of paths If the <code>cuType</code> attribute is LOCAL, this information is not output. |
| numOfPaths | int | Number of set remote paths If the <code>cuType</code> attribute is LOCAL, this information is not output. |

| Attribute | Type | Description |
|----------------------------------|---------|--|
| incidentMode | string | <p>Incident mode for sending incidents to the RCU host</p> <ul style="list-style-type: none"> ▪ MR: Incidents are sent to the MCU host and the RCU host. ▪ RO: Incidents are sent to the RCU host only. <p>This item is hidden when the value of the connection setting of the remote path is CU Free or when the value of the <code>cuType</code> attribute is LOCAL.</p> |
| isFreezeOptionEnabled | boolean | <p>Value of the FREEZE option</p> <ul style="list-style-type: none"> ▪ <code>false</code>: The FREEZE option is disabled. ▪ <code>true</code>: The FREEZE option is enabled. <p>This item is hidden when the value of the connection setting of the remote path is CU Free or when the value of the <code>cuType</code> attribute is LOCAL.</p> |
| timeoutValueForRemoteIOInSeconds | int | <p>RIO timeout value (in seconds) for RIO (Remote IO) setting between the local storage system and the remote storage system</p> <p>If the <code>cuType</code> attribute is LOCAL, this information is not output.</p> |
| roundTripTimeInMilliseconds | int | <p>The round-trip time value (in milliseconds) between the local storage system and the remote storage system</p> <p>If the <code>cuType</code> attribute is LOCAL, this information is not output.</p> |

Status codes

For details on the status codes of the request for this operation, see the description on HTTP status codes.

Coding example

```
curl -v -H "Accept:application/json" -H "Content-Type:application/json" -H "Authorization:Session d7b673af189048468c5af9bcf3bbbb6f" -X GET https://192.0.2.100/ConfigurationManager/v1/objects/remotepath-groups
```

Getting information about a specific remote connection

The following request gets information about a specific remote connection. You can get information about a remote connection when the value of the connection setting of the remote path is CU Free.

Execution permission

Storage Administrator (View Only)

Request line

```
GET base-URL/v1/objects/remotepath-groups/object-ID
```

Request message

Object ID

Specify the value of `remotepathGroupId` that was obtained by the processing to get information about the remote connection. You can also specify the attributes and connect them with commas as follows:

```
remoteSerialNumber,remoteStorageTypeId,pathGroupId
```

| Attribute | Type | Description |
|---------------------|--------|--|
| remoteSerialNumber | string | (Required) Serial number of the remote storage system |
| remoteStorageTypeId | string | (Required) ID that indicates the model of the remote storage system You can specify the following values: <ul style="list-style-type: none"> ▪ R9: VSP 5000 series ▪ M8: VSP E series, VSP G350, G370, G700, G900 or VSP F350, F370, F700, F900 |
| pathGroupId | int | (Required) Path group ID |

Query parameters

None.

Body

None.

Response message**Body**

The following is an example of the output when information about the remote storage system is not registered on the REST API server:

```
{
  "remotepathGroupId": "492015,M8,255",
  "remoteSerialNumber": "492015",
  "remoteStorageTypeId": "M8",
  "pathGroupId": 255,
  "remotePaths": [
    {
      "cuType": "REMOTE",
      "portType": "ISCSI",
      "pathNumber": 0,
      "localPortId": "CL3-B",
      "remotePortId": "CL2-C",
      "pathStatus": "ERR_03"
    }
  ]
}
```

The following is an example of the output when information about the remote storage system is registered on the REST API server:

```
{
  "remotepathGroupId": "492015,M8,255",
  "remoteStorageDeviceId": "886000492015",
  "remoteSerialNumber": "492015",
  "remoteStorageModel": "VSP G900",
  "remoteStorageTypeId": "M8",
  "pathGroupId": 255,
  "remotePaths": [
    {
      "cuType": "REMOTE",
      "portType": "ISCSI",
      "pathNumber": 0,
      "localPortId": "CL3-B",
      "remotePortId": "CL2-C",
      "pathStatus": "ERR_03"
    }
  ]
}
```

| Attribute | Type | Description |
|-------------------|--------|-------------------------------------|
| remotepathGroupId | string | Object ID for the remote connection |

| Attribute | Type | Description |
|-----------------------|------------|---|
| remoteStorageDeviceId | string | Storage device ID of the remote storage system This attribute is output when information about the remote storage system is registered on the REST API server. |
| remoteSerialNumber | string | Serial number of the remote storage system |
| remoteStorageModel | string | Model type of the remote storage system This attribute is output when information about the remote storage system is registered on the REST API server. |
| remoteStorageTypeId | string | ID that indicates the model of the remote storage system <ul style="list-style-type: none"> ▪ R9: VSP 5000 series ▪ M8: VSP E series, VSP G350, G370, G700, G900 or VSP F350, F370, F700, F900 |
| pathGroupId | int | Path group ID |
| remotePaths | objects[] | The following attributes are output for each remote path: <ul style="list-style-type: none"> ▪ cuType (string) CU type <ul style="list-style-type: none"> • REMOTE: If a remote path is set from the local storage system to the remote storage system • LOCAL: If a remote path is set from the remote storage system to the local storage system ▪ portType (string) Port type of the remote path <ul style="list-style-type: none"> • FIBRE: Fibre Channel port • ESCON: ESCON port • ISCSI: iSCSI port ▪ pathNumber (int) Path number ▪ localPortId (string) Port number of the local storage system (MCU) |

| Attribute | Type | Description |
|-----------|------|---|
| | | <ul style="list-style-type: none"> ▪ remotePortId (string) Port number of the remote storage system (RCU) ▪ pathStatus (string) The path status <ul style="list-style-type: none"> • NML_01: Normal • ERR_02: Initialization failed • ERR_03: Communication timeout • ERR_04: Logical blockade • ERR_05: Resource Shortage • ERR_06: Serial Number Mismatch • ERR_10: Invalid Port • ERR_80: RCU Port Number Mismatch • ERR_81: RCU Port Type Mismatch • ERR_82: Communication Failed • IN_PRG: The path is being created or deleted. |

Status codes

For details on the status codes of the request for this operation, see the description on HTTP status codes.

Coding example

```
curl -v -H "Accept:application/json" -H "Content-Type:application/json" -H
"Authorization:Session d7b673af189048468c5af9bcf3bbbb6f" -X GET https://
192.0.2.100/ConfigurationManager/v1/objects/remotepath-groups/492015,M8,255
```

Creating a remote connection

The following request creates a remote connection, and then adds a remote path. By using this request, you can create a CU Free remote connection. You can specify the serial number and the series name of the remote storage system to create a remote connection. Alternatively, you can specify the storage device ID of the remote storage system to create a remote connection. To add a remote path for an iSCSI port, register in advance the iSCSI port of the remote storage system to the iSCSI port of the local storage system.

Execution permission

Storage Administrator (Remote Copy)

Request linePOST *base-URL/v1/objects/remotepath-groups***Request message****Object ID**

None.

Query parameters

None.

Body

The following is a coding example for creating a remote connection by specifying the serial number and the series name of the remote storage system:

```
{
  "remoteSerialNumber": "492015",
  "remoteStorageTypeId": "M8",
  "pathGroupId": 255,
  "localPortId": "CL3-B",
  "remotePortId": "CL2-C"
}
```

| Attribute | Type | Description |
|---------------------|--------|--|
| remoteSerialNumber | string | (Required) Serial number of the remote storage system |
| remoteStorageTypeId | string | (Required) ID that indicates the model of the remote storage system You can specify the following values: <ul style="list-style-type: none"> ▪ R9: VSP 5000 series ▪ M8: VSP E series, VSP G350, G370, G700, G900 or VSP F350, F370, F700, F900 |
| pathGroupId | int | (Required) Path group ID Specify a decimal (base 10) number in the range from 0 to 255. |
| localPortId | string | (Required) Port number of the local storage system |

| Attribute | Type | Description |
|--------------|--------|---|
| remotePortId | string | (Required) Port number of the remote storage system |

The following is a coding example for creating a remote connection by specifying the storage device ID of the remote storage system:

```
{
  "remoteStorageDeviceId": "886000410011",
  "pathGroupId": 255,
  "localPortId": "CL3-B",
  "remotePortId": "CL2-C"
}
```

| Attribute | Type | Description |
|-----------------------|--------|--|
| remoteStorageDeviceId | string | (Required) Storage device ID of the remote storage system |
| pathGroupId | int | (Required) Path group ID Specify a decimal (base 10) number in the range from 0 to 255. |
| localPortId | string | (Required) Port number of the local storage system |
| remotePortId | string | (Required) Port number of the remote storage system |

Response message

Body

A job object is returned. For details on attributes other than `affectedResources`, see the section explaining job objects.

| Attribute | Description |
|-------------------|---|
| affectedResources | URL of the registered remote connection |

Status codes

The following table describes the meaning of the status code of the request for this operation. For details on other status codes, see the section explaining HTTP status codes.

| Status code | Message | Description |
|-------------|----------|--|
| 409 | Conflict | A remote connection has already been created with the specified path group ID. |

Coding example

```
curl -v -H "Accept:application/json" -H "Content-Type:application/json" -H
"Authorization:Session d7b673af189048468c5af9bcf3bbbb6f" -X POST --data-
binary @./InputParameters.json https://192.0.2.100/ConfigurationManager/v1/
objects/remotepath-groups
```

Changing the remote connection settings

The following request changes the remote connection settings such as the minimum number of paths, communication timeout value, and the return response time. You can change the remote connection settings when the value of the connection setting of the remote path is CU Free.

Execution permission

Storage Administrator (Remote Copy)

Request line

```
PATCH base-URL/v1/objects/remotepath-groups/object-ID
```

Request message**Object ID**

Specify the value of `remotepathGroupId` that was obtained by the processing to get information about the remote connection. You can also specify the attributes and connect them with commas as follows:

```
remoteSerialNumber,remoteStorageTypeId,pathGroupId
```

| Attribute | Type | Description |
|--------------------|--------|---|
| remoteSerialNumber | string | (Required) Serial number of the remote storage system |

| Attribute | Type | Description |
|---------------------|--------|--|
| remoteStorageTypeId | string | (Required) ID that indicates the model of the remote storage system You can specify the following values: <ul style="list-style-type: none"> R9: VSP 5000 series M8: VSP E series, VSP G350, G370, G700, G900 or VSP F350, F370, F700, F900 |
| pathGroupId | int | (Required) Path group ID |

Query parameters

None.

Body

```
{
  "minNumOfPaths": 1,
  "timeoutValueForRemoteIOInSeconds": 15,
  "roundTripTimeInMilliseconds": 1
}
```

| Attribute | Type | Description |
|----------------------------------|------|---|
| minNumOfPaths | int | Minimum number of remote paths Specify a value in the range from 1 to 8. This value is set to 1 by default when a remote connection is created. Specify a value that is no more than the number of remote paths registered in the remote connection. |
| timeoutValueForRemoteIOInSeconds | int | RIO timeout value (in seconds) for RIO (Remote IO) setting between the local storage system and the remote storage system Specify a value in the range from 10 to 100. This value is set to 15 by default when a remote connection is created. |

| Attribute | Type | Description |
|-----------------------------|------|---|
| roundTripTimeInMilliseconds | int | The round-trip time value (in milliseconds) between the local storage system and the remote storage system Specify a value in the range from 1 to 500. Default: 1 This value is set to 1 by default when a remote connection is created. |

Response message

Body

A job object is returned. For details on attributes other than `affectedResources`, see the section explaining job objects.

| Attribute | Description |
|--------------------------------|--------------------------------------|
| <code>affectedResources</code> | URL of the changed remote connection |

Status codes

The following table describes the meaning of the status code of the request for this operation. For details on other status codes, see the section explaining HTTP status codes.

| Status code | Message | Description |
|-------------|-------------|--|
| 400 | Bad Request | Values smaller or greater than the specifiable values exist in the specified values. |

Coding example

```
curl -v -H "Accept:application/json" -H "Content-Type:application/json" -H
"Authorization:Session d7b673af189048468c5af9bcf3b6bb6f" -X PATCH --data-
binary @./InputParameters.json https://192.0.2.100/ConfigurationManager/v1/
objects/remotepath-groups/492015,M8,255
```

Adding remote paths to a remote connection

The following request adds a remote path to the existing remote connection. You can add a remote path when the value of the connection setting of the remote path is CU Free. To add a remote path for an iSCSI port, register in advance the iSCSI port of the remote storage system to the iSCSI port of the local storage system.

Execution permission

Storage Administrator (Remote Copy)

Request line

```
POST base-URL/v1/objects/remotepath-groups/object-ID/actions/add-remotepath/invoke
```

Request message

Object ID

Specify the value of `remotepathGroupId` that was obtained by the processing to get information about the remote connection. You can also specify the attributes and connect them with commas as follows:

```
remoteSerialNumber,remoteStorageTypeId,pathGroupId
```

| Attribute | Type | Description |
|---------------------|--------|--|
| remoteSerialNumber | string | (Required) Serial number of the remote storage system |
| remoteStorageTypeId | string | (Required) ID that indicates the model of the remote storage system You can specify the following values: <ul style="list-style-type: none"> ▪ R9: VSP 5000 series ▪ M8: VSP E series, VSP G350, G370, G700, G900 or VSP F350, F370, F700, F900 |
| pathGroupId | int | (Required) Path group ID |

Query parameters

None.

Body

```
{
  "parameters": {
```

```

"localPortId": "CL1-A",
"remotePortId": "CL2-B"
}
}

```

| Attribute | Type | Description |
|--------------|--------|---|
| localPortId | string | (Required) Port number of the local storage system |
| remotePortId | string | (Required) Port number of the remote storage system |

Response message

Body

A job object is returned. For details on attributes other than `affectedResources`, see the section explaining job objects.

| Attribute | Description |
|-------------------|--|
| affectedResources | URL of the remote path that was added to the remote connection |

Action template

```
GET base-URL/v1/objects/remotepath-groups/object-ID/actions/add-remotepath
```

Status codes

The following table describes the meaning of the status code of the request for this operation. For details on other status codes, see the section explaining HTTP status codes.

| Status code | Message | Description |
|-------------|---------------------|---|
| 412 | Precondition Failed | The number of the remote paths already registered to the target remote connection is eight, which is the maximum number of remote paths that can be registered. |

Coding example

To get an action template:

```
curl -v -H "Accept:application/json" -H "Content-Type:application/json" -H
"Authorization:Session d7b673af189048468c5af9bcf3bbbb6f" -X GET https://
192.0.2.100/ConfigurationManager/v1/objects/remotepath-groups/492015,M8,
255/actions/add-remotepath
```

To run the request after getting an action template:

```
curl -v -H "Accept:application/json" -H "Content-Type:application/json" -H
"Authorization:Session d7b673af189048468c5af9bcf3bbbb6f" -X POST --data-
binary @./InputParameters.json https://192.0.2.100/ConfigurationManager/v1/
objects/remotepath-groups/492015,M8,255/actions/add-remotepath/invoke
```

Deleting a remote path from a remote connection

The following request deletes a specified remote path from a remote connection. You can delete a remote path when the value of the connection setting of the remote path is CU Free. If the specified path is an iSCSI remote path and is not registered to other remote connections, the remote storage system's iSCSI port information that is registered to the iSCSI port on the local storage system is deleted at the same time the iSCSI remote path is deleted.

Execution permission

Storage Administrator (Remote Copy)

Request line

```
POST base-URL/v1/objects/remotepath-groups/object-ID/actions/remove-
remotepath/invoke
```

Request message**Object ID**

Specify the value of `remotepathGroupId` that was obtained by the processing to get information about the remote connection. You can also specify the attributes and connect them with commas as follows:

```
remoteSerialNumber,remoteStorageTypeId,pathGroupId
```

| Attribute | Type | Description |
|--------------------|--------|---|
| remoteSerialNumber | string | (Required) Serial number of the remote storage system |

| Attribute | Type | Description |
|---------------------|--------|--|
| remoteStorageTypeId | string | (Required) ID that indicates the model of the remote storage system You can specify the following values: <ul style="list-style-type: none"> R9: VSP 5000 series M8: VSP E series, VSP G350, G370, G700, G900 or VSP F350, F370, F700, F900 |
| pathGroupId | int | (Required) Path group ID |

Query parameters

None.

Body

```
{
  "parameters": {
    "localPortId": "CL1-A",
    "remotePortId": "CL2-B"
  }
}
```

| Attribute | Type | Description |
|--------------|--------|---|
| localPortId | string | (Required) Port number of the local storage system |
| remotePortId | string | (Required) Port number of the remote storage system |

Response message**Body**

A job object is returned. For details on attributes other than `affectedResources`, see the section explaining job objects.

| Attribute | Description |
|-------------------|---|
| affectedResources | URL of the remote path removed from the remote connection |

Action template

```
GET base-URL/v1/objects/remotepath-groups/object-ID/actions/remove-remotepath
```

Status codes

The following table describes the meaning of the status code of the request for this operation. For details on other status codes, see the section explaining HTTP status codes.

| Status code | Message | Description |
|-------------|---------------------|---|
| 412 | Precondition Failed | Only one remote path or the minimum number of remote paths is set for the target remote connection. |

Coding example

To get an action template

```
curl -v -H "Accept:application/json" -H "Content-Type:application/json" -H "Authorization:Session d7b673af189048468c5af9bcf3b66b6f" -X GET https://192.0.2.100/ConfigurationManager/v1/objects/remotepath-groups/492015,M8,255/actions/remove-remotepath
```

To run the request after getting an action template:

```
curl -v -H "Accept:application/json" -H "Content-Type:application/json" -H "Authorization:Session d7b673af189048468c5af9bcf3b66b6f" -X POST --data-binary @./InputParameters.json https://192.0.2.100/ConfigurationManager/v1/objects/remotepath-groups/492015,M8,255/actions/remove-remotepath/invoke
```

Deleting a remote connection

The following request deletes a specified remote connection. You can delete a remote connection when the value of the connection setting of the remote path is CU Free. When a remote connection is deleted, all remote paths registered to the remote connection to be deleted will also be deleted. If an iSCSI remote path is included in the remote connection to be deleted and is not registered to other remote connections, the remote storage system's iSCSI port information that is registered to the iSCSI port on the local storage system is deleted at the same time the iSCSI remote path is deleted.

Execution permission

Storage Administrator (Remote Copy)

Request line

```
DELETE base-URL/v1/objects/remotepath-groups/object-ID
```

Request message**Object ID**

Specify the value of `remotepathGroupId` that was obtained by the processing to get information about the remote connection. You can also specify the attributes and connect them with commas as follows:

```
remoteSerialNumber,remoteStorageTypeId,pathGroupId
```

| Attribute | Type | Description |
|---------------------|--------|--|
| remoteSerialNumber | string | (Required) Serial number of the remote storage system |
| remoteStorageTypeId | string | (Required) ID that indicates the model of the remote storage system You can specify the following values: <ul style="list-style-type: none"> ▪ R9: VSP 5000 series ▪ M8: VSP E series, VSP G350, G370, G700, G900 or VSP F350, F370, F700, F900 |
| pathGroupId | int | (Required) Path group ID |

Query parameters

None.

Body

None.

Response message**Body**

A job object is returned. For details on attributes other than `affectedResources`, see the section explaining job objects.

| Attribute | Description |
|-------------------|--------------------------------------|
| affectedResources | URL of the deleted remote connection |

Status codes

For details on the status codes of the request for this operation, see the description on HTTP status codes.

Coding example

```
curl -v -H "Accept:application/json" -H "Content-Type:application/json" -H
"Authorization:Session d7b673af189048468c5af9bcf3bbbb6f" -X DELETE
https://192.0.2.100/ConfigurationManager/v1/objects/remotepath-groups/
492015,M8,255
```

Getting information about iSCSI ports

The following request gets information about iSCSI ports of the registered remote storage system.

Execution permission

Storage Administrator (View Only)

Request line

```
GET base-URL/v1/objects/remote-iscsi-ports
```

Request message**Object ID**

None.

Query parameters

None.

Body

None.

Response message**Body**

The following is an example of the output when information about the remote storage system is not registered on the REST API server:

```
{
  "data": [
    {
      "remoteIscsiPortId": "CL1-B,410012,M8,CL2-D",
      "localPortId": "CL1-B",
      "remoteSerialNumber": "410012",
      "remoteStorageTypeId": "M8",
      "remotePortId": "CL2-D",
      "remoteIpAddress": "192.168.116.29",
      "remoteTcpPort": 3260
    },
  ],
}
```

```

{
  "remoteIscsiPortId": "CL3-B,410012,M8,CL2-D",
  "localPortId": "CL3-B",
  "remoteSerialNumber": "410012",
  "remoteStorageTypeId": "M8",
  "remotePortId": "CL2-D",
  "remoteIpAddress": "192.168.116.29",
  "remoteTcpPort": 3260
}
]
}

```

The following is an example of the output when information about the remote storage system is registered on the REST API server:

```

{
  "data": [
    {
      "remoteIscsiPortId": "CL1-B,410012,M8,CL2-D",
      "localPortId": "CL1-B",
      "remoteStorageDeviceId": "886000410012",
      "remoteSerialNumber": "410012",
      "remoteStorageModel": "VSP G900",
      "remoteStorageTypeId": "M8",
      "remotePortId": "CL2-D",
      "remoteIpAddress": "192.168.116.29",
      "remoteTcpPort": 3260
    },
    {
      "remoteIscsiPortId": "CL3-B,410012,M8,CL2-D",
      "localPortId": "CL3-B",
      "remoteStorageDeviceId": "886000410012",
      "remoteSerialNumber": "410012",
      "remoteStorageModel": "VSP G900",
      "remoteStorageTypeId": "M8",
      "remotePortId": "CL2-D",
      "remoteIpAddress": "192.168.116.29",
      "remoteTcpPort": 3260
    }
  ]
}

```

| Attribute | Type | Description |
|-------------------|--------|------------------------------|
| remoteIscsiPortId | string | Object ID for the iSCSI port |

| Attribute | Type | Description |
|-----------------------|--------|--|
| localPortId | string | Port number of the local storage system |
| remoteStorageDeviceId | string | Storage device ID of the remote storage system This attribute is output when information about the remote storage system is registered on the REST API server. |
| remoteSerialNumber | string | Serial number of the remote storage system |
| remoteStorageModel | string | Model type of the remote storage system This attribute is output when information about the remote storage system is registered on the REST API server. |
| remoteStorageTypeId | string | ID that indicates the model of the remote storage system <ul style="list-style-type: none"> ▪ R8: VSP G1000, VSP G1500, or VSP F1500 ▪ R9: VSP 5000 series ▪ M8: VSP E series, VSP Gx00 models or VSP Fx00 models |
| remotePortId | string | Port number of the remote storage system |
| remoteIpAddress | string | IP address of the remote storage system |
| remoteTcpPort | int | TCP port number of the remote storage system |

Status codes

For details on the status codes of the request for this operation, see the description on HTTP status codes.

Coding example

```
curl -v -H "Accept:application/json" -H "Content-Type:application/json" -H
"Authorization:Session d7b673af189048468c5af9bcf3b66b6f" -X GET https://
192.0.2.100/ConfigurationManager/v1/objects/remote-iscsi-ports
```

Getting information about a specific iSCSI port

If you specify a port, the following request gets information about that iSCSI port of the remote storage system.

Execution permission

Storage Administrator (View Only)

Request line

```
GET base-URL/v1/objects/remote-iscsi-ports/object-ID
```

Request message

Object ID

Specify the value of `remoteIscsiPortId` that was obtained by the processing to get information about the port. You can also specify the attributes and connect them with commas as follows:

```
localPortId,remoteSerialNumber,remoteStorageTypeId,remotePortId
```

| Attribute | Type | Description |
|---------------------|--------|--|
| localPortId | string | (Required) Port number of the local storage system |
| remoteSerialNumber | string | (Required) Serial number of the remote storage system |
| remoteStorageTypeId | string | (Required) ID that indicates the model of the remote storage system You can specify the following values: <ul style="list-style-type: none"> ▪ R9: VSP 5000 series ▪ M8: VSP E series, VSP G350, G370, G700, G900 or VSP F350, F370, F700, F900 |
| remotePortId | string | (Required) Port number of the remote storage system |

Query parameters

None.

Body

None.

Response message**Body**

The following is an example of the output when information about the remote storage system is not registered on the REST API server:

```
{
  "remoteIscsiPortId": "CL1-B,410012,M8,CL2-D",
  "localPortId": "CL1-B",
  "remoteSerialNumber": "410012",
  "remoteStorageTypeId": "M8",
  "remotePortId": "CL2-D",
  "remoteIpAddress": "192.168.116.29",
  "remoteTcpPort": 3260
}
```

The following is an example of the output when information about the remote storage system is registered on the REST API server:

```
{
  "remoteIscsiPortId": "CL1-B,410012,M8,CL2-D",
  "localPortId": "CL1-B",
  "remoteStorageDeviceId": "886000410012",
  "remoteSerialNumber": "410012",
  "remoteStorageModel": "VSP G900",
  "remoteStorageTypeId": "M8",
  "remotePortId": "CL2-D",
  "remoteIpAddress": "192.168.116.29",
  "remoteTcpPort": 3260
}
```

| Attribute | Type | Description |
|-----------------------|--------|---|
| remotelscsiPortId | string | Object ID for the iSCSI port |
| localPortId | string | Port number of the local storage system |
| remoteStorageDeviceId | string | Storage device ID of the remote storage system This attribute is output when information about the remote storage system is registered on the REST API server. |
| remoteSerialNumber | string | Serial number of the remote storage system |
| remoteStorageModel | string | Model type of the remote storage system |

| Attribute | Type | Description |
|---------------------|--------|--|
| | | This attribute is output when information about the remote storage system is registered on the REST API server. |
| remoteStorageTypeId | string | ID that indicates the model of the remote storage system <ul style="list-style-type: none"> ▪ R9: VSP 5000 series ▪ M8: VSP E series, VSP G350, G370, G700, G900 or VSP F350, F370, F700, F900 |
| remotePortId | string | Port number of the remote storage system |
| remoteIpAddress | string | IP address of the remote storage system |
| remoteTcpPort | int | TCP port number of the remote storage system |

Status codes

For details on the status codes of the request for this operation, see the description on HTTP status codes.

Coding example

```
curl -v -H "Accept:application/json" -H "Content-Type:application/json" -H
"Authorization:Session d7b673af189048468c5af9bcf3b66b6f" -X GET https://
192.0.2.100/ConfigurationManager/v1/objects/remote-iscsi-ports/CL1-B,
410012,M8,CL2-D
```

Registering an iSCSI port

The following request registers the iSCSI port of the remote storage system to the iSCSI port of the local storage system. You can specify the serial number and the series name of the remote storage system to register an iSCSI port. Alternatively, you can specify the storage device ID of the remote storage system to register an iSCSI port. Perform this operation before adding a remote path to a remote connection.

Execution permission

Storage Administrator (Remote Copy)

Request line

```
POST base-URL/v1/objects/remote-iscsi-ports
```

Request message**Object ID**

None.

Query parameters

None.

Body

The following is a coding example for registering an iSCSI port by specifying the serial number, series name, and the TCP port number of the remote storage system:

```
{
  "localPortId": "CL1-B",
  "remoteSerialNumber": "492015",
  "remoteStorageTypeId": "M8",
  "remotePortId": "CL2-D",
  "remoteIpAddress": "192.168.116.29",
  "remoteTcpPort": 3260
}
```

The following is a coding example for registering an iSCSI port by specifying the serial number and the series name of the remote storage system, without specifying the TCP port number:

```
{
  "localPortId": "CL1-B",
  "remoteSerialNumber": "492015",
  "remoteStorageTypeId": "M8",
  "remotePortId": "CL2-D",
  "remoteIpAddress": "192.168.116.29"
}
```

When registering an iSCSI port by specifying the serial number and the series name of the remote storage system:

| Attribute | Type | Description |
|---------------------|--------|---|
| localPortId | string | (Required) Port number of the local storage system |
| remoteSerialNumber | string | (Required) Serial number of the remote storage system |
| remoteStorageTypeId | string | (Required) ID that indicates the model of the remote storage system |

| Attribute | Type | Description |
|-----------------|--------|---|
| | | You can specify the following values: <ul style="list-style-type: none"> R9: VSP 5000 series M8: VSP E series, VSP G350, G370, G700, G900 or VSP F350, F370, F700, F900 |
| remotePortId | string | (Required) Port number of the remote storage system |
| remoteIpAddress | string | (Required) IP address of the remote storage system You can specify an IPv4 or IPv6 address. |
| remoteTcpPort | int | (Optional) TCP port number If this attribute is not specified, the TCP port number for the iSCSI target of the local storage system will be set to the TCP port number of the remote storage system. |

The following is a coding example for registering an iSCSI port by specifying the storage device ID and the TCP port number of the remote storage system:

```
{
  "localPortId": "CL1-B",
  "remoteStorageDeviceId": "886000492015",
  "remotePortId": "CL2-D",
  "remoteIpAddress": "192.168.116.29"
}
```

When registering the iSCSI port by specifying the storage device ID of the remote storage system:

| Attribute | Type | Description |
|-----------------------|--------|--|
| localPortId | string | (Required) Port number of the local storage system |
| remoteStorageDeviceId | string | (Required) Storage device ID of the remote storage system |
| remotePortId | string | (Required) Port number of the remote storage system |
| remoteIpAddress | string | (Required) IP address of the remote storage system You can specify an IPv4 or IPv6 address. |
| remoteTcpPort | int | (Optional) TCP port number |

| Attribute | Type | Description |
|-----------|------|---|
| | | If this attribute is not specified, the TCP port number for the iSCSI target of the local storage system will be set to the TCP port number of the remote storage system. |

Response message

Body

A job object is returned. For details on attributes other than `affectedResources`, see the section explaining job objects.

| Attribute | Description |
|--------------------------------|--|
| <code>affectedResources</code> | URL of the iSCSI port of the remote storage system that was registered to the iSCSI port of the local storage system |

Status codes

For details on the status codes of the request for this operation, see the description on HTTP status codes.

Coding example

```
curl -v -H "Accept:application/json" -H "Content-Type:application/json" -H
"Authorization:Session d7b673af189048468c5af9bcf3b66b6f" -X POST --data-
binary @./InputParameters.json https://192.0.2.100/ConfigurationManager/v1/
objects/remote-iscsi-ports
```

Removing the registration of an iSCSI port

The following request deletes information about the iSCSI port of the remote storage system that is registered to the iSCSI port of the local storage system. If this iSCSI port is registered in a remote connection, you cannot delete the information.

Execution permission

Storage Administrator (Remote Copy)

Request line

```
DELETE base-URL/v1/objects/remote-iscsi-ports/object-ID
```

Request message**Object ID**

Specify the value of `remoteIscsiPortId` that was obtained by the processing to get information about the port. You can also specify the attributes and connect them with commas as follows:

```
localPortId,remoteSerialNumber,remoteStorageTypeId,remotePortId
```

| Attribute | Type | Description |
|---------------------|--------|--|
| localPortId | string | (Required) Port number of the local storage system |
| remoteSerialNumber | string | (Required) Serial number of the remote storage system |
| remoteStorageTypeId | string | (Required) ID that indicates the model of the remote storage system You can specify the following values: <ul style="list-style-type: none"> ▪ R9: VSP 5000 series ▪ M8: VSP E series, VSP G350, G370, G700, G900 or VSP F350, F370, F700, F900 |
| remotePortId | string | (Required) Port number of the remote storage system |

Query parameters

None.

Body

None.

Response message**Body**

A job object is returned. For details on attributes other than `affectedResources`, see the section explaining job objects.

| Attribute | Description |
|-------------------|-------------------------------|
| affectedResources | URL of the deleted iSCSI port |

Status codes

For details on the status codes of the request for this operation, see the description on HTTP status codes.

Coding example

```
curl -v -H "Accept:application/json" -H "Content-Type:application/json" -H
"Authorization:Session d7b673af189048468c5af9bcf3b6666f" -X DELETE
https://192.0.2.100/ConfigurationManager/v1/objects/remote-iscsi-ports/CL1-
B,410012,M8,CL2-D
```

Setting journals

This section describes how to specify settings of journals to be used in Universal Replicator by using the REST API.

Getting journal information

The following request gets a list of information about a journal.

Execution permission

Storage Administrator (View Only)

Request line

```
GET base-URL/v1/objects/journals
```

Request message**Object ID**

None.

Query parameters

| Parameter | Type | Filter Condition |
|-------------|--------|---|
| journalInfo | string | (Required) Type of information to be obtained The specifiable values are as follows: <ul style="list-style-type: none"> ▪ basic: Basic journal information ▪ timer: Journal time information ▪ detail: Detailed journal information |

Body

None.

Response message**Body**

The following is an example of the output when basic journal information is obtained:

```
{
  "data": [
    {
      "journalId": 0,
      "muNumber": 1,
      "consistencyGroupId": 5,
      "journalStatus": "PJSF",
      "numOfActivePaths": 1,
      "usageRate": 0,
      "qMarker": "575cc653",
      "qCount": 0,
      "byteFormatCapacity": "1.88 G",
      "blockCapacity": 3956736,
      "numOfLdevs": 1,
      "firstLdevId": 513
    }
  ]
}
```

| Attribute | Type | Description |
|--------------------|--------|---|
| journalId | int | Journal ID |
| muNumber | int | MU (mirror unit) number |
| consistencyGroupId | int | Consistency group identifier |
| journalStatus | string | Journal volume status For details, see the section explaining the mirror journal statuses. |
| numOfActivePaths | int | Number of active link paths |
| usageRate | int | Usage rate of the journal volume |
| qMarker | string | If the obtained journal is the master journal, the last sequential number (Q-marker) when the journal volume received the write data is output. If the obtained journal is the restore journal, the last sequential number (Q-marker) that is written in the cache is output. |

| Attribute | Type | Description |
|--------------------|--------|--|
| qCount | long | Number of <code>qMarker</code> remaining in the master journal volume |
| byteFormatCapacity | string | Capacity of the journal volume The value is output to the second decimal place. |
| blockCapacity | long | Number of blocks of the journal volume |
| numOfLdevs | int | Number of LDEVs configuring the journal volume |
| firstLdevId | int | LDEV number of the first LDEV assigned to the journal |

The following is an example of the output when journal time information is obtained:

```
{
  "data": [
    {
      "journalId": 0,
      "muNumber": 1,
      "consistencyGroupId": 5,
      "journalStatus": "PJSF",
      "numOfActivePaths": 1,
      "usageRate": 0,
      "qMarker": "575cc653",
      "qCount": 0,
      "byteFormatCapacity": "1.88 G",
      "blockCapacity": 3956736,
      "dataOverflowWatchInSeconds": 60,
      "pathBlockadeWatchInMinutes": 5,
      "activePathWatchTimerSettingInSeconds": 40
    }
  ]
}
```

| Attribute | Type | Description |
|--------------------|--------|---|
| journalId | int | Journal ID |
| muNumber | int | MU (mirror unit) number |
| consistencyGroupId | int | Consistency group identifier |
| journalStatus | string | Journal volume status For details, see the section explaining the mirror journal statuses. |

| Attribute | Type | Description |
|--------------------------------------|--------|---|
| numOfActivePaths | int | Number of active link paths |
| usageRate | int | Usage rate of the journal volume |
| qMarker | string | If the obtained journal is the master journal, the last sequential number (Q-marker) when the journal volume received the write data is output. If the obtained journal is the restore journal, the last sequential number (Q-marker) that is written in the cache is output. |
| qCount | long | Number of qMarker remaining in the master journal volume |
| byteFormatCapacity | string | Capacity of the journal volume The value is output to the second decimal place. |
| blockCapacity | long | Number of blocks of the journal volume |
| dataOverflowWatchInSeconds | int | Data Overflow Watch timer setting (in seconds) per the Journal |
| pathBlockadeWatchInMinutes | int | Path Blockade Watch timer setting (in minutes) per the Journal |
| activePathWatchTimerSettingInSeconds | int | Active Path Watch timer setting (in seconds) to detect any link failures |

The following is an example of the output when detailed journal information is obtained:

```
{
  "data": [
    {
      "journalId": 0,
      "isMainframe": false,
      "isCacheModeEnabled": true,
      "isInflowControlEnabled": true,
      "dataOverflowWatchInSeconds": 60,
      "copySpeed": 256,
      "isDataCopying": true,
      "mpBladeId": 0,
      "mirrorUnits": [
```

```

{
  "muNumber": 0,
  "consistencyGroupId": 0,
  "journalStatus": "SMPL",
  "pathBlockadeWatchInMinutes": 5,
  "copyPace": "L"
  "copySpeed": 256,
  "isDataCopying": true,
},
...
...
{
  "muNumber": 3,
  "consistencyGroupId": 0,
  "journalStatus": "SMPL",
  "pathBlockadeWatchInMinutes": 5,
  "copyPace": "L"
  "copySpeed": 256,
  "isDataCopying": true,
}
]
}
]
}

```

| Attribute | Type | Description |
|-------------|---------|---|
| journalId | int | Journal ID |
| isMainframe | boolean | Indicates whether the journal is used for mainframe systems or open systems <ul style="list-style-type: none"> ▪ true: The journal is used for mainframe systems ▪ false: The journal is used for open systems |
| mfTimerType | string | Timer type for mainframe systems <ul style="list-style-type: none"> ▪ LOCAL: A local timer is used. ▪ SYSTEM: A system timer is used. ▪ none: A system timer is used (when the copy direction is the reverse). |

| Attribute | Type | Description |
|----------------------------|-----------|--|
| isCacheModeEnabled | boolean | Indicates whether the cache mode setting is enabled <ul style="list-style-type: none"> ▪ <code>true</code>: The cache mode setting is enabled. ▪ <code>false</code>: The cache mode setting is disabled. |
| isInflowControlEnabled | boolean | Indicates whether an inflow of update I/O to the journal volume is limited <ul style="list-style-type: none"> ▪ <code>true</code>: Inflow is limited. ▪ <code>false</code>: Inflow is unlimited. |
| dataOverflowWatchInSeconds | int | Data Overflow Watch timer setting (in seconds) per the Journal |
| copySpeed | int | Transfer speed (in Mbps) The value set for the object whose MU (mirror unit) number is 3 is output. For details about the value for each mirror, see the description of the <code>copySpeed</code> attribute of the <code>mirrorUnits</code> object. |
| isDataCopying | boolean | Copy mode "true" or "false" under failure of the delta resync: <ul style="list-style-type: none"> ▪ <code>true</code>: copying ALL data ▪ <code>false</code>: No copying The value set for the object whose MU (mirror unit) number is 3 is output. For details about the value for each mirror, see the description of the <code>isDataCopying</code> attribute of the <code>mirrorUnits</code> object. |
| mpBladeId | int | MP blade ID |
| mirrorUnits | object[] | The following attributes are output for each mirror: <ul style="list-style-type: none"> ▪ <code>muNumber</code> (int) MU (mirror unit) number ▪ <code>consistencyGroupId</code> (int) Consistency group ID |

| Attribute | Type | Description |
|-----------|------|---|
| | | <ul style="list-style-type: none"> ▪ <code>journalStatus</code> (string) The journal status For details, see the section explaining the mirror journal statuses. ▪ <code>pathBlockadeWatchInMinutes</code> (int) Path Blockade Watch timer setting (in minutes) per the Journal ▪ <code>copyPace</code> (string) Copy speed <ul style="list-style-type: none"> • L: Low speed • M: Medium speed • H: High speed ▪ <code>copySpeed</code> (int) Transfer speed (in Mbps) ▪ <code>isDataCopying</code> (boolean) Copy mode "true" or "false" under failure of the delta resync: <ul style="list-style-type: none"> • <code>true</code>: copying ALL data • <code>false</code>: No copying |

Status codes

For details on the status codes of the request for this operation, see the description on HTTP status codes.

Coding example

To get basic journal information:

```
curl -v -H "Accept:application/json" -H "Content-Type:application/json" -H
"Authorization:Session d7b673af189048468c5af9bcf3b6bb6f" -X GET https://
192.0.2.100/ConfigurationManager/v1/objects/journals?journalInfo=basic
```

To get journal time information:

```
curl -v -H "Accept:application/json" -H "Content-Type:application/json" -H
"Authorization:Session d7b673af189048468c5af9bcf3b6bb6f" -X GET https://
192.0.2.100/ConfigurationManager/v1/objects/journals?journalInfo=timer
```

To get detailed journal information:

```
curl -v -H "Accept:application/json" -H "Content-Type:application/json" -H
"Authorization:Session d7b673af189048468c5af9bcf3b6bb6f" -X GET https://
192.0.2.100/ConfigurationManager/v1/objects/journals?journalInfo=detail
```

Getting information about a specific journal

The following request gets basic information about the specified journal. To get journal time information or detailed journal information, run the API function for getting a list of journals.



Note: If the specified journal is used in a 3DC configuration and multiple MUs are set for the journal, information about only one MU can be acquired for the API. In this situation, run the API function for getting a list of journals to get the information about the target journal ID.

Execution permission

Storage Administrator (View Only)

Request line

```
GET base-URL/v1/objects/journals/object-ID
```

Request message

Object ID

Specify the `journalId` value obtained by getting information about the journal.

| Attribute | Type | Description |
|-----------|------|-----------------------|
| journalId | int | (Required) Journal ID |

Query parameters

None.

Body

None.

Response message**Body**

```
{
  "journalId": 0,
  "muNumber": 1,
  "consistencyGroupId": 5,
  "journalStatus": "PJSF",
  "numOfActivePaths": 1,
  "usageRate": 0,
  "qMarker": "575cc653",
  "qCount": 0,
  "byteFormatCapacity": "1.88 G",
  "blockCapacity": 3956736,
  "numOfLdevs": 1,
  "firstLdevId": 513
}
```

| Attribute | Type | Description |
|--------------------|--------|---|
| journalId | int | Journal ID |
| muNumber | int | MU (mirror unit) number |
| consistencyGroupId | int | Consistency group identifier |
| journalStatus | string | Journal volume status For details, see the section explaining the mirror journal statuses. |
| numOfActivePaths | int | Number of active link paths |
| usageRate | int | Usage rate of the journal volume |
| qMarker | string | If the obtained journal is the master journal, the last sequential number (Q-marker) when the journal volume received the write data is output. If the obtained journal is the restore journal, the last sequential number (Q-marker) that is written in the cache is output. |
| qCount | long | Number of <code>qMarker</code> remaining in the master journal volume |
| byteFormatCapacity | string | Capacity of the journal volume The value is output to the second decimal place. |
| blockCapacity | long | Number of blocks of the journal volume |

| Attribute | Type | Description |
|-------------|------|---|
| numOfLdevs | int | Number of LDEVs configuring the journal volume |
| firstLdevId | int | LDEV number of the first LDEV assigned to the journal |

Status codes

For details on the status codes of the request for this operation, see the description on HTTP status codes.

Coding example

```
curl -v -H "Accept:application/json" -H "Content-Type:application/json" -H
"Authorization:Session d7b673af189048468c5af9bcf3bbbb6f" -X GET https://
192.0.2.100/ConfigurationManager/v1/objects/journals/0
```

Creating a journal

The following request creates a journal and then adds a journal volume. Specify a DP volume for a journal volume to be added.

Execution permission

Storage Administrator (Remote Copy)

Request line

```
POST base-URL/v1/objects/journals
```

Request message

Object ID

None.

Query parameters

None.

Body

The following is a coding example for creating a journal by specifying the LDEV number:

```
{
  "journalId": 33,
```

```
"ldevIds": [101,102]
}
```

When creating a journal by specifying the LDEV number

| Attribute | Type | Description |
|-----------|-------|---|
| journalId | int | (Required) Specify the journal ID. Specify a decimal (base 10) number in the range from 0 to 255. |
| ldevIds | int[] | (Required) Specify the LDEV number with a decimal (base 10) number. You can specify up to 2 numbers. |

The following is a coding example for creating a journal by specifying a range of consecutive LDEV numbers:

```
{
  "journalId": 33,
  "startLdevId": 101,
  "endLdevId": 102
}
```

When creating a journal by specifying a range of consecutive LDEV numbers

| Attribute | Type | Description |
|-------------|------|---|
| journalId | int | (Required) Specify the journal ID with a decimal (base 10) number. |
| startLdevId | int | (Required) Specify the first LDEV number by using a decimal (base 10) number. The value of this attribute must be smaller than that of endLdevId. |
| endLdevId | int | (Required) Specify the last LDEV number by using a decimal (base 10) number. The value of this attribute must be greater than that of startLdevId. Specify a number such that the range indicated by the startLdevId and endLdevId attributes consists of no more than 2 LDEVs. |

Response message**Body**

A job object is returned. For details on attributes other than `affectedResources`, see the description on job objects.

| Attribute | Description |
|--------------------------------|----------------------------|
| <code>affectedResources</code> | URL of the created journal |

Status codes

The following table describes the meaning of the status code of the request for this operation. For details on other status codes, see the description on HTTP status codes.

| Status code | Message | Description |
|-------------|----------|---|
| 409 | Conflict | A journal that has the specified journal ID already exists. |

Coding example

```
curl -v -H "Accept:application/json" -H "Content-Type:application/json" -H "Authorization:Session d7b673af189048468c5af9bcf3bbbb6f" -X POST --data-binary @./InputParameters.json https://192.0.2.100/ConfigurationManager/v1/objects/journals
```

The mirror journal status

The following table describes the mirror journal statuses for Universal Replicator.

| Status | Description |
|---------|--|
| SMPL | The mirror is not used. |
| P(S)JNN | The master journal (restore journal) is normal. |
| P(S)JSN | The master journal (restore journal) is in normal split status. |
| P(S)JNF | The master journal (restore journal) is full. |
| P(S)JSF | The master journal (restore journal) is full and split. |
| P(S)JSE | The master journal (restore journal) is split due to an error (including link errors). |

| Status | Description |
|---------|---|
| P(S)JNS | The master journal (restore journal) is in normal split status (for the 3DC multi-target configuration that uses delta resync). |
| P(S)JES | The master journal (restore journal) is split due to an error (for the 3DC multi-target configuration that uses delta resync). |

Changing journal settings

The following request changes the journal settings, such as Data Overflow Watch and the transfer speed.



Note:

If a user uses the REST API to lock the resources of a target storage system, any request that includes a change to the transfer speed (the `copySpeed` attribute) cannot run. In such a case, unlock the resources before performing the operation.

Execution permission

Storage Administrator (Remote Copy)

Request line

```
PATCH base-URL/v1/objects/journals/object-ID
```

Request message

Object ID

Specify the value of `journalId` that was obtained by the processing to get information about journals.

| Attribute | Type | Description |
|------------------------|------|-----------------------|
| <code>journalId</code> | int | (Required) Journal ID |

Query parameters

None.

Body

The following is a coding example for changing the following settings: Data Overflow Watch, cache mode, and transfer speed:

```
{
  "dataOverflowWatchInSeconds": 60,
```

```

    "isCacheModeEnabled": true,
    "copySpeed": 100
  }

```

The following is a coding example for changing the following settings: mirror copy speed and Path Blockade Watch Time for the mirror:

```

{
  "mirrorUnit": {
    "muNumber": 0,
    "copyPace": "M",
    "pathBlockadeWatchInMinutes": 10
  }
}

```

The following is a coding example for changing the following settings: Data Overflow Watch, cache mode, transfer speed, copy speed per mirror, and Path Blockade Watch Time for the mirror:

```

{
  "dataOverflowWatchInSeconds": 60,
  "isCacheModeEnabled": true,
  "copySpeed": 100,
  "mirrorUnit": {
    "muNumber": 0,
    "copyPace": "M",
    "pathBlockadeWatchInMinutes": 10
  }
}

```

| Attribute | Type | Description |
|----------------------------|---------|---|
| dataOverflowWatchInSeconds | int | (Optional) Data Overflow Watch (in seconds) This value is set to 60 by default when a journal is created. If 0 is specified, control on inflow of update I/O to the journal volume will be disabled. |
| isCacheModeEnabled | boolean | (Optional) Specify whether to enable the cache mode setting. <ul style="list-style-type: none"> ▪ true: The cache mode setting is enabled. ▪ false: Disable the cache mode setting. This value is set to true by default when a journal is created. |

| Attribute | Type | Description |
|-----------|------|--|
| copySpeed | int | <p>(Optional) Transfer speed (in Mbps)</p> <p>Specify the transfer speed for data transfer. You can specify one of the following values:</p> <p>3, 10, 100, or 256</p> <p>This value is set to 256 by default when a journal is created.</p> |

| Attribute | Type | Description |
|------------|--------|---|
| mirrorUnit | object | <p>Specify the following attributes for each mirror:</p> <ul style="list-style-type: none"> ▪ (Optional) muNumber (int) MU (mirror unit) number Specify this attribute together with either the <code>copyPace</code> attribute or the <code>pathBlockadeWatchInMinutes</code> attribute. ▪ (Optional) copyPace (string) Copy speed The type is not case sensitive. <ul style="list-style-type: none"> • L: Low speed • M: Medium speed • H: High speed This value is set to L by default when a journal is created. ▪ (Optional) pathBlockadeWatchInMinutes (int) Path Blockade Watch Time (in minutes) Specify a value in the range from 0 to 60. This value is set to 5 by default when a journal is created. If 0 is specified, the Path Blockade Watch Time is not changed, and the function that transfers the Path Blockade Watch Time to the secondary site of the mirror (the RCU) is disabled. If a value other than 0 is specified, the specified value is set as the value for the Path Blockade Watch Time, and the function that transfers the Path Blockade Watch Time to the secondary site of the mirror (the RCU) is enabled. |

Response message**Body**

A job object is returned. For details on attributes other than `affectedResources`, see the description on job objects.

| Attribute | Description |
|-------------------|--|
| affectedResources | URL of the changed journal You can use detailed journal information to check changed setting values. You can obtain detailed information by specifying <code>journalInfo=detail</code> for the query parameter of the API for getting a list of journals. |

Status codes

For details on the status codes of the request for this operation, see the description on HTTP status codes.

Coding example

```
curl -v -H "Accept:application/json" -H "Content-Type:application/json" -H
"Authorization:Session d7b673af189048468c5af9bcf3bbbb6f" -X PATCH --data-
binary @./InputParameters.json https://192.0.2.100/ConfigurationManager/v1/
objects/journals/100
```

Adding a journal volume

The following request adds a journal volume to a journal to expand the journal. Specify a DP volume for a journal volume to be added.

Execution permission

Storage Administrator (Remote Copy)

Request line

```
POST base-URL/v1/objects/journals/object-ID/actions/expand/invoke
```

Request message**Object ID**

Specify the value of `journalId` that was obtained by the processing to get information about journals.

| Attribute | Type | Description |
|------------------------|------|-----------------------|
| <code>journalId</code> | int | (Required) Journal ID |

Query parameters

None.

Body

```
{
  "parameters": {
    "ldevIds": [101]
  }
}
```

| Attribute | Type | Description |
|----------------------|-------|---|
| <code>ldevIds</code> | int[] | (Required) Specify the LDEV number with a decimal (base 10) number. You can specify only one LDEV. |

Response message**Body**

A job object is returned. For details on attributes other than `affectedResources`, see the description on job objects.

| Attribute | Description |
|--------------------------------|--|
| <code>affectedResources</code> | URL of the journal to which a volume was added |

Action template

```
GET base-URL/v1/objects/journals/object-ID/actions/expand
```

Status codes

The following table describes the meaning of the status code of the request for this operation. For details on other status codes, see the description on HTTP status codes.

| Status code | Message | Description |
|-------------|---------------------|---|
| 412 | Precondition Failed | The number of journal volumes that are registered to the target volume is already at the maximum. |

Coding example

To get an action template:

```
curl -v -H "Accept:application/json" -H "Content-Type:application/json" -H
"Authorization:Session d7b673af189048468c5af9bcf3b6bb6f" -X GET https://
192.0.2.100/ConfigurationManager/v1/objects/journals/3/actions/expand
```

To run the request after getting an action template:

```
curl -v -H "Accept:application/json" -H "Content-Type:application/json" -H
"Authorization:Session d7b673af189048468c5af9bcf3b6bb6f" -X POST --data-
binary @./InputParameters.json https://192.0.2.100/ConfigurationManager/v1/
objects/journals/3/actions/expand/invoke
```

Deleting a journal volume from a journal

The following request deletes the specified journal volume from a journal to shrink the journal.

Execution permission

Storage Administrator (Remote Copy)

Request line

```
POST base-URL/v1/objects/journals/object-ID/actions/shrink/invoke
```

Request message**Object ID**

Specify the value of `journalId` that was obtained by the processing to get information about journals.

| Attribute | Type | Description |
|-----------|------|-----------------------|
| journalId | int | (Required) Journal ID |

Query parameters

None.

Body

```
{
  "parameters": {
    "ldevIds": [101]
  }
}
```

| Attribute | Type | Description |
|-----------|-------|---|
| ldevIds | int[] | (Required) Specify the LDEV number with a decimal (base 10) number. You can specify only one LDEV. |

Response message**Body**

A job object is returned. For details on attributes other than `affectedResources`, see the description on job objects.

| Attribute | Description |
|-------------------|--|
| affectedResources | URL of the journal from which a volume was deleted |

Action template

```
GET base-URL/v1/objects/journals/object-ID/actions/shrink
```

Status codes

The following table describes the meaning of the status code of the request for this operation. For details on other status codes, see the description on HTTP status codes.

| Status code | Message | Description |
|-------------|---------------------|--|
| 412 | Precondition Failed | Only one journal volume exists in the target journal, or pairs are created and the status of the journal volume is normal. |

Coding example

To get an action template:

```
curl -v -H "Accept:application/json" -H "Content-Type:application/json" -H
"Authorization:Session d7b673af189048468c5af9bcf3b66b6f" -X GET https://
192.0.2.100/ConfigurationManager/v1/objects/journals/3/actions/shrink
```

To run the request after getting an action template:

```
curl -v -H "Accept:application/json" -H "Content-Type:application/json" -H
"Authorization:Session d7b673af189048468c5af9bcf3b66b6f" -X POST --data-
binary @./InputParameters.json https://192.0.2.100/ConfigurationManager/v1/
objects/journals/3/actions/shrink/invoke
```

Changing the MP blade assigned to a journal

The following request changes the MP blade assigned to a journal.

Execution permission

Storage Administrator (System Resource Management)

Request line

```
POST base-URL/v1/objects/journals/object-ID/actions/assign-mp-blade/invoke
```

Request message**Object ID**

Specify the `journalId` value obtained by getting journal information.

| Attribute | Type | Description |
|-----------|------|-----------------------|
| journalId | int | (Required) Journal ID |

Query parameters

None.

Body

```
{
  "parameters": {
    "mpBladeId": 1
  }
}
```

| Attribute | Type | Description |
|-----------|------|---|
| mpBladeId | int | (Required) The blade number of the MP blade to be assigned to the journal |

Response message

Body

A job object is returned. For details about attributes other than `affectedResources`, see the description of job objects.

| Attribute | Description |
|--------------------------------|---|
| <code>affectedResources</code> | URL of the journal for which the MP blade was changed You can use detailed journal information to check changed setting values. You can obtain detailed information by specifying <code>journalInfo=detail</code> for the query parameter of the API for getting a list of journals. |

Action template

None.

Status codes

For details about the status codes of the request for this operation, see the description of the HTTP status codes.

Coding example

```
curl -v -H "Accept:application/json" -H "Content-Type:application/json" -H "Authorization:Session d7b673af189048468c5af9bcf3b66b6f" -X POST --data-binary @./InputParameters.json https://192.0.2.100/ConfigurationManager/v1/objects/journals/3/actions/assign-mp-blade/invoke
```

Deleting a journal

The following request deletes a journal. A DP volume registered as a journal volume is not deleted. However, the DP volume can no longer be used as a journal.

Execution permission

Storage Administrator (Remote Copy)

Request line

```
DELETE base-URL/v1/objects/journals/object-ID
```

Request message**Object ID**

Specify the value of `journalId` that was obtained by the processing to get information about journals.

| Attribute | Type | Description |
|------------------------|------|-----------------------|
| <code>journalId</code> | int | (Required) Journal ID |

Query parameters

None.

Body

None.

Response message**Body**

A job object is returned. For details on attributes other than `affectedResources`, see the description on job objects.

| Attribute | Description |
|--------------------------------|----------------------------|
| <code>affectedResources</code> | URL of the deleted journal |

Status codes

For details on the status codes of the request for this operation, see the description on HTTP status codes.

Coding example

```
curl -v -H "Accept:application/json" -H "Content-Type:application/json" -H
"Authorization:Session d7b673af189048468c5af9bcf3b66b6f" -X DELETE
https://192.0.2.100/ConfigurationManager/v1/objects/journals/30
```

Setting quorum

This section describes how to use the REST API to configure the settings of the quorum to be used in a global-active device.

Getting information about quorum disks

The following request gets a list of information about quorum disks.

Execution permission

Storage Administrator (View Only)

Request line

```
GET base-URL/v1/objects/quorum-disks
```

Request message

Object ID

None.

Query parameters

None.

Body

None.

Response message

Body

```
{
  "data": [
    {
      "quorumDiskId" : 1,
      "remoteSerialNumber" : "39304",
      "remoteStorageTypeId" : "R9",
      "readResponseGuaranteedTime" : 40
    },
    {
      "quorumDiskId" : 31,
      "remoteSerialNumber" : "39304",
      "remoteStorageTypeId" : "R9",
      "ldevId" : 11432,
      "readResponseGuaranteedTime" : 40,
      "status" : "NORMAL"
    }
  ]
}
```

| Attribute | Type | Description |
|----------------------------|--------|---|
| quorumDiskId | int | ID of the Quorum disk |
| remoteSerialNumber | string | Serial number of the remote storage system with which the quorum disk is shared |
| remoteStorageTypeId | string | Model ID of the remote storage system with which the quorum disk is shared <ul style="list-style-type: none"> ▪ R8: VSP G1000, VSP G1500, or VSP F1500 ▪ R9: VSP 5000 series ▪ M8: VSP E series, VSP Gx00 models or VSP Fx00 models |
| ldevId | int | LDEV number that is set for the quorum disk This attribute is not output for configurations where no volumes are set for quorum disks. |
| readResponseGuaranteedTime | int | Guaranteed read-response time (in seconds) set for the quorum disk when quorum monitoring is stopped |
| status | string | Status of the quorum disk <ul style="list-style-type: none"> ▪ NORMAL: The disk is in a normal state. ▪ TRANSITIONING: The disk is transitioning. ▪ BLOCKED: The disk is blocked. ▪ REPLACING: The disk is being replaced. ▪ FAILED: The disk is in an abnormal state. <p>This attribute is not output for configurations where no volumes are set for quorum disks.</p> |

Status codes

For details on the status codes of the request for this operation, see the description on HTTP status codes.

Coding example

```
curl -v -H "Accept:application/json" -H "Content-Type:application/json" -H
"Authorization:Session d7b673af189048468c5af9bcf3b6bb6f" -X GET https://
192.0.2.100/ConfigurationManager/v1/objects/quorum-disks
```

Getting information about a specific quorum disk

The following request gets information about the specified quorum disk.

Execution permission

Storage Administrator (View Only)

Request line

```
GET base-URL/v1/objects/quorum-disks/object-ID
```

Request message**Object ID**

Specify the value of `quorumDiskId` obtained by the request that gets information about quorum disks.

| Attribute | Type | Description |
|---------------------------|------|---|
| <code>quorumDiskId</code> | int | (Required) ID of the Quorum disk Specify a decimal (base 10) number in the range from 0 to 31. |

Query parameters

None.

Body

None.

Response message**Body**

```
{
  "quorumDiskId": 31,
  "remoteSerialNumber": "39304",
  "remoteStorageTypeId": "R9",
  "ldevId": 1,
  "readResponseGuaranteedTime": 5,
```

```
"status": "NORMAL"
}
```

| Attribute | Type | Description |
|----------------------------|--------|---|
| quorumDiskId | int | ID of the Quorum disk |
| remoteSerialNumber | string | Serial number of the remote storage system with which the quorum disk is shared |
| remoteStorageTypeId | string | Model ID of the remote storage system with which the quorum disk is shared <ul style="list-style-type: none"> ▪ R8: VSP G1000, VSP G1500, or VSP F1500 ▪ R9: VSP 5000 series ▪ M8: VSP E series, VSP Gx00 models or VSP Fx00 models |
| ldevId | int | LDEV number that is set for the quorum disk This attribute is not output for configurations where no volumes are set for quorum disks. |
| readResponseGuaranteedTime | int | Guaranteed read-response time (in seconds) set for the quorum disk when quorum monitoring is stopped |
| status | string | Status of the quorum disk <ul style="list-style-type: none"> ▪ NORMAL: The disk is in a normal state. ▪ TRANSITIONING: The disk is transitioning. ▪ BLOCKED: The disk is blocked. ▪ REPLACING: The disk is being replaced. ▪ FAILED: The disk is in an abnormal state. <p>This attribute is not output for configurations where no volumes are set for quorum disks.</p> |

Status codes

For details on the status codes of the request for this operation, see the description on HTTP status codes.

Coding example

```
curl -v -H "Accept:application/json" -H "Content-Type:application/json" -H
"Authorization:Session d7b673af189048468c5af9bcf3b6bb6f" -X GET https://
192.0.2.100/ConfigurationManager/v1/objects/quorum-disks/31
```

Registering information about a quorum disk

In the storage system, you can register information about the quorum disk to use for global-active device.

**Note:**

You need to specify the same quorum disk ID for the local storage system and for the remote storage system. For each storage system, run the API request that gets information about quorum disks and check for unused quorum disk IDs.

Execution permission

Storage Administrator (Provisioning)

Request line

```
POST base-URL/v1/objects/quorum-disks
```

Request message**Object ID**

None.

Query parameters

None.

Body

```
{
  "quorumDiskId": 1,
  "remoteSerialNumber": "39304",
  "remoteStorageTypeId": "R9",
  "ldevId": 10
}
```

| Attribute | Type | Description |
|--------------|------|---|
| quorumDiskId | int | (Required) ID of the Quorum disk Specify a decimal (base 10) number in the range from 0 to 31. |

| Attribute | Type | Description |
|---------------------|--------|--|
| | | Specify an unused quorum disk ID. |
| remoteSerialNumber | string | (Required) Serial number of the remote storage system with which the quorum disk is shared |
| remoteStorageTypeId | string | (Required) Model ID of the remote storage system with which the quorum disk is shared You can specify the following values: <ul style="list-style-type: none"> ▪ R8: VSP G1000, VSP G1500, or VSP F1500 ▪ R9: VSP 5000 series ▪ M8: VSP E series, VSP Gx00 models or VSP Fx00 models |
| ldevId | int | (Optional) LDEV number to be set for the quorum disk Specify a decimal (base 10) number in the range from 0 to 65279. If you want to register information about a quorum disk with an external volume configured, you must specify this attribute. If you do not specify this attribute, information about the quorum disk will be registered with no external volume configured. |

Response message

Body

A job object is returned. For details on attributes other than `affectedResources`, see the section explaining job objects.

| Attribute | Description |
|--------------------------------|---|
| <code>affectedResources</code> | URL of the registered quorum disk information |

Status codes

For details on the status codes of the request for this operation, see the description on HTTP status codes.

Coding example

```
curl -v -H "Accept:application/json" -H "Content-Type:application/json" -H
"Authorization:Session d7b673af189048468c5af9bcf3b6bb6f" -X POST --data-
binary @./InputParameters.json https://192.0.2.100/ConfigurationManager/v1/
objects/quorum-disks
```

Deleting information about a quorum disk

You can delete information about a quorum disk from the storage system by specifying the Quorum disk ID.

Execution permission

Storage Administrator (Provisioning)

Request line

```
DELETE base-URL/v1/objects/quorum-disks/object-ID
```

Request message**Object ID**

Set the `quorumDiskId` value obtained by getting the information about the quorum disks.

| Attribute | Type | Description |
|--------------|------|---|
| quorumDiskId | int | (Required) ID of the Quorum disk Specify a decimal (base 10) number in the range from 0 to 31. |

Query parameters

None.

Body

None.

Response message**Body**

A job object is returned. For details on attributes other than `affectedResources`, see the section explaining job objects.

| Attribute | Description |
|-------------------|--|
| affectedResources | URL of the deleted quorum disk information |

Status codes

For details on the status codes of the request for this operation, see the description on HTTP status codes.

Coding example

```
curl -v -H "Accept:application/json" -H "Content-Type:application/json" -H  
"Authorization:Session d7b673af189048468c5af9bcf3bbbb6f" -X DELETE  
https://192.0.2.100/ConfigurationManager/v1/objects/quorum-disks/31
```

Chapter 11: Managing TrueCopy pairs or Universal Replicator pairs

This chapter describes how to perform operations on TrueCopy pairs or Universal Replicator pairs by using the REST API.

Overview of TrueCopy and Universal Replicator

TrueCopy and Universal Replicator create a copy of a data volume between storage systems. You can create a pair or manage the pair status by issuing an API operation from a REST API client.

TrueCopy

By synchronizing with the data of the local storage system, TrueCopy copies the data to the remote storage system. Therefore, if the volumes of the local storage system (primary volumes) and the volumes of the remote storage system (secondary volumes) are in the PAIR status, the data is consistent.

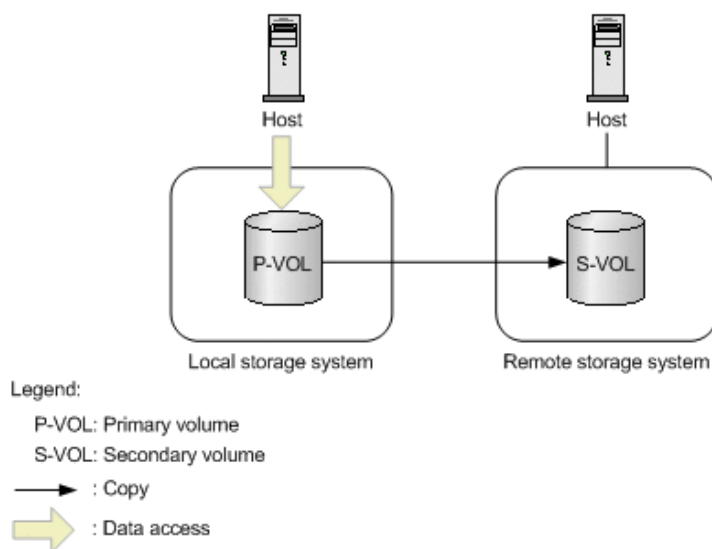

A pair consists of a primary volume and a secondary volume. You can perform operations on pairs in units of copy groups. A copy group is a group made up of copy pairs. Each copy group consists of a device group made up of primary volumes, and a device group made up of secondary volumes.

For details on TrueCopy, see the *Hitachi TrueCopy® User Guide*.

Universal Replicator

Universal Replicator asynchronously copies the data of the local storage system to the data of the remote storage system. The updated data (journal data) is stored in the master journal volume, and is copied to the data of the secondary volumes via the restore journal volume.

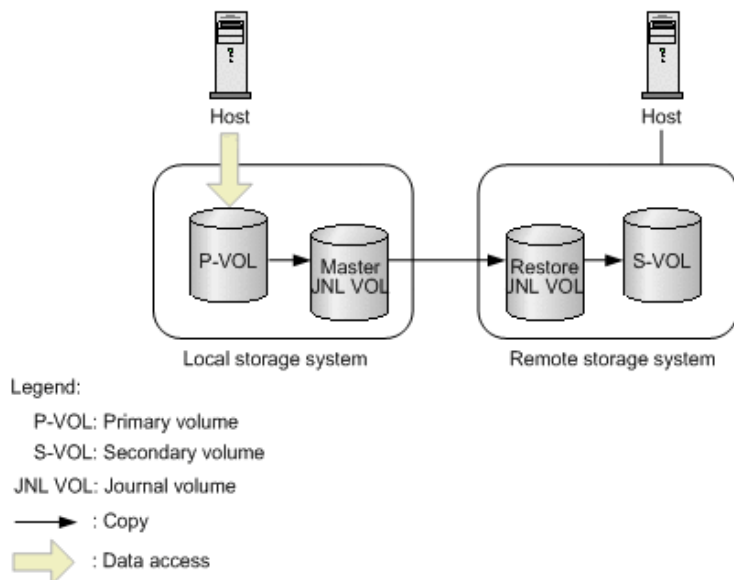

For Universal Replicator, the primary volumes and the master journal volume are called the master journal, and the secondary volumes and the restore journal volume are called the restore journal. Perform operations on pairs in units of mirrors (copy groups) that are the correspondence relationship between the master journal and the restore journal. A mirror (copy group) is a group made up of copy pairs. Each mirror (copy group) consists of a device group made up of primary volumes, and a device group made up of secondary volumes.

For details on Universal Replicator, see the *Hitachi Universal Replicator User Guide*.

Workflow for operating TrueCopy pairs or Universal Replicator pairs

The following figure shows the workflow for performing TrueCopy or Universal Replicator operations.

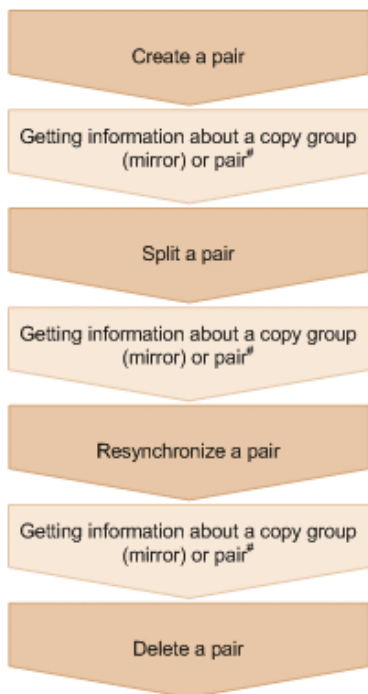

#: Optional operations



Important:

If you perform operations on or get information about TrueCopy or Universal Replicator pairs, specify Remote-Authorization for the request header.

Creating a pair

Create a pair, and then copy all of the data in the P-VOL to the S-VOL. The pair is synchronized. Create a pair in a new copy pair (mirror), or add a pair to an existing copy group.

Getting information about a copy group (mirror) or pair

For TrueCopy, you can perform operations on the pair in units of copy groups or pairs. For Universal Replicator, perform operations on the pair in units of copy groups (mirrors).

Splitting a pair

Split the pair to suspend data copy.

Resynchronizing a pair

Copy the differential data to resynchronize the pair.



Note: Resynchronization can be performed in units of copy groups or pairs. For TrueCopy, if you want to register pairs to a consistency group during resynchronization, perform resynchronization in units of copy groups. Do not perform resynchronization in units of pairs.

Deleting a pair

Dissolve the pair status of the volumes.

Specifying Job-Mode-Wait-Configuration-Change in the request header

During the creation, splitting, and resynchronizing of pairs, if multiple asynchronous processing requests are issued at the same time, jobs might get stuck and the job status might not change to `Completed` because data copying takes a long time. In such cases, specify `Job-Mode-Wait-Configuration-Change:NoWait` in the request header so that the job status changes to `Completed` without waiting for data copying to finish, and the next job starts. At this time, data copying continues even after job execution ends. To check whether data copying has finished, check the pair status of the target resource instead of the job status. For details about the pair status, see the description of the pair status transitions.

Flow of recovery operations to be performed when a failure occurs at the primary site of a Universal Replicator pair

If a failure occurs at the primary site of a Universal Replicator pair, you can use the REST API to perform a failover to the secondary site, in order to ensure continuous operation. After the recovery of the primary site is complete, you can return the pair to the state it was in before the failure occurred by switching operations back to the primary site from the secondary site.

The operations for recovering the Universal Replicator pair can be divided into three general phases:

1. Perform a failover to switch operations over to the secondary site.
2. Copy data from the secondary site to the primary site.
3. Return the pair relationship between the primary site and the secondary site to the state it was in before the failure occurred.

The following explains the flow of operations in each phase.

Performing a failover to switch over business operations to the secondary site

After a failure is detected at the primary site, switch the roles of the primary volume and the secondary volume of the Universal Replicator pair, so that data can be written to the secondary volume, and business operations can continue at the secondary site.



Note: If a failure has occurred at the primary site, pair information of the primary site cannot be obtained. Therefore, to identify the volume at the secondary site to which business operations are to be switched over, you need to know in advance which storage system makes up a pair together with the primary volume of the Universal Replicator pair at the primary site.

The following figure shows the flow of operations:

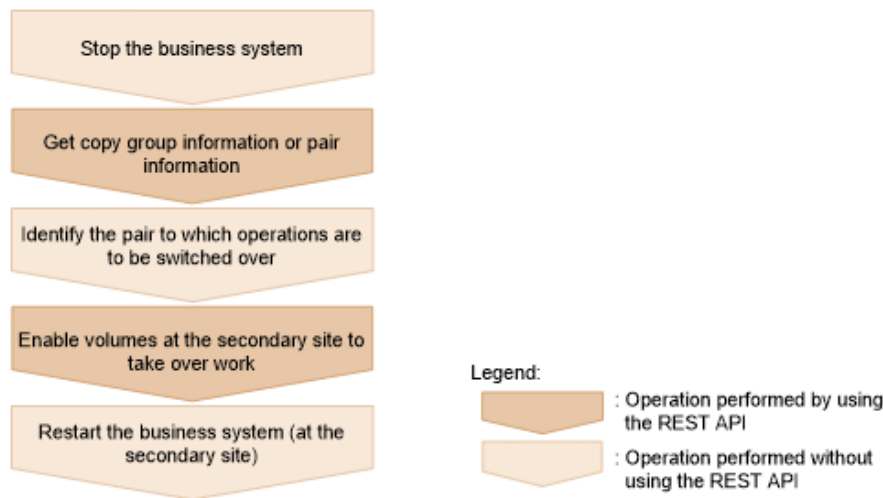

Stop the business system

When a failure is detected at the primary site, stop the business system, and make sure that there is no I/O to or from the hosts.

Get copy group information or pair information

Get a list of the copy groups on the storage system of the secondary site. Then, based on this information, get copy pair information for the secondary site. When executing these API requests, you need to specify remote storage system information for the query parameter or object ID. In this situation, specify NotSpecified.

Identify the pair to which business operations are to be switched over

Based on the pair information for the secondary site, identify the pair to which business operations are to be switched over.

Switch over business operations to a volume at the secondary site

Specify the pair or copy group, and then switch the roles of the primary volume and the secondary volume. Data can now be written to the secondary volume.



Note: When `auto` is specified as the takeover execution mode, the storage systems at the secondary site automatically try to resynchronize with the storage systems at the primary site. If the resynchronization succeeds, you do not need to split and then resynchronize the pair by performing the following flow of operations (the flow of operations for copying data from the secondary site to the primary site). To check whether the resynchronization was successful, get pair information.

Restart the business system (at the secondary site)

Restart the operations of the business system at the secondary site.

Copying data from the secondary site to the primary site

After recovery is complete for the primary site, apply the data that was written to the secondary site during the failure to the primary site. The following figure shows the flow of operations:

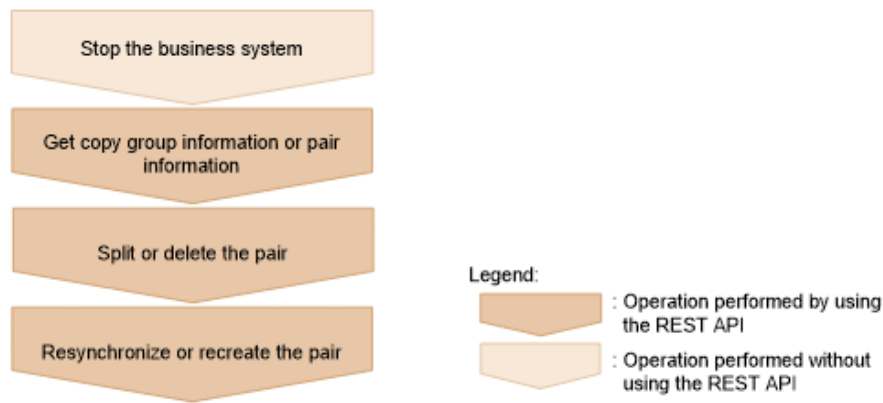

Stop the business system

Stop the business system, and make sure that there is no I/O to or from the hosts.

Get copy group information or pair information

Get copy pair information based on the copy group information, and then check the pair status.

Split or delete the pair

Perform one of the following operations if necessary, according to the pair status:

- If the pair status of the S-VOL is SSWS, split the pair.
- If the pair status of the P-VOL or the S-VOL is SMPL, delete the pair.

Resynchronize or re-create the pair

Perform one of the following operations if necessary, according to the pair status:

- If the pair status of the S-VOL is SSWS, resynchronize the pair at the secondary site (the S-VOL). At this time, specify `true` for `doSwapSvol`.
- If the pair status of both the primary site and the secondary site is SMPL, create a pair by specifying the P-VOL for the secondary site.

Returning the pair relationship between the primary site and the secondary site to the state it was in before the failure

When all pair statuses are PAIR and all data on the secondary site is applied to the primary site, normal operation can be restarted at the primary site. The following figure shows the flow of operations:

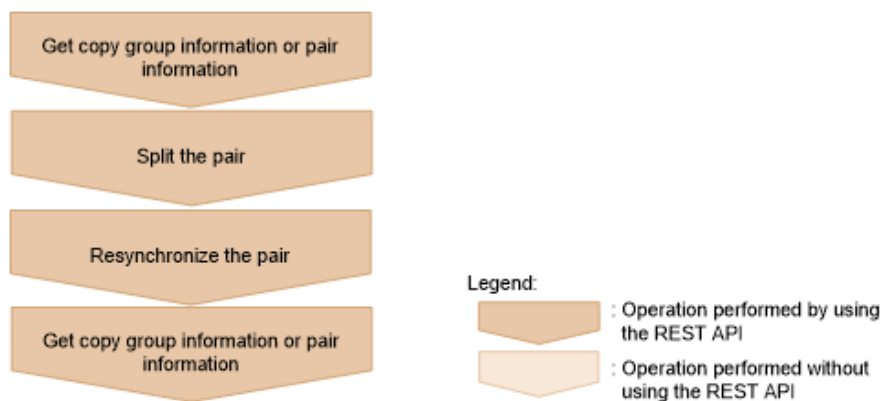

Get copy group information or pair information

Get pair information based on copy group information, and make sure that the status of the target pair is `PAIR`.

Split the pair

Split the pair.

Resynchronize the pair

Resynchronize the pair at the primary site (P-VOL). Specify `true` for `doSwapSvol`.

Get copy group information or pair information

Get pair information based on copy group information, and make sure that the status of the target pair is `PAIR`.

The pair relationship between the primary site and the secondary site and the copy direction are returned to the state they were in before the failure, and the business system can now be restarted.



Pair status (TrueCopy and Universal Replicator)

This section explains the operations and status transition for TrueCopy pairs and Universal Replicator pairs.

Pair status for TrueCopy pairs

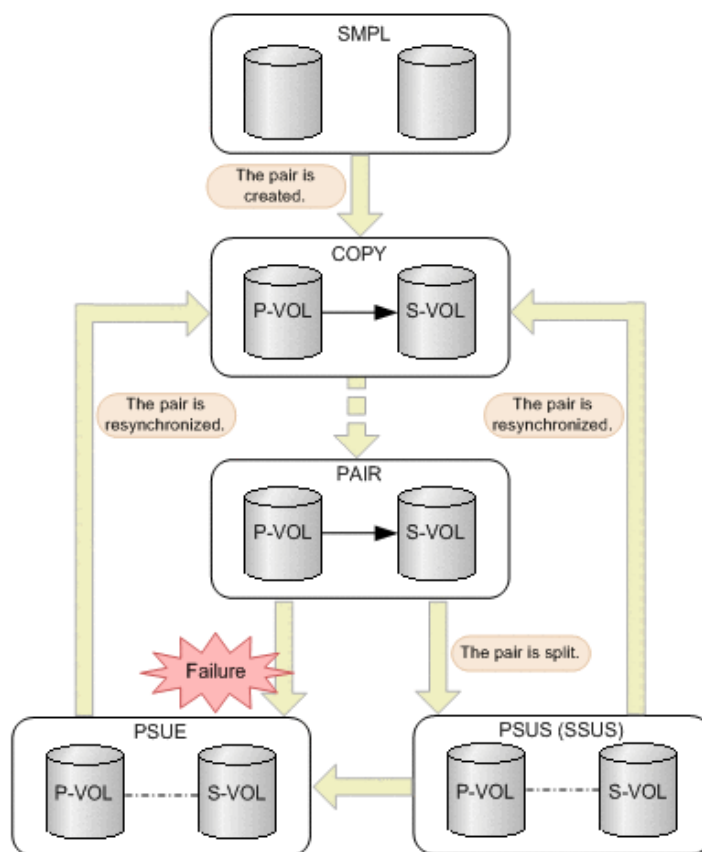
The following explains the operations and status transitions for TrueCopy pairs.



Legend:
 P-VOL: Primary volume
 S-VOL: Secondary volume
 : Indicates an operation for the pair by the REST API.
 : Indicates the status of the pair.

| Pair status | Description | Access to the P-VOL | Access to the S-VOL |
|-------------|---|---------------------|---------------------|
| SMPL | Unpaired volumes | -- | -- |
| COPY | A pair is being created. An initial copy or resynchronization is being performed. | R/W enabled | R enabled |
| PAIR | Paired volumes The initial copy finished, and the pair volumes are synchronized. | R/W enabled | R enabled |
| PSUS | The pair is split by operation, or deleted from the storage system on the secondary site. (This value is output for the P-VOL.) | R/W enabled | R/W enabled |

| Pair status | Description | Access to the P-VOL | Access to the S-VOL |
|-------------|---|---------------------|---------------------|
| | | | #1 |
| SSUS | The pair is split by operation, or deleted from the storage system on the secondary site. (This value is output for the S-VOL.) | R/W enabled | R/W enabled #1 |
| PSUE | The pair is split due to a failure. | R/W enabled #2 | R enabled |
| SSWS | The P-VOL and S-VOL are switched, and the S-VOL is writable. | R enabled | R/W enabled |

#1: When you split a pair, you can specify whether to permit read-write or read-only.

#2: When the fence level of the P-VOL is DATA (S-VOL data), read-only is permitted.

If you delete a pair, the pair status changes to SMPL.

Pair status for Universal Replicator pairs

The following explains the operations and status transitions for Universal Replicator pairs.

Universal Replicator pairs have specific pair statuses because Universal Replicator pairs use the journal volume to asynchronously copy data.

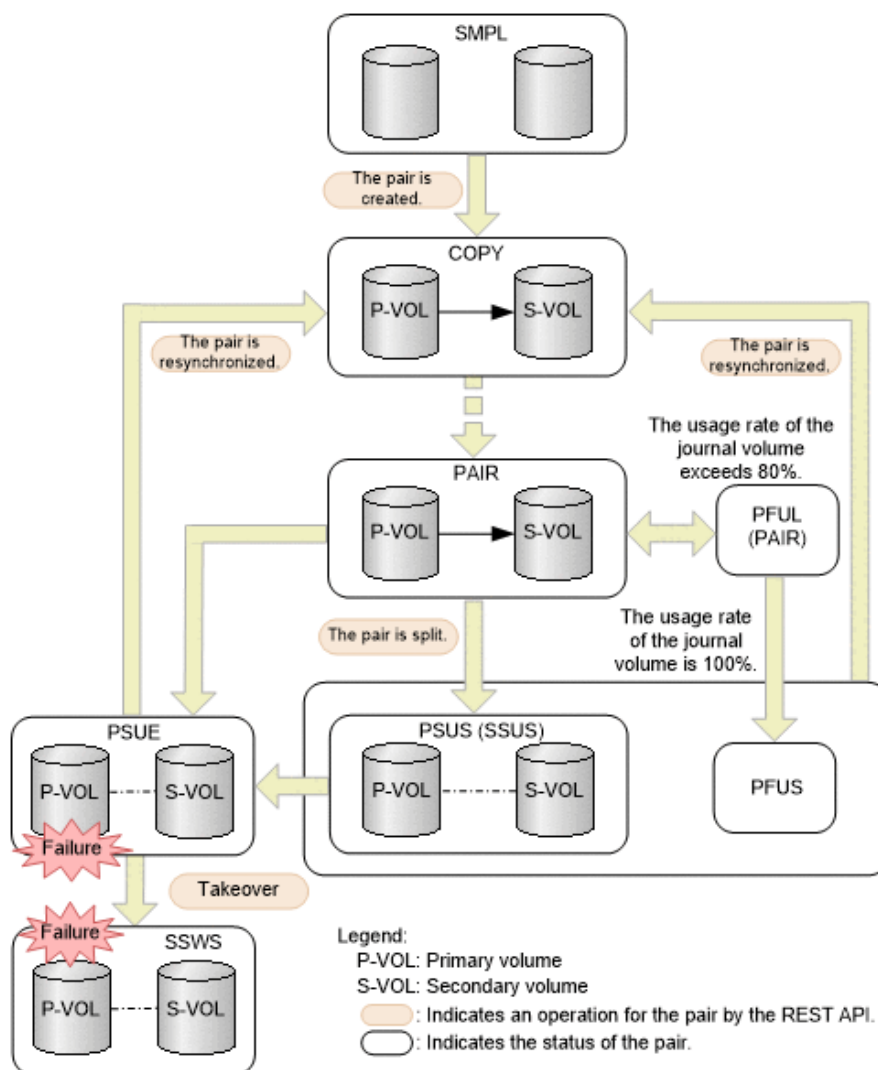

| Pair status | Description | Access to the P-VOL | Access to the S-VOL |
|-------------|---|---------------------|---------------------|
| SMPL | Unpaired volumes | -- | -- |
| COPY | A pair is being created. An initial copy or resynchronization is being performed. | R/W enabled | R enabled |
| PAIR | Paired volumes The initial copy is finished, and the pair volumes are synchronized. | R/W enabled | R enabled |
| PSUS | The pair is split by operation, or deleted from the storage system on the secondary site. (This value is output for the P-VOL.) | R/W enabled | R/W enabled |

| Pair status | Description | Access to the P-VOL | Access to the S-VOL |
|-------------|---|---------------------|---------------------|
| | | | # |
| SSUS | The pair is split by operation, or deleted from the storage system on the secondary site. (This value is output for the S-VOL.) | R/W enabled | R/W enabled # |
| PSUE | The pair is split due to a failure. | R/W enabled | R enabled |
| SSWS | The P-VOL and S-VOL are switched, and the S-VOL is writable. | R enabled | R/W enabled |
| PFUL | The amount of the data in the journal volume exceeds the threshold (80%). The pair is not split, and data continues to be copied. | R/W enabled | R enabled |
| PFUS | The amount of the data in the journal volume reaches 100%, and the pair is split. You must review the configurations of remote paths and the journal volume. | R/W enabled | R enabled # |

#: This is determined by the secondary volume's access mode that is specified to split the pair. (Default: Read is enabled.)

If you delete a pair, the pair status changes to SMPL.



Note:

In the following cases, if you perform an operation on a pair, the request successfully returns a response, but the details specified in the request body are not actually applied:

- When you perform a pair splitting operation on a pair for which the status is PSUS or SSUS
- When you perform a pair resynchronization operation on a pair for which the status is COPY or PAIR

Getting a list of remote copy groups

The following request gets a list of all the remote copy groups in which the remote copy pairs (TrueCopy, Universal Replicator, and global-active device) of the target storage system are registered. If the device group name or copy group name contains spaces, copy group information cannot be obtained.

Execution permission

Storage Administrator (View Only)

Request lineGET *base-URL/v1/objects/remote-mirror-copygroups***Request message****Object ID**

None.

Query parameters

You can get only a list of remote copy groups, or you can get detailed information about remote copy pairs in addition to a list of remote copy groups.

- To get a list of remote copy groups only:

| Parameter | Type | Filter condition |
|-----------------------|--------|---|
| remoteStorageDeviceId | string | <p>(Required) Storage device ID of the remote storage system</p> <p>If a failure occurs in a remote storage system and you then specify <code>NotSpecified</code>, only the information about the local storage system is obtained. In this situation (when a failure occurs and you specify <code>NotSpecified</code>), you do not need to specify the <code>Remote-Authorization</code> header.</p> |

| Parameter | Type | Filter condition |
|-----------|------|--|
| | | If you specify <code>NotSpecified</code> for this parameter, you cannot specify the <code>detailInfoType</code> parameter. |

- To obtain additional detailed information:

| Parameter | Type | Description |
|-----------------------------|--------|--|
| <code>detailInfoType</code> | string | <p>(Optional) Type of detailed information to be obtained</p> <ul style="list-style-type: none"> ▪ <code>pair</code> <p>Gets additional detailed information[#] about remote copy pairs.</p> <p>You can specify this item for VSP 5000 series.</p> <p>To get up-to-date information, you must run the API request that refreshes the storage system's cache before running this request. For details, see "Updating the cache of storage system configuration information".</p> <p>If you specify <code>NotSpecified</code> for the <code>remoteStorageDeviceId</code> parameter, you cannot specify this parameter.</p> |

[#]: If the remote storage system is a VSP E series, VSP G350, G370, G700, G900 or VSP F350, F370, F700, F900 model storage system, you might not be able to get some of the information about the remote storage system.

For other storage systems, if the remote storage system's microcode version meets the following conditions, you might not be able to get some of the information about the remote storage system.

- For a VSP 5000 series storage system:
The microcode version is earlier than 90-01-42-XX/XX.
- For a VSP G1000, VSP G1500, VSP F1500 model storage system:
The microcode version is earlier than 80-06-71-XX/XX.

Body

None.

Response message**Body**

```

{
  "data" : [ {
    "remoteMirrorCopyGroupId" : "886000123789,remoteCopyGroup1,
remoteCopyGroup1S_,remoteCopyGroup1P_",
    "copyGroupName" : "remoteCopyGroup1",
    "muNumber" : 0,
    "remoteStorageDeviceId" : "886000123789",
    "localDeviceGroupName" : "remoteCopyGroup1S_",
    "remoteDeviceGroupName" : "remoteCopyGroup1P_"
  }, {
    "remoteMirrorCopyGroupId" : "886000123789,remoteCopyGroup2,
remoteCopyGroup2P_,remoteCopyGroup2S_",
    "copyGroupName" : "remoteCopyGroup2",
    "muNumber" : 0,
    "remoteStorageDeviceId" : "886000123789",
    "localDeviceGroupName" : "remoteCopyGroup2P_",
    "remoteDeviceGroupName" : "remoteCopyGroup2S_"
  }, {
    "remoteMirrorCopyGroupId" : "886000123789,remoteCopyGroup3,
remoteCopyGroup3P_,remoteCopyGroup3S_",
    "copyGroupName" : "remoteCopyGroup3",
    "muNumber" : 0,
    "remoteStorageDeviceId" : "886000123789",
    "localDeviceGroupName" : "remoteCopyGroup3P_",
    "remoteDeviceGroupName" : "remoteCopyGroup3S_"
  } ]
}

```

| Attribute | Type | Description |
|-----------------------|--------|--|
| remoteStorageDeviceId | string | Storage device ID of the remote storage system If you specify NotSpecified for remoteStorageDeviceId, NotSpecified is output. |
| copyGroupName | string | Copy group name |
| localDeviceGroupName | string | Device group name in the local storage system |
| remoteDeviceGroupName | string | Device group name in the remote storage system If you specify NotSpecified for remoteStorageDeviceId, NotSpecified is output. |
| muNumber | int | MU (mirror unit) number |

| Attribute | Type | Description |
|-------------------------|--------|---|
| | | If the MU number cannot be obtained, information is not output. |
| remoteMirrorCopyGroupId | string | Object ID of the remote copy group The following attributes are output, separated by commas: <ul style="list-style-type: none"> ▪ remoteStorageDeviceId ▪ copyGroupName ▪ localDeviceGroupName ▪ remoteDeviceGroupName |

If you run the request with `pair` specified for the query parameter `detailInfoType`, you can get the following information, in addition to information about remote copy groups:

| Attribute | Type | Description |
|-----------|----------|--|
| copyPairs | object[] | Detailed information about the remote copy pair is output. |

| Attribute | Type | Description |
|-----------|------|---|
| | | If information cannot be acquired, the attributes under the <code>copyPairs</code> object are not output. |

| Attribute | Type | Description |
|-----------|------|---|
| | | <ul style="list-style-type: none"> ▪ copyGroupName (string) Copy group name ▪ copyPairName (string) Copy pair name ▪ replicationType (string) Pair type <ul style="list-style-type: none"> • TC: TrueCopy • UR: Universal Replicator • GAD: global-active device <p>If the pair status is <code>SMPL</code>, information is not output.</p> ▪ pvolDevId (int) LDEV number of P-VOL ▪ svolDevId (int) LDEV number of S-VOL ▪ fenceLevel (string) Fence level <ul style="list-style-type: none"> ▪ DATA: S-VOL data ▪ STATUS: S-VOL status ▪ NEVER: None ▪ ASYNC: Asynchronous <p>If the fence level cannot be obtained, information is not output.</p> ▪ pvolJournalId (int) Journal ID of the P-VOL A value from 0 to 255 is output only in the case of Universal Replicator. This information is not output if the pair type cannot be obtained. ▪ svolJournalId (int) Journal ID of the S-VOL A value from 0 to 255 is output only in the case of Universal Replicator. This information |

| Attribute | Type | Description |
|-----------|------|---|
| | | <p>is not output if the pair type cannot be obtained.</p> <ul style="list-style-type: none"> <li data-bbox="829 338 1424 541"> <p>▪ quorumDiskId (int)</p> <p>ID of the Quorum disk</p> <p>A value from 0 to 31 is output only in the case of global-active device. This information is not output if the pair type cannot be obtained.</p> <li data-bbox="829 558 1424 1003"> <p>▪ pvolStatus (string)</p> <p>Pair status of the P-VOL</p> <p>For details, see the section explaining on pair status (TrueCopy and Universal Replicator) or pair status (global-active device).</p> <p>If the pair status cannot be obtained, information is not output.</p> <p>In the case of Universal Replicator, if the transition status of the Universal Replicator pair is <i>Suspending</i> or <i>Deleting</i>, information is not output.</p> <li data-bbox="829 1020 1424 1465"> <p>▪ svolStatus (string)</p> <p>Pair status of the S-VOL</p> <p>For details, see the section explaining on pair status (TrueCopy and Universal Replicator) or pair status (global-active device).</p> <p>If the pair status cannot be obtained, information is not output.</p> <p>In the case of Universal Replicator, if the transition status of the Universal Replicator pair is <i>Suspending</i> or <i>Deleting</i>, information is not output.</p> <li data-bbox="829 1482 1424 1644"> <p>▪ consistencyGroupId (int)</p> <p>Consistency group ID</p> <p>If no consistency group consists, information is not output.</p> <li data-bbox="829 1661 1424 1843"> <p>▪ pvolIOMode (string)</p> <p>I/O mode of the P-VOL</p> <ul style="list-style-type: none"> <li data-bbox="867 1766 1097 1797">▪ L/M: Mirror (RL) <li data-bbox="867 1814 1032 1845">▪ L/L: Local |

| Attribute | Type | Description |
|-----------|------|--|
| | | <ul style="list-style-type: none"> ▪ B/B: Block <p>Information is output only in the case of global-active device. If the pair status is <code>SMPL</code>, information is not output.</p> <ul style="list-style-type: none"> ▪ <code>svollOMode</code> (string) <p>I/O mode of the S-VOL</p> <ul style="list-style-type: none"> ▪ L/M: Mirror (RL) ▪ L/L: Local ▪ B/B: Block <p>Information is output only in the case of global-active device. If the pair status is <code>SMPL</code>, information is not output.</p> <ul style="list-style-type: none"> ▪ <code>pvolStorageDeviceId</code> (string) <p>Storage device ID of the storage system on the P-VOL</p> <ul style="list-style-type: none"> ▪ <code>svolStorageDeviceId</code> (string) <p>Storage device ID of the storage system on the S-VOL</p> <ul style="list-style-type: none"> ▪ <code>remoteMirrorCopyPairId</code> (string) <p>Object ID of the remote copy pair</p> <p>The following attributes are output, separated by commas:</p> <ul style="list-style-type: none"> ▪ <code>remoteStorageDeviceId</code> ▪ <code>copyGroupName</code> ▪ <code>localDeviceGroupName</code> ▪ <code>remoteDeviceGroupName</code> ▪ <code>copyPairName</code> <ul style="list-style-type: none"> ▪ <code>transitionStatus</code> (string) <p>The transition status of a pair is output for a Universal Replicator pair.</p> <ul style="list-style-type: none"> • <code>None</code>: The pair is not in transition. • <code>Suspending</code>: The pair is being split. • <code>Deleting</code>: The pair is being deleted. |

| Attribute | Type | Description |
|-----------|------|--|
| | | <p>This is not output if the copy pair is not a Universal Replicator pair.</p> <ul style="list-style-type: none"> ▪ copyPace (int) Copy speed This is not output if copy pair is Universal Replicator. ▪ pathGroupId (int) ID of the RCU path group This is not output if CU is specified for the remote path connection setting. This is not output if the pair status of the P-VOL or the S-VOL is <i>SMPL</i>. ▪ deltaStatus (string) Status of the 3DC multi-target configuration that uses delta resync This is output if the pair type is Universal Replicator and the 3DC multi-target configuration that uses delta resync is used. <ul style="list-style-type: none"> • HOLD: Universal Replicator delta resync pair (normal) • HLDE: Universal Replicator delta resync pair (failed) • HOLDING: In the process of being changed to a Universal Replicator delta resync pair |

Status codes

For details on the status codes of the request for this operation, see the description on HTTP status codes.

Coding example

```
curl -v -H "Accept: application/json" -H "Remote-Authorization:Session
10399a1ffce3489b9c3a823017462396" -H "Authorization:Session
d7b673af189048468c5af9bcf3bbbbb6f" -X GET https://192.0.2.100/
ConfigurationManager/v1/objects/remote-mirror-copygroups?
remoteStorageDeviceId=886000123789
```

Getting information about a specific remote copy group

The following request gets information about the specified copy group. This request also gets information about the pairs (TrueCopy, Universal Replicator, or global-active device) included in the copy group. If the copy group name or copy pair name contains spaces, pair information cannot be obtained.

Execution permission

Storage Administrator (View Only)

Request line

```
GET base-URL/v1/objects/remote-mirror-copygroups/object-ID
```

Request message

Object ID

Specify the value of `remoteMirrorCopyGroupId` that was obtained by the processing to get information about the remote copy group. You can also specify the attributes and connect them with commas as follows:

```
remoteStorageDeviceId, copyGroupName, localDeviceGroupName,  
remoteDeviceGroupName
```

| Attribute | Type | Description |
|-----------------------|--------|--|
| remoteStorageDeviceId | string | (Required) Storage device ID of the remote storage system# Specify a decimal (base 10) number equal to or greater than 0. |
| copyGroupName | string | (Required) Copy group name Specify a character string consisting of 1 to 31 characters. The name is case sensitive. |
| localDeviceGroupName | string | (Required) Device group name in the local storage system Specify a character string consisting of 1 to 31 characters. The name is case sensitive. |
| remoteDeviceGroupName | string | (Required) Device group name in the remote storage system# Specify a character string consisting of 1 to 31 characters. The name is case sensitive. |

#: If you specify `NotSpecified` in cases such as when a failure occurs in a remote storage system, only information about the local storage system can be acquired. If you specify `NotSpecified`, copy pair information about attributes of volumes that belong to the remote storage system will not be output. In this case, you do not need to specify the `Remote-Authorization` header.

Query parameters

| Parameter | Type | Description |
|-----------------------------|--------|--|
| <code>detailInfoType</code> | string | <p>(Optional) Type of detailed information to be obtained</p> <ul style="list-style-type: none"> ▪ <code>class</code> <p>Adds additional information# from the storage system's cache.</p> <p>You can specify this item for VSP 5000 series.</p> <p>To get up-to-date information, you must run the API request that refreshes the storage system's cache before running this request. For details, see "Updating the cache of storage system configuration information".</p> |

#: If the remote storage system is a VSP E series, VSP G350, G370, G700, G900 or VSP F350, F370, F700, F900 model storage system, you might not be able to get some of the information about the remote storage system.

For other storage systems, if the remote storage system's microcode version meets the following conditions, you might not be able to get some of the information about the remote storage system.

- For a VSP 5000 series storage system:
The microcode version is earlier than 90-01-42-XX/XX.
- For a VSP G1000, VSP G1500, VSP F1500 model storage system:
The microcode version is earlier than 80-06-71-XX/XX.

Body

None.

Response message**Body**

The following is an example of the output when information about TrueCopy pairs is obtained:

```
{
  "remoteMirrorCopyGroupId" : "886000123789,remoteCopyGroup1,
remoteCopyGroup1P_,remoteCopyGroup1S_",
  "copyGroupName" : "remoteCopyGroup1",
  "copyPairs" : [ {
    "copyGroupName" : "remoteCopyGroup1",
    "copyPairName" : "pair1",
    "replicationType" : "TC",
    "remoteMirrorCopyPairId" : "886000123789,remoteCopyGroup1,
remoteCopyGroup1P_,remoteCopyGroup1S_,pair1",
    "pvolLdevId" : 2108,
    "svolLdevId" : 1581,
    "fenceLevel" : "DATA",
    "pvolStatus" : "PAIR",
    "svolStatus" : "PAIR",
    "consistencyGroupId": 5,
    "pvolStorageDeviceId" : "886000123456",
    "svolStorageDeviceId" : "886000123789",
    "pvolDifferenceDataManagement": "S",
    "svolDifferenceDataManagement": "S",
    "pvolProcessingStatus": "N",
    "svolProcessingStatus": "N"
  }, {
    "copyGroupName" : "remoteCopyGroup1",
    "copyPairName" : "pair2",
    "replicationType" : "TC",
    "remoteMirrorCopyPairId" : "886000123789,remoteCopyGroup1,
remoteCopyGroup1P_,remoteCopyGroup1S_,pair2",
    "pvolLdevId" : 2109,
    "svolLdevId" : 1582,
    "fenceLevel" : "DATA",
    "pvolStatus" : "PSUS",
    "svolStatus" : "SMPL",
    "consistencyGroupId": 5,
    "pvolStorageDeviceId" : "886000123456",
    "svolStorageDeviceId" : "886000123789",
    "pvolDifferenceDataManagement": "S",
    "svolDifferenceDataManagement": "S",
    "pvolProcessingStatus": "N",
    "svolProcessingStatus": "N"
  } ],
  "remoteStorageDeviceId" : "886000123789",
  "localDeviceGroupName" : "remoteCopyGroup1P_",
}
```



```

"remoteDeviceGroupName" : "remoteCopyGroup1S_"
}

```

The following is an example of the output when information about Universal Replicator pairs is obtained:

```

{
  "remoteMirrorCopyGroupId" : "886000123789,remoteCopyGroup2,
remoteCopyGroup2P_,remoteCopyGroup2S_",
  "copyGroupName" : "remoteCopyGroup2",
  "copyPairs" : [ {
    "copyGroupName" : "remoteCopyGroup2",
    "copyPairName" : "pair1",
    "replicationType" : "UR",
    "remoteMirrorCopyPairId" : "886000123789,remoteCopyGroup2,
remoteCopyGroup2P_,remoteCopyGroup2S_,pair1",
    "consistencyGroupId" : 10,
    "pvolLdevId" : 1569,
    "pvolJournalId" : 13,
    "svolLdevId" : 2835,
    "svolJournalId" : 36,
    "fenceLevel" : "ASYNC",
    "pvolStatus" : "PAIR",
    "svolStatus" : "PAIR",
    "pvolStorageDeviceId" : "886000123456",
    "svolStorageDeviceId" : "886000123789",
    "pvolDifferenceDataManagement" : "S",
    "svolDifferenceDataManagement" : "S",
    "pvolProcessingStatus" : "N",
    "svolProcessingStatus" : "N"
  } ],
  "remoteStorageDeviceId" : "886000123789",
  "localDeviceGroupName" : "remoteCopyGroup2P_",
  "remoteDeviceGroupName" : "remoteCopyGroup2S_"
}

```

The following is an example of the output when information about global-active device pairs is obtained:

```

{
  "remoteMirrorCopyGroupId" : "886000123789,remoteCopyGroup3,
remoteCopyGroup3P_,remoteCopyGroup3S_",
  "copyGroupName" : "remoteCopyGroup3",
  "copyPairs" : [ {
    "copyGroupName" : "remoteCopyGroup3",
    "copyPairName" : "pair1",
    "replicationType" : "GAD",
    "remoteMirrorCopyPairId" : "886000123789,remoteCopyGroup3,
remoteCopyGroup3P_,remoteCopyGroup3S_,pair1",

```

```

"quorumDiskId" : 14,
"pvolLdevId" : 1580,
"svolLdevId" : 2128,
"fenceLevel" : "NEVER",
"pvolStatus" : "PAIR",
"svolStatus" : "PAIR",
"pvolIOMode" : "L/M",
"svolIOMode" : "L/M",
"pvolStorageDeviceId" : "886000123456",
"svolStorageDeviceId" : "886000123789",
"pvolDifferenceDataManagement": "S",
"svolDifferenceDataManagement": "S",
"pvolProcessingStatus": "N",
"svolProcessingStatus": "N"
} ],
"remoteStorageDeviceId" : "886000123789",
"localDeviceGroupName" : "remoteCopyGroup3P_",
"remoteDeviceGroupName" : "remoteCopyGroup3S_"
}

```

| Attribute | Type | Description |
|-------------------------|--------|---|
| remoteStorageDeviceId | string | Storage device ID of the remote storage system If you specify a value that includes <code>NotSpecified</code> for the object ID, <code>NotSpecified</code> is output. |
| copyGroupName | string | Copy group name |
| localDeviceGroupName | string | Device group name in the local storage system |
| remoteDeviceGroupName | string | Device group name in the remote storage system If you specify a value that includes <code>NotSpecified</code> for the object ID, <code>NotSpecified</code> is output. |
| remoteMirrorCopyGroupID | string | Object ID of the remote copy group The following attributes are output, separated by commas: <ul style="list-style-type: none"> ▪ remoteStorageDeviceId ▪ copyGroupName ▪ localDeviceGroupName ▪ remoteDeviceGroupName |

| Attribute | Type | Description |
|-----------|----------|---|
| copyPairs | object[] | The detailed information about the copy pair is output. |

| Attribute | Type | Description |
|-----------|------|--|
| | | <ul style="list-style-type: none"> <li data-bbox="846 254 1175 331">▪ copyGroupName (string) Copy group name <li data-bbox="846 352 1149 430">▪ copyPairName (string) Copy pair name <li data-bbox="846 451 1154 583">▪ replicationType (string) Pair type <ul style="list-style-type: none"> <li data-bbox="883 556 1084 583">▪ TC: TrueCopy <li data-bbox="883 604 1206 632">▪ UR: Universal Replicator <li data-bbox="883 653 1219 680">▪ GAD: global-active device <p data-bbox="883 709 1390 772">If the pair status is <code>SMPL</code>, information is not output.</p> <li data-bbox="846 800 1346 1031">▪ pvolLdevId (int) LDEV number of P-VOL If you specify a value that includes <code>NotSpecified</code> for the object ID, this attribute is output only if the P-VOL is a volume in the local storage system. <li data-bbox="846 1058 1346 1289">▪ svolLdevId (int) LDEV number of S-VOL If you specify a value that includes <code>NotSpecified</code> for the object ID, this attribute is output only if the S-VOL is a volume in the local storage system. <li data-bbox="846 1316 1190 1598">▪ fenceLevel (string) Fence level <ul style="list-style-type: none"> <li data-bbox="883 1415 1138 1442">▪ DATA: S-VOL data <li data-bbox="883 1463 1190 1491">▪ STATUS: S-VOL status <li data-bbox="883 1512 1081 1539">▪ NEVER: None <li data-bbox="883 1560 1183 1587">▪ ASYNC: Asynchronous <p data-bbox="883 1617 1317 1680">If the fence level cannot be obtained, information is not output.</p> <li data-bbox="846 1709 1166 1787">▪ pvolJournalId (int) Journal ID of the P-VOL |

| Attribute | Type | Description |
|-----------|------|--|
| | | <p>A value from 0 to 255 is output only in the case of Universal Replicator. If the pair status is <code>SMPL</code>, information is not output.</p> <p>If you specify a value that includes <code>NotSpecified</code> for the object ID, this attribute is output only if the P-VOL is a volume in the local storage system.</p> <ul style="list-style-type: none"> ▪ <code>svolJournalId</code> (int) Journal ID of the S-VOL <p>A value from 0 to 255 is output only in the case of Universal Replicator. If the pair status is <code>SMPL</code>, information is not output.</p> <p>If you specify a value that includes <code>NotSpecified</code> for the object ID, this attribute is output only if the S-VOL is a volume in the local storage system.</p> <ul style="list-style-type: none"> ▪ <code>quorumDiskId</code> (int) ID of the Quorum disk <p>A value from 0 to 31 is output only in the case of global-active device. If the pair status is <code>SMPL</code>, information is not output.</p> <ul style="list-style-type: none"> ▪ <code>pvolStatus</code> (string) Pair status of the P-VOL <p>For details, see the section explaining on pair status (TrueCopy and Universal Replicator) or pair status (global-active device).</p> <p>If the pair status cannot be obtained, information is not output.</p> <p>If you specify a value that includes <code>NotSpecified</code> for the object ID, this attribute is output only if the P-VOL is a volume in the local storage system.</p> <ul style="list-style-type: none"> ▪ <code>svolStatus</code> (string) Pair status of the S-VOL <p>For details, see the section explaining on pair status (TrueCopy and Universal Replicator) or pair status (global-active device).</p> |

| Attribute | Type | Description |
|-----------|------|---|
| | | <p>If the pair status cannot be obtained, information is not output.</p> <p>If you specify a value that includes <code>NotSpecified</code> for the object ID, this attribute is output only if the S-VOL is a volume in the local storage system.</p> <ul style="list-style-type: none"> ▪ consistencyGroupId (int) Consistency group ID <p>If no consistency group consists, information is not output.</p> <ul style="list-style-type: none"> ▪ pvollOMode (string) I/O mode of the P-VOL <ul style="list-style-type: none"> ▪ L/M: Mirror (RL) ▪ L/L: Local ▪ B/B: Block <p>Information is output only in the case of global-active device. If the pair status is <code>SMPL</code>, information is not output.</p> <p>If you specify a value that includes <code>NotSpecified</code> for the object ID, this attribute is output only if the P-VOL is a volume in the local storage system.</p> <ul style="list-style-type: none"> ▪ svollOMode (string) I/O mode of the S-VOL <ul style="list-style-type: none"> ▪ L/M: Mirror (RL) ▪ L/L: Local ▪ B/B: Block <p>Information is output only in the case of global-active device. If the pair status is <code>SMPL</code>, information is not output.</p> <p>If you specify a value that includes <code>NotSpecified</code> for the object ID, this attribute is output only if the S-VOL is a volume in the local storage system.</p> <ul style="list-style-type: none"> ▪ pvolStorageDeviceId (string) Storage device ID of the storage system on the P-VOL |

| Attribute | Type | Description |
|-----------|------|--|
| | | <p>If you specify a value that includes <code>NotSpecified</code> for the object ID, this attribute is output only if the P-VOL is a volume in the local storage system.</p> <ul style="list-style-type: none"> ▪ <code>svolStorageDeviceId</code> (string) Storage device ID of the storage system on the S-VOL <p>If you specify a value that includes <code>NotSpecified</code> for the object ID, this attribute is output only if the S-VOL is a volume in the local storage system.</p> <ul style="list-style-type: none"> ▪ <code>copyProgressRate</code> (int) Copy progress rate Information is output only when the pair status of the P-VOL is <code>COPY</code> (a pair is being created or resynchronized). This attribute is not output if you specify a value that includes <code>NotSpecified</code> for the object ID. ▪ <code>remoteMirrorCopyPairId</code> (string) Object ID of the remote copy pair# The following attributes are output, separated by commas: <ul style="list-style-type: none"> ▪ <code>remoteStorageDeviceId</code> ▪ <code>copyGroupName</code> ▪ <code>localDeviceGroupName</code> ▪ <code>remoteDeviceGroupName</code> ▪ <code>copyPairName</code> ▪ <code>pvolDifferenceDataManagement</code> (string) Method for managing difference data about the P-VOL <ul style="list-style-type: none"> • S: Difference data based on the shared memory • D: Hierarchical difference data (difference data based on drives) ▪ <code>svolDifferenceDataManagement</code> (string) |

| Attribute | Type | Description |
|-----------|------|--|
| | | <p>Method for managing difference data about the S-VOL</p> <ul style="list-style-type: none"> • S: Difference data based on the shared memory • D: Hierarchical difference data (difference data based on drives) <ul style="list-style-type: none"> ▪ pvolProcessingStatus (string) Processing status of the pair of P-VOLs <ul style="list-style-type: none"> • E: Processing to expand the P-VOLs is being performed • N: Processing to expand the P-VOLs is not being performed ▪ svolProcessingStatus (string) Processing status of the pair of S-VOLs <ul style="list-style-type: none"> • E: Processing to expand the S-VOLs is being performed • N: Processing to expand the S-VOLs is not being performed |

#: We recommend that you save the object ID information you obtain in case a failure occurs. When you need to perform a takeover to recover the system, you can use the saved information to identify the pair that you need to work on, even if you cannot get information about the failed storage system.

If you run this request with `class` specified for `detailInfoType` in the query parameters, additional information from the storage system's cache is also obtained.

| Attribute | Type | Description |
|------------|----------|---|
| copy Pairs | object[] | <p>Attributes related to the detailed information about the copy pair</p> <ul style="list-style-type: none"> ▪ transitionStatus (string) <p>The transition status of a pair is output for a Universal Replicator pair.</p> <ul style="list-style-type: none"> • <code>None</code>: The pair is not in transition. • <code>Suspending</code>: The pair is being split. • <code>Deleting</code>: The pair is being deleted. <p>This is not output if the copy pair is not a Universal Replicator pair.</p> ▪ copyPace (int) <p>Copy speed</p> <p>This is not output for a Universal Replicator pair.</p> |

| Attribute | Type | Description |
|-----------|------|--|
| | | <ul style="list-style-type: none"> <li data-bbox="824 289 1414 611"> <p>▪ pathGroupId (int)</p> <p>ID of the RCU path group</p> <p>This is not output if CU is specified for the remote path connection setting.</p> <p>This is not output if the pair volume status of the P-VOL or S-VOL (the value of the <code>pvolStatus</code> attribute of the <code>svolStatus</code> attribute) is <code>SMPL</code>.</p> <li data-bbox="824 646 1414 1283"> <p>▪ deltaStatus (string)</p> <p>Status of the 3DC multi-target configuration that uses delta resync</p> <p>This is output if the value of <code>replicationType</code> for the <code>copyPairs</code> attribute of the <code>replicationType</code> attribute, which is the pair type for the detailed information about the remote copy pairs, is Universal Replicator, and if you are using a 3DC multi-target configuration that uses delta resync.</p> <ul style="list-style-type: none"> <li data-bbox="863 1045 1373 1108">• <code>HOLD</code>: Universal Replicator delta resync pair (normal) <li data-bbox="863 1129 1373 1192">• <code>HLDE</code>: Universal Replicator delta resync pair (failed) <li data-bbox="863 1213 1409 1276">• <code>HOLDING</code>: In the process of being changed to a Universal Replicator delta resync pair |

Status codes

For details on the status codes of the request for this operation, see the description on HTTP status codes.

Coding example

For TrueCopy:

```
curl -v -H "Accept: application/json" -H "Remote-Authorization:Session
10399a1ffce3489b9c3a823017462396" -H "Authorization:Session
d7b673af189048468c5af9bcf3bbbbb6f" -X GET https://192.0.2.100/
ConfigurationManager/v1/objects/remote-mirror-copygroups/886000123789,
remoteCopyGroup1,remoteCopyGroup1P_,remoteCopyGroup1S_
```

For Universal Replicator:

```
curl -v -H "Accept: application/json" -H "Remote-Authorization:Session
10399a1ffce3489b9c3a823017462396" -H "Authorization:Session
d7b673af189048468c5af9bcf3bbbbb6f" -X GET https://192.0.2.100/
ConfigurationManager/v1/objects/remote-mirror-copygroups/886000123789,
remoteCopyGroup2,remoteCopyGroup2P_,remoteCopyGroup2S_
```

For global-active device:

```
curl -v -H "Accept: application/json" -H "Remote-Authorization:Session
10399a1ffce3489b9c3a823017462396" -H "Authorization:Session
d7b673af189048468c5af9bcf3bbbbb6f" -X GET https://192.0.2.100/
ConfigurationManager/v1/objects/remote-mirror-copygroups/886000123789,
remoteCopyGroup3,remoteCopyGroup3P_,remoteCopyGroup3S_
```

Getting information about a specific remote copy pair

The following request gets information about the specified copy pair (TrueCopy, Universal Replicator, or global-active device). Use this information to get the information that is necessary for performing pair operations (for example, the pair status). If the copy group name or copy pair name contains spaces, pair information cannot be obtained.

Execution permission

Storage Administrator (View Only)

Request line

```
GET base-URL/v1/objects/remote-mirror-copypairs/object-ID
```

Request message

Object ID

Specify the value of `remoteMirrorCopyPairId` that was obtained by the processing to get information about the remote copy group. You can also specify the attributes and connect them with commas as follows:

```
remoteStorageDeviceId, copyGroupName, localDeviceGroupName,
remoteDeviceGroupName, copyPairName
```

| Attribute | Type | Description |
|------------------------------------|--------|---|
| <code>remoteStorageDeviceId</code> | string | (Required) Storage device ID of the remote storage system # |

| Attribute | Type | Description |
|-----------------------|--------|---|
| | | Specify a decimal (base 10) number equal to or greater than 0. |
| copyGroupName | string | (Required) Copy group name Specify a character string consisting of 1 to 31 characters. The name is case sensitive. |
| localDeviceGroupName | string | (Required) Device group name in the local storage system Specify a character string consisting of 1 to 31 characters. The name is case sensitive. |
| remoteDeviceGroupName | string | (Required) Device group name in the remote storage system # Specify a character string consisting of 1 to 31 characters. The name is case sensitive. |
| copyPairName | string | (Required) Copy pair name Specify a name consisting of 1 to 31 characters. The name is case sensitive. |

#: If you specify `NotSpecified` in cases such as when a failure occurs in a remote storage system, only information about the local storage system can be acquired. If you specify `NotSpecified`, copy pair information about attributes of volumes that belong to the remote storage system will not be output. In this case, you do not need to specify the `Remote-Authorization` header.

Query parameters

None.

Body

None.

Response message

Body

The following is an example of the output when information about TrueCopy pairs is obtained:

```
{
  "copyGroupName" : "remoteCopyGroup1",
  "copyPairName" : "pair1",
  "replicationType" : "TC",
  "remoteMirrorCopyPairId" : "886000123789,remoteCopyGroup1,
```

```
remoteCopyGroup1P_,remoteCopyGroup1S_,pair1",
  "pvolLdevId" : 2108,
  "svolLdevId" : 1581,
  "fenceLevel" : "DATA",
  "pvolStatus" : "PAIR",
  "svolStatus" : "PAIR",
  "pvolStorageDeviceId" : "886000123456",
  "svolStorageDeviceId" : "886000123789",
  "pvolDifferenceDataManagement": "S",
  "svolDifferenceDataManagement": "S",
  "pvolProcessingStatus": "N",
  "svolProcessingStatus": "N"
}
```

The following is an example of the output when information about Universal Replicator pairs is obtained:

```
{
  "copyGroupName" : "remoteCopyGroup2",
  "copyPairName" : "pair1",
  "replicationType" : "UR",
  "remoteMirrorCopyPairId" : "886000123789,remoteCopyGroup2,
remoteCopyGroup2P_,remoteCopyGroup2S_,pair1",
  "consistencyGroupId" : 10,
  "pvolLdevId" : 1569,
  "pvolJournalId" : 13,
  "svolLdevId" : 2835,
  "svolJournalId" : 36,
  "fenceLevel" : "ASYNC",
  "pvolStatus" : "PAIR",
  "svolStatus" : "PAIR",
  "pvolStorageDeviceId" : "886000123456",
  "svolStorageDeviceId" : "886000123789",
  "pvolDifferenceDataManagement": "S",
  "svolDifferenceDataManagement": "S",
  "pvolProcessingStatus": "N",
  "svolProcessingStatus": "N"
}
```

The following is an example of the output when information about global-active device pairs is obtained:

```
{
  "copyGroupName" : "remoteCopyGroup3",
  "copyPairName" : "pair1",
  "replicationType" : "GAD",
  "remoteMirrorCopyPairId" : "886000123789,remoteCopyGroup3,
remoteCopyGroup3P_,remoteCopyGroup3S_,pair1",
  "quorumDiskId" : 14,
```

```

"pvolLdevId" : 1580,
"svolLdevId" : 2128,
"fenceLevel" : "NEVER",
"pvolStatus" : "PAIR",
"svolStatus" : "PAIR",
"pvolIOMode" : "L/M",
"svolIOMode" : "L/M",
"pvolStorageDeviceId" : "886000123456",
"svolStorageDeviceId" : "886000123789",
"pvolDifferenceDataManagement": "S",
"svolDifferenceDataManagement": "S",
"pvolProcessingStatus": "N",
"svolProcessingStatus": "N"
}

```

| Attribute | Type | Description |
|-----------------|--------|--|
| copyGroupName | string | Copy group name |
| copyPairName | string | Copy pair name |
| replicationType | string | Pair type <ul style="list-style-type: none"> ▪ TC: TrueCopy ▪ UR: Universal Replicator ▪ GAD: global-active device If the pair status is SMPL, information is not output. |
| pvolLdevId | int | LDEV number of P-VOL If you specify a value that includes <code>NotSpecified</code> for the object ID, this attribute is output only if the P-VOL is a volume in the local storage system. |
| svolLdevId | int | LDEV number of S-VOL If you specify a value that includes <code>NotSpecified</code> for the object ID, this attribute is output only if the S-VOL is a volume in the local storage system. |
| fenceLevel | string | Fence level <ul style="list-style-type: none"> ▪ DATA: S-VOL data ▪ STATUS: S-VOL status ▪ NEVER: None ▪ ASYNC: Asynchronous |

| Attribute | Type | Description |
|---------------|--------|--|
| | | If the fence level cannot be obtained, information is not output. |
| pvolJournalId | int | <p>Journal ID of the P-VOL</p> <p>A value from 0 to 255 is output only in the case of UR. If the pair status is <code>SMPL</code>, information is not output.</p> <p>If you specify a value that includes <code>NotSpecified</code> for the object ID, this attribute is output only if the P-VOL is a volume in the local storage system.</p> |
| svolJournalId | int | <p>Journal ID of the S-VOL</p> <p>A value from 0 to 255 is output only in the case of UR. If the pair status is <code>SMPL</code>, information is not output.</p> <p>If you specify a value that includes <code>NotSpecified</code> for the object ID, this attribute is output only if the S-VOL is a volume in the local storage system.</p> |
| quorumDiskId | int | <p>ID of the Quorum disk</p> <p>A value from 0 to 31 is output only in the case of global-active device. If the pair status is <code>SMPL</code>, information is not output.</p> |
| pvolStatus | string | <p>Pair status of the P-VOL</p> <p>For details, see the section explaining on pair status (TrueCopy and Universal Replicator) or pair status (global-active device).</p> <p>If the pair status cannot be obtained, information is not output.</p> <p>If you specify a value that includes <code>NotSpecified</code> for the object ID, this attribute is output only if the P-VOL is a volume in the local storage system.</p> |
| svolStatus | string | <p>Pair status of the S-VOL</p> <p>For details, see the section explaining on pair status (TrueCopy and Universal Replicator) or pair status (global-active device).</p> <p>If the pair status cannot be obtained, information is not output.</p> |

| Attribute | Type | Description |
|----------------------------------|---------------------|--|
| | | If you specify a value that includes <code>NotSpecified</code> for the object ID, this attribute is output only if the S-VOL is a volume in the local storage system. |
| <code>consistencyGroupId</code> | <code>int</code> | Consistency group ID If no consistency group consists, information is not output. |
| <code>pvollIOMode</code> | <code>string</code> | I/O mode of the P-VOL <ul style="list-style-type: none"> ▪ L/M: Mirror (RL) ▪ L/L: Local ▪ B/B: Block Information is output only in the case of global-active device. If the pair status is <code>SMPL</code> , information is not output. If you specify a value that includes <code>NotSpecified</code> for the object ID, this attribute is output only if the P-VOL is a volume in the local storage system. |
| <code>svollIOMode</code> | <code>string</code> | I/O mode of the S-VOL <ul style="list-style-type: none"> ▪ L/M: Mirror (RL) ▪ L/L: Local ▪ B/B: Block Information is output only in the case of global-active device. If the pair status is <code>SMPL</code> , information is not output. If you specify a value that includes <code>NotSpecified</code> for the object ID, this attribute is output only if the S-VOL is a volume in the local storage system. |
| <code>pvolStorageDeviceId</code> | <code>string</code> | Storage device ID of the storage system on the P-VOL If you specify a value that includes <code>NotSpecified</code> for the object ID, this attribute is output only if the P-VOL is a volume in the local storage system. |
| <code>svolStorageDeviceId</code> | <code>string</code> | Storage device ID of the storage system on the S-VOL If you specify a value that includes <code>NotSpecified</code> for the object ID, this attribute is output only if the S-VOL is a volume in the local storage system. |

| Attribute | Type | Description |
|------------------------------|--------|--|
| copyProgressRate | int | Copy progress rate Information is output only when the pair status of the P-VOL is <code>COPY</code> (a pair is being created or resynchronized). This attribute is not output if you specify a value that includes <code>NotSpecified</code> for the object ID. |
| remoteMirrorCopyPairId | string | Object ID of the remote copy pair# The following attributes are output, separated by commas: <ul style="list-style-type: none"> ▪ remoteStorageDeviceId ▪ copyGroupName ▪ localDeviceGroupName ▪ remoteDeviceGroupName ▪ copyPairName |
| pvolDifferenceDataManagement | string | Method for managing difference data about the P-VOL <ul style="list-style-type: none"> ▪ S: Difference data based on the shared memory ▪ D: Hierarchical difference data (difference data based on drives) |
| svolDifferenceDataManagement | string | Method for managing difference data about the S-VOL <ul style="list-style-type: none"> ▪ S: Difference data based on the shared memory ▪ D: Hierarchical difference data (difference data based on drives) |
| pvolProcessingStatus | string | Processing status of the pair of P-VOLs <ul style="list-style-type: none"> ▪ E: Processing to expand the P-VOLs is being performed ▪ N: Processing to expand the P-VOLs is not being performed |
| svolProcessingStatus | string | Processing status of the pair of S-VOLs <ul style="list-style-type: none"> ▪ E: Processing to expand the S-VOLs is being performed ▪ N: Processing to expand the S-VOLs is not being performed |

#: We recommend that you save the object ID information you obtain in case a failure occurs. When you need to perform a takeover to recover the system, you can use the saved information to identify the pair that you need to work on, even if you cannot get information about the failed storage system.

Status codes

For details on the status codes of the request for this operation, see the description on HTTP status codes.

Coding example

For TrueCopy:

```
curl -v -H "Accept: application/json" -H "Remote-Authorization:Session
10399a1ffce3489b9c3a823017462396" -H "Authorization:Session
d7b673af189048468c5af9bcf3bbbb6f" -X GET https://192.0.2.100/
ConfigurationManager/v1/objects/remote-mirror-copypairs/886000123789,
remoteCopyGroup1,remoteCopyGroup1P_,remoteCopyGroup1S_,pair1
```

For Universal Replicator:

```
curl -v -H "Accept: application/json" -H "Remote-Authorization:Session
10399a1ffce3489b9c3a823017462396" -H "Authorization:Session
d7b673af189048468c5af9bcf3bbbb6f" -X GET https://192.0.2.100/
ConfigurationManager/v1/objects/remote-mirror-copypairs/886000123789,
remoteCopyGroup2,remoteCopyGroup2P_,remoteCopyGroup2S_,pair1
```

For global-active device:

```
curl -v -H "Accept: application/json" -H "Remote-Authorization:Session
10399a1ffce3489b9c3a823017462396" -H "Authorization:Session
d7b673af189048468c5af9bcf3bbbb6f" -X GET https://192.0.2.100/
ConfigurationManager/v1/objects/remote-mirror-copypairs/886000123789,
remoteCopyGroup3,remoteCopyGroup3P_,remoteCopyGroup3S_,pair1
```

Getting TrueCopy or Universal Replicator pair information

You can obtain a list of volume and storage system information regarding the P-VOL and S-VOL composing a TrueCopy or Universal Replicator pair. You can obtain the pair information without specifying information about the remote storage system in the request message.

Execution permission

Administrator user group (built-in user group)

Request line

```
GET base-URL/v1/objects/remote-coppairs
```

Request message**Object ID**

None.

Query parameters

| Parameter | Type | Filter Condition |
|-----------------|--------|---|
| replicationType | string | (Required) Specify the pair type. <ul style="list-style-type: none"> TC: TrueCopy UR: Universal Replicator |
| headLdevId | int | (Optional) Specify, as a decimal (base 10) number, the number of the first LDEV for which you want to acquire information about the pair. Specify a value in the range from 0 to 65279. If this attribute is omitted, 0 is set. |
| count | int | (Optional) Specify the number of LDEVs about which information is to be obtained. Specify this by a decimal (base 10) number. Specify a value in the range from 0 to 500. If this attribute is omitted, 500 is set. |

Body

None.

Response message**Body**

```
{
  "data" : [ {
    "replicationType" : "TC",
    "ldevId" : 49153,
    "remoteSerialNumber" : "10088",
    "remoteStorageTypeId" : "R9",
    "remoteLdevId" : 51712,
    "primaryOrSecondary" : "P-VOL",
```

```

    "muNumber" : 0,
    "status" : "PSUS",
    "serialNumber" : "10011",
    "storageTypeId" : "R9",
    "isMainframe" : false
  } ]
}

```

| Attribute | Type | Description |
|---------------------|--------|--|
| replicationType | string | Pair type <ul style="list-style-type: none"> TC: TrueCopy UR: Universal Replicator |
| ldevId | int | LDEV number of the volume on the local storage system. |
| remoteSerialNumber | string | Serial number of the remote storage system |
| remoteStorageTypeId | string | ID corresponding to the model of the remote storage system <ul style="list-style-type: none"> R8: VSP G1000, VSP G1500, or VSP F1500 R9: VSP 5000 series M8: VSP E series, VSP Gx00 models or VSP Fx00 models |
| remoteLdevId | int | LDEV number of the volume on the remote storage system |
| primaryOrSecondary | string | Attribute of the volume on the local storage system <ul style="list-style-type: none"> P-VOL S-VOL |
| muNumber | int | MU number |
| status | string | Pair status of the volume on the local storage system For details, see the section about pair status transition (TrueCopy and Universal Replicator). |
| serialNumber | string | Serial number of the local storage system |

| Attribute | Type | Description |
|---------------|---------|---|
| storageTypeId | string | ID indicating the model of the local storage system <ul style="list-style-type: none"> R9: VSP 5000 series M8: VSP E series, VSP Gx00 models or VSP Fx00 models |
| isMainframe | boolean | Whether the pair is for mainframe use <ul style="list-style-type: none"> true: Pair for mainframe use false: Not a pair for mainframe use |

Status codes

For details on the status codes for the request that performs this operation, see the description of HTTP status codes.

Coding example

```
curl -v -H "Accept:application/json" -H "Content-Type:application/json" -H
"Authorization:Session d7b673af189048468c5af9bcf3b66b6f" -X GET https://
192.0.2.100/ConfigurationManager/v1/objects/remote-copypairs?
replicationType=TC
```

Getting information about all of remote copy pairs

The following request gets a list of information about the remote copy pairs (TrueCopy, Universal Replicator, or global-active device) registered in the target storage system. You can obtain information about all such pairs from the cache of the storage system, regardless of whether they are managed by using copy groups. You do not need to specify the information about the remote storage system in the request message.



Note:

- This API can be used when the storage system is the VSP 5000 series.
- To get up-to-date information, you must run the API request that refreshes the storage system's cache before running this request. For details, see "Updating the cache of storage system configuration information".

Execution permission

Storage Administrator (View Only)

Request lineGET *base-URL/v1/objects/storages/remote-replications***Request message****Object ID**

None.

Query parameters

| Parameter | Type | Filter condition |
|-----------------|--------|--|
| startLdevId | int | <p>(Optional) To specify a range of LDEVs, specify the LDEV number of the first LDEV in the range.</p> <p>The P-VOLs and S-VOLs in the specified range of LDEVs are searched, and information about the relevant pairs is obtained.</p> <p>Specify a value in the range from 0 to 65279.</p> <p>The value of this parameter must be smaller than that of the <code>endLdevId</code> parameter.</p> <p>If this attribute is omitted, 0 is set.</p> |
| endLdevId | int | <p>(Optional) To specify a range of LDEVs, specify the LDEV number of the last LDEV in the range.</p> <p>The P-VOLs and S-VOLs in the specified range of LDEVs are searched, and information about the relevant pairs is obtained.</p> <p>Specify a value in the range from 0 to 65279.</p> <p>The value of this parameter must be greater than that of the <code>startLdevId</code> parameter.</p> <p>If this attribute is omitted, the maximum LDEV number in the storage system is set.</p> |
| replicationType | string | <p>(Optional) Specify the pair type of the pairs about which information is to be obtained.</p> <ul style="list-style-type: none"> ▪ TC: TrueCopy ▪ UR: Universal Replicator ▪ GAD: global-active device |

Body

None.

Response message**Body**

```

{
  "data": [
    {
      "remoteReplicationId": "R9,10088,375,R9,10011,969",
      "muNumber": 2,
      "replicationType": "UR",
      "pvolLdevId": 375,
      "svolLdevId": 969,
      "fenceLevel": "ASYNC",
      "pvolJournalId": 10,
      "svolJournalId": 0,
      "pvolStatus": "PAIR",
      "consistencyGroupId": 17,
      "pvolStorageType": "R9",
      "pvolStorageSerial": "10088",
      "svolStorageType": "R9",
      "svolStorageSerial": "10011",
      "transitionStatus": "None",
      "pathGroupId": 0
    },
    {
      "remoteReplicationId": "R9,10088,378,R9,10011,765",
      "replicationType": "TC",
      "pvolLdevId": 378,
      "svolLdevId": 765,
      "fenceLevel": "DATA",
      "pvolStatus": "PAIR",
      "pvolStorageType": "R9",
      "pvolStorageSerial": "10088",
      "svolStorageType": "R9",
      "svolStorageSerial": "10011",
      "copyPace": 3,
      "pathGroupId": 0
    },
    {
      "remoteReplicationId": "R9,10088,400,R9,10011,567",
      "muNumber": 0,
      "replicationType": "GAD",
      "pvolLdevId": 400,
      "svolLdevId": 567,
      "fenceLevel": "NEVER",
      "quorumDiskId": 4,
      "pvolStatus": "PAIR",
      "consistencyGroupId": 11,
      "pvolIOMode": "L/M",
      "pvolStorageType": "R9",
    }
  ]
}

```

```

    "pvolStorageSerial": "10088",
    "svolStorageType": "R9",
    "svolStorageSerial": "10011",
    "copyPace": 7,
    "pathGroupId": 0
  }
]
}

```

| Attribute | Type | Description |
|---------------------|--------|--|
| remoteReplicationId | string | <p>Object ID of the remote copy pair</p> <p>The following attributes are output, separated by commas:</p> <ul style="list-style-type: none"> ▪ pvolStorageType ▪ pvolStorageSerial ▪ pvolLdevId ▪ svolStorageType ▪ svolStorageSerial ▪ svolLdevId <p>If the value of remoteReplicationId includes Unknown or -1, the pair might not be in a normal state. Check the status of the storage system.</p> |
| muNumber | int | MU (mirror unit) number |
| replicationType | string | <p>Pair type</p> <ul style="list-style-type: none"> ▪ TC: TrueCopy ▪ UR: Universal Replicator ▪ GAD: global-active device |
| pvolLdevId | int | LDEV number of P-VOL |
| svolLdevId | int | LDEV number of S-VOL |
| fenceLevel | string | <p>Fence level</p> <ul style="list-style-type: none"> ▪ DATA: S-VOL data ▪ STATUS: S-VOL status ▪ NEVER: None ▪ ASYNC: Asynchronous |

| Attribute | Type | Description |
|--------------------|--------|--|
| | | If the fence level cannot be obtained, information is not output. |
| pvolJournalId | int | Journal ID of the P-VOL A value from 0 to 255 is output only in the case of Universal Replicator. |
| svolJournalId | int | Journal ID of the S-VOL A value from 0 to 255 is output only in the case of Universal Replicator. |
| quorumDiskId | int | ID of the Quorum disk A value from 0 to 31 is output only in the case of global-active device. |
| pvolStatus | string | Pair volume status of the P-VOL This attribute is output only if the specified storage system contains the P-VOL. For details, see the section explaining on pair status (TrueCopy and Universal Replicator) or pair status (global-active device). In the case of Universal Replicator, if the transition status of the Universal Replicator pair is <i>Suspending</i> or <i>Deleting</i> , information is not output. |
| svolStatus | string | Pair volume status of the S-VOL This attribute is output only if the specified storage system contains the S-VOL. For details, see the section explaining on pair status (TrueCopy and Universal Replicator) or pair status (global-active device). In the case of Universal Replicator, if the transition status of the Universal Replicator pair is <i>Suspending</i> or <i>Deleting</i> , information is not output. |
| consistencyGroupId | int | Consistency group ID This attribute is not output if no consistency group consists. |

| Attribute | Type | Description |
|-------------------|--------|---|
| pvolIOMode | string | <p>I/O mode of the P-VOL</p> <ul style="list-style-type: none"> ▪ L/M: Mirror (RL) ▪ L/L: Local ▪ B/B: Block <p>This is output only if the volume is a global-active device and the specified storage system is on the P-VOL.</p> |
| svolIOMode | string | <p>I/O mode of the S-VOL</p> <ul style="list-style-type: none"> ▪ L/M: Mirror (RL) ▪ L/L: Local ▪ B/B: Block <p>This is output only if the volume is a global-active device and the specified storage system is on the S-VOL.</p> |
| pvolStorageType | string | <p>ID indicating the model of the storage system on the P-VOL</p> <ul style="list-style-type: none"> ▪ R8: VSP G1000, VSP G1500, or VSP F1500 ▪ R9: VSP 5000 series ▪ M8: VSP E series, VSP Gx00 models, VSP Fx00 models ▪ UNKNOWN: Unknown |
| pvolStorageSerial | string | Serial number of the storage system on the P-VOL |
| svolStorageType | string | <p>ID indicating the model of the storage system on the S-VOL</p> <ul style="list-style-type: none"> ▪ R8: VSP G1000, VSP G1500, or VSP F1500 ▪ R9: VSP 5000 series ▪ M8: VSP E series, VSP Gx00 models, VSP Fx00 models ▪ UNKNOWN: Unknown |
| svolStorageSerial | string | Serial number of the storage system on the S-VOL |

| Attribute | Type | Description |
|------------------|--------|--|
| transitionStatus | string | <p>The transition status of a pair is output for a Universal Replicator pair.</p> <ul style="list-style-type: none"> ▪ <code>None</code>: The pair is not in transition. ▪ <code>Suspending</code>: The pair is being split. ▪ <code>Deleting</code>: The pair is being deleted. <p>This is not output if the copy pair is not a Universal Replicator pair.</p> |
| copyPace | int | <p>Copy speed</p> <p>If the pair type is <code>TrueCopy</code>, this attribute is output only if the specified storage system contains the P-VOL.</p> <p>If the pair type is <code>global-active device</code>, this attribute is output regardless of whether the specified storage system contains the P-VOL or contains the S-VOL.</p> <p>This is not output if the pair type is Universal Replicator.</p> |
| pathGroupId | int | <p>Path group ID of the RCU</p> <p>This is not output if CU is specified for the remote path connection setting.</p> |
| deltaStatus | string | <p>Status of the 3DC multi-target configuration that uses delta resync</p> <p>This is output if the pair type is Universal Replicator and the 3DC multi-target configuration that uses delta resync is used.</p> <ul style="list-style-type: none"> ▪ <code>HOLD</code>: Universal Replicator delta resync pair (normal) ▪ <code>HLDE</code>: Universal Replicator delta resync pair (failed) ▪ <code>HOLDING</code>: In the process of being changed to a Universal Replicator delta resync pair |

Status codes

For details on the status codes for the request that performs this operation, see the description of HTTP status codes.

Coding example

```
curl -v -H "Accept: application/json" -H "Authorization:Session
d7b673af189048468c5af9bcf3b6bb6f" -X GET https://192.0.2.100/
ConfigurationManager/v1/objects/remote-replications
```

Creating a TrueCopy pair or Universal Replicator pair

The following request creates a TrueCopy pair or a Universal Replicator pair in the storage systems of the primary and secondary sites. The TrueCopy pair or the Universal Replicator pair is either added to a new copy group or to an existing copy group. If you create a copy group, also create a device group. First create a pair in the storage system of the primary site. Before creating a pair, lock the resources or make sure that the resources have not been locked by another user.



Tip: We recommend specifying `Job-Mode-Wait-Configuration-Change:NoWait` in the request header of this API function. For details, see the description of the flow of operations for the pairs.

Execution permission

Storage Administrator (Provisioning) and Storage Administrator (Remote Copy)

Request line

```
POST base-URL/v1/objects/remote-mirror-copypairs
```

Request message**Object ID**

None.

Query parameters

None.

Body

The following are coding examples for creating a TrueCopy pair.

When creating a new copy group and adding a pair to the copy group:

```
{
  "copyGroupName": "remoteCopyGroup1",
  "copyPairName": "pair1",
  "replicationType": "TC",
  "remoteStorageDeviceId": "886000123789",
  "pvolLdevId": 2108,
  "svolLdevId": 1581,
  "localDeviceGroupName": "remoteCopyGroup1P_",
```

```

"remoteDeviceGroupName": "remoteCopyGroup1S_",
"isNewGroupCreation": true,
"fenceLevel": "DATA",
"isConsistencyGroup": true,
"consistencyGroupId": 5,
"copyPace": 10,
"pathGroupId": 3,
"doInitialCopy": true,
"isDataReductionForceCopy": true
}

```

When adding a pair to an existing copy group:

```

{
"copyGroupName": "remoteCopyGroup1",
"copyPairName": "pair2",
"replicationType": "TC",
"remoteStorageDeviceId": "886000123789",
"pvolldevId": 2109,
"svolldevId": 1582,
"localDeviceGroupName": "remoteCopyGroup1P_",
"remoteDeviceGroupName": "remoteCopyGroup1S_",
"isNewGroupCreation": false,
"fenceLevel": "DATA",
"isConsistencyGroup": true,
"consistencyGroupId": 5,
"copyPace": 10,
"doInitialCopy": true,
"isDataReductionForceCopy": false
}

```

The following table describes attributes for a TrueCopy pair.

| Attribute | Type | Description |
|---------------|--------|--|
| copyGroupName | string | (Required) Specify a copy group name consisting of 1 to 29 characters. The name is case sensitive. Set a unique name that is the same for the storage systems on both the local and remote sides. |
| copyPairName | string | (Required) Specify a copy pair name consisting of 1 to 31 characters. The name is case sensitive. Set a unique name that is the same for the storage systems in the copy group. |

| Attribute | Type | Description |
|-----------------------|--------|---|
| replicationType | string | (Required) Specify the pair type. TC: TrueCopy |
| remoteStorageDeviceId | string | (Required) Specify the storage device ID of the remote storage system in which the pair is to be created. |
| pvolLdevId | int | (Required) Specify the LDEV number of the P-VOL with a decimal (base 10) number. |
| svolLdevId | int | (Required) Specify the LDEV number of the S-VOL with a decimal (base 10) number. |
| pathGroupId | int | (Optional) Specify the path group ID by using a decimal (base 10) number in the range from 0 to 255. If you omit this value or specify 0, the lowest path group ID in the specified path group is used. |
| localDeviceGroupName | string | (Optional) Specify the device group name in the local storage system by using 1 to 31 characters. The name is case sensitive. If you add the pair to an existing copy group, specify the same device group name as that of the existing local storage system. If this value is omitted, <i>copyGroupNameP_</i> is set. The name needs to be unique in the local storage system. |
| remoteDeviceGroupName | string | (Optional) Specify the device group name in the remote storage system by using 1 to 31 characters. The name is case sensitive. If you add the pair to an existing copy group, specify the same device group name as that of the existing remote storage system. If this value is omitted, <i>copyGroupNameS_</i> is set. The name needs to be unique in the remote storage system. |

| Attribute | Type | Description |
|--------------------|---------|---|
| isNewGroupCreation | boolean | <p>(Required) Depending on the value, this attribute specifies whether to add the pair to a newly created copy group or to an existing copy group.</p> <ul style="list-style-type: none"> ▪ <code>true</code>: Adds the pair to a newly created copy group. ▪ <code>false</code>: Adds the pair to an existing copy group. |
| isConsistencyGroup | boolean | <p>(Optional) Depending on the value, this attribute specifies whether to register the new pair in a consistency group.</p> <ul style="list-style-type: none"> ▪ <code>true</code>: Registers the pair in a consistency group. ▪ <code>false</code>: Does not register the pair in a consistency group. <p>If you add the pair to an existing copy group, specify the same value as that of the existing copy pair. If a copy group includes both pairs that are registered in a consistency group and pairs that are not registered in a consistency group, pair operations by consistency group cannot be correctly performed. If this value is omitted, <code>false</code> is set.</p> |
| consistencyGroupId | int | <p>(Optional) Specify the consistency group ID by using a decimal (base 10) number in the range from 0 to 255.</p> <p>If you omit this value when registering the new pair in a consistency group, the value of the consistency group ID is automatically assigned.</p> <p>If you add the pair to an existing copy group, specify the same value as that of the existing copy pair. If a copy group includes a pair whose consistency group ID differs, pair operations by consistency group cannot be correctly performed.</p> <p>When specifying this attribute, make sure to specify <code>true</code> for the <code>isConsistencyGroup</code> attribute.</p> |
| fenceLevel | string | (Required) Fence level |

| Attribute | Type | Description |
|--------------------------|---------|--|
| | | <p>The specifiable values are as follows:</p> <ul style="list-style-type: none"> ▪ DATA: S-VOL data ▪ STATUS: S-VOL status ▪ NEVER: None |
| copyPace | int | <p>(Optional) Copy speed</p> <p>Specify a decimal (base 10) number in the range from 1 to 15 for the size of tracks to be copied. The larger the value you specify, the faster the copy speed.</p> <p>If this value is omitted, 3 is assumed.</p> |
| doInitialCopy | boolean | <p>(Optional) Specify whether to perform initial copy when creating a pair.</p> <ul style="list-style-type: none"> ▪ true: Performs initial copy. ▪ false: Does not perform initial copy. <p>If this value is omitted, true is assumed.</p> |
| isDataReductionForceCopy | boolean | <p>(Optional) Specify whether to forcibly create a pair for a volume for which the capacity saving function (dedupe and compression) is enabled.</p> <p>When creating a pair for a volume for which the capacity saving function is enabled, always specify true.</p> <ul style="list-style-type: none"> ▪ true: Forcibly create a pair # ▪ false: Do not forcibly create a pair <p>When the attribute is omitted, false is assumed.</p> |

#: If you create a pair by using volumes for which the capacity saving function (compression or deduplication) is enabled, data that has been compressed or deduplicated will be copied and, as a result, the performance of the copying processing or the I/O performance of the host might decrease.

The following are coding examples for creating a Universal Replicator pair.

When creating a new copy group and adding a pair to the copy group:

```
{
  "copyGroupName": "remoteCopyGroup2",
  "copyPairName": "pair1",
```



```

"replicationType": "UR",
"remoteStorageDeviceId": "886000123789",
"pvolLdevId": 1569,
"svolLdevId": 2835,
"pvolJournalId": 13,
"svolJournalId": 36,
"localDeviceGroupName": "remoteCopyGroup2P_",
"remoteDeviceGroupName": "remoteCopyGroup2S_",
"isNewGroupCreation": true,
"fenceLevel": "ASYNC",
"muNumber": 0,
"consistencyGroupId": 10,
"doInitialCopy": true,
"doDeltaResyncSuspend": false,
"isDataReductionForceCopy": true
}

```

When adding a pair to an existing copy group:

```

{
  "copyGroupName": "remoteCopyGroup2",
  "copyPairName": "pair2",
  "replicationType": "UR",
  "remoteStorageDeviceId": "886000123789",
  "pvolLdevId": 1570,
  "svolLdevId": 2836,
  "localDeviceGroupName": "remoteCopyGroup2P_",
  "remoteDeviceGroupName": "remoteCopyGroup2S_",
  "isNewGroupCreation": false,
  "fenceLevel": "ASYNC",
  "consistencyGroupId": 10,
  "doInitialCopy": true,
  "doDeltaResyncSuspend": false,
  "isDataReductionForceCopy": false
}

```

The following table describes attributes for a Universal Replicator pair.

| Attribute | Type | Description |
|---------------|--------|--|
| copyGroupName | string | (Required) Specify a copy group name consisting of 1 to 29 characters. The name is case sensitive. Set a unique name that is the same for the storage systems on both the local and remote sides. |

| Attribute | Type | Description |
|-----------------------|--------|---|
| copyPairName | string | (Required) Specify a copy pair name consisting of 1 to 31 characters. The name is case sensitive. Set a unique name that is the same for the storage systems in the copy group. |
| replicationType | string | (Required) Specify the pair type. UR: Universal Replicator |
| remoteStorageDeviceId | string | (Required) Specify the storage device ID of the remote storage system in which the pair is to be created. |
| pvolLdevId | int | (Required) Specify the LDEV number of the P-VOL with a decimal (base 10) number. |
| svolLdevId | int | (Required) Specify the LDEV number of the S-VOL with a decimal (base 10) number. |
| pathGroupId | int | (Optional) Specify the path group ID by using a decimal (base 10) number in the range from 0 to 255. If you omit this value or specify 0, the lowest path group ID in the specified path group is used. |
| localDeviceGroupName | string | (Optional) Specify the device group name of the local storage system by using 1 to 31 characters. The name is case sensitive. If you add the pair to an existing copy group, specify the same device group name as that of the existing local storage system. If this value is omitted, <i>copyGroupNameP_</i> is set. The name needs to be unique in the local storage system. |
| remoteDeviceGroupName | string | (Optional) Specify the device group name of the remote storage system by using 1 to 31 characters. The name is case sensitive. If you add the pair to an existing copy group, specify the same device group name as that of the existing remote storage system. If this value is omitted, <i>copyGroupNameS_</i> is set. The name needs to be unique in the remote storage system. |

| Attribute | Type | Description |
|--------------------|---------|---|
| isNewGroupCreation | boolean | <p>(Required) Depending on the value, this attribute specifies whether to add the pair to a newly created copy group or to an existing copy group.</p> <ul style="list-style-type: none"> ▪ <code>true</code>: Adds the pair to a newly created copy group. ▪ <code>false</code>: Adds the pair to an existing copy group. |
| muNumber | int | <p>(Required) Specify the MU (mirror unit) number by using a number from 0 to 3.</p> <p>This value is used by the P-VOL and the S-VOL. You can specify this attribute only if you add the pair to a newly created copy group.</p> |
| pvolJournalId | int | <p>(Required) Specify the journal ID of the P-VOL by using a decimal (base 10) number in the range from 0 to 255.</p> <p>Make sure to specify this attribute if you add the pair to a newly created copy group.</p> |
| svolJournalId | int | <p>(Required) Specify the journal ID of the S-VOL by using a decimal (base 10) number in the range from 0 to 255.</p> <p>Make sure to specify this attribute if you add the pair to a newly created copy group.</p> |
| consistencyGroupId | int | <p>(Optional) Specify the consistency group ID by using a decimal (base 10) number in the range from 0 to 255.</p> <p>If you omit this value when adding the pair to a newly created copy group, the value of the consistency group ID is automatically assigned.</p> <p>If you add the pair to an existing copy group, specify the same value as that of the existing copy pair. If a copy group includes a pair whose consistency group ID differs, pair operations by consistency group cannot be correctly performed.</p> |
| fenceLevel | string | <p>(Optional) Fence level</p> <p><code>ASYN</code> is automatically set.</p> |

| Attribute | Type | Description |
|--------------------------|---------|--|
| doInitialCopy | boolean | <p>(Optional) Specify whether to perform initial copy when creating a pair.</p> <ul style="list-style-type: none"> ▪ <code>true</code>: Performs initial copy. ▪ <code>false</code>: Does not perform initial copy. <p>If this value is omitted, <code>true</code> is assumed.</p> |
| isDataReductionForceCopy | boolean | <p>(Optional) Specify whether to forcibly create a pair for a volume for which the capacity saving function (dedupe and compression) is enabled.</p> <p>When creating a pair for a volume for which the capacity saving function is enabled, always specify <code>true</code>.</p> <ul style="list-style-type: none"> ▪ <code>true</code>: Forcibly create a pair # ▪ <code>false</code>: Do not forcibly create a pair <p>When the attribute is omitted, <code>false</code> is assumed.</p> |
| doDeltaResyncSuspend | boolean | <p>(Optional) For the 3DC multi-target configuration, specify whether to use delta resync between the storage systems of the secondary sites.</p> <ul style="list-style-type: none"> ▪ <code>true</code>: Uses delta resync. ▪ <code>false</code>: Does not use delta resync. <p>If <code>true</code> is specified, a journal volume of the Universal Replicator pair to be used for delta resync will be created in the initial status without initial copy performed. If this value is omitted, <code>false</code> is set.</p> |

#: If you create a pair by using volumes for which the capacity saving function (compression or deduplication) is enabled, data that has been compressed or deduplicated will be copied and, as a result, the performance of the copying processing or the I/O performance of the host might decrease.

Response message**Body**

A job object is returned. For details on attributes other than `affectedResources`, see the section explaining job objects.

| Attribute | Description |
|--------------------------------|---|
| <code>affectedResources</code> | URL of the created TrueCopy pairs or Universal Replicator pairs |

Status codes

For details on the status codes of the request for this operation, see the description on HTTP status codes.

Coding example

```
curl -v -H "Accept: application/json" -H "Remote-Authorization:Session
10399alffce3489b9c3a823017462396" -H "Content-Type: application/json" -H
"Authorization:Session d7b673af189048468c5af9bcf3b66b6f" -X POST --data-
binary @./InputParameters.json https://192.0.2.100/ConfigurationManager/v1/
objects/remote-mirror-copypairs
```

Splitting TrueCopy pairs or Universal Replicator pairs in units of copy groups

The following request splits TrueCopy pairs or Universal Replicator pairs by using the specified copy group. If the pairs are split, data copy from the primary volume to the secondary volume will be suspended. Do not simultaneously perform other operations on the copy group or the pairs in that copy group on which a pair split operation is performed.



Tip: We recommend specifying `Job-Mode-Wait-Configuration-Change:NoWait` in the request header of this API function. For details, see the description of the flow of operations for the pairs.

Execution permission

Storage Administrator (Remote Copy)

Request line

```
POST base-URL/v1/objects/remote-mirror-copygroups/object-ID/actions/split/
invoke
```

Request message**Object ID**

Specify the value of `remoteMirrorCopyGroupId` that was obtained by the processing to get information about the remote copy group. You can also specify the attributes and connect them with commas as follows:

```
remoteStorageDeviceId, copyGroupName, localDeviceGroupName,
remoteDeviceGroupName
```

| Attribute | Type | Description |
|------------------------------------|--------|---|
| <code>remoteStorageDeviceId</code> | string | (Required) Storage device ID of the remote storage system |
| <code>copyGroupName</code> | string | (Required) Copy group name Specify a name consisting of 1 to 31 characters. The name is case sensitive. |
| <code>localDeviceGroupName</code> | string | (Required) Device group name in the local storage system Specify a name consisting of 1 to 31 characters. The name is case sensitive. |
| <code>remoteDeviceGroupName</code> | string | (Required) Device group name in the remote storage system Specify a name consisting of 1 to 31 characters. The name is case sensitive. |

Query parameters

None.

Body

The following is a coding example for simply splitting pairs:

```
{
  "parameters": {
    "replicationType": "TC"
  }
}
```

The following is a coding example for splitting pairs by specifying the S-VOL, and forcibly changing the status of the pairs of the S-VOL to SSWS:

```
{
  "parameters": {
    "replicationType": "UR",
    "svolOperationMode": "SSWS"
  }
}
```

The following is a TrueCopy coding example for splitting pairs and prohibiting write operations for the P-VOL:

```
{
  "parameters": {
    "replicationType": "TC",
    "doPvolWriteProtect": true
  }
}
```

The following is a Universal Replicator coding example for splitting pairs and forcibly stopping operations on a journal volume:

```
{
  "parameters": {
    "replicationType": "UR",
    "doDataSuspend": true
  }
}
```

| Attribute | Type | Description |
|-----------------|--------|--|
| replicationType | string | (Required) Specify the pair type. <ul style="list-style-type: none"> ▪ TC: TrueCopy ▪ UR: Universal Replicator |
| svolAccessMode | string | (Optional) Specify the access mode for the S-VOL after pairs are split. <ul style="list-style-type: none"> ▪ r: Read only ▪ rw: Read and write If the value is not specified, r will be set. |

| Attribute | Type | Description |
|---------------------------------|---------|--|
| | | <p>If you specify this attribute, you cannot specify the <code>svolOperationMode</code> attribute. In the case of TC, you cannot specify <code>true</code> for the <code>doPvolWriteProtect</code> attribute. In the case of UR, you cannot specify <code>true</code> for the <code>doDataSuspend</code> attribute.</p> |
| <code>svolOperationMode</code> | string | <p>(Optional) Specify this attribute to forcibly change the status of the pairs of the S-VOL in cases such as if a failure occurs in the storage system of the primary site. Issue a request from the storage system of the secondary site.</p> <ul style="list-style-type: none"> ▪ <code>SSWS</code>: Change to SSWS mode. ▪ <code>PSUS</code>: Change to PSUS (PSUE or PSUS) mode. <p>If you specify this attribute, you cannot specify the <code>svolAccessMode</code> attribute. In the case of TC, you cannot specify <code>true</code> for the <code>doPvolWriteProtect</code> attribute. In the case of UR, you cannot specify <code>true</code> for the <code>doDataSuspend</code> attribute.</p> |
| <code>doPvolWriteProtect</code> | boolean | <p>(Optional) In the case of TC, specify whether to forcibly disable write operations for the P-VOL. Issue a request from the storage system of the secondary site.</p> <ul style="list-style-type: none"> ▪ <code>true</code>: Disable write operations for P-VOL. ▪ <code>false</code>: Do not disable write operations for P-VOL. <p>If the value is not specified, <code>false</code> will be set.</p> <p>If you specify <code>true</code> for this attribute, you cannot specify the <code>svolAccessMode</code> and <code>svolOperationMode</code> attributes.</p> |
| <code>doDataSuspend</code> | boolean | <p>(Optional) In the case of UR, specify whether to forcibly stop operations on a journal when the amount of access to the journal increases. Issue a request from the storage system of the primary site.</p> <ul style="list-style-type: none"> ▪ <code>true</code>: Forcibly stop operations on the journal. <p>Data is not copied to the group on the S-VOL. The data of the master journal volume and the restore journal volume is deleted.</p> <ul style="list-style-type: none"> ▪ <code>false</code>: Do not forcibly stop operations on the journal. <p>If the value is not specified, <code>false</code> will be set.</p> |

| Attribute | Type | Description |
|-----------|------|--|
| | | If you specify <code>true</code> for this attribute, you cannot specify the <code>svolOperationMode</code> attribute. However, you can specify only <code>rw</code> for the <code>svolAccessMode</code> attribute. |

Response message

Body

A job object is returned. For details on attributes other than `affectedResources`, see the section explaining job objects.

| Attribute | Description |
|--------------------------------|---|
| <code>affectedResources</code> | URL of the copy group of the split TrueCopy pairs or Universal Replicator pairs |

Action template

```
GET base-URL/v1/objects/remote-mirror-copygroups/object-ID/actions/split
```

This action template returns only the specifiable attributes, depending on the following: the type of the pairs of the copy group specified for the object ID, and whether the volume in the copy group of the local storage system is the primary volume or the secondary volume.

Status codes

The following table describes the meaning of the status code of the request for this operation. For details on other status codes, see the section explaining HTTP status codes.

| Status code | Message | Description |
|-------------|---------------------|--|
| 412 | Precondition Failed | This status code indicates that operations on the pairs of the specified copy group cannot be performed. |

Coding example

To get an action template:

When the storage system of the P-VOL is specified:

```
curl -v -H "Accept: application/json" -H "Remote-Authorization:Session
10399a1ffce3489b9c3a823017462396" -H "Authorization:Session
d7b673af189048468c5af9bcf3bbbb6f" -X GET https://192.0.2.100/
```

```
ConfigurationManager/v1/objects/remote-mirror-copygroups/886000123789,
remoteCopyGroup,remoteCopyGroupP_,remoteCopyGroupS_/actions/split
```

When the storage system of the S-VOL is specified:

```
curl -v -H "Accept: application/json" -H "Remote-Authorization:Session
10399a1ffce3489b9c3a823017462396" -H "Authorization:Session
d7b673af189048468c5af9bcf3bbbbb6f" -X GET https://192.0.2.100/
ConfigurationManager/v1/objects/remote-mirror-copygroups/886000123456,
remoteCopyGroup,remoteCopyGroupS_,remoteCopyGroupP_/actions/split
```

To run the request after getting an action template:

When the storage system of the P-VOL is specified:

```
curl -v -H "Accept: application/json" -H "Remote-Authorization:Session
10399a1ffce3489b9c3a823017462396" -H "Content-Type: application/json" -H
"Authorization:Session d7b673af189048468c5af9bcf3bbbbb6f" -X POST --data-
binary @./InputParameters.json https://192.0.2.100/ConfigurationManager/v1/
objects/remote-mirror-copygroups/886000123789,remoteCopyGroup,
remoteCopyGroupP_,remoteCopyGroupS_/actions/split/invoke
```

When the storage system of the S-VOL is specified:

```
curl -v -H "Accept: application/json" -H "Remote-Authorization:Session
10399a1ffce3489b9c3a823017462396" -H "Content-Type: application/json" -H
"Authorization:Session d7b673af189048468c5af9bcf3bbbbb6f" -X POST --data-
binary @./InputParameters.json https://192.0.2.100/ConfigurationManager/v1/
objects/remote-mirror-copygroups/886000123456,remoteCopyGroup,
remoteCopyGroupS_,remoteCopyGroupP_/actions/split/invoke
```

Splitting a TrueCopy pair or Universal Replicator pair

The following request splits the specified TrueCopy pair or Universal Replicator pair. If the pairs are split, data copy from the primary volume to the secondary volume will be suspended. Do not simultaneously perform other operations on the copy group or the pairs in that copy group on which a pair split operation is performed.



Tip: We recommend specifying `Job-Mode-Wait-Configuration-Change:NoWait` in the request header of this API function. For details, see the description of the flow of operations for the pairs.

Execution permission

Storage Administrator (Remote Copy)

Request line

```
POST base-URL/v1/objects/remote-mirror-copypairs/object-ID/actions/split/
invoke
```

Request message**Object ID**

Specify the value of `remoteMirrorCopyPairId` that was obtained by the processing to get information about the remote copy pair. You can also specify the attributes and connect them with commas as follows:

```
remoteStorageDeviceId, copyGroupName, localDeviceGroupName,
remoteDeviceGroupName, copyPairName
```

| Attribute | Type | Description |
|------------------------------------|--------|---|
| <code>remoteStorageDeviceId</code> | string | (Required) Storage device ID of the remote storage system |
| <code>copyGroupName</code> | string | (Required) Copy group name Specify a name consisting of 1 to 31 characters. The name is case sensitive. |
| <code>localDeviceGroupName</code> | string | (Required) Device group name in the local storage system Specify a name consisting of 1 to 31 characters. The name is case sensitive. |
| <code>remoteDeviceGroupName</code> | string | (Required) Device group name of the remote storage system Specify a name consisting of 1 to 31 characters. The name is case sensitive. |
| <code>copyPairName</code> | string | (Required) Copy pair name Specify a name consisting of 1 to 31 characters. The name is case sensitive. |

Query parameters

None.

Body

The following is a coding example for simply splitting pairs:

```
{
  "parameters": {
    "replicationType": "UR"
  }
}
```

The following is a coding example for splitting a pair and permitting write operations for the S-VOL:

```
{
  "parameters": {
    "replicationType": "TC",
    "svolAccessMode": "rw"
  }
}
```

The following is a coding example for splitting a pair by specifying the S-VOL, and forcibly changing the status of the pair of the S-VOL:

```
{
  "parameters": {
    "replicationType": "TC",
    "svolOperationMode": "PSUS"
  }
}
```

| Attribute | Type | Description |
|-----------------|--------|--|
| replicationType | string | (Required) Specify the pair type. <ul style="list-style-type: none"> ▪ TC: TrueCopy ▪ UR: Universal Replicator |
| svolAccessMode | string | (Optional) Specify the access mode for the S-VOL after pairs are split. <ul style="list-style-type: none"> ▪ r: Read only ▪ rw: Read and write If the value is not specified, r will be set. |

| Attribute | Type | Description |
|---------------------------------|---------|--|
| | | <p>If you specify this attribute, you cannot specify the <code>svolOperationMode</code> attribute. In the case of TC, you cannot specify <code>true</code> for the <code>doPvolWriteProtect</code> attribute. In the case of UR, you cannot specify <code>true</code> for the <code>doDataSuspend</code> attribute.</p> |
| <code>svolOperationMode</code> | string | <p>(Optional) Specify this attribute to forcibly change the status of the pairs of the S-VOL in cases such as if a failure occurs in the storage system of the primary site. Issue a request from the storage system of the secondary site.</p> <ul style="list-style-type: none"> ▪ <code>SSWS</code>: Change to SSWS mode. ▪ <code>PSUS</code>: Change to PSUS (PSUE or PSUS) mode. <p>If you specify this attribute, you cannot specify the <code>svolAccessMode</code> attribute. In the case of TC, you cannot specify <code>true</code> for the <code>doPvolWriteProtect</code> attribute. In the case of UR, you cannot specify <code>true</code> for the <code>doDataSuspend</code> attribute.</p> |
| <code>doPvolWriteProtect</code> | boolean | <p>(Optional) In the case of TC, specify whether to forcibly disable write operations for the P-VOL. Issue a request from the storage system of the secondary site.</p> <ul style="list-style-type: none"> ▪ <code>true</code>: Disable write operations for P-VOL. ▪ <code>false</code>: Do not disable write operations for P-VOL. <p>If the value is not specified, <code>false</code> will be set.</p> <p>If you specify <code>true</code> for this attribute, you cannot specify the <code>svolAccessMode</code> and <code>svolOperationMode</code> attributes.</p> |
| <code>doDataSuspend</code> | boolean | <p>(Optional) In the case of UR, specify whether to forcibly stop operations on a journal when the amount of access to the journal increases. Issue a request from the storage system of the primary site.</p> <ul style="list-style-type: none"> ▪ <code>true</code>: Forcibly stop operations on the journal. <p>Data is not copied to the S-VOL. The data of the master journal volume and the restore journal volume is deleted.</p> <ul style="list-style-type: none"> ▪ <code>false</code>: Do not forcibly stop operations on the journal. <p>If the value is not specified, <code>false</code> will be set.</p> |

| Attribute | Type | Description |
|-----------|------|--|
| | | If you specify <code>true</code> for this attribute, you cannot specify the <code>svolOperationMode</code> attribute. However, you can specify only <code>rw</code> for the <code>svolAccessMode</code> attribute. |

Response message

Body

A job object is returned. For details on attributes other than `affectedResources`, see the section explaining job objects.

| Attribute | Description |
|--------------------------------|---|
| <code>affectedResources</code> | URL of the split TrueCopy pairs or Universal Replicator pairs |

Action template

```
GET base-URL/v1/objects/remote-mirror-coppairs/object-ID/actions/split
```

This action template returns only the specifiable attributes, depending on the following: the type of the pair specified for the object ID, and whether the volume in the local storage system is the primary volume or the secondary volume.

Status codes

The following table describes the meaning of the status code of the request for this operation. For details on other status codes, see the section explaining HTTP status codes.

| Status code | Message | Description |
|-------------|---------------------|---|
| 412 | Precondition Failed | This status code indicates that operations on the specified pair cannot be performed. |

Coding example

To get an action template:

When the storage system of the P-VOL is specified:

```
curl -v -H "Accept: application/json" -H "Remote-Authorization:Session
10399a1ffce3489b9c3a823017462396" -H "Authorization:Session
d7b673af189048468c5af9bcf3bbbb6f" -X GET https://192.0.2.100/
```

```
ConfigurationManager/v1/objects/remote-mirror-copypairs/886000123789,  
remoteCopyGroup,remoteCopyGroupP_,remoteCopyGroupS_,pair1/actions/split
```

When the storage system of the S-VOL is specified:

```
curl -v -H "Accept: application/json" -H "Remote-Authorization:Session  
10399a1ffce3489b9c3a823017462396" -H "Authorization:Session  
d7b673af189048468c5af9bcf3bbbb6f" -X GET https://192.0.2.100/  
ConfigurationManager/v1/objects/remote-mirror-copypairs/886000123456,  
remoteCopyGroup,remoteCopyGroupS_,remoteCopyGroupP_,pair1/actions/split
```

To run the request after getting an action template:

When the storage system of the P-VOL is specified:

```
curl -v -H "Accept: application/json" -H "Remote-Authorization:Session  
10399a1ffce3489b9c3a823017462396" -H "Content-Type: application/json" -H  
"Authorization:Session d7b673af189048468c5af9bcf3bbbb6f" -X POST --data-  
binary @./InputParameters.json https://192.0.2.100/ConfigurationManager/v1/  
objects/remote-mirror-copypairs/886000123789,remoteCopyGroup,  
remoteCopyGroupP_,remoteCopyGroupS_,pair1/actions/split/invoke
```

When the storage system of the S-VOL is specified:

```
curl -v -H "Accept: application/json" -H "Remote-Authorization:Session  
10399a1ffce3489b9c3a823017462396" -H "Content-Type: application/json" -H  
"Authorization:Session d7b673af189048468c5af9bcf3bbbb6f" -X POST --data-  
binary @./InputParameters.json https://192.0.2.100/ConfigurationManager/v1/  
objects/remote-mirror-copypairs/886000123456,remoteCopyGroup,  
remoteCopyGroupS_,remoteCopyGroupP_,pair1/actions/split/invoke
```

Resynchronizing TrueCopy pairs or Universal Replicator pairs in units of copy groups

The following request resynchronizes TrueCopy pairs or Universal Replicator pairs by using the specified copy group. If the pairs are resynchronized, the differential data that was accumulated after the pairs were split is copied, by copy group, from the primary volume to the secondary volume, so that the data is consistent between the two volumes. Do not simultaneously perform other operations on the copy group or the pairs in that copy group on which a pair resynchronization operation is performed.



Tip: We recommend specifying `Job-Mode-Wait-Configuration-Change:NoWait` in the request header of this API function. For details, see the description of the flow of operations for the pairs.

**Note:**

If the model of either or both of the storage systems is VSP E series, VSP G350, G370, G700, G900, VSP F350, F370, F700, F900, to register TrueCopy pairs in a consistency group when performing a TrueCopy pair resynchronization operation, the number of pairs in the target copy group must be 1,000 or less. If the number of pairs exceeds 1,000, delete all pairs in the copy group, and then register pairs in a consistency group when you re-create the pairs. Alternatively, delete some pairs so that the number of pairs decreases to 1,000 or less, perform a pair resynchronization operation, and then register the pairs in a consistency group when you re-create the pairs that you deleted.

Execution permission

Storage Administrator (Remote Copy)

Request line

```
POST base-URL/v1/objects/remote-mirror-copygroups/object-ID/actions/resync/
invoke
```

Request message**Object ID**

Specify the value of `remoteMirrorCopyGroupId` that was obtained by the processing to get information about the remote copy group. You can also specify the attributes and connect them with commas as follows:

```
remoteStorageDeviceId, copyGroupName, localDeviceGroupName,
remoteDeviceGroupName
```

| Attribute | Type | Description |
|------------------------------------|--------|--|
| <code>remoteStorageDeviceId</code> | string | (Required) Storage device ID of the remote storage system |
| <code>copyGroupName</code> | string | (Required) Copy group name Specify a name consisting of 1 to 31 characters. The name is case sensitive. |
| <code>localDeviceGroupName</code> | string | (Required) Device group name in the local storage system Specify a name consisting of 1 to 31 characters. The name is case sensitive. |
| <code>remoteDeviceGroupName</code> | string | (Required) Device group name in the remote storage system |

| Attribute | Type | Description |
|-----------|------|--|
| | | Specify a name consisting of 1 to 31 characters. The name is case sensitive. |

Query parameters

None.

Body

The following is a coding example for simply resynchronizing pairs:

```
{
  "parameters": {
    "replicationType": "TC"
  }
}
```

The following is a coding example for resynchronizing pairs by specifying the MU (mirror unit) number of the copy group to be failed back:

```
{
  "parameters": {
    "replicationType": "UR",
    "doFailback": true,
    "failbackMuNumber": 1
  }
}
```

The following is a coding example for reversing and resynchronizing pairs by specifying the P-VOL:

```
{
  "parameters": {
    "replicationType": "UR",
    "doSwapPvol": true
  }
}
```

The following is a TrueCopy coding example for newly registering the specified copy group in a consistency group and resynchronizing pairs:

```
{
  "parameters": {
    "replicationType": "TC",
    "fenceLevel": "STATUS",
```

```

    "isConsistencyGroup": true,
    "consistencyGroupId": 123
  }
}

```

| Attribute | Type | Description |
|------------------|---------|---|
| replicationType | string | <p>(Required) Specify the pair type.</p> <ul style="list-style-type: none"> TC: TrueCopy UR: Universal Replicator |
| doFailback | boolean | <p>(Optional) Specify whether to perform a failback if a failure occurs in a 3DC cascade configuration.</p> <ul style="list-style-type: none"> <code>true</code>: A failback is performed. <code>false</code>: A failback is not performed. <p>If the value is omitted, <code>false</code> is assumed.</p> <p>If you specify <code>true</code> for this attribute, you cannot specify <code>true</code> for the <code>doSwapSvol</code> and <code>doSwapPvol</code> attributes. In the case of TC, you cannot specify the <code>fenceLevel</code> attribute.</p> |
| failbackMuNumber | int | <p>(Optional) Specify the MU (mirror unit) number of the volume to be failed back.</p> <p>You can specify this attribute only if the <code>doFailback</code> attribute is set to <code>true</code>.</p> |
| doSwapSvol | boolean | <p>(Optional) Specify the resynchronization method if the pairs on the specified S-VOL are split. Issue a request from the storage system of the secondary site.</p> <ul style="list-style-type: none"> <code>true</code>: Resynchronize pairs by specifying the S-VOL (swap resync). Reverse the P-VOL and the S-VOL. Copy the data of the new P-VOL to the S-VOL to resynchronize the pairs. <code>false</code>: Resynchronize pairs by specifying the P-VOL. Copy the data of the P-VOL to the S-VOL to resynchronize the pairs. <p>If the value is not specified, <code>false</code> will be set.</p> |

| Attribute | Type | Description |
|--------------------|---------|--|
| | | <p>If you specify <code>true</code> for this attribute, you cannot specify <code>true</code> for the <code>doSwapPvol</code> and <code>doFailback</code> attributes. In the case of TC, you also cannot specify the <code>fenceLevel</code> attribute.</p> |
| doSwapPvol | boolean | <p>(Optional) Specify the resynchronization method if the pairs in the specified P-VOL are split. Issue a request from the storage system of the primary site.</p> <ul style="list-style-type: none"> ▪ <code>true</code>: Resynchronize pairs by specifying the P-VOL (swap resync). Reverse the P-VOL and the S-VOL. Copy the data of the new P-VOL to the S-VOL to resynchronize the pairs. ▪ <code>false</code>: Resynchronize pairs by specifying the P-VOL. Copy the data of the P-VOL to the S-VOL to resynchronize the pairs. <p>If the value is not specified, <code>false</code> will be set.</p> <p>If you specify <code>true</code> for this attribute, you cannot specify <code>true</code> for the <code>doSwapSvol</code> and <code>doFailback</code> attributes. In the case of TC, you also cannot specify the <code>fenceLevel</code> attribute.</p> |
| isConsistencyGroup | boolean | <p>(Optional) In the case of TC, specify the value as follows according to whether the copy group is registered in a consistency group:</p> <ul style="list-style-type: none"> ▪ If the copy group is not registered in a consistency group <ul style="list-style-type: none"> • <code>true</code>: Registers the copy group in a consistency group. # • <code>false</code>: Leaves the copy group as it is without registering it in a consistency group. ▪ If the copy group is registered in a consistency group <ul style="list-style-type: none"> • <code>true</code>: Leaves the copy group registered in a consistency group. • <code>false</code>: Cancels the registration of the copy group in a consistency group, and places it in an unregistered state. |

| Attribute | Type | Description |
|--------------------|--------|--|
| | | <p>If the value is not specified, <code>false</code> will be set. To leave the pair registered in a consistency group, be sure to specify <code>true</code> for this attribute. To cancel registration in a consistency group, specify <code>false</code> for this attribute and, at the same time, specify the <code>fenceLevel</code> attribute.</p> <p>Make sure that each copy group contains either only pairs that are registered to a consistency group or only pairs that are not registered to a consistency group. If a copy group includes both pairs that are registered in a consistency group and pairs that are not registered in a consistency group, pair operations by consistency group cannot be correctly performed.</p> <p>If you specify <code>true</code> for this attribute, make sure to also specify the <code>fenceLevel</code> attribute.</p> |
| consistencyGroupId | int | <p>(Optional) In the case of TC, specify the consistency group ID by using a decimal (base 10) number in the range from 0 to 255.</p> <p>Use this attribute when registering the specified copy group in a consistency group.</p> <p>You cannot specify this attribute if the specified copy group is already registered in a consistency group.</p> <p>When specifying this attribute, make sure to specify <code>true</code> for the <code>isConsistencyGroup</code> attribute.</p> |
| fenceLevel | string | <p>(Required) In the case of TC, specify the fence level.</p> <ul style="list-style-type: none"> ▪ DATA: S-VOL data ▪ STATUS: S-VOL status ▪ NEVER: None <p>If you specify <code>true</code> for the <code>isConsistencyGroup</code> attribute, or if you cancel the registration by specifying <code>false</code> for <code>isConsistencyGroup</code>, be sure to specify this attribute. When you specify this attribute, if there is no change in the fence level, specify the value of the existing fence level.</p> <p>To change the fence level, specify the new value.</p> |

| Attribute | Type | Description |
|-----------------------|------|--|
| | | If you specify this attribute, you cannot specify <code>true</code> for the <code>doFailback</code> , <code>doSwapSvol</code> , and <code>doSwapPvol</code> attributes. |
| <code>copyPace</code> | int | (Optional) In the case of TC, specify a decimal (base 10) number in the range from 1 to 15 for the size of tracks to be copied. The larger the value you specify, the faster the copy speed. |

#: If the model of either or both of the storage systems is VSP E series, VSP G350, G370, G700, G900, VSP F350, F370, F700, F900, this value can be specified only if the number of pairs in the copy group is 1,000 or less.

Response message

Body

A job object is returned. For details on attributes other than `affectedResources`, see the section explaining job objects.

| Attribute | Description |
|--------------------------------|--|
| <code>affectedResources</code> | URL of the copy group of the resynchronized TrueCopy pairs or Universal Replicator pairs |

Action template

```
GET base-URL/v1/objects/remote-mirror-copygroups/object-ID/actions/resync
```

This action template returns only the specifiable attributes depending on the following: the type of the pairs of the copy group specified for the object ID, and whether the volume in the copy group of the local storage system is the primary volume or the secondary volume.

Status codes

The following table describes the meaning of the status code of the request for this operation. For details on other status codes, see the section explaining HTTP status codes.

| Status code | Message | Description |
|-------------|---------------------|--|
| 412 | Precondition Failed | This status code indicates that operations on the pairs of the specified copy group cannot be performed. |

Coding example

To get an action template:

When the storage system of the P-VOL is specified:

```
curl -v -H "Accept: application/json" -H "Remote-Authorization:Session
10399a1ffce3489b9c3a823017462396" -H "Authorization:Session
d7b673af189048468c5af9bcf3bbbb6f" -X GET https://192.0.2.100/
ConfigurationManager/v1/objects/remote-mirror-copygroups/886000123789,
remoteCopyGroup,remoteCopyGroupP_,remoteCopyGroupS_/actions/resync
```

When the storage system of the S-VOL is specified:

```
curl -v -H "Accept: application/json" -H "Remote-Authorization:Session
10399a1ffce3489b9c3a823017462396" -H "Authorization:Session
d7b673af189048468c5af9bcf3bbbb6f" -X GET https://192.0.2.100/
ConfigurationManager/v1/objects/remote-mirror-copygroups/886000123456,
remoteCopyGroup,remoteCopyGroupS_,remoteCopyGroupP_/actions/resync
```

To run the request after getting an action template:

When the storage system of the P-VOL is specified:

```
curl -v -H "Accept: application/json" -H "Remote-Authorization:Session
10399a1ffce3489b9c3a823017462396" -H "Content-Type: application/json" -H
"Authorization:Session d7b673af189048468c5af9bcf3bbbb6f" -X POST --data-
binary @./InputParameters.json https://192.0.2.100/ConfigurationManager/v1/
objects/remote-mirror-copygroups/886000123789,remoteCopyGroup,
remoteCopyGroupP_,remoteCopyGroupS_/actions/resync/invoke
```

When the storage system of the S-VOL is specified:

```
curl -v -H "Accept: application/json" -H "Remote-Authorization:Session
10399a1ffce3489b9c3a823017462396" -H "Content-Type: application/json" -H
"Authorization:Session d7b673af189048468c5af9bcf3bbbb6f" -X POST --data-
binary @./InputParameters.json https://192.0.2.100/ConfigurationManager/v1/
objects/remote-mirror-copygroups/886000123456,remoteCopyGroup,
remoteCopyGroupS_,remoteCopyGroupP_/actions/resync/invoke
```

Resynchronizing a TrueCopy pair or Universal Replicator pair

The following request resynchronizes the specified TrueCopy pair or Universal Replicator pair. If the pair is resynchronized, the differential data that was accumulated after the pair was split is copied from the primary volume to the secondary volume, so that the data is consistent between the two volumes. Do not simultaneously perform other operations on the copy group or the pairs in that copy group on which a pair resynchronization operation is performed.



Tip: We recommend specifying `Job-Mode-Wait-Configuration-Change:NoWait` in the request header of this API function. For details, see the description of the flow of operations for pairs.

**Note:**

If the model of either or both of the storage systems is VSP E series, VSP G350, G370, G700, G900, VSP F350, F370, F700, F900, to register TrueCopy pairs in a consistency group when performing a TrueCopy pair resynchronization operation, the number of pairs in the target copy group must be 1,000 or less. If the number of pairs exceeds 1,000, delete all pairs in the copy group, and then register pairs in a consistency group when you re-create the pairs. Alternatively, delete some pairs so that the number of pairs decreases to 1,000 or less, perform a pair resynchronization operation, and then register the pairs in a consistency group when you re-create the pairs that you deleted.

Execution permission

Storage Administrator (Remote Copy)

Request line

```
POST base-URL/v1/objects/remote-mirror-copypairs/object-ID/actions/resync/
invoke
```

Request message**Object ID**

Specify the value of `remoteMirrorCopyPairId` that was obtained by the processing to get information about the remote copy pair. You can also specify the attributes and connect them with commas as follows:

```
remoteStorageDeviceId, copyGroupName, localDeviceGroupName,
remoteDeviceGroupName, copyPairName
```

| Attribute | Type | Description |
|------------------------------------|--------|--|
| <code>remoteStorageDeviceId</code> | string | (Required) Storage device ID of the remote storage system |
| <code>copyGroupName</code> | string | (Required) Copy group name Specify a name consisting of 1 to 31 characters. The name is case sensitive. |
| <code>localDeviceGroupName</code> | string | (Required) Device group name in the local storage system |

| Attribute | Type | Description |
|-----------------------|--------|---|
| | | Specify a name consisting of 1 to 31 characters. The name is case sensitive. |
| remoteDeviceGroupName | string | (Required) Device group name in the remote storage system Specify a name consisting of 1 to 31 characters. The name is case sensitive. |
| copyPairName | string | (Required) Copy pair name Specify a name consisting of 1 to 31 characters. The name is case sensitive. |

Query parameters

None.

Body

The following is a coding example for simply resynchronizing pairs:

```
{
  "parameters": {
    "replicationType": "UR"
  }
}
```

The following is a coding example for resynchronizing a pair to be failed back by specifying the MU (mirror unit) number of the pair:

```
{
  "parameters": {
    "replicationType": "TC",
    "doFailback": true,
    "failbackMuNumber": 1
  }
}
```

The following is a coding example for reversing and resynchronizing a pair by specifying the S-VOL:

```
{
  "parameters": {
    "replicationType": "TC",
    "doSwapSvol": true
  }
}
```



```

}
}

```

| Attribute | Type | Description |
|------------------|---------|--|
| replicationType | string | <p>(Required) Specify the pair type.</p> <ul style="list-style-type: none"> TC: TrueCopy UR: Universal Replicator |
| doFailback | boolean | <p>(Optional) Specify whether to perform a failback if a failure occurs in a 3DC cascade configuration.</p> <ul style="list-style-type: none"> true: A failback is performed. false: A failback is not performed. <p>If the value is omitted, false is assumed.</p> <p>If you specify true for this attribute, you cannot specify true for the doSwapSvol and doSwapPvol attributes. In the case of TC, you cannot specify the fenceLevel attribute.</p> |
| failbackMuNumber | int | <p>(Optional) Specify the MU (mirror unit) number of the volume to be failed back.</p> <p>You can specify this attribute only if the doFailback attribute is set to true.</p> |
| doSwapSvol | boolean | <p>(Optional) Specify the resynchronization method if the pairs on the specified S-VOL are split. Issue a request from the storage system of the secondary site.</p> <ul style="list-style-type: none"> true: Resynchronize pairs by specifying the S-VOL (swap resync). Reverse the P-VOL and the S-VOL. Copy the data of the new P-VOL to the S-VOL to resynchronize the pairs. false: Resynchronize pairs by specifying the P-VOL. Copy the data of the P-VOL to the S-VOL to resynchronize the pairs. <p>If the value is not specified, false will be set.</p> |

| Attribute | Type | Description |
|--------------------|---------|--|
| | | If you specify <code>true</code> for this attribute, you cannot specify <code>true</code> for the <code>doSwapPvol</code> and <code>doFailback</code> attributes. In the case of TC, you also cannot specify the <code>fenceLevel</code> attribute. |
| doSwapPvol | boolean | <p>(Optional) Specify the resynchronization method if the pairs in the specified P-VOL are split. Issue a request from the storage system of the primary site.</p> <ul style="list-style-type: none"> ▪ <code>true</code>: Resynchronize pairs by specifying the P-VOL (swap resync). Reverse the P-VOL and the S-VOL. Copy the data of the new P-VOL to the S-VOL to resynchronize the pairs. ▪ <code>false</code>: Resynchronize pairs by specifying the P-VOL. Copy the data of the P-VOL to the S-VOL to resynchronize the pairs. <p>If the value is not specified, <code>false</code> will be set.</p> <p>If you specify <code>true</code> for this attribute, you cannot specify <code>true</code> for the <code>doSwapSvol</code> and <code>doFailback</code> attributes. In the case of TC, you also cannot specify the <code>fenceLevel</code> attribute.</p> |
| isConsistencyGroup | boolean | <p>(Optional) In the case of TC, specify the value as follows according to whether the pair is registered in a consistency group:</p> <ul style="list-style-type: none"> ▪ If the pair is not registered in a consistency group <ul style="list-style-type: none"> • <code>true</code>: Registers the pair in a consistency group. # • <code>false</code>: Leaves the pair as it is without registering it in a consistency group. ▪ If the pair is registered in a consistency group <ul style="list-style-type: none"> • <code>true</code>: Leaves the pair registered in a consistency group. • <code>false</code>: Cancels the registration of the pair in a consistency group, and places it in an unregistered state. |

| Attribute | Type | Description |
|--------------------|--------|--|
| | | <p>If the value is not specified, <code>false</code> will be set. To leave the pair registered in a consistency group, be sure to specify <code>true</code> for this attribute. To cancel registration in a consistency group, specify <code>false</code> for this attribute and, at the same time, specify the <code>fenceLevel</code> attribute.</p> <p>Make sure that each copy group contains either only pairs that are registered to a consistency group or only pairs that are not registered to a consistency group. If a copy group includes both pairs that are registered in a consistency group and pairs that are not registered in a consistency group, pair operations by consistency group cannot be correctly performed.</p> <p>If you specify <code>true</code> for this attribute, make sure to also specify the <code>fenceLevel</code> attribute.</p> |
| consistencyGroupId | int | <p>(Optional) In the case of TC, specify the consistency group ID by using a decimal (base 10) number in the range from 0 to 255.</p> <p>Use this attribute when registering the specified copy group in a consistency group.</p> <p>You cannot specify this attribute if the specified pair is already registered in a consistency group.</p> <p>Unify the consistency group ID within the copy group. If a copy group includes a pair whose consistency group ID differs, pair operations by consistency group cannot be correctly performed.</p> <p>When specifying this attribute, make sure to specify <code>true</code> for the <code>isConsistencyGroup</code> attribute.</p> |
| fenceLevel | string | <p>(Required) In the case of TC, specify the fence level.</p> <ul style="list-style-type: none"> ▪ DATA: S-VOL data ▪ STATUS: S-VOL status ▪ NEVER: None |

| Attribute | Type | Description |
|-----------------------|------------------|---|
| | | <p>If you specify <code>true</code> for the <code>isConsistencyGroup</code> attribute, or if you cancel the registration by specifying <code>false</code> for <code>isConsistencyGroup</code>, be sure to specify this attribute. When you specify this attribute, if there is no change in the fence level, specify the value of the existing fence level.</p> <p>To change the fence level, specify the new value.</p> <p>If you specify this attribute, you cannot specify <code>true</code> for the <code>doFailback</code>, <code>doSwapSvol</code>, and <code>doSwapPvol</code> attributes.</p> |
| <code>copyPace</code> | <code>int</code> | (Optional) In the case of TC, specify a decimal (base 10) number in the range from 1 to 15 for the size of tracks to be copied. The larger the value you specify, the faster the copy speed. |

#: If the model of either or both of the storage systems is VSP E series, VSP G350, G370, G700, G900, VSP F350, F370, F700, F900, this value can be specified only if the number of pairs in the copy group is 1,000 or less.

Response message

Body

A job object is returned. For details on attributes other than `affectedResources`, see the section explaining job objects.

| Attribute | Description |
|--------------------------------|--|
| <code>affectedResources</code> | URL of the resynchronized TrueCopy pairs or Universal Replicator pairs |

Action template

```
GET base-URL/v1/objects/remote-mirror-coppairs/object-ID/actions/resync
```

This action template returns only the specifiable attributes depending on the following: the type of the pair specified for the object ID, and whether the volume in the local storage system is the primary volume or the secondary volume.

Status codes

The following table describes the meaning of the status code of the request for this operation. For details on other status codes, see the section explaining HTTP status codes.

| Status code | Message | Description |
|-------------|---------------------|---|
| 412 | Precondition Failed | This status code indicates that operations on the specified pair cannot be performed. |

Coding example

To get an action template:

When the storage system of the P-VOL is specified:

```
curl -v -H "Accept: application/json" -H "Remote-Authorization:Session
10399a1ffce3489b9c3a823017462396" -H "Authorization:Session
d7b673af189048468c5af9bcf3b666f" -X GET https://192.0.2.100/
ConfigurationManager/v1/objects/remote-mirror-copypairs/886000123789,
remoteCopyGroup,remoteCopyGroupP_,remoteCopyGroupS_,pair1/actions/resync
```

When the storage system of the S-VOL is specified:

```
curl -v -H "Accept: application/json" -H "Remote-Authorization:Session
10399a1ffce3489b9c3a823017462396" -H "Authorization:Session
d7b673af189048468c5af9bcf3b666f" -X GET https://192.0.2.100/
ConfigurationManager/v1/objects/remote-mirror-copypairs/886000123456,
remoteCopyGroup,remoteCopyGroupS_,remoteCopyGroupP_,pair1/actions/resync
```

To run the request after getting an action template:

When the storage system of the P-VOL is specified:

```
curl -v -H "Accept: application/json" -H "Remote-Authorization:Session
10399a1ffce3489b9c3a823017462396" -H "Content-Type: application/json" -H
"Authorization:Session d7b673af189048468c5af9bcf3b666f" -X POST --data-
binary @./InputParameters.json https://192.0.2.100/ConfigurationManager/v1/
objects/remote-mirror-copypairs/886000123789,remoteCopyGroup,
remoteCopyGroupP_,remoteCopyGroupS_,pair1/actions/resync/invoke
```

When the storage system of the S-VOL is specified:

```
curl -v -H "Accept: application/json" -H "Remote-Authorization:Session
10399a1ffce3489b9c3a823017462396" -H "Content-Type: application/json" -H
"Authorization:Session d7b673af189048468c5af9bcf3b666f" -X POST --data-
binary @./InputParameters.json https://192.0.2.100/ConfigurationManager/v1/
objects/remote-mirror-copypairs/886000123456,remoteCopyGroup,
remoteCopyGroupS_,remoteCopyGroupP_,pair1/actions/resync/invoke
```

Deleting TrueCopy pairs or Universal Replicator pairs in units of copy groups

The following request deletes TrueCopy pairs or Universal Replicator pairs by using the specified copy group. When the pairs are all deleted, the device groups are also deleted. Before deleting a pair, lock the resources or make sure the resources have not been locked by another user.

Execution permission

Storage Administrator (Provisioning) and Storage Administrator (Remote Copy)

Request line

```
DELETE base-URL/v1/objects/remote-mirror-copygroups/object-ID
```

Request message

Object ID

Specify the value of `remoteMirrorCopyGroupId` that was obtained by the processing to get information about the remote copy group. You can also specify the attributes and connect them with commas as follows:

```
remoteStorageDeviceId, copyGroupName, localDeviceGroupName, remoteDeviceGroupName
```

| Attribute | Type | Description |
|-----------------------|--------|---|
| remoteStorageDeviceId | string | (Required) Storage device ID of the remote storage system |
| copyGroupName | string | (Required) Copy group name Specify a name consisting of 1 to 31 characters. The name is case sensitive. |
| localDeviceGroupName | string | (Required) Device group name in the local storage system Specify a name consisting of 1 to 31 characters. The name is case sensitive. |
| remoteDeviceGroupName | string | (Required) Device group name in the remote storage system Specify a name consisting of 1 to 31 characters. The name is case sensitive. |

Query parameters

None.

Body

None.

Response message**Body**

A job object is returned. For details on attributes other than affectedResources, see the section explaining job objects.

| Attribute | Description |
|-------------------|---|
| affectedResources | URL of the copy group of the deleted TrueCopy pairs or Universal Replicator pairs |

Status codes

For details on the status codes of the request for this operation, see the description on HTTP status codes.

Coding example

```
curl -v -H "Accept: application/json" -H "Remote-Authorization:Session
10399alffce3489b9c3a823017462396" -H "Content-Type: application/json" -H
"Authorization:Session d7b673af189048468c5af9bcf3b66b6f" -X DELETE --data-
binary @./InputParameters.json https://192.0.2.100/ConfigurationManager/v1/
objects/remote-mirror-copygroups/886000123789,remoteCopyGroup,
remoteCopyGroupP_,remoteCopyGroupS_
```

Deleting a TrueCopy pair or Universal Replicator pair

The following request deletes the specified TrueCopy pair or Universal Replicator pair. As a result of deleting a pair, if there is no pair in the copy group, the copy group and the device group are also deleted. Before deleting a pair, lock the resources or make sure that the resources have not been locked by another user.

Execution permission

Storage Administrator (Provisioning) and Storage Administrator (Remote Copy)

Request line

```
DELETE base-URL/v1/objects/remote-mirror-copypairs/object-ID
```

Request message**Object ID**

Specify the value of `remoteMirrorCopyPairId` that was obtained by the processing to get information about the remote copy pair. You can also specify the attributes and connect them with commas as follows:

```
remoteStorageDeviceId, copyGroupName, localDeviceGroupName,
remoteDeviceGroupName, copyPairName
```

| Attribute | Type | Description |
|------------------------------------|--------|---|
| <code>remoteStorageDeviceId</code> | string | (Required) Storage device ID of the remote storage system |
| <code>copyGroupName</code> | string | (Required) Copy group name Specify a name consisting of 1 to 31 characters. The name is case sensitive. |
| <code>localDeviceGroupName</code> | string | (Required) Device group name in the local storage system Specify a name consisting of 1 to 31 characters. The name is case sensitive. |
| <code>remoteDeviceGroupName</code> | string | (Required) Device group name in the remote storage system Specify a name consisting of 1 to 31 characters. The name is case sensitive. |
| <code>copyPairName</code> | string | (Required) Copy pair name Specify a name consisting of 1 to 31 characters. The name is case sensitive. |

Query parameters

None.

Body

None.

Response message**Body**

A job object is returned. For details on attributes other than `affectedResources`, see the section explaining job objects.

| Attribute | Description |
|--------------------------------|---|
| <code>affectedResources</code> | URL of the deleted TrueCopy pairs or Universal Replicator pairs |

Status codes

For details on the status codes of the request for this operation, see the description on HTTP status codes.

Coding example

```
curl -v -H "Accept: application/json" -H "Remote-Authorization:Session
10399a1ffce3489b9c3a823017462396" -H "Content-Type: application/json" -H
"Authorization:Session d7b673af189048468c5af9bcf3bbbb6f" -X DELETE --data-
binary @./InputParameters.json https://192.0.2.100/ConfigurationManager/v1/
objects/remote-mirror-copypairs/886000123789,remoteCopyGroup,
remoteCopyGroupP_,remoteCopyGroupS_,pair1
```

Enabling volumes at the secondary site to take over work in units of copy groups

If a failure occurs at the primary site, the following request switches the roles between the primary volumes and the secondary volumes of Universal Replicator pairs (in units of copy groups) to enable data to be written in the secondary volumes so that work can be taken over and continued at the secondary site. This API request runs on the storage system of the secondary site.

**Note:**

- Valid targets are Universal Replicator pairs that are not in a cascade configuration.
- When running this API request, you do not need to specify `Remote-Authorization` for the request header.
- If you specify `Job-Mode-Wait-Configuration-Change:NoWait` for the request header, specify `forceSplit` for mode in the request body. When these are specified, the value specified for `timeout` is ignored.

Execution permission

Storage Administrator (Remote Copy)

Request line

```
POST base-URL/v1/objects/remote-mirror-copygroups/object-ID/actions/
takeover/invoke
```

Request message**Object ID**

Specify the `remoteMirrorCopyGroupId` value obtained by getting information about the remote copy group. You can also specify the attributes separated by commas as follows:

```
remoteStorageDeviceId, copyGroupName, localDeviceGroupName,
remoteDeviceGroupName
```

| Attribute | Type | Description |
|------------------------------------|--------|---|
| <code>remoteStorageDeviceId</code> | string | (Required) Storage device ID of the remote storage system For this API request, specify <code>NotSpecified</code> . |
| <code>copyGroupName</code> | string | (Required) Copy group name Specify a character string of 1 to 31 characters. The name is case sensitive. |
| <code>localDeviceGroupName</code> | string | (Required) Device group name at the local storage system Specify a character string of 1 to 31 characters. The name is case sensitive. |
| <code>remoteDeviceGroupName</code> | string | (Required) Device group name at the remote storage system For this API request, specify <code>NotSpecified</code> . |

Query parameters

None.

Body

```
{
  "parameters": {
    "mode": "auto"
  }
}
```

| Attribute | Type | Description |
|-----------|--------|--|
| mode | string | <p>(Required) Execution mode at takeover</p> <p>After the P-VOL and the S-VOL are switched, the pair is in a split status (SSWS) and writable. For the subsequent transition of the pair status, specify one of the following values:</p> <ul style="list-style-type: none"> ▪ <code>forceSplit</code>: Does not change from the status in which the pair is split (SSWS). ▪ <code>auto</code>: Resynchronize the pair if possible according to the status of the storage system. <p>If you specify <code>Job-Mode-Wait-Configuration-Change:NoWait</code> for the request header, specify <code>forceSplit</code>.</p> |
| timeout | int | <p>(Optional) Timeout period for waiting for completion of synchronization of differential data (seconds)</p> <p>Specify the timeout time for the processing that synchronizes the differential data with the S-VOL if the journal contains differential data.</p> <p>Specify a value in the range from 1 to 10000.</p> <p>If you do not specify a value, 7200 is assumed.</p> <p>If you specify <code>Job-Mode-Wait-Configuration-Change:NoWait</code> for the request header, the value specified for this attribute is ignored.</p> <p>If the synchronization of the pairs does not finish within the specified time, the REST API job fails. However, on the storage system, the synchronization processing and the splitting processing after the synchronization is completed continue to be performed. To check whether the synchronization of the pairs has finished, obtain the information about the target pairs.</p> |

Response message**Body**

A job object is returned. For details on attributes other than `affectedResources`, see the section explaining job objects.

| Attribute | Description |
|--------------------------------|--|
| <code>affectedResources</code> | URL of the copy group of the Universal Replicator pairs that were switched |

Action template

None.

Status codes

For details on the status codes of the request for this operation, see the description on HTTP status codes.

Coding example

```
curl -v -H "Accept: application/json" -H "Content-type: application/json" -H "Authorization:Session d7b673af189048468c5af9bcf3b666f" -X POST --data-binary @./InputParameters.json https://192.0.2.100/ConfigurationManager/v1/objects/remote-mirror-copygroups/NotSpecified,copyGroup,localDeviceGroup,NotSpecified/actions/takeover/invoke
```

Enabling volumes at the secondary site to take over work in units of copy pairs

If a failure occurs at the primary site, you can continue your work at the secondary site by switching the roles of the primary volume and the secondary volume of the Universal Replicator pair (in units of copy pairs), to enable writing to the secondary volume (takeover). This API is executed on the storage system of the secondary site.

**Note:**

- Valid targets are Universal Replicator pairs that are not in a cascade configuration.
- When running this API request, you do not need to specify `Remote-Authorization` for the request header.
- If you specify `Job-Mode-Wait-Configuration-Change:NoWait` for the request header, specify `forceSplit` for mode in the request body. When these are specified, the value specified for `timeout` is ignored.

Execution permission

Storage Administrator (Remote Copy)

Request line

```
POST base-URL/v1/objects/remote-mirror-copypairs/object-ID/actions/
takeover/invoke
```

Request message**Object ID**

Specify the value of `remoteMirrorCopyPairId` that was obtained by the processing to get information about the remote copy pair. You can also specify the attributes and connect them with commas as follows:

```
remoteStorageDeviceId, copyGroupName, localDeviceGroupName,
remoteDeviceGroupName, copyPairName
```

| Attribute | Type | Description |
|------------------------------------|--------|---|
| <code>remoteStorageDeviceId</code> | string | (Required) Storage device ID of the remote storage system For this API request, specify <code>NotSpecified</code> . |
| <code>copyGroupName</code> | string | (Required) Copy group name Specify a character string of 1 to 31 characters. The name is case sensitive. |
| <code>localDeviceGroupName</code> | string | (Required) Device group name at the local storage system Specify a character string of 1 to 31 characters. The name is case sensitive. |
| <code>remoteDeviceGroupName</code> | string | (Required) Device group name at the remote storage system For this API request, specify <code>NotSpecified</code> . |
| <code>copyPairName</code> | string | (Required) Copy pair name Specify a name consisting of 1 to 31 characters. The name is case sensitive. |

Query parameters

None.

Body

```
{
  "parameters": {
    "mode": "auto"
  }
}
```

| Attribute | Type | Description |
|-----------|--------|---|
| mode | string | <p>(Required) Execution mode at takeover</p> <p>After the P-VOL and the S-VOL are switched, the pair is in a split status (SSWS) and writable. For the subsequent transition of the pair status, specify one of the following values:</p> <ul style="list-style-type: none"> ▪ <code>forceSplit</code>: Does not change from the status in which the pair is split (SSWS). ▪ <code>auto</code>: Resynchronize the pair if possible according to the status of the storage system. <p>If you specify <code>Job-Mode-Wait-Configuration-Change:NoWait</code> for the request header, specify <code>forceSplit</code>.</p> |
| timeout | int | <p>(Optional) Timeout period for waiting for completion of synchronization of differential data (seconds)</p> <p>Specify the timeout time for the processing that synchronizes the differential data with the S-VOL if the journal contains differential data.</p> <p>Specify a value in the range from 1 to 10000.</p> <p>If you do not specify a value, 7200 is assumed.</p> <p>If you specify <code>Job-Mode-Wait-Configuration-Change:NoWait</code> for the request header, the value specified for this attribute is ignored.</p> |

| Attribute | Type | Description |
|-----------|------|--|
| | | If the synchronization of the pairs does not finish within the specified time, the REST API job fails. However, on the storage system, the synchronization processing and the splitting processing after the synchronization is completed continue to be performed. To check whether the synchronization of the pairs has finished, obtain the information about the target pairs. |

Response message

Body

A job object is returned. For details on attributes other than affectedResources, see the section explaining job objects.

| Attribute | Description |
|-------------------|--|
| affectedResources | URL of the copy group of the Universal Replicator pairs that were switched |

Action template

None.

Status codes

For details on the status codes of the request for this operation, see the description on HTTP status codes.

Coding example

```
curl -v -H "Accept: application/json" -H "Content-type: application/json" -H "Authorization:Session d7b673af189048468c5af9bcf3b6666f" -X POST --data-binary @./InputParameters.json https://192.0.2.100/ConfigurationManager/v1/objects/remote-mirror-copypairs/NotSpecified,copyGroup,localDeviceGroup,NotSpecified,pair/actions/takeover/invoke
```

Chapter 12: Managing global-active device pairs

This chapter describes how to perform operations on global-active device pairs by using the REST API.

Overview of global-active device

Global-active device enables you to duplicate volumes between two storage systems to improve availability of the storage systems. If you register resources of each storage system in the same virtual storage machine and specify the same virtual LDEV ID for the volumes to be paired, the host can handle the volumes as a volume of a storage system. I/O from the host can be received by both storage systems. If data is written in one volume, the data is automatically synchronized with another volume.

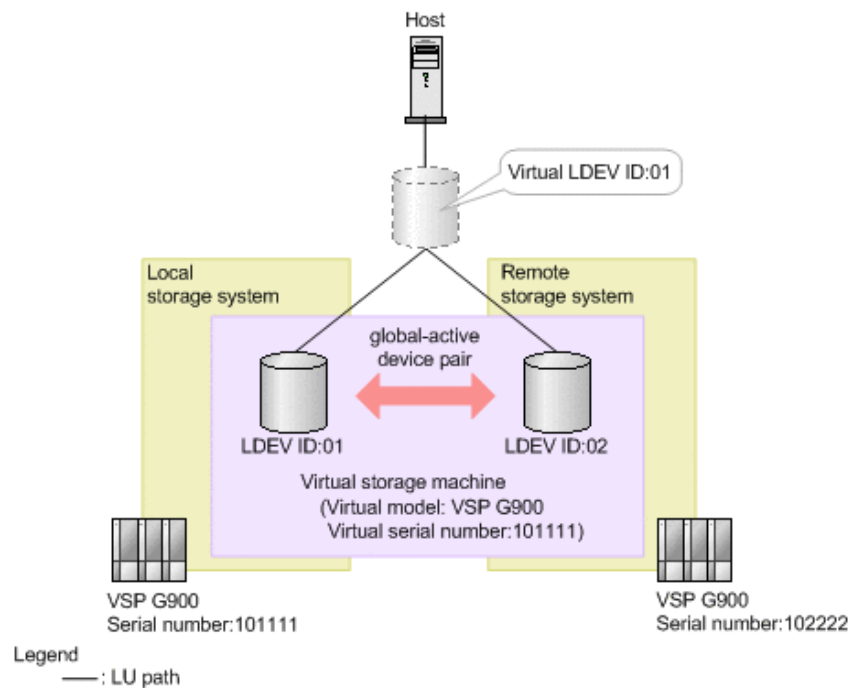

If you issue an API request from a REST API client, you can create a global-active device pair, or perform operations on pairs when stopping either storage system for maintenance.

To perform operations on global-active device pairs, you must set up a quorum in advance. If a path or a storage system fails, the quorum disk determines the storage system on which I/O operations from the server will continue.

For a global-active device in a cross-path configuration (using a Fibre Channel connection), you can change the volume settings to enable the ALUA attribute or to set the priority levels of ALUA paths.

For details on global-active device, see the *Global-Active Device User Guide*.

Workflow for operating global-active device pairs

The global-active device pair operation, which is performed in an environment that uses the REST API, is divided into normal operation and maintenance operation.



Important:

If you perform operations on or get information about global-active device pairs, specify Remote-Authorization for the request header.

Normal operation

The following figure shows the workflow for the normal operation.

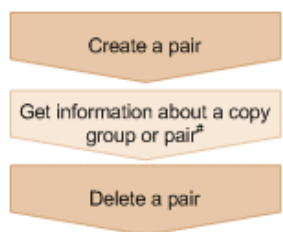

#: Optional operation

Creating a pair

Create a pair, and then copy all of the data in the P-VOL to the S-VOL. The pair is duplicated. Create a pair in a new copy group (mirror), or add a pair to an existing copy group (mirror). A copy group is a group made up of copy pairs. Each copy group consists of a device group made up of P-VOLs, and a device group made up of S-VOLs.

Getting information about a copy group or pair

You can perform operations on the pair in units of copy groups or pairs.

Deleting a pair

Suspend the pair in advance, and then dissolve the pair status of the volumes.

Maintenance operation

You can use the REST API to stop the storage systems used by global-active device as planned and to perform maintenance work.

The following figure shows the workflow for performing maintenance work of the primary site.

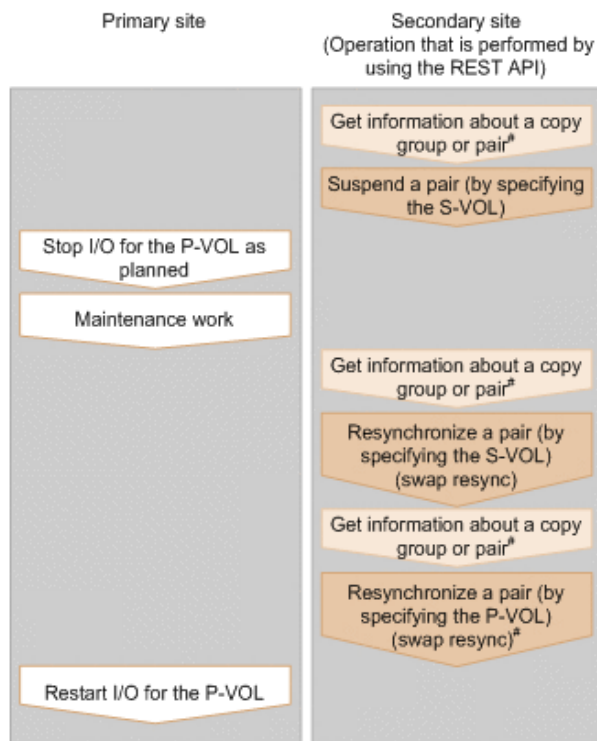

#: Optional operation

Suspending a pair (by specifying the S-VOL)

Suspend the status of a pair that is duplicated. I/O is switched to the secondary site.

Stopping I/O for the P-VOL as planned

Stop I/O for the P-VOL.

Maintenance work

At the primary site, upgrade the micro version or perform other maintenance work.

Resynchronizing a pair (by specifying the S-VOL) (swap resync)

After the maintenance work, resynchronize the differential data generated during stop of the P-VOL. Switch the P-VOL and the S-VOL, and then copy the data of the switched P-VOL to the S-VOL to resynchronize the pair.



Note:

Resynchronization can be performed in units of copy groups or pairs. If you want to register pairs to a consistency group during resynchronization, perform resynchronization in units of copy groups. Do not perform resynchronization in units of pairs.

Resynchronizing a pair (by specifying the P-VOL) (swap resync)

If necessary, switch the switched P-VOL and S-VOL.

Restarting I/O for the P-VOL

Restart I/O for the P-VOL.

Specifying Job-Mode-Wait-Configuration-Change in the request header

During the creation, splitting, and resynchronizing of pairs, if multiple asynchronous processing requests are issued at the same time, jobs might get stuck and the job status might not change to `Completed` because data copying takes a long time. In such cases, specify `Job-Mode-Wait-Configuration-Change:NoWait` in the request header so that the job status changes to `Completed` without waiting for data copying to finish, and the next job starts. At this time, data copying continues even after job execution ends. To check whether data copying has finished, check the pair status of the target resource instead of the job status. For details about the pair status, see the description of the pair status transitions.

Pair status (global-active device)

The following explains the operations and status transitions for global-active device pairs.

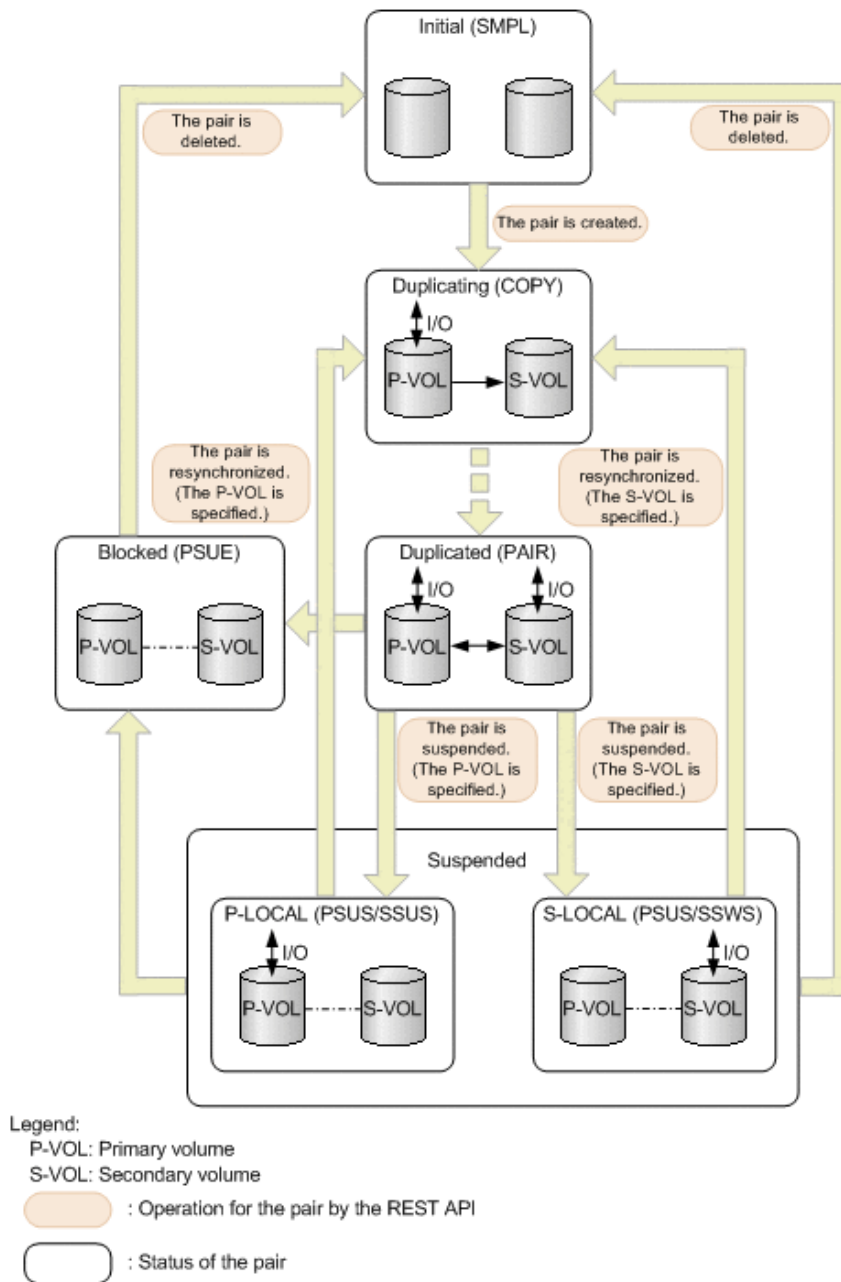

Management of the status for global-active device pairs

Global-active device pairs are managed based on the following statuses and mode:

- **GAD status**
 Status of a global-active device pair. The value is determined by the combination of the pair status and I/O mode, and is not output anywhere.
- **Pair status**
 Pair statuses for the primary volume and the secondary volume
- **I/O mode**
 I/O modes for the primary volume and the secondary volume

The following table shows GAD status values.

| GAD status | Description |
|-------------------|---|
| Simplex | Status before creating a pair |
| Mirroring | The status is being changed to the mirrored status. This status indicates either of the following cases: <ul style="list-style-type: none"> ▪ A Quorum disk is being prepared. ▪ Data in the P-VOL is being copied to the S-VOL. |
| Mirrored | The pair is running normally. Data is duplicated. |
| Suspended | The pair is suspended by operation or due to a failure. The latest data is stored in either the P-VOL or the S-VOL. I/O from the host targets only the volume that contains the latest data. |
| Blocked | Multiple failures occurred at the same time, and neither the P-VOL nor the S-VOL accepts I/O from the host. This status indicates either of the following cases: <ul style="list-style-type: none"> ▪ The latest data is stored in both the P-VOL and the S-VOL, and one of the volumes can accept I/O from the host if the pair is forcibly deleted. However, the REST API cannot be used to forcibly delete the pair. ▪ A failure occurred on the local storage system or the remote storage system, and the volume on the other storage system also blocks I/O from the host. |

The following table shows pair status values. The primary volume and the secondary volume each have the pair status.

| Pair status | Description |
|--------------------|--|
| SMPL | Unpaired volumes |
| COPY | A pair is being created. An initial copy or resynchronization is being performed. |
| PAIR | Paired volumes The initial copy is completed, and data is duplicated. |
| PSUS | The pair is suspended by operation. |

| Pair status | Description |
|-------------|--|
| | (This value is output for the P-VOL.) |
| SSUS | The pair is suspended by operation, and the S-VOL is not updated. (This value is output for the S-VOL.) |
| PSUE | The pair is suspended and blocked due to a failure. |
| SSWS | The pair is suspended by operation or due to a failure, and the P-VOL is not updated. (This value is output for the S-VOL.) |

The following table shows I/O mode values. I/O mode indicates the I/O operations for the primary and secondary volumes that make up a global-active device pair.

| I/O mode | Status | Read processing | Write processing |
|----------|-------------|---|--|
| L/M | Mirror (RL) | Data in the volume on the local storage system is sent to the host. | Data is written to the volumes on the local storage system and the remote storage system, in this order. |
| L/L | Local | Data in the volume on the local storage system is sent to the host. | Data is written to the volume on the local storage system only. |
| B/B | Block | Denied. (An illegal request is returned.) | Denied. (An illegal request is returned.) |

"L" indicates "local". "M" indicates "Mirror". "B" indicates "Block".

The following table shows the relationships of the GAD status, pair status, and I/O mode.

| GAD status | Trigger of suspension | P-VOL | | S-VOL | | Volume that contains the latest data |
|------------|-----------------------|-------------|----------|-------------|----------|--------------------------------------|
| | | Pair status | I/O mode | Pair status | I/O mode | |
| Simplex | -- | SMPL | -- | SMPL | -- | -- |
| Mirroring | -- | COPY | L/M | COPY | B/B | P-VOL |
| Mirrored | -- | PAIR | L/M | PAIR | L/M | P-VOL |

| GAD status | Trigger of suspension | P-VOL | | S-VOL | | Volume that contains the latest data | | |
|---------------------|------------------------|-------------|----------|-------------|----------|--------------------------------------|------|----|
| | | Pair status | I/O mode | Pair status | I/O mode | | | |
| | | | | | | S-VOL | | |
| Suspended (P-LOCAL) | Operation for the pair | PSUS | L/L | SSUS | B/B | P-VOL | | |
| | Failure | PSUE | L/L | PSUE | B/B | | | |
| | | | | SMPL | -- | | | |
| | | | | N | N | | | |
| Suspended (S-LOCAL) | Operation for the pair | PSUS | B/B | SSWS | L/L | S-VOL | | |
| | Failure | PSUE | B/B | SSWS | L/L | | | |
| | | | | | | | SMPL | -- |
| | | | | | | | N | N |
| Blocked | -- | PSUE | B/B | PSUE | B/B | P-VOL | | |
| | | | | N | N | S-VOL | | |
| | | N | N | PSUE | B/B | | | |

(Legend)

--: Not applied.

N: The I/O mode and pair status cannot be confirmed due to a storage system failure.



Note:

In the following cases, if you perform an operation on a pair, the request successfully returns a response, but the details specified in the request body are not actually applied:

- When you perform a pair suspending operation on a pair for which the status is PSUS or SSUS
- When you perform a pair resynchronization operation on a pair for which the status is COPY or PAIR

Getting a list of remote copy groups

The following request gets a list of all the remote copy groups in which the remote copy pairs (TrueCopy, Universal Replicator, and global-active device) of the target storage system are registered. If the device group name or copy group name contains single-byte spaces, copy group information cannot be obtained.

Execution permission

Storage Administrator (View Only)

Request line

```
GET base-URL/v1/objects/remote-mirror-copygroups
```

Request message

Object ID

None.

Query parameters

You can get only a list of remote copy groups, or you can get detailed information about remote copy pairs in addition to a list of remote copy groups.

- To get a list of remote copy groups only:

| Parameter | Type | Filter condition |
|-----------------------|--------|--|
| remoteStorageDeviceId | string | (Required) Storage device ID of the remote storage system If a failure occurs in a remote storage system and you then specify <code>NotSpecified</code> , only the information about the local storage system is obtained. In this situation (when a failure occurs and you specify <code>NotSpecified</code>), you do not need to specify the <code>Remote-Authorization</code> header. |

| Parameter | Type | Filter condition |
|-----------|------|--|
| | | If you specify <code>NotSpecified</code> for this parameter, you cannot specify the <code>detailInfoType</code> parameter. |

- To obtain additional detailed information:

| Parameter | Type | Description |
|-----------------------------|--------|--|
| <code>detailInfoType</code> | string | <p>(Optional) Type of detailed information to be obtained</p> <ul style="list-style-type: none"> ▪ <code>pair</code> <p>Gets additional detailed information[#] about remote copy pairs.</p> <p>You can specify this item for VSP 5000 series.</p> <p>To get up-to-date information, you must run the API request that refreshes the storage system's cache before running this request. For details, see "Updating the cache of storage system configuration information".</p> <p>If you specify <code>NotSpecified</code> for the <code>remoteStorageDeviceId</code> parameter, you cannot specify this parameter.</p> |

[#]: If the remote storage system is a VSP E series, VSP G350, G370, G700, G900 or VSP F350, F370, F700, F900 model storage system, you might not be able to get some of the information about the remote storage system.

For other storage systems, if the remote storage system's microcode version meets the following conditions, you might not be able to get some of the information about the remote storage system.

- For a VSP 5000 series storage system:
The microcode version is earlier than 90-01-42-XX/XX.
- For a VSP G1000, VSP G1500, VSP F1500 model storage system:
The microcode version is earlier than 80-06-71-XX/XX.

Body

None.

Response message**Body**

```
{
  "data" : [ {
    "remoteMirrorCopyGroupId" : "886000123789,remoteCopyGroup1,
remoteCopyGroup1S_,remoteCopyGroup1P_",
    "copyGroupName" : "remoteCopyGroup1",
    "muNumber" : 0,
    "remoteStorageDeviceId" : "886000123789",
    "localDeviceGroupName" : "remoteCopyGroup1S_",
    "remoteDeviceGroupName" : "remoteCopyGroup1P_"
  }, {
    "remoteMirrorCopyGroupId" : "886000123789,remoteCopyGroup2,
remoteCopyGroup2P_,remoteCopyGroup2S_",
    "copyGroupName" : "remoteCopyGroup2",
    "muNumber" : 0,
    "remoteStorageDeviceId" : "886000123789",
    "localDeviceGroupName" : "remoteCopyGroup2P_",
    "remoteDeviceGroupName" : "remoteCopyGroup2S_"
  }, {
    "remoteMirrorCopyGroupId" : "886000123789,remoteCopyGroup3,
remoteCopyGroup3P_,remoteCopyGroup3S_",
    "copyGroupName" : "remoteCopyGroup3",
    "muNumber" : 0,
    "remoteStorageDeviceId" : "886000123789",
    "localDeviceGroupName" : "remoteCopyGroup3P_",
    "remoteDeviceGroupName" : "remoteCopyGroup3S_"
  } ]
}
```

| Attribute | Type | Description |
|-----------------------|--------|--|
| remoteStorageDeviceId | string | Storage device ID of the remote storage system If you specify NotSpecified for remoteStorageDeviceId, NotSpecified is output. |
| copyGroupName | string | Copy group name |
| localDeviceGroupName | string | Device group name in the local storage system |
| remoteDeviceGroupName | string | Device group name in the remote storage system If you specify NotSpecified for remoteStorageDeviceId, NotSpecified is output. |
| muNumber | int | MU (mirror unit) number |

| Attribute | Type | Description |
|-------------------------|--------|---|
| | | If the MU number cannot be obtained, information is not output. |
| remoteMirrorCopyGroupId | string | Object ID of the remote copy group The following attributes are output, separated by commas: <ul style="list-style-type: none"> ▪ remoteStorageDeviceId ▪ copyGroupName ▪ localDeviceGroupName ▪ remoteDeviceGroupName |

If you run the request with `pair` specified for the query parameter `detailInfoType`, you can get the following information, in addition to information about remote copy groups:

| Attribute | Type | Description |
|-----------|----------|--|
| copyPairs | object[] | Detailed information about the remote copy pair is output. |

| Attribute | Type | Description |
|-----------|------|---|
| | | If information cannot be acquired, the attributes under the <code>copyPairs</code> object are not output. |

| Attribute | Type | Description |
|-----------|------|---|
| | | <ul style="list-style-type: none"> ▪ copyGroupName (string) Copy group name ▪ copyPairName (string) Copy pair name ▪ replicationType (string) Pair type <ul style="list-style-type: none"> • TC: TrueCopy • UR: Universal Replicator • GAD: global-active device <p>If the pair status is <code>SMPL</code>, information is not output.</p> ▪ pvolDevId (int) LDEV number of P-VOL ▪ svolDevId (int) LDEV number of S-VOL ▪ fenceLevel (string) Fence level <ul style="list-style-type: none"> ▪ DATA: S-VOL data ▪ STATUS: S-VOL status ▪ NEVER: None ▪ ASYNC: Asynchronous <p>If the fence level cannot be obtained, information is not output.</p> ▪ pvolJournalId (int) Journal ID of the P-VOL A value from 0 to 255 is output only in the case of Universal Replicator. This information is not output if the pair type cannot be obtained. ▪ svolJournalId (int) Journal ID of the S-VOL A value from 0 to 255 is output only in the case of Universal Replicator. This information |

| Attribute | Type | Description |
|-----------|------|--|
| | | <p>is not output if the pair type cannot be obtained.</p> <ul style="list-style-type: none"> <li data-bbox="829 338 1424 541"> <p>▪ quorumDiskId (int)</p> <p>ID of the Quorum disk</p> <p>A value from 0 to 31 is output only in the case of global-active device. This information is not output if the pair type cannot be obtained.</p> <li data-bbox="829 558 1424 995"> <p>▪ pvolStatus (string)</p> <p>Pair status of the P-VOL</p> <p>For details, see the section explaining on pair status (TrueCopy and Universal Replicator) or pair status (global-active device).</p> <p>If the pair status cannot be obtained, information is not output.</p> <p>In the case of Universal Replicator, if the transition status of the Universal Replicator pair is <i>Suspending</i> or <i>Deleting</i>, information is not output.</p> <li data-bbox="829 1012 1424 1449"> <p>▪ svolStatus (string)</p> <p>Pair status of the S-VOL</p> <p>For details, see the section explaining on pair status (TrueCopy and Universal Replicator) or pair status (global-active device).</p> <p>If the pair status cannot be obtained, information is not output.</p> <p>In the case of Universal Replicator, if the transition status of the Universal Replicator pair is <i>Suspending</i> or <i>Deleting</i>, information is not output.</p> <li data-bbox="829 1465 1424 1640"> <p>▪ consistencyGroupId (int)</p> <p>Consistency group ID</p> <p>If no consistency group consists, information is not output.</p> <li data-bbox="829 1656 1424 1843"> <p>▪ pvolIOMode (string)</p> <p>I/O mode of the P-VOL</p> <ul style="list-style-type: none"> <li data-bbox="867 1766 1097 1793">▪ L/M: Mirror (RL) <li data-bbox="867 1810 1032 1837">▪ L/L: Local |

| Attribute | Type | Description |
|-----------|------|--|
| | | <ul style="list-style-type: none"> ▪ B/B: Block <p>Information is output only in the case of global-active device. If the pair status is <code>SMPL</code>, information is not output.</p> <ul style="list-style-type: none"> ▪ <code>svollOMode</code> (string) <p>I/O mode of the S-VOL</p> <ul style="list-style-type: none"> ▪ L/M: Mirror (RL) ▪ L/L: Local ▪ B/B: Block <p>Information is output only in the case of global-active device. If the pair status is <code>SMPL</code>, information is not output.</p> <ul style="list-style-type: none"> ▪ <code>pvolStorageDeviceId</code> (string) <p>Storage device ID of the storage system on the P-VOL</p> <ul style="list-style-type: none"> ▪ <code>svolStorageDeviceId</code> (string) <p>Storage device ID of the storage system on the S-VOL</p> <ul style="list-style-type: none"> ▪ <code>remoteMirrorCopyPairId</code> (string) <p>Object ID of the remote copy pair</p> <p>The following attributes are output, separated by commas:</p> <ul style="list-style-type: none"> ▪ <code>remoteStorageDeviceId</code> ▪ <code>copyGroupName</code> ▪ <code>localDeviceGroupName</code> ▪ <code>remoteDeviceGroupName</code> ▪ <code>copyPairName</code> <ul style="list-style-type: none"> ▪ <code>transitionStatus</code> (string) <p>The transition status of a pair is output for a Universal Replicator pair.</p> <ul style="list-style-type: none"> • <code>None</code>: The pair is not in transition. • <code>Suspending</code>: The pair is being split. • <code>Deleting</code>: The pair is being deleted. |

| Attribute | Type | Description |
|-----------|------|--|
| | | <p>This is not output if the copy pair is not a Universal Replicator pair.</p> <ul style="list-style-type: none"> ▪ copyPace (int) Copy speed This is not output if copy pair is Universal Replicator. ▪ pathGroupId (int) ID of the RCU path group This is not output if CU is specified for the remote path connection setting. This is not output if the pair status of the P-VOL or the S-VOL is <i>SMPL</i>. ▪ deltaStatus (string) Status of the 3DC multi-target configuration that uses delta resync This is output if the pair type is Universal Replicator and the 3DC multi-target configuration that uses delta resync is used. <ul style="list-style-type: none"> • HOLD: Universal Replicator delta resync pair (normal) • HLDE: Universal Replicator delta resync pair (failed) • HOLDING: In the process of being changed to a Universal Replicator delta resync pair |

Status codes

For details on the status codes of the request for this operation, see the description on HTTP status codes.

Coding example

```
curl -v -H "Accept: application/json" -H "Remote-Authorization:Session
10399a1ffce3489b9c3a823017462396" -H "Authorization:Session
d7b673af189048468c5af9bcf3bbbbb6f" -X GET https://192.0.2.100/
ConfigurationManager/v1/objects/remote-mirror-copygroups?
remoteStorageDeviceId=886000123789
```

Getting information about a specific remote copy group

The following request gets information about the specified copy group. This request also gets information about the pairs (TrueCopy, Universal Replicator, or global-active device) included in the copy group. If the copy group name or copy pair name contains single-byte spaces, pair information cannot be obtained.

Execution permission

Storage Administrator (View Only)

Request line

```
GET base-URL/v1/objects/remote-mirror-copygroups/object-ID
```

Request message

Object ID

Specify the value of `remoteMirrorCopyGroupId` that was obtained by the processing to get information about the remote copy group. You can also specify the attributes and connect them with commas as follows:

```
remoteStorageDeviceId, copyGroupName, localDeviceGroupName,  
remoteDeviceGroupName
```

| Attribute | Type | Description |
|-----------------------|--------|--|
| remoteStorageDeviceId | string | (Required) Storage device ID of the remote storage system# Specify a decimal (base 10) number equal to or greater than 0. |
| copyGroupName | string | (Required) Copy group name Specify a character string consisting of 1 to 31 characters. The name is case sensitive. |
| localDeviceGroupName | string | (Required) Device group name in the local storage system Specify a character string consisting of 1 to 31 characters. The name is case sensitive. |
| remoteDeviceGroupName | string | (Required) Device group name in the remote storage system# Specify a character string consisting of 1 to 31 characters. The name is case sensitive. |

#: If you specify `NotSpecified` in cases such as when a failure occurs in a remote storage system, only information about the local storage system can be acquired. If you specify `NotSpecified`, copy pair information about attributes of volumes that belong to the remote storage system will not be output. In this case, you do not need to specify the `Remote-Authorization` header.

Query parameters

| Parameter | Type | Description |
|-----------------------------|--------|--|
| <code>detailInfoType</code> | string | <p>(Optional) Type of detailed information to be obtained</p> <ul style="list-style-type: none"> <code>class</code> <p>Adds additional information# from the storage system's cache.</p> <p>You can specify this item for VSP 5000 series.</p> <p>To get up-to-date information, you must run the API request that refreshes the storage system's cache before running this request. For details, see "Updating the cache of storage system configuration information".</p> |

#: If the remote storage system is a VSP E series, VSP G350, G370, G700, G900 or VSP F350, F370, F700, F900 model storage system, you might not be able to get some of the information about the remote storage system.

For other storage systems, if the remote storage system's microcode version meets the following conditions, you might not be able to get some of the information about the remote storage system.

- For a VSP 5000 series storage system:
The microcode version is earlier than 90-01-42-XX/XX.
- For a VSP G1000, VSP G1500, VSP F1500 model storage system:
The microcode version is earlier than 80-06-71-XX/XX.

Body

None.

Response message**Body**

The following is an example of the output when information about TrueCopy pairs is obtained:

```
{
  "remoteMirrorCopyGroupId" : "886000123789,remoteCopyGroup1,
remoteCopyGroup1P_,remoteCopyGroup1S_",
  "copyGroupName" : "remoteCopyGroup1",
  "copyPairs" : [ {
    "copyGroupName" : "remoteCopyGroup1",
    "copyPairName" : "pair1",
    "replicationType" : "TC",
    "remoteMirrorCopyPairId" : "886000123789,remoteCopyGroup1,
remoteCopyGroup1P_,remoteCopyGroup1S_,pair1",
    "pvolLdevId" : 2108,
    "svolLdevId" : 1581,
    "fenceLevel" : "DATA",
    "pvolStatus" : "PAIR",
    "svolStatus" : "PAIR",
    "consistencyGroupId": 5,
    "pvolStorageDeviceId" : "886000123456",
    "svolStorageDeviceId" : "886000123789",
    "pvolDifferenceDataManagement": "S",
    "svolDifferenceDataManagement": "S",
    "pvolProcessingStatus": "N",
    "svolProcessingStatus": "N"
  }, {
    "copyGroupName" : "remoteCopyGroup1",
    "copyPairName" : "pair2",
    "replicationType" : "TC",
    "remoteMirrorCopyPairId" : "886000123789,remoteCopyGroup1,
remoteCopyGroup1P_,remoteCopyGroup1S_,pair2",
    "pvolLdevId" : 2109,
    "svolLdevId" : 1582,
    "fenceLevel" : "DATA",
    "pvolStatus" : "PSUS",
    "svolStatus" : "SMPL",
    "consistencyGroupId": 5,
    "pvolStorageDeviceId" : "886000123456",
    "svolStorageDeviceId" : "886000123789",
    "pvolDifferenceDataManagement": "S",
    "svolDifferenceDataManagement": "S",
    "pvolProcessingStatus": "N",
    "svolProcessingStatus": "N"
  } ],
  "remoteStorageDeviceId" : "886000123789",
  "localDeviceGroupName" : "remoteCopyGroup1P_",
}
```

```

"remoteDeviceGroupName" : "remoteCopyGroup1S_"
}

```

The following is an example of the output when information about Universal Replicator pairs is obtained:

```

{
  "remoteMirrorCopyGroupId" : "886000123789,remoteCopyGroup2,
remoteCopyGroup2P_,remoteCopyGroup2S_",
  "copyGroupName" : "remoteCopyGroup2",
  "copyPairs" : [ {
    "copyGroupName" : "remoteCopyGroup2",
    "copyPairName" : "pair1",
    "replicationType" : "UR",
    "remoteMirrorCopyPairId" : "886000123789,remoteCopyGroup2,
remoteCopyGroup2P_,remoteCopyGroup2S_,pair1",
    "consistencyGroupId" : 10,
    "pvolLdevId" : 1569,
    "pvolJournalId" : 13,
    "svolLdevId" : 2835,
    "svolJournalId" : 36,
    "fenceLevel" : "ASYNC",
    "pvolStatus" : "PAIR",
    "svolStatus" : "PAIR",
    "pvolStorageDeviceId" : "886000123456",
    "svolStorageDeviceId" : "886000123789",
    "pvolDifferenceDataManagement" : "S",
    "svolDifferenceDataManagement" : "S",
    "pvolProcessingStatus" : "N",
    "svolProcessingStatus" : "N"
  } ],
  "remoteStorageDeviceId" : "886000123789",
  "localDeviceGroupName" : "remoteCopyGroup2P_",
  "remoteDeviceGroupName" : "remoteCopyGroup2S_"
}

```

The following is an example of the output when information about global-active device pairs is obtained:

```

{
  "remoteMirrorCopyGroupId" : "886000123789,remoteCopyGroup3,
remoteCopyGroup3P_,remoteCopyGroup3S_",
  "copyGroupName" : "remoteCopyGroup3",
  "copyPairs" : [ {
    "copyGroupName" : "remoteCopyGroup3",
    "copyPairName" : "pair1",
    "replicationType" : "GAD",
    "remoteMirrorCopyPairId" : "886000123789,remoteCopyGroup3,
remoteCopyGroup3P_,remoteCopyGroup3S_,pair1",

```

```

"quorumDiskId" : 14,
"pvolLdevId" : 1580,
"svolLdevId" : 2128,
"fenceLevel" : "NEVER",
"pvolStatus" : "PAIR",
"svolStatus" : "PAIR",
"pvolIOMode" : "L/M",
"svolIOMode" : "L/M",
"pvolStorageDeviceId" : "886000123456",
"svolStorageDeviceId" : "886000123789",
"pvolDifferenceDataManagement": "S",
"svolDifferenceDataManagement": "S",
"pvolProcessingStatus": "N",
"svolProcessingStatus": "N"
} ],
"remoteStorageDeviceId" : "886000123789",
"localDeviceGroupName" : "remoteCopyGroup3P_",
"remoteDeviceGroupName" : "remoteCopyGroup3S_"
}

```

| Attribute | Type | Description |
|--------------------------|--------|---|
| remoteStorageDeviceId | string | Storage device ID of the remote storage system If you specify a value that includes <code>NotSpecified</code> for the object ID, <code>NotSpecified</code> is output. |
| copyGroupName | string | Copy group name |
| localDeviceGroupName | string | Device group name in the local storage system |
| remoteDeviceGroupName | string | Device group name in the remote storage system If you specify a value that includes <code>NotSpecified</code> for the object ID, <code>NotSpecified</code> is output. |
| remoteMirrorCopyGroupPld | string | Object ID of the remote copy group The following attributes are output, separated by commas: <ul style="list-style-type: none"> ▪ remoteStorageDeviceId ▪ copyGroupName ▪ localDeviceGroupName ▪ remoteDeviceGroupName |

| Attribute | Type | Description |
|-----------|----------|---|
| copyPairs | object[] | The detailed information about the copy pair is output. |

| Attribute | Type | Description |
|-----------|------|---|
| | | <ul style="list-style-type: none"> ▪ copyGroupName (string) Copy group name ▪ copyPairName (string) Copy pair name ▪ replicationType (string) Pair type <ul style="list-style-type: none"> ▪ TC: TrueCopy ▪ UR: Universal Replicator ▪ GAD: global-active device <p>If the pair status is <code>SMPL</code>, information is not output.</p> ▪ pvolLdevId (int) LDEV number of P-VOL If you specify a value that includes <code>NotSpecified</code> for the object ID, this attribute is output only if the P-VOL is a volume in the local storage system. ▪ svolLdevId (int) LDEV number of S-VOL If you specify a value that includes <code>NotSpecified</code> for the object ID, this attribute is output only if the S-VOL is a volume in the local storage system. ▪ fenceLevel (string) Fence level <ul style="list-style-type: none"> ▪ DATA: S-VOL data ▪ STATUS: S-VOL status ▪ NEVER: None ▪ ASYNC: Asynchronous <p>If the fence level cannot be obtained, information is not output.</p> ▪ pvolJournalId (int) Journal ID of the P-VOL |

| Attribute | Type | Description |
|-----------|------|--|
| | | <p>A value from 0 to 255 is output only in the case of Universal Replicator. If the pair status is <code>SMPL</code>, information is not output.</p> <p>If you specify a value that includes <code>NotSpecified</code> for the object ID, this attribute is output only if the P-VOL is a volume in the local storage system.</p> <ul style="list-style-type: none"> ▪ <code>svolJournalId</code> (int) Journal ID of the S-VOL <p>A value from 0 to 255 is output only in the case of Universal Replicator. If the pair status is <code>SMPL</code>, information is not output.</p> <p>If you specify a value that includes <code>NotSpecified</code> for the object ID, this attribute is output only if the S-VOL is a volume in the local storage system.</p> <ul style="list-style-type: none"> ▪ <code>quorumDiskId</code> (int) ID of the Quorum disk <p>A value from 0 to 31 is output only in the case of global-active device. If the pair status is <code>SMPL</code>, information is not output.</p> <ul style="list-style-type: none"> ▪ <code>pvolStatus</code> (string) Pair status of the P-VOL <p>For details, see the section explaining on pair status (TrueCopy and Universal Replicator) or pair status (global-active device).</p> <p>If the pair status cannot be obtained, information is not output.</p> <p>If you specify a value that includes <code>NotSpecified</code> for the object ID, this attribute is output only if the P-VOL is a volume in the local storage system.</p> <ul style="list-style-type: none"> ▪ <code>svolStatus</code> (string) Pair status of the S-VOL <p>For details, see the section explaining on pair status (TrueCopy and Universal Replicator) or pair status (global-active device).</p> |

| Attribute | Type | Description |
|-----------|------|---|
| | | <p>If the pair status cannot be obtained, information is not output.</p> <p>If you specify a value that includes <code>NotSpecified</code> for the object ID, this attribute is output only if the S-VOL is a volume in the local storage system.</p> <ul style="list-style-type: none"> ▪ consistencyGroupId (int) Consistency group ID <p>If no consistency group consists, information is not output.</p> <ul style="list-style-type: none"> ▪ pvollOMode (string) I/O mode of the P-VOL <ul style="list-style-type: none"> ▪ L/M: Mirror (RL) ▪ L/L: Local ▪ B/B: Block <p>Information is output only in the case of global-active device. If the pair status is <code>SMPL</code>, information is not output.</p> <p>If you specify a value that includes <code>NotSpecified</code> for the object ID, this attribute is output only if the P-VOL is a volume in the local storage system.</p> <ul style="list-style-type: none"> ▪ svollOMode (string) I/O mode of the S-VOL <ul style="list-style-type: none"> ▪ L/M: Mirror (RL) ▪ L/L: Local ▪ B/B: Block <p>Information is output only in the case of global-active device. If the pair status is <code>SMPL</code>, information is not output.</p> <p>If you specify a value that includes <code>NotSpecified</code> for the object ID, this attribute is output only if the S-VOL is a volume in the local storage system.</p> <ul style="list-style-type: none"> ▪ pvolStorageDeviceId (string) Storage device ID of the storage system on the P-VOL |

| Attribute | Type | Description |
|-----------|------|--|
| | | <p>If you specify a value that includes <code>NotSpecified</code> for the object ID, this attribute is output only if the P-VOL is a volume in the local storage system.</p> <ul style="list-style-type: none"> ▪ <code>svolStorageDeviceId</code> (string) Storage device ID of the storage system on the S-VOL <p>If you specify a value that includes <code>NotSpecified</code> for the object ID, this attribute is output only if the S-VOL is a volume in the local storage system.</p> <ul style="list-style-type: none"> ▪ <code>copyProgressRate</code> (int) Copy progress rate Information is output only when the pair status of the P-VOL is <code>COPY</code> (a pair is being created or resynchronized). This attribute is not output if you specify a value that includes <code>NotSpecified</code> for the object ID. ▪ <code>remoteMirrorCopyPairId</code> (string) Object ID of the remote copy pair# The following attributes are output, separated by commas: <ul style="list-style-type: none"> ▪ <code>remoteStorageDeviceId</code> ▪ <code>copyGroupName</code> ▪ <code>localDeviceGroupName</code> ▪ <code>remoteDeviceGroupName</code> ▪ <code>copyPairName</code> ▪ <code>pvolDifferenceDataManagement</code> (string) Method for managing difference data about the P-VOL <ul style="list-style-type: none"> • <code>S</code>: Difference data based on the shared memory • <code>D</code>: Hierarchical difference data (difference data based on drives) ▪ <code>svolDifferenceDataManagement</code> (string) |

| Attribute | Type | Description |
|-----------|------|--|
| | | <p>Method for managing difference data about the S-VOL</p> <ul style="list-style-type: none"> • S: Difference data based on the shared memory • D: Hierarchical difference data (difference data based on drives) <ul style="list-style-type: none"> ▪ pvolProcessingStatus (string) Processing status of the pair of P-VOLs <ul style="list-style-type: none"> • E: Processing to expand the P-VOLs is being performed • N: Processing to expand the P-VOLs is not being performed ▪ svolProcessingStatus (string) Processing status of the pair of S-VOLs <ul style="list-style-type: none"> • E: Processing to expand the S-VOLs is being performed • N: Processing to expand the S-VOLs is not being performed |

#: We recommend that you save the object ID information you obtain in case a failure occurs. When you need to perform a takeover to recover the system, you can use the saved information to identify the pair that you need to work on, even if you cannot get information about the failed storage system.

If you run this request with `class` specified for `detailInfoType` in the query parameters, additional information from the storage system's cache is also obtained.

| Attribute | Type | Description |
|------------|----------|---|
| copy Pairs | object[] | <p>Attributes related to the detailed information about the copy pair</p> <ul style="list-style-type: none"> ▪ transitionStatus (string) The transition status of a pair is output for a Universal Replicator pair. <ul style="list-style-type: none"> • <code>None</code>: The pair is not in transition. • <code>Suspending</code>: The pair is being split. • <code>Deleting</code>: The pair is being deleted. <p>This is not output if the copy pair is not a Universal Replicator pair.</p> ▪ copyPace (int) Copy speed This is not output for a Universal Replicator pair. |

| Attribute | Type | Description |
|-----------|------|--|
| | | <ul style="list-style-type: none"> <li data-bbox="823 289 1417 604"> <p>▪ pathGroupId (int)</p> <p>ID of the RCU path group</p> <p>This is not output if CU is specified for the remote path connection setting.</p> <p>This is not output if the pair volume status of the P-VOL or S-VOL (the value of the <code>pvolStatus</code> attribute of the <code>svolStatus</code> attribute) is <code>SMPL</code>.</p> <li data-bbox="823 646 1417 1283"> <p>▪ deltaStatus (string)</p> <p>Status of the 3DC multi-target configuration that uses delta resync</p> <p>This is output if the value of <code>replicationType</code> for the <code>copyPairs</code> attribute of the <code>replicationType</code> attribute, which is the pair type for the detailed information about the remote copy pairs, is Universal Replicator, and if you are using a 3DC multi-target configuration that uses delta resync.</p> <ul style="list-style-type: none"> <li data-bbox="862 1045 1372 1108">• <code>HOLD</code>: Universal Replicator delta resync pair (normal) <li data-bbox="862 1129 1372 1192">• <code>HLDE</code>: Universal Replicator delta resync pair (failed) <li data-bbox="862 1213 1411 1276">• <code>HOLDING</code>: In the process of being changed to a Universal Replicator delta resync pair |

Status codes

For details on the status codes of the request for this operation, see the description on HTTP status codes.

Coding example

For TrueCopy:

```
curl -v -H "Accept: application/json" -H "Remote-Authorization:Session
10399a1ffce3489b9c3a823017462396" -H "Authorization:Session
d7b673af189048468c5af9bcf3bbbb6f" -X GET https://192.0.2.100/
ConfigurationManager/v1/objects/remote-mirror-copygroups/886000123789,
remoteCopyGroup1,remoteCopyGroup1P_,remoteCopyGroup1S_
```

For Universal Replicator:

```
curl -v -H "Accept: application/json" -H "Remote-Authorization:Session
10399a1ffce3489b9c3a823017462396" -H "Authorization:Session
d7b673af189048468c5af9bcf3b666f" -X GET https://192.0.2.100/
ConfigurationManager/v1/objects/remote-mirror-copygroups/886000123789,
remoteCopyGroup2,remoteCopyGroup2P_,remoteCopyGroup2S_
```

For global-active device:

```
curl -v -H "Accept: application/json" -H "Remote-Authorization:Session
10399a1ffce3489b9c3a823017462396" -H "Authorization:Session
d7b673af189048468c5af9bcf3b666f" -X GET https://192.0.2.100/
ConfigurationManager/v1/objects/remote-mirror-copygroups/886000123789,
remoteCopyGroup3,remoteCopyGroup3P_,remoteCopyGroup3S_
```

Getting information about global-active device pairs

The following request acquires a list of volume information and storage system information about the P-VOLs and S-VOLs that make up a global-active device pair. You can get information about a pair without specifying information about the remote storage system in the request message.



Important:

For a VSP E series, VSP G350, G370, G700, G900, VSP F350, F370, F700, F900 storage system, pay attention to the number of concurrent executions of this API request. For details, see "Implementing retry processing".

Execution permission

Administrator user group (built-in user group)

Request line

```
GET base-URL/v1/objects/remote-coppairs
```

Request message

Object ID

None.

Query parameters

| Parameter | Type | Filter Condition |
|-----------------|--------|---|
| replicationType | string | (Required) Specify the pair type. GAD: global-active device |
| startLdevId | int | (Optional) Specify, as a decimal (base 10) number, the number of the first LDEV for which you want to acquire information about the pair. Specify a value in the range from 0 to 65279. If you specify this attribute, be sure to also specify the endLdevId attribute. The value of this attribute must be equal to or less than the value of endLdevId. If this attribute is omitted, 0 is set. |
| endLdevId | int | (Optional) Specify, as a decimal (base 10) number, the number of the last LDEV for which you want to acquire information about the pair. Specify a value in the range from 0 to 65279. If you specify this attribute, be sure to also specify the startLdevId attribute. The value of this attribute must be equal to or greater than the value of startLdevId. Specify these values so that the range indicated by the startLdevId and endLdevId attributes consists of no more than 2048 LDEVs. If this attribute is omitted, 2047 will be set. |

Body

None.

Response message

Body

```
{
  "data" : [ {
    "replicationType" : "GAD",
    "ldevId" : 8,
    "remoteSerialNumber" : "415008",
    "remoteStorageTypeId" : "M8",
    "remoteLdevId" : 22,
    "primaryOrSecondary" : "P-VOL",
```

```

    "muNumber" : 0,
    "status" : "PSUE",
    "isSSWS" : false,
    "createdLocalTime" : "2017-09-29T16:26:07",
    "quorumDiskId" : 1,
    "suspendedMode" : "BLOCK"
  }, {
    "replicationType" : "GAD",
    "ldevId" : 9,
    "remoteSerialNumber" : "415008",
    "remoteStorageTypeId" : "M8",
    "remoteLdevId" : 23,
    "primaryOrSecondary" : "P-VOL",
    "muNumber" : 2,
    "status" : "PSUS",
    "isSSWS" : false,
    "createdLocalTime" : "2017-10-02T09:46:36",
    "quorumDiskId" : 1,
    "suspendedMode" : "BLOCK"
  }, {
    "replicationType" : "GAD",
    "ldevId" : 73,
    "remoteSerialNumber" : "415008",
    "remoteStorageTypeId" : "M8",
    "remoteLdevId" : 2171,
    "primaryOrSecondary" : "P-VOL",
    "muNumber" : 0,
    "status" : "PAIR",
    "isSSWS" : false,
    "createdLocalTime" : "2018-11-04T01:12:39",
    "quorumDiskId" : 1,
    "suspendedMode" : "BLOCK"
  }, {
    "replicationType" : "GAD",
    "ldevId" : 93,
    "remoteSerialNumber" : "415008",
    "remoteStorageTypeId" : "M8",
    "remoteLdevId" : 25,
    "primaryOrSecondary" : "P-VOL",
    "muNumber" : 0,
    "status" : "PSUE",
    "isSSWS" : false,
    "createdLocalTime" : "2017-10-27T17:42:33",
    "quorumDiskId" : 1,
    "suspendedMode" : "BLOCK"
  }, {
    "replicationType" : "GAD",
    "ldevId" : 99,
    "remoteSerialNumber" : "415008",

```



```

"remoteStorageTypeId" : "M8",
"remoteLdevId" : 2163,
"primaryOrSecondary" : "P-VOL",
"muNumber" : 0,
"status" : "PAIR",
"isSSWS" : false,
"createdLocalTime" : "2018-03-11T03:10:22",
"quorumDiskId" : 1,
"suspendedMode" : "BLOCK"
} ]
}

```

| Attribute | Type | Description |
|---------------------|--------|--|
| replicationType | string | Pair type GAD: global-active device |
| ldevId | int | LDEV number of the volume on the local storage system. |
| remoteSerialNumber | string | Serial number of the remote storage system |
| remoteStorageTypeId | string | ID corresponding to the model of the remote storage system <ul style="list-style-type: none"> ▪ R8: VSP G1000, VSP G1500, or VSP F1500 ▪ R9: VSP 5000 series ▪ M8: VSP E series, VSP Gx00 models or VSP Fx00 models |
| remoteLdevId | int | LDEV number of the volume on the remote storage system |
| primaryOrSecondary | string | Attribute of the volume on the local storage system <ul style="list-style-type: none"> ▪ P-VOL ▪ S-VOL |
| muNumber | int | MU number |
| status | string | Pair status of the volume on the local storage system For details, see the section about pair status transition (global-active device). |

| Attribute | Type | Description |
|------------------|---------|--|
| isSSWS | boolean | Indicates whether the state of the volume on the local storage system is SSWS. <ul style="list-style-type: none"> ▪ true: The state of the volume is SSWS. ▪ false: The state of the volume is not SSWS. |
| createdLocalTime | string | Time at which the pair was created. The local time of the storage system is displayed in YYYY-MM-DDThh:mm:ss format. |
| quorumDiskId | int | Quorum disk ID |
| suspendedMode | string | Block or Remote instructions when a pair is suspended <ul style="list-style-type: none"> ▪ BLOCK_IO: Block with I/O check ▪ BLOCK: Block without I/O check ▪ REMOTE: Remote |

Status codes

For details on the status codes for the request that performs this operation, see the description of HTTP status codes.

Coding example

```
curl -v -H "Accept:application/json" -H "Content-Type:application/json" -H "Authorization:Session d7b673af189048468c5af9bcf3b66b6f" -X GET https://192.0.2.100/ConfigurationManager/v1/objects/remote-copypairs?replicationType=GAD
```

Getting information about a specific remote copy pair

The following request gets information about the specified copy pair (TrueCopy, Universal Replicator, or global-active device). Use this information to get the information that is necessary for performing pair operations (for example, the pair status). If the copy group name or copy pair name contains single-byte spaces, pair information cannot be obtained.

Execution permission

Storage Administrator (View Only)

Request line

```
GET base-URL/v1/objects/remote-mirror-copypairs/object-ID
```

Request message**Object ID**

Specify the value of `remoteMirrorCopyPairId` that was obtained by the processing to get information about the remote copy group. You can also specify the attributes and connect them with commas as follows:

```
remoteStorageDeviceId, copyGroupName, localDeviceGroupName,  
remoteDeviceGroupName, copyPairName
```

| Attribute | Type | Description |
|-----------------------|--------|---|
| remoteStorageDeviceId | string | (Required) Storage device ID of the remote storage system # Specify a decimal (base 10) number equal to or greater than 0. |
| copyGroupName | string | (Required) Copy group name Specify a character string consisting of 1 to 31 characters. The name is case sensitive. |
| localDeviceGroupName | string | (Required) Device group name in the local storage system Specify a character string consisting of 1 to 31 characters. The name is case sensitive. |
| remoteDeviceGroupName | string | (Required) Device group name in the remote storage system # Specify a character string consisting of 1 to 31 characters. The name is case sensitive. |
| copyPairName | string | (Required) Copy pair name Specify a name consisting of 1 to 31 characters. The name is case sensitive. |

#: If you specify `NotSpecified` in cases such as when a failure occurs in a remote storage system, only information about the local storage system can be acquired. If you specify `NotSpecified`, copy pair information about attributes of volumes that belong to the remote storage system will not be output. In this case, you do not need to specify the `Remote-Authorization` header.

Query parameters

None.

Body

None.

Response message**Body**

The following is an example of the output when information about TrueCopy pairs is obtained:

```
{
  "copyGroupName" : "remoteCopyGroup1",
  "copyPairName" : "pair1",
  "replicationType" : "TC",
  "remoteMirrorCopyPairId" : "886000123789,remoteCopyGroup1,
remoteCopyGroup1P_,remoteCopyGroup1S_,pair1",
  "pvolLdevId" : 2108,
  "svolLdevId" : 1581,
  "fenceLevel" : "DATA",
  "pvolStatus" : "PAIR",
  "svolStatus" : "PAIR",
  "pvolStorageDeviceId" : "886000123456",
  "svolStorageDeviceId" : "886000123789",
  "pvolDifferenceDataManagement" : "S",
  "svolDifferenceDataManagement" : "S",
  "pvolProcessingStatus" : "N",
  "svolProcessingStatus" : "N"
}
```

The following is an example of the output when information about Universal Replicator pairs is obtained:

```
{
  "copyGroupName" : "remoteCopyGroup2",
  "copyPairName" : "pair1",
  "replicationType" : "UR",
  "remoteMirrorCopyPairId" : "886000123789,remoteCopyGroup2,
remoteCopyGroup2P_,remoteCopyGroup2S_,pair1",
  "consistencyGroupId" : 10,
  "pvolLdevId" : 1569,
  "pvolJournalId" : 13,
  "svolLdevId" : 2835,
  "svolJournalId" : 36,
  "fenceLevel" : "ASYNC",
  "pvolStatus" : "PAIR",
  "svolStatus" : "PAIR",
}
```

```

"pvolStorageDeviceId" : "886000123456",
"svolStorageDeviceId" : "886000123789",
"pvolDifferenceDataManagement": "S",
"svolDifferenceDataManagement": "S",
"pvolProcessingStatus": "N",
"svolProcessingStatus": "N"
}

```

The following is an example of the output when information about global-active device pairs is obtained:

```

{
  "copyGroupName" : "remoteCopyGroup3",
  "copyPairName" : "pair1",
  "replicationType" : "GAD",
  "remoteMirrorCopyPairId" : "886000123789,remoteCopyGroup3,
remoteCopyGroup3P_,remoteCopyGroup3S_,pair1",
  "quorumDiskId" : 14,
  "pvolLdevId" : 1580,
  "svolLdevId" : 2128,
  "fenceLevel" : "NEVER",
  "pvolStatus" : "PAIR",
  "svolStatus" : "PAIR",
  "pvolIOMode" : "L/M",
  "svolIOMode" : "L/M",
  "pvolStorageDeviceId" : "886000123456",
  "svolStorageDeviceId" : "886000123789",
  "pvolDifferenceDataManagement": "S",
  "svolDifferenceDataManagement": "S",
  "pvolProcessingStatus": "N",
  "svolProcessingStatus": "N"
}

```

| Attribute | Type | Description |
|-----------------|--------|--|
| copyGroupName | string | Copy group name |
| copyPairName | string | Copy pair name |
| replicationType | string | Pair type <ul style="list-style-type: none"> ▪ TC: TrueCopy ▪ UR: Universal Replicator ▪ GAD: global-active device If the pair status is <code>SMPL</code> , information is not output. |
| pvolLdevId | int | LDEV number of P-VOL |

| Attribute | Type | Description |
|----------------------------|--------|--|
| | | If you specify a value that includes <code>NotSpecified</code> for the object ID, this attribute is output only if the P-VOL is a volume in the local storage system. |
| <code>svolDevId</code> | int | LDEV number of S-VOL If you specify a value that includes <code>NotSpecified</code> for the object ID, this attribute is output only if the S-VOL is a volume in the local storage system. |
| <code>fenceLevel</code> | string | Fence level <ul style="list-style-type: none"> ▪ DATA: S-VOL data ▪ STATUS: S-VOL status ▪ NEVER: None ▪ ASYNC: Asynchronous If the fence level cannot be obtained, information is not output. |
| <code>pvolJournalId</code> | int | Journal ID of the P-VOL A value from 0 to 255 is output only in the case of UR. If the pair status is <code>SMPL</code> , information is not output. If you specify a value that includes <code>NotSpecified</code> for the object ID, this attribute is output only if the P-VOL is a volume in the local storage system. |
| <code>svolJournalId</code> | int | Journal ID of the S-VOL A value from 0 to 255 is output only in the case of UR. If the pair status is <code>SMPL</code> , information is not output. If you specify a value that includes <code>NotSpecified</code> for the object ID, this attribute is output only if the S-VOL is a volume in the local storage system. |
| <code>quorumDiskId</code> | int | ID of the Quorum disk A value from 0 to 31 is output only in the case of global-active device. If the pair status is <code>SMPL</code> , information is not output. |
| <code>pvolStatus</code> | string | Pair status of the P-VOL For details, see the section explaining on pair status (TrueCopy and Universal Replicator) or pair status (global-active device). |

| Attribute | Type | Description |
|--------------------|--------|---|
| | | <p>If the pair status cannot be obtained, information is not output.</p> <p>If you specify a value that includes <code>NotSpecified</code> for the object ID, this attribute is output only if the P-VOL is a volume in the local storage system.</p> |
| svolStatus | string | <p>Pair status of the S-VOL</p> <p>For details, see the section explaining on pair status (TrueCopy and Universal Replicator) or pair status (global-active device).</p> <p>If the pair status cannot be obtained, information is not output.</p> <p>If you specify a value that includes <code>NotSpecified</code> for the object ID, this attribute is output only if the S-VOL is a volume in the local storage system.</p> |
| consistencyGroupld | int | <p>Consistency group ID</p> <p>If no consistency group consists, information is not output.</p> |
| pvollIOMode | string | <p>I/O mode of the P-VOL</p> <ul style="list-style-type: none"> ▪ L/M: Mirror (RL) ▪ L/L: Local ▪ B/B: Block <p>Information is output only in the case of global-active device. If the pair status is <code>SMPL</code>, information is not output.</p> <p>If you specify a value that includes <code>NotSpecified</code> for the object ID, this attribute is output only if the P-VOL is a volume in the local storage system.</p> |
| svollIOMode | string | <p>I/O mode of the S-VOL</p> <ul style="list-style-type: none"> ▪ L/M: Mirror (RL) ▪ L/L: Local ▪ B/B: Block <p>Information is output only in the case of global-active device. If the pair status is <code>SMPL</code>, information is not output.</p> |

| Attribute | Type | Description |
|---|--------|--|
| | | If you specify a value that includes <code>NotSpecified</code> for the object ID, this attribute is output only if the S-VOL is a volume in the local storage system. |
| <code>pvolStorageDeviceId</code> | string | Storage device ID of the storage system on the P-VOL If you specify a value that includes <code>NotSpecified</code> for the object ID, this attribute is output only if the P-VOL is a volume in the local storage system. |
| <code>svolStorageDeviceId</code> | string | Storage device ID of the storage system on the S-VOL If you specify a value that includes <code>NotSpecified</code> for the object ID, this attribute is output only if the S-VOL is a volume in the local storage system. |
| <code>copyProgressRate</code> | int | Copy progress rate Information is output only when the pair status of the P-VOL is <code>COPY</code> (a pair is being created or resynchronized). This attribute is not output if you specify a value that includes <code>NotSpecified</code> for the object ID. |
| <code>remoteMirrorCopyPairId</code> | string | Object ID of the remote copy pair# The following attributes are output, separated by commas: <ul style="list-style-type: none"> ▪ <code>remoteStorageDeviceId</code> ▪ <code>copyGroupName</code> ▪ <code>localDeviceGroupName</code> ▪ <code>remoteDeviceGroupName</code> ▪ <code>copyPairName</code> |
| <code>pvolDifferenceDataManagement</code> | string | Method for managing difference data about the P-VOL <ul style="list-style-type: none"> ▪ <code>S</code>: Difference data based on the shared memory ▪ <code>D</code>: Hierarchical difference data (difference data based on drives) |

| Attribute | Type | Description |
|-------------------------------|--------|--|
| svolDifferenceData Management | string | Method for managing difference data about the S-VOL <ul style="list-style-type: none"> ▪ S: Difference data based on the shared memory ▪ D: Hierarchical difference data (difference data based on drives) |
| pvolProcessingStatus | string | Processing status of the pair of P-VOLs <ul style="list-style-type: none"> ▪ E: Processing to expand the P-VOLs is being performed ▪ N: Processing to expand the P-VOLs is not being performed |
| svolProcessingStatus | string | Processing status of the pair of S-VOLs <ul style="list-style-type: none"> ▪ E: Processing to expand the S-VOLs is being performed ▪ N: Processing to expand the S-VOLs is not being performed |

#: We recommend that you save the object ID information you obtain in case a failure occurs. When you need to perform a takeover to recover the system, you can use the saved information to identify the pair that you need to work on, even if you cannot get information about the failed storage system.

Status codes

For details on the status codes of the request for this operation, see the description on HTTP status codes.

Coding example

For TrueCopy:

```
curl -v -H "Accept: application/json" -H "Remote-Authorization:Session
10399a1ffce3489b9c3a823017462396" -H "Authorization:Session
d7b673af189048468c5af9bcf3b6bb6f" -X GET https://192.0.2.100/
ConfigurationManager/v1/objects/remote-mirror-copypairs/886000123789,
remoteCopyGroup1,remoteCopyGroup1P_,remoteCopyGroup1S_,pair1
```

For Universal Replicator:

```
curl -v -H "Accept: application/json" -H "Remote-Authorization:Session
10399a1ffce3489b9c3a823017462396" -H "Authorization:Session
d7b673af189048468c5af9bcf3b6bb6f" -X GET https://192.0.2.100/
```

```
ConfigurationManager/v1/objects/remote-mirror-copypairs/886000123789,
remoteCopyGroup2,remoteCopyGroup2P_,remoteCopyGroup2S_,pair1
```

For global-active device:

```
curl -v -H "Accept: application/json" -H "Remote-Authorization:Session
10399a1ffce3489b9c3a823017462396" -H "Authorization:Session
d7b673af189048468c5af9bcf3bbbb6f" -X GET https://192.0.2.100/
ConfigurationManager/v1/objects/remote-mirror-copypairs/886000123789,
remoteCopyGroup3,remoteCopyGroup3P_,remoteCopyGroup3S_,pair1
```

Getting information about all of remote copy pairs

The following request gets a list of information about the remote copy pairs (TrueCopy, Universal Replicator, or global-active device) registered in the target storage system. You can obtain information about all such pairs from the cache of the storage system, regardless of whether they are managed by using copy groups. You do not need to specify the information about the remote storage system in the request message.



Note:

- This API can be used when the storage system is the VSP 5000 series.
- To get up-to-date information, you must run the API request that refreshes the storage system's cache before running this request. For details, see "Updating the cache of storage system configuration information".

Execution permission

Storage Administrator (View Only)

Request line

```
GET base-URL/v1/objects/storages/remote-replications
```

Request message

Object ID

None.

Query parameters

| Parameter | Type | Filter condition |
|-------------|------|---|
| startLdevId | int | (Optional) To specify a range of LDEVs, specify the LDEV number of the first LDEV in the range. |

| Parameter | Type | Filter condition |
|------------------------------|--------|--|
| | | <p>The P-VOLs and S-VOLs in the specified range of LDEVs are searched, and information about the relevant pairs is obtained.</p> <p>Specify a value in the range from 0 to 65279.</p> <p>The value of this parameter must be smaller than that of the <code>endLdevId</code> parameter.</p> <p>If this attribute is omitted, 0 is set.</p> |
| <code>endLdevId</code> | int | <p>(Optional) To specify a range of LDEVs, specify the LDEV number of the last LDEV in the range.</p> <p>The P-VOLs and S-VOLs in the specified range of LDEVs are searched, and information about the relevant pairs is obtained.</p> <p>Specify a value in the range from 0 to 65279.</p> <p>The value of this parameter must be greater than that of the <code>startLdevId</code> parameter.</p> <p>If this attribute is omitted, the maximum LDEV number in the storage system is set.</p> |
| <code>replicationType</code> | string | <p>(Optional) Specify the pair type of the pairs about which information is to be obtained.</p> <ul style="list-style-type: none"> ▪ TC: TrueCopy ▪ UR: Universal Replicator ▪ GAD: global-active device |

Body

None.

Response message**Body**

```
{
  "data": [
    {
      "remoteReplicationId": "R9,10088,375,R9,10011,969",
      "muNumber": 2,
      "replicationType": "UR",
      "pvolLdevId": 375,
      "svolLdevId": 969,
      "fenceLevel": "ASYNC",
    }
  ]
}
```

```

    "pvolJournalId": 10,
    "svolJournalId": 0,
    "pvolStatus": "PAIR",
    "consistencyGroupId": 17,
    "pvolStorageType": "R9",
    "pvolStorageSerial": "10088",
    "svolStorageType": "R9",
    "svolStorageSerial": "10011",
    "transitionStatus": "None",
    "pathGroupId": 0
  },
  {
    "remoteReplicationId": "R9,10088,378,R9,10011,765",
    "replicationType": "TC",
    "pvolLdevId": 378,
    "svolLdevId": 765,
    "fenceLevel": "DATA",
    "pvolStatus": "PAIR",
    "pvolStorageType": "R9",
    "pvolStorageSerial": "10088",
    "svolStorageType": "R9",
    "svolStorageSerial": "10011",
    "copyPace": 3,
    "pathGroupId": 0
  },
  {
    "remoteReplicationId": "R9,10088,400,R9,10011,567",
    "muNumber": 0,
    "replicationType": "GAD",
    "pvolLdevId": 400,
    "svolLdevId": 567,
    "fenceLevel": "NEVER",
    "quorumDiskId": 4,
    "pvolStatus": "PAIR",
    "consistencyGroupId": 11,
    "pvolIOMode": "L/M",
    "pvolStorageType": "R9",
    "pvolStorageSerial": "10088",
    "svolStorageType": "R9",
    "svolStorageSerial": "10011",
    "copyPace": 7,
    "pathGroupId": 0
  }
]
}

```

| Attribute | Type | Description |
|---------------------|--------|--|
| remoteReplicationId | string | Object ID of the remote copy pair The following attributes are output, separated by commas: <ul style="list-style-type: none"> ▪ pvolStorageType ▪ pvolStorageSerial ▪ pvolLdevId ▪ svolStorageType ▪ svolStorageSerial ▪ svolLdevId If the value of remoteReplicationId includes Unknown or -1, the pair might not be in a normal state. Check the status of the storage system. |
| muNumber | int | MU (mirror unit) number |
| replicationType | string | Pair type <ul style="list-style-type: none"> ▪ TC: TrueCopy ▪ UR: Universal Replicator ▪ GAD: global-active device |
| pvolLdevId | int | LDEV number of P-VOL |
| svolLdevId | int | LDEV number of S-VOL |
| fenceLevel | string | Fence level <ul style="list-style-type: none"> ▪ DATA: S-VOL data ▪ STATUS: S-VOL status ▪ NEVER: None ▪ ASYNC: Asynchronous If the fence level cannot be obtained, information is not output. |
| pvolJournalId | int | Journal ID of the P-VOL A value from 0 to 255 is output only in the case of Universal Replicator. |
| svolJournalId | int | Journal ID of the S-VOL A value from 0 to 255 is output only in the case of Universal Replicator. |

| Attribute | Type | Description |
|--------------------|--------|--|
| quorumDiskId | int | <p>ID of the Quorum disk</p> <p>A value from 0 to 31 is output only in the case of global-active device.</p> |
| pvolStatus | string | <p>Pair volume status of the P-VOL</p> <p>This attribute is output only if the specified storage system contains the P-VOL.</p> <p>For details, see the section explaining on pair status (TrueCopy and Universal Replicator) or pair status (global-active device).</p> <p>In the case of Universal Replicator, if the transition status of the Universal Replicator pair is <code>Suspending</code> or <code>Deleting</code>, information is not output.</p> |
| svolStatus | string | <p>Pair volume status of the S-VOL</p> <p>This attribute is output only if the specified storage system contains the S-VOL.</p> <p>For details, see the section explaining on pair status (TrueCopy and Universal Replicator) or pair status (global-active device).</p> <p>In the case of Universal Replicator, if the transition status of the Universal Replicator pair is <code>Suspending</code> or <code>Deleting</code>, information is not output.</p> |
| consistencyGroupId | int | <p>Consistency group ID</p> <p>This attribute is not output if no consistency group consists.</p> |
| pvollOMode | string | <p>I/O mode of the P-VOL</p> <ul style="list-style-type: none"> ▪ L/M: Mirror (RL) ▪ L/L: Local ▪ B/B: Block <p>This is output only if the volume is a global-active device and the specified storage system is on the P-VOL.</p> |

| Attribute | Type | Description |
|-------------------|--------|---|
| svolIOMode | string | <p>I/O mode of the S-VOL</p> <ul style="list-style-type: none"> ▪ L/M: Mirror (RL) ▪ L/L: Local ▪ B/B: Block <p>This is output only if the volume is a global-active device and the specified storage system is on the S-VOL.</p> |
| pvolStorageType | string | <p>ID indicating the model of the storage system on the P-VOL</p> <ul style="list-style-type: none"> ▪ R8: VSP G1000, VSP G1500, or VSP F1500 ▪ R9: VSP 5000 series ▪ M8: VSP E series, VSP Gx00 models, VSP Fx00 models ▪ UNKNOWN: Unknown |
| pvolStorageSerial | string | Serial number of the storage system on the P-VOL |
| svolStorageType | string | <p>ID indicating the model of the storage system on the S-VOL</p> <ul style="list-style-type: none"> ▪ R8: VSP G1000, VSP G1500, or VSP F1500 ▪ R9: VSP 5000 series ▪ M8: VSP E series, VSP Gx00 models, VSP Fx00 models ▪ UNKNOWN: Unknown |
| svolStorageSerial | string | Serial number of the storage system on the S-VOL |
| transitionStatus | string | <p>The transition status of a pair is output for a Universal Replicator pair.</p> <ul style="list-style-type: none"> ▪ None: The pair is not in transition. ▪ Suspending: The pair is being split. ▪ Deleting: The pair is being deleted. <p>This is not output if the copy pair is not a Universal Replicator pair.</p> |
| copyPace | int | Copy speed |

| Attribute | Type | Description |
|-------------|--------|---|
| | | <p>If the pair type is TrueCopy, this attribute is output only if the specified storage system contains the P-VOL.</p> <p>If the pair type is global-active device, this attribute is output regardless of whether the specified storage system contains the P-VOL or contains the S-VOL.</p> <p>This is not output if the pair type is Universal Replicator.</p> |
| pathGroupId | int | <p>Path group ID of the RCU</p> <p>This is not output if CU is specified for the remote path connection setting.</p> |
| deltaStatus | string | <p>Status of the 3DC multi-target configuration that uses delta resync</p> <p>This is output if the pair type is Universal Replicator and the 3DC multi-target configuration that uses delta resync is used.</p> <ul style="list-style-type: none"> ▪ HOLD: Universal Replicator delta resync pair (normal) ▪ HLDE: Universal Replicator delta resync pair (failed) ▪ HOLDING: In the process of being changed to a Universal Replicator delta resync pair |

Status codes

For details on the status codes for the request that performs this operation, see the description of HTTP status codes.

Coding example

```
curl -v -H "Accept: application/json" -H "Authorization:Session
d7b673af189048468c5af9bcf3b66b6f" -X GET https://192.0.2.100/
ConfigurationManager/v1/objects/remote-replications
```

Creating a global-active device pair

The following request creates a global-active device pair in the storage systems of the primary and secondary sites. The global-active device pair is either added to a new copy group or to an existing copy group. If you create a copy group, a device group is also created.

Before creating a pair, lock the resources or make sure that the resources have not been locked by another user.



Tip:

- Before creating the pair, set the reserved attribute of global-active device for the secondary volume by using the API that sets a virtual LDEV number.
- We recommend specifying `Job-Mode-Wait-Configuration-Change:NoWait` in the request header of this API function. For details, see the description of the flow of operations for the pairs.
- For data migration that uses global-active device pairs, one volume is paired with two different volumes to form one pair for migration from the global-active device pair that is in use, and to form one migration destination pair from one pair for migration. In this case, the pair statuses of the pair for migration and the migration destination pair might not change even after the copying processing finishes. For this reason, when performing operations on a pair for migration or a migration destination pair, specify `Job-Mode-Wait-Configuration-Change:NoWait` in the request header of the API function. For details, see the description of the flow of operations for the pairs. For details on data migration that uses global-active device pairs, see the *Global-Active Device User Guide*.

Execution permission

Storage Administrator (Provisioning) and Storage Administrator (Remote Copy)

Request line

```
POST base-URL/v1/objects/remote-mirror-copypairs
```

Request message

Object ID

None.

Query parameters

None.

Body

The following is a coding example for creating a new copy group and adding a pair to the copy group:

```
{
  "copyGroupName": "remoteCopyGroup3",
  "copyPairName": "pair1",
  "replicationType": "GAD",
  "remoteStorageDeviceId": "886000123789",
  "pvolldevId": 1580,
  "svolldevId": 2128,
```

```

"localDeviceGroupName": "remoteCopyGroup3P_",
"remoteDeviceGroupName": "remoteCopyGroup3S_",
"muNumber": 0,
"quorumDiskId": 14,
"isNewGroupCreation": true,
"fenceLevel": "NEVER",
"copyPace": 10,
"doInitialCopy": true,
"isDataReductionForceCopy": true
}

```

The following is a coding example for adding a pair to an existing copy group:

```

{
"copyGroupName": "remoteCopyGroup3",
"copyPairName": "pair2",
"replicationType": "GAD",
"remoteStorageDeviceId": "886000123789",
"pvolLdevId": 1581,
"svolLdevId": 2129,
"localDeviceGroupName": "remoteCopyGroup3P_",
"remoteDeviceGroupName": "remoteCopyGroup3S_",
"quorumDiskId": 14,
"isNewGroupCreation": false,
"fenceLevel": "NEVER",
"copyPace": 10,
"doInitialCopy": true,
"isDataReductionForceCopy": false
}

```

| Attribute | Type | Description |
|-----------------|--------|--|
| copyGroupName | string | (Required) Specify a copy group name consisting of 1 to 29 characters. The name is case sensitive. Set a unique name that is the same for the storage systems on both the local and remote sides. |
| copyPairName | string | (Required) Specify a copy pair name consisting of 1 to 31 characters. The name is case sensitive. Set a unique name that is the same for the storage systems in the copy group. |
| replicationType | string | (Required) Specify the pair type. |

| Attribute | Type | Description |
|-----------------------|--------|---|
| | | GAD: global-active device |
| remoteStorageDeviceId | string | (Required) Specify the storage device ID of the remote storage system in which the pair is to be created. |
| pvolLdevId | int | (Required) Specify the LDEV number of the P-VOL with a decimal (base 10) number. |
| svolLdevId | int | (Required) Specify the LDEV number of the S-VOL for which the reserved attribute of global-active device is set. Specify it with a decimal (base 10) number. Specify the reserved attribute of global-active device by using the API that sets a virtual LDEV number. |
| pathGroupId | int | (Optional) Specify the path group ID by using a decimal (base 10) number in the range from 0 to 255. If you omit this value or specify 0, the lowest path group ID in the specified path group is used. |
| localDeviceGroupName | string | (Optional) Specify the device group name in the local storage system by using 1 to 31 characters. The name is case sensitive. If you add the pair to an existing copy group, specify the same device group name as that of the existing local storage system. The name needs to be unique in the local storage system. If this value is omitted, <i>copyGroupNameP_</i> is assumed. |
| remoteDeviceGroupName | string | (Optional) Specify the device group name in the remote storage system by using 1 to 31 characters. The name is case sensitive. If you add the pair to an existing copy group, specify the same device group name as that of the existing remote storage system. The name needs to be unique in the remote storage system. If this value is omitted, <i>copyGroupNameS_</i> is assumed. |

| Attribute | Type | Description |
|--------------------|---------|---|
| isNewGroupCreation | boolean | <p>(Required) Depending on the value, this attribute specifies whether to add the pair to a new copy group or to an existing copy group.</p> <ul style="list-style-type: none"> ▪ <code>true</code>: Adds the pair to a new copy group. ▪ <code>false</code>: Adds the pair to an existing copy group. |
| muNumber | int | <p>(Required) Specify the MU (mirror unit) number by using a number from 0 to 3.</p> <p>This value is used by the P-VOL and the S-VOL. You can specify this attribute only if you add the pair to a new copy group.</p> |
| quorumDiskId | int | <p>(Required) Specify the quorum disk ID by using a decimal (base 10) number in the range from 0 to 31.</p> |
| isConsistencyGroup | boolean | <p>(Optional) Depending on the value, this attribute specifies whether to register the new pair in a consistency group.</p> <ul style="list-style-type: none"> ▪ <code>true</code>: Registers the pair in a consistency group. ▪ <code>false</code>: Does not register the pair in a consistency group. <p>If you add the pair to an existing copy group, specify the same value as that of the existing copy pair. If a copy group includes both pairs that are registered in a consistency group and pairs that are not registered in a consistency group, pair operations by consistency group cannot be correctly performed. If this value is omitted, <code>false</code> is assumed.</p> |
| consistencyGroupId | int | <p>(Optional) Specify the consistency group ID by using a decimal (base 10) number.</p> <p>If you omit this value when registering the new pair in a consistency group, the value is automatically assigned.</p> |

| Attribute | Type | Description |
|---------------------------------------|---------|--|
| | | <p>If you add the pair to an existing copy group, specify the same value as that of the existing copy pair. If a copy group includes a pair whose consistency group ID differs, pair operations by consistency group cannot be correctly performed.</p> <p>When specifying this attribute, make sure to specify <code>true</code> for the <code>isConsistencyGroup</code> attribute.</p> |
| <code>fenceLevel</code> | string | <p>(Optional) Fence level</p> <p><code>NEVER</code> is automatically set.</p> |
| <code>copyPace</code> | int | <p>(Optional) Copy speed</p> <p>Specify a decimal (base 10) number in the range from 1 to 15 for the size of tracks to be copied. The larger the value you specify, the faster the copy speed.</p> <p>If this value is omitted, 3 is assumed.</p> |
| <code>doInitialCopy</code> | boolean | <p>(Optional) Specify whether to perform initial copy when creating a pair.</p> <ul style="list-style-type: none"> ▪ <code>true</code>: Performs initial copy. ▪ <code>false</code>: Does not perform initial copy. <p>If this value is omitted, <code>true</code> is assumed.</p> |
| <code>isDataReductionForceCopy</code> | boolean | <p>(Optional) Specify whether to forcibly create a pair for a volume for which the capacity saving function (dedupe and compression) is enabled.</p> <p>When creating a pair for a volume for which the capacity saving function is enabled, always specify <code>true</code>.</p> <ul style="list-style-type: none"> ▪ <code>true</code>: Forcibly create a pair # ▪ <code>false</code>: Do not forcibly create a pair <p>When the attribute is omitted, <code>false</code> is assumed.</p> |

#: If you create a pair by using volumes for which the capacity saving function (compression or deduplication) is enabled, data that has been compressed or deduplicated will be copied and, as a result, the performance of the copying processing or the I/O performance of the host might decrease.

Response message**Body**

A job object is returned. For details on attributes other than `affectedResources`, see the section explaining job objects.

| Attribute | Description |
|--------------------------------|---|
| <code>affectedResources</code> | URL for accessing the created global-active device pair |

Status codes

For details on the status codes of the request for this operation, see the section explaining HTTP status codes.

Coding example

```
curl -v -H "Accept: application/json" -H "Remote-Authorization:Session
10399alffce3489b9c3a823017462396" -H "Content-Type: application/json" -H
"Authorization:Session d7b673af189048468c5af9bcf3b66b6f" -X POST --data-
binary @./InputParameters.json https://192.0.2.100/ConfigurationManager/v1/
objects/remote-mirror-copypairs
```

Deleting global-active device pairs in units of copy groups

The following request deletes global-active device pairs by using the specified copy group. When the pairs are all deleted, the device groups are also deleted. You can specify a copy group on the primary volume side to delete pairs. Alternatively, you can specify a copy group on the secondary volume side to delete pairs. Before deleting pairs, specify the copy group to suspend the pairs, and then change the statuses of the pairs to suspension. If a copy group includes the primary volume and the secondary volume, you cannot specify a copy group to delete pairs. Before deleting a pair, lock the resources or make sure that the resources have not been locked by another user.

Execution permission

Storage Administrator (Provisioning) and Storage Administrator (Remote Copy)

Request line

```
DELETE base-URL/v1/objects/remote-mirror-copygroups/object-ID
```

Request message**Object ID**

Specify the value of `remoteMirrorCopyGroupId` that was obtained by the processing to get information about the remote copy group. You can also specify the attributes and connect them with commas as follows:

```
remoteStorageDeviceId, copyGroupName, localDeviceGroupName,
remoteDeviceGroupName
```

| Attribute | Type | Description |
|------------------------------------|--------|---|
| <code>remoteStorageDeviceId</code> | string | (Required) Storage device ID of the remote storage system |
| <code>copyGroupName</code> | string | (Required) Copy group name Specify a name consisting of 1 to 31 characters. The name is case sensitive. |
| <code>localDeviceGroupName</code> | string | (Required) Device group name in the local storage system Specify a name consisting of 1 to 31 characters. The name is case sensitive. |
| <code>remoteDeviceGroupName</code> | string | (Required) Device group name in the remote storage system Specify a name consisting of 1 to 31 characters. The name is case sensitive. |

Query parameters

None.

Body

The following is a coding example of continuing to use the S-VOL after a suspended (S-LOCAL) pair is deleted:

```
{
  "isSvolToKeepUsing" : true
}
```

| Attribute | Type | Description |
|-------------------|---------|---|
| isSvolToKeepUsing | boolean | <p>(Optional) Specify the volume that continues I/O after pairs are deleted.</p> <ul style="list-style-type: none"> <code>true</code>: Deletes the pairs by specifying the S-VOL. The S-VOL continues I/O, and the reserved attribute of global-active device is set for the P-VOL. If you set <code>true</code>, you must suspend pairs in advance by specifying the S-VOL. <code>false</code>: Deletes the pairs by specifying the P-VOL. The P-VOL continues I/O, and the reserved attribute of global-active device is set for the S-VOL. If you set <code>false</code>, you must suspend pairs in advance by specifying the P-VOL. <p>If this value is omitted, <code>false</code> is set.</p> |

Response message

Body

A job object is returned. For details on attributes other than `affectedResources`, see the section explaining job objects.

| Attribute | Description |
|--------------------------------|---|
| <code>affectedResources</code> | URL of the copy group of the deleted global-active device pairs |

Status codes

For details on the status codes of the request for this operation, see the section explaining HTTP status codes.

Coding example

```
curl -v -H "Accept: application/json" -H "Remote-Authorization:Session 10399a1ffce3489b9c3a823017462396" -H "Content-Type: application/json" -H "Authorization:Session d7b673af189048468c5af9bcf3b6bb6f" -X DELETE --data-binary @./InputParameters.json https://192.0.2.100/ConfigurationManager/v1/objects/remote-mirror-copygroups/886000123789,remoteCopyGroup,remoteCopyGroupP_,remoteCopyGroupS_
```

Deleting a global-active device pair

The following request deletes the specified global-active device pair. As a result of deleting a pair, if there is no pair in the copy group, the copy group and the device group are also deleted. You can specify the primary volume to delete a pair. Alternatively, you can specify the secondary volume to delete a pair. Before deleting a pair, suspend the pair, and then change the status of the pair to suspension. Before deleting a pair, lock the resources or make sure that the resources have not been locked by another user.

Execution permission

Storage Administrator (Provisioning) and Storage Administrator (Remote Copy)

Request line

```
DELETE base-URL/v1/objects/remote-mirror-copypairs/object-ID
```

Request message

Object ID

Specify the value of `remoteMirrorCopyPairId` that was obtained by the processing to get information about the remote copy pair. You can also specify the attributes and connect them with commas as follows:

```
remoteStorageDeviceId, copyGroupName, localDeviceGroupName,  
remoteDeviceGroupName, copyPairName
```

| Attribute | Type | Description |
|-----------------------|--------|--|
| remoteStorageDeviceId | string | (Required) Storage device ID of the remote storage system |
| copyGroupName | string | (Required) Copy group name Specify a name consisting of 1 to 31 characters. The name is case sensitive. |
| localDeviceGroupName | string | (Required) Device group name in the local storage system Specify a name consisting of 1 to 31 characters. The name is case sensitive. |
| remoteDeviceGroupName | string | (Required) Device group name in the remote storage system Specify a name consisting of 1 to 31 characters. The name is case sensitive. |

| Attribute | Type | Description |
|--------------|--------|--|
| copyPairName | string | (Required) Copy pair name Specify a name consisting of 1 to 31 characters. The name is case sensitive. |

Query parameters

None.

Body

The following is a coding example of continuing to use the S-VOL after a suspended (S-LOCAL) pair is deleted:

```
{
  "isSvolToKeepUsing" : true
}
```

| Attribute | Type | Description |
|-------------------|---------|--|
| isSvolToKeepUsing | boolean | (Optional) Specify the volume that continues I/O after the pair is deleted. <ul style="list-style-type: none"> <code>true</code>: Deletes the pair by specifying the S-VOL. The S-VOL continues I/O, and the reserved attribute of global-active device is set for the P-VOL. If you set <code>true</code>, you must suspend pairs in advance by specifying the S-VOL. <code>false</code>: Deletes the pair by specifying the P-VOL. The P-VOL continues I/O, and the reserved attribute of global-active device is set for the S-VOL. If you set <code>false</code>, you must suspend pairs in advance by specifying the P-VOL. <p>If this value is omitted, <code>false</code> is set.</p> |

Response message**Body**

A job object is returned. For details on attributes other than `affectedResources`, see the section explaining job objects.

| Attribute | Description |
|--------------------------------|--|
| <code>affectedResources</code> | URL of the deleted global-active device pair |

Status codes

For details on the status codes of the request for this operation, see the section explaining HTTP status codes.

Coding example

```
curl -v -H "Accept: application/json" -H "Remote-Authorization:Session
10399a1ffce3489b9c3a823017462396" -H "Content-Type: application/json" -H
"Authorization:Session d7b673af189048468c5af9bcf3bbbb6f" -X DELETE --data-
binary @./InputParameters.json https://192.0.2.100/ConfigurationManager/v1/
objects/remote-mirror-copypairs/886000123789,remoteCopyGroup,
remoteCopyGroupP_,remoteCopyGroupS_,pair1
```

Suspending global-active device pairs in units of copy groups

The following request suspends global-active device pairs by using the specified copy group. You can specify a copy group on the primary volume side to suspend pairs. Alternatively, you can specify a copy group on the secondary volume side to suspend pairs. If a copy group includes the primary volume and the secondary volume, you cannot specify the copy group to suspend pairs. Also, when suspending pairs by copy group, do not simultaneously perform other operations on the copy group or the pairs in that copy group on which a pair suspending operation is performed.



Tip: We recommend specifying `Job-Mode-Wait-Configuration-Change:NoWait` in the request header of this API function. For details, see the description of the flow of operations for the pairs.

Execution permission

Storage Administrator (Remote Copy)

Request line

```
POST base-URL/v1/objects/remote-mirror-copygroups/object-ID/actions/split/
invoke
```

Request message**Object ID**

Specify the value of `remoteMirrorCopyGroupId` that was obtained by the processing to get information about the remote copy group. You can also specify the attributes and connect them with commas as follows:

```
remoteStorageDeviceId, copyGroupName, localDeviceGroupName,
remoteDeviceGroupName
```

| Attribute | Type | Description |
|------------------------------------|--------|---|
| <code>remoteStorageDeviceId</code> | string | (Required) Storage device ID of the remote storage system |
| <code>copyGroupName</code> | string | (Required) Copy group name Specify a name consisting of 1 to 31 characters. The name is case sensitive. |
| <code>localDeviceGroupName</code> | string | (Required) Device group name in the local storage system Specify a name consisting of 1 to 31 characters. The name is case sensitive. |
| <code>remoteDeviceGroupName</code> | string | (Required) Device group name in the remote storage system Specify a name consisting of 1 to 31 characters. The name is case sensitive. |

Query parameters

None.

Body

The following coding example is for simply suspending pairs. After pairs are suspended, I/O is continued on the P-VOL.

```
{
  "parameters": {
    "replicationType": "GAD"
  }
}
```

The following coding example is for suspending pairs by specifying the S-VOL. After pairs are suspended, I/O is continued on the S-VOL.

```
{
  "parameters": {
    "replicationType": "GAD",
    "svolOperationMode": "SSWS"
  }
}
```

| Attribute | Type | Description |
|-------------------|--------|---|
| replicationType | string | (Required) Specify the pair type. GAD: global-active device |
| svolOperationMode | string | (Optional) Specify the volume that continues I/O after pairs are suspended. Specify the following value. <ul style="list-style-type: none"> SSWS: The S-VOL continues I/O. Specify the S-VOL to suspend a pair. If this attribute is omitted, the P-VOL continues I/O. In this case, specify the P-VOL to suspend a pair. |

Response message

Body

A job object is returned. For details on attributes other than affectedResources, see the section explaining job objects.

| Attribute | Description |
|-------------------|---|
| affectedResources | URL of the copy group of the suspended global-active device pairs |

Action template

```
GET base-URL/v1/objects/remote-mirror-copygroups/object-ID/actions/split
```

This action template returns only the specifiable attributes, depending on the following: the type of the pairs of the copy group specified for the object ID, and whether the volume in the local storage system is the primary volume or the secondary volume.

Status codes

The following table describes the meaning of the status code of the request for this operation. For details on other status codes, see the section explaining HTTP status codes.

| Status code | Message | Description |
|-------------|---------------------|---|
| 412 | Precondition Failed | This object indicates that operations on the pairs of the specified copy group cannot be performed. |

Coding example

To get an action template:

When the storage system of the P-VOL is specified:

```
curl -v -H "Accept: application/json" -H "Remote-Authorization:Session
10399a1ffce3489b9c3a823017462396" -H "Authorization:Session
d7b673af189048468c5af9bcf3bbbb6f" -X GET https://192.0.2.100/
ConfigurationManager/v1/objects/remote-mirror-copygroups/886000123789,
remoteCopyGroup,remoteCopyGroupP_,remoteCopyGroupS_/actions/split
```

When the storage system of the S-VOL is specified:

```
curl -v -H "Accept: application/json" -H "Remote-Authorization:Session
10399a1ffce3489b9c3a823017462396" -H "Authorization:Session
d7b673af189048468c5af9bcf3bbbb6f" -X GET https://192.0.2.100/
ConfigurationManager/v1/objects/remote-mirror-copygroups/886000123456,
remoteCopyGroup,remoteCopyGroupS_,remoteCopyGroupP_/actions/split
```

To run the request after getting an action template:

When the storage system of the P-VOL is specified:

```
curl -v -H "Accept: application/json" -H "Remote-Authorization:Session
10399a1ffce3489b9c3a823017462396" -H "Content-Type: application/json" -H
"Authorization:Session d7b673af189048468c5af9bcf3bbbb6f" -X POST --data-
binary @./InputParameters.json https://192.0.2.100/ConfigurationManager/v1/
objects/remote-mirror-copygroups/886000123789,remoteCopyGroup,
remoteCopyGroupP_,remoteCopyGroupS_/actions/split/invoke
```

When the storage system of the S-VOL is specified:

```
curl -v -H "Accept: application/json" -H "Remote-Authorization:Session
10399a1ffce3489b9c3a823017462396" -H "Content-Type: application/json" -H
"Authorization:Session d7b673af189048468c5af9bcf3bbbb6f" -X POST --data-
binary @./InputParameters.json https://192.0.2.100/ConfigurationManager/v1/
objects/remote-mirror-copygroups/886000123456,remoteCopyGroup,
remoteCopyGroupS_,remoteCopyGroupP_/actions/split/invoke
```

Suspending a global-active device pair

The following request suspends the specified global-active device pair. You can specify the primary volume to suspend a pair. Alternatively, you can specify the secondary volume to suspend a pair. Also, when suspending a pair, do not simultaneously perform other operations on the copy group or the pairs in that copy group on which a pair suspending operation is performed.



Tip: We recommend specifying `Job-Mode-Wait-Configuration-Change:NoWait` in the request header of this API function. For details, see the description of the flow of operations for the pairs.

Execution permission

Storage Administrator (Remote Copy)

Request line

```
POST base-URL/v1/objects/remote-mirror-copypairs/object-ID/actions/split/
invoke
```

Request message

Object ID

Specify the value of `remoteMirrorCopyPairId` that was obtained by the processing to get information about the remote copy pair. You can also specify the attributes and connect them with commas as follows:

```
remoteStorageDeviceId, copyGroupName, localDeviceGroupName,
remoteDeviceGroupName, copyPairName
```

| Attribute | Type | Description |
|------------------------------------|--------|--|
| <code>remoteStorageDeviceId</code> | string | (Required) Storage device ID of the remote storage system |
| <code>copyGroupName</code> | string | (Required) Copy group name Specify a name consisting of 1 to 31 characters. The name is case sensitive. |
| <code>localDeviceGroupName</code> | string | (Required) Device group name in the local storage system Specify a name consisting of 1 to 31 characters. The name is case sensitive. |
| <code>remoteDeviceGroupName</code> | string | (Required) Device group name in the remote storage system |

| Attribute | Type | Description |
|--------------|--------|---|
| | | Specify a name consisting of 1 to 31 characters. The name is case sensitive. |
| copyPairName | string | (Required) Copy pair name Specify a name consisting of 1 to 31 characters. The name is case sensitive. |

Query parameters

None.

Body

The following coding example is for simply suspending pairs. After pairs are suspended, I/O is continued on the P-VOL.

```
{
  "parameters": {
    "replicationType": "GAD"
  }
}
```

The following coding example is for suspending pairs by specifying the S-VOL. After pairs are suspended, I/O is continued on the S-VOL.

```
{
  "parameters": {
    "replicationType": "GAD",
    "svolOperationMode": "SSWS"
  }
}
```

| Attribute | Type | Description |
|-------------------|--------|---|
| replicationType | string | (Required) Specify the pair type. GAD: global-active device |
| svolOperationMode | string | (Optional) Specify the volume that continues I/O after pairs are suspended. Specify the following value. <ul style="list-style-type: none"> SSWS: The S-VOL continues I/O. Specify the S-VOL to suspend a pair. If this attribute is omitted, the P-VOL continues I/O. In this case, specify the P-VOL to suspend a pair. |

Response message**Body**

A job object is returned. For details on attributes other than `affectedResources`, see the section explaining job objects.

| Attribute | Description |
|--------------------------------|--|
| <code>affectedResources</code> | URL of the suspended global-active device pair |

Action template

```
GET base-URL/v1/objects/remote-mirror-copypairs/object-ID/actions/split
```

This action template returns only the specifiable attributes, depending on the following: the type of the copy pair specified for the object ID, and whether the volume in the local storage system is the primary volume or the secondary volume.

Status codes

The following table describes the meaning of the status code of the request for this operation. For details on other status codes, see the section explaining HTTP status codes.

| Status code | Message | Description |
|-------------|---------------------|--|
| 412 | Precondition Failed | This object indicates that operations on the specified pair cannot be performed. |

Coding example

To get an action template:

When the storage system of the P-VOL is specified:

```
curl -v -H "Accept: application/json" -H "Remote-Authorization:Session
10399a1ffce3489b9c3a823017462396" -H "Authorization:Session
d7b673af189048468c5af9bcf3bbbb6f" -X GET https://192.0.2.100/
ConfigurationManager/v1/objects/remote-mirror-copypairs/886000123789,
remoteCopyGroup,remoteCopyGroupP_,remoteCopyGroupS_,pair1/actions/split
```

When the storage system of the S-VOL is specified:

```
curl -v -H "Accept: application/json" -H "Remote-Authorization:Session
10399a1ffce3489b9c3a823017462396" -H "Authorization:Session
d7b673af189048468c5af9bcf3bbbb6f" -X GET https://192.0.2.100/
ConfigurationManager/v1/objects/remote-mirror-copypairs/886000123456,
remoteCopyGroup,remoteCopyGroupS_,remoteCopyGroupP_,pair1/actions/split
```

To run the request after getting an action template:

When the storage system of the P-VOL is specified:

```
curl -v -H "Accept: application/json" -H "Remote-Authorization:Session
10399a1ffce3489b9c3a823017462396" -H "Content-Type: application/json" -H
"Authorization:Session d7b673af189048468c5af9bcf3b6bb6f" -X POST --data-
binary @./InputParameters.json https://192.0.2.100/ConfigurationManager/v1/
objects/remote-mirror-copypairs/886000123789,remoteCopyGroup,
remoteCopyGroupP_,remoteCopyGroupS_,pair1/actions/split/invoke
```

When the storage system of the S-VOL is specified:

```
curl -v -H "Accept: application/json" -H "Remote-Authorization:Session
10399a1ffce3489b9c3a823017462396" -H "Content-Type: application/json" -H
"Authorization:Session d7b673af189048468c5af9bcf3b6bb6f" -X POST --data-
binary @./InputParameters.json https://192.0.2.100/ConfigurationManager/v1/
objects/remote-mirror-copypairs/886000123456,remoteCopyGroup,
remoteCopyGroupS_,remoteCopyGroupP_,pair1/actions/split/invoke
```

Resynchronizing global-active device pairs in units of copy groups

The following request resynchronizes global-active device pairs by using the specified copy groups. You can specify a copy group on the primary volume side to resynchronize pairs. Alternatively, you can specify a copy group on the secondary volume side to resynchronize pairs. If a copy group includes the primary volume and the secondary volume, you cannot specify the copy group to resynchronize pairs. Also, when resynchronizing pairs by copy group, do not simultaneously perform other operations on the copy group or the pairs in that copy group on which a pair resynchronization operation is performed.



Tip:

- We recommend specifying `Job-Mode-Wait-Configuration-Change:NoWait` in the request header of this API function. For details, see the description of the flow of operations for the pairs.
- For data migration that uses global-active device pairs, one volume is paired with two different volumes to form one pair for migration from the global-active device pair that is in use, and to form one migration destination pair from one pair for migration. In this case, the pair statuses of the pair for migration and the migration destination pair might not change even after the copying processing finishes. For this reason, when performing operations on a pair for migration or a migration destination pair, specify `Job-Mode-Wait-Configuration-Change:NoWait` in the request header of the API function. For details, see the description of the flow of operations for the pairs. For details on data migration that uses global-active device pairs, see the *Global-Active Device User Guide*.

**Note:**

If the model of either or both of the storage systems is VSP E series, VSP G350, G370, G700, G900, VSP F350, F370, F700, F900, to register pairs in a consistency group when performing a pair resynchronization operation, the number of pairs in the target copy group must be 1,000 or less. If the number of pairs exceeds 1,000, delete all pairs in the copy group, and then register pairs in a consistency group when you re-create the pairs. Alternatively, delete some pairs so that the number of pairs decreases to 1,000 or less, perform a pair resynchronization operation, and then register the pairs in a consistency group when you re-create the pairs that you deleted.

Execution permission

Storage Administrator (Remote Copy)

Request line

```
POST base-URL/v1/objects/remote-mirror-copygroups/object-ID/actions/resync/
invoke
```

Request message**Object ID**

Specify the value of `remoteMirrorCopyGroupId` that was obtained by the processing to get information about the remote copy group. You can also specify the attributes and connect them with commas as follows:

```
remoteStorageDeviceId, copyGroupName, localDeviceGroupName,
remoteDeviceGroupName
```

| Attribute | Type | Description |
|------------------------------------|--------|--|
| <code>remoteStorageDeviceId</code> | string | (Required) Storage device ID of the remote storage system |
| <code>copyGroupName</code> | string | (Required) Copy group name Specify a name consisting of 1 to 31 characters. The name is case sensitive. |
| <code>localDeviceGroupName</code> | string | (Required) Device group name in the local storage system Specify a name consisting of 1 to 31 characters. The name is case sensitive. |
| <code>remoteDeviceGroupName</code> | string | (Required) Device group name in the remote storage system |

| Attribute | Type | Description |
|-----------|------|--|
| | | Specify a name consisting of 1 to 31 characters. The name is case sensitive. |

Query parameters

None.

Body

The following is a coding example for simply resynchronizing pairs:

```
{
  "parameters": {
    "replicationType": "GAD"
  }
}
```

The following is a coding example for reversing and resynchronizing pairs by specifying the S-VOL:

```
{
  "parameters": {
    "replicationType": "GAD",
    "doSwapSvol": true
  }
}
```

| Attribute | Type | Description |
|-----------------|---------|--|
| replicationType | string | (Required) Specify the pair type. GAD: global-active device |
| doSwapSvol | boolean | (Optional) Specify the copy group to be used for a pair resynchronization operation. Use this attribute when the S-VOL side is used as the local storage system. <ul style="list-style-type: none"> ▪ <code>true</code>: Resynchronize pairs by specifying the copy group on the S-VOL side (swap resync). You can use this value if the pairs in the specified copy group on the S-VOL side are suspended. Reverse the P-VOL and the S-VOL, and then copy data of the new P-VOL to the new S-VOL. ▪ <code>false</code>: Resynchronize pairs by specifying the copy group on the P-VOL side. |

| Attribute | Type | Description |
|--------------------|---------|--|
| | | <p>If the value is not specified, <code>false</code> will be set.</p> <p>If this attribute is set to <code>true</code>, you cannot specify <code>true</code> for the <code>doSwapPvol</code> and <code>isConsistencyGroup</code> attributes.</p> |
| doSwapPvol | boolean | <p>(Optional) Specify the copy group to be used for a pair resynchronization operation. Use this attribute when the P-VOL side is used as the local storage system.</p> <ul style="list-style-type: none"> ▪ <code>true</code>: Resynchronize pairs by specifying the copy group on the P-VOL side (swap resync). <p>You can use this value if the pairs in the specified copy group on the P-VOL side are suspended. Reverse the P-VOL and the S-VOL, and then copy data of the new P-VOL to the new S-VOL.</p> <ul style="list-style-type: none"> ▪ <code>false</code>: Resynchronize pairs by specifying the copy group on the P-VOL side. <p>If the value is not specified, <code>false</code> will be set.</p> <p>If this attribute is set to <code>true</code>, you cannot specify <code>true</code> for the <code>doSwapSvol</code> and <code>isConsistencyGroup</code> attributes.</p> |
| isConsistencyGroup | boolean | <p>(Optional) If the pair is not registered in a consistency group, you can specify the value as follows:</p> <ul style="list-style-type: none"> ▪ <code>true</code>: Registers the copy group in a consistency group.# ▪ <code>false</code>: Leaves the copy group as it is without registering it in a consistency group. <p>If the pair is already registered in a consistency group, you do not need to specify this attribute to maintain the registered state, regardless of the value specified for this attribute. Note that, if <code>false</code> is specified, registration of the consistency group cannot be canceled.</p> <p>To register the copy group in a consistency group, you must also specify the <code>consistencyGroupId</code> attribute.</p> |

| Attribute | Type | Description |
|----------------------------------|---------------------|--|
| | | Make sure that each copy group contains either only pairs that are registered to a consistency group or only pairs that are not registered to a consistency group. If a copy group includes both pairs that are registered in a consistency group and pairs that are not registered in a consistency group, pair operations by consistency group cannot be correctly performed. If you specify <code>true</code> for this attribute, you cannot specify the <code>doSwapSvol</code> and <code>doSwapPvol</code> attributes. |
| <code>consistencyGroupPld</code> | <code>int</code> | (Optional) Specify the consistency group ID by using a decimal (base 10) number. Be sure to specify this attribute when registering the copy group in a consistency group. |
| <code>fenceLevel</code> | <code>string</code> | (Optional) Specify <code>NEVER</code> for the fence level. If you specify <code>true</code> for the <code>isConsistencyGroup</code> attribute, <code>NEVER</code> is automatically set. |
| <code>copyPace</code> | <code>int</code> | (Optional) Copy speed Specify a decimal (base 10) number in the range from 1 to 15 for the size of tracks to be copied. The larger the value you specify, the faster the copy speed. |

#: If the model of either or both of the storage systems is VSP E series, VSP G350, G370, G700, G900, VSP F350, F370, F700, F900, this value can be specified only if the number of pairs in the copy group is 1,000 or less.

Response message

Body

A job object is returned. For details on attributes other than `affectedResources`, see the description on job objects.

| Attribute | Description |
|--------------------------------|--|
| <code>affectedResources</code> | URL of the copy group of the resynchronized global-active device pairs |

Action template

```
GET base-URL/v1/objects/remote-mirror-copygroups/object-ID/actions/resync
```

This action template returns only the specifiable attributes, depending on the following: the type of the pairs of the copy group specified for the object ID, and whether the volume in the local storage system is the primary volume or the secondary volume.

Status codes

The following table describes the meaning of the status code of the request for this operation. For details on other status codes, see the description on HTTP status codes.

| Status code | Message | Description |
|-------------|---------------------|--|
| 412 | Precondition Failed | This object indicates that operations on the specified pair cannot be performed. |

Coding example

To get an action template:

When the storage system of the P-VOL is specified:

```
curl -v -H "Accept: application/json" -H "Remote-Authorization:Session
10399a1ffce3489b9c3a823017462396" -H "Authorization:Session
d7b673af189048468c5af9bcf3bbbb6f" -X GET https://192.0.2.100/
ConfigurationManager/v1/objects/remote-mirror-copygroups/886000123789,
remoteCopyGroup,remoteCopyGroupP_,remoteCopyGroupS_/actions/resync
```

When the storage system of the S-VOL is specified:

```
curl -v -H "Accept: application/json" -H "Remote-Authorization:Session
10399a1ffce3489b9c3a823017462396" -H "Authorization:Session
d7b673af189048468c5af9bcf3bbbb6f" -X GET https://192.0.2.100/
ConfigurationManager/v1/objects/remote-mirror-copygroups/886000123456,
remoteCopyGroup,remoteCopyGroupS_,remoteCopyGroupP_/actions/resync
```

To run the request after getting an action template:

When the storage system of the P-VOL is specified:

```
curl -v -H "Accept: application/json" -H "Remote-Authorization:Session
10399a1ffce3489b9c3a823017462396" -H "Content-Type: application/json" -H
"Authorization:Session d7b673af189048468c5af9bcf3bbbb6f" -X POST --data-
binary @./InputParameters.json https://192.0.2.100/ConfigurationManager/v1/
objects/remote-mirror-copygroups/886000123789,remoteCopyGroup,
remoteCopyGroupP_,remoteCopyGroupS_/actions/resync/invoke
```

When the storage system of the S-VOL is specified:

```
curl -v -H "Accept: application/json" -H "Remote-Authorization:Session
10399a1ffce3489b9c3a823017462396" -H "Content-Type: application/json" -H
```

```
"Authorization:Session d7b673af189048468c5af9bcf3b66b6f" -X POST --data-binary @./InputParameters.json https://192.0.2.100/ConfigurationManager/v1/objects/remote-mirror-copygroups/886000123456,remoteCopyGroup,remoteCopyGroupS_,remoteCopyGroupP_/actions/resync/invoke
```

Resynchronizing a global-active device pair

The following request resynchronizes the specified global-active device pair. You can specify the primary volume to resynchronize pairs. Alternatively, you can specify the secondary volume to resynchronize pairs. Also, when resynchronizing pairs, do not simultaneously perform other operations on the copy group or pairs on which a pair resynchronization operation is performed.



Tip:

- We recommend specifying `Job-Mode-Wait-Configuration-Change:NoWait` in the request header of this API function. For details, see the description of the flow of operations for the pairs.
- For data migration that uses global-active device pairs, one volume is paired with two different volumes to form one pair for migration from the global-active device pair that is in use, and to form one migration destination pair from one pair for migration. In this case, the pair statuses of the pair for migration and the migration destination pair might not change even after the copying processing finishes. For this reason, when performing operations on a pair for migration or a migration destination pair, specify `Job-Mode-Wait-Configuration-Change:NoWait` in the request header of the API function. For details, see the description of the flow of operations for the pairs. For details on data migration that uses global-active device pairs, see the *Global-Active Device User Guide*.



Note:

If the model of either or both of the storage systems is VSP E series, VSP G350, G370, G700, G900, VSP F350, F370, F700, F900, to register pairs in a consistency group when performing a pair resynchronization operation, the number of pairs in the target copy group must be 1,000 or less. If the number of pairs exceeds 1,000, delete all pairs in the copy group, and then register pairs in a consistency group when you re-create the pairs. Alternatively, delete some pairs so that the number of pairs decreases to 1,000 or less, perform a pair resynchronization operation, and then register the pairs in a consistency group when you re-create the pairs that you deleted.

Execution permission

Storage Administrator (Remote Copy)

Request line

```
POST base-URL/v1/objects/remote-mirror-copypairs/object-ID/actions/resync/
invoke
```

Request message**Object ID**

Specify the value of `remoteMirrorCopyPairId` that was obtained by the processing to get information about the remote copy pair. You can also specify the attributes and connect them with commas as follows:

```
remoteStorageDeviceId, copyGroupName, localDeviceGroupName,
remoteDeviceGroupName, copyPairName
```

| Attribute | Type | Description |
|------------------------------------|--------|---|
| <code>remoteStorageDeviceId</code> | string | (Required) Storage device ID of the remote storage system |
| <code>copyGroupName</code> | string | (Required) Copy group name Specify a name consisting of 1 to 31 characters. The name is case sensitive. |
| <code>localDeviceGroupName</code> | string | (Required) Device group name in the local storage system Specify a name consisting of 1 to 31 characters. The name is case sensitive. |
| <code>remoteDeviceGroupName</code> | string | (Required) Device group name in the remote storage system Specify a name consisting of 1 to 31 characters. The name is case sensitive. |
| <code>copyPairName</code> | string | (Required) Copy pair name Specify a name consisting of 1 to 31 characters. The name is case sensitive. |

Query parameters

None.

Body

The following is a coding example for simply resynchronizing pairs:

```
{
  "parameters": {
```

```

    "replicationType": "GAD"
  }
}

```

The following is a coding example for reversing and resynchronizing pairs by specifying the P-VOL:

```

{
  "parameters": {
    "replicationType": "GAD",
    "doSwapPvol": true
  }
}

```

| Attribute | Type | Description |
|-----------------|---------|---|
| replicationType | string | (Required) Specify the pair type. GAD: global-active device |
| doSwapSvol | boolean | (Optional) Specify the volume to be specified for a pair resynchronization operation. Use this attribute when the S-VOL side is used as the local storage system. <ul style="list-style-type: none"> ▪ <code>true</code>: Resynchronize pairs by specifying the S-VOL (swap resync). You can use this value if the pairs in the specified S-VOL are suspended. Reverse the P-VOL and the S-VOL, and then copy data of the new P-VOL to the new S-VOL. ▪ <code>false</code>: Resynchronize pairs by specifying the P-VOL. <p>If the value is not specified, <code>false</code> will be set.</p> <p>If this attribute is set to <code>true</code>, you cannot specify <code>true</code> for the <code>doSwapPvol</code> and <code>isConsistencyGroup</code> attributes.</p> |

| Attribute | Type | Description |
|--------------------|---------|---|
| doSwapPvol | boolean | <p>(Optional) Specify the volume to be specified for a pair resynchronization operation. Use this attribute when the P-VOL side is used as the local storage system.</p> <ul style="list-style-type: none"> ▪ <code>true</code>: Resynchronize pairs by specifying the P-VOL (swap resync). <p>You can use this value if the pairs in the specified P-VOL are suspended. Reverse the P-VOL and the S-VOL, and then copy data of the new P-VOL to the new S-VOL.</p> <ul style="list-style-type: none"> ▪ <code>false</code>: Resynchronize pairs by specifying the P-VOL. <p>If the value is not specified, <code>false</code> will be set.</p> <p>If this attribute is set to <code>true</code>, you cannot specify <code>true</code> for the <code>doSwapSvol</code> and <code>isConsistencyGroup</code> attributes.</p> |
| isConsistencyGroup | boolean | <p>(Optional) If the pair is not registered in a consistency group, you can specify the value as follows:</p> <ul style="list-style-type: none"> ▪ <code>true</code>: Registers the pair in a consistency group. # ▪ <code>false</code>: Leaves the pair as it is without registering it in a consistency group. <p>If the pair is already registered in a consistency group, you do not need to specify this attribute to maintain the registered state, regardless of the value specified for this attribute. Note that, if <code>false</code> is specified, registration of the consistency group cannot be canceled.</p> <p>To register the pair in a consistency group, you must also specify the <code>consistencyGroupId</code> attribute.</p> <p>Make sure that each copy group contains either only pairs that are registered to a consistency group or only pairs that are not registered to a consistency group. If a copy group includes both pairs that are registered in a consistency group and pairs that are not registered in a consistency group, pair operations by consistency group cannot be correctly performed.</p> <p>If you specify <code>true</code> for this attribute, you cannot specify the <code>doSwapSvol</code> and <code>doSwapPvol</code> attributes.</p> |
| consistencyGroupId | int | <p>(Optional) Specify the consistency group ID by using a decimal (base 10) number.</p> |

| Attribute | Type | Description |
|------------|--------|--|
| | | Be sure to specify this attribute when registering the pair in a consistency group. Unify the consistency group ID within the copy group. If a copy group includes a pair whose consistency group ID differs, pair operations by consistency group cannot be correctly performed. |
| fenceLevel | string | (Optional) Specify <code>NEVER</code> for the fence level. If you specify <code>true</code> for the <code>isConsistencyGroup</code> attribute, <code>NEVER</code> is automatically set. |
| copyPace | int | (Optional) Copy speed Specify a decimal (base 10) number in the range from 1 to 15 for the size of tracks to be copied. The larger the value you specify, the faster the copy speed. |

#: If the model of either or both of the storage systems is VSP E series, VSP G350, G370, G700, G900, VSP F350, F370, F700, F900, this value can be specified only if the number of pairs in the copy group is 1,000 or less.

Response message

Body

A job object is returned. For details on attributes other than `affectedResources`, see the description on job objects.

| Attribute | Description |
|--------------------------------|--|
| <code>affectedResources</code> | URL of the resynchronized global-active device pairs |

Action template

```
GET base-URL/v1/objects/remote-mirror-copypairs/object-ID/actions/resync
```

This action template returns only the specifiable attributes, depending on the following: the type of the copy pair specified for the object ID, and whether the volume in the local storage system is the primary volume or the secondary volume.

Status codes

The following table describes the meaning of the status code of the request for this operation. For details on other status codes, see the description on HTTP status codes.

| Status code | Message | Description |
|-------------|---------------------|--|
| 412 | Precondition Failed | This object indicates that operations on the specified pair cannot be performed. |

Coding example

To get an action template:

When the storage system of the P-VOL is specified:

```
curl -v -H "Accept: application/json" -H "Remote-Authorization:Session 10399a1ffce3489b9c3a823017462396" -H "Authorization:Session d7b673af189048468c5af9bcf3bbbbb6f" -X GET https://192.0.2.100/ConfigurationManager/v1/objects/remote-mirror-copypairs/886000123789,remoteCopyGroup,remoteCopyGroupP_,remoteCopyGroupS_,pair1/actions/resync
```

When the storage system of the S-VOL is specified:

```
curl -v -H "Accept: application/json" -H "Remote-Authorization:Session 10399a1ffce3489b9c3a823017462396" -H "Authorization:Session d7b673af189048468c5af9bcf3bbbbb6f" -X GET https://192.0.2.100/ConfigurationManager/v1/objects/remote-mirror-copypairs/886000123456,remoteCopyGroup,remoteCopyGroupS_,remoteCopyGroupP_,pair1/actions/resync
```

To run the request after getting an action template:

When the storage system of the P-VOL is specified:

```
curl -v -H "Accept: application/json" -H "Remote-Authorization:Session 10399a1ffce3489b9c3a823017462396" -H "Content-Type: application/json" -H "Authorization:Session d7b673af189048468c5af9bcf3bbbbb6f" -X POST --data-binary @./InputParameters.json https://192.0.2.100/ConfigurationManager/v1/objects/remote-mirror-copypairs/886000123789,remoteCopyGroup,remoteCopyGroupP_,remoteCopyGroupS_,pair1/actions/resync/invoke
```

When the storage system of the S-VOL is specified:

```
curl -v -H "Accept: application/json" -H "Remote-Authorization:Session 10399a1ffce3489b9c3a823017462396" -H "Content-Type: application/json" -H "Authorization:Session d7b673af189048468c5af9bcf3bbbbb6f" -X POST --data-binary @./InputParameters.json https://192.0.2.100/ConfigurationManager/v1/objects/remote-mirror-copypairs/886000123456,remoteCopyGroup,remoteCopyGroupS_,remoteCopyGroupP_,pair1/actions/resync/invoke
```

Chapter 13: Performing Volume Migration operations

This chapter describes how to use the REST API to perform Volume Migration operations.

Overview of Volume Migration

Volume Migration is used to move data on a volume to another volume within the storage system (including a volume on an external storage system). Moving data to another volume is called migration.

Use Volume Migration to perform migration in situations such as the following:

- When you want to migrate data from the old storage system when a new storage system is installed
- When you want to migrate data with a low frequency of I/O operations to an external storage system
- When you want to relocate data with a high frequency of I/O operations to a volume on a drive with a low usage rate or to a volume on a drive with high performance

The host can access data during migration. When migration is complete, the LDEV ID and the host I/O of the migration source volume are automatically swapped with those of the migration target volume. For this reason, the host can continue to access data after the migration by using the same path settings.

The following figures show the flow of data when migration is performed by using Volume Migration.

Before migration

I/O from the host is directed to the migration source volume. From the source volume and the target volume (the volume that was created for the purpose of migration), create a pair to be used for Volume Migration.

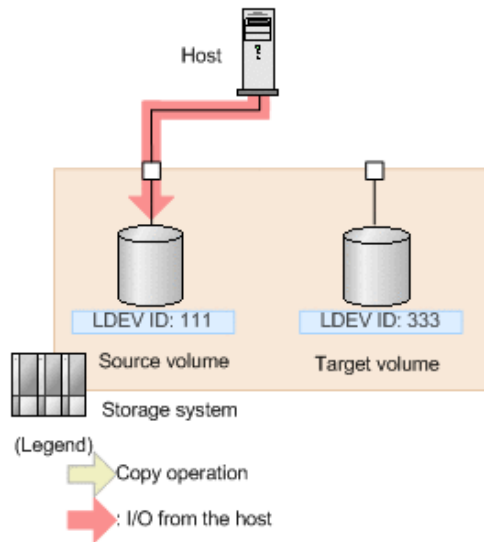

During migration

When migration is performed, data is copied from the source volume to the target volume. During migration, the host can read and write data online. If a write I/O operation from the host is performed while the data is being copied, only the differential data is copied to the target volume. Copy operations continue to be performed until all differential data has been copied.

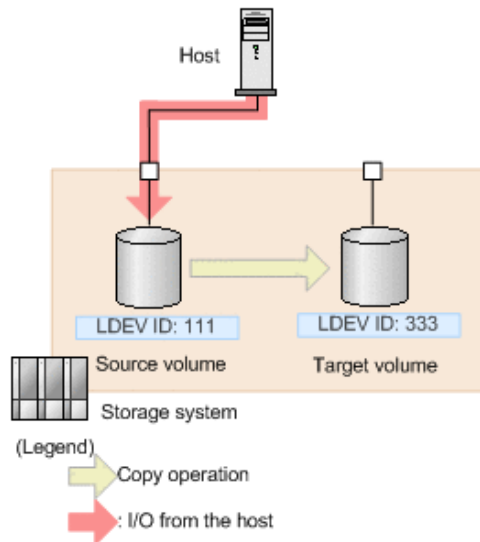

Note:

There is an upper limit to the number of copy operations that can be performed, and the upper limit varies depending on the capacity of the source volume. If differential data still exists after the upper limit for the number of copy operations is exceeded, migration will fail. In this case, reduce the load from the host, and then perform migration again. Use a value of 50 IOPS or less as a reference value for the update I/O operations from the host.

When migration is complete

After the data is copied and the data on the source volume and the data on the target volume are fully synchronized, the LDEV ID and the host I/O of the source volume are swapped with those of the target volume. From the host, the volume and the path settings are the same as before the migration. The actual data, however, has been migrated to the volume that was prepared for migration.

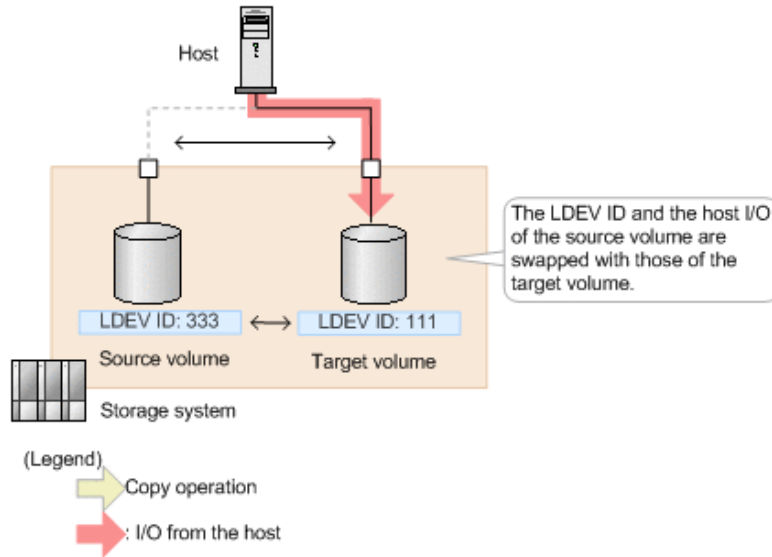
**Workflow for performing Volume Migration**

The following explains how to perform migrations by using Volume Migration, which is executed by the REST API.

Preparing for migration

Before starting migration, prepare a volume as the migration destination (target volume). You must set an LU path for the target volume.

The following figure shows the workflow.

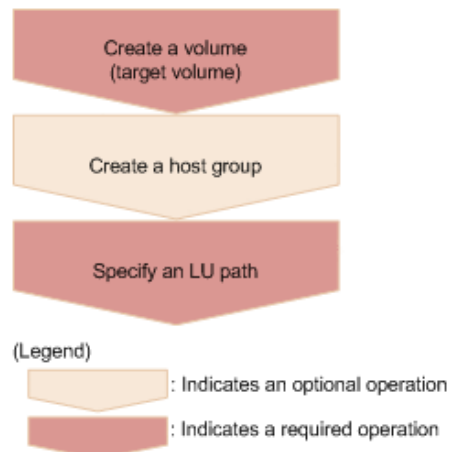

Creating volumes (target volumes)

Create target volumes to which data is to be migrated.

Creating a host group

Create a host group so that LU paths can be set for the target volumes. The host group does not need to be allocated to the host. You can use an existing host group, but it must not include the volumes to be migrated (source volumes).

Setting LU paths

Specify the host group that you created for the target volumes, and then set LU paths.

Migrating data

Create Volume Migration pairs by specifying the source volumes as the P-VOLs and the target volumes as the S-VOLs, and then copy the data. You can perform operations on copy pairs in units of copy groups. A copy group is a group made up of copy pairs. Each copy group consists of a device group that is made up of P-VOLs and a device group made up of S-VOLs.

The following figure shows the workflow.

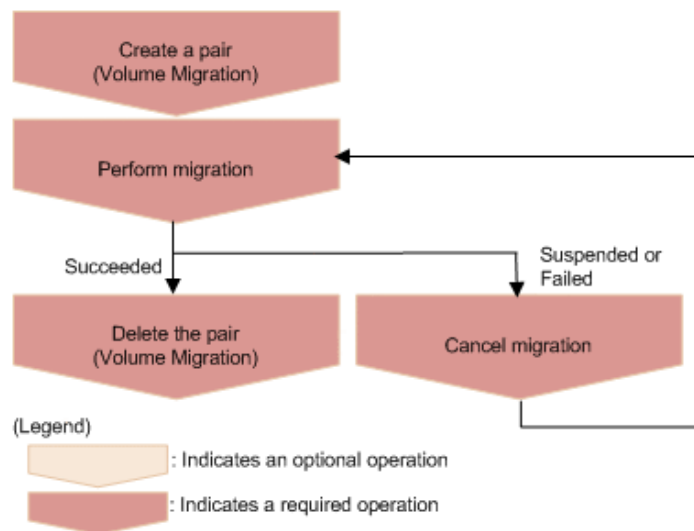
**Creating pairs (Volume Migration)**

Use the source volumes and the target volumes to create Volume Migration pairs. When a Volume Migration pair is created, the pair status is SMPL. Data is not copied until migration is performed.

Migrating data

Copy data from the source volumes to the target volumes in units of pairs or copy groups. When data copying is complete, the LDEV IDs and the path settings of the source volumes and the target volumes are switched, and the I/O from the host switches to the target volumes.

Deleting pairs (Volume Migration)

After the migration job is complete, if migration was successful, delete the pairs for migration.

Canceling migration

Cancel migration to stop the migration processing or if a migration job fails. When the migration of a pair is canceled, the pair status changes to SMPL, and you can then perform migration again.

Performing post-migration tasks

Delete the volumes and the host group that were created for migration.

The following figure shows the workflow.

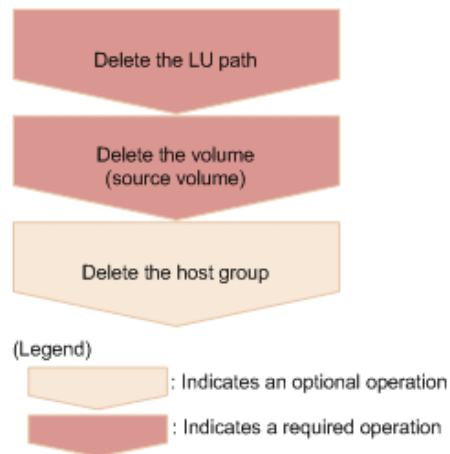

Deleting LU paths

Delete the LU paths that were set for the source volumes. Note that the path settings of source volumes and target volumes are switched when migration finishes. For this reason, be sure to delete the paths set for the host group that was created for volume migration (the host group that is not allocated to the host).

Deleting volumes (source volumes)

Delete the source volumes. Note that the LDEV IDs are switched when migration finishes. For this reason, when specifying the LDEV IDs of the volumes to be deleted, be sure to specify the LDEV IDs of the volumes that were created as the target volumes (volumes that do not receive I/O from the host).

Deleting the host group

If the host group to which the source volumes belong is no longer necessary, delete the host group.

Specifying Job-Mode-Wait-Configuration-Change in the request header

With respect to operations to perform or cancel migration, data copying might take a long time. As a result, the job status might not change to `Completed` and other jobs might become delayed if you execute multiple asynchronous processes at the same time. In such cases, specify `Job-Mode-Wait-Configuration-Change:NoWait` in the request header, so that the job status changes to `Completed` without waiting for data copying to finish, and the next job starts. In other words, data copying will continue even after the job execution ends. To check whether data copying has finished, check the status of the applicable pair, instead of checking the job status. For details about pair statuses, see the description of pair status transitions.

Pair status transitions (Volume Migration)

The following figure shows how pair statuses transition when certain pair operations are performed.

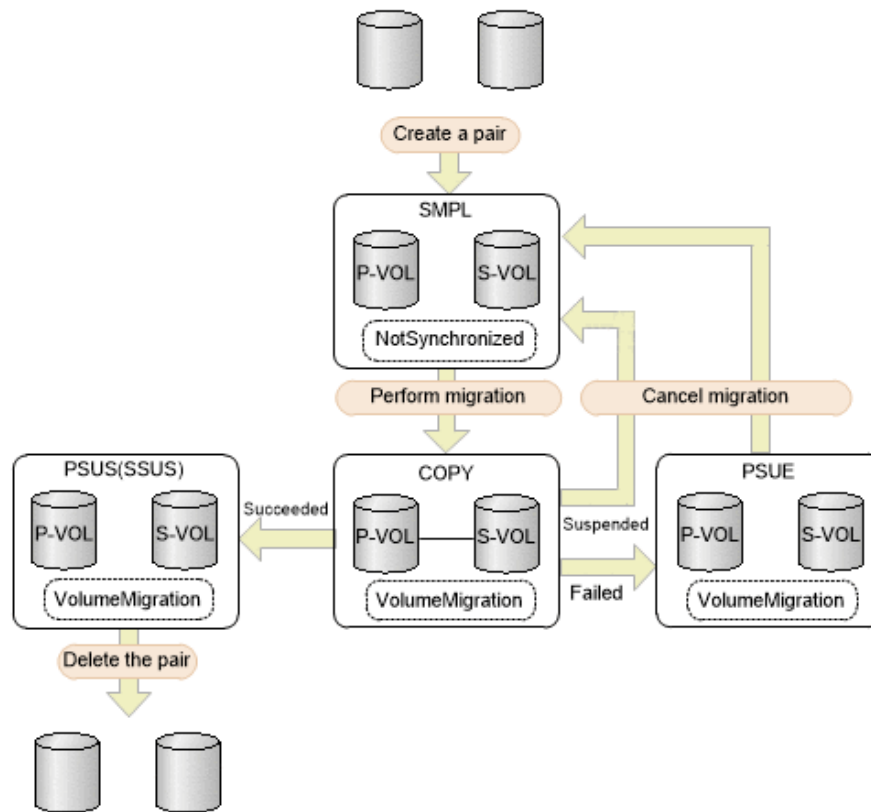

- (Legend)
- P-VOL: Primary volume
 - S-VOL: Secondary volume
 - : Indicates a pair operation performed from the REST API
 - : Indicates the pair status
 - : Indicates the copy mode

| Pair status | Copy mode | Description | Access to the P-VOL | Access to the S-VOL |
|-------------|-----------------|--|---------------------|---------------------|
| SMPL | NotSynchronized | Volume Migration can be performed. | R/W enabled | R/W enabled |
| COPY | VolumeMigration | The pair status is being migrated. | R/W enabled | - |
| PSUS | VolumeMigration | Migration is complete. (This value is output for the P-VOL.) | R/W enabled | R/W enabled |
| SSUS | VolumeMigration | Migration is complete. (This value is output for the S-VOL.) | R/W enabled | R/W enabled |
| PSUE | VolumeMigration | Migration was interrupted, or migration failed. | R/W enabled | R enabled |

Creating a pair to be used for Volume Migration

To perform migration by using the REST API, create a pair of volumes from the source volume (P-VOL) and the target volume (S-VOL). When the pair is created, the status of the pair is SMPL.

Execution permission

Storage Administrator (Provisioning) and Storage Administrator (Local Copy)

Request line

```
POST base-URL/v1/objects/local-clone-copypairs
```

Request message

Object ID

None.

Query parameters

None.

Body

```
{
  "copyGroupName": "vm-cg",
  "pvolDeviceGroupName": "dgp",
  "svolDeviceGroupName": "dgs",
```

```

"copyPairName": "pair",
"svolLdevId": 40970,
"pvolLdevId": 40960,
"replicationType": "SI",
"copyMode": "NotSynchronized",
"isNewGroupCreation": true
}

```

| Attribute | Type | Description |
|---------------------|---------|---|
| copyGroupName | string | (Required) Specify the copy group name. Value should not exceed 29 characters. The name is case sensitive. |
| isNewGroupCreation | boolean | (Required) Depending on the value, this attribute specifies whether to add a pair to a newly created copy group or to an existing copy group. Make sure that the Volume Migration pair is not added to a copy group that includes ShadowImage pairs. <ul style="list-style-type: none"> ▪ <code>true</code>: Adds the pair to a newly created copy group. ▪ <code>false</code>: Adds the pair to an existing copy group. |
| copyPairName | string | (Required) Specify the pair name. Value should not exceed 31 characters. The name is case sensitive. |
| copyMode | string | (Required) Copy mode Specify <code>NotSynchronized</code> . |
| replicationType | string | (Required) Specify <code>SI</code> . |
| pvolLdevId | int | (Required) Specify the LDEV number of the P-VOL (source volume) with a decimal (base 10) number. |
| svolLdevId | int | (Required) Specify the LDEV number of the S-VOL (target volume) with a decimal (base 10) number. |
| pvolDeviceGroupName | string | (Optional) Specify the device group name for the P-VOL. Value should not exceed 31 characters. The name is case sensitive. |

| Attribute | Type | Description |
|---------------------|--------|--|
| | | Specify a device group name that differs from the device group name for the S-VOL. In addition, to add a pair to an existing copy group, specify the device group name for an existing P-VOL. If this value is omitted, <i>copyGroupNameP_</i> is assumed. |
| svolDeviceGroupName | string | (Optional) Specify the device group name for the S-VOL. Value should not exceed 31 characters. The name is case sensitive. Specify a device group name that differs from the device group name for the P-VOL. To add a pair to an existing copy group, specify the device group name for an existing S-VOL. If this value is omitted, <i>copyGroupNameS_</i> is assumed. |

Response message

Body

A job object is returned. For details on attributes other than *affectedResources*, see the section explaining job objects.

| Attribute | Description |
|--------------------------|-------------------------|
| <i>affectedResources</i> | URL of the created pair |

Status codes

For details on the status codes of the request for this operation, see the description on HTTP status codes.

Coding example

```
curl -v -H "Accept: application/json" -H "Content-Type: application/json" -H "Authorization:Session d7b673af189048468c5af9bcf3b6666f" -X POST --data-binary @./InputParameters.json https://192.0.2.100/ConfigurationManager/v1/objects/local-clone-coppairs
```

Performing migration for an entire copy group

The following request performs migration to copy the data in the source volume (P-VOL) to the target volume (S-VOL) for the entire specified copy group. When the copy operation is complete, the host switches from accessing the target volume to accessing the source volume.



Note:

After copying the data by successfully executing the API request for performing migration, execute the API request for deleting a pair to change the pair status of the source volume and the target volume to SMPL.



Tip: We recommend specifying `Job-Mode-Wait-Configuration-Change:NoWait` in the request header of this API function. For details, see the description of the workflow for performing Volume Migration.

Execution permission

Storage Administrator (Provisioning)

Request line

```
POST base-URL/v1/objects/local-clone-copygroups/object-ID/actions/migrate/
invoke
```

Request message

Object ID

Specify the `localCloneCopygroupId` value obtained by getting the list of copy groups. You can also specify the following attributes and connect them with commas:

```
copyGroupName, pvolDeviceGroupName, svolDeviceGroupName
```

| Attribute | Type | Description |
|---------------------|--------|--|
| copyGroupName | string | (Required) Specify the copy group name. Value should not exceed 31 characters. The name is case sensitive. |
| pvolDeviceGroupName | string | (Required) Specify the P-VOL (source volume) device group name. Value should not exceed 31 characters. The name is case sensitive. |
| svolDeviceGroupName | string | (Required) Specify the S-VOL (target volume) device group name. Value should not exceed 31 characters. The name is case sensitive. |

Query parameters

None.

Body

None.

Response message**Body**

A job object is returned. See the description for the job object. `affectedResources` is not displayed for this API. To check whether the migration was successful, execute the API request for obtaining information about a copy group. The possible pair statuses are as follows:

- If the migration was successful: PSUS
- If the migration failed: PSUE

Action template

None.

Status codes

For details on the status codes of the API, see the description on HTTP status codes.

Coding example

```
curl -v -H "Accept: application/json" -H "Content-Type: application/json" -
H "Authorization:Session d7b673af189048468c5af9bcf3bbbb6f" -X POST -d ""
https://192.0.2.100/ConfigurationManager/v1/objects/local-clone-
copygroups/vm-cg,dgp,dgs/actions/migrate/invoke
```

Performing migration

The following request performs migration to copy the data of the source volume (P-VOL) to the target volume (S-VOL). When the copy operation is complete, the host switches from accessing the target volume to accessing the source volume.

**Note:**

After copying the data by successfully executing the API request for performing migration, execute the API request for deleting a pair to change the pair status of the source volume and the target volume to SMPL.



Tip: We recommend specifying `Job-Mode-Wait-Configuration-Change:NoWait` in the request header of this API function. For details, see the description of the workflow for performing Volume Migration.

Execution permission

Storage Administrator (Provisioning)

Request line

```
POST base-URL/v1/objects/local-clone-copypairs/object-ID/actions/migrate/
invoke
```

Request message**Object ID**

Specify the `localCloneCopypairId` value obtained by getting the pair information. You can also specify the following attributes and connect them with commas:

```
copyGroupName, pvolDeviceGroupName, svolDeviceGroupName, copyPairName
```

| Attribute | Type | Description |
|----------------------------------|--------|--|
| <code>copyGroupName</code> | string | (Required) Specify the copy group name. Value should not exceed 31 characters. The name is case sensitive. |
| <code>pvolDeviceGroupName</code> | string | (Required) Specify the P-VOL (source volume) device group name. Value should not exceed 31 characters. The name is case sensitive. |
| <code>svolDeviceGroupName</code> | string | (Required) Specify the S-VOL (target volume) device group name. Value should not exceed 31 characters. The name is case sensitive. |
| <code>copyPairName</code> | string | (Required) Specify the name of the pair. Value should not exceed 31 characters. The name is case sensitive. |

Query parameters

None.

Body

None.

Response message**Body**

A job object is returned. See the description for the job object. `affectedResources` is not displayed for this API. To check whether the migration was successful, execute the API request for obtaining information about a pair. The possible pair statuses are as follows:

- If the migration was successful: PSUS
- If the migration failed: PSUE

Action template

None.

Status codes

For details on the status codes of the request for this operation, see the description on HTTP status codes.

Coding example

```
curl -v -H "Accept: application/json" -H "Content-Type: application/json" -
H "Authorization:Session d7b673af189048468c5af9bcf3bbbb6f" -X POST -d ""
https://192.0.2.100/ConfigurationManager/v1/objects/local-clone-
coppairs/vm-cg,dgp,dgs,pl/actions/migrate/invoke
```

Getting a list of copy groups (Volume Migration)

The following request gets information about the copy groups containing pairs in the storage system.

**Important:**

If the copy group name or device group name contains spaces, the copy group information cannot be obtained.

Execution permission

Storage Administrator (View Only)

Request line

```
GET base-URL/v1/objects/local-clone-copygroups
```

Request message**Object ID**

None.

Query parameters

| Parameter | Type | Description |
|----------------|--------|--|
| detailInfoType | string | <p>(Optional) Type of detailed information to be obtained</p> <ul style="list-style-type: none"> pair <p>Specify this parameter to get detailed information about the pairs in each copy group in addition to a list of copy groups.</p> <p>You can specify this item for VSP 5000 series.</p> <p>To get up-to-date information, you must run the API request that refreshes the storage system's cache before running this request. For details, see "Updating the cache of storage system configuration information".</p> |

Body

None.

Response message**Body**

```

{
  "data": [
    {
      "copyGroupName": "localCopyGroup1",
      "pvolDeviceGroupName": "localCopyGroup1P_",
      "svolDeviceGroupName": "localCopyGroup1S_",
      "localCloneCopygroupId": "localCopyGroup1,localCopyGroup1P_,
localCopyGroup1S_"
    },
    {
      "copyGroupName": "localCopyGroup2",
      "pvolDeviceGroupName": "localCopyGroupppvol",
      "svolDeviceGroupName": "localCopyGroupsvol",
      "localCloneCopygroupId": "localCopyGroup2,localCopyGroupppvol,
localCopyGroupsvol"
    }
  ]
}

```

| Attribute | Type | Description |
|-----------------------|--------|---|
| copyGroupName | string | Copy group name |
| pvolDeviceGroupName | string | Device group name for the P-VOL (source volume) |
| svolDeviceGroupName | string | Device group name for the S-VOL (target volume) |
| localCloneCopygroupId | string | Object ID of the copy group that contains a pair The following attributes are output, separated by commas: <ul style="list-style-type: none"> ▪ copyGroupName ▪ pvolDeviceGroupName ▪ svolDeviceGroupName |

If you run the request with `pair` specified for the query parameter `detailInfoType`, you can get the following information, in addition to a list of copy groups:

| Attribute | Type | Description |
|-----------|----------|--|
| copyPairs | object[] | The following attributes about the pairs included in the copy group: If information cannot be acquired, the attributes under the <code>copyPairs</code> object are not output. <ul style="list-style-type: none"> ▪ copyGroupName (string) Copy group name ▪ copyPairName (string) Pair name ▪ replicationType (string) Pair type Outputs SI . |

| Attribute | Type | Description |
|-----------|------|---|
| | | <ul style="list-style-type: none"> ▪ copyMode (string) Copy mode <ul style="list-style-type: none"> ▪ NotSynchronized: Pairs created for the purpose of performing migration ▪ VolumeMigration: Pairs for which migration is in progress or for which migration is complete <p>Other values are displayed for pairs that do not meet either of the preceding conditions.</p> ▪ pvolDevId (int) LDEV number of the P-VOL ▪ svolDevId (int) LDEV number of the S-VOL ▪ pvolStatus (string) Pair volume status of the P-VOL For details, see the section describing the pair status (Volume Migration). This attribute is not output if no information can be obtained. ▪ svolStatus (string) Pair volume status of the S-VOL For details, see the section describing the pair status (Volume Migration). This attribute is not output if no information can be obtained. ▪ localCloneCoppairId (string) Object ID of the pair ▪ pvolMuNumber (int) MU number of the P-VOL |

Status codes

For details on the status codes of the request for this operation, see the section explaining HTTP status codes.

Coding example

```
curl -v -H "Accept: application/json" -H "Authorization:Session
d7b673af189048468c5af9bcf3bbbbb6f" -X GET https://192.0.2.100/
ConfigurationManager/v1/objects/local-clone-copygroups
```

Getting information about a specific copy group (Volume Migration)

The following request acquires information about the specified copy group and about the pairs within that copy group that are to be used for Volume Migration. This operation allows you to check the status of the pairs and to acquire their pair configuration information.

**Important:**

- If the target copy group contains a pair that was created or deleted by using another REST API server or software other than the REST API, correct information about that pair might not be obtained. To obtain the most recent information about such pairs, use the API for obtaining a list of pairs.
- If the copy group name, device group name, or copy pair name contains spaces, the information cannot be obtained.

Execution permission

Storage Administrator (View Only)

Request line

```
GET base-URL/v1/objects/local-clone-copygroups/object-ID
```

Request message**Object ID**

Specify the `localCloneCopygroupId` value obtained by getting the list of copy groups. You can also specify the following attributes and connect them with commas:

```
copyGroupName, pvolDeviceGroupName, svolDeviceGroupName
```

| Attribute | Type | Description |
|---------------|--------|--|
| copyGroupName | string | (Required) Specify the copy group name. Value should not exceed 31 characters. The name is case sensitive. |

| Attribute | Type | Description |
|---------------------|--------|--|
| pvolDeviceGroupName | string | (Required) Specifies the device group name for the P-VOL (source volume). Value should not exceed 31 characters. The name is case sensitive. |
| svolDeviceGroupName | string | (Required) Specifies the device group name for the S-VOL (target volume). Value should not exceed 31 characters. The name is case sensitive. |

Query parameters

None.

Body

None.

Response message**Body**

```
{
  "localCloneCopygroupId" : "vm-cg,dgp,dgs",
  "copyGroupName" : "vm-cg",
  "pvolDeviceGroupName" : "dgp",
  "svolDeviceGroupName" : "dgs",
  "copyPairs" : [ {
    "localCloneCopypairId" : "vm-cg,dgp,dgs,p0",
    "copyGroupName" : "vm-cg",
    "copyPairName" : "p0",
    "replicationType" : "SI",
    "copyMode" : "NotSynchronized",
    "pvolLdevId" : 40970,
    "pvolStatus" : "SMPL",
    "svolLdevId" : 40960,
    "svolStatus" : "SMPL",
    "pvolMuNumber" : 0,
    "pvolProcessingStatus" : "N",
    "svolProcessingStatus" : "N"
  }, {
    "localCloneCopypairId" : "vm-cg,dgp,dgs,p1",
    "copyGroupName" : "vm-cg",
    "copyPairName" : "p1",
    "replicationType" : "SI",
    "copyMode" : "NotSynchronized",
    "pvolLdevId" : 40971,
    "pvolStatus" : "SMPL",
    "svolLdevId" : 40961,
  }
}
```

Getting information about a specific copy group (Volume Migration)

```

"svolStatus" : "SMPL",
"pvolMuNumber" : 0,
"pvolProcessingStatus": "N",
"svolProcessingStatus": "N"
} ]
}

```

| Attribute | Type | Description |
|-----------------------|----------|---|
| copyGroupName | string | Copy group name |
| pvolDeviceGroupName | string | Device group name for the P-VOL |
| svolDeviceGroupName | string | Device group name for the S-VOL |
| localCloneCopygroupId | string | Object ID of the copy group that contains a pair The following attributes are output, separated by commas: <ul style="list-style-type: none"> ▪ copyGroupName ▪ pvolDeviceGroupName ▪ svolDeviceGroupName |
| copyPairs | object[] | The following attributes about the pairs included in the copy group: <ul style="list-style-type: none"> ▪ copyGroupName (string) Copy group name ▪ copyPairName (string) Pair name ▪ replicationType (string) Pair type Outputs SI . |

| Attribute | Type | Description |
|-----------|------|--|
| | | <ul style="list-style-type: none"> <li data-bbox="813 254 1409 541"> ▪ copyMode (string) Copy mode <ul style="list-style-type: none"> <li data-bbox="850 352 1386 422">▪ NotSynchronized: Pairs created for the purpose of performing migration <li data-bbox="850 436 1321 541">▪ VolumeMigration: Pairs for which migration is in progress or for which migration is complete Other values are displayed for pairs that do not meet either of the preceding conditions. <li data-bbox="813 659 1409 827"> ▪ copyProgressRate (int) Copy progress rate (%) <p>This attribute is not output if no information can be obtained.</p> <li data-bbox="813 863 1182 940"> ▪ pvolDevId (int) LDEV number of the P-VOL <li data-bbox="813 976 1182 1054"> ▪ svolDevId (int) LDEV number of the S-VOL <li data-bbox="813 1089 1409 1341"> ▪ pvolStatus (string) Pair volume status of the P-VOL <p>For details, see the section describing the pair status (Volume Migration).</p> <p>This attribute is not output if no information can be obtained.</p> <li data-bbox="813 1377 1409 1629"> ▪ svolStatus (string) Pair volume status of the S-VOL <p>For details, see the section describing the pair status (Volume Migration).</p> <p>This attribute is not output if no information can be obtained.</p> <li data-bbox="813 1665 1091 1743"> ▪ localCloneCoppairId (string) Object ID of the pair |

| Attribute | Type | Description |
|-----------|------|---|
| | | <ul style="list-style-type: none"> ▪ pvolMuNumber (int) MU number of the P-VOL ▪ pvolProcessingStatus (string) Processing status of the pair <ul style="list-style-type: none"> • E: The expansion processing is in progress. • N: The expansion processing is not in progress. <p>The same value as that of <code>svolProcessingStatus</code> is output.</p> ▪ svolProcessingStatus (string) Processing status of the pair <ul style="list-style-type: none"> • E: The expansion processing is in progress. • N: The expansion processing is not in progress. <p>The same value as that of <code>pvolProcessingStatus</code> is output.</p> |

Status codes

The following table describes the meaning of the status code of the request for this operation. For details on other status codes, see the section explaining HTTP status codes.

| Status code | Message | Description |
|-------------|-----------|---|
| 404 | Not Found | No copy group can be obtained, or no pair was included in the copy group that was obtained. |

Coding example

```
curl -v -H "Accept: application/json" -H "Content-Type: application/json" -
H "Authorization:Session d7b673af189048468c5af9bcf3b6bb6f" -X GET
https://192.0.2.100/ConfigurationManager/v1/objects/local-clone-copypairs?
localCloneCopyGroupId=vm-cg,dgp,dgs
```

Getting a list of pairs (Volume Migration)

The following request obtains information about the pairs in a copy group specified by using query parameters. You can also update the pair information when you obtain information about pairs.



Important:

- If the target copy group contains a pair that was created or deleted by using another REST API server or software other than the REST API, information about that pair might not be obtained. To obtain the most recent information about such pairs, run the API with `refresh=true` specified for the query parameter. Note that such processing takes time because the information about the pairs in the specified copy group is updated, and then information is obtained.
- If the copy group name, device group name, or copy pair name contains spaces, the information cannot be obtained.

Execution permission

Storage Administrator (View Only)

Request line

```
GET base-URL/v1/objects/local-clone-copypairs
```

Request message

Object ID

None.

Query parameters

| Parameter | Type | Filter condition |
|-----------------------|--------|---|
| localCloneCopyGroupId | string | (Required) Object ID of the copy group that contains a pair |

| Parameter | Type | Filter condition |
|----------------------|---------|--|
| | | <p>Specify the <code>localCloneCopygroupId</code> value obtained by getting the list of copy groups. You can also specify the following attributes, separated by a comma:</p> <p><i>copyGroupName,pvolDeviceGroupName,svolDeviceGroupName</i></p> <ul style="list-style-type: none"> ▪ <code>copyGroupName</code> (string) Copy group name Value should not exceed 31 characters. ▪ <code>pvolDeviceGroupName</code> (string) Device group name for the P-VOL (source volume) Value should not exceed 31 characters. ▪ <code>svolDeviceGroupName</code> (string) Device group name for the S-VOL (target volume) Value should not exceed 31 characters. |
| <code>refresh</code> | boolean | <p>(Optional) Whether to update the pair information to the most recent:</p> <ul style="list-style-type: none"> ▪ <code>true</code>: Pair information will be updated. ▪ <code>false</code>: Pair information will not be updated. <p>If you specify <code>true</code>, processing takes time because the information about the pairs in the specified copy group is updated and then information is obtained. If this parameter is omitted, <code>false</code> is assumed.</p> |

Body

None.

Response message**Body**

Information about the pairs in the specified copy group is obtained in a list. For details about the response body, see the section describing the API for obtaining information about a specific pair.

Status codes

For details on the status codes of the request for this operation, see the section explaining HTTP status codes.

Coding example

```
curl -v -H "Accept: application/json" -H "Authorization:Session
d7b673af189048468c5af9bcf3bbbbb6f" -X GET "https://192.0.2.100/
ConfigurationManager/v1/objects/local-clone-coppairs?
localCloneCopyGroupId=localCopyGroup1,localCopyGroup1P_,
localCopyGroup1S_&refresh=true"
```

Getting information about a specific pair (Volume Migration)

The following request gets information about specific pairs to be used for Volume Migration. This operation allows you to obtain information about the status and the configuration information of the pairs.

**Important:**

- If the target pair was created or deleted by using another REST API server or software other than the REST API, correct information about that pair might not be obtained. To obtain the most recent information about the pairs, use the API for obtaining a list of pairs.
- If the copy group name, device group name, or pair name contains spaces, information cannot be obtained.

Execution permission

Storage Administrator (View Only)

Request line

```
GET base-URL/v1/objects/local-clone-coppairs/object-ID
```

Request message**Object ID**

Specify the `localCloneCopypairId` value obtained by getting the pair information. You can also specify the following attributes and connect them with commas:

```
copyGroupName,pvolDeviceGroupName,svolDeviceGroupName,copyPairName
```

| Attribute | Type | Description |
|---------------------|--------|--|
| copyGroupName | string | (Required) Specify the copy group name. Value should not exceed 31 characters. The name is case sensitive. |
| pvolDeviceGroupName | string | (Required) Specify the P-VOL (source volume) device group name. Value should not exceed 31 characters. The name is case sensitive. |
| svolDeviceGroupName | string | (Required) Specify the S-VOL (target volume) device group name. Value should not exceed 31 characters. The name is case sensitive. |
| copyPairName | string | (Required) Specify the name of the pair. Value should not exceed 31 characters. The name is case sensitive. |

Query parameters

None.

Body

None.

Response message**Body**

```
{
  "localCloneCopypairId" : "vm-cg,dgp,dgs,p1",
  "copyGroupName" : "vm-cg",
  "copyPairName" : "p1",
  "replicationType" : "SI",
  "copyMode" : "NotSynchronized",
  "pvolLdevId" : 40971,
  "pvolStatus" : "SMPL",
  "svolLdevId" : 40961,
  "svolStatus" : "SMPL",
  "pvolMuNumber" : 0,
  "pvolProcessingStatus": "N",
  "svolProcessingStatus": "N"
}
```

| Attribute | Type | Description |
|---------------|--------|-----------------|
| copyGroupName | string | Copy group name |

| Attribute | Type | Description |
|----------------------|--------|---|
| copyPairName | string | Pair name |
| replicationType | string | Pair type Outputs SI |
| copyMode | string | Copy mode <ul style="list-style-type: none"> ▪ NotSynchronized: Pairs created to be used for migration ▪ VolumeMigration: Pairs for which migration is being performed or complete Other values are displayed for pairs other than the above. |
| copyProgressRate | int | Copy progress rate (%) This attribute is not output if no information can be obtained. |
| pvolLdevId | int | LDEV number of the P-VOL |
| svolLdevId | int | LDEV number of the S-VOL |
| pvolStatus | string | Pair volume status of the P-VOL For details, see the section describing the pair status (Volume Migration). This attribute is not output if no information can be obtained. |
| svolStatus | string | Pair volume status of the S-VOL For details, see the section describing the pair status (Volume Migration). This attribute is not output if no information can be obtained. |
| localCloneCopypairId | string | Object ID of the pair |
| pvolMuNumber | int | MU number of the P-VOL |
| pvolProcessingStatus | string | Processing status of the pair <ul style="list-style-type: none"> ▪ E: The expansion processing is in progress. ▪ N: The expansion processing is not in progress. The same value as that of <code>svolProcessingStatus</code> is output. |

| Attribute | Type | Description |
|----------------------|--------|---|
| svolProcessingStatus | string | Processing status of the pair <ul style="list-style-type: none"> ▪ E: The expansion processing is in progress. ▪ N: The expansion processing is not in progress. The same value as that of <code>pvolProcessingStatus</code> is output. |

Status codes

For details on the status codes of the request for this operation, see the section explaining HTTP status codes.

Coding example

```
curl -v -H "Accept: application/json" -H "Content-Type: application/json" -
H "Authorization:Session d7b673af189048468c5af9bcf3bbbb6f" -X GET
https://192.0.2.100/ConfigurationManager/v1/objects/local-clone-
coppairs/vm-cg,dgp,dgs,pl
```

Deleting a pair (Volume Migration)

The following request deletes the specified pair. If there is no pair in the copy group, the copy group and the device group that make up the copy group are also deleted.

Execution permission

Storage Administrator (Provisioning) and Storage Administrator (Local Copy)

Request line

```
DELETE base-URL/v1/objects/local-clone-coppairs/object-ID
```

Request message

Object ID

Specify the `localCloneCoppairId` value obtained by getting the pair information. You can also specify the following attributes and connect them with commas:

```
copyGroupName,pvolDeviceGroupName,svolDeviceGroupName,copyPairName
```

| Attribute | Type | Description |
|---------------------|--------|--|
| copyGroupName | string | (Required) Specify the copy group name. Value should not exceed 31 characters. The name is case sensitive. |
| pvolDeviceGroupName | string | (Required) Specify the P-VOL (source volume) device group name. Value should not exceed 31 characters. The name is case sensitive. |
| svolDeviceGroupName | string | (Required) Specify the S-VOL (target volume) device group name. Value should not exceed 31 characters. The name is case sensitive. |
| copyPairName | string | (Required) Specify the name of the pair. Value should not exceed 31 characters. The name is case sensitive. |

Query parameters

None.

Body

None.

Response message**Body**

A job object is returned. For details on attributes other than affectedResources, see the section explaining job objects.

| Attribute | Description |
|-------------------|-------------------------|
| affectedResources | URL of the deleted pair |

Status codes

For details on the status codes of the request for this operation, see the description on HTTP status codes.

Coding example

```
curl -v -H "Accept: application/json" -H "Authorization:Session
d7b673af189048468c5af9bcf3bbbb6f" -X DELETE https://192.0.2.100/
ConfigurationManager/v1/objects/local-clone-coppairs/localCopyGroup1,
localCopyGroup1P_,localCopyGroup1S_,pair1
```

Deleting a copy group (Volume Migration)

The following request deletes pairs by using the specified copy group. When the pairs are all deleted, the device groups are also deleted.

Execution permission

Storage Administrator (Provisioning) and Storage Administrator (Local Copy)

Request line

```
DELETE base-URL/v1/objects/local-clone-copygroups/object-ID
```

Request message

Object ID

Specify the `localCloneCopygroupId` value obtained by getting the list of copy groups. You can also specify the following attributes and connect them with commas:

```
copyGroupName,pvolDeviceGroupName,svolDeviceGroupName
```

| Attribute | Type | Description |
|----------------------------------|--------|--|
| <code>copyGroupName</code> | string | (Required) Specify the copy group name. Value should not exceed 31 characters. The name is case sensitive. |
| <code>pvolDeviceGroupName</code> | string | (Required) Specify the P-VOL (source volume) device group name. Value should not exceed 31 characters. The name is case sensitive. |
| <code>svolDeviceGroupName</code> | string | (Required) Specify the S-VOL (target volume) device group name. Value should not exceed 31 characters. The name is case sensitive. |

Query parameters

None.

Body

None.

Response message

Body

A job object is returned. For details on attributes other than `affectedResources`, see the section explaining job objects.

| Attribute | Description |
|-------------------|-------------------------------|
| affectedResources | URL of the deleted copy group |

Coding example

```
curl -v -H "Accept: application/json" -H "Content-Type: application/json" -H "Authorization:Session d7b673af189048468c5af9bcf3bbbbb6f" -X DELETE --data-binary @./InputParameters.json https://192.0.2.100/ConfigurationManager/v1/objects/local-clone-copygroups/localCopyGroup1,localCopyGroup1P_,localCopyGroup1S_
```

When forcibly deleting a copy group

When a copy group cannot be deleted because the device group in a local storage system remains or because the configuration is not normal, you can forcibly delete the copy group by specifying the `forceDelete` attribute for the request body. The following shows a coding example of using the `forceDelete` attribute:

```
{
  "forceDelete" : true
}
```

| Attribute | Type | Description |
|-------------|---------|--|
| forceDelete | boolean | (Optional) Specify whether to delete the copy group forcibly. <ul style="list-style-type: none"> ▪ <code>true</code>: Forcibly delete the copy group. ▪ <code>false</code>: Do not forcibly delete the copy group. When the attribute is omitted, <code>false</code> is assumed. |

Canceling migration for an entire copy group

The following request cancels migration of the pairs in a specified copy group. You can use this request if you want to cancel a migration that is in progress, or if an attempted migration fails. If migration is canceled, the status of the pairs included in the target copy group reverts to SMPL.

Execution permission

Storage Administrator (Local Copy)

Request line

```
POST base-URL/v1/objects/local-clone-copygroups/object-ID/actions/split/
invoke
```

Request message**Object ID**

Specify the `localCloneCopygroupId` value obtained by getting the list of copy groups. You can also specify the following attributes and connect them with commas:

```
copyGroupName, pvolDeviceGroupName, svolDeviceGroupName
```

| Attribute | Type | Description |
|----------------------------------|--------|--|
| <code>copyGroupName</code> | string | (Required) Specify the copy group name. Value should not exceed 31 characters. The name is case sensitive. |
| <code>pvolDeviceGroupName</code> | string | (Required) Specify the P-VOL (source volume) device group name. Value should not exceed 31 characters. The name is case sensitive. |
| <code>svolDeviceGroupName</code> | string | (Required) Specify the S-VOL (target volume) device group name. Value should not exceed 31 characters. The name is case sensitive. |

Query parameters

None.

Body

```
{
  "parameters":{
    "forceSplit": true
  }
}
```

| Attribute | Type | Description |
|-------------------------|---------|---|
| <code>forceSplit</code> | boolean | (Optional) Specify whether to cancel migration. <ul style="list-style-type: none"> ▪ <code>true</code>: Cancel migration. ▪ <code>false</code>: Do not cancel migration. If this attribute is omitted, <code>false</code> is assumed. |

Response message**Body**

A job object is returned. For details on attributes other than `affectedResources`, see the section explaining job objects.

| Attribute | Description |
|--------------------------------|--|
| <code>affectedResources</code> | URL of the copy group for which migration was canceled |

Status codes

For details on the status codes of the request for this operation, see the description on HTTP status codes.

Coding example

```
curl -v -H "Accept: application/json" -H "Content-Type: application/json" -
H "Authorization:Session d7b673af189048468c5af9bcf3bbbb6f" -X POST --data-
binary @./InputParameters.json https://192.0.2.100/ConfigurationManager/v1/
objects/local-clone-copygroups/vm-cg,dgp,dgs/actions/split/invoke
```

Canceling migration

The following request cancels migration of the specified pair. You can use this request if you want to cancel a migration that is in progress, or if an attempted migration fails. If migration is canceled, the status of the pair reverts to SMPL.

Execution permission

Storage Administrator (Local Copy)

Request line

```
POST base-URL/v1/objects/local-clone-copypairs/object-ID/actions/split/
invoke
```

Request message**Object ID**

Specify the `localCloneCopypairId` value obtained by getting the pair information. You can also specify the following attributes and connect them with commas:

```
copyGroupName, pvolDeviceGroupName, svolDeviceGroupName, copyPairName
```

| Attribute | Type | Description |
|---------------------|--------|--|
| copyGroupName | string | (Required) Specify the copy group name. Value should not exceed 31 characters. The name is case sensitive. |
| pvolDeviceGroupName | string | (Required) Specify the P-VOL (source volume) device group name. Value should not exceed 31 characters. The name is case sensitive. |
| svolDeviceGroupName | string | (Required) Specify the S-VOL (target volume) device group name. Value should not exceed 31 characters. The name is case sensitive. |
| copyPairName | string | (Required) Specify the name of the pair. Value should not exceed 31 characters. The name is case sensitive. |

Query parameters

None.

Body

```
{
  "parameters":{
    "forceSplit": true
  }
}
```

| Attribute | Type | Description |
|------------|---------|---|
| forceSplit | boolean | (Optional) Specify whether to cancel migration. <ul style="list-style-type: none"> ▪ <code>true</code>: Cancel migration. ▪ <code>false</code>: Do not cancel migration. If this attribute is omitted, <code>false</code> is assumed. |

Response message**Body**

A job object is returned. For details on attributes other than `affectedResources`, see the section explaining job objects.

| Attribute | Description |
|-------------------|--|
| affectedResources | URL of the pair for which migration was canceled |

Status codes

For details on the status codes of the request for this operation, see the description on HTTP status codes.

Coding example

```
curl -v -H "Accept: application/json" -H "Content-Type: application/json" -H "Authorization:Session d7b673af189048468c5af9bcf3bbbb6f" -X POST --data-binary @./InputParameters.json https://192.0.2.100/ConfigurationManager/v1/objects/local-clone-copypairs/vm-cg,dgp,dgs,p1/actions/split/invoke
```

Chapter 14: Performing Universal Volume Manager operations

This chapter describes how to use the REST API to perform Universal Volume Manager operations.

Overview of Universal Volume Manager

Universal Volume Manager is a function that virtualizes storage devices and enables different models of storage systems to be used as one storage system.

To use volumes on an external storage system as external volumes, use a cable to connect the external connection port of the local storage system and the port of the external storage system, and then allocate (map) the volumes of the external storage system to the local storage system.

External volumes are used in situations such as the following:

- When you want to back up data in the volumes on the local storage system to the external storage system
- When you want to allocate an external volume to a host when the host issues a request for a volume to be used for storing data
- When you want to migrate data from the old storage system (external storage system) when a new storage system is installed

To discontinue the use of an external storage system that has become necessary, unmap the volumes of the unnecessary external storage system.

For details about the functions of Universal Volume Manager and related notes, see the *Hitachi Universal Volume Manager User Guide*.

The following figure shows the system configuration for using Universal Volume Manager, and the components of that configuration.

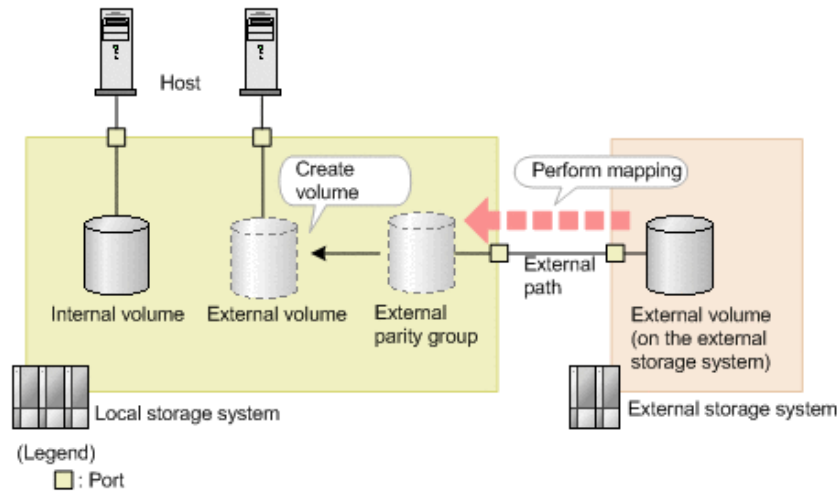

Local storage system

The local storage system receives requests from the REST API client.

External storage system

The external storage system is connected to the local storage system via external paths.

External path

An external path is a route by which the external connection port of the local storage system and the port of the external storage system are connected. You can set multiple routes as external paths. A group consisting of multiple external volumes that use the same external path is called an external path group.

External parity group

An external parity group is used to manage external volumes on the local storage system. Although an external parity group does not include parity information, it is managed in the same way as a parity group is managed. By registering external volumes on the external storage system in the external parity group, you can use the external volume from the local storage system.

External volume

You can enable volumes on an external storage system to be used from the host by creating external volumes from the external parity group. You can use the external volumes in the same way as other volumes on the local storage system.



Tip:

The mapped volumes on the external storage system are also called external volumes. When these mapped volumes need to be distinguished from the external volumes that are used on the local storage system, the mapped volumes will be referred to as "external volumes on the external storage system".

! **Important:**

If you are using the REST API, Storage Advisor Embedded, or CCI, attempts to perform multiple, concurrent executions of the following operations on external volumes might fail or produce incorrect results.

- Getting a list of ports on an external storage system
- Getting a list of the LUs of ports on an external storage system
- Getting information about the iSCSI targets of ports on an external storage system
- Performing a test to log in to an iSCSI target of an external storage system registered to the port of the local storage system

We recommend that you do not perform multiple, concurrent executions of these operations. For details about the problems that might occur if you perform multiple, concurrent executions of these operations and how to resolve these problems, see the note on the number of concurrent executions of operations on external volumes in the *Hitachi Universal Volume Manager User Guide*.

Workflow for Universal Volume Manager

This section describes the workflow in the REST API for using Universal Volume Manager to virtualize and use external storage system resources.



Note: For the REST API, if the virtual port mode of the local storage system is enabled, the virtual port ID is assumed to be 0. If the virtual port mode is enabled, use CCI to perform operations on ports.

Using external volumes

Create external volumes by mapping volumes of the external storage system that is connected to the port of the local storage system.

**Important:**

For storage systems of the VSP 5000 series, if the port on the local storage system is a target port, you need to change that port on the local storage system to a bidirectional port.

The workflow is shown in the following diagram.

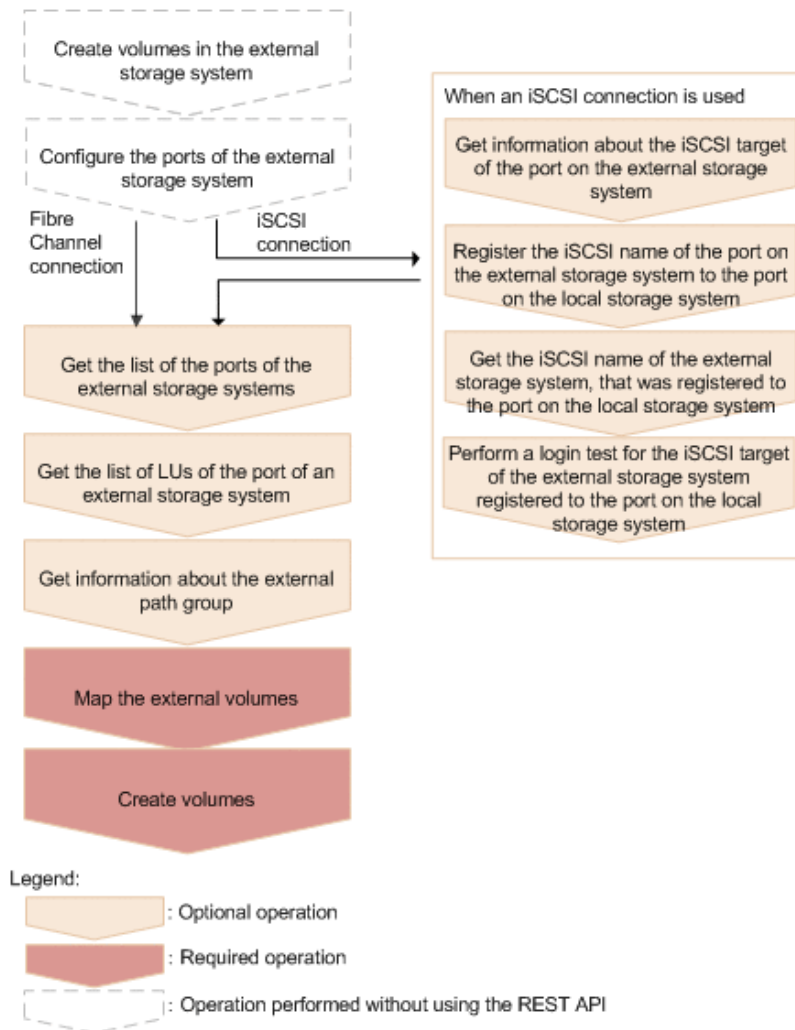

Create volumes in the external storage system

Create volumes in the external storage system. If the external storage system supports the REST API, you can use the REST API on the external storage system to create volumes.

Configure the ports of the external storage system

Configure the ports of the external storage system and the system options. For details on how to configure the ports and options, see the manual for the external storage system that you are using.

(for iSCSI) Get information about the iSCSI target of the port on the external storage system

If the external storage system is connected via an iSCSI connection, retrieve information about the iSCSI target of the port on the external storage system.

(for iSCSI) Register the iSCSI name of the port on the external storage system to the port on the local storage system

If the external storage system is connected via an iSCSI connection, register the retrieved iSCSI name of the port on the external storage system to the port on the local storage system.

After registering the iSCSI name, use the API request for performing a login test make sure that you can successfully log in.

(for iSCSI) Get the iSCSI name of the external storage system, that was registered to the port on the local storage system

If the external storage system is connected via an iSCSI connection, get the iSCSI name of the port on the external storage system, that was registered to the port on the local storage system.

(for iSCSI) Perform a login test for the iSCSI target of the external storage system, that was registered to the port of the local storage system

If the external storage system is connected via an iSCSI connection, test whether you can log in to the iSCSI target of the external storage system by using the retrieved iSCSI name.

If you cannot log in, revise the settings so that you can log in, or delete the iSCSI target. If you do not delete iSCSI targets that cannot be used to log in, when you retrieve information about iSCSI targets of the port on the external storage system, there will be an increased load on the network or external storage system and information might not be retrieved successfully.

Get the list of the ports of the external storage systems

Get information about the ports of the external storage systems that are connected. The obtained information will be used to map external volumes.

Get the list of LUs defined for the port on the external storage system

Get information about the LUs that are defined for the ports of the connected external storage system. The obtained information will be used to map external volumes.

Get information about the external path group

To use an existing external path group to perform mapping, get information about the external path group and check the path group ID.

When an iSCSI connection is used and the model of the local storage system is VSP E series, VSP G350, G370, G700, G900, VSP F350, F370, F700, F900, you can perform this operation by using the Platform REST API (Simple). For detailed information about this operation, see the [Hitachi Vantara Knowledge](#). For storage systems of other models, use storage management software such as CCI.

Map the external volumes

Create external parity groups, and register information about the external volumes of the external storage system that you want to map. Check the registered mapping information with the API function for getting information about the external path group to which the parity groups that you created belong.

When an iSCSI connection is used and the model of the local storage system is VSP E series, VSP G350, G370, G700, G900, VSP F350, F370, F700, F900, you can perform this operation by using the Platform REST API (Simple). For detailed information about this operation, see the [Hitachi Vantara Knowledge](#). For storage systems of other models, use storage management software such as CCI.

Create volumes

Create external volumes from the external parity groups that have been created in the local storage system. The created external volumes can be allocated to the host or used as pool volumes (this is the same as other volumes in the local storage system).

Making the external paths redundant

You can make the access routes to the external volumes redundant by setting multiple external paths between the local storage system and the external storage system. To set multiple external paths, add the paths to the external path group. The external path group is created automatically when external volumes are mapped.

The workflow is shown in the following diagram.

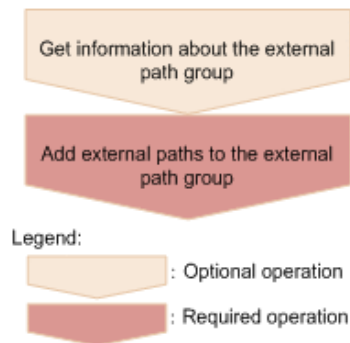

Get information about the external path group

Get information about the target external path group to check the path group ID.

When an iSCSI connection is used and the model of the local storage system is VSP E series, VSP G350, G370, G700, G900, VSP F350, F370, F700, F900, you can perform this operation by using the Platform REST API (Simple). For detailed information about this operation, see the [Hitachi Vantara Knowledge](#). For storage systems of other models, use storage management software such as CCI.

Add external paths to the external path group

Add external paths by specifying the external path group.

Changing priorities of external paths

The priorities of external paths depend on the order that the paths are registered to the external path group. To change the priority of a path in the REST API, delete the paths that are registered before the path for which you want to increase the priority, and then re-register the paths.

The workflow for external paths is shown in the following diagram.

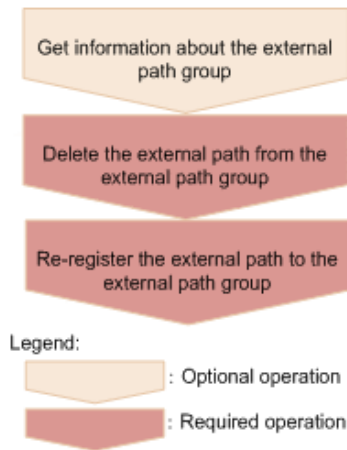

Get information about the external path group

Get information about the target external path group, and check the priorities of the external paths and the path group ID.

When an iSCSI connection is used and the model of the local storage system is VSP E series, VSP G350, G370, G700, G900, VSP F350, F370, F700, F900, you can perform this operation by using the Platform REST API (Simple). For detailed information about this operation, see the [Hitachi Vantara Knowledge](#). For storage systems of other models, use storage management software such as CCI.

Delete the external path from the external path group

From the external path group, delete the external path whose priority you want to reduce.

Re-register the external path to the external path group

Re-register the deleted external path in the external path group. To add more than one path, re-register the paths starting from the path with a higher priority.

Abolishing the use of external volumes

To dispose of an external storage system, disconnect the external volumes to release the mappings, and abolish the use of the external volumes.

The workflow is shown in the following diagram.

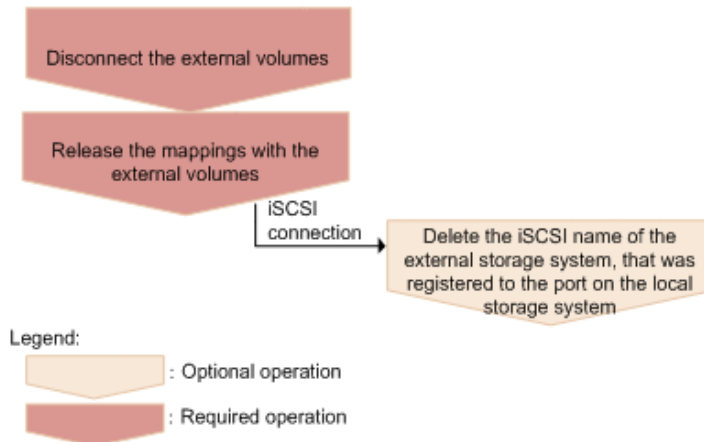

Disconnect the external volumes

Disconnect the external volumes. Input operations to and output operations from the mapped external volumes are stopped, and the data stored in the cache memory is written (destaged) to the external volumes.

Release the mappings with the external volumes

Delete the external parity groups to release the mappings with the external volumes. Data that has been written to the volumes on the external storage system site is not deleted after mappings are released. When the last external parity group in the external path group is deleted, the path group is automatically deleted.

(for iSCSI) Delete the iSCSI name of the external storage system, that was registered to the port on the local storage system

If the connection to the iSCSI target is no longer necessary, delete the iSCSI name of the external storage system, that was registered to the port on the local storage system.

Getting information about an iSCSI target of a port on an external storage system

This request gets information by searching for an iSCSI target (on an external storage system) that is connected to the local storage system.



Note:

- 0 is assumed for the virtual port ID if virtual port mode is enabled for the local storage system.

Execution permission

Storage Administrator (View Only)

Request line

POST *base-URL/v1/objects/iscsi-ports/object-ID/actions/discover/invoke*

Request message

Object ID

Specify the value of `portId` that was obtained by the processing to get information about ports.

| Attributes | Type | Description |
|------------|--------|--|
| portId | string | (Required) Port number of the local storage system |

Query parameters

None.

Body

```
{
  "parameters": {
    "iscsiIpAddress": "192.168.0.100",
    "tcpPort": 3260
  }
}
```

| Attribute | Type | Description |
|----------------|--------|--|
| iscsiIpAddress | string | (Required) IP address of the iSCSI target on the external storage system Specify an IPv4 or IPv6 IP address. |
| tcpPort | int | (Optional) TCP port number of the iSCSI target on the external storage system If this attribute is omitted, the TCP port number of the port on the local storage system is assumed. |

Response message**Body**

```
{
  "portId": "CL1-A",
  "externalIscsiTargets": [
    {
      "iscsiIpAddress": "192.168.0.100",
      "tcpPort": 3260,
      "iscsiName": "iqn.rest.example.of.iscsi1",
      "virtualPortId": 0,
      "isRegistered": true
    },
    {
      "iscsiIpAddress": "192.168.0.101",
      "tcpPort": 3260,
      "iscsiName": "iqn.rest.example.of.iscsi2",
      "virtualPortId": 0,
      "isRegistered": false
    }
  ]
}
```

| Attribute | Type | Description |
|----------------------|-----------|--|
| portId | string | Port number of the local storage system |
| externalIscsiTargets | object[] | <p>The following attributes related to the iSCSI target of the external storage system are output:</p> <ul style="list-style-type: none"> ▪ tcpPort (int) TCP port number ▪ iscsiIpAddress (string) IP address of the iSCSI target ▪ iscsiName (string) iSCSI name of the iSCSI target ▪ virtualPortId (int) ID of the virtual port by which the local storage system is connected to the external storage system This attribute is output if the virtual port mode is enabled. ▪ isRegistered (boolean) Indicates whether this iSCSI target is registered to the iSCSI port of the local storage system <ul style="list-style-type: none"> ▪ true: The iSCSI target is registered to the iSCSI port of the local storage system. ▪ false: The iSCSI target is not registered to the iSCSI port of the local storage system. |

Action template

None.

Status codes

For details about the status codes of the request for this operation, see the description of HTTP status codes.

Coding example

```
curl -v -H "Accept:application/json" -H "Content-Type:application/json" -H
"Authorization:Session f76884c29fff4dfaa664aa6981087b71" -X POST
"https://192.0.2.100/ConfigurationManager/v1/objects/iscsi-ports/CL1-A/
actions/discover/invoke"
```

Registering an iSCSI name of an external storage system to a port on the local storage system

This request registers an iSCSI name of an external storage system to a port on the local storage system.

After registering the iSCSI name, run the API request that performs a login test to verify that you can log in. If the attempt to log in fails, revise the settings so that you can log in, or delete that iSCSI target. If iSCSI targets remain to which you cannot log in, attempts to obtain information might fail because a heavy load might be placed on the network or external storage system when you search for an iSCSI target of a port on the external storage system.



Note:

- 0 is assumed for the virtual port ID if virtual port mode is enabled for the local storage system.

Execution permission

Storage Administrator (Provisioning)

Request line

```
POST base-URL/v1/objects/iscsi-ports/object-ID/actions/register/invoke
```

Request message

Object ID

Specify the value of `portId` that was obtained by the processing to get information about ports.

| Attribute | Type | Description |
|---------------------|--------|--|
| <code>portId</code> | string | (Required) Port number of the local storage system |

Query parameters

None.

Body

```
{
  "parameters": {
    "iscsiIpAddress": "192.168.0.100",
    "iscsiName": "iqn.rest.example.of.iscsi1",
    "tcpPort" : 3260
  }
}
```

```
}
}
```

| Attribute | Type | Description |
|----------------|--------|---|
| iscsilpAddress | string | (Required) IP address of the iSCSI target on the external storage system Specify an IPv4 or IPv6 IP address. |
| iscsiName | string | (Required) iSCSI name of the iSCSI target on the external storage system Specify the name in iqn or eui format. This attribute is case sensitive. |
| tcpPort | int | (Optional) TCP port number of the iSCSI target on the external storage system If this attribute is omitted, the TCP port number of the port on the local storage system is assumed. If the iSCSI name and IP address to be specified are already registered to a port of the local storage system, set the same value as that port or omit this attribute. If you omit this attribute in this situation, the following settings are applied: <ul style="list-style-type: none"> ▪ If the iSCSI name and IP address are already registered to the same port as the port specified for object-ID, the registered <code>tcpPort</code> value is not changed. ▪ If the iSCSI name and IP address are registered to a port different from the port specified for object-ID, the same value as the value that was set for <code>tcpPort</code> when the iSCSI name and IP address were registered to that port is set for the port specified for object-ID. |

Response message

A job object is returned. For details about attributes other than `affectedResources`, see the description of job objects.

| Attribute | Description |
|--------------------------------|--|
| <code>affectedResources</code> | URL of the port (on the local storage system) to which information about the iSCSI name of the external storage system is registered |

Action template

None.

Status codes

For details about the status codes of the request for this operation, see the description of HTTP status codes.

Coding example

```
curl -v -H "Accept:application/json" -H "Content-Type:application/json" -H "Authorization:Session f76884c29fff4dfaa664aa6981087b71" -X POST "https://192.0.2.100/ConfigurationManager/v1/objects/iscsi-ports/CL1-A/actions/register/invoke"
```

Getting the iSCSI name of an external storage system that is registered to a port on the local storage system

The following request gets information about the iSCSI name of an iSCSI target of a port on an external storage system that is registered to a port on the specified local storage system.

Execution permission

Storage Administrator (View Only)

Request line

```
GET base-URL/v1/objects/iscsi-ports/object-ID
```

Request message

Object ID

Specify the value of `portId` that was obtained by the processing to get information about ports.

| Attribute | Type | Description |
|-----------|--------|--|
| portId | string | (Required) Port number of the local storage system |

Query parameters

None.

Body

None.

Response message

Body

```
{
  "portId": "CL1-A",
  "externalIscsiTargets": [
    {
      "iscsiIpAddress": "192.168.0.100",
      "tcpPort": 3260,
      "iscsiName": "iqn.rest.example.of.iscsi1",
      "authenticationMode": "CHAP",
      "iscsiTargetDirection": "D",
      "chapUserName": "Win_SQL_EX",
      "isSecretSet": true,
      "virtualPortId": 0
    },
    {
      "iscsiIpAddress": "192.168.0.101",
      "tcpPort": 3260,
      "iscsiName": "iqn.rest.example.of.iscsi2",
      "authenticationMode": "NONE",
      "iscsiTargetDirection": "S",
      "chapUserName": "-",
      "isSecretSet": false,
      "virtualPortId": 0
    }
  ]
}
```

| Attribute | Type | Description |
|----------------------|-----------|---|
| portId | string | Port number of the local storage system |
| externalIscsiTargets | object[] | <p>The attributes related to the iSCSI target on the external storage system are output.</p> <p>An empty array is output if the port on the external storage system is a Fibre Channel port.</p> <ul style="list-style-type: none"> ▪ iscsiIpAddress (string) IP address of the iSCSI target ▪ tcpPort (int) TCP port number ▪ iscsiName (string) iSCSI name |

| Attribute | Type | Description |
|-----------|------|--|
| | | <ul style="list-style-type: none"> ▪ authenticationMode (string) CHAP-authentication mode <ul style="list-style-type: none"> • CHAP: CHAP-authentication mode • NONE: No authentication mode ▪ iscsiTargetDirection (string) Direction of the iSCSI target CHAP-authentication <ul style="list-style-type: none"> • D: Bidirectional authentication (The iSCSI target and the iSCSI initiator authenticate each other.) • S: Unidirectional authentication (The iSCSI target authenticates the iSCSI initiator.) ▪ chapUserName (string) CHAP user name The following user name is output: the user name used when the direction of CHAP-authentication is bidirectional. This also appears if CHAP-authentication mode is NONE. A hyphen (-) appears if the CHAP user name is omitted.# ▪ isSecretSet (boolean) Indicates whether a secret password is set for the CHAP authentication <ul style="list-style-type: none"> • true: A password is set. • false: A password is not set. ▪ virtualPortId (int) ID of the virtual port by which the local storage system is connected to the external storage system This attribute is output if virtual port mode is enabled. |

#: A hyphen (-) is output if - is specified for the CHAP user name.

Status codes

For details about the status codes of the request for this operation, see the description of HTTP status codes.

Coding example

```
curl -v -H "Accept:application/json" -H "Content-Type:application/json" -H "Authorization:Session f76884c29fff4dfaa664aa6981087b71" -X GET "https://192.0.2.100/ConfigurationManager/v1/objects/iscsi-ports/CL1-A"
```

Performing a login test on an iSCSI target of an external storage system that is registered to a port on the local storage system

The following request gets a login result by logging in to an iSCSI target on an external storage system that is registered to a port on the local storage system.

If an attempt to log in fails, revise the settings so that you can log in to the iSCSI target, or delete that iSCSI target. If iSCSI targets remain to which you cannot log in, attempts to obtain information might fail because a heavy load might be placed on the network or external storage system when you search for an iSCSI target of a port on the external storage system.



Note:

- 0 is assumed for the virtual port ID if virtual port mode is enabled for the local storage system.

Execution permission

Storage Administrator (View Only)

Request line

```
POST base-URL/v1/objects/iscsi-ports/object-ID/actions/check/invoke
```

Request message

Object ID

Specify the value of `portId` that was obtained by the processing to get information about ports.

| Attribute | Type | Description |
|-----------|--------|--|
| portId | string | (Required) Port number of the local storage system |

Query parameters

None.

Body

```
{
  "parameters": {
    "iscsiIpAddress": "192.168.0.100",
    "iscsiName": "iqn.rest.example.of.iscsi1"
  }
}
```

| Attribute | Type | Description |
|----------------|--------|---|
| iscsiIpAddress | string | (Required) IP address of the iSCSI target of the external storage system Specify an IPv4 or IPv6 IP address. |
| iscsiName | string | (Required) iSCSI name of the iSCSI target of the external storage system Specify the name in iqn or eui format. This attribute is case sensitive. |

Response message

Body

```
{
  "portId": "CL1-A",
  "externalIscsiTargets": [
    {
      "iscsiIpAddress": "192.168.0.100",
      "iscsiName": "iqn.rest.example.of.iscsi1",
      "isLoginSucceeded": true
    }
  ]
}
```

| Attribute | Type | Description |
|-----------|--------|---|
| portId | string | Port number of the local storage system |

| Attribute | Type | Description |
|----------------------|-----------|--|
| externaliscsiTargets | object[] | <p>The following attributes related to the iSCSI target of the external storage system are output:</p> <ul style="list-style-type: none"> ▪ <code>iscsilpAddress</code> (string) IP address of the iSCSI target ▪ <code>iscsiName</code> (string) iSCSI name of the iSCSI target ▪ <code>isLoginSucceeded</code> (boolean) Result of logging in to the iSCSI target <ul style="list-style-type: none"> ▪ <code>true</code>: The login attempt succeeded. ▪ <code>false</code>: The login attempt failed. |

Action template

None.

Status codes

For details about the status codes of the request for this operation, see the description of HTTP status codes.

Coding example

```
curl -v -H "Accept:application/json" -H "Content-Type:application/json" -H
"Authorization:Session f76884c29fff4dfaa664aa6981087b71" -X POST
"https://192.0.2.100/ConfigurationManager/v1/objects/iscsi-ports/CL1-A/
actions/check/invoke"
```

Getting a list of ports on an external storage system

The following request acquires a list of ports for an external storage system that is connected to the local storage system.

**Note:**

- In the case of an iSCSI port, if an iSCSI target that cannot connect to the target iSCSI port is registered, attempts to obtain information might fail because a heavy load might be placed on the network or external storage system. After registering the iSCSI name, perform a login test to verify that you can log in.
- If you use a port for external connections as the endpoint of an I/O path from an external storage system to a local storage system, the I/O path might become disconnected. Use a route that can be used as an external path. For details about external paths, see the *Hitachi Universal Volume Manager User Guide*.

Execution permission

Storage Administrator (View Only)

Request lineGET *base-URL/v1/objects/external-storage-ports***Request message****Object ID**

None.

Query parameters

| Parameter | Type | Filter condition |
|-----------|--------|---|
| portId | string | (Required) Number of the port on the local storage system |

Body

None.

Response message**Body**

The following is a coding example when a Fibre Channel port is used:

```
{
  "data" : [ {
    "externalWwn" : "50060e80222fd141",
    "portId" : "CL7-A",
    "externalSerialNumber" : "477777",
    "externalStorageInfo" : "HITACHI VSP Gx00",
```

```

    "externalPathMode" : "Multi",
    "externalIsUsed" : false
  } ]
}

```

The following is a coding example when an iSCSI port is used:

```

{
  "data" : [ {
    "portId" : "CL2-D",
    "externalSerialNumber" : "477777",
    "externalStorageInfo" : "HITACHI VSP Gx00",
    "externalPathMode" : "Multi",
    "externalIsUsed" : true,
    "iscsiIpAddress" : "192.0.1.100",
    "iscsiName" : "iqn.rest.example.of.iscsi1",
    "virtualPortId" : 0
  } ]
}

```

| Attribute | Type | Description |
|----------------------|--------|--|
| portId | string | Number of the port on the local storage system |
| externalWwn | string | WWN of the port on the external storage system This attribute is displayed when a Fibre Channel port is used. |
| iscsiIpAddress | string | IP address of the iSCSI target on the external storage system This attribute is displayed when an iSCSI port is used. |
| iscsiName | string | Name of the iSCSI target on the external storage system This attribute is displayed when an iSCSI port is used. |
| virtualPortId | int | Virtual port ID This attribute is displayed when an iSCSI port is used and virtual port mode is enabled. |
| externalSerialNumber | string | Serial number of the external storage system |
| externalStorageInfo | string | The vendor information and product ID of the external storage system |

| Attribute | Type | Description |
|------------------|---------|--|
| | | This information is obtained in a format in which the vendor information and product ID are concatenated by a space. |
| externalPathMode | string | Path mode for the external path of the port on the external storage system <ul style="list-style-type: none"> ▪ Multi: Multi mode ▪ Single: Single mode ▪ APLB: APLB mode |
| externallsUsed | boolean | Whether the port of the external storage system that is externally connected to the local storage system is being used to map external volumes <ul style="list-style-type: none"> ▪ true: Used ▪ false: Not used |

Status codes

For details on the status codes of the request for this operation, see the description on HTTP status codes.

Coding example

```
curl -v -H "Accept:application/json" -H "Content-Type:application/json" -H
"Authorization:Session d7b673af189048468c5af9bcf3bbbb6f" -X GET https://
192.0.2.100/ConfigurationManager/v1/objects/external-storage-ports?
portId=CL7-A
```

Getting a list of LUs defined for a port on an external storage system

The following request acquires a list of the LUs that are defined for the port on an external storage system that is externally connected to the local storage system.



Note:

If you use a port for external connections as the endpoint of an I/O path from an external storage system to a local storage system, the I/O path might become disconnected. Use a route that can be used as an external path. For details about external paths, see the *Hitachi Universal Volume Manager User Guide*.

Execution permission

Storage Administrator (View Only)

Request lineGET *base-URL/v1/objects/external-storage-luns***Request message****Object ID**

None.

Query parameters

When a Fibre Channel port is used:

| Parameter | Type | Filter Condition |
|-------------|--------|---|
| portId | string | (Required) Number of the port on the local storage system |
| externalWwn | string | (Required) WWN of the port on the external storage system |

When an iSCSI port is used:

| Parameter | Type | Filter Condition |
|----------------|--------|--|
| portId | string | (Required) Port number on the local storage system |
| iscsilpAddress | string | (Required) IP address of the iSCSI target on the external storage system |
| iscsiName | string | (Required) iSCSI name of the iSCSI target on the external storage system Specify this parameter in iqn or eui format. |

Body

None.

Response message**Body**

The following is a coding example when a Fibre Channel port is used:

```
{
  "data" : [ {
    "externalLun" : 0,
    "portId" : "CL7-A",
    "externalWwn" : "50060e80222fd141",
    "externalVolumeCapacity" : 62914560,
    "externalVolumeInfo" : "OPEN-V HITACHI 50412FD100CC"
  } ]
}
```

The following is a coding example when an iSCSI port is used:

```
{
  "data" : [ {
    "externalLun" : 0,
    "portId" : "CL7-A",
    "externalVolumeCapacity" : 62914560,
    "externalVolumeInfo" : "OPEN-V HITACHI 50412FD100CC",
    "iscsiIpAddress" : "192.168.0.100",
    "iscsiName" : "iqn.rest.example.of.iscsi1",
    "virtualPortId" : 0
  } ]
}
```

| Attribute | Type | Description |
|----------------|--------|--|
| portId | string | Number of the port on the local storage system |
| externalWwn | string | WWN of the port on the external storage system This attribute is displayed when a Fibre Channel port is used. |
| iscsiIpAddress | string | IP address of the iSCSI target on the external storage system This attribute is displayed when an iSCSI port is used. |
| iscsiName | string | Name of the iSCSI target on the external storage system |

| Attribute | Type | Description |
|------------------------|--------|--|
| | | This attribute is displayed when an iSCSI port is used. |
| virtualPortId | int | Virtual port ID This attribute is displayed when an iSCSI port is used and virtual port mode is enabled. |
| externalLun | int | LUN that can be referenced from the port on the external storage system |
| externalVolumeCapacity | long | Capacity of the external volume on the external storage system (1 block = 512 bytes) |
| externalVolumeInfo | string | The product ID and the device identification (output in ASCII format) in the SCSI information for the external volume on the external storage system This information is obtained in a format in which the product ID and the device identification are concatenated by a space. If the LU cannot be used as an external volume group, OTHER is output for the product ID. |

Status codes

For details on the status codes of the request for this operation, see the description on HTTP status codes.

Coding example

```
curl -v -H "Accept:application/json" -H "Content-Type:application/json" -H
"Authorization:Session d7b673af189048468c5af9bcf3b6bb6f" -X GET "https://
192.0.2.100/ConfigurationManager/v1/objects/external-storage-luns?
portId=CL7-A&externalWwn=50060e80222fd141"
```

Mapping an external volume

The following request creates an external parity group on the local storage system, and then registers (maps) volumes on an external storage system to the created external parity group. When a volume is mapped, the external path group and the external path are also created.

**Important:**

The API request for mapping an external volume can be used only when Fibre Channel ports are used. The request cannot be used when iSCSI ports are used.

If you are using an iSCSI port, use storage management software such as CCI. For VSP E series, VSP G350, G370, G700, G900, VSP F350, F370, F700, F900 storage systems, you can perform this operation by using the Platform REST API (Simple). For detailed information about this operation, see the [Hitachi Vantara Knowledge website](#).

**Note:**

If you use a port for external connections as the endpoint of an I/O path from an external storage system to a local storage system, the I/O path might become disconnected. Use a route that can be used as an external path. For details about external paths, see the *Hitachi Universal Volume Manager User Guide*.

Execution permission

Storage Administrator (Provisioning)

Request line

```
POST base-URL/v1/objects/external-parity-groups
```

Request message**Object ID**

None.

Query parameters

None.

Body

```
{
  "externalParityGroupId": "1-1",
  "externalPathGroupId": 1,
  "portId": "CL7-A",
  "externalWwn": "50060e80222fd141",
  "lunId": 0,
  "emulationType": "OPEN-V",
  "clprId": 0
}
```

| Attribute | Type | Description |
|-----------------------|--------|---|
| externalParityGroupId | string | (Required) External parity group number |

| Attribute | Type | Description |
|---------------------|--------|--|
| | | Specify the number in <i>gno-sgno</i> format. |
| externalPathGroupId | int | (Required) External path group ID If the specified path group ID does not exist, a new path group ID will be created. |
| portId | string | (Required) Number of the port on the local storage system |
| externalWwn | string | (Required) WWN of the external storage system |
| lunId | int | (Required) LUN of the port on the external storage system |
| emulationType | string | (Optional) Emulation type Specifiable values are as follows: OPEN-3 , OPEN-8 , OPEN-9 , OPEN-E , OPEN-K , OPEN-L , OPEN-V , 3380-3 , 3380-3A , 3380-3B , 3380-3C , 3390-1 , 3390-2 , 3390-3 , 3390-A , 3390-3A , 3390-3B , 3390-3C , 3390-3R , 3390-9 , 3390-9A , 3390-9B , 3390-9C , 3390-L , 3390-LA , 3390-LB , 3390-LC , 3390-M , 3390-MA , 3390-MB , 3390-MC , 3390-V , 6586-G , 6586-J , 6586-K , 6586-KA , 6586-KB , 6586-KC , 6588-1 , 6588-3 , 6588-9 , 6588-A , 6588-3A , 6588-3B , 6588-3C , 6588-9A , 6588-9B , 6588-9C , 6588-L , 6588-LA , 6588-LB , 6588-LC If this attribute is omitted, OPEN-V is set. |
| clprId | int | (Optional) CLPR number to be used by the external parity group Specify a decimal (base 10) number in the range from 0 to 31. If this attribute is omitted, 0 is set. |

| Attribute | Type | Description |
|------------------------------|---------|--|
| isExternalAttributeMigration | boolean | (Optional) Whether to set the nondisruptive migration attribute for the external parity group <ul style="list-style-type: none"> ▪ <code>true</code>: Set the attribute. ▪ <code>false</code>: Do not set the attribute If this attribute is omitted, <code>false</code> is set. |
| commandDeviceLdevId | int | (Optional) LDEV number of the remote command device Specify this attribute if you want to map the command device of the external storage system. The specified LDEV number is assigned to the remote command device. |

Response message

Body

A job object is returned. For details on attributes other than `affectedResources`, see the section explaining job objects. To check whether the execution results of this API request have been correctly applied, execute the API request for getting information about the external paths.

| Attribute | Description |
|--------------------------------|---|
| <code>affectedResources</code> | URL of the mapped external parity group |

Status codes

For details on the status codes of the request for this operation, see the description on HTTP status codes.

Coding example

```
curl -v -H "Accept:application/json" -H "Content-Type:application/json" -H
"Authorization:Session d7b673af189048468c5af9bcf3b6bb6f" -X POST --data-
binary @./InputParameters.json https://192.0.2.100/ConfigurationManager/v1/
objects/external-parity-groups
```

Getting a list of external path groups

The following request obtains a list of information about external path groups. It also obtains information about the related external parity groups and external paths.

Depending on the number of resources for which information is to be obtained, you might have to run this API request more than once to obtain information about all of those resources. In such cases, each time you run the request, if information was not obtained for one or more external path groups, the attribute `nextPageHeadPathGroupId` in the response body indicates the ID of the first external path group for which information was not obtained. To obtain information about the remaining external path groups, run the API request with the path group ID indicated by `nextPageHeadPathGroupId` specified for the parameter `headPathGroupId` in the query. If information was obtained for all target resources, the attribute `nextPageHeadPathGroupId` returns the value `-1`.



Important:

The API request for getting a list of external path groups can be used only when Fibre Channel ports are used. The request cannot be used when iSCSI ports are used.

If you are using an iSCSI port, use storage management software such as CCI. For VSP E series, VSP G350, G370, G700, G900, VSP F350, F370, F700, F900 storage systems, you can perform this operation by using the Platform REST API (Simple). For detailed information about this operation, see the [Hitachi Vantara Knowledge website](#).

Execution permission

Storage Administrator (View Only)

Request line

```
GET base-URL/v1/objects/external-path-groups
```

Request message

Object ID

None.

Query parameters

| Parameter | Type | Filter Condition |
|------------------------------------|--------|---|
| <code>externalParityGroupId</code> | string | (Optional) External parity group number Specify the number in <i>gno-sgno</i> format. You cannot specify this parameter and the <code>ldevId</code> parameter at the same time. |

| Parameter | Type | Filter Condition |
|-----------------|--------|---|
| ldevId | string | (Optional) LDEV number You cannot specify this parameter and the <code>externalParityGroupId</code> parameter at the same time. |
| headPathGroupId | int | (Optional) ID of the first external path group of the external path groups for which information is to be obtained If you want to specify a range of external path groups for which to information is to be obtained, specify the ID of the first external path group in the target range. |

Body

None.

Response message**Body**

```

{
  "data": [
    {
      "externalPathGroupId": 0,
      "externalSerialNumber": "91110309",
      "externalProductId": "HUS",
      "externalParityGroups": [
        {
          "externalParityGroupId": "1-1",
          "externalParityGroupStatus": "BLK",
          "cacheMode": "D",
          "isInflowControlEnabled": false,
          "mpBladeId": 0,
          "loadBalanceMode": "N",
          "pathMode": "M",
          "isDataDirectMapping": false,
          "externalLuns": [
            {
              "portId": "CL5-B",
              "externalWwn": "50060e8010539b51",
              "priority": 1,
              "externalLun": 0,
              "pathStatus": "BLK"
            }
          ]
        }
      ]
    }
  ]
}

```

```

    ]
  },
  {
    "externalParityGroupId": "1-12",
    "externalParityGroupStatus": "BLK",
    "cacheMode": "E",
    "isInflowControlEnabled": false,
    "mpBladeId": 2,
    "loadBalanceMode": "N",
    "pathMode": "M",
    "isDataDirectMapping": false,
    "externalLuns": [
      {
        "portId": "CL5-B",
        "externalWwn": "50060e8010539b51",
        "priority": 1,
        "externalLun": 19,
        "pathStatus": "BLK"
      }
    ]
  }
],
"externalPaths": [
  {
    "portId": "CL5-B",
    "externalWwn": "50060e8010539b51"
  }
],
"nextPageHeadPathGroupId": -1
},
{
  "externalPathGroupId": 1,
  "externalSerialNumber": "210945",
  "externalProductId": "HUS VM",
  "externalParityGroups": [
    {
      "externalParityGroupId": "1-2",
      "externalParityGroupStatus": "NML",
      "cacheMode": "D",
      "isInflowControlEnabled": false,
      "mpBladeId": 1,
      "loadBalanceMode": "N",
      "pathMode": "M",
      "isDataDirectMapping": false,
      "externalLuns": [
        {
          "portId": "CL5-B",
          "externalWwn": "50060e80132ac120",
          "priority": 1,

```

```

        "externalLun": 21,
        "pathStatus": "NML"
    }
]
},
{
    "externalParityGroupId": "1-23",
    "externalParityGroupStatus": "NML",
    "cacheMode": "E",
    "isInflowControlEnabled": false,
    "mpBladeId": 2,
    "loadBalanceMode": "N",
    "pathMode": "M",
    "isDataDirectMapping": false,
    "externalLuns": [
        {
            "portId": "CL5-B",
            "externalWwn": "50060e80132ac120",
            "priority": 1,
            "externalLun": 32,
            "pathStatus": "NML"
        }
    ]
}
],
"externalPaths": [
    {
        "portId": "CL5-B",
        "externalWwn": "50060e80132ac120"
    }
],
"nextPageHeadPathGroupId": -1
}
]
}

```

| Attribute | Type | Description |
|----------------------|--------|--|
| externalPathGroupId | int | External path group number |
| externalSerialNumber | string | Serial number of the external storage system |
| externalProductId | string | Product ID of the external storage system |

| Attribute | Type | Description |
|----------------------|----------|--|
| externalParityGroups | object[] | <p>The following attributes are output for each external parity group:</p> <ul style="list-style-type: none"> ▪ externalParityGroupId (string) External parity group number ▪ externalParityGroupStatus (string) Status of the external parity group <ul style="list-style-type: none"> ▪ NML: Normal ▪ CHK: The mapping path status is being checked ▪ SYN: Data in the cache is being written to the volume ▪ DSC: The parity group is disconnected from the external storage system or the external volumes ▪ BLK: The mapping path is blocked ▪ WAR: The status of the mapping path is not normal ▪ Unknown: Unknown ▪ cacheMode (string) Cache mode <ul style="list-style-type: none"> ▪ E: Enabled ▪ D: Disabled <p>For an external parity group that has the nondisruptive migration attribute, the following values are output:</p> <ul style="list-style-type: none"> ▪ EM: Enabled ▪ DM: Disabled ▪ TM: Through ▪ SM: Synchronized writing |

| Attribute | Type | Description |
|-----------|------|---|
| | | <ul style="list-style-type: none"> ▪ <code>isInflowControlEnabled</code> (boolean) Inflow cache control <ul style="list-style-type: none"> ▪ <code>true</code>: Enabled ▪ <code>false</code>: Disabled ▪ <code>mpBladeId</code> (int) MP blade ID ▪ <code>loadBalanceMode</code> (string) The load balancing method for I/O operations for the external storage system <ul style="list-style-type: none"> ▪ <code>N</code>: Standard round-robin method ▪ <code>E</code>: Expanded round-robin method ▪ <code>D</code>: I/O is performed over a single path, and load balancing is not used ▪ <code>pathMode</code> (string) Path mode of the external storage system <ul style="list-style-type: none"> ▪ <code>M</code>: Multi mode ▪ <code>S</code>: Single mode ▪ <code>A</code>: APLB mode ▪ <code>AL</code>: ALUA mode ▪ <code>MA</code>: Multi mode (in a state in which the mode can be changed to the ALUA mode) ▪ <code>SA</code>: Single mode (in a state in which the mode can be changed to the ALUA mode) |

| Attribute | Type | Description |
|----------------------------|-----------------------|---|
| | | <ul style="list-style-type: none"> ▪ <code>isDataDirectMapping</code> (boolean) Whether the data direct mapping attribute is enabled <ul style="list-style-type: none"> ▪ <code>true</code>: Enabled ▪ <code>false</code>: Disabled ▪ <code>externalLuns</code> (object[]) The following attributes are output for each LU on the external storage system: <ul style="list-style-type: none"> • <code>portId</code> (string) Port number • <code>externalWwn</code> (string) WWN of the external storage system • <code>priority</code> (int) Priority within the external path group • <code>externalLun</code> (int) LUN within the ports of the external storage system • <code>pathStatus</code> (string) Status of the external path NML: Normal CHK: Temporarily blocked (The status of the external path is being checked.) BLK: Blocked DSC: Disconnected Unknown: Unknown |
| <code>externalPaths</code> | <code>object[]</code> | <p>The following attributes are output for each external path:</p> <ul style="list-style-type: none"> ▪ <code>portId</code> (string) Port number ▪ <code>externalWwn</code> (string) WWN of the external storage system |

| Attribute | Type | Description |
|-------------------------|------|---|
| | | <ul style="list-style-type: none"> <li data-bbox="867 254 1414 457"> ▪ qDepth (int) Number of Read/Write commands that can be queued to the external parity group This information is obtained only when the qDepth attribute is set. <li data-bbox="867 474 1414 678"> ▪ ioTimeOut (int) The value (in seconds) set for the I/O time over for the external parity group This information is obtained only when the ioTimeOut attribute is set. <li data-bbox="867 695 1414 961"> ▪ blockedPathMonitoring (int) The time (in seconds) until the external parity group is blocked after all paths to the external parity group are disconnected This information is obtained only when the blockedPathMonitoring attribute is set. |
| nextPageHeadPathGroupId | int | <p data-bbox="867 995 1373 1052">ID of the first external path group for which information was not obtained</p> <p data-bbox="867 1079 1414 1314">If you were not able to obtain information about all target external path groups by a single execution of the request, you can obtain information about the remaining external path groups by running the request again, with this value specified for the parameter headPathGroupId in the query.</p> <p data-bbox="867 1341 1390 1398">If information was obtained about all target external path groups, the value -1 is output.</p> |

Status codes

For details on the status codes of the API, see the description on HTTP status codes.

Coding example

```
curl -v -H "Accept:application/json" -H "Content-Type:application/json" -H
"Authorization:Session d7b673af189048468c5af9bcf3b6bb6f" -X GET https://
192.0.2.100/ConfigurationManager/v1/objects/external-path-groups
```

Getting information about a specific external path group

The following request acquires information about a specified external path group and the external parity groups and external paths that are related to the specified external path group.



Important:

The API request for getting information about a specific external path group can be used only when Fibre Channel ports are used. The request cannot be used when iSCSI ports are used.

If you are using an iSCSI port, use storage management software such as CCI. For VSP E series, VSP G350, G370, G700, G900, VSP F350, F370, F700, F900 storage systems, you can perform this operation by using the Platform REST API (Simple). For detailed information about this operation, see the [Hitachi Vantara Knowledge website](#).

Execution permission

Storage Administrator (View Only)

Request line

```
GET base-URL/v1/objects/external-path-groups/object-ID
```

Request message

Object ID

Specify the value of `externalPathGroupId` that was obtained by the request to get information about the external path group.

| Attribute | Type | Description |
|----------------------------------|------|---------------------------------------|
| <code>externalPathGroupId</code> | int | (Required) External path group number |

Query parameters

None.

Body

None.

Response message

Body

```
{
  "externalPathGroupId": 1,
  "externalSerialNumber": "210945",
```

```

"externalProductId": "HUS VM",
"externalParityGroups": [
  {
    "externalParityGroupId": "1-2",
    "externalParityGroupStatus": "NML",
    "cacheMode": "D",
    "mpBladeId": 1,
    "loadBalanceMode": "N",
    "pathMode": "M",
    "externalLuns": [
      {
        "portId": "CL5-B",
        "externalWwn": "50060e80132ac120",
        "priority": 1,
        "externalLun": 21,
        "pathStatus": "NML"
      }
    ],
    "isInflowControlEnabled": false,
    "isDataDirectMapping": false
  },
  {
    "externalParityGroupId": "1-23",
    "externalParityGroupStatus": "NML",
    "cacheMode": "E",
    "mpBladeId": 2,
    "loadBalanceMode": "N",
    "pathMode": "M",
    "externalLuns": [
      {
        "portId": "CL5-B",
        "externalWwn": "50060e80132ac120",
        "priority": 1,
        "externalLun": 32,
        "pathStatus": "NML"
      }
    ],
    "isInflowControlEnabled": false,
    "isDataDirectMapping": false
  }
],
"externalPaths": [
  {
    "portId": "CL5-B",
    "externalWwn": "50060e80132ac120"
  }
]
}

```

| Attribute | Type | Description |
|----------------------|----------|--|
| externalPathGroupId | int | External path group number |
| externalSerialNumber | string | Serial number of the external storage system |
| externalProductId | string | Product ID of the external storage system |
| externalParityGroups | object[] | <p>The following attributes are output for each external parity group:</p> <ul style="list-style-type: none"> ▪ externalParityGroupId (string) External parity group number ▪ externalParityGroupStatus (string) Status of the external parity group <ul style="list-style-type: none"> ▪ NML: Normal ▪ CHK: The mapping path status is being checked ▪ SYN: Data in the cache is being written to the volume ▪ DSC: The external parity group is disconnected from the external storage system or the external volume ▪ BLK: The mapping path is blocked ▪ WAR: The status of the mapping path is not normal ▪ Unknown: Unknown |

| Attribute | Type | Description |
|-----------|------|---|
| | | <ul style="list-style-type: none"> ▪ cacheMode (string) Cache mode <ul style="list-style-type: none"> ▪ E: Enabled ▪ D: Disabled <p>For an external parity group that has the nondisruptive migration attribute, the following values are output:</p> <ul style="list-style-type: none"> ▪ EM: Enabled ▪ DM: Disabled ▪ TM: Through ▪ SM: Synchronized writing ▪ isInflowControlEnabled (boolean) Inflow cache control <ul style="list-style-type: none"> ▪ true: Enabled ▪ false: Disabled ▪ mpBladeId (int) MP blade ID ▪ loadBalanceMode (string) The load balancing method for I/O operations for the external storage system <ul style="list-style-type: none"> ▪ N: Standard round-robin method ▪ E: Expanded round-robin method ▪ D: I/O is performed over a single path, and load balancing is not used |

| Attribute | Type | Description |
|-----------|------|--|
| | | <ul style="list-style-type: none"> ▪ pathMode (string) Path mode of the external storage system ▪ M: Multi mode ▪ S: Single mode ▪ A: APLB mode ▪ AL: ALUA mode ▪ MA: Multi mode (E) ▪ SA: Single mode (in a state in which the mode can be changed to the ALUA mode) |

| Attribute | Type | Description |
|---------------|----------|--|
| | | <ul style="list-style-type: none"> ▪ isDataDirectMapping (boolean) Whether the data direct mapping attribute is enabled <ul style="list-style-type: none"> ▪ <code>true</code>: Enabled ▪ <code>false</code>: Disabled ▪ externalLuns (object[]) The following attributes are output for each LU on the external storage system: <ul style="list-style-type: none"> • portId (string) Port number • externalWwn (string) WWN of the external storage system • priority (int) Priority within the external path group • externalLun (int) LUN within the ports of the external storage system • pathStatus (string) Status of the external path NML: Normal CHK: Temporarily blocked (The status of the external path is being checked.) BLK: Blocked DSC: Disconnected Unknown: Unknown |
| externalPaths | object[] | <p>The following attributes are displayed for each external path:</p> <ul style="list-style-type: none"> ▪ portId (string) Port number ▪ externalWwn (string) WWN of the external storage system |

| Attribute | Type | Description |
|-----------|------|---|
| | | <ul style="list-style-type: none"> <li data-bbox="852 256 1417 457"> ▪ <code>qDepth</code> (int) Number of Read/Write commands that can be queued to the external parity group This information is obtained only when the <code>qDepth</code> attribute is set. <li data-bbox="852 478 1417 680"> ▪ <code>ioTimeout</code> (int) The value (in seconds) set for the I/O time over for the external parity group This information is obtained only when the <code>ioTimeout</code> attribute is set. <li data-bbox="852 701 1417 928"> ▪ <code>blockedPathMonitoring</code> (int) The time (in seconds) until the external parity group is blocked after all paths to the external parity group are disconnected This information is obtained only when the <code>blockedPathMonitoring</code> attribute is set. |

Status codes

For details on the status codes of the API, see the description on HTTP status codes.

Coding example

```
curl -v -H "Accept:application/json" -H "Content-Type:application/json" -H
"Authorization:Session d7b673af189048468c5af9bcf3b6bb6f" -X GET https://
192.0.2.100/ConfigurationManager/v1/objects/external-path-groups/1
```

Adding an external path to an external path group

The following request adds external path information to an existing external path group. The priority of the path is set in ascending order, according to the order in which the path was added.



Note:

If you use a port for external connections as the endpoint of an I/O path from an external storage system to a local storage system, the I/O path might become disconnected. Use a route that can be used as an external path. For details about external paths, see the *Hitachi Universal Volume Manager User Guide*.

Execution permission

Storage Administrator (Provisioning)

Request line

```
POST base-URL/v1/objects/external-path-groups/object-ID/actions/add-path/
invoke
```

Request message**Object ID**

Specify the value of `externalPathGroupId` that was obtained by the request to get information about the external path group.

| Attribute | Type | Description |
|----------------------------------|------|---------------------------------------|
| <code>externalPathGroupId</code> | int | (Required) External path group number |

Query parameters

None.

Body

The following is a coding example when a Fibre Channel port is used:

```
{
  "parameters": {
    "portId": "CL7-A",
    "externalWwn": "50060E801033C2F0"
  }
}
```

When a Fibre Channel port is used:

| Attribute | Type | Description |
|--------------------------|--------|---|
| <code>portId</code> | string | (Required) Number of the port on the local storage system |
| <code>externalWwn</code> | string | (Required) WWN of the external storage system |

The following is a coding example when an iSCSI port is used:

```
{
  "parameters": {
    "portId": "CL1-C",
```

```

"iscsiIpAddress": "192.168.0.100",
"iscsiName": "iqn.rest.example.of.iscsi1"
}
}

```

When an iSCSI port is used:

| Attribute | Type | Description |
|----------------|--------|--|
| portId | string | (Required) Port number on the local storage system |
| iscsiIpAddress | string | (Required) IP address of the iSCSI target on the external storage system Specify an IPv4 or IPv6 address. |
| iscsiName | string | (Required) iSCSI name of the iSCSI target on the external storage system Specify this attribute in iqn or eui format. |

Response message

Body

A job object is returned. For details on attributes other than `affectedResources`, see the section explaining job objects.

| Attribute | Description |
|-------------------|--|
| affectedResources | <ul style="list-style-type: none"> When a Fibre Channel port is used: The URL of the external path group to which the external path was added is returned. When an iSCSI port is used: <code>affectedResources</code> is not displayed for this API. To check whether the external path was added to the external path group, use storage management software such as CCI. For VSP E series, VSP G350, G370, G700, G900, VSP F350, F370, F700, F900, you can perform this operation by using the Platform REST API (Simple). For detailed information about this operation, see the Hitachi Vantara Knowledge website. |

Action template

None.

Status codes

For details on the status codes of the request for this operation, see the description on HTTP status codes.

Coding example

```
curl -v -H "Accept:application/json" -H "Content-Type:application/json" -H
"Authorization:Session d7b673af189048468c5af9bcf3b66b6f" -X POST --data-
binary @./InputParameters.json https://192.0.2.100/ConfigurationManager/v1/
objects/external-path-groups/1/actions/add-path/invoke
```

Removing an external path from an external path group

The following request removes external path information from an external path group.

Execution permission

Storage Administrator (Provisioning)

Request line

```
POST base-URL/v1/objects/external-path-groups/object-ID/actions/remove-
path/invoke
```

Request message**Object ID**

Specify the value of `externalPathGroupId` that was obtained by the request to get information about the external path group.

| Attribute | Type | Description |
|----------------------------------|------|---------------------------------------|
| <code>externalPathGroupId</code> | int | (Required) External path group number |

Query parameters

None.

Body

The following is a coding example when a Fibre Channel port is used:

```
{
  "parameters": {
    "portId": "CL7-A",
    "externalWwn": "50060E801033C2F0"
  }
}
```

When a Fibre Channel port is used:

| Attribute | Type | Description |
|-------------|--------|---|
| portId | string | (Required) Number of the port on the local storage system |
| externalWwn | string | (Required) WWN of the external storage system |

The following is a coding example when an iSCSI port is used:

```
{
  "parameters": {
    "portId": "CL1-C",
    "iscsiIpAddress": "192.168.0.100",
    "iscsiName": "iqn.rest.example.of.iscsi1"
  }
}
```

When an iSCSI port is used:

| Attribute | Type | Description |
|----------------|--------|--|
| portId | string | (Required) Port number on the local storage system |
| iscsiIpAddress | string | (Required) IP address of the iSCSI target on the external storage system Specify an IPv4 or IPv6 address. |
| iscsiName | string | (Required) iSCSI name of the iSCSI target on the external storage system Specify this attribute in iqn or eui format. |

Response message**Body**

A job object is returned. For details on attributes other than `affectedResources`, see the section explaining job objects.

| Attribute | Description |
|-------------------|---|
| affectedResources | <ul style="list-style-type: none"> <li data-bbox="688 436 1424 552">▪ When a Fibre Channel port is used: The URL of the external path group from which the external path was removed is returned. <li data-bbox="688 583 1424 926">▪ When an iSCSI port is used: <code>affectedResources</code> is not displayed for this API. To check whether the external path was removed from the external path group, use storage management software such as CCI. For VSP E series, VSP G350, G370, G700, G900, VSP F350, F370, F700, F900, you can perform this operation by using the Platform REST API (Simple). For detailed information about this operation, see the Hitachi Vantara Knowledge website. |

Action template

None.

Status codes

For details on the status codes of the request for this operation, see the description on HTTP status codes.

Coding example

```
curl -v -H "Accept:application/json" -H "Content-Type:application/json" -H
"Authorization:Session d7b673af189048468c5af9bcf3b66b6f" -X POST --data-
binary @./InputParameters.json https://192.0.2.100/ConfigurationManager/v1/
objects/external-path-groups/1/actions/remove-path/invoke
```

Unmapping an external volume

The following request unmaps an external volume by deleting the external parity group. If the last external parity group is deleted, the external path group itself is also deleted.

Execution permission

Storage Administrator (Provisioning)

Request line

```
DELETE base-URL/v1/objects/external-parity-groups/object-ID
```

Request message**Object ID**

Specify the value of `externalParityGroupId` that was obtained by the processing to get information about the external path group.

| Attribute | Type | Description |
|------------------------------------|--------|---|
| <code>externalParityGroupId</code> | string | (Required) External parity group number |

Query parameters

None.

Body

```
{
  "force": true
}
```

| Attribute | Type | Description |
|--------------------|---------|--|
| <code>force</code> | boolean | <p>(Optional) Specify whether to forcibly unmap the external volume without destaging it.</p> <p>Specify <code>true</code> to unmap the external volume without destaging it.</p> <ul style="list-style-type: none"> ▪ <code>true</code>: Forcibly unmap the external volume. ▪ <code>false</code>: Unmap the external volume only if the external volume has been destaged. <p>If this attribute is omitted, <code>false</code> is set.</p> <p>If you specify <code>false</code>, first execute the API function to disconnect the external volume.</p> |

Response message**Body**

A job object is returned. See the description for the job object. `affectedResources` is not displayed for this API. To check whether the unmapping was successful, execute the API request for getting information about an external path group.

Status codes

For details on the status codes of the request for this operation, see the description on HTTP status codes.

Coding example

```
curl -v -H "Accept:application/json" -H "Content-Type:application/json" -H
"Authorization:Session d7b673af189048468c5af9bcf3bbbb6f" -X DELETE
https://192.0.2.100/ConfigurationManager/v1/objects/external-parity-
groups/1-1
```

Disconnecting from an external volume

The following request disconnects an external volume on an external storage system from the local storage system. The external volume is not unmapped.

Execution permission

Storage Administrator (Provisioning)

Request line

```
POST base-URL/v1/objects/external-parity-groups/object-ID/actions/
disconnect/invoke
```

Request message**Object ID**

Specify the value of `externalParityGroupId` that was obtained by the processing to get information about the external path group.

| Attribute | Type | Description |
|------------------------------------|--------|---|
| <code>externalParityGroupId</code> | string | (Required) External parity group number |

Query parameters

None.

Body

None.

Response message

Body

A job object is returned. See the description for the job object. `affectedResources` is not displayed for this API function. To check whether the disconnection was successful, check the status of the external path by executing the API function for getting information about an external path group.

Action template

None.

Status codes

For details on the status codes of the request for this operation, see the description of HTTP status codes.

Coding example

```
curl -v -H "Accept:application/json" -H "Content-Type:application/json" -H "Authorization:Session d7b673af189048468c5af9bcf3b66b6f" -X POST https://192.0.2.100/ConfigurationManager/v1/objects/external-parity-groups/1-1/actions/disconnect/invoke -d ""
```

Deleting an iSCSI name of an external storage system that is registered to a port on the local storage system

This request deletes information about an iSCSI name (on the external storage system) that is registered to the local storage system.



Note:

- 0 is assumed for the virtual port ID if virtual port mode is enabled for the local storage system.

Execution permission

Storage Administrator (Provisioning)

Request line

```
POST base-URL/v1/objects/iscsi-ports/object-ID/actions/remove/invoke
```

Request message

Object ID

Specify the value of `portId` that was obtained by the processing to get information about ports.

| Attribute | Type | Description |
|-----------|--------|--|
| portId | string | (Required) Port number of the local storage system |

Query parameters

None.

Body

```
{
  "parameters": {
    "iscsiIpAddress": "192.168.0.100",
    "iscsiName": "iqn.rest.example.of.iscsi1"
  }
}
```

| Attribute | Type | Description |
|----------------|--------|---|
| iscsiIpAddress | string | (Required) IP address of the iSCSI target on the external storage system Specify an IPv4 or IPv6 IP address. |
| iscsiName | string | (Required) iSCSI name of the iSCSI target on the external storage system Specify the name in iqn or eui format. This attribute is case sensitive. |

Response message

A job object is returned. For details about attributes other than `affectedResources`, see the description of job objects.

| Attribute | Description |
|-------------------|---|
| affectedResources | URL of the port (on the local storage system) whose iSCSI name information about the external storage system has been deleted |

Action template

None.

Status codes

For details about the status codes of the request for this operation, see the description of HTTP status codes.

Coding example

```
curl -v -H "Accept:application/json" -H "Content-Type:application/json" -H  
"Authorization:Session f76884c29fff4dfaa664aa6981087b71" -X POST  
"https://192.0.2.100/ConfigurationManager/v1/objects/iscsi-ports/CL1-A/  
actions/remove/invoke"
```

Chapter 15: Initial settings for a storage system

This chapter describes the initial settings for a storage system that are performed by using the REST API.

Overview of the initial settings of a storage system

This section describes the operations that can be performed by using the REST API, related to the initial settings of a storage system.

For VSP 5000 series

You can perform the following operations:

- Setting the transfer destinations for audit log files
Specify settings related to the transfer of audit log files from a storage system to the syslog servers. You can also upload to the storage system the certificate files that are required when SSL communication is used to transfer audit log files between a storage system and the syslog servers.
- Setting the SNMP notification destinations
Specify settings related to reporting error information (SIM) of a storage system by using SNMP. To perform a test transmission of the SNMP trap, use Hitachi Device Manager - Storage Navigator.
- License management
Set software licenses.
- Changing the user information used in searches of the external authentication server
Change the DN (Distinguished Name) and password of the user used in searches of the external authentication server set for the storage system.

For VSP E series, VSP G350, G370, G700, G900, VSP F350, F370, F700, F900

- Setting the system date and time for a storage system
Set the system date and time for a storage system.
- Setting the transfer destinations for audit log files
Specify settings related to the transfer of audit log files from a storage system to the syslog servers. You can also upload to the storage system the certificate files that are required when SSL communication is used to transfer audit log files between a storage system and the syslog servers.

- Setting the SNMP notification destinations
Specify settings related to reporting error information (SIM) of a storage system by using SNMP.
- Setting error notification emails
Specify settings related to reporting error information (SIM) of a storage system by using emails.
- License management
Set software licenses.
- Changing the user information used in searches of the external authentication server
Change the DN (Distinguished Name) and password of the user used in searches of the external authentication server set for the storage system.

Related manuals

For details about the initial settings of the storage system, see the following manuals.

- *System Administrator Guide*
- *Hitachi Alert Notification Guide* (VSP 5000 series)
- *Hitachi SNMP Agent User Guide* (VSP E series, VSP G350, G370, G700, G900, VSP F350, F370, F700, F900)

Getting the system date and time of a storage system

The following request gets the system date and time of a storage system.



Note:

You can use this API function for VSP E series, VSP G350, G370, G700, G900, VSP F350, F370, F700, F900.

Execution permission

Storage Administrator (View Only)

Request line

```
GET base-URL/v1/objects/date-times/instance
```

Request message

Object ID

Specify *instance*.

If an object has only one instance, the *instance* is the fixed value that specifies the object ID.

Query parameters

None.

Body

None.

Response message**Body**

```
{
  "isNtpEnabled": true,
  "ntpServerNames": [
    "192.0.2.200"
  ],
  "timeZoneId": "America/Los_Angeles",
  "systemTime": "2016-07-20T17:02:12Z",
  "synchronizingLocalTime": "22:00",
  "adjustsDaylightSavingTime": true
}
```

| Attribute | Type | Description |
|---------------------------|---------------|--|
| isNtpEnabled | boolean | Whether to synchronize the time with the NTP server <ul style="list-style-type: none"> ▪ <code>true</code>: Synchronize the time with the NTP server ▪ <code>false</code>: Do not synchronize the time with the NTP server |
| ntpServerNames | string[] | The IP address or host name of the NTP server This attribute is displayed if the time is synchronized with the NTP server. |
| timeZoneId | string | Time zone ID |
| systemTime | ISO8601string | System date and time (UTC) |
| synchronizingLocalTime | string | Synchronization time with the NTP server (local time) This attribute is displayed if the time is synchronized with the NTP server. |
| adjustsDaylightSavingTime | boolean | Whether to automatically adjust for daylight saving time |

| Attribute | Type | Description |
|-----------|------|---|
| | | <p>This attribute is displayed if the time zone supports daylight saving time.</p> <ul style="list-style-type: none"> <code>true</code>: Adjust for daylight saving time <code>false</code>: Do not adjust for daylight saving time |

Status codes

The following table describes the meaning of the status code of the request for this operation. For details on other status codes, see the description of HTTP status codes.

| Status code | Message | Description |
|-------------|---------------------|--|
| 412 | Precondition Failed | The microcode version of the storage system does not support this operation. |

Coding example

```
curl -v -H "Accept:application/json" -H "Content-Type:application/json" -H
"Authorization:Session d7b673af189048468c5af9bcf3b6bb6f" -X GET https://
192.0.2.100/ConfigurationManager/v1/objects/date-times/instance
```

Getting a list of time zones that can be used in a storage system

The following request checks the time zones that can be used when you set the system date and time of a storage system or other information.



Note:

You can use this API function for VSP E series, VSP G350, G370, G700, G900, VSP F350, F370, F700, F900.

Execution permission

Storage Administrator (View Only)

Request line

```
GET base-URL/v1/objects/time-zones
```

Request message

Object ID

None.

Query parameters

None.

Body

None.

Response message

Body

```
{
  "data": [
    {
      "timeZoneId": "Etc/GMT+12",
      "timeZone": "(UTC-12:00)",
      "displayName": "International Date Line West",
      "observesDaylightSavingTime": false
    },
    {
      "timeZoneId": "Etc/GMT+11",
      "timeZone": "(UTC-11:00)",
      "displayName": "Coordinated Universal Time-11",
      "observesDaylightSavingTime": false
    },
    {
      "timeZoneId": "Pacific/Honolulu",
      "timeZone": "(UTC-10:00)",
      "displayName": "Hawaii",
      "observesDaylightSavingTime": false
    }
  ]
}
```

| Attribute | Type | Description |
|-------------|--------|------------------------------------|
| timeZoneId | string | Time zone ID |
| timeZone | string | Time zone |
| displayName | string | Displays the name of the time zone |

| Attribute | Type | Description |
|----------------------------|---------|---|
| observesDaylightSavingTime | boolean | Whether daylight saving time is supported <ul style="list-style-type: none"> ▪ <code>true</code>: Daylight saving time is supported. ▪ <code>false</code>: Daylight saving time is not supported. |

Status codes

The following table describes the meaning of the status code of the request for this operation. For details on other status codes, see the description of HTTP status codes.

| Status code | Message | Description |
|-------------|---------------------|--|
| 412 | Precondition Failed | The microcode version of the storage system does not support this operation. |

Coding example

```
curl -v -H "Accept:application/json" -H "Content-Type:application/json" -H "Authorization:Session d7b673af189048468c5af9bcf3b66b6f" -X GET https://192.0.2.100/ConfigurationManager/v1/objects/time-zones
```

Setting the system date and time of a storage system

The following request sets the system date and time of a storage system.



Note:

- You can use this API function for VSP E series, VSP G350, G370, G700, G900, VSP F350, F370, F700, F900.
- If you locked any resources of the target storage system by using the REST API, you will not be able to use this API function. In such cases, unlock the resources before running the API function.

Execution permission

Storage Administrator (Initial Configuration)

Request line

```
PATCH base-URL/v1/objects/date-times/instance
```

Request message**Object ID**

Specify `instance`.

If an object has only one instance, the `instance` is the fixed value that specifies the object ID.

Query parameters

None.

Body

```
{
  "isNtpEnabled": true,
  "ntpServerNames": [
    "192.0.2.200",
    "192.0.2.300"
  ],
  "timeZoneId": "America/Los_Angeles",
  "systemTime": "2016-07-20T17:02:12Z",
  "synchronizingLocalTime": "22:00",
  "adjustsDaylightSavingTime": true,
  "synchronizesNow": true
}
```

| Attribute | Type | Description |
|-----------------------------|----------|--|
| <code>isNtpEnabled</code> | boolean | (Required) Whether to synchronize the time with the NTP server <ul style="list-style-type: none"> ▪ <code>true</code>: Synchronize the time with the NTP server ▪ <code>false</code>: Do not synchronize the time with the NTP server |
| <code>ntpServerNames</code> | string[] | (Optional) The IP address or host name of the NTP server You can specify this attribute only if <code>true</code> is specified for the <code>isNtpEnabled</code> attribute. If <code>true</code> is specified for the <code>isNtpEnabled</code> attribute, you must specify this attribute. |

| Attribute | Type | Description |
|---------------------------|---------------|---|
| | | If you specify multiple NTP servers, use commas to delimit the names. You can set a maximum of 5 NTP servers. |
| timeZoneId | string | (Required) Time zone ID Specify a time zone ID that you obtained by using the API function that obtains a list of available time zones for the storage system. |
| systemTime | ISO8601string | (Required) System date and time (UTC) Specify a date between January 1, 2000 and December 31, 2037 in YYYY-MM-DDThh:mm:ssZ format. If the time zone specified for the <code>timeZoneId</code> attribute uses daylight saving time and the <code>adjustsDaylightSavingTime</code> attribute is set to <code>true</code> , you cannot set a time that is within the transition period of standard time to daylight saving time or the transition period of daylight saving time to standard time. The specified system date and time might be different from the date and time actually set on the storage system by several seconds. To set an accurate date and time, we recommend that you synchronize the date and time with the NTP server. |
| synchronizingLocalTime | string | (Optional) Synchronization time with the NTP server (local time) You can specify this attribute only if <code>true</code> is specified for the <code>isNtpEnabled</code> attribute. Specify a time between 00:00 and 23:59 in "hh:mm" format. If this attribute is omitted, 00:00 is assumed to be set. |
| adjustsDaylightSavingTime | boolean | (Optional) Whether to automatically switch to daylight saving time |

| Attribute | Type | Description |
|-----------------|---------|---|
| | | <p>You can specify this attribute only if the time zone specified for the <code>timeZoneId</code> attribute supports daylight saving time.</p> <p>You cannot specify this attribute if the specified time zone does not support daylight saving time. To check whether the time zone supports daylight saving time, you can use the API function that obtains a list of available time zones for the storage system.</p> <ul style="list-style-type: none"> ▪ <code>true</code>: Switch to daylight saving time ▪ <code>false</code>: Do not switch to daylight saving time <p>If this attribute is omitted, <code>true</code> is assumed to be set.</p> |
| synchronizesNow | boolean | <p>(Optional) Whether to immediately synchronize with the NTP server</p> <p>You can specify this attribute only when <code>true</code> is specified for the <code>isNtpEnabled</code> attribute.</p> <ul style="list-style-type: none"> ▪ <code>true</code>: Immediately synchronize with the NTP server ▪ <code>false</code>: Do not synchronize with the NTP server until the synchronization time <p>If you specify <code>false</code> for this attribute, the time will be set as the time specified for the <code>systemTime</code> attribute until the time specified for the <code>synchronizingLocalTime</code> attribute.</p> <p>If this attribute is omitted, <code>true</code> is assumed to be set.</p> |

Response message**Body**

```
{
  "isNtpEnabled": true,
  "ntpServerNames": [
    "192.0.2.200",
    "192.0.2.300"
  ],
  "timeZoneId": "America/Los_Angeles",
  "systemTime": "2016-07-20T17:02:12Z",
  "synchronizingLocalTime": "22:00",
  "adjustsDaylightSavingTime": true
}
```

| Attribute | Type | Description |
|---------------------------|---------------|--|
| isNtpEnabled | boolean | Whether to synchronize the time with the NTP server <ul style="list-style-type: none"> ▪ true: Synchronize the time with the NTP server ▪ false: Do not synchronize the time with the NTP server |
| ntpServerNames | string[] | The IP address or host name of the NTP server |
| timeZoneId | string | Time zone ID |
| systemTime | ISO8601string | System date and time (UTC) |
| synchronizingLocalTime | string | Synchronization time with the NTP server (local time) |
| adjustsDaylightSavingTime | boolean | Whether to automatically switch to daylight saving time <ul style="list-style-type: none"> ▪ true: Switch to daylight saving time ▪ false: Do not switch to daylight saving time |

Action template

None.

Status codes

The following table describes the meaning of the status code of the request for this operation. For details on other status codes, see the description of HTTP status codes.

| Status code | Message | Description |
|-------------|---------------------|--|
| 412 | Precondition Failed | The microcode version of the storage system does not support this operation. |

Coding example

```
curl -v -H "Accept:application/json" -H "Content-Type:application/json" -H
"Authorization:Session d7b673af189048468c5af9bcf3b6bb6f" -X PATCH --data-
binary @./InputParameters.json https://192.0.2.100/ConfigurationManager/v1/
objects/date-times/instance
```

Uploading the files required for initial configuration

The following request uploads the files required for the initial configuration of storage systems. The files are uploaded from a REST API client to the storage system. In the request header of this API function, specify `multipart/form-data` for Content-Type.

For a list of storage systems that support this API, see [Overview of the initial settings of a storage system \(on page 900\)](#).

If SSL communication is used between the storage system and the syslog server, run this API function to upload the required certificate file to the storage system in advance. After that, run the API function for setting the transfer destinations of the audit log. When you do so, the storage system will be set to use the uploaded certificate file for communication.

**Important:**

- Only one file can be uploaded in one request.
- If files with the same `fileType` attribute are already uploaded, the currently uploaded file will be overwritten by the file to be uploaded.

Execution permission

Audit Log Administrator (View & Modify)

Request header

In this API, the request body is sent in the format of `multipart/form-data`. Specify `multipart/form-data` for the Content-Type of the request header.

Request line

POST *base-URL*/v1/objects/actions/file-upload/invoke

Request message

Object ID

None.

Query parameters

None.

Body

| Attribute | Type | Description |
|-----------|--------|---|
| fileType | string | <p>(Required) File type of the file to be uploaded</p> <p>The specifiable values are as follows:</p> <ul style="list-style-type: none"> ▪ AuditSyslogPrimaryClientCertFile: Client certificate file of the syslog server to which audit log files are to be transferred (for the primary server) ▪ AuditSyslogPrimaryRootCertFile: Root certificate file of the syslog server to which audit log files are to be transferred (for the primary server) ▪ AuditSyslogSecondaryClientCertFile: Client certificate file of the syslog server to which audit log files are to be transferred (for the secondary server) ▪ AuditSyslogSecondaryRootCertFile: Root certificate file of the syslog server to which audit log files are to be transferred (for the secondary server) |
| file | file | <p>(Required) File to be uploaded</p> <p>You can use the following characters:</p> <ul style="list-style-type: none"> ▪ Spaces ▪ Alphanumeric characters ▪ The following symbols: ! " # \$ % & ' () * + , - . : ; < = > ? @ [\] ^ _ ` { } ~ |

Response message

Body

None.

Status codes

For details on the status codes of the request for this operation, see the description of HTTP status codes.

If HTTP status code 502 is returned, make sure the file is correctly specified, and then run the API request again.

Coding example

```
curl -v -H "Accept:application/json" -H "Content-Type: multipart/form-data" -H "Authorization:Session d7b673af189048468c5af9bcf3b66b6f" -H "Expect:" -X POST -F "file=@C:\certfile.crt" -F "fileType=AuditSyslogPrimaryClientCertFile" https://192.0.2.100/ConfigurationManager/v1/objects/actions/file-upload/invoke
```

If you run a request in which `multipart/form-data` is specified for `Content-Type`, `Expect: 100-continue` might be automatically assigned to the header, depending on the specifications of the client software. For VSP E series, VSP G350, G370, G700, G900, VSP F350, F370, F700, F900 storage systems, depending on the specifications of the web server, this header might not be accepted. If the header is not accepted, a 417 error occurs, and the request fails. In this coding example, the `Expect` header is specified to overwrite the automatically assigned header, thereby preventing this error.

Getting information about the transfer destinations of audit log files

The following request gets information, specified for a storage system, about the settings related to the transfer of audit log files to the syslog servers.

For a list of storage systems that support this API, see [Overview of the initial settings of a storage system \(on page 900\)](#).

Execution permission

Audit Log Administrator (View Only)

Request line

```
GET base-URL/v1/objects/auditlog-syslog-servers/instance
```

Request message**Object ID**

Specify *instance*.

If an object has only one instance, the *instance* is the fixed value that specifies the object ID.

Query parameters

None.

Body

None.

Response message**Body**

```
{
  "transferProtocol": "TLS",
  "locationName": "886000123456",
  "retries": true,
  "retryInterval": 30,
  "isDetailed": true,
  "primarySyslogServer": {
    "isEnabled": true,
    "ipAddress": "192.0.1.100",
    "port": 12345
  },
  "secondarySyslogServer": {
    "isEnabled": true,
    "ipAddress": "192.0.1.200",
    "port": 12345
  }
}
```

| Attribute | Type | Description |
|------------------|---------|--|
| transferProtocol | string | Protocol to be used when transferring audit log files to the syslog servers <ul style="list-style-type: none"> ▪ TLS: TLS1.2/RFC5424 ▪ UDP: UDP/RFC3164 If the transfer destination of audit log files has not been set, <code>undefined</code> will be output for VSP 5000 series storage systems, but <code>UDP</code> will be output for VSP E series, VSP G350, G370, G700, G900 , VSP F350, F370, F700, F900 storage systems. |
| locationName | string | Name of the storage system from which audit log files are to be transferred |
| retries | boolean | Specifies whether to try again if communication with a syslog server fails |

| Attribute | Type | Description |
|------------------------------------|----------------------|---|
| | | <p>This attribute is displayed if the <code>transferProtocol</code> attribute is <code>TLS</code>.</p> <ul style="list-style-type: none"> <code>true</code>: Tries again <code>false</code>: Does not try again |
| <code>retryInterval</code> | <code>int</code> | <p>Retry interval (in seconds) when communication with a syslog server fails</p> <p>This attribute is displayed if the <code>retries</code> attribute is <code>true</code>.</p> |
| <code>isDetailed</code> | <code>boolean</code> | <p>Specifies whether to transfer detailed information about audit log files to the syslog servers</p> <ul style="list-style-type: none"> <code>true</code>: Transfers detailed information <code>false</code>: Does not transfer detailed information |
| <code>primarySyslogServer</code> | <code>object</code> | <p>Settings of the primary-site syslog server</p> <p>The following information about the primary-site syslog server is displayed:</p> <ul style="list-style-type: none"> <code>isEnabled</code> (boolean) <ul style="list-style-type: none"> Whether audit log files are transferred to the syslog server <code>true</code>: Audit log files are transferred to the syslog server <code>false</code>: Audit log files are not transferred to the syslog server <code>ipAddress</code> (string) <ul style="list-style-type: none"> IP address or host name of the server This is displayed when the value of the <code>isEnabled</code> attribute is <code>true</code>. <code>port</code> (int) <ul style="list-style-type: none"> Port number This is displayed when the value of the <code>isEnabled</code> attribute is <code>true</code>. |
| <code>secondarySyslogServer</code> | <code>object</code> | Settings of the secondary-site syslog server |

| Attribute | Type | Description |
|-----------|------|--|
| | | <p>The following information about the secondary-site syslog server is displayed:</p> <ul style="list-style-type: none"> ▪ isEnabled (boolean) Whether audit log files are transferred to the syslog server <ul style="list-style-type: none"> ▪ <code>true</code>: Audit log files are transferred to the syslog server ▪ <code>false</code>: Audit log files are not transferred to the syslog server ▪ ipAddress (string) IP address or host name of the server This is displayed when the value of the <code>isEnabled</code> attribute is <code>true</code>. ▪ port (int) Port number This is displayed when the value of the <code>isEnabled</code> attribute is <code>true</code>. |

Status codes

For details on the status codes of the request for this operation, see the description of HTTP status codes.

Coding example

```
curl -v -H "Accept:application/json" -H "Content-Type:application/json" -H
"Authorization:Session d7b673af189048468c5af9bcf3bbbb6f" -X GET https://
192.0.2.100/ConfigurationManager/v1/objects/auditlog-syslog-servers/
instance
```

Specifying the transfer destinations of audit log files

The following request specifies settings related to the transfer of audit log files from a storage system to the syslog servers. Run this API function with `https` specified as the protocol to be used.

For a list of storage systems that support this API, see [Overview of the initial settings of a storage system \(on page 900\)](#).

**Note:**

- If SSL communication is to be used to transfer audit log files between syslog servers, upload the necessary certificate files to the storage system before specifying the transfer destinations of audit log files.
- If you locked the resources of the target storage system by using the REST API, you will not be able to use the API function for specifying the transfer destinations of audit log files. In such cases, unlock the resources before running the API function.
- When specifying the transfer destinations of audit log files for VSP 5000 series, number of the retry and the timeout value are set as 1 and 120 sec.

Execution permission

Audit Log Administrator (View & Modify)

Request line

```
PATCH base-URL/v1/objects/auditlog-syslog-servers/instance
```

Request message**Object ID**

Specify *instance*.

If an object has only one instance, the *instance* is the fixed value that specifies the object ID.

Query parameters

None.

Body

```
{
  "transferProtocol": "TLS",
  "locationName": "886000123456",
  "retries": true,
  "retryInterval": 30,
  "isDetailed": true,
  "primarySyslogServer": {
    "isEnabled": true,
    "ipAddress": "192.0.1.100",
    "port": 12345,
    "clientCertFileName": "primaryClientCert.crt",
    "clientCertFilePassword": "123456",
    "rootCertFileName": "primaryRootCert.crt"
  },
  "secondarySyslogServer": {
    "isEnabled": true,
```

```

"ipAddress": "192.0.1.200",
"port": 12345,
"clientCertFileName": "secondaryClientCert.crt",
"clientCertFilePassword": "123456",
"rootCertFileName": "secondaryRootCert.crt"
}
}

```

| Attribute | Type | Description |
|------------------|---------|---|
| transferProtocol | string | <p>(Required) Protocol used when transferring audit log files to syslog servers</p> <p>Specify one of the following values:</p> <ul style="list-style-type: none"> ▪ TLS: TLS1.2/RFC5424 ▪ UDP: UDP/RFC3164 |
| locationName | string | <p>(Required) Name of the storage system from which audit log files are to be transferred</p> <p>Specify a character string consisting of 1 to 32 characters. You can use the following characters:</p> <ul style="list-style-type: none"> ▪ Alphanumeric characters ▪ The following symbols: ! " # \$ % & ' () * + - . / : ; < = > ? @ [\] ^ _ ` { } ~ |
| retries | boolean | <p>(Optional) Specify whether to try again if communication with a syslog server fails.</p> <p>If the <code>transferProtocol</code> attribute is <code>TLS</code>, specify either of the following values:</p> <ul style="list-style-type: none"> ▪ <code>true</code>: Try again. ▪ <code>false</code>: Do not try again. <p>If you omit this item, <code>true</code> is assumed.</p> |
| retryInterval | int | <p>(Optional) Retry interval (in seconds) if communication with a syslog server fails</p> <p>If the <code>retries</code> attribute is <code>true</code>, specify a value in the range from 1 to 60. If you omit this item, 1 will be set.</p> |
| isDetailed | boolean | <p>(Optional) Specify whether to transfer detailed information about audit log files to the syslog servers.</p> |

| Attribute | Type | Description |
|---------------------|--------|--|
| | | Specify one of the following values: <ul style="list-style-type: none"> ▪ <code>true</code>: Transfer detailed information. ▪ <code>false</code>: Do not transfer detailed information. If you omit this item, <code>true</code> is assumed. |
| primarySyslogServer | object | (Required) Settings of the primary-site syslog server |

| Attribute | Type | Description |
|-----------|------|---|
| | | <p>Specify values for the following attributes of the primary-site syslog server:</p> <ul style="list-style-type: none"> ▪ isEnabled (boolean) <p>(Required) Specify whether audit log files are to be transferred to the syslog server.</p> <ul style="list-style-type: none"> ▪ <code>true</code>: Transfer audit log files. ▪ <code>false</code>: Do not transfer audit log files. ▪ ipAddress (string) <p>(Optional) IP address or host name of the server</p> <p>You must specify this attribute if <code>true</code> is specified for <code>isEnabled</code>.</p> <p>You can specify an IPv4 address, an IPv6 address, or a host name.</p> <p>Specify a name consisting of 1 to 255 characters.</p> <p>You can use the following characters in the host name:</p> <ul style="list-style-type: none"> • Alphanumeric characters • The following symbols: ! \$ % - . @ _ ` ~ ▪ port (int) <p>(Optional) Port number</p> <p>You must specify this attribute if <code>true</code> is specified for <code>isEnabled</code>.</p> ▪ clientCertFileName (string) <p>(Optional) Name of the client certificate file</p> <p>You must specify this attribute if <code>true</code> is specified for <code>isEnabled</code> and TLS is specified for <code>transferProtocol</code>. If you specify this attribute, the certificate file that was uploaded to the storage system will be set to be used. (The system will not check whether the file name of the certificate matches the file name specified for this attribute.) If a null character string is specified for this attribute, the certificate file that</p> |

| Attribute | Type | Description |
|------------------------------------|--------|---|
| | | <p>is already set for the storage system will be used.</p> <ul style="list-style-type: none"> ▪ <code>clientCertFilePassword</code> (string) (Optional) Password for client certificate You must specify this attribute if <code>true</code> is specified for <code>isEnabled</code> and TLS is specified for <code>transferProtocol</code>. ▪ <code>rootCertFileName</code> (string) (Optional) File name for root certificate You must specify this attribute if <code>true</code> is specified for <code>isEnabled</code> and TLS is specified for <code>transferProtocol</code>. If you specify this attribute, the certificate file that was uploaded to the storage system will be set to be used. (The system will not check whether the file name of the certificate matches the file name specified for this attribute.) If a null character string is specified for this attribute, the certificate file that is already set for the storage system will be used. |
| <code>secondarySyslogServer</code> | object | (Required) Settings of the secondary-site syslog server |

| Attribute | Type | Description |
|-----------|------|---|
| | | <p>Specify values for the following attributes of the secondary-site syslog server:</p> <ul style="list-style-type: none"> ▪ isEnabled (boolean) <ul style="list-style-type: none"> (Required) Specify whether audit log files are to be transferred to the syslog server. ▪ <code>true</code>: Transfer audit log files. ▪ <code>false</code>: Do not transfer audit log files. ▪ ipAddress (string) <ul style="list-style-type: none"> (Optional) IP address or host name of the server You must specify this attribute if <code>true</code> is specified for <code>isEnabled</code>. You can specify an IPv4 address, an IPv6 address, or a host name. Specify a name consisting of 1 to 255 characters. You can use the following characters in the host name: <ul style="list-style-type: none"> • Alphanumeric characters • The following symbols: ! \$ % - . @ _ ` ~ ▪ port (int) <ul style="list-style-type: none"> (Optional) Port number You must specify this attribute if <code>true</code> is specified for <code>isEnabled</code>. ▪ clientCertFileName (string) <ul style="list-style-type: none"> (Optional) Name of the client certificate file You must specify this attribute if <code>true</code> is specified for <code>isEnabled</code> and TLS is specified for <code>transferProtocol</code>. If you specify this attribute, the certificate file that was uploaded to the storage system will be set to be used. (The system will not check whether the file name of the certificate matches the file name specified for this attribute.) If a null character string is specified for this attribute, the certificate file that |

| Attribute | Type | Description |
|-----------|------|---|
| | | <p>is already set for the storage system will be used.</p> <ul style="list-style-type: none"> clientCertFilePassword (string) (Optional) Password for client certificate You must specify this attribute if <code>true</code> is specified for <code>isEnabled</code> and TLS is specified for <code>transferProtocol</code>. rootCertFileName (string) (Optional) File name for root certificate You must specify this attribute if <code>true</code> is specified for <code>isEnabled</code> and TLS is specified for <code>transferProtocol</code>. If you specify this attribute, the certificate file that was uploaded to the storage system will be set to be used. (The system will not check whether the file name of the certificate matches the file name specified for this attribute.) If a null character string is specified for this attribute, the certificate file that is already set for the storage system will be used. |

Response message

Body

A job object is returned. For details on attributes other than `affectedResources`, see the description of job objects.

| Attribute | Description |
|--------------------------------|--|
| <code>affectedResources</code> | URL of the transfer destinations set for the audit log files of the storage system |

Status codes

For details on the status codes of the request for this operation, see the description of HTTP status codes.

Coding example

```
curl -v -H "Accept:application/json" -H "Content-Type:application/json" -H
"Authorization:Session d7b673af189048468c5af9bcf3bbbb6f" -X PATCH --data-
```

```
binary @./InputParameters.json https://192.0.2.100/ConfigurationManager/v1/objects/auditlog-syslog-servers/instance
```

Sending test messages to the transfer destinations of audit log files

The following request sends test messages to the syslog servers to verify that the settings related to the transfer destinations of audit log files are correctly specified.

For a list of storage systems that support this API, see [Overview of the initial settings of a storage system \(on page 900\)](#).



Note:

If you locked the resources of the target storage system by using the REST API, you will not be able to use the API function for sending test messages. In such cases, unlock the resources before running the API function.

Execution permission

Audit Log Administrator (View & Modify)

Request line

```
POST base-URL/v1/objects/auditlog-syslog-servers/instance/actions/send-test/invoke
```

Request message

Object ID

Specify *instance*.

If an object has only one instance, the *instance* is the fixed value that specifies the object ID.

Query parameters

None.

Body

None.

Response message

Body

A job object is returned. For details on the schema of job objects, see the description of job objects.

Action template

None.

Status codes

For details on the status codes of the request for this operation, see the description of HTTP status codes.

Coding example

```
curl -v -H "Accept:application/json" -H "Content-Type:application/json" -H
"Authorization:Session d7b673af189048468c5af9bcf3bbbb6f" -X POST https://
192.0.2.100/ConfigurationManager/v1/objects/auditlog-syslog-servers/
instance/actions/send-test/invoke -d ""
```

Getting SNMP settings

The following request explains how to obtain the SNMP settings for a storage system.

For a list of storage systems that support this API, see [Overview of the initial settings of a storage system \(on page 900\)](#).

Execution permission

Storage Administrator (View Only)

Request line

```
GET base-URL/v1/objects/snmp-settings/instance
```

Request message**Object ID**Specify *instance*.

If an object has only one instance, the *instance* is the fixed value that specifies the object ID.

Query parameters

None.

Body

None.

Response message**Body**

The following is an example of output when the SNMP version is SNMP v1:

```
{
  "isSNMPAgentEnabled": true,
  "snmpVersion": "v1",
  "sendingTrapSetting": {
    "snmpv1v2cSettings": [
      {
        "community": "MyRestSNMPCommunity1",
        "sendTrapTo": [
          "192.0.2.100",
          "192.0.2.200"
        ]
      }
    ]
  },
  "requestAuthenticationSetting": {
    "snmpv1v2cSettings": [
      {
        "community": "MyRestSNMPCommunity2",
        "requestsPermitted": [
          "192.0.3.100"
        ]
      }
    ]
  },
  "systemGroupInformation": {
    "storageSystemName": "VSP_G700",
    "contact": "confmanager.@example.com",
    "location": "Data Center 1F"
  },
  "snmpEngineID": "0x80000074046361336663353061"
}
```

The following is an example of output when the SNMP version is SNMP v3:

```
{
  "isSNMPAgentEnabled": true,
  "snmpVersion": "v3",
  "sendingTrapSetting": {
    "snmpv3Settings": [
      {
        "userName": "MyRestSNMPUser1",
        "sendTrapTo": "192.0.2.100",
        "authentication": {
          "protocol": "SHA",

```

```

    "password": "",
    "encryption": {
      "protocol": "AES",
      "key": ""
    }
  },
  {
    "userName": "MyRestSNMPUser2",
    "sendTrapTo": "192.0.2.200"
  }
]
},
"requestAuthenticationSetting": {
  "snmpv3Settings": [
    {
      "userName": "MyRestSNMPUser3",
      "authentication": {
        "protocol": "MD5",
        "password": "",
        "encryption": {
          "protocol": "DES",
          "key": ""
        }
      }
    }
  ]
},
"systemGroupInformation": {
  "storageSystemName": "VSP_G700",
  "contact": "confmanager@example.com",
  "location": "Data Center 1F"
},
"snmpEngineID": "0x80000074046361336663353061"
}

```

| Attribute | Type | Description |
|--------------------|---------|---|
| isSNMPAgentEnabled | boolean | <p>Whether the SNMP Agent is enabled</p> <ul style="list-style-type: none"> ▪ true: Enabled ▪ false: Disabled <p>If this attribute is <code>true</code>, error information (SIM) is reported by SNMP traps. Also, SNMP operation requests (GET REQUEST, GETNEXT REQUEST, and GETBULK REQUEST) are received.</p> |

| Attribute | Type | Description |
|-------------|--------|--|
| snmpVersion | string | <p>SNMP version</p> <p>Outputs the SNMP version that is being used.</p> <ul style="list-style-type: none">▪ v1 : SNMP v1▪ v2c : SNMP v2c▪ v3 : SNMP v3 <p>If this attribute is not set, Unestablished is output.</p> |

| Attribute | Type | Description |
|------------------------------|--------|--|
| sendingTrapSetting | object | <p>SNMP trap destinations</p> <ul style="list-style-type: none"> ▪ snmpv1v2cSettings (object[]) <p>Array of settings for SNMP trap destinations</p> <p>This is output when there is a setting for which the SNMP version is SNMPv1 or SNMPv2c.</p> <ul style="list-style-type: none"> • community (string) <p>Community name used for SNMP trap reports</p> • sendTrapTo (string[]) <p>Array of IP addresses to which SNMP traps are sent</p> <p>The addresses are output in IPv4 or IPv6 IP.</p> ▪ snmpv3Settings (object[]) <p>Array of the settings for SNMP trap destinations</p> <p>This is output when there is a setting for which the SNMP protocol version is SNMP v3.</p> <ul style="list-style-type: none"> • userName (string) <p>User name that is used for SNMP trap reports</p> • sendTrapTo (string) <p>The IP address to which an SNMP trap is sent</p> <p>This is output in IPv4 or IPv6 format.</p> • authentication (object) <p>Authentication information</p> <p>This is output when password-based authentication is enabled. For details on the output attributes, see the table of the attributes output to the <code>authentication</code> attribute.</p> |
| requestAuthenticationSetting | object | Settings for permitted requests. |

| Attribute | Type | Description |
|-----------|------|---|
| | | <p>Settings for the permitted requests (GET REQUEST, GETNEXT REQUEST, and GETBULK REQUEST) of SNMP operations are output.</p> <ul style="list-style-type: none"> ▪ <code>snmpv1v2cSettings</code> (object[]) <ul style="list-style-type: none"> Array of the settings for permitted requests This is output when there is a setting for which the SNMP protocol version is SNMPv1 or SNMPv2c. <ul style="list-style-type: none"> • <code>community</code> (string) <ul style="list-style-type: none"> Name of the community that receives requests • <code>requestsPermitted</code> (string[]) <ul style="list-style-type: none"> Array of the IP addresses of the SNMP Managers that receive requests This is output in IPv4 or IPv6 format. If the array is empty, requests of all SNMP Managers are received. ▪ <code>snmpv3Settings</code> (object[]) <ul style="list-style-type: none"> Array of the settings for permitted requests This is output when there is a setting for which the SNMP version is SNMP v3. <ul style="list-style-type: none"> • <code>userName</code> (string) <ul style="list-style-type: none"> Name of the user who receives requests • <code>authentication</code> (object) <ul style="list-style-type: none"> Authentication information This is output when password-based authentication is enabled. For details on the output attributes, see the table of the attributes output to the <code>authentication</code> attribute. |

| Attribute | Type | Description |
|------------------------|--------|--|
| systemGroupInformation | object | Information of the system group <ul style="list-style-type: none"> ▪ storageSystemName (string) Name of the storage system ▪ contact (string) Contact information or name of the administrator ▪ location (string) Location of the storage system |
| snmpEngineID | string | ID identifying the SNMP engine |

The following table shows the attributes output to the `authentication` attribute.

| Attribute | Type | Description |
|------------|--------|--|
| protocol | string | Authentication method The following values are output: <ul style="list-style-type: none"> ▪ SHA ▪ MD5 |
| password | string | Password An empty character string is output even if a password has been set. |
| encryption | object | Encryption information This is output when encryption is enabled. <ul style="list-style-type: none"> ▪ protocol (string) Encryption method The following values are output: <ul style="list-style-type: none"> ▪ AES ▪ DES ▪ key (string) Encryption key An empty character string is output even if an encryption key has been set. |

Status codes

For details on the status codes of the request for this operation, see the description on HTTP status codes.

Coding example

```
curl -v -H "Accept:application/json" -H "Content-Type:application/json" -H
"Authorization:Session d7b673af189048468c5af9bcf3bbbb6f" -X GET https://
192.0.2.100/ConfigurationManager/v1/objects/snmp-settings/instance
```

Specifying the SNMP error notification destinations

The following request specifies settings related to reporting error information (SIM) of a storage system by using SNMP. Run this API function with `https` specified as the protocol to be used.

For a list of storage systems that support this API, see [Overview of the initial settings of a storage system \(on page 900\)](#).

Notes on creating the request body

Before running this API function, obtain the current settings by using the API function that obtains SNMP information. The response body you have obtained is to be used as the request body for this API function. Values other than the SNMP-version value specified in the `snmpVersion` attribute might also be output in the obtained settings information. Change only the values of the attributes that you want to change.

For the VSP 5000 series, this API only updates the values of settings supported by the SNMP version that is specified by the `snmpVersion` attribute. For example, if `v1` is set for the `snmpVersion` attribute, this API updates only the values of the items that are supported by version SNMP v1 and specified under the `sendingTrapSetting` attribute. For details, see the descriptions about the attributes of the request body.

For VSP E series, VSP G350, G370, G700, G900, VSP F350, F370, F700, F900, this API updates all settings by overwriting the existing values, including the settings of versions other than the version specified by the `snmpVersion` attribute. When you delete the information of the acquired response body, those setting contents are deleted.

**Note:**

- Null character values are output to the acquired response body for the `password` attribute and `key` attribute. Change the values only when you want to change the setting.
- You cannot change the setting for the `snmpEngineID` attribute. The value is ignored even if it is specified.
- If you locked any resources of the target storage system by using the REST API, you will not be able to use this API function. In such cases, unlock the resources before running the API function.

Execution permission

Storage Administrator (Initial Configuration)

Request linePATCH *base-URL/v1/objects/snmp-settings/instance***Request message****Object ID**Specify *instance*.

If an object has only one instance, the *instance* is the fixed value that specifies the object ID.

Query parameters

None.

Body

The following is a coding example when the SNMP version is SNMP v1:

```
{
  "isSNMPAgentEnabled": true,
  "snmpVersion": "v1",
  "sendingTrapSetting": {
    "snmpv1v2cSettings": [
      {
        "community": "MyRestSNMPCommunity1",
        "sendTrapTo": [
          "192.0.2.100",
          "192.0.2.200"
        ]
      }
    ]
  },
  "requestAuthenticationSetting": {
    "snmpv1v2cSettings": [
      {
        "community": "MyRestSNMPCommunity2",
        "requestsPermitted": [
          "192.0.3.100"
        ]
      }
    ]
  },
  "systemGroupInformation": {
    "storageSystemName": "VSP_G700",
    "contact": "confmanager@example.com",
    "location": "Data Center 1F"
  }
}
```

```

}
}

```

The following is a coding example when the SNMP version is SNMP v3:

```

{
  "isSNMPAgentEnabled": true,
  "snmpVersion": "v3",
  "sendingTrapSetting": {
    "snmpv3Settings": [
      {
        "userName": "MyRestSNMPUser1",
        "sendTrapTo": "192.0.2.100",
        "authentication": {
          "protocol": "SHA",
          "password": "TopSecretForMySNMP1",
          "encryption": {
            "protocol": "AES",
            "key": "KeyForMySNMP1"
          }
        }
      },
      {
        "userName": "MyRestSNMPUser2",
        "sendTrapTo": "192.0.2.200"
      }
    ]
  },
  "requestAuthenticationSetting": {
    "snmpv3Settings": [
      {
        "userName": "MyRestSNMPUser3",
        "authentication": {
          "protocol": "MD5",
          "password": "",
          "encryption": {
            "protocol": "DES",
            "key": ""
          }
        }
      }
    ]
  },
  "systemGroupInformation": {
    "storageSystemName": "VSP_G700",
    "contact": "confmanager@example.com",
    "location": "Data Center 1F"
  }
}

```

```

}
}

```

| Attribute | Type | Description |
|--------------------|---------|--|
| isSNMPAgentEnabled | boolean | <p>(Required) Whether SNMP Agent is enabled</p> <ul style="list-style-type: none"> ▪ true: Enabled ▪ false: Disabled <p>If this attribute is <code>true</code>, error information (SIM) is sent by using SNMP traps. Also, SNMP operation requests (GET REQUEST, GET NEXT REQUEST, and GET BULK REQUEST) are received.</p> |
| snmpVersion | string | <p>(Required) SNMP version</p> <p>Specify the SNMP version that is used. The specifiable values are as follows:</p> <ul style="list-style-type: none"> ▪ v1: SNMP v1 ▪ v2c: SNMP v2c ▪ v3: SNMP v3 |
| sendingTrapSetting | object | (Optional) SNMP trap destinations |

| Attribute | Type | Description |
|-----------|------|--|
| | | <p>Specifiable attributes vary depending on the SNMP version.</p> <ul style="list-style-type: none"> ▪ snmpv1v2cSettings (object[]) <p>(Optional) Array of the settings for SNMP trap destinations (for SNMP v1 or SNMP v2c)</p> <p>You can specify up to 32 destinations. If you specify more than one destination, you must specify a unique <code>community</code> attribute. If you specify <code>snmpv1v2cSettings</code> attribute, you must also specify both the <code>community</code> attribute and the <code>sendTrapTo</code> attribute.</p> <ul style="list-style-type: none"> • community (string) <p>Community name used to report an SNMP trap#</p> <p>Specify a character string that consists of 1 to 180 characters.</p> • sendTrapTo (string[]) <p>Array of the IP addresses to which SNMP traps are sent.</p> <p>Specify these in IPv4 or IPv6 format. You can specify up to 32 IP addresses.</p> |

| Attribute | Type | Description |
|------------------------------|--------|--|
| | | <ul style="list-style-type: none"> ▪ snmpv3Settings (object[]) (Optional) Array of the settings for SNMP trap destinations (for SNMP v3) You can specify up to 8 destinations. If you specify more than one destination, you must specify a unique <code>sendTrapTo</code> attribute. If you specify <code>snmpv3Settings</code> attribute, you must also specify both the <code>userName</code> attribute and the <code>sendTrapTo</code> attribute. <ul style="list-style-type: none"> • <code>userName</code> (string) User name that is used for SNMP trap reports# Specify a character string that consists of 1 to 32 characters. • <code>sendTrapTo</code> (string) Specify the IP address to which SNMP traps are sent. Specify these in IPv4 or IPv6 format. • <code>authentication</code> (object) (Optional) Authentication information Specify this attribute when password-based authentication is enabled. For details on the specifiable attributes, see the table of the attributes that can be specified for the <code>authentication</code> attribute. |
| requestAuthenticationSetting | object | (Optional) Settings for the permitted requests |

| Attribute | Type | Description |
|-----------|------|--|
| | | <p>Specify the settings for the permitted requests (GET REQUEST, GETNEXT REQUEST, and GETBULK REQUEST) of SNMP operations. Specifiable attributes vary depending on the SNMP version.</p> <ul style="list-style-type: none"> ▪ snmpv1v2cSettings (object[]) <p>(Optional) Array of the settings for permitted requests (for SNMP v1 or SNMP v2c)</p> <p>You can specify up to 32 requests. If you specify more than one request, you must specify a unique <code>community</code> attribute. If you specify <code>snmpv1v2cSettings</code> attribute, you must also specify both the <code>community</code> attribute and the <code>requestsPermitted</code> attribute.</p> <ul style="list-style-type: none"> • community (string) <p>Name of the community that receives requests[#]</p> <p>Specify a character string that consists of 1 to 180 characters.</p> • requestsPermitted (string[]) <p>Array of the IP addresses of the SNMP Managers that receive requests</p> <p>Specify this in IPv4 or IPv6 format. You can specify up to 32 IP addresses. If you specify an empty array, requests of all SNMP Managers are received.</p> |

| Attribute | Type | Description |
|-----------|------|---|
| | | <ul style="list-style-type: none"> <li data-bbox="878 254 1427 594"> <p>▪ snmpv3Settings (object[]) (Optional) Array of the settings for permitted requests (for SNMP v3) You can specify up to 8 requests. If you specify more than one request, you must specify a unique <code>userName</code> attribute. If you specify <code>snmpv3Settings</code> attribute, you must also specify the <code>userName</code> attribute.</p> <li data-bbox="878 617 1427 846"> <p>• <code>userName</code> (string) Name of the user who receives requests# Specify a character string that consists of 1 to 32 characters. This attribute is case sensitive.</p> <li data-bbox="878 869 1427 1178"> <p>• authentication (object) (Optional) Authentication information Specify this attribute when password-based authentication is enabled. For details on the specifiable attributes, see the table of the attributes that can be specified for the <code>authentication</code> attribute.</p> |

| Attribute | Type | Description |
|------------------------|--------|--|
| systemGroupInformation | object | <p>(Required) Information of the system group</p> <ul style="list-style-type: none"> ▪ storageSystemName (string) (Required) Name of the storage system# This is output as the sysName of the MIB of SNMP Agent. Specify a character string that consists of 1 to 180 characters. ▪ contact (string) (Required) Contact information or name of the administrator# This is output as the sysContact of the MIB of SNMP Agent. Specify a character string that consists of 0 to 180 characters. ▪ location (string) (Required) Location of the storage system# This is output as the sysLocation of the MIB of SNMP Agent. Specify a character string that consists of 0 to 180 characters. |

The following table shows the attributes that can be specified for the `authentication` attribute. If you specify `authentication` attribute, you must also specify both the `protocol` attribute and the `password` attribute.

| Attribute | Type | Description |
|-----------|--------|--|
| protocol | string | <p>Authentication method</p> <p>You can specify the following values:</p> <ul style="list-style-type: none"> ▪ SHA ▪ MD5 |
| password | string | <p>Password#</p> <p>For a VSP 5000 series storage system, specify a character string consisting of no fewer than 8 and no more than 180 characters.</p> <p>For a VSP E series, VSP G350, G370, G700, G900, VSP F350, F370, F700, F900 storage system, specify a character string consisting of no fewer than 8 and no more than 64 characters.</p> |

| Attribute | Type | Description |
|------------|--------|--|
| | | If you do not want to change the password, specify an empty character string. |
| encryption | object | <p>(Optional) Encryption information</p> <p>Specify this item to enable encryption. If you specify this attribute, you must also specify both the <code>protocol</code> attribute and the <code>key</code> attribute.</p> <ul style="list-style-type: none"> ▪ <code>protocol</code> (string) Encryption method <p>You can specify the following values:</p> <ul style="list-style-type: none"> ▪ AES ▪ DES <ul style="list-style-type: none"> ▪ <code>key</code> (string) Encryption key[#] <p>For a VSP 5000 series storage system, specify a character string consisting of no fewer than 8 and no more than 180 characters.</p> <p>For a VSP E series, VSP G350, G370, G700, G900, VSP F350, F370, F700, F900 storage system, specify a character string consisting of no fewer than 8 and no more than 64 characters.</p> <p>If you do not want to change the encryption key, specify an empty character string.</p> |

[#]: You can use the following characters:

- Alphanumeric characters
- The following symbols:

! # \$ ' () + - . = @ [] _ ` { } ~

For a VSP 5000 series storage system, the following symbols can be used for the `community` attribute.

! # \$ () + - . = @ [] _ ` { } ~

- Spaces (except at the beginning or end of a character string)

Response message

Body

A job object is returned. For details on attributes other than `affectedResources`, see the section explaining job objects.

| Attribute | Description |
|-------------------|--------------------------|
| affectedResources | URL of the SNMP settings |

Status codes

For details on the status codes of the request for this operation, see the description on HTTP status codes.

Coding example

```
curl -v -H "Accept:application/json" -H "Content-Type:application/json" -H
"Authorization:Session d7b673af189048468c5af9bcf3bbbb6f" -X PATCH --data-
binary @./InputParameters.json https://192.0.2.100/ConfigurationManager/v1/
objects/snmp-settings/instance
```

Sending a test SNMP trap

The following request sends a test SNMP trap to make sure that the settings for reporting error information (SIM) to the SNMP manager are correctly specified.

For a list of storage systems that support this API, see [Overview of the initial settings of a storage system \(on page 900\)](#).



Note:

If you locked any resources of the target storage system by using the REST API, you will not be able to use this API function. In such cases, unlock the resources before running the API function.

Execution permission

Storage Administrator (Initial Configuration)

Request line

```
POST base-URL/v1/objects/snmp-settings/instance/actions/send-trap-test/
invoke
```

Request message

Object ID

Specify *instance*.

If an object has only one instance, the *instance* is the fixed value that specifies the object ID.

Query parameters

None.

Body

None.

Response message**Body**

A job object is returned. For details on the schema of job objects, see the description of job objects.

Action template

None.

Status codes

For details on the status codes of the request for this operation, see the description of HTTP status codes.

Coding example

```
curl -v -H "Accept:application/json" -H "Content-Type:application/json" -H "Authorization:Session d7b673af189048468c5af9bcf3b66b6f" -X POST https://192.0.2.100/ConfigurationManager/v1/objects/snmp-settings/instance/actions/send-trap-test/invoke -d ""
```

Getting information about the error notification email settings

The following request gets information about settings related to the sending of email notifications for the service information messages (SIMs) of storage systems.

For a list of storage systems that support this API, see [Overview of the initial settings of a storage system \(on page 900\)](#).

Execution permission

Storage Administrator (View Only)

Request line

```
GET base-URL/v1/objects/alert-email-settings/instance
```

Request message**Object ID**

Specify `instance`.

If an object has only one instance, the `instance` is the fixed value that specifies the object ID.

Query parameters

None.

Body

None.

Response message**Body**

```
{
  "isEmailNotificationEnabled" : true,
  "mailServer" : {
    "serverName" : "server1",
    "smtpAuth" : {
      "isSmtplibAuthEnabled" : false,
      "account" : "user1",
      "password" : "*****"
    }
  },
  "fromAddress" : "from@example.com",
  "replyToAddress" : "replyTo@example.com",
  "toAddresses" : [
    {
      "attribute" : "to",
      "address" : "to@example.com"
    }
  ],
  "description" : "description"
}
```

| Attribute | Type | Description |
|----------------------------|---------|---|
| isEmailNotificationEnabled | boolean | Whether notification by error notification emails is enabled <ul style="list-style-type: none"> ▪ true: Enabled ▪ false: Disabled |
| mailServer | object | Settings related to the server that sends the error notification emails |

| Attribute | Type | Description |
|----------------|----------|--|
| | | <p>The IP address or host name of the server is displayed, along with the following SMTP authentication settings.</p> <ul style="list-style-type: none"> ▪ <code>serverName</code> (string) IP address or host name of the server ▪ <code>smtpAuth</code> (object) SMTP authentication settings for the server <ul style="list-style-type: none"> ▪ <code>isSmtpAuthEnabled</code> (boolean) Whether SMTP authentication is enabled <code>true</code>: Enabled <code>false</code>: Disabled ▪ <code>account</code> (string) Account (user name) for SMTP authentication ▪ <code>password</code> (string) Password for SMTP authentication If a password is set, four asterisks (****) are displayed. If no password is set, an empty character string is displayed. |
| fromAddress | string | Source (from) email address from which error notification emails are sent |
| replyToAddress | string | Reply-destination (reply-to) email address to which replies to error notification emails are sent |
| toAddresses | object[] | Array of destination addresses for error notification emails |

| Attribute | Type | Description |
|-------------|--------|--|
| | | <p>If destination addresses for error notification emails are set, the following information is output:</p> <ul style="list-style-type: none"> ▪ attribute (string) An attribute of a destination address for error notification emails. Either <code>to</code>, <code>cc</code>, or <code>bcc</code> is output. ▪ address (string) A destination address for error notification emails. |
| description | string | <p>Information displayed at the beginning of an error notification email</p> <p>Additional notification information that is displayed at the beginning of an error notification email is output.</p> |

Status codes

For details on the status codes of the request for this operation, see the description on HTTP status codes.

Coding example

```
curl -v -H "Accept:application/json" -H "Content-Type:application/json" -H "Authorization:Session d7b673af189048468c5af9bcf3bbbb6f" -X GET https://192.0.2.100/ConfigurationManager/v1/objects/alert-email-settings/instance
```

Specifying settings for error notification emails

The following request specifies settings related to the sending of email notifications for the service information messages (SIMs) of storage systems. You can specify, in a batch operation, the server that sends the error notification emails, additional information to be included in each email, and the destination addresses.

For a list of storage systems that support this API, see [Overview of the initial settings of a storage system \(on page 900\)](#).

**Note:**

If you locked any resources of the target storage system by using the REST API, you will not be able to use this API function. In such cases, unlock the resources before running the API function.

Execution permission

Storage Administrator (Initial Configuration)

Request line

```
PATCH base-URL/v1/objects/alert-email-settings/instance
```

Request message**Object ID**

Specify *instance*.

If an object has only one instance, the *instance* is the fixed value that specifies the object ID.

Query parameters

None.

Body

```
{
  "isEmailNotificationEnabled": true,
  "mailServer": {
    "serverName": "server1",
    "smtpAuth" : {
      "account": "user1",
      "password": "userPass"
    }
  },
  "fromAddress" : "from@example.com",
  "replyToAddress" : "reply@example.com",
  "toAddresses" : [
    {
      "attribute" : "to",
      "address" : "to@example.com"
    },
    {
      "attribute" : "cc",
      "address" : "cc@example.com"
    },
    {
      "attribute" : "bcc",
      "address" : "bcc@example.com"
    }
  ]
}
```

```

    }
  ],
  "description" : "description"
}

```

| Attribute | Type | Description |
|----------------------------|---------|---|
| isEmailNotificationEnabled | boolean | <p>(Optional) Whether to enable the sending of error notification emails</p> <ul style="list-style-type: none"> ▪ <code>true</code>: Enabled ▪ <code>false</code>: Disabled <p>If you specify <code>true</code>, be sure to specify at least one source (from) address and one destination address.</p> |

| Attribute | Type | Description |
|------------|--------|---|
| mailServer | object | <p>(Optional) Settings related to the server that sends the error notification emails</p> <ul style="list-style-type: none"> ▪ <code>serverName</code> (string) <p>(Optional) IP address or host name of the server</p> <p>If you want to enable sending error notification emails, be sure to specify the <code>serverName</code> attribute of the <code>mailServer</code> object.</p> <p>You can specify an IPv4 address, an IPv6 address, or a host name.</p> <p>Specify a name consisting of 1 to 255 characters.</p> <p>You can use the following characters in the host name:</p> <ul style="list-style-type: none"> ▪ Alphanumeric characters ▪ The following symbols: ! \$ % - . @ _ ` ~ <p>You cannot use spaces.</p> <p>To delete the IP address or host name of the server for sending emails, specify <code>false</code> for the <code>isEmailNotificationEnabled</code> attribute, and then specify an empty character string for this attribute.</p> |

| Attribute | Type | Description |
|-----------|------|--|
| | | <ul style="list-style-type: none"> <li data-bbox="878 254 1424 365">▪ smtpAuth (object) (Optional) SMTP authentication settings for the server <li data-bbox="878 390 1424 604">▪ isSmtplibAuthEnabled (boolean) (Optional) Whether to use SMTP authentication <code>true</code>: Use <code>false</code>: Do not use <li data-bbox="878 646 1424 1409">▪ account (string) (Optional) Account (user name) for SMTP authentication You must specify this attribute if <code>true</code> is specified for the <code>isSmtplibAuthEnabled</code> attribute. Specify a name consisting of 1 to 255 characters. You can use the following characters: Alphanumeric characters The following symbols: <code>! \$ % () - . @ _ ` ~</code> You cannot use spaces. To delete the account (user name) for SMTP authentication, specify <code>false</code> for the <code>isSmtplibAuthEnabled</code> attribute, and specify an empty character string for this attribute. <li data-bbox="878 1451 1424 1812">▪ password (string) (Optional) Password for SMTP authentication You must specify this attribute if <code>true</code> is specified for the <code>isSmtplibAuthEnabled</code> attribute. Specify a password consisting of 1 to 255 characters. You can use the following characters: |

| Attribute | Type | Description |
|----------------|----------|---|
| | | <p>Alphanumeric characters</p> <p>The following symbols: ! \$ % () - . @ _ ` ~</p> <p>You cannot use spaces.</p> <p>To delete the SMTP authentication password, specify <code>false</code> for the <code>isSmtpAuthEnabled</code> attribute, and specify an empty character string for this attribute.</p> |
| fromAddress | string | <p>(Optional) Source (from) email address from which error notification emails are sent[#]</p> <p>In <code>fromAddress</code>, specify a value consisting of 1 to 255 characters.</p> <p>To delete a source (from) email address from which error notification emails are sent, specify <code>false</code> for the <code>isEmailNotificationEnabled</code> attribute, and then specify an empty character string for this attribute.</p> |
| replyToAddress | string | <p>(Optional) Reply-destination (reply-to) email address to which replies to error notification emails are to be sent[#]</p> <p>In <code>replyToAddress</code>, specify a value consisting of 1 to 255 characters.</p> <p>To delete the reply-destination (reply-to) address, specify an empty character string.</p> |
| toAddresses | object[] | <p>(Optional) Array of destination addresses for error notification emails</p> |

| Attribute | Type | Description |
|-------------|--------|---|
| | | <p>You can specify up to 32 destination addresses to which error notification emails are to be sent. If you specify this attribute, all destination addresses that are currently registered will be overwritten.</p> <ul style="list-style-type: none"> ▪ attribute (string) <p>An attribute of a destination address for error notification emails.</p> <p>You must specify this attribute if you specify the <code>toAddresses</code> attribute.</p> <ul style="list-style-type: none"> • <code>to</code> • <code>cc</code> • <code>bcc</code> ▪ address (string) <p>A destination address for error notification emails.#</p> <p>You must specify this attribute if you specify the <code>toAddresses</code> attribute.</p> <p>Specify an address consisting of 1 to 255 characters.</p> <p>To delete all registered destination addresses for error notification emails, specify <code>false</code> for the <code>isEmailNotificationEnabled</code> attribute, and then specify an empty array for this attribute.</p> |
| description | string | <p>(Optional) Information displayed at the beginning of an error notification email</p> <p>Specify additional notification information to be displayed at the beginning of an error notification email. You can use between 1 and 511 characters.</p> |

| Attribute | Type | Description |
|-----------|------|---|
| | | <p>You can use the following characters:</p> <ul style="list-style-type: none"> ▪ Alphanumeric characters ▪ The following symbols: ! " # \$ % & ' () * + , - . / : ; < = > ? @ [\] ^ _ ` { } ~ ▪ Spaces ▪ Newlines <p>A newline character is counted as two characters.</p> <p>To delete the information displayed at the beginning of an error notification email, specify an empty character string.</p> |

#: You can use the following characters for the source (from) address, reply-destination (reply-to) address, and destination address:

- Alphanumeric characters
- The following symbols:
! # \$ % & ' * + - . = ? @ ^ _ ` { | } ~

You cannot use spaces.

Response message

Body

A job object is returned. For details on attributes other than affectedResources, see the section explaining job objects.

| Attribute | Description |
|-------------------|--|
| affectedResources | URL for acquiring settings information about an error notification email |

Status codes

For details on the status codes of the request for this operation, see the description on HTTP status codes.

Coding example

```
curl -v -H "Accept:application/json" -H "Content-Type:application/json" -H
"Authorization:Session d7b673af189048468c5af9bcf3b6bb6f" -X PATCH --data-
binary @./InputParameters.json https://192.0.2.100/ConfigurationManager/v1/
objects/alert-email-settings/instance
```

Adding a destination address for error notification emails

You can add a destination address for error notification emails. These notification emails are used to report service information messages (SIMs) of storage systems. This API allows you to add one destination address for error notification emails at a time.

For a list of storage systems that support this API, see [Overview of the initial settings of a storage system \(on page 900\)](#).

**Note:**

If you locked any resources of the target storage system by using the REST API, you will not be able to use this API function. In such cases, unlock the resources before running the API function.

Execution permission

Storage Administrator (Initial Configuration)

Request line

```
POST base-URL/v1/objects/alert-email-settings/instance/actions/add-
recipient-address/invoke
```

Request message**Object ID**

Specify *instance*.

If an object has only one instance, the *instance* is the fixed value that specifies the object ID.

Query parameters

None.

Body

```
{
  "parameters": {
    "attribute" : "to",
    "address"   : "to@example.com"
```

```
}
}
```

| Attribute | Type | Description |
|-----------|--------|--|
| attribute | string | (Required) An attribute of a destination address for error notification emails that you want to add. <ul style="list-style-type: none"> to cc bcc |
| address | string | (Required) A destination address for error notification emails that you want to add. Specify a name consisting of 1 to 255 characters. You can use the following characters: <ul style="list-style-type: none"> Alphanumeric characters The following symbols: ! # \$ % & ' * + - . = ? @ ^ _ ` { } ~ You cannot use spaces. |

Response message

Body

A job object is returned. For details on attributes other than `affectedResources`, see the section explaining job objects.

| Attribute | Description |
|--------------------------------|--|
| <code>affectedResources</code> | URL for acquiring settings information about an error notification email |

Action template

None.

Status codes

For details on the status codes of the request for this operation, see the description on HTTP status codes.

Coding example

```
curl -v -H "Accept:application/json" -H "Content-Type:application/json" -H
"Authorization:Session d7b673af189048468c5af9bcf3b6bb6f" -X POST --data-
binary @./InputParameters.json https://192.0.2.100/ConfigurationManager/v1/
objects/alert-email-settings/instance/actions/add-recipient-address/invoke
```

Deleting a destination address for error notification emails

You can delete a destination address for error notification emails. These notification emails are used to report service information messages (SIMs) of storage systems. This API allows you to delete one destination address at a time.

For a list of storage systems that support this API, see [Overview of the initial settings of a storage system \(on page 900\)](#).

**Note:**

- To delete all destination addresses at once, disable the setting for sending error notification emails.
- If you locked any resources of the target storage system by using the REST API, you will not be able to use this API function. In such cases, unlock the resources before running the API function.

Execution permission

Storage Administrator (Initial Configuration)

Request line

```
POST base-URL/v1/objects/alert-email-settings/instance/actions/remove-
recipient-address/invoke
```

Request message**Object ID**

Specify *instance*.

If an object has only one instance, the *instance* is the fixed value that specifies the object ID.

Query parameters

None.

Body

```
{
  "parameters": {
```

```

    "address" : "to@example.com"
  }
}

```

| Attribute | Type | Description |
|-----------|--------|---|
| address | string | <p>(Required) A destination address for error notification emails that you want to delete.</p> <p>Specify a name consisting of 1 to 255 characters.</p> <p>You can use the following characters:</p> <ul style="list-style-type: none"> ▪ Alphanumeric characters ▪ The following symbols: ! # \$ % & ' * + - . = ? @ ^ _ ` { } ~ <p>You cannot use spaces.</p> |

Response message

Body

A job object is returned. For details on attributes other than `affectedResources`, see the section explaining job objects.

| Attribute | Description |
|--------------------------------|--|
| <code>affectedResources</code> | URL for acquiring settings information about an error notification email |

Action template

None.

Status codes

For details on the status codes of the request for this operation, see the description on HTTP status codes.

Coding example

```

curl -v -H "Accept:application/json" -H "Content-Type:application/json" -H
"Authorization:Session d7b673af189048468c5af9bcf3bbbb6f" -X POST --data-
binary @./InputParameters.json https://192.0.2.100/ConfigurationManager/v1/

```

```
objects/alert-email-settings/instance/actions/remove-recipient-address/
invoke
```

Sending a test error notification email

The following request sends a test error notification email to verify that the settings related to the sending of email notifications for the service information messages (SIMs) of storage systems are correctly specified.

For a list of storage systems that support this API, see [Overview of the initial settings of a storage system \(on page 900\)](#).



Note:

If you locked any resources of the target storage system by using the REST API, you will not be able to use this API function. In such cases, unlock the resources before running the API function.

Execution permission

Storage Administrator (Initial Configuration)

Request line

```
POST base-URL/v1/objects/alert-email-settings/instance/actions/send-email-
test/invoke
```

Request message

Object ID

Specify `instance`.

If an object has only one instance, the `instance` is the fixed value that specifies the object ID.

Query parameters

None.

Body

None.

Response message

Body

A job object is returned. For details on attributes other than `affectedResources`, see the section explaining job objects. `affectedResources` is not displayed for this API. To verify that the email was successfully sent, check whether the test email was received by the specified recipients (destination addresses).

Status codes

The following table describes the meaning of the status code of the request for this operation. For details on other status codes, see the description of HTTP status codes.

| Status code | Message | Description |
|-------------|---------------------|---|
| 412 | Precondition Failed | If the setting for sending error notification emails is disabled, test emails cannot be sent. |

Coding example

```
curl -v -H "Accept:application/json" -H "Content-Type:application/json" -H
"Authorization:Session d7b673af189048468c5af9bcf3b6bb6f" -X POST https://
192.0.2.100/ConfigurationManager/v1/objects/alert-email-settings/instance/
actions/send-email-test/invoke -d ""
```

Getting a list of license information

The following request obtains a list of software license information. You can also obtain the list by specifying the software name or installation status of the software.

For a list of storage systems that support this API, see [Overview of the initial settings of a storage system \(on page 900\)](#).

**Note:**

If you execute this API request immediately after updating the license, the request might not be processed correctly if the system does not recognize the updated license. If this happens, wait a while, and then execute the request again.

Execution permission

Storage Administrator (View Only)

Request line

```
GET base-URL/v1/objects/licenses
```

Request message**Object ID**

None.

Query parameters

| Parameter | Type | Filter condition |
|--------------------|--------|---|
| programProductName | string | (Optional) Software name You cannot specify this parameter and the <code>status</code> parameter at the same time. |
| status | string | (Optional) Installation status of the software You can specify the following values: <ul style="list-style-type: none"> ▪ Installed ▪ Installed (Disabled) ▪ Not Installed ▪ Not Enough License ▪ Grace Period ▪ Expired You cannot specify this parameter and the <code>programProductName</code> parameter at the same time. |

Body

None.

Response message**Body**

```
{
  "data": [
    {
      "licenseId": 32775,
      "programProductName": "Dynamic Provisioning",
      "status": "Installed",
      "keyType": "Permanent",
      "capacityLimitStatus": "Unlimited",
      "usedCapacityInGB": 24379
    },
    {
      "licenseId": 32835,
      "programProductName": "Dynamic Tiering",
      "status": "Installed",
      "keyType": "Permanent",
      "capacityLimitStatus": "Unlimited",
      "usedCapacityInGB": 14682
    }
  ],
}
```

```

{
  "licenseId": 32880,
  "programProductName": "Thin Image",
  "status": "Installed",
  "keyType": "Permanent",
  "capacityLimitStatus": "Unlimited",
  "usedCapacityInGB": 940
},
{
  "licenseId": 32884,
  "programProductName": "global-active device",
  "status": "Installed",
  "keyType": "Permanent",
  "capacityLimitStatus": "Unlimited",
  "usedCapacityInGB": 161
}
]
}

```

The following is an example of output generated when the query parameters are specified:

```

{
  "data": [
    {
      "licenseId": 32775,
      "programProductName": "Dynamic Provisioning",
      "status": "Installed",
      "keyType": "Permanent",
      "capacityLimitStatus": "Unlimited",
      "usedCapacityInGB": 24379
    }
  ]
}

```

The following table lists the license information that you can obtain. For details about license information, see the *System Administrator Guide*.

| Attribute | Type | Description |
|--------------------|--------|---------------|
| licenseId | int | License ID |
| programProductName | string | Software name |

| Attribute | Type | Description |
|-----------------------|--------|---|
| status | string | <p>Installation status of the software</p> <ul style="list-style-type: none"> ▪ Installed: Installed ▪ Installed (Disabled): Installed (License is disabled) ▪ Not Installed: Not installed ▪ Not Enough License: Installed (Not enough license capacity) ▪ Grace Period: Not enough license capacity because of additional LDEVs or pool volumes, or creation of pairs ▪ Expired: Expired <p>Output when the <code>keyType</code> attribute is <code>Temporary</code>.</p> |
| keyType | string | <p>License key type</p> <ul style="list-style-type: none"> ▪ Permanent: For purchase (no limit on effective term) ▪ Term: For purchase (effective term specified) ▪ Temporary: For trial use before purchase ▪ Emergency: For emergency use |
| capacityLimitStatus | string | <p>Specified if the permitted license capacity has a limit</p> <ul style="list-style-type: none"> ▪ Limited: Limited ▪ Unlimited: Unlimited |
| permittedCapacityInTB | long | Permitted license capacity (TB) |
| usedCapacityInGB | long | Volume capacity used by the software (GB) |
| remainingDays | int | <p>Remaining days before expiration</p> <ul style="list-style-type: none"> ▪ If the <code>keyType</code> attribute is <code>Term</code>, <code>Temporary</code>, or <code>Emergency</code>: Remaining days before expiration ▪ If a license for which the <code>keyType</code> attribute is <code>Temporary</code> is expired: Remaining days after the expiration date until re-installation of the software becomes available |

Status codes

For details on the status codes of the request for this operation, see the description on HTTP status codes.

Coding example

```
curl -v -H "Accept:application/json" -H "Content-Type:application/json" -H
"Authorization:Session d7b673af189048468c5af9bcf3bbbb6f" -X GET https://
192.0.2.100/ConfigurationManager/v1/objects/licenses
```

Getting information about a specific license

The following request obtains license information by specifying a software license ID.

For a list of storage systems that support this API, see [Overview of the initial settings of a storage system \(on page 900\)](#).

Execution permission

Storage Administrator (View Only)

Request line

```
GET base-URL/v1/objects/licenses/object-ID
```

Request message**Object ID**

Specify the `licenseId` value obtained by getting information about the licenses.

| Attribute | Type | Description |
|-----------|------|-----------------------|
| licenseId | int | (Required) License ID |

Query parameters

None.

Body

None.

Response message**Body**

```
{
  "licenseId": 32775,
  "programProductName": "Dynamic Provisioning",
  "status": "Installed",
  "keyType": "Permanent",
  "capacityLimitStatus": "Unlimited",
  "usedCapacityInGB": 24379
}
```

The following table lists the license information that you can obtain. For details about license information, see the *System Administrator Guide*.

| Attribute | Type | Description |
|--------------------|--------|--|
| licenseId | int | License ID |
| programProductName | string | Software name |
| status | string | Installation status of the software <ul style="list-style-type: none"> ▪ Installed: Installed ▪ Installed (Disabled): Installed (License is disabled) ▪ Not Installed: Not installed ▪ Not Enough License: Installed (Not enough license capacity) ▪ Grace Period: Not enough license capacity because of additional LDEVs or pool volumes, or creation of pairs ▪ Expired: Expired Output when the <code>keyType</code> attribute is <code>Temporary</code> . |
| keyType | string | License key type <ul style="list-style-type: none"> ▪ Permanent: For purchase (no limit on effective term) ▪ Term: For purchase (effective term specified) ▪ Temporary: For trial use before purchase ▪ Emergency: For emergency use |

| Attribute | Type | Description |
|-----------------------|--------|--|
| capacityLimitStatus | string | Specified if the permitted license capacity has a limit <ul style="list-style-type: none"> Limited: Limited Unlimited: Unlimited |
| permittedCapacityInTB | long | Permitted license capacity (TB) |
| usedCapacityInGB | long | Volume capacity used by the software (GB) |
| remainingDays | int | Remaining days before expiration <ul style="list-style-type: none"> If the <code>keyType</code> attribute is <code>Term</code>, <code>Temporary</code>, or <code>Emergency</code>: Remaining days before expiration If a license for which the <code>keyType</code> attribute is <code>Temporary</code> is expired: Remaining days after the expiration date until re-installation of the software becomes available |

Status codes

For details on the status codes of the request for this operation, see the description on HTTP status codes.

Coding example

```
curl -v -H "Accept:application/json" -H "Content-Type:application/json" -H
"Authorization:Session d7b673af189048468c5af9bcf3b66b6f" -X GET https://
192.0.2.100/ConfigurationManager/v1/objects/licenses/34055
```

Installing software

The following request installs software by registering a license key code.

For a list of storage systems that support this API, see [Overview of the initial settings of a storage system \(on page 900\)](#).

Execution permission

Storage Administrator (Initial Configuration)

Request line

```
POST base-URL/v1/objects/licenses
```

Request message**Object ID**

None.

Query parameters

None.

Body

```
{
  "keyCode":
  "ABCDEFGHIJKLMNOPQRSTUVWXYZ123456789012345678901234567890ABCDEFGHIJKLMNOPQRSTUVWXYZ"
}
```

| Attribute | Type | Description |
|-----------|--------|-----------------------------|
| keyCode | string | (Required) License key code |

Response message**Body**

A job object is returned. For details on attributes other than affectedResources, see the section explaining job objects.

| Attribute | Description |
|-------------------|---|
| affectedResources | URL of the list of software license information |

Status codes

For details on the status codes of the request for this operation, see the description on HTTP status codes.

Coding example

```
curl -v -H "Accept:application/json" -H "Content-Type:application/json" -H
"Authorization:Session d7b673af189048468c5af9bcf3bbbb6f" -X POST --data-
binary @./InputParameters.json https://192.0.2.100/ConfigurationManager/v1/
objects/licenses
```

Enabling or disabling a license

You can enable or disable a software license by specifying the software license ID.

For a list of storage systems that support this API, see [Overview of the initial settings of a storage system \(on page 900\)](#).

Execution permission

Storage Administrator (Initial Configuration)

Request line

```
PATCH base-URL/v1/objects/licenses/object-ID
```

Request message

Object ID

Specify the `licenseId` value obtained by getting information about the licenses.

| Attribute | Type | Description |
|------------------------|------------------|-----------------------|
| <code>licenseId</code> | <code>int</code> | (Required) License ID |

Query parameters

None.

Body

```
{
  "isEnabled": true
}
```

| Attribute | Type | Description |
|------------------------|----------------------|--|
| <code>isEnabled</code> | <code>boolean</code> | (Required) Whether to enable a license or not <ul style="list-style-type: none"> ▪ <code>true</code>: Enables a license ▪ <code>false</code>: Disables a license |

Response message**Body**

A job object is returned. For details on attributes other than `affectedResources`, see the section explaining job objects.

| Attribute | Description |
|--------------------------------|--|
| <code>affectedResources</code> | URL of information about the license for which the setting was changed |

Action template

None.

Status codes

For details on the status codes of the request for this operation, see the description on HTTP status codes.

Coding example

```
curl -v -H "Accept:application/json" -H "Content-Type:application/json" -H
"Authorization:Session d7b673af189048468c5af9bcf3bbbb6f" -X PATCH --data-
binary @./InputParameters.json https://192.0.2.100/ConfigurationManager/v1/
objects/licenses/34055
```

Removing software

The following request shows how to remove software by specifying the license ID.

For a list of storage systems that support this API, see [Overview of the initial settings of a storage system \(on page 900\)](#).

Execution permission

Storage Administrator (Initial Configuration)

Request line

```
DELETE base-URL/v1/objects/licenses/object-ID
```

Request message**Object ID**

Specify the `licenseId` value obtained by getting information about the licenses.

| Attribute | Type | Description |
|-----------|------|-----------------------|
| licenseId | int | (Required) License ID |

Query parameters

None.

Body

None.

Response message

Body

A job object is returned. For details on attributes other than affectedResources, see the section explaining job objects.

| Attribute | Description |
|-------------------|---|
| affectedResources | URL of the license information of the removed program product |

Status codes

For details on the status codes of the request for this operation, see the description on HTTP status codes.

Coding example

```
curl -v -H "Accept:application/json" -H "Content-Type:application/json" -H "Authorization:Session d7b673af189048468c5af9bcf3bbbb6f" -X DELETE https://192.0.2.100/ConfigurationManager/v1/objects/licenses/34055
```

Changing the user information used in searches of the external authentication server set for a storage system

If the DN (Distinguished Name) or password of a user used in searches of the external authentication server (LDAP server) set for a storage system is changed on the LDAP server side, change the settings on the storage system side.

For a list of storage systems that support this API, see [Overview of the initial settings of a storage system \(on page 900\)](#).



Note:

- To specify the initial settings for linkage with the external authentication server, use the maintenance utility or Hitachi Device Manager - Storage Navigator.
- If you locked any resources of the target storage system by using the REST API, you will not be able to use this API function. In such cases, unlock the resources before running the API function.

Execution permission

Security Administrator (View & Modify)

Request line

```
PATCH base-URL/v1/objects/external-authentication-server-settings/instance
```

Request message

Object ID

Specify *instance*.

If an object has only one instance, the *instance* is the fixed value that specifies the object ID.

Query information

None.

Body

```
{
  "ldap" : {
    "searchUserDN": "CN=search_user,DC=example,DC=com",
    "searchUserPassword": "search_password"
  }
}
```

| Attribute | Type | Description |
|-----------|--------|---|
| ldap | Object | <p>(Required) Setting when an LDAP server is used for the external authentication server</p> <ul style="list-style-type: none"> ▪ searchUserDN (string) <p>(Optional) DN of the user used for searches</p> <p>Specify a name consisting of 1 to 255 characters.</p> <p>You can use the following characters:</p> <ul style="list-style-type: none"> • Alphanumeric characters • The following symbols: ! " # \$ % & ' () * + , - . / : ; < = > ? @ [\] ^ _ ` { } ~ • Spaces ▪ searchUserPassword (string) <p>(Required) Password of the user used for searches</p> <p>Specify a name consisting of 1 to 256 characters.</p> <p>You can use the following characters:</p> <ul style="list-style-type: none"> • Alphanumeric characters • The following symbols: ! # \$ % & ' () * + - . = @ \ ^ _ |

Response message

Body

A job object is returned. See the description for the job object. `affectedResources` is not displayed for this API request. To check whether a change has been applied, as a user authenticated by the external authentication server, run the API request for generating a session and confirm that authentication is successful.

Action template

None.

Status codes

For details on the status codes of the request for this operation, see the description of HTTP status codes.

Coding example

```
curl -v -H "Accept:application/json" -H "Content-Type:application/json" -H "Authorization:Session d7b673af189048468c5af9bcf3bbbb6f" -X PATCH --data-binary @./InputParameters.json https://192.0.2.100/ConfigurationManager/v1/objects/external-authentication-server-settings/instance
```

Chapter 16: Encrypting data

You can use REST API to perform operations related to data encryption that utilizes Encryption License Key.

Overview of data encryption

You can use the Encryption License Key functionality to encrypt data stored in a volume of the storage system. If you encrypt data, you can prevent information leakage when hard disks in the storage system are replaced or the hard disks are stolen. Even if you encrypt data, the processing time or waiting time during I/O will not increase and the existing applications and infrastructure will not be affected.

With the REST API, you can use the Encryption License Key functionality if the storage system is VSP E series, VSP G350, G370, G700, G900, VSP F350, F370, F700, F900.

The operations for data encryption to be performed by using the REST API are as follows:

- Setting an encryption environment

You can use the REST API to change the encryption environment settings for the storage system or initialize the encryption environment.

- Encrypting data to be stored in a volume

If you enable data encryption when creating a parity group and create a volume from the parity group, data to be stored in that volume is encrypted. In addition, if you migrate existing volumes to the volume, the data stored in these existing volumes can also be encrypted.

- Managing encryption keys

You can use the REST API to manage encryption keys used to encrypt and decrypt data. Encryption keys are automatically created when an encryption environment is enabled for the first time. You can create a new key if unassigned keys become insufficient due to replacement of a drive, or delete unnecessary unassigned keys. In addition, you can back up encryption keys to a REST API client and restore them if needed.



Note: If the settings are specified so that an encryption environment for the storage system links with the key management server, you cannot use the REST API to perform the following operations:

- Change or get the encryption environment settings
- Create or delete encryption keys
- Back up or restore encryption keys

For details on the Encryption License Key functionality such as the encryption specifications and system requirements, see the *Encryption License Key User Guide*.

Workflow for operations related to data encryption

The workflow for using the REST API to perform operations to encrypt and use data stored in a volume of a storage system is as follows.

Specifying encryption environment settings

Specify settings for an environment used to encrypt data stored in a volume.

The following figure shows the workflow.

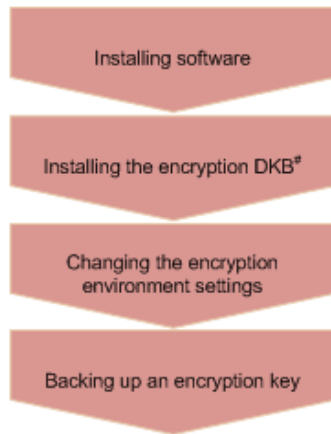

Legend:

 : Required operation

#: Operation performed without using the REST API

Installing software

Install the license key for the Encryption License Key software.

Installing the encryption disk board (DKB)

Install the encryption DKB.

Changing the encryption environment settings

Enable the encryption environment settings.

Backing up an encryption key

When you enable the encryption environment settings and create an encryption key, you need to back up the encryption key.

Encrypting new data

The following describes how to create a volume, and then encrypt data to be newly written to the volume.

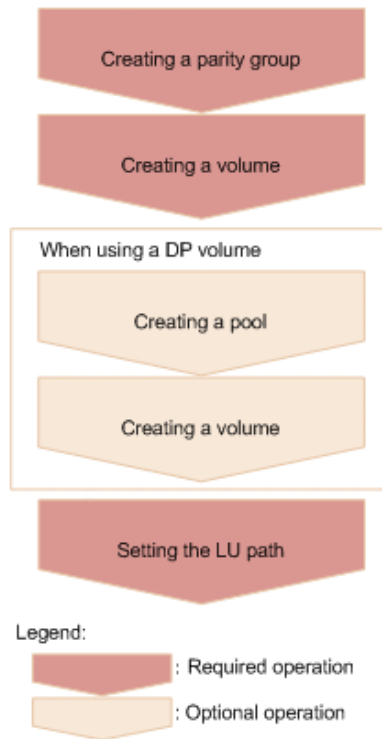
**Creating a parity group**

Create a parity group for which data encryption is enabled (specify `true` for the attribute `isEncryptionEnabled`).

Creating a volume

Create a volume by specifying the parity group for which data encryption is enabled.

When using a DP volume**Creating a pool**

Create a pool by specifying volumes whose data is encrypted.

Creating a volume

Create a DP volume by specifying a pool consisting only of volumes whose data is encrypted.

Setting the LU path

Specify the LU path from the host to the volume.

Encrypting existing data

The following describes how to encrypt the existing data stored in a volume.

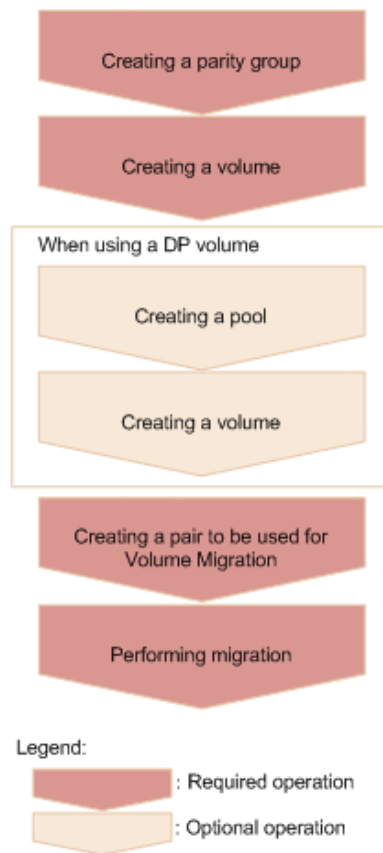
**Creating a parity group**

Create a parity group for which data encryption is enabled (specify `true` for the attribute `isEncryptionEnabled`).

Creating a volume

Create a volume by specifying the parity group for which data encryption is enabled.

When using a DP volume**Creating a pool**

Create a pool by specifying volumes whose data is encrypted.

Creating a volume

Create a DP volume by specifying a pool consisting only of volumes whose data is encrypted.

Creating a pair to be used for Volume Migration

Create a pair by specifying the volume whose data is to be encrypted as the source volume (P-VOL). For the target volume (S-VOL), specify a volume created from a parity group for which data encryption is enabled.

Performing migration

Perform migration to copy the data of the source volume (P-VOL) that is to be encrypted to the target volume (S-VOL).

Encrypting existing data without changing the drive configuration

The following describes how to encrypt the data in a volume in a parity group for which data encryption is disabled, without changing the drive configuration.

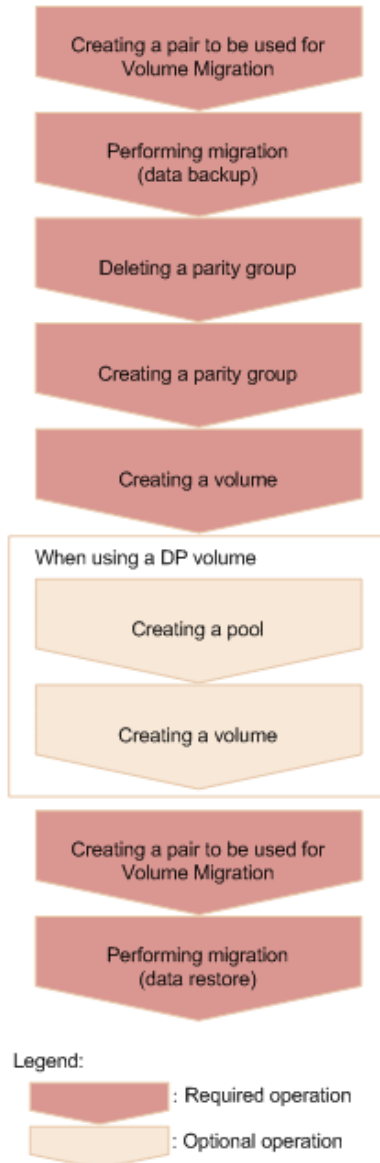

Creating a pair to be used for Volume Migration

Create a pair to which to back up the data to be encrypted, by specifying a volume in one parity group as the source volume (P-VOL). For the target volume (S-VOL), specify a volume in another parity group as the destination volume for the volume to be backed up.

Performing migration

Back up (migrate) the data of the source volume (P-VOL) to the target volume (S-VOL).

Deleting a parity group

Verify that the data has been migrated, and then delete the parity group.

Creating a parity group

Create a parity group for which data encryption is enabled (specify `true` for the attribute `isEncryptionEnabled`).

Creating a volume

Create a volume by specifying the parity group for which data encryption is enabled.

When using a DP volume

Creating a pool

Create a pool by specifying volumes whose data is encrypted.

Creating a volume

Create a DP volume by specifying a pool consisting only of volumes whose data is encrypted.

Creating a pair to be used for Volume Migration

Create a pair by specifying the migrated volume as the source volume (P-VOL) to be encrypted. For the target volume (S-VOL), specify a volume created from a parity group for which data encryption is enabled.

Performing migration

Restore (migrate) the data of the source volume (P-VOL) to be encrypted to the target volume (S-VOL).



Note:

Use the following method to check whether the data in a volume is encrypted.

- To check a basic volume:

Get information about the volume by running the API request for getting information about a specific volume.

If `ENCD` is output for the `attributes` attribute, this indicates that the data in the volume is encrypted.

- To check a DP volume:

Get information about a list of volumes that make up a pool, by running the API request for getting volume information with the pool number specified for the query parameter `poolId`.

If `ENCD` is output for the `attributes` attribute of each pool volume that makes up the pool, this indicates that the data in the DP volume is encrypted.

Getting information about the encryption environment settings

The following request gets information about the encryption environment settings.

Execution permission

Security Administrator (View & Modify)

Request lineGET *base-URL/v1/objects/encryption-settings/instance***Request message****Object ID**Specify *instance*.

If an object has only one instance, the *instance* is the fixed value that specifies the object ID.

Query parameters

None.

Body

None.

Response message**Body**

```
{
  "isEnabled": true,
  "detectsError": false
}
```

| Attribute | Type | Description |
|--------------|---------|--|
| isEnabled | boolean | Whether the encryption environment is enabled <ul style="list-style-type: none"> ▪ <code>true</code>: The encryption environment is enabled ▪ <code>false</code>: The encryption environment is disabled |
| detectsError | boolean | Whether an error occurred while the encryption environment settings were being changed <ul style="list-style-type: none"> ▪ <code>true</code>: An error occurred. ▪ <code>false</code>: No error occurred. |

| Attribute | Type | Description |
|-----------|------|--|
| | | If this value is <code>true</code> , data encryption cannot be performed. Disable (initialize) the encryption environment settings by running the API request that changes the encryption environment settings, and then enable the encryption environment settings again. |

Status codes

For details about the status codes of the request for this operation, see the description of HTTP status codes.

Coding example

```
curl -v -H "Accept:application/json" -H "Content-Type:application/json" -H
"Authorization:Session d7b673af189048468c5af9bcf3bbbb6f" -X GET https://
192.0.2.100/ConfigurationManager/v1/objects/encryption-settings/instance
```

Changing the encryption environment settings

You can change the encryption environment settings. If you change the settings to enable the encryption environment, encryption is applied. If you change the settings to disable the encryption environment, the encryption environment settings are initialized.



Note:

If you locked any resources of the target storage system by using the REST API, you will not be able to use this API function. In such cases, unlock the resources before running the API function.

Execution permission

Security Administrator (View & Modify)

Request line

```
PATCH base-URL/v1/objects/encryption-settings/instance
```

Request message

Object ID

Specify `instance`

If an object has only one instance, the `instance` is the fixed value that specifies the object ID.

Query parameters

None.

Body

```
{
  "isEnabled": true
}
```

| Attribute | Type | Description |
|-----------|---------|--|
| isEnabled | boolean | (Required) Specify whether to enable the encryption environment. <ul style="list-style-type: none"> ▪ <code>true</code>: Enables the encryption environment ▪ <code>false</code>: Disables (initialize) the encryption environment |

Response message**Body**

A job object is returned. For details on attributes other than `affectedResources`, see the section explaining job objects.

| Attribute | Description |
|-------------------|---|
| affectedResources | URL of the encryption environment settings specified for the storage system |

Action template

None.

Status codes

For details on the status codes of the request for this operation, see the description of HTTP status codes.

Coding example

```
curl -v -H "Accept:application/json" -H "Content-Type:application/json" -H
"Authorization:Session d7b673af189048468c5af9bcf3bbbb6f" -X PATCH --data-
binary @./InputParameters.json https://192.0.2.100/ConfigurationManager/v1/
objects/encryption-settings/instance
```

Getting the number of encryption keys

This request obtains the number of encryption keys.

Execution permission

Security Administrator (View Only)

Request line

```
GET base-URL/v1/objects/encryption-key-counts/instance
```

Request message

Object ID

Specify *instance*.

If an object has only one instance, the *instance* is the fixed value that specifies the object ID.

Query parameters

None.

Body

None.

Response message

Body

```
{
  "cek": 4,
  "dek": 12,
  "free": 1003
}
```

| Attribute | Type | Description |
|-----------|------|--|
| cek | int | The number of certificate encryption keys (CEKs) |
| dek | int | The number of data encryption keys (DEKs) |
| free | int | The number of unused keys |

Status codes

The following table describes the meaning of the status code of the request for this operation. For details on other status codes, see the description on HTTP status codes.

| Status code | Message | Description |
|-------------|---------------------|--|
| 412 | Precondition Failed | This operation is not supported for the microcode version of the storage system. |

Coding example

```
curl -v -H "Accept:application/json" -H "Content-Type:application/json" -H
"Authorization:Session d7b673af189048468c5af9bcf3b66b6f" -X GET https://
192.0.2.100/ConfigurationManager/v1/objects/encryption-key-counts/instance
```

Getting information about a list of encryption keys

You can get information about a list of encryption keys.

Execution permission

Security Administrator (View Only)

Request line

```
GET base-URL/v1/objects/encryption-keys
```

Request message**Object ID**

None.

Query parameters

| Parameter | Type | Filter condition |
|-----------|--------|--|
| keyType | string | (Required) Type of keys for which information is to be obtained <ul style="list-style-type: none"> ▪ DEK ▪ CEK ▪ KEK ▪ FREE ▪ DEKANDFREE (DEK and FREE) |

| Parameter | Type | Filter condition |
|-------------------------------|---------------|--|
| | | If you specify <code>DEK</code> , <code>FREE</code> , or <code>DEKANDFREE</code> for this parameter, you can specify other optional parameters. |
| <code>startKeyId</code> | int | (Optional) ID of the key from which to start getting information Specify a value in the range from 0 to 4095. This parameter is valid only if you specify <code>DEK</code> , <code>FREE</code> , or <code>DEKANDFREE</code> for the <code>keyType</code> parameter. If this parameter is omitted, 0 is assumed. |
| <code>count</code> | int | (Optional) Number of keys for which information is to be obtained Specify a value in the range from 1 to 1024. This parameter is valid only if you specify <code>DEK</code> , <code>FREE</code> , or <code>DEKANDFREE</code> for the <code>keyType</code> parameter. If this parameter is omitted, 1024 is assumed. |
| <code>startCreatedTime</code> | ISO8601string | (Optional) Information is obtained about keys that were created on or after the specified date and time. Specify a value in YYYY-MM-DDThh:mm:ssZ format. If you also specify the <code>endCreatedTime</code> parameter, specify a date and time that is earlier than the date and time specified for the <code>endCreatedTime</code> parameter. This parameter is valid only if you specify <code>DEK</code> , <code>FREE</code> , or <code>DEKANDFREE</code> for the <code>keyType</code> parameter. |
| <code>endCreatedTime</code> | ISO8601string | (Optional) Information is obtained about keys that were created on or before the specified date and time. Specify a value in YYYY-MM-DDThh:mm:ssZ format. |

| Parameter | Type | Filter condition |
|-----------|------|--|
| | | <p>If you also specify the <code>startCreatedTime</code> parameter, specify a date and time that is later than the date and time specified for the <code>startCreatedTime</code> parameter.</p> <p>This parameter is valid only if you specify <code>DEK</code>, <code>FREE</code>, or <code>DEKANDFREE</code> for the <code>keyType</code> parameter.</p> |

Body

None.

Response message**Body**

```
{
  "data": [
    {
      "keyId": "6",
      "createdTime": "2018-10-29T04:32:26Z",
      "keyType": "DEK",
      "uuid": "-",
      "targetDeviceLocation": "HDD00-08",
      "keyGeneratedLocation": "DKC",
      "numOfBackups": 4
    },
    {
      "keyId": "7",
      "createdTime": "2018-10-29T04:32:26Z",
      "keyType": "DEK",
      "uuid": "-",
      "targetDeviceLocation": "HDD00-09",
      "keyGeneratedLocation": "DKC",
      "numOfBackups": 4
    }
  ]
}
```

| Attribute | Type | Description |
|-----------|--------|---------------|
| keyId | string | ID of the key |

| Attribute | Type | Description |
|-----------------------------------|----------------------------|---|
| | | If the value of the <code>keyType</code> attribute is <code>CEK</code> or <code>KEK</code> , a hyphen (-) is output. |
| <code>createdTime</code> | <code>ISO8601string</code> | Date and time when the key was created If the value of the <code>keyType</code> attribute is <code>KEK</code> and the value of the <code>keyGeneratedLocation</code> attribute is <code>DKC</code> , a hyphen (-) is output. |
| <code>keyType</code> | <code>string</code> | Type of the key <ul style="list-style-type: none"> ▪ <code>DEK</code>: Encryption key The key is used to encrypt stored data. ▪ <code>CEK</code>: Key for authentication This key is used to encrypt a certificate. It is also used when a DEK is stored in a DKB. ▪ <code>KEK</code>: Key for encrypting keys This key is used to encrypt a CEK, a DEK, or a FREE key. Only one KEK exists for each storage system. ▪ <code>FREE</code>: Unused key that has not been assigned an encryption key |
| <code>uuid</code> | <code>string</code> | UUID of the key If the value of the <code>keyType</code> attribute is not <code>KEK</code> , or if the value of the <code>keyType</code> attribute is <code>KEK</code> but no key management server is linked, a hyphen (-) is output. |
| <code>targetDeviceLocation</code> | <code>string</code> | Device to which the key is assigned <ul style="list-style-type: none"> ▪ Location number of the drive (if the key type is <code>DEK</code>) ▪ Location number of the controller (if the key type is <code>CEK</code>) ▪ A hyphen (-) (if the key type is <code>KEK</code> or <code>FREE</code>) |

| Attribute | Type | Description |
|----------------------|--------|--|
| keyGeneratedLocation | string | Location where the key was created <ul style="list-style-type: none"> DKC: Storage system KMS: Key management server |
| numOfBackups | int | Number of times the key was backed up If the value of the <code>keyType</code> attribute is KEK, -1 is output, indicating an invalid value. |

Status codes

The following table describes the meaning of the status code of the request for this operation. For details on other status codes, see the description on HTTP status codes.

| Status code | Message | Description |
|-------------|---------------------|--|
| 412 | Precondition Failed | This operation is not supported for the microcode version of the storage system. |

Coding example

```
curl -v -H "Accept:application/json" -H "Content-Type:application/json" -H "Authorization:Session d7b673af189048468c5af9bcf3bbbb6f" -X GET https://192.0.2.100/ConfigurationManager/v1/objects/encryption-keys?keyType=DEK
```

Getting a specific encryption key

You can get information about a specific encryption key by specifying the ID of the key. You can use this API request to get information about a key whose type is DEK or FREE. To get information about a key whose type is CEK or KEK, use the API request that gets information about a list of encryption keys.

Execution permission

Security Administrator (View Only)

Request line

```
GET base-URL/v1/objects/encryption-keys/object-ID
```

Request message**Object ID**

Specify the value for `keyId` that you acquired by running the API request to obtain a list of encryption keys.

| Attribute | Type | Description |
|-----------|--------|--------------------------|
| keyId | string | (Required) ID of the key |

Query parameters

None.

Body

None.

Response message**Body**

```
{
  "keyId": "7",
  "createdTime": "2018-10-29T04:32:26Z",
  "keyType": "DEK",
  "uuid": "-",
  "targetDeviceLocation": "HDD00-09",
  "keyGeneratedLocation": "DKC",
  "numOfBackups": 4
}
```

| Attribute | Type | Description |
|-------------|---------------|--|
| keyId | string | ID of the key |
| createdTime | ISO8601string | Date and time when the key was created |
| keyType | string | Type of the key <ul style="list-style-type: none"> ▪ DEK: Encryption key The key is used to encrypt stored data. ▪ FREE: Unused key that has not been assigned an encryption key |
| uuid | string | UUID of the key |

| Attribute | Type | Description |
|----------------------|--------|---|
| | | A hyphen (-) is always output. |
| targetDeviceLocation | string | Device to which the key is assigned <ul style="list-style-type: none"> Location number of the drive (if the key type is DEK) A hyphen (-) (if the key type is FREE) |
| keyGeneratedLocation | string | Location where the key was created <ul style="list-style-type: none"> DKC: Storage system KMS: Key management server |
| numOfBackups | int | Number of times the key was backed up |

Status codes

The following table describes the meaning of the status code of the request for this operation. For details on other status codes, see the description of HTTP status codes.

| Status code | Message | Description |
|-------------|---------------------|--|
| 412 | Precondition Failed | The microcode version of the storage system does not support this operation. |

Coding example

```
curl -v -H "Accept:application/json" -H "Content-Type:application/json" -H
"Authorization:Session d7b673af189048468c5af9bcf3b66b6f" -X GET https://
192.0.2.100/ConfigurationManager/v1/objects/encryption-keys/7
```

Creating encryption keys

You can create encryption keys by specifying the number of encryption keys you want to create. After creating an encryption key, be sure to back it up.



Note:

If you locked any resources of the target storage system by using the REST API, you will not be able to use this API function. In such cases, unlock the resources before running the API function.

Execution permission

Security Administrator (View & Modify)

Request line

```
POST base-URL/v1/objects/encryption-keys
```

Request message**Object ID**

None.

Query parameters

None.

Body

```
{
  "count": 10
}
```

| Attribute | Type | Description |
|-----------|------|---|
| count | int | (Required) The number of encryption keys to be created Specify a value equal to or greater than 1. If the sum of the value specified for the <code>count</code> attribute and the number of existing keys exceeds the maximum number of keys that can be created, no keys are created, and an error occurs. |

Response message**Body**

A job object is returned. See the description for the job object. `affectedResources` is not displayed for this API. To confirm that the encryption keys have been created, run the API request for obtaining the number of encryption keys or the API request for obtaining a list of encryption keys.

Status codes

The following table describes the meaning of the status code of the request for this operation. For details on other status codes, see the description of HTTP status codes.

| Status code | Message | Description |
|-------------|---------------------|--|
| 412 | Precondition Failed | The microcode version of the storage system does not support this operation. |

Coding example

```
curl -v -H "Accept:application/json" -H "Content-Type:application/json" -H
"Authorization:Session d7b673af189048468c5af9bcf3b6bb6f" -X POST --data-
binary @./InputParameters.json https://192.0.2.100/ConfigurationManager/v1/
objects/encryption-keys
```

Deleting an encryption key

You can delete unused (FREE) keys by specifying the ID of the key you want to delete. Keys whose type is CEK or DEK cannot be deleted.



Note:

If you locked any resources of the target storage system by using the REST API, you will not be able to use this API function. In such cases, unlock the resources before running the API function.

Execution permission

Security Administrator (View & Modify)

Request line

```
DELETE base-URL/v1/objects/encryption-keys/object-ID
```

Request message

Object ID

Specify the value for `keyId` that you acquired by running the API request to obtain a list of encryption keys.

| Attribute | Type | Description |
|-----------|--------|-----------------------|
| keyId | string | (Required) The key ID |

Query parameters

None.

Body

None.

Response message**Body**

A job object is returned. For details on attributes other than `affectedResources`, see the section explaining job objects.

| Attribute | Description |
|--------------------------------|-------------------------------------|
| <code>affectedResources</code> | The URL of the key that was deleted |

Status codes

The following table describes the meaning of the status code of the request for this operation. For details on other status codes, see the description of HTTP status codes.

| Status code | Message | Description |
|-------------|---------------------|--|
| 412 | Precondition Failed | The microcode version of the storage system does not support this operation. |

Coding example

```
curl -v -H "Accept:application/json" -H "Content-Type:application/json" -H
"Authorization:Session d7b673af189048468c5af9bcf3b6bb6f" -X DELETE
https://192.0.2.100/ConfigurationManager/v1/objects/encryption-keys/4
```

Backing up encryption keys

You can back up encryption keys to a file on the REST API client. In the request header of this API function, specify `application/octet-stream` for `Accept`.

**Note:**

- When you create an encryption key, be sure to back it up. We also recommend that you periodically back up encryption keys.
- If you locked any resources of the target storage system by using the REST API, you will not be able to use this API function. In such cases, unlock the resources before running the API function.

Execution permission

Security Administrator (View & Modify)

Request header

This API request downloads an encryption key file to the REST API client. Specify `application/octet-stream` for the Accept of the request header.

Request line

```
POST base-URL/v1/objects/encryption-keys/file/actions/backup/invoke
```

Request message**Object ID**

Specify a value for `file`.

When backing up encryption keys to a file or restoring encryption keys from a file, the value of `file` is a fixed value (the object ID).

Query parameters

None.

Body

```
{
  "parameters": {
    "password": "backuppasword"
  }
}
```

| Attribute | Type | Description |
|-----------|--------|---|
| password | string | <p>(Required) Password.</p> <p>Specify a character string consisting of 6 to 255 characters.</p> <p>You can use the following characters:</p> <ul style="list-style-type: none"> ▪ Alphanumeric characters ▪ ! " # \$ % & ' () * + , - . / : ; < = > ? @ [\] ^ _ ` { } ~ <p>You will need this password when you restore the encryption key.</p> |

Response header

This API request returns the following response header.

| Header | Description |
|---------------------|--|
| Content-Disposition | attachment |
| Content-Length | The size of the backup data (in bytes) |
| Content-type | application/octet-stream |

Response message**Body**

None.

Action template

None.

Status codes

The following table describes the meaning of the status code of the request for this operation. For details on other status codes, see the description of HTTP status codes.

| Status code | Message | Description |
|-------------|---------------------|--|
| 412 | Precondition Failed | The microcode version of the storage system does not support this operation. |

Coding example

```
curl -v -H "Accept:application/octet-stream" -H "Content-Type:application/json" -H "Authorization:Session d7b673af189048468c5af9bcf3b66b6f" -X POST --data-binary @./InputParameters.json https://192.0.2.100/ConfigurationManager/v1/objects/encryption-keys/file/actions/backup/invoke -o "backupfile.ekf"
```

Restoring encryption keys

You can restore encryption key file that was previously backed up. In the request header of this API function, specify `multipart/form-data` for Content-Type.

**Note:**

If you locked any resources of the target storage system by using the REST API, you will not be able to use this API function. In such cases, unlock the resources before running the API function.

Execution permission

Security Administrator (View & Modify)

Request header

In this API, the request body is sent in the format of multipart/form-data. Specify `multipart/form-data` for the Content-Type of the request header.

Request line

```
POST base-URL/v1/objects/encryption-keys/file/actions/restore/invoke
```

Request message**Object ID**

Specify a value for `file`.

When backing up encryption keys to a file or restoring encryption keys from a file, the value of `file` is a fixed value (the object ID).

Query parameters

None.

Body

| Attribute | Type | Description |
|-----------|--------|--|
| password | string | (Required) The password that was specified when the encryption key was backed up. |
| file | file | (Required) The backed-up encryption key file. Specify the most recent backup file. Encryption keys that are not up to date (for example, encryption keys that were changed after the file was backed up) cannot be restored. |

Response message**Body**

A job object is returned. For details on the schema of job objects, see the description of job objects. Note, however, that this API function does not display the `affectedResources` attribute.

Action template

None.

Status codes

The following table describes the meaning of the status code of the request for this operation. For details on other status codes, see the description of HTTP status codes.

| Status code | Message | Description |
|-------------|---------------------|--|
| 412 | Precondition Failed | The microcode version of the storage system does not support this operation. |

Coding example

```
curl -v -H "Accept:application/json" -H "Content-Type: multipart/form-data" -H "Authorization:Session d7b673af189048468c5af9bcf3b66b6f" -H "Expect:" -X POST -F "file=@C:\backupfile.ekf" -F "password=backuppasword" https://192.0.2.100/ConfigurationManager/v1/objects/encryption-keys/file/actions/restore/invoke
```

Chapter 17: Monitoring storage systems

You can monitor the status of storage systems by getting alerts (SIMs) generated on each storage system, as well as information about the hardware installed in each storage system.

Getting a list of alert information

The following request gets a list of alerts related to the error information (SIM) of a storage system.

**Note:**

This API request can be used when the storage system is VSP E series, VSP G350, G370, G700, G900, VSP F350, F370, F700, F900.

Execution permission

Support Personnel or User Maintenance

Request line

```
GET base-URL/v1/objects/alerts
```

Request message**Object ID**

None.

Query parameters

| Attribute | Type | Filter Condition |
|-----------|--------|---|
| type | string | (Required) Specify the type of the alert information you want to obtain. Specifiable values are as follows: <ul style="list-style-type: none">DKC: DKCCTL1: controller 1CTL2: controller 2 |

| Attribute | Type | Filter Condition |
|-----------|------|---|
| start | int | <p>(Optional) Specify the number of the alert from which you want to start obtaining information.</p> <p>Alerts are sorted by date and time in descending order.</p> <p>If you specified <code>DKC</code> for the <code>type</code> parameter, specify a value in the range from 1 to 10240.</p> <p>If you specified <code>CTL1</code> or <code>CTL2</code> for the <code>type</code> parameter, specify a value in the range from 1 to 256.</p> <p>If this parameter is omitted, alert information will be obtained starting from the first alert.</p> |
| count | int | <p>(Optional) Specify the number of alerts to be obtained.</p> <p>If you specified <code>DKC</code> for the <code>type</code> parameter, specify a value in the range from 1 to 10240.</p> <p>If you specified <code>CTL1</code> or <code>CTL2</code> for the <code>type</code> parameter, specify a value in the range from 1 to 256.</p> <p>If this parameter is omitted, 10 alerts will be obtained.</p> |

Body

None.

Response message**Body**

```
{
  "data" : [
    {
      "alertIndex" : "133ed620e449-0f0c9-7d0700",
      "alertId" : 61641,
      "occurrenceTime" : "2018-03-22T16:14:01",
      "referenceCode" : 8193792,
      "errorLevel" : "Moderate",
      "errorSection" : "GUM detection error",
      "errorDetail" : "GUM security error detected",
      "location" : "CTL1",
      "actionCodes" : [
        {
          "actionCode" : 1492123648,
          "possibleFailureParts" : "TSC CALL",
          "accLocation" : "-"
        }
      ]
    }
  ]
}
```

```

},
{
  "alertIndex" : "133ed620a156-0f0c6-7d0700",
  "alertId" : 61638,
  "occurrenceTime" : "2018-03-22T11:28:22",
  "referenceCode" : 8193792,
  "errorLevel" : "Moderate",
  "errorSection" : "GUM detection error",
  "errorDetail" : "GUM security error detected",
  "location" : "CTL1",
  "actionCodes" : [
    {
      "actionCode" : 1492123648,
      "possibleFailureParts" : "TSC CALL",
      "accLocation" : "-"
    }
  ]
},
{
  "alertIndex" : "133ed6011907-0f0c3-7d0700",
  "alertId" : 61635,
  "occurrenceTime" : "2018-03-20T19:59:03",
  "referenceCode" : 8193792,
  "errorLevel" : "Moderate",
  "errorSection" : "GUM detection error",
  "errorDetail" : "GUM security error detected",
  "location" : "CTL1",
  "actionCodes" : [
    {
      "actionCode" : 1492123648,
      "possibleFailureParts" : "TSC CALL",
      "accLocation" : "-"
    }
  ]
},
{
  "alertIndex" : "133ed601164f-0f0bd-7d0700",
  "alertId" : 61629,
  "occurrenceTime" : "2018-03-20T19:47:27",
  "referenceCode" : 8193792,
  "errorLevel" : "Moderate",
  "errorSection" : "GUM detection error",
  "errorDetail" : "GUM security error detected",
  "location" : "CTL1",
  "actionCodes" : [
    {
      "actionCode" : 1492123648,
      "possibleFailureParts" : "TSC CALL",
      "accLocation" : "-"
    }
  ]
}

```

```

    }
  ]
}

```

| Attribute | Type | Description |
|----------------|--------|---|
| alertIndex | string | Character string that uniquely identifies an alert |
| alertID | int | Alert ID The log number of the SIM is displayed. |
| occurrenceTime | string | Date and time when the alert occurred The local time of the storage system is displayed in YYYY-MM-DDThh:mm:ss format. |
| referenceCode | int | SIM reference code |
| errorLevel | string | One of the following values is displayed as the error level: <ul style="list-style-type: none"> ▪ Service: Service ▪ Moderate: Warning (Moderate) ▪ Serious: Error (Serious) ▪ Acute: Acute |
| errorSection | string | Information about where the alert occurred |
| errorDetail | string | Details of the alert |
| location | string | The location of the component or part for which the error occurred |

| Attribute | Type | Description |
|-----------|----------|--|
| actions | object[] | <p>The following information related to the action code of the alert is displayed:</p> <ul style="list-style-type: none"> ▪ <code>actionCode</code> (long) Action code ▪ <code>possibleFailureParts</code> (string) The part that might have been the cause of the error The name of the part that is assumed to be the cause of the error is displayed. ▪ <code>accLocation</code> (string) Location The location of the component in which the error occurred is displayed. |

Status codes

For details on the status codes of the request for this operation, see the description on HTTP status codes.

Coding example

```
curl -v -H "Accept:application/json" -H "Content-Type:application/json" -H
"Authorization:Session f76884c29fff4dfaa664aa6981087b71" -X GET "https://
192.0.2.100/ConfigurationManager/v1/objects/alerts?
type=CTL1&start=2&count=4"
```

Getting information about the hardware installed in a storage system

The following request gets information about the hardware installed in a storage system, including information about the controller's temperature and the battery status.

Execution permission

Storage Administrator (View Only)

Request line

```
GET base-URL/v1/objects/components/instance
```

Request message**Object ID**

Specify `instance`. If an object has only one instance, the value for `instance` is the fixed value that specifies the object ID.

Query parameters

| Parameter | Type | Description |
|------------------------------|--------|---|
| <code>componentOption</code> | string | <p>(Optional) Type of detailed information to be obtained</p> <ul style="list-style-type: none"> <code>class</code> <p>You can get information about hardware installed on a storage system from the storage system's cache.</p> <p>You can specify this item for VSP 5000 series.</p> <p>To get up-to-date information, you must run the API request that refreshes the storage system's cache before running this request. For details, see "Updating the cache of storage system configuration information".</p> <p>If you specify <code>class</code> for <code>componentOption</code> in a query parameter, only detailed information is obtained.</p> |

Body

None.

Response message**Body**

```
{
  "system": {
    "powerConsumption": 283
  },
  "ctls": [
    {
      "location": "CTL1",
      "status": "Normal",
      "temperature": 29,
      "temperatureStatus": "Normal",
      "charge": 100,
    }
  ]
}
```

```

    "type": "Controller Board"
  },
  {
    "location": "CTL2",
    "status": "Normal",
    "temperature": 29,
    "temperatureStatus": "Normal",
    "charge": 100,
    "type": "Controller Board"
  }
],
"cacheMemories": [
  {
    "location": "CTL1 CMG0",
    "status": "Normal",
    "cacheSize": 16
  },
  {
    "location": "CTL2 CMG0",
    "status": "Normal",
    "cacheSize": 16
  }
],
"chbs": [
  {
    "location": "CHB-1A",
    "status": "Normal",
    "type": "10G 2Port iSCSI (Optic)"
  },
  {
    "location": "CHB-2A",
    "status": "Normal",
    "type": "10G 2Port iSCSI (Optic)"
  }
],
"cacheFlashMemories": [
  {
    "location": "CFM-1",
    "status": "Normal",
    "type": "BM05"
  },
  {
    "location": "CFM-2",
    "status": "Normal",
    "type": "BM05"
  }
],
"dkbs": [],

```

```
"lanbs": [], ...
}
```

For attributes indicated by a hash mark (#), if there is no hardware and information cannot be obtained, the attributes under the object are not output.

| Attribute | Type | Description |
|-----------|----------|--|
| system | object | <p>The following attribute related to the storage system information is output:</p> <ul style="list-style-type: none"> ▪ powerConsumption (int) Power consumption of the storage system (Watt) A value is output indicating the average amount of power consumed by the controller and the drive box per minute. If a valid value cannot be obtained, -1 is output. |
| ctls | object[] | <p>The following attributes related to the controller information are output:</p> <ul style="list-style-type: none"> ▪ location (string) Location of the controller ▪ status (string) Status of the controller <ul style="list-style-type: none"> • Normal • Warning • Blocked • Failed ▪ temperature (int) Temperature of the controller (°C) A value in the range from -55 to 125 is output. If a value outside of this range is obtained, -274 is output. If the value of the <code>status</code> attribute is <code>Blocked</code>, the value that was obtained immediately before the controller was blocked is output. A similar value might also be output if the value of the <code>status</code> attribute is <code>Failed</code>. |

| Attribute | Type | Description |
|-----------------------------|-----------------------|---|
| | | <ul style="list-style-type: none"> ▪ <code>temperatureStatus</code> (string) Status indicating the temperature of the controller <ul style="list-style-type: none"> • <code>Normal</code> • <code>Warning</code> • <code>Failed</code> <p>This attribute is output for VSP E series, VSP G350, G370, G700, G900, VSP F350, F370, F700, F900.</p> ▪ <code>charge</code> (int) Charge status of the battery (%) A value in the range from 0 to 100 is output. If a value outside of this range is obtained, -1 is output. This attribute is output for VSP E series, VSP G350, G370, G700, G900, VSP F350, F370, F700, F900. ▪ <code>type</code> (string) Type of the controller <ul style="list-style-type: none"> • <code>Encryption Controller Board: Encryption is enabled.</code> • <code>Encryption Controller Board for NVMe: Encryption is enabled.</code> • <code>Controller Board: Encryption is disabled.</code> • <code>Controller Board for NVMe: Encryption is disabled.</code> <p>If a valid value cannot be obtained, - is output. This attribute is output for VSP E series, VSP G350, G370, G700, G900, VSP F350, F370, F700, F900.</p> |
| <code>cacheMemories#</code> | <code>object[]</code> | The following attributes related to the cache memory are output: |

| Attribute | Type | Description |
|-----------|----------|--|
| | | <p>This attribute is output for VSP E series, VSP G350, G370, G700, G900, VSP F350, F370, F700, F900.</p> <ul style="list-style-type: none"> ▪ location (string) Location of the cache memory ▪ status (string) Status of the cache memory <ul style="list-style-type: none"> • Normal • Warning • Blocked ▪ cacheSize (int) Size (GB) of the cache memory If a valid value cannot be obtained, -1 is output. |
| chbs# | object[] | The following attributes related to the channel board are output: |

| Attribute | Type | Description |
|--------------------|----------|---|
| | | <p>This attribute is output for VSP E series, VSP G350, G370, G700, G900, VSP F350, F370, F700, F900.</p> <ul style="list-style-type: none"> ▪ location (string) Location of the channel board ▪ status (string) Status of the channel board <ul style="list-style-type: none"> • Normal • Warning • Blocked • Failed ▪ type (string) Type of the channel board <ul style="list-style-type: none"> • 16G 2Port FC • 32G Ready 4Port FC • 10G 2Port iSCSI (Optic) • 10G 2Port iSCSI (Copper) |
| cacheFlashMemoryS# | object[] | The following attributes related to the cache flash memory are output: |

| Attribute | Type | Description |
|-----------|----------|---|
| | | <p>This attribute is output for VSP E series, VSP G350, G370, G700, G900, VSP F350, F370, F700, F900.</p> <ul style="list-style-type: none"> ▪ location (string) Location of the cache flash memory ▪ status (string) Status of the cache flash memory <ul style="list-style-type: none"> • Normal • Warning • Blocked • Failed ▪ type (string) Type of the cache flash memory Example : BM30 |
| dkbs# | object[] | <p>The following attributes related to the disk board are output: This attribute is output for VSP E series, VSP G350, G370, G700, G900, VSP F350, F370, F700, F900.</p> <ul style="list-style-type: none"> ▪ location (string) Location of the disk board ▪ status (string) Status of the disk board <ul style="list-style-type: none"> • Normal • Warning • Blocked • Failed ▪ type (string) Type of the disk board Example : Disk Board |
| lanbs# | object[] | The following attributes related to the LAN board are output: |

| Attribute | Type | Description |
|-----------|----------|--|
| | | <p>This attribute is output for VSP E series, VSP G350, G370, G700, G900, VSP F350, F370, F700, F900.</p> <ul style="list-style-type: none"> ▪ location (string) Location of the LAN board ▪ status (string) Status of the LAN board <ul style="list-style-type: none"> • Normal • Warning |
| sfps# | object[] | <p>The following attributes related to the SFP (Small Form Factor Pluggable) information are output:</p> <p>This attribute is output for VSP E series, VSP G350, G370, G700, G900, VSP F350, F370, F700, F900.</p> <ul style="list-style-type: none"> ▪ portId (string) Port number of the SFP ▪ status (string) Status of the SFP <ul style="list-style-type: none"> • Not fix • Normal • Warning ▪ type (string) Type of the SFP <ul style="list-style-type: none"> • Short Wave • Long Wave • Copper Cable <p>If no port is used, an empty character string is output.</p> |

| Attribute | Type | Description |
|-----------|----------|--|
| | | <ul style="list-style-type: none"> ▪ speed (string) SFP Speed <ul style="list-style-type: none"> • 16Gbps • 32Gbps If no speed is set, an empty character string is output. ▪ portCondition (string) Condition of the SFP port <ul style="list-style-type: none"> • Not Available • Available (Connected) • Available (Not Connected) If the value of the attribute is anything other than the above, a hyphen (-) is output. |
| bkmfs# | object[] | The following attributes related to the backup module are output: |

| Attribute | Type | Description |
|-----------|----------|--|
| | | <p>This attribute is output for VSP E series, VSP G350, G370, G700, G900, VSP F350, F370, F700, F900.</p> <ul style="list-style-type: none"> ▪ location (string) Location of the backup module ▪ status (string) Status of the backup module <ul style="list-style-type: none"> • Normal • Warning • Blocked • Failed ▪ batteries (object[]) The following attributes related to the battery are output: <ul style="list-style-type: none"> • location(string) Location of the battery • status (string) Status of the battery Normal Warning Blocked Failed • life (int) Life expectancy of the battery A value in the range from 0 to 100 is output. If a value outside of this range is obtained, -1 is output. |
| dkcps# | object[] | The following attributes related to the DKCPS information are output: |

| Attribute | Type | Description |
|-------------|----------|---|
| | | <p>This attribute is output for VSP E series, VSP G350, G370, G700, G900, VSP F350, F370, F700, F900.</p> <ul style="list-style-type: none"> ▪ location (string) Location of the DKCPS ▪ status (string) Status of the DKCPS <ul style="list-style-type: none"> • Normal • Warning • Failed • Blocked |
| driveBoxes# | object[] | <p>The following attributes related to the drive box are output: This attribute is output for VSP E series, VSP G350, G370, G700, G900, VSP F350, F370, F700, F900.</p> <ul style="list-style-type: none"> ▪ location (string) Location of the drive box ▪ type (string) Type of the drive box <ul style="list-style-type: none"> • DBS • DBL • DB60 • DBF • DBN ▪ led (string) Status of the LED <ul style="list-style-type: none"> • ON • OFF |

| Attribute | Type | Description |
|-----------|------|--|
| | | <ul style="list-style-type: none"> ▪ drives (object[]) <p>The following attributes related to drives are output:</p> <ul style="list-style-type: none"> • location (string) <p>Location of the drives</p> • modelCode (string) <p>Drive type code</p> • status (string) <p>Status of the drives</p> <p>Normal</p> <p>Warning</p> <p>Warning (Port 0 failed)</p> <p>Warning (Port 1 failed)</p> <p>Blocked</p> <p>Failed</p> <p>Copying n % (xxx to xxx)</p> <p>Copying n % (xxx from xxx)</p> <p>Pending (xxx to xxx)</p> <p>Pending (xxx from xxx)</p> <p>Copy incomplete</p> <p>Reserved</p> <p>If multiple copy statuses exist, all of them are output.</p> • usage (string) <p>Drive usage</p> <p>DATA</p> <p>Spare</p> <p>Free</p> • recomendReplacement (int) <p>Whether the replacement of the drive is recommended</p> <p>0: PDEV replacement is not recommended.</p> <p>1: PDEV replacement is recommended.</p> |

| Attribute | Type | Description |
|-----------|----------|--|
| | | <ul style="list-style-type: none"> ▪ encs (object[]) <p>The following attributes related to the ENC information are output:</p> <ul style="list-style-type: none"> • location (string) <p>Location of the ENC</p> • status (string) <p>Status of the ENC</p> <p>Normal</p> <p>Warning</p> <p>Blocked</p> <p>Failed</p> ▪ dbps (object[]) <p>The following attributes related to the power supply for drive boxes are output:</p> <ul style="list-style-type: none"> • location (string) <p>Location of the power supply for drive boxes</p> • status (string) <p>Status of the power supply for drive boxes</p> <p>Normal</p> <p>Warning</p> <p>Failed</p> |
| fans# | object[] | The following attributes related to fans are output: |

| Attribute | Type | Description |
|-----------|----------|---|
| | | <p>This attribute is output for VSP E series, VSP G350, G370, G700, G900, VSP F350, F370, F700, F900.</p> <ul style="list-style-type: none"> ▪ location (string) Location of the fans ▪ status (string) Status of the fans <ul style="list-style-type: none"> • Normal • Warning • Failed |
| upsMode | string | <p>UPS mode</p> <p>This attribute is output for VSP E series, VSP G350, G370, G700, G900, VSP F350, F370, F700, F900.</p> <ul style="list-style-type: none"> ▪ UPS Interlock Mode 1 ▪ UPS Interlock Mode 2 ▪ UPS Interlock Mode 3 ▪ Standard Mode |
| pecbs# | object[] | <p>The following attributes related to the PCIe channel board are output:</p> |

| Attribute | Type | Description |
|-----------|----------|--|
| | | <p>This attribute is output for VSP E series, VSP G350, G370, G700, G900, VSP F350, F370, F700, F900.</p> <ul style="list-style-type: none"> ▪ location (string) Location of the PCIe channel board ▪ status (string) Status of the PCIe channel board <ul style="list-style-type: none"> • Normal • Warning • Blocked ▪ connectionMode (string) Connection mode of the PCIe channel board <ul style="list-style-type: none"> • Channel Board Box • Server Chassis <p>If the value of the attribute is anything other than the above, a hyphen (-) is output.</p> |
| chbb# | object | <p>The following attributes related to the channel board box are output:</p> <p>This attribute is output for VSP E series, VSP G350, G370, G700, G900, VSP F350, F370, F700, F900.</p> <ul style="list-style-type: none"> ▪ location (string) Location of the channel board box ▪ expansionMode (string) Expansion mode of the channel board box <ul style="list-style-type: none"> • 1-vSW • 2-vSW <p>If the value of the attribute is anything other than the above, a hyphen (-) is output.</p> |
| pcps# | object[] | <p>The following attributes related to the PCIe channel package are output:</p> |

| Attribute | Type | Description |
|-----------|----------|--|
| | | <p>This attribute is output for VSP E series, VSP G350, G370, G700, G900, VSP F350, F370, F700, F900.</p> <ul style="list-style-type: none"> ▪ location (string) Location of the PCIe channel package ▪ status (string) Status of the PCIe channel package <ul style="list-style-type: none"> • Normal • Warning • Blocked |
| swpks# | object[] | <p>The following attributes related to the switch package are output:</p> <p>This attribute is output for VSP E series, VSP G350, G370, G700, G900, VSP F350, F370, F700, F900.</p> <ul style="list-style-type: none"> ▪ location (string) Location of the switch package ▪ status (string) Status of the switch package <ul style="list-style-type: none"> • Normal • Warning • Blocked |
| chbbfans# | object[] | <p>The following attributes related to the fan for the channel board box are output:</p> <p>This attribute is output for VSP E series, VSP G350, G370, G700, G900, VSP F350, F370, F700, F900.</p> <ul style="list-style-type: none"> ▪ location (string) Location of the fan for the channel board box ▪ status (string) Status of the fan for the channel board box <ul style="list-style-type: none"> • Normal • Warning |
| chbbps# | object[] | <p>The following attributes related to the power supply for the channel board box are output:</p> |

| Attribute | Type | Description |
|-----------|------|---|
| | | <p>This attribute is output for VSP E series, VSP G350, G370, G700, G900, VSP F350, F370, F700, F900.</p> <ul style="list-style-type: none"> ▪ location (string) Location of the power supply for the channel board box ▪ status (string) Status of the power supply for the channel board box <ul style="list-style-type: none"> • Normal • Warning |

If you run this request with `class` specified for the `componentOption` query parameter, only information from the storage system's cache will be obtained.

| Attribute | Type | Description |
|--------------------|--------|---|
| cacheMemorySummary | object | <p>The attribute related to summary information about the cache memory</p> <ul style="list-style-type: none"> ▪ status (string) Status of the cache memory <ul style="list-style-type: none"> • Normal • Service • Moderate • Serious • Acute • Unknown |

| Attribute | Type | Description |
|---------------------|--------|--|
| sharedMemorySummary | object | <p>The attribute related to summary information about the shared memory</p> <ul style="list-style-type: none"> ▪ status (string) <ul style="list-style-type: none"> Status of the shared memory • Normal • Service • Moderate • Serious • Acute • Unknown |
| lanbSummary | object | <ul style="list-style-type: none"> ▪ status (string) <ul style="list-style-type: none"> This attribute is currently not in use. |
| bkmfSummary | object | <p>The attribute related to summary information about the backup module</p> <ul style="list-style-type: none"> ▪ fanStatus (string) <ul style="list-style-type: none"> Status of the fan • Normal • Service • Moderate • Serious • Acute • Unknown |

| Attribute | Type | Description |
|-----------------|--------|--|
| dkcpsSummary | object | <p>The attribute related to summary information about the DKCPS</p> <ul style="list-style-type: none">▪ status (string) Status of the DKCPS<ul style="list-style-type: none">• Normal• Service• Moderate• Serious• Acute• Unknown |
| driveBoxSummary | object | <p>Attributes related to summary information about the drive box</p> <ul style="list-style-type: none">▪ powerSupplyStatus (string) Status of the drive box power supply<ul style="list-style-type: none">• Normal• Service• Moderate• Serious• Acute• Unknown▪ fanStatus (string) This attribute is currently not in use. |

| Attribute | Type | Description |
|------------------|--------|--|
| | | <ul style="list-style-type: none"> ▪ environmentStatus (string) Status of the drive box environment <ul style="list-style-type: none"> • Normal • Service • Moderate • Serious • Acute • Unknown ▪ driveStatus (string) Status of the drive <ul style="list-style-type: none"> • Normal • Service • Moderate • Serious • Acute • Unknown |
| processorSummary | object | <p>The attribute related to summary information about the processor</p> <ul style="list-style-type: none"> ▪ status (string) Status of the processor <ul style="list-style-type: none"> • Normal • Service • Moderate • Serious • Acute • Unknown |

| Attribute | Type | Description |
|----------------|--------|---|
| batterySummary | object | <p>The attribute related to summary information about the battery</p> <ul style="list-style-type: none"> ▪ status (string) Status of the battery <ul style="list-style-type: none"> • Normal • Service • Moderate • Serious • Acute • Unknown |
| xPathSummary | object | <p>The attribute related to summary information about the X-path</p> <p>Information about the X-path and the interconnection switch is output as the value of the <code>xPathSummary</code> attribute.</p> <ul style="list-style-type: none"> ▪ status (string) Status of the X-path <ul style="list-style-type: none"> • Normal • Service • Moderate • Serious • Acute • Unknown |

Status codes

For details on the status codes of the request for this operation, see the section explaining HTTP status codes.

Coding example

```
curl -v -H "Accept:application/json" -H "Content-Type:application/json" -H
"Authorization:Session d7b673af189048468c5af9bcf3b6bb6f" -X GET https://
192.0.2.100/ConfigurationManager/v1/objects/components/instance
```

Getting information about channel boards

This request gets information about all channel boards.

**Note:**

- You can use this API function for VSP 5000 series.
- To get up-to-date information, you must run the API request that refreshes the storage system's cache before running this request. For details, see "Updating the cache of storage system configuration information".

Execution permission

Storage Administrator (View Only)

Request line

```
GET base-URL/v1/objects/channel-boards
```

Request message**Object ID**

None.

Query parameters

None.

Body

None.

Response message**Body**

```
{
  "data" : [ {
    "channelBoardId" : 3,
    "location" : "CHB-01F",
    "clusterNumber" : 1,
    "channelBoardNumber" : 3,
    "channelBoardType" : "FIBRE",
    "numOfPorts" : "4Port",
    "maxPortSpeed" : "32G",
    "cableMaterial" : "-"
  }, {
    "channelBoardId" : 7,
    "location" : "CHB-02F",
    "clusterNumber" : 2,
    "channelBoardNumber" : 3,
    "channelBoardType" : "FIBRE",
    "numOfPorts" : "4Port",
    "maxPortSpeed" : "32G",
    "cableMaterial" : "-"
  } ]
}
```

| Attribute | Type | Description |
|--------------------|--------|---|
| channelBoardId | int | ID of the channel board |
| location | string | Location of the channel board |
| clusterNumber | int | Cluster number of the channel board |
| channelBoardNumber | int | Number of the channel board Each channel board in a cluster is assigned a unique number. |
| channelBoardType | string | Type of ports that are installed on the channel board <ul style="list-style-type: none"> ▪ FICON ▪ FIBRE ▪ ISCSI |

| Attribute | Type | Description |
|---------------|--------|--|
| numOfPorts | string | Number of ports that are installed on the channel board <ul style="list-style-type: none"> ▪ 2Port ▪ 4Port ▪ - If this information cannot be obtained, a hyphen (-) is output. |
| maxPortSpeed | string | Data transmission speed of the ports installed on the channel board <ul style="list-style-type: none"> ▪ 10G ▪ 16G ▪ 32G ▪ - If this information cannot be obtained, a hyphen (-) is output. |
| cableMaterial | string | Type of cable materials that can be used with the ports that are installed on the channel board <ul style="list-style-type: none"> ▪ Optical ▪ - If no information about the type of cable materials exists, a hyphen (-) is output. |

Status codes

For details on the status codes of the request for this operation, see the description on HTTP status codes.

Coding example

```
curl -v -H "Accept:application/json" -H "Content-Type:application/json" -H
"Authorization:Session d7b673af189048468c5af9bcf3b66b6f" -X GET https://
192.0.2.100/ConfigurationManager/v1/objects/channel-boards
```

Chapter 18: Managing resources by using virtual storage machines

This chapter explains how to manage resources on virtual storage machines by using the REST API.

Overview of managing resources by using virtual storage machines

A "virtual storage machine" is a virtual storage system created on a storage system by using the global storage virtualization function. You can set virtual information, such as models and serial numbers, for virtual storage machines.

A virtual storage machine can be used as a global-active device or for nondisruptive migration. By registering resources in virtual storage machines, you can collectively manage resources of multiple physical storage systems on a single virtual storage machine, or divide resources of a single physical storage system into multiple virtual storage machines and manage the resources separately.

Examples of virtual storage machine configurations

The following figure shows examples of virtual storage machine configurations:

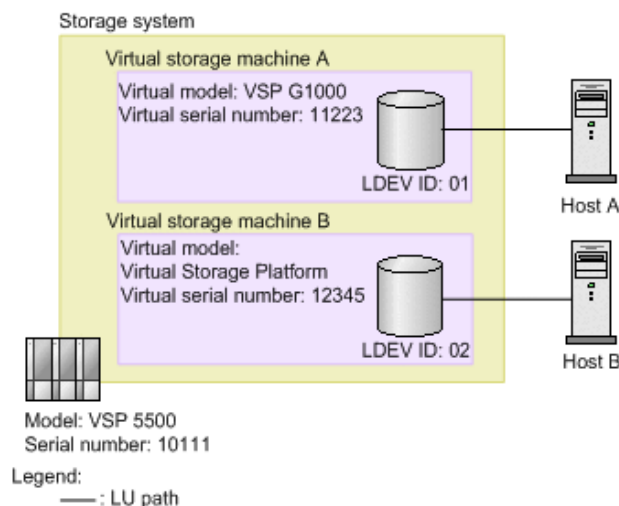

In this figure, a virtual storage machine of the virtual model VSP G1000 (virtual serial number: 11223) and a virtual storage machine of the virtual model Virtual Storage Platform (virtual serial number: 12345) are created in a VSP 5500 storage system (serial number: 10111), and the resources registered in the virtual storage machines are allocated to the hosts. When the configuration is set up like this, from the virtual point of view it seems as if host A is accessing VSP G1000 (virtual serial number: 11223), and host B is accessing Virtual Storage Platform (virtual serial number: 12345).

For details on how to manage resources by using virtual storage machines, see the *Provisioning Guide for Open Systems*, or the *Provisioning Guide*.

Workflow for managing resources by using virtual storage machines

The following explains how to manage resources on virtual storage machines by using the REST API.

Workflow for creating a virtual storage machine and registering resources

Create a virtual storage machine, and then register the required resources. Allocate the registered resources to the hosts in the same way as allocating resources of a physical storage system, or use the registered resources in the volumes of a global-active device pair.

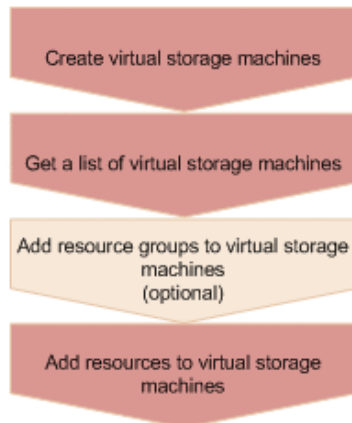

Create a virtual storage machine

Create a virtual storage machine, and then specify the model name and serial number. A resource group to be used on the virtual storage machine is also created at the same time.

Get a list of the virtual storage machines

Get information such as the storage device IDs of the created virtual storage machines, and the IDs of resource groups on the virtual storage machines.

Add resource groups on a virtual storage machine (optional)

If necessary, add resource groups to the virtual storage machine. Perform this operation by executing the API request for creating resource groups.

Add resources to the virtual storage machines

In the resource groups of the virtual storage machine, add resources such as host numbers, host group numbers, and LDEV numbers. Perform this operation by executing the API request for adding a resource to a resource group.

- To add an LDEV number, first delete the set virtual LDEV number, and then add the LDEV number. After adding the LDEV number in the virtual storage machine, set the virtual LDEV number.
- To add a host group number or iSCSI target number, add an undefined host group or iSCSI target.

Workflow for deleting an unnecessary virtual storage machine

Delete the resources on a virtual storage machine before you delete the virtual storage machine.

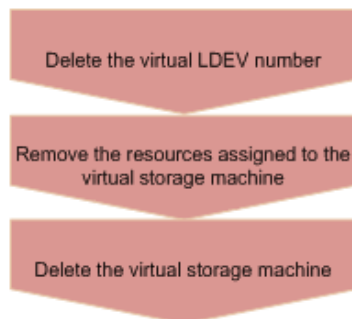
**Delete the virtual LDEV number**

Delete the virtual LDEV number that was set for the virtual LDEV on the virtual storage machine.

Remove the resources in the virtual storage machine

Delete the LDEVs, parity groups, host numbers, and all other resources that are added in the resource group in the virtual storage machine. Perform this operation by executing the API request for removing resources from resource groups.

Delete the virtual storage machine

Delete the virtual storage machine. Note that when all of the resource groups are deleted from the virtual storage machine, the virtual storage machine is automatically deleted.

Getting a list of virtual storage machines

The following request obtains a list of virtual storage machines. You can get information such as serial numbers, model names, and resource group IDs.

Execution permission

Storage Administrator (View Only)

Request line

```
GET base-URL/v1/objects/virtual-storages
```

Request message**Object ID**

None.

Query parameters

None.

Body

None.

Response message**Body**

```
{
  "data" : [
    {
      "virtualStorageDeviceId" : "800000002015",
      "virtualSerialNumber" : "2015",
      "virtualModel" : "VSP G1000/G1500 and VSP F1500",
      "resourceGroupIds" : [
        1,
        3
      ],
      "virtualStorageTypeId" : "R8"
    },
    {
      "virtualStorageDeviceId" : "882000400002",
      "virtualSerialNumber" : "400002",
      "virtualModel" : "VSP G350",
      "resourceGroupIds" : [
        0,
        2,
        4
      ],
      "virtualStorageTypeId" : "M850S1"
    }
  ]
}
```

| Attribute | Type | Description |
|------------------------|--------|--|
| virtualStorageDeviceld | string | Storage device ID of the virtual storage machine |
| virtualSerialNumber | string | Serial number of the virtual storage machine |
| virtualModel | string | Model name of the virtual storage machine |
| resourceGroupIds | int[] | Resource group ID |
| virtualStorageTypeld | string | Storage system type ID of the virtual storage machine If storage system is not be determined, <code>Unknown</code> is output. |

Status codes

For details on the status codes for the request that performs this operation, see the description of HTTP status codes.

Coding example

```
curl -v -H "Accept:application/json" -H "Content-Type:application/json" -H
"Authorization:Session d7b673af189048468c5af9bcf3b6bb6f" -X GET https://
192.0.2.100/ConfigurationManager/v1/objects/virtual-storages
```

Getting information about a specific virtual storage machine

The following request gets information about the specified virtual storage machine. You can get information such as serial numbers, model names, and resource group IDs.

Execution permission

Storage Administrator (View Only)

Request line

```
GET base-URL/v1/objects/virtual-storages/object-ID
```

Request message**Object ID**

Specify the `virtualStorageDeviceId` value obtained by getting information about the virtual storage machine.

| Attribute | Type | Description |
|-------------------------------------|--------|---|
| <code>virtualStorageDeviceId</code> | string | (Required) Storage device ID of the virtual storage machine |

Query parameters

None.

Body

None.

Response message**Body**

```
{
  "virtualStorageDeviceId" : "882000400002",
  "virtualSerialNumber" : "400002",
  "virtualModel" : "VSP G350",
  "resourceGroupIds" : [
    0,
    2,
    4
  ],
  "virtualStorageTypeId" : "M850S1"
}
```

| Attribute | Type | Description |
|-------------------------------------|--------|--|
| <code>virtualStorageDeviceId</code> | string | Storage device ID of the virtual storage machine |
| <code>virtualSerialNumber</code> | string | Serial number of the virtual storage machine |
| <code>virtualModel</code> | string | Model name of the virtual storage machine |
| <code>resourceGroupIds</code> | int[] | Resource group ID |

| Attribute | Type | Description |
|----------------------|--------|---|
| virtualStorageTypeid | string | Storage system type ID of the virtual storage machine If storage system is not be determined, Unknown is output. |

Status codes

For details on the status codes for the request that performs this operation, see the description of HTTP status codes.

Coding example

```
curl -v -H "Accept:application/json" -H "Content-Type:application/json" -H
"Authorization:Session d7b673af189048468c5af9bcf3b66b6f" -X GET https://
192.0.2.100/ConfigurationManager/v1/objects/virtual-storages/882000400002
```

Creating a virtual storage machine

The following request creates a virtual storage machine. A resource group is also created at the same time.



Note:

If you locked any resources of the target storage system by using the REST API, you will not be able to use this API function. In such cases, unlock the resources before running the API function.

Execution permission

Security Administrator (View & Modify)

Request line

```
POST base-URL/v1/objects/virtual-storages
```

Request message

Object ID

None.

Query parameters

None.

Body

```
{
  "virtualSerialNumber": "422222",
  "virtualModel": "VSP G700",
  "resourceGroupName": "DevGroup"
}
```

| Attribute | Type | Description |
|---------------------|--------|---|
| virtualSerialNumber | string | (Required) Serial number of the virtual storage machine |
| virtualModel | string | (Required) Model name of the virtual storage machine Specifiable values are as follows: <ul style="list-style-type: none"> ▪ VSP E990 ▪ VSP E790 ▪ VSP E590 ▪ VSP F900 ▪ VSP F700 ▪ VSP F370 ▪ VSP F350 ▪ VSP G900 ▪ VSP G700 ▪ VSP G370 ▪ VSP G350 ▪ VSP G130 ▪ VSP G800 and VSP F800[#] ▪ VSP G400/G600 and VSP F400/F600[#] ▪ VSP G200 ▪ HUS VM |

| Attribute | Type | Description |
|-------------------|--------|---|
| | | <ul style="list-style-type: none"> ▪ VSP 5000 series AFA ▪ VSP 5000 series hybrid ▪ VSP G1000/G1500 and VSP F1500 ▪ VSP |
| resourceGroupName | string | <p>(Required) Name of the resource group to be created when the virtual storage machine is created</p> <p>Specify a name consisting of 1 to 32 characters.</p> |

#: If the storage system model is VSP N400 or VSP N600, specify VSP G400/G600 and VSP F400/F600. If the storage system model is VSP N800, specify VSP G800 and VSP F800.

Response message

Body

A job object is returned. For details on attributes other than `affectedResources`, see the description of job objects.

| Attribute | Description |
|-------------------|--|
| affectedResources | URL of the created virtual storage machine |

Status codes

For details on the status codes of the request for this operation, see the description on HTTP status codes.

Coding example

```
curl -v -H "Accept:application/json" -H "Content-Type:application/json" -H
"Authorization:Session d7b673af189048468c5af9bcf3b6bb6f" -X POST --data-
binary @./InputParameters.json https://192.0.2.100/ConfigurationManager/v1/
objects/virtual-storages/
```

Deleting a virtual storage machine

The following request deletes a virtual storage machine. Remove all of the resources included in the virtual storage machine before running this request.



Note:

If you locked any resources of the target storage system by using the REST API, you will not be able to use this API function. In such cases, unlock the resources before running the API function.

Execution permission

Security Administrator (View & Modify)

Request line

```
DELETE base-URL/v1/objects/virtual-storages/object-ID
```

Request message

Object ID

Specify the `virtualStorageDeviceId` value obtained by getting information about the virtual storage machine.

| Attribute | Type | Description |
|-------------------------------------|--------|---|
| <code>virtualStorageDeviceId</code> | string | (Required) Storage device ID of the virtual storage machine |

Query parameters

None.

Body

None.

Response message

Body

A job object is returned. For details on attributes other than `affectedResources`, see the description of job objects.

| Attribute | Description |
|--------------------------------|--|
| <code>affectedResources</code> | URL of the deleted virtual storage machine |

Status codes

For details on the status codes of the request for this operation, see the description on HTTP status codes.

Coding example

```
curl -v -H "Accept:application/json" -H "Content-Type:application/json" -H
"Authorization:Session d7b673af189048468c5af9bcf3bbbb6f" -X DELETE
https://192.0.2.100/ConfigurationManager/v1/objects/virtual-storages/
409900010000
```

Getting information about virtual LDEVs

The following request gets information about the virtual LDEVs (LDEVs to which virtual LDEV numbers have been assigned) on a virtual storage machine. If no virtual LDEVs exist in the specified range, an empty list will be returned. To get information about virtual LDEVs, use multiple query parameters so that virtual LDEVs are included.

Execution permission

Storage Administrator (View Only)

Request line

```
GET base-URL/v1/objects/ldevs
```

Request message**Object ID**

None.

Query parameters

You can filter the execution result by specifying conditions, or request additional detailed information about virtual LDEVs. To get information about virtual LDEVs, specify the target virtual storage machine by using the `virtualSerialNumber` parameter.

- When filtering the execution result

By default, information about a maximum of 100 virtual LDEVs is obtained. You can get information about a maximum of 16,384 virtual LDEVs by specifying the `count` parameter. When the `ldevOption` parameter or the `poolId` parameter is specified, if the number of virtual LDEVs for which information is to be obtained exceeds 16,384, use the `headVirtualLdevId` parameter and specify a value so that the virtual LDEV numbers whose information is to be obtained are included in the range. The information that can be obtained is only about the number of virtual LDEVs that are included in the range specified by the combination of the `headVirtualLdevId` parameter and the `count` parameter.



Tip:

Of the resources displayed by the filter, you can obtain information only about the resources for which you have been granted access permissions.

For example, if you specify 10 for the `count` parameter and you have permission to access all virtual LDEVs, information about 10 virtual LDEVs will be obtained. If you have permission to access specific virtual LDEVs only, information will be obtained only about virtual LDEVs for which you have been granted access permissions.



Important:

For a VSP E series, VSP G350, G370, G700, G900, VSP F350, F370, F700, F900 storage system, pay attention to the number of concurrent executions of this API request. For details, see "Implementing retry processing".

For query parameters that can be specified at the same time, see the following table that lists the combinations of query parameters that can be specified.

| Parameter | Type | Filter Condition |
|----------------------------------|--------|--|
| <code>virtualSerialNumber</code> | string | (Required) Specify the serial number of a virtual storage machine. Information about virtual LDEVs on the virtual storage machine is obtained in the ascending order of virtual LDEV numbers. |
| <code>headVirtualLdevId</code> | int | (Optional) Specify the virtual LDEV number (a decimal) from which the processing to get information is to start. |

| Parameter | Type | Filter Condition |
|------------|--------|---|
| | | <p>Information about the LDEVs is obtained in the ascending order of virtual LDEV numbers, starting with the specified virtual LDEV number.</p> <p>If this parameter is omitted, 0 is assumed.</p> <p>When specifying this parameter, be sure to also specify the <code>virtualSerialNumber</code> parameter.</p> |
| count | int | <p>(Optional) Specify the number of virtual LDEVs about which you want to obtain information. Specify a value in the range from 1 to 16384.</p> <p>If this parameter is omitted, 100 is assumed.</p> |
| ldevOption | string | <p>(Optional) Virtual LDEV conditions for getting information</p> <p>You can specify the following conditions:</p> <ul style="list-style-type: none"> ▪ <code>defined</code> Get information about virtual LDEVs that have been implemented. ▪ <code>undefined</code> Get information about virtual LDEVs that are not implemented. ▪ <code>dpVolume</code> Obtaining DP volume information ▪ <code>luMapped</code> Get information about virtual LDEVs for which LU paths are defined. ▪ <code>luUnmapped</code> Get information about virtual LDEVs for which LU paths have not been defined. ▪ <code>externalVolume</code> Get information about external volumes. <p>If this is omitted, information about all types of virtual LDEVs will be obtained.</p> |
| poolId | int | <p>(Optional) Pool number</p> <p>Get information about the virtual LDEVs that are associated with the specified pool.</p> |

| Parameter | Type | Filter Condition |
|------------------------------|--------|--|
| | | <p>By using the <code>ldevOption</code> parameter when specifying conditions, the following information can be obtained:</p> <ul style="list-style-type: none"> ▪ If <code>dpVolume</code> is specified for the <code>ldevOption</code> parameter: Gets information about the DP volumes that are associated with the specified pool. ▪ If <code>luMapped</code> is specified for the <code>ldevOption</code> parameter: Gets information about virtual LDEVs for which LU paths associated with the specified pool are defined. ▪ If <code>luUnmapped</code> is specified for the <code>ldevOption</code> parameter: Gets information about virtual LDEVs for which LU paths associated with the specified pool have not been defined. <p>If you specify this parameter without specifying the <code>ldevOption</code> parameter, the API gets information about the volumes that make up the pool (pool volumes).</p> |
| <code>resourceGroupId</code> | int | (Optional) ID of the resource group to which virtual LDEVs for which information is to be obtained belong |
| <code>journalId</code> | int | (Optional) ID of the journal to which virtual LDEVs for which information is to be obtained belong |
| <code>parityGroupId</code> | string | <p>(Optional) Number of the parity group to which LDEVs for which information is to be obtained belong</p> <p>Specify concatenated parity groups in the same way as the above.</p> <p>If the concatenated parity groups are 1-3-1, 1-3-2, or 1-3-3, specify as follows:</p> <pre>parityGroupId=1-3</pre> |

The following table shows the combinations of query parameters that can be specified.

| Parameter | virtual Serial Number | headVirtualLdevId | count | ldevOption | poolId | resourceGroupId | journalId | parityGroupId |
|---------------------|-----------------------|-------------------|-------|------------|--------|-----------------|-----------|---------------|
| virtualSerialNumber | -- | Y | Y | Y | Y | Y | Y | Y |
| headVirtualLdevId | Y | -- | Y | Y | N | N | N | N |
| count | Y | Y | -- | Y | Y | Y | Y | Y |
| ldevOption | Y | Y | Y | -- | Y# | Y | N | N |
| poolId | Y | N | Y | Y# | -- | Y | N | N |
| resourceGroupId | Y | N | Y | Y | Y | -- | Y | Y |
| journalId | Y | N | Y | N | N | Y | -- | N |
| parityGroupId | Y | N | Y | N | N | Y | N | -- |

#: If defined, undefined, or externalVolume is specified as the value of the ldevOption parameter, you cannot specify this combination of parameters.

- When requesting additional detailed information

| Parameter | Type | Description |
|----------------|--------|--|
| detailInfoType | string | <p>(Optional) Type of detailed information to be obtained</p> <p>You can use this parameter together with parameters that filter the execution results.</p> <p>The following values can be specified. To specify multiple values, separate the values by using commas.</p> <ul style="list-style-type: none"> ▪ FMC <p>Adds detailed information about accelerated compression for the virtual LDEVs that belong to parity groups with drive type SSD (FMC).</p> <ul style="list-style-type: none"> ▪ virtualSerialNumber <p>Adds detailed information about virtual storage machines.</p> |

| Parameter | Type | Description |
|-----------|------|---|
| | | <ul style="list-style-type: none"> ▪ <code>class</code> Adds additional information from the storage system's cache. You can specify this item for VSP 5000 series. To get up-to-date information, you must run the API request that refreshes the storage system's cache before running this request. For details, see "Updating the cache of storage system configuration information". Immediately after you create an LDEV, if you specify <code>class</code> and at the same time specify <code>defined</code> in the query parameter <code>ldevOption</code> and then run the command, the volume status might be output as unimplemented. In such a case, wait a while and then run this request again. Alternatively, run the API request that updates the cache of storage system configuration information, and then run this request again. ▪ <code>qos</code> Adds information about QoS settings. You can specify this item for VSP 5000 series, VSP G350, G370, G700, G900, VSP F350, F370, F700, F900. |

Body

None.

Response message**Body**

```
{
  "data": [
    {
      "ldevId": 0,
      "virtualLdevId": 0,
      "virtualSerialNumber": "410012",
      "clprId": 0,
      "emulationType": "OPEN-V-CVS",
      "byteFormatCapacity": "1.00 G",
      "blockCapacity": 2097152,
    }
  ]
}
```



```

    "numOfPorts": 1,
    "ports": [
      {
        "portId": "CL3-B",
        "hostGroupNumber": 25,
        "hostGroupName": "bs10300-7",
        "lun": 19
      }
    ],
    "attributes": [
      "CVS",
      "HDP",
      "GAD"
    ],
    "status": "NML",
    "mpBladeId": 2,
    "ssid": "0004",
    "poolId": 4,
    "numOfUsedBlock": 0,
    "isFullAllocationEnabled": false,
    "resourceGroupId": 6,
    "dataReductionStatus": "DISABLED",
    "dataReductionMode": "disabled",
    "isAluaEnabled": false
  },
  {
    "ldevId": 1,
    "virtualLdevId": 1,
    "virtualSerialNumber": "410012",
    "clprId": 0,
    "emulationType": "OPEN-V-CVS",
    "byteFormatCapacity": "1.00 G",
    "blockCapacity": 2097152,
    "numOfPorts": 1,
    "ports": [
      {
        "portId": "CL3-B",
        "hostGroupNumber": 25,
        "hostGroupName": "bs10300-7",
        "lun": 21
      }
    ],
    "attributes": [
      "CVS",
      "HDP",
      "GAD"
    ],
    "label": "ldev_label_1",
    "status": "NML",

```

```

    "mpBladeId": 0,
    "ssid": "0004",
    "poolId": 10,
    "numOfUsedBlock": 0,
    "isFullAllocationEnabled": false,
    "resourceGroupId": 6,
    "dataReductionStatus": "DISABLED",
    "dataReductionMode": "disabled",
    "isAluaEnabled": false
  }
]
}

```

The following table describes the attributes to be obtained in the body of the response message. For details on attributes to be obtained, see the description of the API function for getting volume information.

| Attribute | Type | Description |
|---------------------|--------|--|
| ldevId | int | LDEV number |
| virtualLdevId | int | Virtual LDEV number |
| virtualSerialNumber | string | Serial number of the virtual storage machine |

If you execute the request with `virtualSerialNumber` specified for the `detailInfoType` query parameter, the request also obtains detailed information about the virtual storage machines.

| Attribute | Type | Description |
|--------------|--------|---|
| virtualModel | string | Model name of the virtual storage machine |

If you run this request with `class` specified for `detailInfoType` in the query parameters, additional information from the storage system's cache is also obtained.

| Attribute | Type | Description |
|----------------------|--------|--|
| virtualEmulationType | string | Virtual emulation type of the virtual LDEV |
| virtualSsid | int | Virtual SSID of the virtual LDEV |

| Attribute | Type | Description |
|--------------|---------|---|
| isVirtualCvs | boolean | Whether a virtual CVS is set for the virtual LDEV <ul style="list-style-type: none"> true: Set false: Not set |

Status codes

For details on the status codes of the request for this operation, see the section explaining HTTP status codes.

Coding example

```
curl -v -H "Accept:application/json" -H "Content-Type:application/json" -H
"Authorization:Session d7b673af189048468c5af9bcf3bbbb6f" -X GET "https://
192.0.2.100/ConfigurationManager/v1/objects/ldevs?
count=2&virtualSerialNumber=410012"
```

Setting a virtual LDEV number

The following request sets a virtual LDEV number for an LDEV.

Execution permission

Storage Administrator (Provisioning)

Request line

```
POST base-URL/v1/objects/ldevs/object-ID/actions/assign-virtual-ldevid/
invoke
```

Request message

Object ID

Specify the `ldevId` value obtained by getting information about volumes.

| Attribute | Type | Description |
|-----------|------|---|
| ldevId | int | (Required) Specify the LDEV number with a decimal (base 10) number. |

Query parameters

None.

Body

The following coding example sets the virtual LDEV number 405 for a LDEV:

```
{
  "parameters": {
    "virtualLdevId": 405
  }
}
```

| Attribute | Type | Description |
|---------------|------|--|
| virtualLdevId | int | (Required) Specify the virtual LDEV number with a decimal (base 10) number. If you specify 65535, the reserved attribute of global-active device will be set. |

Response message**Body**

A job object is returned. For details on attributes other than affectedResources, see the section explaining job objects.

| Attribute | Description |
|-------------------|--|
| affectedResources | URL of the LDEV for which the virtual LDEV number is set |

Action template

```
GET base-URL/v1/objects/ldevs/object-ID/actions/assign-virtual-ldevId
```

Status codes

The following table describes the meaning of the status code of the request for this operation. For details on other status codes, see the description on HTTP status codes.

| Status code | Message | Description |
|-------------|---------------------|---|
| 412 | Precondition Failed | The virtual LDEV number is already set for the target LDEV. |

Coding example

To get an action template:

```
curl -v -H "Accept:application/json" -H "Content-Type:application/json" -H
"Authorization:Session d7b673af189048468c5af9bcf3bbbb6f" -X GET https://
192.0.2.100/ConfigurationManager/v1/objects/ldevs/1/actions/assign-virtual-
ldevId
```

To run the request after getting an action template:

```
curl -v -H "Accept:application/json" -H "Content-Type:application/json" -H
"Authorization:Session d7b673af189048468c5af9bcf3bbbb6f" -X POST --data-
binary @./InputParameters.json https://192.0.2.100/ConfigurationManager/v1/
objects/ldevs/1/actions/assign-virtual-ldevId/invoke
```

Deleting a virtual LDEV number

The following request deletes the virtual LDEV number set for an LDEV.

Execution permission

Storage Administrator (Provisioning)

Request line

```
POST base-URL/v1/objects/ldevs/object-ID/actions/unassign-virtual-ldevId/
invoke
```

Request message**Object ID**

Specify the `ldevId` value obtained by getting information about the virtual LDEV number.

| Attribute | Type | Description |
|-----------|------|---|
| ldevId | int | (Required) Specify the LDEV number with a decimal (base 10) number. |

Query parameters

None.

Body

The following coding example deletes virtual LDEV number 405:

```
{
  "parameters": {
    "virtualLdevId": 405
  }
}
```

| Attribute | Type | Description |
|---------------|------|--|
| virtualLdevId | int | (Required) Specify the virtual LDEV number with a decimal (base 10) number. If you specify 65535, the reserved attribute of global-active device is canceled. |

Response message**Body**

A job object is returned. For details on attributes other than affectedResources, see the section explaining job objects.

| Attribute | Description |
|-------------------|--|
| affectedResources | URL of the LDEV for which the virtual LDEV number is deleted |

Action template

```
GET base-URL/v1/objects/ldevs/object-ID/actions/unassign-virtual-ldevId
```

Status codes

The following table describes the meaning of the status code of the request for this operation. For details on other status codes, see the description on HTTP status codes.

| Status code | Message | Description |
|-------------|---------------------|---|
| 412 | Precondition Failed | The virtual LDEV number is not set for the target LDEV. |

Coding example

To get an action template:

```
curl -v -H "Accept:application/json" -H "Content-Type:application/json" -H  
"Authorization:Session d7b673af189048468c5af9bcf3bbbb6f" -X GET https://  
192.0.2.100/ConfigurationManager/v1/objects/ldevs/1/actions/unassign-  
virtual-ldevid
```

To run the request after getting an action template:

```
curl -v -H "Accept:application/json" -H "Content-Type:application/json" -H  
"Authorization:Session d7b673af189048468c5af9bcf3bbbb6f" -X POST --data-  
binary @./InputParameters.json https://192.0.2.100/ConfigurationManager/v1/  
objects/ldevs/1/actions/unassign-virtual-ldevid/invoke
```

Chapter 19: Sample coding

This chapter explains the sample coding.

Overview of sample coding

This section provides sample client coding written in Python, as reference information for calling and using the REST API. The sample client coding includes basic code constructs required for client programs, including those for getting information about, creating, and changing the attributes of objects. Each sample of client coding shows an operation example such as allocating a volume or creating a copy pair. You can apply the code constructs included in the sample client coding to other use cases.

Code constructs of sample coding

The following operations are performed by the sample coding:

- Allocate a volume
In one of the samples, an HDP volume is created from an HDP pool that has already been created, and the volume is made accessible by allocating it to a host.
- Operate a ShadowImage pair
In one of the samples, volumes that have already been created are used to create a ShadowImage pair. After the pair is split, the status of the pair is verified.
- Register remote storage system information
In one of the code samples, information about the remote storage systems is registered to the REST API server of the local storage system. This is a prerequisite operation for a remote copy operation.
- Operate a TrueCopy pair
In one of the code samples, a TrueCopy pair is created by using volumes that have already been created, and the pair status is checked. A resource group is locked while the pair is being created.
- Upload files (specify the transfer destinations of audit log files)
Specify settings so that the audit log files of storage systems are transferred to the syslog server. This sample coding includes the procedure for uploading the client certificates to a storage system.

- Download a file (back up encryption keys)

Back up the encryption keys by using a REST API client. This sample coding includes the procedure for downloading an encryption backup file to a client. The supported storage systems for this sample coding are VSP E series, VSP G350, G370, G700, G900, VSP F350, F370, F700, F900.

- Re-create a parity group (encrypt data)

Delete an existing parity group, and then create a parity group for which encryption is enabled. This operation is performed as part of the procedure for encrypting existing data without changing the drive configuration. For details on the entire procedure, see the description of the flow of data encryption operations. The supported storage systems for this sample coding are VSP E series, VSP G350, G370, G700, G900, VSP F350, F370, F700, F900.

Code constructs such as the following are included in the previously listed operations:

1. Processing that is run before the REST API is called
 - Generating request bodies in JSON format
 - Creating form data
 - Specifying request headers (for the default HTTP headers or for the custom HTTP headers)
 - Setting user authentication information (for authentication by using a user ID and a password, or for authentication by using session-based authentication)
 - Getting the URLs of the resources (when object IDs are not specified or when object IDs that are obtained from the operation results are specified, or when fixed object IDs such as those for single instances are specified)
2. Processing to call the REST API
 - Getting information about the version of the REST API by performing a GET operation
 - Getting the action template by performing a GET operation
 - Changing object attributes by performing a PATCH operation
 - Running actions that use the action template by performing a POST operation
 - Running actions for objects by using the POST operation
 - Running actions for services by performing a POST operation
 - Creating objects by performing a POST operation
 - Running actions for objects by using the POST operation
 - Operations that require sessions to be generated on multiple devices (remote copy operation)
 - Deleting objects by performing a DELETE operation
3. Processing that is run after the REST API is called
 - Outputting obtained information
 - Getting job execution results

- Getting the URLs of the resources to which the operation results have been applied
- Getting error codes
- Outputting error messages

The following table shows an example of using each code construct included in the samples. For details about each code, see the description of each sample coding.

| Code constructs | Example of using sample coding | Corresponding sample coding |
|--|--|--|
| Generating a request body in JSON format | Define functions for issuing an HTTP request and for verifying the status of asynchronous processing. | Volume allocation Operate a ShadowImage pair |
| | Create an HDP volume. | Volume allocation |
| | Create a ShadowImage pair. | Operate a ShadowImage pair |
| Creating form data | Upload the root certificate of the syslog server to which audit log files are to be transferred. Upload the client certificate of the syslog server to which audit log files are to be transferred. | Upload files (specify the transfer destinations of audit log files) |
| Specifying request headers (for the default HTTP headers) | Define headers. | Volume allocation Operate a ShadowImage pair Register remote storage system information Operate a TrueCopy pair |
| Specifying request headers (for the custom HTTP headers) | Define headers. | Operate a ShadowImage pair |
| Setting user authentication information (for authentication by using a user ID and a password) | Generate a session. | Volume allocation Operate a ShadowImage pair Register remote storage system information |

| Code constructs | Example of using sample coding | Corresponding sample coding |
|--|---|---|
| | | Operate a TrueCopy pair |
| Setting user authentication information (for authentication by using session-based authentication) | Define functions for issuing an HTTP request and for verifying the status of asynchronous processing. | Volume allocation Operate a ShadowImage pair |
| | Create an HDP volume. | Volume allocation |
| | Split a ShadowImage pair. | Operate a ShadowImage pair |
| Getting the URLs of the resources (when object IDs are not specified) | Create an HDP volume. (BlockStorageAPI.idevs) | Volume allocation |
| | Create a host group. (BlockStorageAPI.host_groups) | Volume allocation |
| | Create a ShadowImage pair. (BlockStorageAPI.local_copy_pairs) | Operate a ShadowImage pair |
| Getting the URLs of the resources (when object IDs that are obtained from the operation results are specified) | Create a host group. (BlockStorageAPI.affected_resource) | Volume allocation |
| | Create a ShadowImage pair. (BlockStorageAPI.affected_resource) | Operate a ShadowImage pair |
| Getting the URLs of the resources (when fixed object IDs such as those for single instances are specified) | Specify the syslog server to which audit log files are to be transferred. (BlockStorageAPI.auditlog_syslog) Send a test message to the syslog server to which audit log files are to be transferred. (BlockStorageAPI.auditlog_syslog_send_test) | Upload files (specify the transfer destinations of audit log files) |
| | Download the encryption key backup file. (BlockStorageAPI.encryption_key_file_backup) | Download a file (back up encryption keys) |

| Code constructs | Example of using sample coding | Corresponding sample coding |
|---|---|--|
| Getting information about the version of the REST API by performing the GET operation | Check the version of the REST API. (BlockStorageAPI.api_version) | Volume allocation Operate a ShadowImage pair Register remote storage system information Operate a TrueCopy pair |
| Getting an object by performing the GET operation | Get HDP volume information. (BlockStorageAPI.ldev) | Volume allocation |
| | Get information about a ShadowImage pair. | Operate a ShadowImage pair |
| Getting the action template by performing the GET operation | Split a ShadowImage pair. (BlockStorageAPI.split_local_copy_pair_template) | Operate a ShadowImage pair |
| Getting information about the job status by performing the GET operation | Define functions for issuing an HTTP request and for verifying the status of asynchronous processing. | Volume allocation Operate a ShadowImage pair Register remote storage system information |
| | Define the function for getting status changes for asynchronous processing. | Operate a TrueCopy pair |
| Changing the object attribute by performing the PATCH operation | Change the host mode. | Volume allocation |
| Running actions that use the action template by performing a POST operation | Split a ShadowImage pair. (BlockStorageAPI.split_local_copy_pair) | Operate a ShadowImage pair |
| Running actions for objects by using the POST operation | Send a test message to the syslog server to which audit log files are to be transferred. | Upload files (specify the transfer destinations of audit log files) |
| Running actions for services by performing a POST operation | Lock resources. Unlock resources. | Operate a TrueCopy pair |

| Code constructs | Example of using sample coding | Corresponding sample coding |
|--|--|--|
| Creating objects by performing a POST operation | Create an HDP volume. (BlockStorageAPI.ldevs) Register the WWN of the host. (BlockStorageAPI.host_wwns) Create a host group. (BlockStorageAPI.host_groups) Set an LU path. (BlockStorageAPI.luns) | Volume allocation |
| | Create a ShadowImage pair. (BlockStorageAPI.local_copy_pairs) | Operate a ShadowImage pair |
| Running actions for objects by using the POST operation | Upload the root certificate of the syslog server to which audit log files are to be transferred. Upload the client certificate of the syslog server to which audit log files are to be transferred. | Upload files (specify the transfer destinations of audit log files) |
| Operations that require sessions to be generated on multiple devices (remote copy operation) | Create a TrueCopy pair. | Operate a TrueCopy pair |
| Deleting objects by performing a DELETE operation | Discard the session. | Volume allocation Operate a ShadowImage pair Register remote storage system information Operate a TrueCopy pair |
| Outputting the obtained information | Get HDP volume information. | Volume allocation |
| | Get information about a ShadowImage pair. | Operate a ShadowImage pair |
| Getting the job execution results | Define functions for issuing an HTTP request and for | Volume allocation |

| Code constructs | Example of using sample coding | Corresponding sample coding |
|--|---|--|
| | verifying the status of asynchronous processing. (BlockStorageAPI.job) | Operate a ShadowImage pair Register remote storage system information |
| | Define the function for getting status changes for asynchronous processing. | Operate a TrueCopy pair |
| Getting the URLs of the resources to which the operation results have been applied | Define functions for issuing an HTTP request and for verifying the status of asynchronous processing. | Volume allocation Operate a ShadowImage pair Register remote storage system information |
| | Define the function for getting status changes for asynchronous processing. | Operate a TrueCopy pair |
| Getting error codes | Define functions for issuing an HTTP request and for verifying the status of asynchronous processing. | Volume allocation Operate a ShadowImage pair Register remote storage system information |
| | Define the function for getting status changes for asynchronous processing. | Operate a TrueCopy pair |
| Outputting error messages | Output error messages. | Volume allocation Operate a ShadowImage pair Register remote storage system information Operate a TrueCopy pair |

Structure of sample coding

The following operations are shared by the samples. These operations are implemented as functions, which are called and executed by the main operation. For details on each function, see the section explaining the functions used in the sample coding.

- **Generating a URL (BlockStorageAPI class)**
Creates a URL to issue an HTTP request to the storage system.
- **Issuing an HTTP request and verify the status of the asynchronous processing (invoke_async_command)**
Issues an HTTP request, verifies whether the execution results of the asynchronous processing have been applied, and then returns the result.
- **Getting status changes for asynchronous processing (wait_until_jobstatus_is_changed)**
Verifies that jobs have moved to the status specified in the parameter, and then returns the result.

Sample coding files

The following describes files that are provided as sample coding and their content:

- `provisioning.py`
This file contains sample coding for volume allocation.
- `local_copy.py`
This file contains sample coding for ShadowImage pair operations.
- `register_remote_storage.py`
This file contains sample coding for registering remote storage system information.
- `synchronous_remote_copy.py`
This file contains sample coding for TrueCopy pair operations.
- `auditlog_syslog_server_setting.py`
This file contains sample coding for uploading files (specifying the transfer destinations of audit log files).
- `backup_encryption_keys.py`
This file contains sample coding for downloading a file (backing up encryption keys).
- `recreate_parity_group.py`
This file contains sample coding for re-creating a parity group (encrypting data).
- `block_storage_api.py`
This file defines the BlockStorageAPI class.
- `rest_server_param.py`
This file defines information about the server where the REST API server is installed.
- `storage_param.py`
This file defines information about the local storage system.
- `remote_copy_param.py`
This file defines information about the remote and the local storage systems.

You can download the sample coding file from the following URL:

For VSP 5000 series storage systems:

`http://SVP-IP-address/download/samplecode.zip`

For VSP E series, VSP G350, G370, G700, G900, VSP F350, F370, F700, F900 storage systems:

`http://GUM-IP-address/download/restapi/samplecode.zip`

Operation environment for sample coding

The samples are coded in the script language Python. Python code has excellent readability. Python is a versatile programming language widely used by Web service developers. Please download Python from the official Python website (<https://www.python.org/>) and configure the operation environment.

The code samples provided in this chapter use the standard library (json, sys, http.client, time, and traceback). Along with the standard library, you are also going to use the Requests library, which is a third-party library. Please download it from the web page for downloading the Requests library.

Note that the operations of the code samples described in this chapter have been checked in an environment of Python 3.7.5 and Requests 2.13.0.



Tip: To prevent errors that occur when the server certificate used for SSL communication between the REST API client and the storage system is a self-signed certificate, the sample coding specifies that verification of the server certificate is skipped when a request is issued.

Sample coding for volume allocation

This section explains the sample coding for volume allocation.

Sample coding operation flow for volume allocation

The following table shows the sample coding operation flow for volume allocation and the corresponding code constructs.

| Step | Sample coding operation flow | Code constructs |
|------|---|--|
| 1 | Import necessary libraries and set parameters. | - |
| 2 | Define headers. | Specifying request headers (for the default HTTP headers) |
| 3 | Define functions for issuing an HTTP request and for verifying the status of asynchronous processing. | Getting information about the job status by performing a GET operation Setting user authentication information (for authentication by using session-based authentication) Generating a request body in JSON format Getting the job execution results Getting the URLs of the resources to which the operation results have been applied Getting error codes |
| 4 | Check the version of the REST API. | Getting information about the version of the REST API by performing a GET operation |
| 5 | Generate a session. | Getting the URLs of the resources (when object IDs are not specified) |

| Step | Sample coding operation flow | Code constructs |
|------|-------------------------------|--|
| | | Setting user authentication information (for authentication by using a user ID and a password) Creating objects by performing a POST operation |
| 6 | Create an HDP volume. | Getting the URLs of the resources (when object IDs are not specified) Setting user authentication information (for authentication by using session-based authentication) Generating a request body in JSON format Creating objects by performing a POST operation |
| 7 | Create a host group. | Getting the URLs of the resources (when object IDs are not specified) Generating a request body in JSON format Creating objects by performing a POST operation Getting the URLs of the resources (when object IDs that are automatically obtained from the operation results are specified) |
| 8 | Change the host mode. | Generating a request body in JSON format Changing the object attribute by performing a PATCH operation |
| 9 | Register the WWN of the host. | Getting the URLs of the resources (when object IDs are not specified) Generating a request body in JSON format Creating objects by performing a POST operation |
| 10 | Set an LU path. | Getting the URLs of the resources (when object IDs are not specified) Generating a request body in JSON format Creating objects by performing a POST operation |
| 11 | Get HDP volume information. | Getting an object by performing the GET operation Setting user authentication information (for authentication by using session-based authentication) Outputting the obtained information |
| 12 | Output error messages. | Outputting error messages |

| Step | Sample coding operation flow | Code constructs |
|------|------------------------------|---|
| 13 | Discard the session. | Getting the URLs of the resources (when object IDs that are obtained from the operation results are specified) Deleting objects by performing a DELETE operation |

Expected system configuration

This sample coding assumes the system configuration is as shown in the following figure.

Before execution

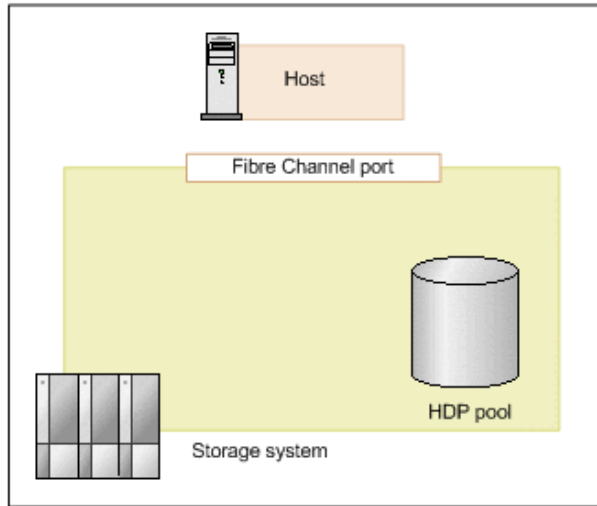

After execution

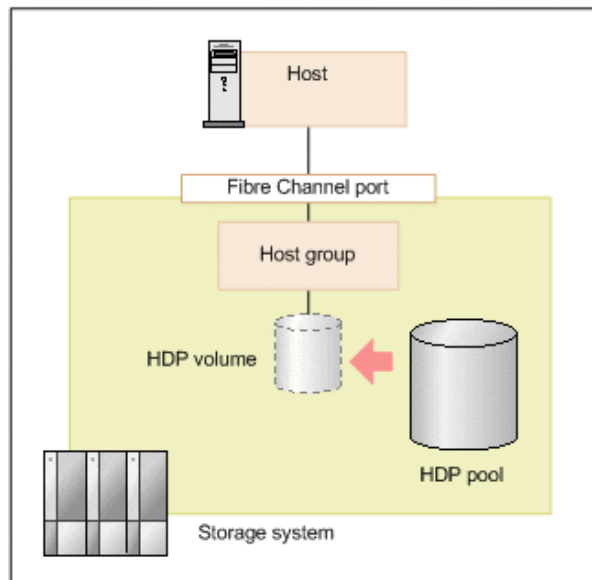

(Legend)

— : LU path

The following table shows the values specified for the parameters in the sample coding. If necessary, change the settings to match the system environment and requirements.

| Parameter | Value | Description |
|-----------------|-----------------------|---|
| USER_CREDENTIAL | ("user1", "pass1") | This is the authentication information to be used for authentication in the storage system. The coding sample shows a setting example when the user ID is <code>user1</code> , and the password is <code>pass1</code> . The user needs the Storage Administrator (Provisioning) role. |

| Parameter | Value | Description |
|-----------------|----------------------|---|
| POOL_ID | 8 | ID of the created HDP pool which will be used to create the HDP volume |
| BYTE_CAPACITY | 1T | Capacity of the HDP volume to be created |
| PORT_ID | ["CL1-A"] | The array of names of the Fibre Channel port that is used for I/O with the host |
| HOST_GRP_NAME | WindowsHost | The host group name to be created in order to associate the host and the port |
| HOST_MODE | WIN | The host mode to be specified for the host group |
| HOST_WWN | aaaabbbbcccc 0123 | The WWN of the host |
| FIRST_WAIT_TIME | 1 | The first interval (seconds) for collecting the execution result of asynchronous processing. Normally, you do not need to change this value. |
| MAX_RETRY_COUNT | 6 | The maximum number of retries for collecting the execution result of asynchronous processing. Normally, you do not need to change this value. |

Contents of the sample coding

This subsection explains the sample coding.

1. Import necessary libraries and set parameters.

Before starting the volume allocation processing, the sample coding imports the required libraries or classes. In addition to the common libraries, the sample coding also imports the BlockStorageAPI class that defines the function that generates URLs.

```
# coding:utf-8

"""
provisioning

This program requires API version 1.9.0 or newer.
"""

import requests
import json
import sys
import http.client
import time
import traceback
import rest_server_param
import storage_param
```

```
from block_storage_api import BlockStorageAPI
```

Set parameters to be used in the sample coding.

```
# #####Initialize parameters##### #
# Change the following parameters to fit your environment

# A POOL ID for creating a volume
POOL_ID = 8

# The DP volume capacity to create
BYTE_CAPACITY = "1T"

# A port name to add a LUN path
PORT_ID = ["CL1-A"]

# A host group name to create
# You can assign any host group name
HOST_GRP_NAME = "WindowsHost"

# A Host mode for the created host group
# Please refer to the manual and set an appropriate mode
HOST_MODE = "WIN"

# A World Wide Name of the host (HBA) to allocate the volume
HOST_WWN = "aaaabbbbcccc0123"

# This parameter defines the first interval to access
# an asynchronous job. (Unit: Second)
FIRST_WAIT_TIME = 1

# This parameter defines the maximum retry time
# to confirm job status.
MAX_RETRY_COUNT = 6

# An user id and password of the target storage
USER_CREDENTIAL = ("user1", "pass1")

#####
```

2. Define headers.

Define the HTTP request header. Because the REST API only supports JSON format data, the sample coding defines header information so that data is handled in JSON format.

```
# ###You don't have to change the following parameters### #
block_storage_api = BlockStorageAPI(
```

```
rest_server_param.REST_SERVER_IP_ADDR,  
rest_server_param.REST_SERVER_PORT,  
storage_param.STORAGE_MODEL,  
storage_param.SERIAL_NUMBER)  
  
headers = {"content-type": "application/json",  
          "accept": "application/json"}  
  
REQUIRED_MAJOR_VERSION = 1  
REQUIRED_MINOR_VERSION = 9  
  
session_id = 0  
  
#####
```

3. Define the function for issuing an HTTP request and for verifying the status of asynchronous processing (the `invoke_async_command` function).

Define the function that issues an HTTP request and verifies the status of asynchronous processing. Call and use this function from the main volume allocation operation. For details on this function, see the section explaining the functions used in the sample coding.



Tip: To prevent errors that occur when the server certificate used for SSL communication between the REST API client and the storage system is a self-signed certificate, the sample coding specifies `verify=False` in the request message to skip verification of the server certificate.

```
"""
Check whether the asynchronous command was finished.
@param job_id the job ID to identify
           the asynchronous command
@return r the response data
"""

def check_update(job_id):
    url = block_storage_api.job(str(job_id))
    r = requests.get(url, headers=headers, verify=False)
    return r
```

```
"""
Execute the HTTP request (POST or PATCH)
@param method_type HTTP request method (POST or PATCH)
@param url URL to execute HTTP method
@param body The information of a resource
@return job_result.json()["affectedResources"][0]
           URL of an affected resource
"""

def invoke_async_command(method_type, url, body):
    if method_type == "patch":
        r = requests.patch(url, headers=headers,
                          data=json.dumps(body), verify=False)
    elif method_type == "post":
        r = requests.post(
            url,
            headers=headers,
            data=json.dumps(body),
            verify=False)
    if r.status_code != http.client.ACCEPTED:
        raise requests.HTTPError(r)
    print("Request was accepted. JOB URL : " +
          r.json()["self"])
```

```
status = "Initializing"
```



```

job_result = None
retry_count = 1
wait_time = FIRST_WAIT_TIME
while status != "Completed":
    if retry_count > MAX_RETRY_COUNT:
        raise Exception("Timeout Error! "
                        "Operation was not completed.")
    time.sleep(wait_time)
    job_result = check_update(r.json()["jobId"])
    status = job_result.json()["status"]
    double_time = wait_time * 2
    if double_time < 120:
        wait_time = double_time
    else:
        wait_time = 120
    retry_count += 1
if job_result.json()["state"] == "Failed":
    error_obj = job_result.json()["error"]
    if "errorCode" in error_obj:
        if "SSB1" in error_obj["errorCode"]:
            print("Error! SSB code : ",
                  error_obj["errorCode"]["SSB1"],
                  ", ", error_obj["errorCode"]["SSB2"])
        elif "errorCode" in error_obj["errorCode"]:
            print("Error! error code : ",
                  error_obj["errorCode"]["errorCode"])
    raise Exception("Job Error!", job_result.text)

print("Async job was succeeded. affected resource : " +
      job_result.json()["affectedResources"][0])
return job_result.json()["affectedResources"][0]

```

4. Check the version of the REST API.

Get information about the version of the REST API to make sure that the version is supported.

```

"""
Check whether this API version allows the REST
Server to execute this program

@param api_version api version of this REST Server
@param required_major_version the lowest number of
    the major version that this program requires
@param required_minor_version the lowest number of
    the minor version that this program requires

"""

def check_api_version(api_version, required_major_version,
                     required_minor_version):
    version = api_version.split(".")
    major_version = int(version[0])
    minor_version = int(version[1])
    if not ((major_version == required_major_version and
            minor_version >= required_minor_version) or
            major_version >= required_major_version + 1):
        sys.exit("This program requires API Version " +
                str(required_major_version) + "." +
                str(required_minor_version) +
                "." + "x or newer.\n")

try:
    # step1 Check the API version #
    print("Check the API version")
    url = block_storage_api.api_version()
    r = requests.get(url, headers=headers, verify=False)
    if r.status_code != http.client.OK:
        raise requests.HTTPError(r)
    check_api_version(
        r.json()["apiVersion"],
        REQUIRED_MAJOR_VERSION,
        REQUIRED_MINOR_VERSION)

```

5. Generate a session.

Generate sessions by using the REST API server.

```
# step2 Generate a session #
print("Generate a session")
url = block_storage_api.generate_session()
r = requests.post(url, headers=headers, auth=USER_CREDENTIAL,
                  verify=False)
if r.status_code != http.client.OK:
    raise requests.HTTPError(r)
token = r.json()["token"]
auth = "Session " + token
session_id = r.json()["sessionId"]
```

When a session is generated, a session ID and a token are returned. When running the API, specify the token for the Authentication header as the required authentication information for the subsequent operations. Use the session ID to discard the session after a set of operations is completed.

6. Create an HDP volume.

Specify the pool ID, and the volume capacity, and then create the HDP volume.

```
# step3 Add an LDEV #
print("Add an LDEV")
url = block_storage_api.ldevs()
headers["Authorization"] = auth
body = {
    "poolId": POOL_ID,
    "byteFormatCapacity": BYTE_CAPACITY,
    "isParallelExecutionEnabled": True
}
ldev_id = invoke_async_command("post", url, body).split("/")[-1]
```

The `invoke_async_command` function issues the request to create the HDP volume, checks the execution status of the jobs that were run asynchronously, and then returns the URL of the created HDP volume as the execution result.

7. Create a host group.

To allocate the created HDP volume to the host, create a host group. The sample coding only specifies the port number to be used by the host group and the host group name. Specification of the host group number is omitted. In this case, a host group number is automatically assigned.

```
# step4 Add a host group #
print("Add a host group")
url = block_storage_api.host_groups()
body = {
    "portId": PORT_ID[0],
    "hostGroupName": HOST_GRP_NAME
}
affected_resource_path = invoke_async_command("post",
                                             url, body)
```

Get the URL of the created host group and the assigned host group number.

```
url = block_storage_api.affected_resource(
    affected_resource_path)

r = requests.get(url, headers=headers, verify=False)
if r.status_code != http.client.OK:
    raise requests.HTTPError(r)

host_group_number = r.json()["hostGroupName"]
```

8. Change the host mode.

Change the host mode of the created host group according to the platform of the host to which the volume will be allocated. To issue a request to change the host mode, use the URL of the host group that was obtained in the step when the host group was created.

```
# step5 Modify the host group #
print("Modify the host group")
body = {
    "hostMode": HOST_MODE
}
invoke_async_command("patch", url, body)
```

9. Register the WWN of the host.

Register the host to which the HDP volume will be allocated in the host group that you created. Specify the WWN of the HBA of the host to be registered, the port number of the host group, and the assigned host group number. Use the host group number that was obtained when the host group was created.

```
# step6 Add an HBA WWN #
print("Add an HBA WWN")
url = block_storage_api.host_wwns()
body = {
    "hostWwn": HOST_WWN,
    "portId": PORT_ID[0],
    "hostGroupNumber": host_group_number
}
invoke_async_command("post", url, body)
```

10. Set an LU path.

Set the LU path by associating the created volume with the host group. The sample coding specifies the LDEV number of the created HDP volume, the port number to be used by the host group, and the host group number. Specification of the LUN is omitted. In this case, a LUN is automatically assigned.

```
# step7 Add a LUN path #
print("Add a LUN path")
url = block_storage_api.luns()
body = {
    "ldevId": ldev_id,
    "portIds": PORT_ID,
    "hostGroupNumber": host_group_number
}
invoke_async_command("post", url, body)
```

The LU path is set, and the HDP volume is now accessible from the host.

11. Get HDP volume information.

To check whether the operations up to this step have been correctly applied to the resource, specify the LDEV number that was obtained when the HDP volume was created, and then obtain HDP volume information. From the collected information, the sample coding outputs the LDEV number, the ID of the pool from which the volume was created, the capacity of the HDP volume, and the assigned port.

```
# step8 Print the LDEV #
print("Print the LDEV")
url = block_storage_api.ldev(ldev_id)
r = requests.get(url, headers=headers, verify=False)
if r.status_code != http.client.OK:
    raise requests.HTTPError(r)

print("LDEV ID : " + str(r.json()["ldevId"]))
print("POOL ID : " + str(r.json()["poolId"]))
print("CAPACITY : " +
      str(r.json()["byteFormatCapacity"]))
print("PORT : " + str(r.json()["ports"]))
print()
```

12. Output error messages.

In the sample coding, processing for communication errors, HTTP request errors, and job execution errors is described. If a communication error occurs, an error message is output. If an HTTP request error occurs, the error code, the error message, and the response body are output. If a job execution error occurs, all of the contents included in the job execution result are output.

```
except requests.ConnectionError:
    sys.stderr.write("Connection Error!\n")
    sys.stderr.write(traceback.format_exc())
except requests.HTTPError as he:
    sys.stderr.write("HTTP Error! status code : ")
    sys.stderr.write(str(he.args[0].status_code) + "\n")
    sys.stderr.write(he.args[0].text + "\n")
except Exception as e:
    sys.stderr.write(traceback.format_exc())
    for msg in e.args:
        sys.stderr.write(str(msg) + "\n")
```

13. Discard the session.

After a set of operations is completed, discard the session. Specify the session ID that was obtained when the session was generated. The "finally" statement in the sample coding makes sure that the session will be discarded even if an error occurs while the API is running. After the session is discarded, the processing ends.

```
finally:
    # ----step10 Discard the session----#
    print("Discard the session")
    url = block_storage_api.discard_session(session_id)
    r = requests.delete(url, headers=headers, verify=False)
    try:
        if r.status_code != http.client.OK:
            raise requests.HTTPError(r)
    except requests.HTTPError as he:
        sys.stderr.write("HTTP Error! status code : ")
        sys.stderr.write(str(he.args[0].status_code) + "\n")
        sys.stderr.write(he.args[0].text + "\n")

    print("Operation was completed.")
    sys.exit()
```

Sample coding for ShadowImage pair operations

This section explains the sample coding for the ShadowImage pair operations.

Sample coding operation flow for ShadowImage pair operations

The following table shows the sample coding operation flow for ShadowImage pair operations and the corresponding code constructs.

| Step | Sample coding operation flow | Code constructs |
|------|---|--|
| 1 | Import necessary libraries and set parameters. | - |
| 2 | Define headers. | Specifying request headers (for the default HTTP headers) Specifying request headers (for the custom HTTP headers) |
| 3 | Define functions for issuing an HTTP request and for verifying the status of asynchronous processing. | Getting information about the job status by performing a GET operation Setting user authentication information (for authentication by using session-based authentication) Generating a request body in JSON format |

| Step | Sample coding operation flow | Code constructs |
|------|---|--|
| | | Getting the job execution results Getting the URLs of the resources to which the operation results have been applied Getting error codes |
| 4 | Check the version of the REST API. | Getting information about the version of the REST API by performing a GET operation |
| 5 | Generate a session. | Getting the URLs of the resources (when object IDs are not specified) Setting user authentication information (for authentication by using a user ID and a password) Creating objects by performing a POST operation |
| 6 | Create a ShadowImage pair. | Getting the URLs of the resources (when object IDs are not specified) Getting the URLs of the resources (when object IDs that are obtained from the operation results are specified) Generating a request body in JSON format Creating objects by performing a POST operation |
| 7 | Split a ShadowImage pair. | Getting the action template by performing a GET operation Setting user authentication information (for authentication by using session-based authentication) Generating a request body in JSON format Running actions that use the action template by using a POST operation |
| 8 | Get information about a ShadowImage pair. | Getting an object by performing a GET operation Setting user authentication information (for authentication by using session-based authentication) Outputting the obtained information |
| 9 | Output error messages. | Outputting error messages |
| 10 | Discard the session. | Getting the URLs of the resources (when object IDs that are obtained from the operation results are specified) |

| Step | Sample coding operation flow | Code constructs |
|------|------------------------------|---|
| | | Deleting objects by performing a DELETE operation |

Expected system configuration

This sample coding assumes the system configuration is as shown in the following figure.

Before execution

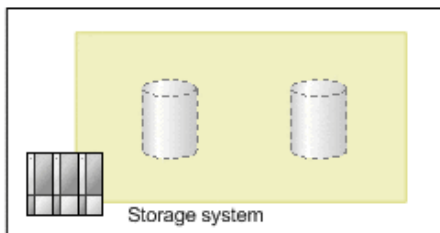

After the pair is created

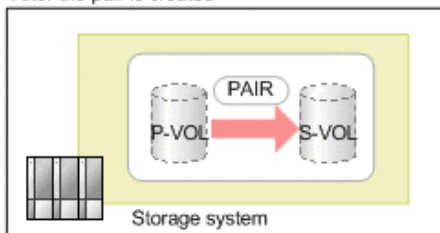

After the pair is split

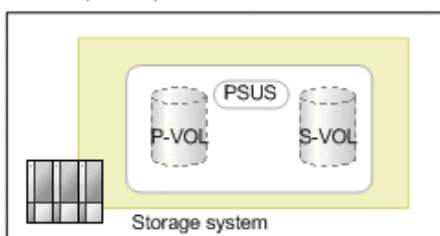

(Legend)



: Volume



: Copy group



: Pair status



: Data copy direction

The following table shows the values specified for the parameters in the sample coding. If necessary, change the settings to match the system environment and requirements.

| Parameter | Value | Description |
|-----------------|-----------------------|---|
| USER_CREDENTIAL | ("user1", "pass1") | This is the authentication information to be used for authentication in the storage system. The coding sample shows a setting example when the user ID is <code>user1</code> , and the password is <code>pass1</code> . The user needs the Storage Administrator (Provisioning) role and the Storage Administrator (Local Copy) role. |
| COPY_GROUP_NAME | SI_347 | The copy group name to be used for creating a ShadowImage pair. In the sample coding, a new copy group is created when creating a pair. |
| COPY_PAIR_NAME | p_347-348 | The copy pair name of the ShadowImage pair to be created |
| PVOL_LDEV_ID | 347 | The LDEV number of the already created volume to be used as the primary volume |
| SVOL_LDEV_ID | 348 | The LDEV number of the already created volume to be used as the secondary volume |
| FIRST_WAIT_TIME | 1 | The first interval for collecting the execution result of asynchronous processing. Normally, you do not need to change this value. |
| MAX_RETRY_COUNT | 10 | The maximum number of retries for collecting the execution result of asynchronous processing. Normally, you do not need to change this value. |

Contents of the sample coding

This subsection explains the sample coding.

1. Import necessary libraries and set parameters.

Before performing operations for the ShadowImage pair, the sample coding imports the required libraries or classes. In addition to the common libraries, the sample coding also imports the BlockStorageAPI class that defines the function that generates URLs.

```
# coding:utf-8

"""
local_copy

This program requires API version 1.9.0 or newer.
"""

import traceback
import requests
import json
import sys
import http.client
import time
import rest_server_param
import storage_param

from block_storage_api import BlockStorageAPI
```

Set parameters to be used in the sample coding.

```
# #####Initialize parameters##### #
# Change the following parameters to fit your environment

# A copy group name
COPY_GROUP_NAME = "SI_347"

# A copy pair name
COPY_PAIR_NAME = "p_347-348"

# A primary volume ID
# Specify already created and allocated volume ID by decimal
PVOL_LDEV_ID = 347

# A secondary volume ID which has the exactly same size
# as the primary volume
# Specify already created and allocated volume ID by decimal
SVOL_LDEV_ID = 348

# This parameter defines the first interval to access
# an asynchronous job. (Unit: Second)
FIRST_WAIT_TIME = 1

# This parameter defines the maximum retry time
# to confirm job status.
MAX_RETRY_COUNT = 10

# An user id and password of the target storage
USER_CREDENTIAL = ("user1", "pass1")

#####
```

2. Define headers.

Define the HTTP request header. Because the REST API only supports JSON format data, the sample coding defines header information so that data is handled in JSON format. In addition, for asynchronous processing, the sample coding specifies the settings of the Response-Job-Status header so that responses are returned after waiting for the completion of the jobs.

```
# ###You don't have to change the following parameters### #
block_storage_api = BlockStorageAPI(
    rest_server_param.REST_SERVER_IP_ADDR,
    rest_server_param.REST_SERVER_PORT,
    storage_param.STORAGE_MODEL,
    storage_param.SERIAL_NUMBER)

headers = {"content-type": "application/json",
          "accept": "application/json",
          "Response-Job-Status": "Completed"}

REQUIRED_MAJOR_VERSION = 1
REQUIRED_MINOR_VERSION = 9

session_id = 0

#####
```

3. Define the function for issuing an HTTP request and for verifying the status of asynchronous processing (the `invoke_async_command` function).

Define the function that issues an HTTP request and verifies the status of asynchronous processing. Call and use this function from the main ShadowImage pair operation. For details on this function, see the section explaining the of functions used in the sample coding.



Tip: To prevent errors that occur when the server certificate used for SSL communication between the REST API client and the storage system is a self-signed certificate, the sample coding specifies `verify=False` in the request message to skip verification of the server certificate.

```

"""
Check whether the asynchronous command was finished.
@param job_id The job ID to identify
               the asynchronous command
@return r.json() The JSON data that contains response data
"""

def check_update(job_id):
    url = block_storage_api.job(str(job_id))
    r = requests.get(url, headers=headers, verify=False)
    return r

"""
Execute the HTTP request (POST or PATCH)
@param method_type HTTP request method (POST or PATCH)
@param url URL to execute HTTP method
@param body The information of a resource
@return job_result.json()["affectedResources"][0]
        URL of an affected resource
"""

def invoke_async_command(method_type, url, body):
    if method_type == "patch":
        r = requests.patch(url, headers=headers,
                          data=json.dumps(body), verify=False)
    elif method_type == "post":
        r = requests.post(
            url,
            headers=headers,
            data=json.dumps(body),
            verify=False)
    if r.status_code != http.client.ACCEPTED:
        raise requests.HTTPError(r)
    print("Request was accepted. JOB URL : " +
          r.json()["self"])
    status = "Initializing"

```

```

job_result = None
retry_count = 1
wait_time = FIRST_WAIT_TIME
while status != "Completed":
    if retry_count > MAX_RETRY_COUNT:
        raise Exception("Timeout Error! "
                        "Operation was not completed.")
    time.sleep(wait_time)
    job_result = check_update(r.json()["jobId"])
    status = job_result.json()["status"]
    double_time = wait_time * 2
    if double_time < 120:
        wait_time = double_time
    else:
        wait_time = 120
    retry_count += 1
if job_result.json()["state"] == "Failed":
    error_obj = job_result.json()["error"]
    if "errorCode" in error_obj:
        if "SSB1" in error_obj["errorCode"]:
            print("Error! SSB code : ",
                  error_obj["errorCode"]["SSB1"],
                  ", ", error_obj["errorCode"]["SSB2"])
        elif "errorCode" in error_obj["errorCode"]:
            print("Error! error code : ",
                  error_obj["errorCode"]["errorCode"])
        raise Exception("Job Error!", job_result.text)
print("Async job was succeeded. affected resource : " +
      job_result.json()["affectedResources"][0])
return job_result.json()["affectedResources"][0]

```

4. Check the version of the REST API.

Get information about the version of the REST API to make sure that the version is supported.

```

"""
Check whether this API version allows the REST
Server to execute this program

@param api_version api version of this REST Server
@param required_major_version the lowest number of
    the major version that this program requires
@param required_minor_version the lowest number of
    the minor version that this program requires

"""

def check_api_version(api_version, required_major_version,
                     required_minor_version):
    version = api_version.split(".")
    major_version = int(version[0])
    minor_version = int(version[1])
    if not ((major_version == required_major_version and
             minor_version >= required_minor_version) or
            major_version >= required_major_version + 1):
        sys.exit(
            "This program requires API Version " +
            str(required_major_version) +
            "." +
            str(required_minor_version) +
            "." +
            "x or newer.\n")

try:
    # step1 Check the API version #
    print("Check the API version")
    url = block_storage_api.api_version()
    r = requests.get(url, headers=headers, verify=False)
    if r.status_code != http.client.OK:
        raise requests.HTTPError(r)
    check_api_version(
        r.json()["apiVersion"],
        REQUIRED_MAJOR_VERSION,
        REQUIRED_MINOR_VERSION)

```

5. Generate a session.

Generate sessions by using the REST API server.

```
# step2 Generate a session #
print("Generate a session")
url = block_storage_api.generate_session()
r = requests.post(url, headers=headers,
                  auth=USER_CREDENTIAL, verify=False)
if r.status_code != http.client.OK:
    raise requests.HTTPError(r)
token = r.json()["token"]
auth = "Session " + token
session_id = r.json()["sessionId"]
```

When a session is generated, a session ID and a token are returned. When running the API, specify the token for the Authentication header as the required authentication information for the subsequent operations. Use the session ID to discard the session after a set of operations is completed.

6. Create a ShadowImage pair.

Use the already created volumes to create a ShadowImage pair. Also create a new copy group. Specify the copy group name, copy pair name, and the LDEV number of the volume to be used that are defined in advance in the parameters. In addition, specify the copy pair type, MU number, and whether to create a copy group, and then issue a request to create a ShadowImage pair. The `block_storage_api` function is used to generate the URL.

```
# step3 Create a local copy pair #
print("Create a local copy pair")
url = block_storage_api.local_copy_pairs()
body = {
    "copyGroupName": COPY_GROUP_NAME,
    "copyPairName": COPY_PAIR_NAME,
    "replicationType": "SI",
    "pvolLdevId": PVOL_LDEV_ID,
    "pvolMuNumber": 0,
    "svolLdevId": SVOL_LDEV_ID,
    "isNewGroupCreation": True,
}
headers["Authorization"] = auth
affected_resource = invoke_async_command("post",
                                        url, body)
pair_url = block_storage_api.affected_resource(
    affected_resource)
```

The `invoke_async_command` function issues the request to create a ShadowImage pair under the specified conditions, checks the execution status of the jobs that were run asynchronously, and then returns the URL of the created pair as the execution result.

7. Split the ShadowImage pair.

In the sample coding, a ShadowImage pair is split by using the action template. First, get the action template for splitting a ShadowImage pair by using the URL of the pair that was obtained when the ShadowImage pair was created.

```
# step4 Split the local copy pair #
print("Split the local copy pair")
url = block_storage_api.split_local_copy_pair_template(
    pair_url)
r = requests.get(url, headers=headers, verify=False)
if r.status_code != http.client.OK:
    raise requests.HTTPError(r)
print("Action template(split):")
print(r.text)
```

Set values in the obtained template, and then issue a request to split the created ShadowImage pair.

```
body = r.json()
body["parameters"]["copyPace"] = 3
split_url = block_storage_api.split_local_copy_pair(
    pair_url)
invoke_async_command("post", split_url, body)
```

8. Get information about the ShadowImage pair.

Get information about the pair by using the URL of the pair that was obtained when the ShadowImage pair was created. In the sample coding, the following items are output: the copy group name, copy pair name, LDEV number and pair volume status for the P-VOL, and the LDEV number and pair volume status for the S-VOL.

```
# step5 Print the pair status #
print("Print the pair status")
r = requests.get(pair_url,
                 headers=headers, verify=False)
if r.status_code != http.client.OK:
    raise requests.HTTPError(r)

print("COPY GROUP NAME : " + r.json()["copyGroupName"])
print("COPY PAIR NAME : " + r.json()["copyPairName"])
print("P-VOL LDEV ID : " + str(r.json()["pvolldevId"]))
print("S-VOL LDEV ID : " + str(r.json()["svolldevId"]))
print("P-VOL STATUS : " + r.json()["pvolStatus"])
print("S-VOL STATUS : " + r.json()["svolStatus"])
print("LOCAL CLONE COPY PAIR ID : " +
      r.json()["localCloneCopypairId"])
print()
```

9. Output error messages.

In the sample coding, processing for communication errors, HTTP request errors, and job execution errors is described. If a communication error occurs, an error message is output. If an HTTP request error occurs, the error code, the error message, and the response body are output. If a job execution error occurs, all of the contents included in the job execution result are output.

```
except requests.ConnectionError:
    sys.stderr.write("Connection Error!\n")
    sys.stderr.write(traceback.format_exc())
except requests.HTTPError as he:
    sys.stderr.write("HTTP Error! status code : ")
    sys.stderr.write(str(he.args[0].status_code) + "\n")
    sys.stderr.write(he.args[0].text + "\n")
except Exception as e:
    sys.stderr.write(traceback.format_exc())
    for msg in e.args:
        sys.stderr.write(str(msg) + "\n")
```

10. Discard the session.

After a set of operations is completed, discard the session. Specify the session ID that was obtained when the session was generated. The "finally" statement in the sample coding makes sure that the session will be discarded even if an error occurs while the API is running. After the session is discarded, the processing ends.

```
finally:
    # step6 Discard the session #
    print("Discard the session")
    url = block_storage_api.discard_session(session_id)
    r = requests.delete(url, headers=headers, verify=False)
    try:
        if r.status_code != http.client.OK:
            raise requests.HTTPError(r)
    except requests.HTTPError as he:
        sys.stderr.write("HTTP Error! status code : ")
        sys.stderr.write(str(he.args[0].status_code) + "\n")
        sys.stderr.write(he.args[0].text + "\n")

    print("Operation was completed.")
    sys.exit()
```

Sample coding for registering remote storage system information

This section explains the sample coding for registering remote storage system information.

Sample coding operation flow for registering remote storage system information

The following table shows the sample coding operation flow for registering remote storage system information and the corresponding code constructs.

| Step | Sample coding operation flow | Code constructs |
|------|---|--|
| 1 | Import necessary libraries and set parameters. | - |
| 2 | Define headers. | Specifying request headers (for the default HTTP headers) |
| 3 | Define functions for issuing an HTTP request and for verifying the status of asynchronous processing. | Getting information about the job status by performing a GET operation Setting user authentication information (for authentication by using session-based authentication) Generating a request body in JSON format Getting the job execution results Getting the URLs of the resources to which the operation results have been applied Getting error codes |
| 4 | Check the version of the REST API. | Getting information about the version of the REST API by performing a GET operation |
| 5 | Generate a session. | Getting the URLs of the resources (when object IDs are not specified) Setting user authentication information (for authentication by using a user ID and a password) Creating objects by performing a POST operation |
| 6 | Register information about storage systems. | Getting the URLs of the resources (when object IDs are not specified) Generating a request body in JSON format Operations that require sessions to be generated on multiple devices (remote copy operation) Creating objects by performing a POST operation |
| 7 | Get information about storage systems. | Getting the URLs of the resources (when object IDs that are obtained from the operation results are specified) Setting user authentication information (for authentication by using session-based authentication) |

| Step | Sample coding operation flow | Code constructs |
|------|------------------------------|---|
| | | Getting an object by performing a GET operation Outputting the obtained information |
| 8 | Output error messages. | Outputting error messages |
| 9 | Discard the session. | Getting the URLs of the resources (when object IDs that are obtained from the operation results are specified) Deleting objects by performing a DELETE operation |

Expected system configuration

This sample coding assumes the system configuration is as shown in the following figure.

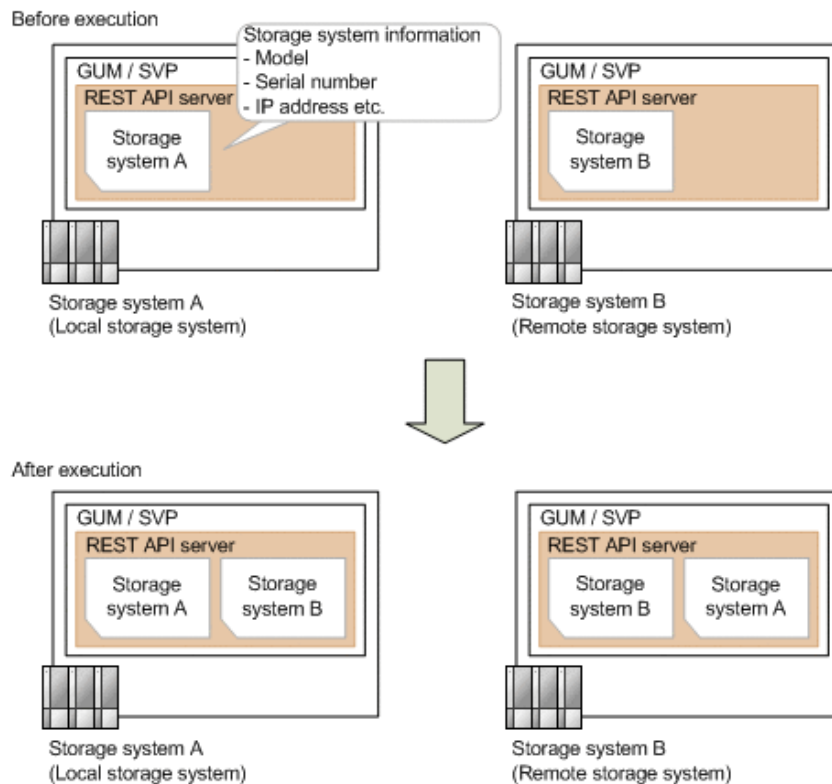

The following table shows the values specified for the parameters in the sample coding. If necessary, change the settings to match the system environment and requirements.

| Parameter | Value | Description |
|------------------------|---|---|
| LOCAL_USER_CREDENTIAL | (<code>"local_user", "local_pass"</code>) | This is the authentication information to be used for authentication in the local storage system. The coding sample shows a setting example when the user ID is <code>local_user</code> , and the password is <code>local_pass</code> . The user needs the Storage Administrator (Initial Configuration) role. |
| REMOTE_USER_CREDENTIAL | (<code>"remote_user", "remote_pass"</code>) | This is the authentication information to be used for authentication in the remote storage system. The coding sample shows a setting example when the user ID is <code>remote_user</code> , and the password is <code>remote_pass</code> . The user needs the Storage Administrator (Initial Configuration) role. |
| FIRST_WAIT_TIME | 1 | The first interval for collecting the execution result of asynchronous processing. Normally, you do not need to change this value. |
| MAX_RETRY_COUNT | 10 | The maximum number of retries for collecting the execution result of asynchronous processing. Normally, you do not need to change this value. |

The following table shows the parameters and values defined in the `remote_copy_param.py` file, which can be used in coding samples as common variables for the information about the local and the remote storage systems. If necessary, change the settings to match the system environment and requirements.

| Parameter | Value | Description |
|----------------------------|-------------|---|
| LOCAL_REST_SERVER_IP_ADDR | 192.0.2.100 | The IP address of the REST API server of the local storage system |
| LOCAL_PORT | 443 | The SSL communication port for the REST API server of the local storage system |
| LOCAL_STORAGE_MODEL | VSP G900 | The model name of the local storage system |
| LOCAL_SERIAL_NUMBER | 410000 | The serial number of the local storage system |
| REMOTE_REST_SERVER_IP_ADDR | 192.0.2.200 | The IP address of the REST API server of the remote storage system |
| REMOTE_PORT | 443 | The SSL communication port for the REST API server of the remote storage system |

| Parameter | Value | Description |
|----------------------|----------|--|
| REMOTE_STORAGE_MODEL | VSP G900 | The model name of the remote storage system |
| REMOTE_SERIAL_NUMBER | 420000 | The serial number of the remote storage system |

Contents of the sample coding

This subsection explains the sample coding.

1. Import necessary libraries and set parameters.

Before starting the registration processing of remote storage system information, the sample coding imports the required libraries or classes. In addition to the common libraries, the sample coding also imports the BlockStorageAPI class that defines the function that generates URLs.

```
# coding:utf-8

"""
register_remote_storage

This program requires API version 1.9.0 or newer.
"""

import traceback
import requests
import json
import sys
import http.client
import time
import remote_copy_param

from block_storage_api import BlockStorageAPI
```

Set parameters to be used in the sample coding.

```
# #####Initialize parameters##### #
# Change the following parameters to fit your environment

# This parameter defines the first interval to access
# an asynchronous job. (Unit: Second)
FIRST_WAIT_TIME = 1

# This parameter defines the maximum retry time
# to confirm job status.
MAX_RETRY_COUNT = 10

# An user id and password of the local storage
LOCAL_USER_CREDENTIAL = ("local_user", "local_pass")

# An user id and password of the remote storage
REMOTE_USER_CREDENTIAL = ("remote_user", "remote_pass")

#####
```

2. Define headers.

Define the HTTP request header. Because the REST API only supports JSON format data, the sample coding defines header information so that data is handled in JSON format.

```
# ###You don't have to change the following parameters### #
local_storage_api = BlockStorageAPI(
    remote_copy_param.LOCAL_REST_SERVER_IP_ADDR,
    remote_copy_param.LOCAL_PORT,
    remote_copy_param.LOCAL_STORAGE_MODEL,
    remote_copy_param.LOCAL_SERIAL_NUMBER)

remote_storage_api = BlockStorageAPI(
    remote_copy_param.REMOTE_REST_SERVER_IP_ADDR,
    remote_copy_param.REMOTE_PORT,
    remote_copy_param.REMOTE_STORAGE_MODEL,
    remote_copy_param.REMOTE_SERIAL_NUMBER)

local_headers = {"content-type": "application/json",
                 "accept": "application/json",
                 "Response-Job-Status": "Completed"}

remote_headers = {"content-type": "application/json",
                  "accept": "application/json",
                  "Response-Job-Status": "Completed"}

REQUIRED_MAJOR_VERSION = 1
REQUIRED_MINOR_VERSION = 9

local_session_id = 0
remote_session_id = 0

#####
```

3. Define the function for issuing an HTTP request and for verifying the status of asynchronous processing (the `invoke_async_command` function).

Define the function that issues an HTTP request and verifies the status of asynchronous processing. Call and use this function from the main registration operation of the remote storage system information. For details on this function, see the section explaining the functions used in the sample coding.



Tip: To prevent errors that occur when the server certificate used for SSL communication between the REST API client and the storage system is a self-signed certificate, the sample coding specifies `verify=False` in the request message to skip verification of the server certificate.

```
"""
Check whether the asynchronous command was finished.

@param storage_api storage_api
@param job_id the job ID to identify
```

```

the asynchronous command
@param headers the array of the http headers
@return r the response data
"""

def check_update(storage_api, job_id, headers):
    url = storage_api.job(str(job_id))
    r = requests.get(url, headers=headers, verify=False)
    return r

"""
Execute the HTTP request (POST or PATCH)

@param storage_api storage_api
@param method_type HTTP request method (POST or PATCH)
@param headers the array of the http headers
@param url URL to execute HTTP method
@param body The information of a resource
@return job_result.json()["affectedResources"][0]
        URL of an affected resource
"""

def invoke_async_command(storage_api, method_type, headers,
                        url, body):
    if method_type == "patch":
        r = requests.patch(url, headers=headers,
                          data=json.dumps(body), verify=False)
    elif method_type == "post":
        r = requests.post(
            url,
            headers=headers,
            data=json.dumps(body),
            verify=False)
    if r.status_code != http.client.ACCEPTED:
        raise requests.HTTPError(r)
    print("Request was accepted. JOB URL : " +
          r.json()["self"])
    status = "Initializing"
    job_result = None
    retry_count = 1
    wait_time = FIRST_WAIT_TIME
    while status != "Completed":
        if retry_count > MAX_RETRY_COUNT:
            raise Exception("Timeout Error! "
                            "Operation was not completed.")
        time.sleep(wait_time)
        job_result = check_update(storage_api,
                                 r.json()["jobId"], headers)
        status = job_result.json()["status"]

```

```
double_time = wait_time * 2
if double_time < 120:
    wait_time = double_time
else:
    wait_time = 120
retry_count += 1
if job_result.json()["state"] == "Failed":
    error_obj = job_result.json()["error"]
    if "errorCode" in error_obj:
        if "SSB1" in error_obj["errorCode"]:
            print("Error! SSB code : ",
                  error_obj["errorCode"]["SSB1"],
                  ", ", error_obj["errorCode"]["SSB2"])
        elif "errorCode" in error_obj["errorCode"]:
            print("Error! error code : ",
                  error_obj["errorCode"]["errorCode"])
        raise Exception("Job Error!", job_result.text)
    print("Async job was succeeded. affected resource : " +
          job_result.json()["affectedResources"][0])
    return job_result.json()["affectedResources"][0]
```

4. Check the version of the REST API.

Get information about the version of the REST API for both the local and the remote storage systems by using the REST API server of each system to make sure that the version is supported.

```

"""
Check whether this API version allows the REST
Server to execute this program

@param api_version api_version of this REST Server
@param required_major_version the lowest number of
the major version that this program requires
@param required_minor_version the lowest number of
the minor version that this program requires

"""

def check_api_version(api_version, required_major_version,
                     required_minor_version):
    version = api_version.split(".")
    major_version = int(version[0])
    minor_version = int(version[1])
    if not ((major_version == required_major_version and
             minor_version >= required_minor_version) or
            major_version >= required_major_version + 1):
        sys.exit("This program requires API Version " +
                 str(required_major_version) + "." +
                 str(required_minor_version) +
                 "." + "x or newer.\n")

try:
    # step1 Check the API version of the local REST API #
    print("Check the API version of the local REST API")
    url = local_storage_api.api_version()
    r = requests.get(url, headers=local_headers,
                     verify=False)
    if r.status_code != http.client.OK:
        raise requests.HTTPError(r)
    check_api_version(r.json()["apiVersion"],
                     REQUIRED_MAJOR_VERSION,
                     REQUIRED_MINOR_VERSION)

    # step1 Check the API version of the remote REST API #
    print("Check the API version of the remote REST API")
    url = remote_storage_api.api_version()
    r = requests.get(url, headers=remote_headers,
                     verify=False)
    if r.status_code != http.client.OK:
        raise requests.HTTPError(r)
    check_api_version(r.json()["apiVersion"],
                     REQUIRED_MAJOR_VERSION,

```

```
REQUIRED_MINOR_VERSION)
```

5. Generate a session.

Generate a session in both the local and the remote storage systems by using the REST API server of each system.

```
# step2 Generate a local session #
print("Generate a local session")
url = local_storage_api.generate_session()
r = requests.post(
    url,
    headers=local_headers,
    auth=LOCAL_USER_CREDENTIAL,
    verify=False)
if r.status_code != http.client.OK:
    raise requests.HTTPError(r)
local_token = r.json()["token"]
local_auth = "Session " + local_token
local_session_id = r.json()["sessionId"]

# step2 Generate a remote session #
print("Generate a remote session")
url = remote_storage_api.generate_session()
r = requests.post(url, headers=remote_headers,
    auth=REMOTE_USER_CREDENTIAL,
    verify=False)
if r.status_code != http.client.OK:
    raise requests.HTTPError(r)
remote_token = r.json()["token"]
remote_auth = "Session " + remote_token
remote_session_id = r.json()["sessionId"]
remote_headers["Authorization"] = remote_auth
```

When a session is generated, a session ID and a token are returned. When running the API, specify the token for the Authentication header as the required authentication information for the subsequent operations. Use the session ID to discard the session after a set of operations is completed.

6. Register information about the remote storage system

Register information about the remote storage system on the REST API server of the local storage system. For the request body, specify information about the remote storage system.

```
# step3 Register a remote storage device #
print("Register a remote storage device")
url = local_storage_api.remote_storage()
body = {
    "storageDeviceId": remote_storage_api.
        get_storage_id(),
    "restServerIp":
        remote_copy_param.REMOTE_REST_SERVER_IP_ADDR,
    "restServerPort": remote_copy_param.REMOTE_PORT
}
local_headers["Authorization"] = local_auth
local_headers["Remote-Authorization"] = remote_auth
affected_resource_path = invoke_async_command(
    local_storage_api, "post",
    local_headers, url, body)
```

The `invoke_async_command` function issues a request for registering information about the remote storage system, verifies the execution status of the jobs that were run asynchronously, and then returns the URL of the registered storage system as the execution result.

7. Get information about the registered remote storage system.

To confirm that information about the remote storage system is correctly registered, get the registered storage information by using the REST API server of the local storage system.

```
# step4 Print the remote storage device #
print("Print the remote storage device")
url = local_storage_api.affected_resource(
    affected_resource_path)
r = requests.get(url, headers=local_headers,
    verify=False)
if r.status_code != http.client.OK:
    raise requests.HTTPError(r)
print("STORAGE DEVICE ID : " +
    str(r.json()["storageDeviceId"]))
print("DKC TYPE : " + str(r.json()["dkcType"]))
print("REST SERVER IP : " + str(r.json()["restServerIp"]))
print("REST SERVER PORT : " +
    str(r.json()["restServerPort"]))
print("MODEL : " + str(r.json()["model"]))
print("SERIAL NUMBER : " +
    str(r.json()["serialNumber"]))
```

In the sample coding, the following items are obtained and output: storage device ID, storage system type, IP address of the REST API server for the remote storage system, port number of the REST API server for the remote storage system, model name, and serial number.

8. Output error messages.

In the sample coding, processing for communication errors, HTTP request errors, and job execution errors is described. If a communication error occurs, an error message is output. If an HTTP request error occurs, the error code, the error message, and the response body are output. If a job execution error occurs, all of the contents included in the job execution result are output.

```
except requests.ConnectionError:
    sys.stderr.write("Connection Error!\n")
    sys.stderr.write(traceback.format_exc())
except requests.HTTPError as he:
    sys.stderr.write("HTTP Error! status code : ")
    sys.stderr.write(str(he.args[0].status_code) + "\n")
    sys.stderr.write(he.args[0].text + "\n")
except Exception as e:
    sys.stderr.write(traceback.format_exc())
    for msg in e.args:
        sys.stderr.write(str(msg) + "\n")
```

9. Discard the session.

After a set of operations is completed, discard the session by using the REST API server of both the local and the remote storage systems. Specify the session ID that was obtained when the session was created. The "finally" statement in the sample coding makes sure that the session will be discarded even if an error occurs while the API is running. After the session is discarded, the processing ends.

```
finally:
    # step5 Discard the local session #
    print("Discard the local session")
    url = local_storage_api.discard_session(
        local_session_id)
    r = requests.delete(url, headers=local_headers,
                        verify=False)
    if r.status_code != http.client.OK:
        raise requests.HTTPError(r)

    # step5 Discard the remote session #
    print("Discard the remote session")
    url = remote_storage_api.discard_session(
        remote_session_id)
    r = requests.delete(url, headers=remote_headers,
                        verify=False)
    if r.status_code != http.client.OK:
        raise requests.HTTPError(r)

    print("Operation was completed.")
    sys.exit()
```

Sample coding for TrueCopy pair operations

This section explains the sample coding for the TrueCopy pair operations.

Sample coding operation flow for TrueCopy pair operations

The following table shows the sample coding operation flow for TrueCopy pair operations and the corresponding code constructs.

| Step | Sample coding operation flow | Code constructs |
|------|---|--|
| 1 | Import necessary libraries and set parameters. | - |
| 2 | Define headers. | Specifying request headers (for the default HTTP headers) |
| 3 | Define the function for getting status changes for asynchronous processing. | Getting information about the job status by performing a GET operation |

| Step | Sample coding operation flow | Code constructs |
|------|------------------------------------|--|
| | | Setting user authentication information (for authentication by using session-based authentication) Getting the job execution results Getting error codes |
| 4 | Check the version of the REST API. | Getting information about the version of the REST API by performing a GET operation |
| 5 | Generate a session. | Getting the URLs of the resources (when object IDs are not specified) Setting user authentication information (for authentication by using a user ID and a password) Creating objects by performing a POST operation |
| 6 | Lock resources. | Getting the URLs of the resources (when object IDs are not specified) Setting user authentication information (for authentication by using session-based authentication) Running actions for services by performing a POST operation |
| 7 | Create a TrueCopy pair. | Getting the URLs of the resources (when object IDs are not specified) Getting the URLs of the resources (when object IDs that are obtained from the operation results are specified) Setting user authentication information (for authentication by using session-based authentication) Generating a request body in JSON format Operations that require sessions to be generated on multiple devices (remote copy operation) Creating objects by performing a POST operation |
| 8 | Unlock resources. | Getting the URLs of the resources (when object IDs are not specified) Setting user authentication information (for authentication by using session-based authentication) |

| Step | Sample coding operation flow | Code constructs |
|------|---|---|
| | | Running actions for services by performing a POST operation |
| 9 | Confirm that the pair has been created. | - |
| 10 | Get information about a TrueCopy pair. | Getting an object by performing a GET operation Setting user authentication information (for authentication by using session-based authentication) Getting the URLs of the resources to which the operation results have been applied Getting error codes |
| 11 | Output error messages. | Outputting error messages |
| 12 | Discard the session. | Getting the URLs of the resources (when object IDs that are obtained from the operation results are specified) Setting user authentication information (for authentication by using session-based authentication) Deleting objects by performing a DELETE operation |

Expected system configuration

This sample coding assumes the system configuration is as shown in the following figure.

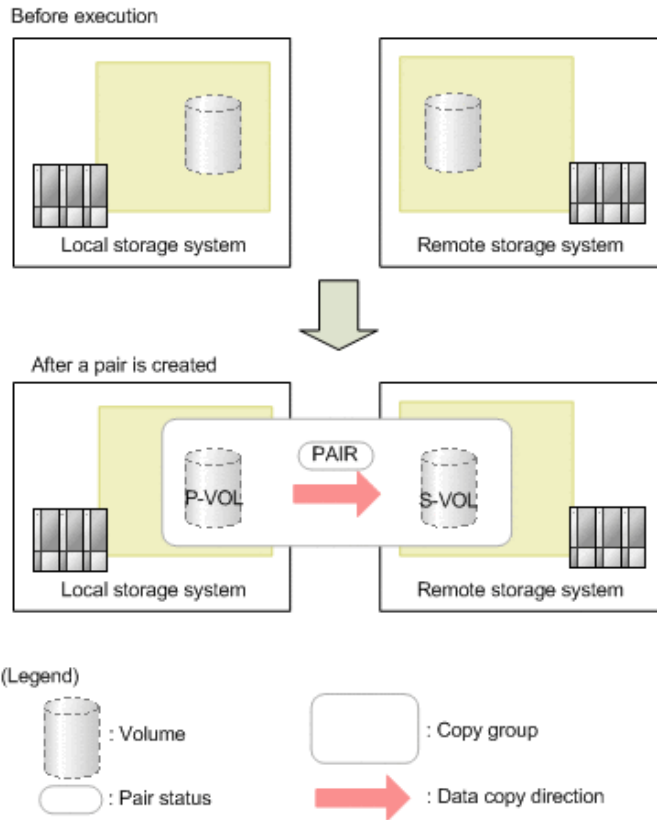

The following table shows the values specified for the parameters in the sample coding. If necessary, change the settings to match the system environment and requirements.

| Parameter | Value | Description |
|------------------------|--|---|
| LOCAL_USER_CREDENTIAL | ("local_copy_user", "local_copy_pass") | This is the authentication information to be used for authentication in the local storage system. The coding sample shows a setting example when the user ID is <code>local_copy_user</code> , and the password is <code>local_copy_pass</code> . The user needs the Storage Administrator (Provisioning) role and the Storage Administrator (Remote Copy) role. |
| REMOTE_USER_CREDENTIAL | ("remote_copy_user", "remote_copy_pass") | This is the authentication information to be used for authentication in the remote storage system. The coding sample shows a setting example when the user ID is <code>remote_copy_user</code> , and the password is <code>remote_copy_pass</code> . The user needs the Storage Administrator (Provisioning) role and the Storage Administrator (Remote Copy) role. |
| COPY_GROUP_NAME | "TC_GROUP" | The copy group name for a TrueCopy pair to be created |

| Parameter | Value | Description |
|-----------------|-------------|---|
| COPY_PAIR_NAME | "p_347-348" | The copy pair name for a TrueCopy pair to be created |
| PVOL_LDEV_ID | 347 | The number of the already created LDEV to be used for the primary volume |
| SVOL_LDEV_ID | 348 | The number of the already created LDEV to be used for the secondary volume |
| FIRST_WAIT_TIME | 1 | The first interval for collecting the execution result of asynchronous processing. Normally, you do not need to change this value. |
| MAX_RETRY_COUNT | 10 | The maximum number of retries for collecting the execution result of asynchronous processing. Normally, you do not need to change this value. |

The following table shows the parameters and values defined in the `remote_copy_param.py` file, which can be used in coding samples as common variables for the information about the local and the remote storage systems. If necessary, change the settings to match the system environment and requirements.

| Parameter | Value | Description |
|----------------------------|-------------|---|
| LOCAL_REST_SERVER_IP_ADDR | 192.0.2.100 | The IP address of the REST API server of the local storage system |
| LOCAL_PORT | 443 | The SSL communication port for the REST API server of the local storage system |
| LOCAL_STORAGE_MODEL | VSP G900 | The model name of the local storage system |
| LOCAL_SERIAL_NUMBER | 410000 | The serial number of the local storage system |
| REMOTE_REST_SERVER_IP_ADDR | 192.0.2.200 | The IP address of the REST API server of the remote storage system |
| REMOTE_PORT | 443 | The SSL communication port for the REST API server of the remote storage system |
| REMOTE_STORAGE_MODEL | VSP G900 | The model name of the remote storage system |
| REMOTE_SERIAL_NUMBER | 420000 | The serial number of the remote storage system |

Contents of the sample coding

This subsection explains the sample coding.

1. Import necessary libraries and set parameters.

Before starting operations for the TrueCopy pair, the sample coding imports the required libraries or classes. In addition to the common libraries, the sample coding also imports the `BlockStorageAPI` class that defines the function that generates URLs.

```
# coding:utf-8

"""
synchronous_remote_copy

This program requires API version 1.9.0 or newer.
"""

import traceback
import requests
import json
import sys
import http.client
import time
import remote_copy_param

from block_storage_api import BlockStorageAPI
```

Set parameters to be used in the sample coding.

```
# #####Initialize parameters##### #
# Change the following parameters to fit your environment

# A copy group name
COPY_GROUP_NAME = "TC_GROUP"

# A copy pair name
COPY_PAIR_NAME = "p_347-348"

# A primary volume ID
# Specify already created and allocated volume ID by decimal
PVOL_LDEV_ID = 347

# A secondary volume ID which has the exactly same size
# as the primary volume
# Specify already created and allocated volume ID by decimal
SVOL_LDEV_ID = 348

# This parameter defines the first interval to access
# an asynchronous job. (Unit: Second)
FIRST_WAIT_TIME = 1

# This parameter defines the maximum retry time
# to confirm job status.
MAX_RETRY_COUNT = 10

# An user id and password of the local storage
LOCAL_USER_CREDENTIAL = ("local_copy_user",
                          "local_copy_pass")

# An user id and password of the remote storage
REMOTE_USER_CREDENTIAL = ("remote_copy_user",
                           "remote_copy_pass")

#####
```

2. Define headers.

Define the HTTP request header. Because the REST API only supports JSON format data, the sample coding defines header information so that data is handled in JSON format.

```
# ###You don't have to change the following parameters### #
local_storage_api = BlockStorageAPI(
    remote_copy_param.LOCAL_REST_SERVER_IP_ADDR,
    remote_copy_param.LOCAL_PORT,
    remote_copy_param.LOCAL_STORAGE_MODEL,
    remote_copy_param.LOCAL_SERIAL_NUMBER)

remote_storage_api = BlockStorageAPI(
    remote_copy_param.REMOTE_REST_SERVER_IP_ADDR,
    remote_copy_param.REMOTE_PORT,
    remote_copy_param.REMOTE_STORAGE_MODEL,
    remote_copy_param.REMOTE_SERIAL_NUMBER)

local_headers = {"content-type": "application/json",
                 "accept": "application/json",
                 "Response-Job-Status": "Completed"}

remote_headers = {"content-type": "application/json",
                  "accept": "application/json",
                  "Response-Job-Status": "Completed"}

REQUIRED_MAJOR_VERSION = 1
REQUIRED_MINOR_VERSION = 9

local_session_id = 0
remote_session_id = 0

#####
```

3. Define the function for getting status changes for asynchronous processing. (wait_until_jobstatus_is_changed function)

Define the function for getting status changes for asynchronous processing. Call and use this function from the main TrueCopy pair operation. For details on this function, see the description of functions used in the sample coding.



Tip: To prevent errors that occur when the server certificate used for SSL communication between the REST API client and the storage system is a self-signed certificate, the sample coding specifies `verify=False` in the request message to skip verification of the server certificate.

```

"""
Check whether the asynchronous command was finished.

@param storage_api storage_api
@param job_id the job ID to identify
           the asynchronous command
@param headers the array of the http headers
@return r the response data
"""

def check_update(storage_api, job_id, headers):
    url = storage_api.job(str(job_id))
    r = requests.get(url, headers=headers, verify=False)
    return r

```

```

"""
Wait until the job status is changed

@param storage_api storage_api
@param headers the array of the http headers
@param job_id the job ID to identify
           the asynchronous command
@param changed_status job status after waiting
@param is_retry_count_enabled if true, wait
           until MAX_RETRY_COUNT. if false, wait forever
           until job status is changed.
@return job_result.json()["affectedResources"][0]
           URL of an affected resource
"""

def wait_until_jobstatus_is_changed(
    storage_api,
    headers,
    job_id,
    changed_status,
    is_retry_count_enabled):
    status = "Initializing"
    retry_count = 1
    wait_time = FIRST_WAIT_TIME
    while status != changed_status:
        if status == "Completed":
            print("Status was already changed" +

```



```

        "to Completed.")
    break
    if is_retry_count_enabled and \
        retry_count > MAX_RETRY_COUNT:
        raise Exception("Timeout Error! "
            "Operation was not completed.")
    time.sleep(wait_time)
    job_result = check_update(storage_api,
                            job_id, headers)
    status = job_result.json()["status"]
    double_time = wait_time * 2
    if double_time < 120:
        wait_time = double_time
    else:
        wait_time = 120
    retry_count += 1
    if job_result.json()["state"] == "Failed":
        error_obj = job_result.json()["error"]
        if "errorCode" in error_obj:
            if "SSB1" in error_obj["errorCode"]:
                print("Error! SSB code : ",
                    error_obj["errorCode"]["SSB1"],
                    ", ", error_obj["errorCode"]["SSB2"])
            elif "errorCode" in error_obj["errorCode"]:
                print("Error! error code : ",
                    error_obj["errorCode"]["errorCode"])
            raise Exception("Job Error!", job_result.text)
    print("Async job was succeeded. affected resource : " +
        job_result.json()["affectedResources"][0])
    return job_result.json()["affectedResources"][0]

```

4. Check the version of the REST API.

Get information about the version of the REST API for both the local and the remote storage systems by using the REST API server of each system to make sure that the version is supported.

```

"""
Check whether this API version allows the REST
Server to execute this program

@param api_version api version of this REST Server
@param required_major_version the lowest number of
    the major version that this program requires
@param required_minor_version the lowest number of
    the minor version that this program requires

"""

def check_api_version(api_version, required_major_version,
                     required_minor_version):
    version = api_version.split(".")
    major_version = int(version[0])
    minor_version = int(version[1])
    if not ((major_version == required_major_version and
             minor_version >= required_minor_version) or
            major_version >= required_major_version + 1):
        sys.exit(
            "This program requires API Version " +
            str(required_major_version) +
            "." +
            str(required_minor_version) +
            "." +
            "x or newer.\n")

try:
    # step1 Check the API version of the local REST API #
    print("Check the API version of the local REST API")
    url = local_storage_api.api_version()
    r = requests.get(url, headers=local_headers,
                    verify=False)
    if r.status_code != http.client.OK:
        raise requests.HTTPError(r)
    check_api_version(r.json()["apiVersion"],
                    REQUIRED_MAJOR_VERSION,
                    REQUIRED_MINOR_VERSION)

    # step1 Check the API version of the remote REST API #
    print("Check the API version of the remote REST API")
    url = remote_storage_api.api_version()
    r = requests.get(url, headers=remote_headers,
                    verify=False)
    if r.status_code != http.client.OK:

```

```

        raise requests.HTTPError(r)
    check_api_version(r.json()["apiVersion"],
                     REQUIRED_MAJOR_VERSION,
                     REQUIRED_MINOR_VERSION)

```

5. Generate a session.

Generate a session in both the local and the remote storage systems by using the REST API server of each system.

```

# step2 Generate a local session #
print("Generate a local session")
url = local_storage_api.generate_session()
r = requests.post(
    url,
    headers=local_headers,
    auth=LOCAL_USER_CREDENTIAL,
    verify=False)
if r.status_code != http.client.OK:
    raise requests.HTTPError(r)
local_token = r.json()["token"]
local_auth = "Session " + local_token
local_session_id = r.json()["sessionId"]

# step2 Generate a remote session #
print("Generate a remote session")
url = remote_storage_api.generate_session()
r = requests.post(
    url,
    headers=remote_headers,
    auth=REMOTE_USER_CREDENTIAL,
    verify=False)
if r.status_code != http.client.OK:
    raise requests.HTTPError(r)
remote_token = r.json()["token"]
remote_auth = "Session " + remote_token
remote_session_id = r.json()["sessionId"]

```

When a session is generated, a session ID and a token are returned. When running the API, specify the token for the Authentication header as the required authentication information for the subsequent operations. Use the session ID to discard the session after a set of operations is completed.

6. Lock resources.

Obtain a lock to prevent other users from performing operations on the target volume. For the local storage system, lock the resource group to which the LDEV for the primary volume belongs. For the remote storage system, lock the resource group to which the LDEV for the secondary volume belongs.

```

try:
    # step3 Lock the local resource group #
    print("Lock the local resource group")
    url = local_storage_api.lock()
    local_headers["Authorization"] = local_auth
    r = requests.post(url, headers=local_headers,
                      verify=False)
    if r.status_code != http.client.ACCEPTED:
        raise requests.HTTPError(r)
    print("Request was accepted. JOB URL : " +
          r.json()["self"])
    wait_until_jobstatus_is_changed(
        local_storage_api,
        local_headers,
        r.json()["jobId"],
        "Completed",
        True)

    # step3 Lock the remote resource group #
    print("Lock the remote resource group")
    remote_headers["Authorization"] = remote_auth
    url = remote_storage_api.lock()
    r = requests.post(url, headers=remote_headers,
                      verify=False)
    if r.status_code != http.client.ACCEPTED:
        raise requests.HTTPError(r)
    print("Request was accepted. JOB URL : " +
          r.json()["self"])
    wait_until_jobstatus_is_changed(
        remote_storage_api,
        remote_headers,
        r.json()["jobId"],
        "Completed",
        True)

```

The `wait_until_jobstatus_is_changed` function checks the execution status of the jobs that were run asynchronously, and waits until the job status changes to the specified status. In the sample coding, the job execution status is confirmed to have changed to "Completed" and to have been locked.

7. Create a TrueCopy pair.

Use the already created LDEV to create a TrueCopy pair. Also create a new copy group. Specify the copy group name, copy pair name, and the LDEV number of the volume to be used, which are defined in advance in the parameters. In addition, specify items such as the copy pair type, whether to create a copy group, and the fence level, and then issue a request for creating a TrueCopy pair. The `block_storage_api` function is used to generate the URL.

```
# step4 Create a remote copy pair #
print("Create a remote copy pair")
url = local_storage_api.remote_copy_pairs()
body = {
    "copyGroupName": COPY_GROUP_NAME,
    "copyPairName": COPY_PAIR_NAME,
    "replicationType": "TC",
    "remoteStorageDeviceId": remote_storage_api.
    get_storage_id(),
    "pvolldevId": PVOL_LDEV_ID,
    "svolldevId": SVOL_LDEV_ID,
    "isNewGroupCreation": "true",
    "fenceLevel": "data",
}
local_headers["Remote-Authorization"] = remote_auth
r = requests.post(
    url,
    headers=local_headers,
    data=json.dumps(body),
    verify=False)
if r.status_code != http.client.ACCEPTED:
    raise requests.HTTPError(r)
print("Create remote copy pair request " +
      "was accepted. JOB URL : " + r.json()["self"])
wait_until_jobstatus_is_changed(
    local_storage_api,
    local_headers,
    r.json()["jobId"],
    "StorageAccepted",
    False)
jobid = r.json()["jobId"]

print("Status changed to StorageAccepted")
```

The `wait_until_jobstatus_is_changed` function checks the execution status of the jobs that were run asynchronously, and waits until the job status changes to the specified status. In the sample coding, it is confirmed that the job execution status has changed to "StorageAccepted" and the request for creating a TrueCopy pair has been received by the storage system.

8. Unlock resources.

After having confirmed that the storage system received processing for creating the pair, cancel the obtained lock. The "finally" statement in the sample coding makes sure that the lock will be canceled even if an error occurs while the API is running.

```
finally:
    # step5 Unlock the local resource group #
    print("Unlock the local resource group")
    url = local_storage_api.unlock()
    r = requests.post(url, headers=local_headers,
                      verify=False)
    if r.status_code != http.client.ACCEPTED:
        raise requests.HTTPError(r)
    print("Request was accepted. JOB URL : " +
          r.json()["self"])
    wait_until_jobstatus_is_changed(
        local_storage_api, local_headers,
        r.json()["jobId"], "Completed", True)

    # step5 Unlock the remote resource group #
    print("Unlock the remote resource group")
    url = remote_storage_api.unlock()
    r = requests.post(url, headers=remote_headers,
                      verify=False)
    if r.status_code != http.client.ACCEPTED:
        raise requests.HTTPError(r)
    print("Request was accepted. JOB URL : " +
          r.json()["self"])
    wait_until_jobstatus_is_changed(
        remote_storage_api,
        remote_headers,
        r.json()["jobId"],
        "Completed",
        True)
```

9. Confirm that the pair has been created.

Confirm that processing for creating the pair is completed in the storage system. Use the `wait_until_jobstatus_is_changed` function to confirm that the job execution status has changed to "Completed".

```
# step6 Wait until the operation is complete #
affected_resource_path = wait_until_jobstatus_is_changed(
    local_storage_api, local_headers,
    jobid, "Completed", False)
```

10. Get information about a TrueCopy pair.

To confirm that the pair has been correctly created, get information about the pair by using the URL of the pair that was obtained when the TrueCopy pair was created. In the sample coding, the following items are output: the copy group name, copy pair name, pair type, LDEV numbers for the P-VOL and S-VOL, pair volume status, and the storage device ID.

```
# step7 Print the remote copy pair #
print("Print the remote copy pair")
url = local_storage_api.affected_resource(
    affected_resource_path)
r = requests.get(url, headers=local_headers,
                verify=False)
if r.status_code != http.client.OK:
    raise requests.HTTPError(r)
print("COPY GROUP NAME : " +
      str(r.json()["copyGroupName"]))
print("COPY PAIR NAME : " +
      str(r.json()["copyPairName"]))
print("REPLICATION TYPE : " +
      str(r.json()["replicationType"]))
print("PVOL LDEV ID : " + str(r.json()["pvolLdevId"]))
print("SVOL LDEV ID : " + str(r.json()["svolLdevId"]))
print("PVOL STATUS : " + str(r.json()["pvolStatus"]))
print("SVOL STATUS : " + str(r.json()["svolStatus"]))
print("PVOL STORAGE DEVICE ID : "
      + str(r.json()["pvolStorageDeviceId"]))
print("SVOL STORAGE DEVICE ID : "
      + str(r.json()["svolStorageDeviceId"]))
print("REMOTE MIRROR COPY PAIR ID : "
      + str(r.json()["remoteMirrorCopyPairId"]))
print()
```

11. Output error messages.

In the sample coding, processing for communication errors, HTTP request errors, and job execution errors is described. If a communication error occurs, an error message is output. If an HTTP request error occurs, the error code, the error message, and the response body are output. If a job execution error occurs, all of the contents included in the job execution result are output.

```
except requests.ConnectionError:
    sys.stderr.write("Connection Error!\n")
    sys.stderr.write(traceback.format_exc())
except requests.HTTPError as he:
    sys.stderr.write("HTTP Error! status code : ")
    sys.stderr.write(str(he.args[0].status_code) + "\n")
    sys.stderr.write(he.args[0].text + "\n")
except Exception as e:
    sys.stderr.write(traceback.format_exc())
    for msg in e.args:
        sys.stderr.write(str(msg) + "\n")
```

12. Discard the session.

After a set of operations is completed, discard the session by using the REST API server of both the local and the remote storage systems. Specify the session ID that was obtained when the session was created. The "finally" statement in the sample coding makes sure that the session will be discarded even if an error occurs while the API is running. After the session is discarded, the processing ends.

```
finally:
    # step8 Discard the local session #
    print("Discard the local session")
    url = local_storage_api. \
        discard_session(local_session_id)
    r = requests.delete(url, headers=local_headers,
                       verify=False)
    if r.status_code != http.client.OK:
        raise requests.HTTPError(r)

    # step8 Discard the remote session #
    print("Discard the remote session")
    url = remote_storage_api.discard_session(
        remote_session_id)
    r = requests.delete(url,
                       headers=remote_headers, verify=False)
    if r.status_code != http.client.OK:
        raise requests.HTTPError(r)

    print("Operation was completed.")
    sys.exit()
```

Sample coding for uploading files (specifying the transfer destinations of audit log files)

This section provides sample code for specifying the transfer destinations of the audit log files of storage systems. This sample coding includes the procedure for uploading the client certificates to a storage system.

Operation flow of the sample code for specifying the transfer destinations of the audit log files of storage systems

The following is the operation flow of the sample code for specifying the transfer destinations of the audit log files of storage systems and the corresponding code constructs.

| Step | Sample coding operation flow | Code constructs |
|------|---|--|
| 1 | Import necessary libraries and set parameters. | - |
| 2 | Define headers. | Specifying request headers (for the default HTTP headers) |
| 3 | Define functions for issuing an HTTP request and for verifying the status of asynchronous processing. | Getting information about the job status by performing a GET operation Setting user authentication information (for authentication by using session-based authentication) Generating a request body in JSON format Getting the job execution results Getting the URLs of the resources to which the operation results have been applied Getting error codes |
| 4 | Check the version of the REST API. | Getting information about the version of the REST API by performing a GET operation |
| 5 | Generate a session. | Getting the URLs of the resources (when object IDs are not specified) Setting user authentication information (for authentication by using a user ID and a password) Creating objects by performing a POST operation |
| 6 | Upload the root certificate of the syslog server to which audit log files are to be transferred. | Getting the URLs of the resources (when object IDs are not specified) Creating form data Running actions for objects by using the POST operation |
| 7 | Upload the client certificate of the syslog server to which audit log files are to be transferred. | Getting the URLs of the resources (when object IDs are not specified) Creating form data Running actions for objects by using the POST operation |

| Step | Sample coding operation flow | Code constructs |
|------|--|--|
| 8 | Specify the syslog server to which audit log files are to be transferred. | Getting the URLs of the resources (when fixed object IDs such as those for single instances are specified) Getting the URLs of the resources (for objects of a single instance) Generating a request body in JSON format Changing the attribute of an object by using the PATCH operation |
| 9 | Send a test message to the syslog server to which audit log files are to be transferred. | Getting the URLs of the resources (when fixed object IDs such as those for single instances are specified) Running actions for objects by using the POST operation |
| 10 | Obtain the configuration information of the transfer destinations of audit log files | Getting the URLs of the resources (when fixed object IDs such as those for single instances are specified) Obtaining an object by using the GET operation (when obtaining a specific object) Outputting obtained information |
| 11 | Output error messages. | Outputting error messages |
| 12 | Discard the session. | Getting the URLs of the resources (when object IDs that are obtained from the operation results are specified) Deleting objects by performing a DELETE operation |

Expected system configuration

The sample code assumes the system configuration in the following figure. Note that the transfer destination is a single syslog server.

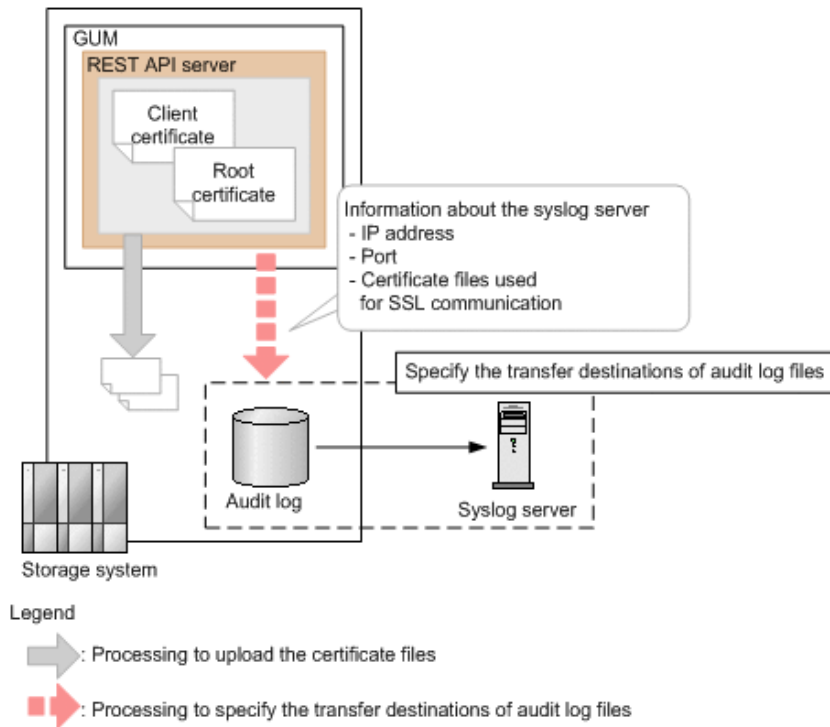

The following table shows the values specified for the parameters in the sample coding. If necessary, change the settings to match the system environment and requirements.

| Parameter | Value | Description |
|-----------------------|--------------------|--|
| USER_CREDENTIAL | ("user1", "pass1") | Authentication information used for authentication by the storage system. In the sample code, the user ID is <code>user1</code> and the password is <code>pass1</code> . The user must have the Audit Log Administrator (View & Modify) role. |
| ROOT_CERT_FILE_PATH | "D:\\cert\\" | The path where the root certificate file of the syslog server (the file to be uploaded to the storage system) is stored. The sample code specifies for SSL communication to be used between the storage system and the syslog server. Prepare the root certificate of the syslog server in advance. |
| ROOT_CERT_FILE_NAME | "root.crt" | The name of the root certificate file of the syslog server (the file to be uploaded to the storage system). |
| CLIENT_CERT_FILE_PATH | "D:\\cert\\" | The path where the client certificate file of the syslog server (the file to be uploaded to the storage system) is stored. |

| Parameter | Value | Description |
|----------------------------------|--------------------|--|
| | | The sample code specifies for SSL communication to be used between the storage system and the syslog server. Prepare the client certificate of the syslog server in advance. |
| CLIENT_CERT_FILE_NAME | "client.pfx" | The name of the client certificate file of the syslog server (the file to be uploaded to the storage system). |
| TRANSFER_PROTOCOL | "TLS" | The protocol to be used when transferring the audit logs to the syslog server. |
| LOCATION_NAME | "STORAGE_SYSTEM_1" | The name that identifies the storage system from which the audit logs are to be transferred. |
| RETRY_INTERVAL | 5 | The interval (in seconds) between retries when communication with the syslog server fails. |
| PRIMARY_SYSLOG_SERVER_IP_ADDRESS | "192.0.1.101" | The IP address of the syslog server. |
| PRIMARY_SYSLOG_SERVER_PORT | "12345" | The port number used by the syslog server. |
| CLIENT_CERT_FILE_PASSWORD | "certFilePass" | The password for the client certificate file. |
| FIRST_WAIT_TIME | 1 | The first interval (in seconds) for collecting the execution result of asynchronous processing. Normally, you do not need to change this value. |
| MAX_RETRY_COUNT | 6 | The maximum number of retries for collecting the execution result of asynchronous processing. Normally, you do not need to change this value. |

Contents of the sample coding

This subsection explains the sample coding.

1. Import necessary libraries and set parameters.

Sample coding for uploading files (specifying the transfer destinations of audit log files)

Before starting the volume allocation processing, the sample coding imports the required libraries or classes. In addition to the common libraries, the sample coding also imports the `BlockStorageAPI` class that defines the function that generates URLs.

```
# coding:utf-8

"""
auditlog_syslog_server setting

This program requires API version 1.9.0 or newer.
"""

import requests
import json
import sys
import http.client
import time
import traceback
import rest_server_param
import storage_param

from block_storage_api import BlockStorageAPI
```

Set parameters to be used in the sample coding.

```
# #####Initialize parameters##### #
# Change the following parameters to fit your environment

# A path of root certificate
ROOT_CERT_FILE_PATH = "D:\\cert\\"

# A root certificate name
ROOT_CERT_FILE_NAME = "root.crt"

# A path of client certificate
CLIENT_CERT_FILE_PATH = "D:\\cert\\"

# A client certificate name
CLIENT_CERT_FILE_NAME = "client.pfx"

# A transfer protocol
TRANSFER_PROTOCOL = "TLS"

# A location name
LOCATION_NAME = "STORAGE_SYSTEM_1"

# A retry interval
RETRY_INTERVAL = 5

# A primary syslog server IP address
PRIMARY_SYSLOG_SERVER_IP_ADDR = "192.0.1.101"

# A primary syslog server port number
PRIMARY_SYSLOG_SERVER_PORT = "12345"

# A password of the client certificate
CLIENT_CERT_FILE_PASSWORD = "certFilePass"

# This parameter defines the first interval to access
# an asynchronous job. (Unit: Second)
FIRST_WAIT_TIME = 1

# This parameter defines the maximum retry time
# to confirm job status.
MAX_RETRY_COUNT = 6

# An user id and password of the target storage
USER_CREDENTIAL = ("user1", "pass1")

#####
```

2. Define headers.

Define the HTTP request header. In addition to the JSON format, which is the standard format for the REST API, define the header information so that the form data format, which used in by the API function for uploading the file, can also be handled.

```
# ###You don't have to change the following parameters### #
block_storage_api = BlockStorageAPI(
    rest_server_param.REST_SERVER_IP_ADDR,
    rest_server_param.REST_SERVER_PORT,
    storage_param.STORAGE_MODEL,
    storage_param.SERIAL_NUMBER)

headers = {"content-type": "application/json",
          "accept": "application/json"}
file_upload_headers = {"accept": "application/json",
                       "Expect": ""}

REQUIRED_MAJOR_VERSION = 1
REQUIRED_MINOR_VERSION = 9

session_id = 0

#####
```

3. Define the function for issuing an HTTP request and for verifying the status of asynchronous processing (the `invoke_async_command` function).

Define the function that issues an HTTP request and verifies the status of asynchronous processing. Call and use this function from the main volume allocation operation. For details on this function, see the section explaining the functions used in the sample coding.



Tip: To prevent errors that occur when the server certificate used for SSL communication between the REST API client and the storage system is a self-signed certificate, the sample coding specifies `verify=False` in the request message to skip verification of the server certificate.

```
"""
Check whether the asynchronous command was finished.
@param job_id the job ID to identify
           the asynchronous command
@return r the response data
"""

def check_update(job_id):
    url = block_storage_api.job(str(job_id))
    r = requests.get(url, headers=headers, verify=False)
    return r
```

```
"""
Execute the HTTP request (POST or PATCH)
@param method_type HTTP request method (POST or PATCH)
@param url URL to execute HTTP method
@param body The information of a resource
@return job_result.json()["affectedResources"][0]
           URL of an affected resource
"""

def invoke_async_command(method_type, url, body):
    if method_type == "patch":
        r = requests.patch(url, headers=headers,
                           data=json.dumps(body), verify=False)
    elif method_type == "post":
        if body is None:
            r = requests.post(
                url,
                headers=headers,
                verify=False)
        else:
            r = requests.post(
                url,
                headers=headers,
                data=json.dumps(body),
                verify=False)
    if r.status_code != http.client.ACCEPTED:
        raise requests.HTTPError(r)
    print("Request was accepted. JOB URL : " +
          r.json()["self"])
```



```
if "affectedResources" in job_result.json():
    print("Async job was succeeded." +
          " affected resource : " +
          job_result.json()["affectedResources"][0])
    return job_result.json()["affectedResources"][0]
else:
    print("Async job was succeeded.")
    return None
```

4. Check the version of the REST API.

Get information about the version of the REST API to make sure that the version is supported.

```
"""
Check whether this API version allows the REST
Server to execute this program

@param api_version api version of this REST Server
@param required_major_version the lowest number of
    the major version that this program requires
@param required_minor_version the lowest number of
    the minor version that this program requires

"""

def check_api_version(api_version, required_major_version,
                     required_minor_version):
    version = api_version.split(".")
    major_version = int(version[0])
    minor_version = int(version[1])
    if not ((major_version == required_major_version and
             minor_version >= required_minor_version) or
            major_version >= required_major_version + 1):
        sys.exit("This program requires API Version " +
                 str(required_major_version) + "." +
                 str(required_minor_version) +
                 "." + "x or newer.\n")

try:
    # step1 Check the API version #
    print("Check the API version")
    url = block_storage_api.api_version()
    r = requests.get(url, headers=headers, verify=False)
    if r.status_code != http.client.OK:
        raise requests.HTTPError(r)
    check_api_version(
        r.json()["apiVersion"],
        REQUIRED_MAJOR_VERSION,
        REQUIRED_MINOR_VERSION)
```

5. Generate a session.

Generate sessions by using the REST API server.

```
# step2 Generate a session #
print("Generate a session")
url = block_storage_api.generate_session()
r = requests.post(url, headers=headers, auth=USER_CREDENTIAL,
                  verify=False)
if r.status_code != http.client.OK:
    raise requests.HTTPError(r)
token = r.json()["token"]
auth = "Session " + token
session_id = r.json()["sessionId"]
headers["Authorization"] = auth
file_upload_headers["Authorization"] = auth
```

When a session is generated, a session ID and a token are returned. When running the API, specify the token for the Authentication header as the required authentication information for the subsequent operations. Use the session ID to discard the session after a set of operations is completed.

6. Upload the root certificate of the syslog server to which the audit log files are to be transferred.

As preparation for transferring the audit log files to the syslog server by using SSL communication, upload the root certificate of the syslog server to the storage system.

```
# step3 Upload a root certificate #
print("Upload a root certificate")
url = block_storage_api.file_upload()
files = {"file": (ROOT_CERT_FILE_NAME,
                 open(ROOT_CERT_FILE_PATH + ROOT_CERT_FILE_NAME, "rb"),
                 "application/octet-stream")}
r = requests.post(url, headers=file_upload_headers,
                  data={"fileType": "AuditSyslogPrimaryRootCertFile"},
                  files=files, verify=False)
if r.status_code != http.client.OK:
    raise requests.HTTPError(r)
```

7. Upload the client certificate of the syslog server to which audit log files are to be transferred.

As preparation for transferring the audit log files to the syslog server by using SSL communication, upload the client certificate of the syslog server to the storage system.

```
# step4 Upload a client certificate #
print("Upload a client certificate")
files = {"file": (CLIENT_CERT_FILE_NAME,
                 open(CLIENT_CERT_FILE_PATH + CLIENT_CERT_FILE_NAME,
                      "rb"), "application/octet-stream")}
r = requests.post(url, headers=file_upload_headers,
                 data={"fileType":
                       "AuditSyslogPrimaryClientCertFile"},
                 files=files, verify=False)
if r.status_code != http.client.OK:
    raise requests.HTTPError(r)
```

8. Specify the syslog server to which audit log files are to be transferred.

Specify the settings for transferring audit log files to the syslog server. Because the sample code specifies for SSL communication to be used for communication with the syslog server, in addition to information about the syslog server to which audit log files are to be transferred, the sample code also specifies information about the certificate for SSL communication.

```
# step5 Modify the syslog server #
print("Modify the syslog server")
url = block_storage_api.auditlog_syslog()
body = {
    "transferProtocol": TRANSFER_PROTOCOL,
    "locationName": LOCATION_NAME,
    "retries": True,
    "retryInterval": RETRY_INTERVAL,
    "primarySyslogServer": {
        "isEnabled": True,
        "ipAddress": PRIMARY_SYSLOG_SERVER_IP_ADDR,
        "port": PRIMARY_SYSLOG_SERVER_PORT,
        "clientCertFileName": CLIENT_CERT_FILE_NAME,
        "clientCertFilePassword": CLIENT_CERT_FILE_PASSWORD,
        "rootCertFileName": ROOT_CERT_FILE_NAME
    },
    "secondarySyslogServer": {
        "isEnabled": False
    }
}
invoke_async_command("patch", url, body)
```

The `invoke_async_command` function issues a request to specify the transfer destination of audit log files and checks the execution status of jobs that are executed asynchronously. The function then returns, as the execution result, the URL of information about the transfer destination of audit log files that is specified for the storage system.

9. Send a test message to the syslog server to which audit log files are to be transferred.

Send a test message to check whether the syslog server that is set as the transfer destination of audit log files can correctly receive audit log data.

```
# step6 Send a test message to the syslog server #
print("Send a test message to the syslog server")
url = block_storage_api.auditlog_syslog_send_test()
invoke_async_command("post", url, None)
```

10. Obtain the configuration information of the transfer destinations of audit log files.

To make sure that the operations in the previous steps (operations to set information on the storage system) have been successful, obtain and output the configuration information of the transfer destinations of audit logs. The sample code obtains and outputs the following information: the protocol to be used, the identifier of the storage system from which audit log files are to be transferred, retry settings and the interval for retries when communication fails, and the IP address and port number of the syslog server.

```
# step7 Get the syslog server #
print("get the syslog server")
url = block_storage_api.auditlog_syslog()
r = requests.get(url, headers=headers, verify=False)
if r.status_code != http.client.OK:
    raise requests.HTTPError(r)
print("TRANSFER PROTOCOL : " +
      str(r.json()["transferProtocol"]))
print("LOCATION NAME : " +
      str(r.json()["locationName"]))
print("RETRIES : " +
      str(r.json()["retries"]))
print("RETRY INTERVAL : " +
      str(r.json()["retryInterval"]))
print("PRIMARY SYSLOG SERVER")
print("IP ADDRESS : " +
      str(r.json()["primarySyslogServer"]["ipAddress"]))
print("PORT : " +
      str(r.json()["primarySyslogServer"]["port"]))
```

11. Output error messages.

In the sample coding, processing for communication errors, HTTP request errors, and job execution errors is described. If a communication error occurs, an error message is output. If an HTTP request error occurs, the error code, the error message, and the response body are output. If a job execution error occurs, all of the contents included in the job execution result are output.

```
except requests.ConnectionError:
    sys.stderr.write("Connection Error!\n")
    sys.stderr.write(traceback.format_exc())
except requests.HTTPError as he:
    sys.stderr.write("HTTP Error! status code : ")
    sys.stderr.write(str(he.args[0].status_code) + "\n")
    sys.stderr.write(he.args[0].text + "\n")
except Exception as e:
    sys.stderr.write(traceback.format_exc())
    for msg in e.args:
        sys.stderr.write(str(msg) + "\n")
```

12. Discard the session.

After a set of operations is completed, discard the session. Specify the session ID that was obtained when the session was generated. The "finally" statement in the sample coding makes sure that the session will be discarded even if an error occurs while the API is running. After the session is discarded, the processing ends.

```
finally:
    # step8 Discard the session #
    print("Discard the session")
    url = block_storage_api.discard_session(session_id)
    r = requests.delete(url, headers=headers, verify=False)
    try:
        if r.status_code != http.client.OK:
            raise requests.HTTPError(r)
    except requests.HTTPError as he:
        sys.stderr.write("HTTP Error! status code : ")
        sys.stderr.write(str(he.args[0].status_code) + "\n")
        sys.stderr.write(he.args[0].text + "\n")

    print("Operation was completed.")
    sys.exit()
```

Sample coding for downloading a file (backing up encryption keys)

This section provides the sample coding for backing up encryption keys. This sample coding includes the procedure for downloading an encryption key backup file to a client.

Sample coding operation flow for backing up encryption keys

The following table shows the sample coding operation flow for backing up encryption keys and the corresponding code constructs.

| Step | Sample coding operation flow | Code constructs |
|------|--|---|
| 1 | Import necessary libraries and set parameters. | - |
| 2 | Define headers. | Specifying request headers (for the default HTTP headers) |
| 3 | Check the version of the REST API. | Getting information about the version of the REST API by performing a GET operation |
| 4 | Download the encryption key backup file. | Getting the URLs of the resources (when fixed object IDs such as those for single instances are specified) Running actions for objects by using the POST operation |
| 5 | Output error messages. | Outputting error messages |

Values to be specified for the parameters in the sample coding

The following table shows the values specified for the parameters in the sample coding. If necessary, change the settings to match the system environment and requirements.

| Parameter | Value | Description |
|---------------------------------|--------------------|---|
| USER_CREDENTIAL | ("user1", "pass1") | This information is used for authentication by the storage system. In the sample coding, the user ID is <code>user1</code> , and the password is <code>pass1</code> . The user must have the Security Administrator (View & Modify) role. |
| BACKUP_PASSWORD | backuppassword | The password for the encryption key backup file |
| ENCRYPTION_KEY_BACKUP_FILE_PATH | D:\encryption\\ | The path where the encryption key backup file is stored |
| ENCRYPTION_KEY_BACKUP_FILE_NAME | backupfile.ekf | The name of the encryption key backup file |

Contents of the sample coding

This subsection explains the sample coding.

1. Import necessary libraries and set parameters.

Before starting the volume allocation processing, the sample coding imports the required libraries or classes. In addition to the common libraries, the sample coding also imports the `BlockStorageAPI` class that defines the function that generates URLs.

```
# coding:utf-8

"""
backup_encryption_keys

This program requires API version 1.12.0 or newer.
"""

import requests
import json
import sys
import http.client
import traceback
import rest_server_param
import storage_param

from block_storage_api import BlockStorageAPI
```

Set parameters to be used in the sample coding.

```
# #####Initialize parameters##### #
# Change the following parameters to fit your environment

# An user id and password of the target storage
USER_CREDENTIAL = ("user1", "pass1")

# A backup password
BACKUP_PASSWORD = "backuppasword"

# A path of encryption key backup file
ENCRYPTION_KEY_BACKUP_FILE_PATH = "D:\encryption\\"

# A encryption key backup file name
ENCRYPTION_KEY_BACKUP_FILE_NAME = "backupfile.ekf"

#####
```

2. Define headers.

Define the HTTP request header. In addition to the JSON format, which is the standard format for the REST API, define the header information so that the stream data format, which is used in the API function for file downloading, can also be handled.

```
# ###You don't have to change the following parameters### #
block_storage_api = BlockStorageAPI(
    rest_server_param.REST_SERVER_IP_ADDR,
    rest_server_param.REST_SERVER_PORT,
    storage_param.STORAGE_MODEL,
    storage_param.SERIAL_NUMBER)

headers = {"content-type": "application/json",
          "accept": "application/json"}

file_download_headers = {"content-type": "application/json",
                        "accept": "application/octet-stream"}

REQUIRED_MAJOR_VERSION = 1
REQUIRED_MINOR_VERSION = 12

#####
```

3. Check the version of the REST API.

Get information about the version of the REST API to make sure that the version is supported.

```
"""
Check whether this API version allows the REST
Server to execute this program

@param api_version api version of this REST Server
@param required_major_version the lowest number of
    the major version that this program requires
@param required_minor_version the lowest number of
    the minor version that this program requires

"""

def check_api_version(api_version, required_major_version,
                    required_minor_version):
    version = api_version.split(".")
    major_version = int(version[0])
    minor_version = int(version[1])
    if not ((major_version == required_major_version and
            minor_version >= required_minor_version) or
            major_version >= required_major_version + 1):
        sys.exit("This program requires API Version " +
                str(required_major_version) + "." +
                str(required_minor_version) +
```

```

        "." + "x or newer.\n")

try:
    # step1 Check the API version #
    print("Check the API version")
    url = block_storage_api.api_version()
    r = requests.get(url, headers=headers, verify=False)
    if r.status_code != http.client.OK:
        raise requests.HTTPError(r)
    check_api_version(
        r.json()["apiVersion"],
        REQUIRED_MAJOR_VERSION,
        REQUIRED_MINOR_VERSION)

```

4. Download the encryption key backup file.

Download the encryption key backup file to a specified path.

```

# step2 Get the encryption keys backup #
print("Get the encryption keys backup")
url = block_storage_api.encryption_key_file_backup()
body = {
    "parameters": {
        "password": BACKUP_PASSWORD
    }
}
r = requests.post(url, headers=file_download_headers,
                  auth=USER_CREDENTIAL, data=json.dumps(body),
                  verify=False)
if r.status_code != http.client.OK:
    raise requests.HTTPError(r)
with open(ENCRYPTION_KEY_BACKUP_FILE_PATH +
          ENCRYPTION_KEY_BACKUP_FILE_NAME, 'wb') as saveFile:
    saveFile.write(r.content)

```

5. Output error messages.

In the sample coding, processing for communication errors, HTTP request errors, and job execution errors is described. If a communication error occurs, an error message is output. If an HTTP request error occurs, the error code, the error message, and the response body are output. If a job execution error occurs, all of the contents included in the job execution result are output.

```

except requests.ConnectionError:
    sys.stderr.write("Connection Error!\n")
    sys.stderr.write(traceback.format_exc())
except requests.HTTPError as he:
    sys.stderr.write("HTTP Error! status code : ")
    sys.stderr.write(str(he.args[0].status_code) + "\n")
    sys.stderr.write(he.args[0].text + "\n")
except Exception as e:

```

```

sys.stderr.write(traceback.format_exc())
for msg in e.args:
    sys.stderr.write(str(msg) + "\n")
finally:
    print("Operation was completed.")
    sys.exit()

```

Sample coding for re-creating a parity group (data encryption)

This section provides the sample coding for re-creating a parity group (encrypting data).



Note:

This operation is performed as part of the procedure for encrypting existing data without changing the drive configuration. For details on the entire procedure, see the description of the flow of data encryption operations.

Before deleting a parity group, be sure to back up the data in the parity group to a volume in another parity group.

Sample coding operation flow for re-creating a parity group

The following table shows the sample coding operation flow for re-creating a parity group and the corresponding code constructs.

| Step | Sample coding operation flow | Code constructs |
|------|---|---|
| 1 | Import necessary libraries and set parameters. | - |
| 2 | Define headers. | Specifying request headers (for the default HTTP headers) |
| 3 | Define functions for issuing an HTTP request and for verifying the status of asynchronous processing. | Getting information about the job status by performing a GET operation Setting user authentication information (for authentication by using session-based authentication) Generating a request body in JSON format Getting the job execution results Getting the URLs of the resources to which the operation results have been applied |

| Step | Sample coding operation flow | Code constructs |
|------|---|---|
| | | Getting error codes |
| 4 | Check the version of the REST API. | Getting information about the version of the REST API by performing a GET operation |
| 5 | Generate a session. | Getting the URLs of the resources (when object IDs are not specified) Setting user authentication information (for authentication by using a user ID and a password) Creating objects by performing a POST operation |
| 6 | Get information about the parity group. | Getting objects by performing a GET operation Setting user authentication information (for authentication by using session-based authentication) Outputting the acquired information |
| 7 | Get information about drives. | Getting objects by performing a GET operation Setting user authentication information (for authentication by using session-based authentication) Outputting the acquired information |
| 8 | Delete the parity group. | Getting the URLs of the resources (when no object ID is specified) Setting user authentication information (for authentication by using session-based authentication) Generating a request body in JSON format Deleting objects by performing a DELETE operation |
| 9 | Create a parity group. | Getting the URLs of the resources (when no object ID is specified) Setting user authentication information (for authentication by using session-based authentication) Generating a request body in JSON format Creating objects by performing a POST operation |
| 10 | Get information about the parity group. | Getting objects by performing a GET operation |

| Step | Sample coding operation flow | Code constructs |
|------|------------------------------|---|
| | | Setting user authentication information (for authentication by using session-based authentication) Outputting the acquired information |
| 11 | Output error messages. | Outputting error messages |
| 12 | Discard the session. | Getting the URLs of the resources (when object IDs that are obtained from the operation results are specified) Deleting objects by performing a DELETE operation |

Expected system configuration

This sample coding assumes the system configuration is as shown in the following figure.

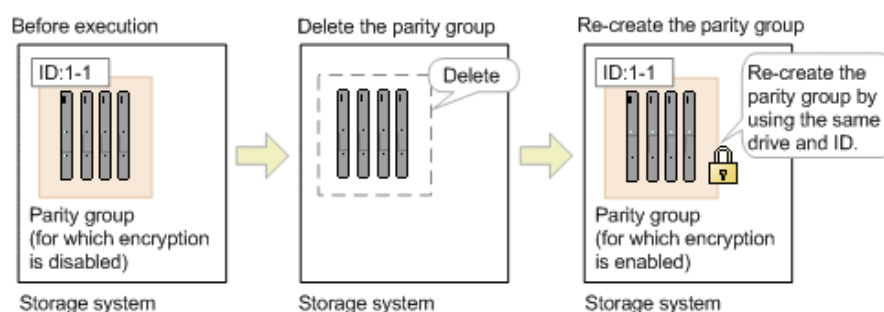

The following table shows the values specified for the parameters in the sample coding. If necessary, change the settings to match the system environment and requirements.

| Parameter | Value | Description |
|-----------------|--------------------|---|
| USER_CREDENTIAL | ("user1", "pass1") | This is the authentication information to be used for authentication in the storage system. The coding sample shows a setting example when the user ID is <code>user1</code> , and the password is <code>pass1</code> . The user needs the Storage Administrator (Provisioning) role. |
| PARITY_GROUP_ID | 1-1 | The ID of the parity group to be recreated |
| FIRST_WAIT_TIME | 1 | The first interval (seconds) for collecting the execution result of asynchronous processing. Normally, you do not need to change this value. |

| Parameter | Value | Description |
|-----------------|-------|---|
| MAX_RETRY_COUNT | 6 | The maximum number of retries for collecting the execution result of asynchronous processing. Normally, you do not need to change this value. |

Contents of the sample coding

This subsection explains the sample coding.

1. Import necessary libraries and set parameters.

Before starting the volume allocation processing, the sample coding imports the required libraries or classes. In addition to the common libraries, the sample coding also imports the BlockStorageAPI class that defines the function that generates URLs.

```
# coding:utf-8

"""
recreate_parity_group

This program requires API version 1.12.0 or newer.
"""

import requests
import json
import sys
import http.client
import time
import traceback
import rest_server_param
import storage_param

from block_storage_api import BlockStorageAPI
```

Set parameters to be used in the sample coding.

```
# #####Initialize parameters##### #
# Change the following parameters to fit your environment

# This parameter defines the first interval to access
# an asynchronous job. (Unit: Second)
FIRST_WAIT_TIME = 1

# This parameter defines the maximum retry time
# to confirm job status.
MAX_RETRY_COUNT = 6

# An user id and password of the target storage
USER_CREDENTIAL = ("user1", "pass1")
```

```
# A parity group id
PARITY_GROUP_ID = "1-1"

#####
```

2. Define headers.

Define the HTTP request header. Because the REST API only supports JSON format data, the sample coding defines header information so that data is handled in JSON format.

```
# ###You don't have to change the following parameters### #
block_storage_api = BlockStorageAPI(
    rest_server_param.REST_SERVER_IP_ADDR,
    rest_server_param.REST_SERVER_PORT,
    storage_param.STORAGE_MODEL,
    storage_param.SERIAL_NUMBER)

headers = {"content-type": "application/json",
          "accept": "application/json",
          "Response-Job-Status": "Completed"}

REQUIRED_MAJOR_VERSION = 1
REQUIRED_MINOR_VERSION = 12

#####
```

3. Define the function for issuing an HTTP request and for verifying the status of asynchronous processing (the `invoke_async_command` function).

Define the function that issues an HTTP request and verifies the status of asynchronous processing. Call and use this function from the main volume allocation operation. For details on this function, see the section explaining the functions used in the sample coding.



Tip: To prevent errors that occur if the server certificate used for SSL communication between the REST API client and the storage system is a self-signed certificate, the sample coding skips the verification of the server certificate by specifying `verify=False` when a request is issued.

```
"""
Check whether the asynchronous command was finished.
@param job_id the job ID to identify
           the asynchronous command
@return r the response data
"""

def check_update(job_id):
    url = block_storage_api.job(str(job_id))
```

```

    r = requests.get(url, headers=headers, verify=False)
    return r

"""
Execute the HTTP request (POST, PUT or DELETE)
@param method_type HTTP request method (POST, PUT or DELETE)
@param url URL to execute HTTP method
@param body The information of a resource
@return job_result.json()["affectedResources"][0]
        URL of an affected resource
"""

def invoke_async_command(method_type, url, body):
    if method_type == "put":
        if body is None:
            r = requests.put(url, headers=headers, verify=False)
        else:
            r = requests.put(url, headers=headers,
                             data=json.dumps(body), verify=False)
    elif method_type == "post":
        r = requests.post(
            url,
            headers=headers,
            data=json.dumps(body),
            verify=False)
    elif method_type == "delete":
        r = requests.delete(
            url,
            headers=headers,
            verify=False)

    if r.status_code != http.client.ACCEPTED:
        raise requests.HTTPError(r)
    print("Request was accepted. JOB URL : " +
          r.json()["self"])
    status = "Initializing"
    job_result = None
    retry_count = 1
    wait_time = FIRST_WAIT_TIME
    while status != "Completed":
        if retry_count > MAX_RETRY_COUNT:
            raise Exception("Timeout Error! "
                             "Operation was not completed.")
        time.sleep(wait_time)
        job_result = check_update(r.json()["jobId"])
        status = job_result.json()["status"]
        double_time = wait_time * 2
        if double_time < 120:
            wait_time = double_time
        else:

```



```

        wait_time = 120
        retry_count += 1
    if job_result.json()["state"] == "Failed":
        error_obj = job_result.json()["error"]
        if "errorCode" in error_obj:
            if "SSB1" in error_obj["errorCode"]:
                print("Error! SSB code : ",
                      error_obj["errorCode"]["SSB1"],
                      ", ", error_obj["errorCode"]["SSB2"])
            elif "errorCode" in error_obj["errorCode"]:
                print("Error! error code : ",
                      error_obj["errorCode"]["errorCode"])
            raise Exception("Job Error!", job_result.text)
        if "affectedResources" in job_result.json():
            print("Async job was succeeded. affected resource : " +
                  job_result.json()["affectedResources"][0])
            return job_result.json()["affectedResources"][0]
        else:
            print("Async job was succeeded.")
            return None

```

4. Check the version of the REST API.

Get information about the version of the REST API to make sure that the version is supported.

```

"""
Check whether this API version allows the REST
Server to execute this program

@param api_version api version of this REST Server
@param required_major_version the lowest number of
    the major version that this program requires
@param required_minor_version the lowest number of
    the minor version that this program requires

"""

def check_api_version(api_version, required_major_version,
                     required_minor_version):
    version = api_version.split(".")
    major_version = int(version[0])
    minor_version = int(version[1])
    if not ((major_version == required_major_version and
             minor_version >= required_minor_version) or
            major_version >= required_major_version + 1):
        sys.exit("This program requires API Version " +
                 str(required_major_version) + "." +
                 str(required_minor_version) +

```

```

        "." + "x or newer.\n")

try:
    # step1 Check the API version #
    print("Check the API version")
    url = block_storage_api.api_version()
    r = requests.get(url, headers=headers, verify=False)
    if r.status_code != http.client.OK:
        raise requests.HTTPError(r)
    check_api_version(
        r.json()["apiVersion"],
        REQUIRED_MAJOR_VERSION,
        REQUIRED_MINOR_VERSION)

```

5. Generate a session.

Generate sessions by using the REST API server.

```

# step2 Generate a session #
print("Generate a session")
url = block_storage_api.generate_session()
r = requests.post(url, headers=headers,
                  auth=USER_CREDENTIAL, verify=False)
if r.status_code != http.client.OK:
    raise requests.HTTPError(r)
token = r.json()["token"]
auth = "Session " + token
session_id = r.json()["sessionId"]
headers["Authorization"] = auth

```

When you generate a session, a session ID and a token are returned. When running the API, specify the token for the Authentication header as the required authentication information for the subsequent operations. Use the session ID to discard the session after a set of operations is completed.

6. Get information about the parity group.

Get information about the parity group by specifying its parity group number. From the acquired information, the sample coding outputs the following information: number of LDEVs in the parity group, usage rate of the parity group, available capacity, RAID level, RAID type, CLPR number, code indicating the drive type of the drives belonging to the parity group, drive type of the drives that belong to the parity group, rotation speed of the drives belonging to the parity group, value of the encryption setting of the parity group, total logical capacity of the parity group, total physical capacity of the parity group, and value of the accelerated compression setting of the parity group.

```

# step3 Get the parity group #
print("Get the parity group")
url = block_storage_api.parity_group(PARITY_GROUP_ID)
r = requests.get(url, headers=headers,
                  auth=USER_CREDENTIAL, verify=False)
if r.status_code != http.client.OK:

```

```

        raise requests.HTTPError(r)

        raidType = r.json()["raidType"]
        isCopyBackModeEnabled = r.json()["isEncryptionEnabled"]
        isAcceleratedCompressionEnabled = r.json()
["isAcceleratedCompressionEnabled"]
        clprId = r.json()["clprId"]
        print("NUM OF LDEVS : " + str(r.json()["numOfLdevs"]))
        print("USED CAPACITY RATE : " + str(r.json()["usedCapacityRate"]))
        print("AVAILABLE VOLUME CAPACITY : " + str(r.json()
["availableVolumeCapacity"]))
        print("RAID LEVEL : " + str(r.json()["raidLevel"]))
        print("RAID TYPE : " + str(r.json()["raidType"]))
        print("CLPR ID : " + str(r.json()["clprId"]))
        print("DRIVE TYPE : " + r.json()["driveType"])
        print("DRIVE TYPE NAME : " + str(r.json()["driveTypeName"]))
        print("DRIVE SPEED : " + str(r.json()["driveSpeed"]))
        print("IS ENCRYPTION ENABLED : " + str(r.json()
["isEncryptionEnabled"]))
        print("TOTAL CAPACITY : " + str(r.json()["totalCapacity"]))
        print("PHYSICAL TOTAL CAPACITY : " + str(r.json()
["physicalCapacity"]))
        print("IS ACCELERATED COMPRESSION ENABLED : " + str(r.json()
["isAcceleratedCompressionEnabled"]))
        print()

```

7. Get information about drives.

Get information about drives that belong to a parity group by specifying its parity group number.

```

# step4 Get drives #
print("Get drives")
url = block_storage_api.drives_parity_group(PARITY_GROUP_ID)
r = requests.get(url, headers=headers,
                 auth=USER_CREDENTIAL, verify=False)
if r.status_code != http.client.OK:
    raise requests.HTTPError(r)

drive_ids = []
for d in r.json()["data"]:
    drive_ids.append(d["driveLocationId"])
    print("DRIVE LOCATION ID : " + str(r.json()
["driveLocationId"]))
print()

```

8. Delete the parity group.

Delete the parity group by specifying its parity group number.

```
# step5 Delete the parity group #
print("Delete the parity group")
url = block_storage_api.parity_group(PARITY_GROUP_ID)
invoke_async_command("delete", url, None)
```

The `invoke_async_command` function issues a request to delete the parity group, checks the execution statuses of the jobs that were executed asynchronously, and then returns the URL of the deleted parity group as the execution result.

9. Create a parity group.

Create a parity group by specifying a parity group number and drive IDs.

```
# step6 Create the parity group #
print("Create the parity group")
url = block_storage_api.parity_groups()
body = {
    "parityGroupId": PARITY_GROUP_ID,
    "driveLocationIds": drive_ids,
    "raidType": raidType,
    "isEncryptionEnabled": True,
    "isCopyBackModeEnabled": isCopyBackModeEnabled,
    "isAcceleratedCompressionEnabled":
isAcceleratedCompressionEnabled,
    "clprId": clprId
}
invoke_async_command("post", url, body)
```

The `invoke_async_command` function issues a request to create a parity group, checks the execution statuses of jobs that were executed asynchronously, and then returns the URL of the created parity group as the execution result.

10. Get information about the parity group.

To check whether the operations up to this step have been correctly applied to the resource, get information about the parity group by specifying the parity group number you acquired when you created the parity group. From the acquired information, the sample coding outputs the following information: number of LDEVs in the parity group, usage rate of the parity group, available capacity, RAID level, RAID type, CLPR number, code indicating the drive type of the drives belonging to the parity group, drive type of the drives that belong to the parity group, rotation speed of the drives belonging to the parity group, value of the encryption setting of the parity group, total logical capacity of the parity group, total physical capacity of the parity group, and value of the accelerated compression setting of the parity group.

```
# step7 Get the parity group #
print("Get the parity group")
url = block_storage_api.parity_group(PARITY_GROUP_ID)
r = requests.get(url, headers=headers,
```

```

        auth=USER_CREDENTIAL, verify=False)
    if r.status_code != http.client.OK:
        raise requests.HTTPError(r)

    print("NUM OF LDEVS : " + str(r.json()["numOfLdevs"]))
    print("USED CAPACITY RATE : " + str(r.json()["usedCapacityRate"]))
    print("AVAILABLE VOLUME CAPACITY : " + str(r.json()
["availableVolumeCapacity"]))
    print("RAID LEVEL : " + str(r.json()["raidLevel"]))
    print("RAID TYPE : " + str(r.json()["raidType"]))
    print("CLPR ID : " + str(r.json()["clprId"]))
    print("DRIVE TYPE : " + r.json()["driveType"])
    print("DRIVE TYPE NAME : " + str(r.json()["driveTypeName"]))
    print("DRIVE SPEED : " + str(r.json()["driveSpeed"]))
    print("IS ENCRYPTION ENABLED : " + str(r.json()
["isEncryptionEnabled"]))
    print("TOTAL CAPACITY : " + str(r.json()["totalCapacity"]))
    print("PHYSICAL TOTAL CAPACITY : " + str(r.json()
["physicalCapacity"]))
    print("IS ACCELERATED COMPRESSION ENABLED : " + str(r.json()
["isAcceleratedCompressionEnabled"]))
    print()

```

11. Output error messages.

In the sample coding, processing for communication errors, HTTP request errors, and job execution errors is described. If a communication error occurs, an error message is output. If an HTTP request error occurs, the error code, the error message, and the response body are output. If a job execution error occurs, all of the contents included in the job execution result are output.

```

except requests.ConnectionError:
    sys.stderr.write("Connection Error!\n")
    sys.stderr.write(traceback.format_exc())
except requests.HTTPError as he:
    sys.stderr.write("HTTP Error! status code : ")
    sys.stderr.write(str(he.args[0].status_code) + "\n")
    sys.stderr.write(he.args[0].text + "\n")
except Exception as e:
    sys.stderr.write(traceback.format_exc())
    for msg in e.args:
        sys.stderr.write(str(msg) + "\n")

```

12. Discard the session.

After a set of operations is completed, discard the session. Specify the session ID that was obtained when the session was generated. The "finally" statement in the sample coding makes sure that the session will be discarded even if an error occurs while the API is running. After the session is discarded, the processing ends.

```
finally:
    # step8 Discard the session #
    print("Discard the session")
    url = block_storage_api.discard_session(session_id)
    r = requests.delete(url, headers=headers, verify=False)
    try:
        if r.status_code != http.client.OK:
            raise requests.HTTPError(r)
    except requests.HTTPError as he:
        sys.stderr.write("HTTP Error! status code : ")
        sys.stderr.write(str(he.args[0].status_code) + "\n")
        sys.stderr.write(he.args[0].text + "\n")

    print("Operation was completed.")
    sys.exit()
```

Functions used in the sample coding

This section explains the functions used in the sample coding.

Generating a URL

In the sample coding, the functions that generate the URL to be used in the HTTP request are defined in the BlockStorageAPI class, and are called from the main processing when needed. If you specify the required parameters for each target resource or the method to use, these functions generate and return the corresponding URL. The following explains the sample coding for BlockStorageAPI.

In this sample coding, the storage device ID to be used in the URL is generated from the model name and serial number of the storage system specified by the parameters. The storage device ID is generated by replacing the model name specified by the STORAGE_MODEL_DICT parameter with the fixed value of the type of the storage system. If necessary, change the value to match the system environment and requirements.

```
# coding:utf-8
"""
This class creates a URL for the REST API
to manage block storage
"""

# For VSP E990
STORAGE_MODEL_DICT = {"VSP E990": "936000"}

# For VSP G350, G370, G700, G900, VSP F350, F370, F700, F900
STORAGE_MODEL_DICT = {
```

```

        "VSP G900": "886000",
        "VSP G700": "886000",
        "VSP G370": "886000",
        "VSP G350": "882000",
        "VSP F900": "886000",
        "VSP F700": "886000",
        "VSP F370": "886000",
        "VSP F350": "882000"}

# For VSP 5000 series
STORAGE_MODEL_DICT = {
    "VSP 5500H": "900000",
    "VSP 5500": "900000",
    "VSP 5100H": "900000",
    "VSP 5100": "900000"}

class BlockStorageAPI():
    # GUM IP address
    gum_ip_addr = None
    # port number
    port = None
    # storage URL
    base_url = None
    # object URL
    object_url = None
    # service URL
    service_url = None
    # storage device ID
    storage_id = None

```

Generate the common part, in the following format, of the requests in the URL:

For the objects domain:

```
protocol://host-name:port-number/ConfigurationManager/version/objects
```

For the services domain:

```
protocol://host-name:port-number/ConfigurationManager/version/
services
```

```

def __init__(self, gum_ip_addr, port, storage_model,
             serial_number):
    self.gum_ip_addr = gum_ip_addr
    self.port = port
    self.storage_id = STORAGE_MODEL_DICT[storage_model] \
        + serial_number
    self.base_url = "https://" + \
        self.gum_ip_addr + ":" + self.port + \
        "/ConfigurationManager/v1"

```

```
self.object_url = "/objects"
self.service_url = "/services"
```

Next, define the functions according to the target resource and the operation. For example, the URL for creating a volume is generated by the `block_storage_api.ldevs` that corresponds to `ldevs`.

```
def get_storage_id(self):
    return self.storage_id

def ldevs(self):
    url = self.base_url + self.object_url + "/ldevs"
    return url

def ldev(self, object_id):
    url = self.ldevs() + "/" + str(object_id)
    return url

def host_groups(self):
    url = self.base_url + self.object_url + "/host-groups"
    return url

def host_wwns(self):
    url = self.base_url + self.object_url + "/host-wwns"
    return url

def luns(self):
    url = self.base_url + self.object_url + "/luns"
    return url

def local_copy_pairs(self):
    url = self.base_url + self.object_url + \
        "/local-clone-copypairs"
    return url

def split_local_copy_pair_template(self, pair_url):
    url = pair_url + "/actions/split"
    return url

def split_local_copy_pair(self, pair_url):
    url = pair_url + "/actions/split/invoke"
    return url

def generate_session(self):
    url = self.base_url + self.object_url + "/sessions"
    return url

def discard_session(self, object_id):
    url = self.base_url + self.object_url + "/sessions/" + \
        str(object_id)
```



```

    return url

def lock(self):
    url = self.base_url + self.service_url + \
        "/resource-group-service/" + \
        "actions/lock/invoke"
    return url

def unlock(self):
    url = self.base_url + self.service_url + \
        "/resource-group-service/" + \
        "actions/unlock/invoke"
    return url

def remote_storage(self):
    url = self.base_url + self.object_url + \
        "/remote-storages"
    return url

def remote_copy_pairs(self):
    url = self.base_url + self.object_url + \
        "/remote-mirror-copypairs"
    return url

def job(self, object_id):
    url = self.base_url + self.object_url + "/jobs/" + \
        str(object_id)
    return url

def affected_resource(self, affected_resource):
    url = "https://" + self.gum_ip_addr + ":" + \
        self.port \
        + affected_resource
    return url

def api_version(self):
    url = "https://" + self.gum_ip_addr + ":" + \
        self.port \
        + "/ConfigurationManager/configuration/version"
    return url

def file_upload(self):
    url = self.base_url + self.object_url + \
        "/actions/file-upload/invoke"
    return url

def auditlog_syslog(self):
    url = self.base_url + self.object_url + \
        "/auditlog-syslog-servers" + "/instance"
    return url

```

```
def auditlog_syslog_send_test(self):
    url = self.auditlog_syslog() + \
        "/actions/send-test/invoke"
    return url

def drives(self):
    url = self.base_url + self.object_url + "/drives"
    return url

def drives_parity_group(self, parity_group_id):
    url = self.drives() + "?parityGroupId=" + str(parity_group_id)
    return url

def parity_groups(self):
    url = self.base_url + self.object_url + "/parity-groups"
    return url

def parity_group(self, object_id):
    url = self.parity_groups() + "/" + str(object_id)
    return url

def encryption_keys(self):
    url = self.base_url + self.object_url + "/encryption-keys"
    return url

def encryption_key(self, object_id):
    url = self.encryption_keys() + "/" + str(object_id)
    return url

def encryption_key_file(self):
    url = self.encryption_key("file")
    return url

def encryption_key_file_backup(self):
    url = self.encryption_key_file() + "/actions/backup/invoke"
    return url

def encryption_key_file_restore(self):
    url = self.encryption_key_file() + "/actions/restore/invoke"
    return url
```

Issuing an HTTP request and verifying the status of asynchronous processing

In the REST API, operations such as creating an object or changing its attributes are registered as jobs and run asynchronously. For asynchronous processing, you must confirm that the jobs are complete before obtaining the resource to which the request execution result is applied. In the sample coding, the `invoke_async_command` function is used to issue the request and to perform the processing for waiting for the completion of the jobs. After the method type, URL, and request body are specified, the `invoke_async_command` function issues the request according to the specified method, waits for the completion of the job, and then returns the resource information.

The `invoke_async_command` function is defined in the coding samples for volume allocation, ShadowImage pair operation, and registration of remote storage system information. The following examples show the contents of coding samples for the `invoke_async_command` function.

First, define the function that gets the job status. This function is called by using the `invoke_async_command` function.

```
"""
Check whether the asynchronous command was finished.
@param job_id the job ID to identify
           the asynchronous command
@return r the response data
"""

def check_update(job_id):
    url = block_storage_api.job(str(job_id))
    r = requests.get(url, headers=headers, verify=False)
    return r
```

Next, define the `invoke_async_command` function. Specify the settings so that when a request is generated, the request body is generated in JSON format. Specify the authentication information by using the token obtained when a session was generated.

```
"""
Execute the HTTP request (POST or PATCH)
@param method_type HTTP request method (POST or PATCH)
@param url URL to execute HTTP method
@param body The information of a resource
@return job_result.json()["affectedResources"][0]
           URL of an affected resource
"""

def invoke_async_command(method_type, url, body):
    if method_type == "patch":
        r = requests.patch(url, headers=headers,
                           data=json.dumps(body), verify=False)
    elif method_type == "post":
        r = requests.post(
```

```

        url,
        headers=headers,
        data=json.dumps(body),
        verify=False)
if r.status_code != http.client.ACCEPTED:
    raise requests.HTTPError(r)
print("Request was accepted. JOB URL : " +
      r.json()["self"])

```

After the request is issued, the job status is repeatedly obtained until the job status changes to `Completed`. If the job does not finish before the maximum number of retries specified in the parameter is reached, the processing ends. In addition, if an error occurs for the job, the error code is obtained and the processing ends.

```

status = "Initializing"
job_result = None
retry_count = 1
wait_time = FIRST_WAIT_TIME
while status != "Completed":
    if retry_count > MAX_RETRY_COUNT:
        raise Exception("Timeout Error! "
                        "Operation was not completed.")
    time.sleep(wait_time)
    job_result = check_update(r.json()["jobId"])
    status = job_result.json()["status"]
    double_time = wait_time * 2
    if double_time < 120:
        wait_time = double_time
    else:
        wait_time = 120
    retry_count += 1
if job_result.json()["state"] == "Failed":
    error_obj = job_result.json()["error"]
    if "errorCode" in error_obj:
        if "SSB1" in error_obj["errorCode"]:
            print("Error! SSB code : ",
                  error_obj["errorCode"]["SSB1"],
                  ", ", error_obj["errorCode"]["SSB2"])
        elif "errorCode" in error_obj["errorCode"]:
            print("Error! error code : ",
                  error_obj["errorCode"]["errorCode"])
    raise Exception("Job Error!", job_result.text)

```

After the job is complete and the status changes to `Completed`, the URL of the resource to which the job execution result is applied is obtained. The first result is obtained because only one result is returned to `affectedResources`.

```

print("Async job was succeeded. affected resource : " +
      job_result.json()["affectedResources"][0])
return job_result.json()["affectedResources"][0]

```

Getting status changes for asynchronous processing

The `wait_until_jobstatus_is_changed` function gets the status of the jobs that were asynchronously run by the REST API, waits until the job status changes to the specified execution status, and then returns the resource information. The `wait_until_jobstatus_is_changed` function is defined in the coding samples for a TrueCopy pair operation. The following example shows the contents of coding samples for the `wait_until_jobstatus_is_changed` function.

First, define the function that gets the job status. This function is called by using the `wait_until_jobstatus_is_changed` function.

```
"""
Check whether the asynchronous command was finished.

@param storage_api storage_api
@param job_id the job ID to identify
           the asynchronous command
@param headers the array of the http headers
@return r the response data
"""

def check_update(storage_api, job_id, headers):
    url = storage_api.job(str(job_id))
    r = requests.get(url, headers=headers, verify=False)
    return r
```

Next, define the `wait_until_jobstatus_is_changed` function. For `changed_status`, specify the job status that needs to be detected when a job status has changed to that status. If `True` is specified for `is_retry_count_enabled`, after processing is tried again for the number of times specified in the `MAX_RETRY_COUNT` parameter, a timeout error will be returned. If `False` is specified, processing will wait until a job moves to the specified status.

```
"""
Wait until the job status is changed

@param storage_api storage_api
@param headers the array of the http headers
@param job_id the job ID to identify
           the asynchronous command
@param changed_status job status after waiting
@param is_retry_count_enabled if true, wait
           until MAX_RETRY_COUNT. if false, wait forever
           until job status is changed.
@return job_result.json()["affectedResources"][0]
           URL of an affected resource
"""

def wait_until_jobstatus_is_changed(
```

```

    storage_api,
    headers,
    job_id,
    changed_status,
    is_retry_count_enabled):
status = "Initializing"
retry_count = 1
wait_time = FIRST_WAIT_TIME
while status != changed_status:
    if status == "Completed":
        print("Status was already changed" +
              "to Completed.")
        break
    if is_retry_count_enabled and \
        retry_count > MAX_RETRY_COUNT:
        raise Exception("Timeout Error! "
                        "Operation was not completed.")
    time.sleep(wait_time)
    job_result = check_update(storage_api,
                              job_id, headers)
    status = job_result.json()["status"]
    double_time = wait_time * 2
    if double_time < 120:
        wait_time = double_time
    else:
        wait_time = 120
    retry_count += 1
if job_result.json()["state"] == "Failed":
    error_obj = job_result.json()["error"]
    if "errorCode" in error_obj:
        if "SSB1" in error_obj["errorCode"]:
            print("Error! SSB code : ",
                  error_obj["errorCode"]["SSB1"],
                  ", ", error_obj["errorCode"]["SSB2"])
        elif "errorCode" in error_obj["errorCode"]:
            print("Error! error code : ",
                  error_obj["errorCode"]["errorCode"])
        raise Exception("Job Error!", job_result.text)
print("Async job was succeeded. affected resource : " +
      job_result.json()["affectedResources"][0])
return job_result.json()["affectedResources"][0]

```

Appendix A: Getting configuration information (including additional information) from the storage system cache

You can get configuration information (including additional information) from the storage system cache held on the SVP and update the cache data of storage systems.

About the acquisition of additional information

This section describes the operation to get configuration information, including additional information, from the storage system cache held on the SVP, after you perform an operation such as changing the configuration.

You can perform this operation on the following storage systems:

- VSP 5000 series

The following indicates the configuration when configuration information, including additional information, is obtained from the storage system cache held on the SVP.

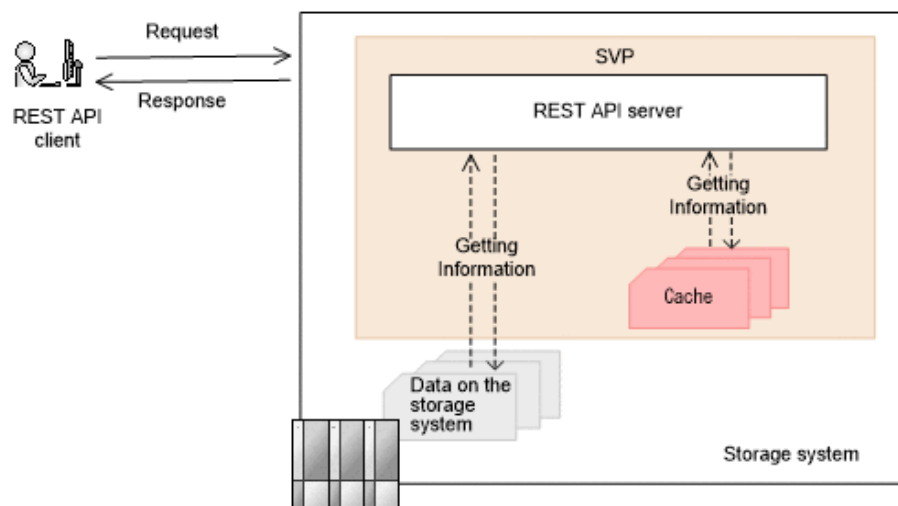

The API requests that get information from the storage system cache can be used to get configuration information including additional information or get information about copy pairs:

- API requests that can get configuration information, including additional information:
 - Summary information about storage systems
 - Channel board information
- API requests that can get configuration information, including additional information, by specifying a query parameter:
 - Information about parity groups
 - Information about external parity groups
 - Information about drives
 - Information about volumes
 - Information about ports
 - Information about pools
 - Information about remote copy groups
 - Information about hardware installed on a storage system[#]
- API requests that can get information about copy pairs:
 - Getting information about all of ShadowImage pairs
 - Getting information about all of Thin Image pairs
 - Getting information about all of remote copy pairs (TrueCopy/Universal Replicator)
 - Getting information about all of remote copy pairs (global-active device)
- API requests that can add and get detailed information about copy pairs, by specifying a query parameter:
 - Getting a list of copy groups (ShadowImage)
 - Getting information about Thin Image pairs in units of snapshot groups
 - Getting a list of remote copy groups (TrueCopy/Universal Replicator)
 - Getting a list of remote copy groups (global-active device)
 - Getting a list of copy groups (Volume Migration)

[#]: Of the information about the hardware installed in the storage system, only additional information is obtained from the storage system cache.

It usually takes from one to five minutes (but can take as long as an hour) before the latest information is applied to the cache. To obtain the latest information, run the API request that updates the cache of storage system configuration information to refresh the cache data, and then run the API request for getting information.

Updating the cache of storage system configuration information

The following API request updates the cache of storage system configuration information.

The procedure for obtaining information about resources after performing operations such as changing the configuration of resources is as follows.

1. Run the API request that changes the configuration of resources described in the explanation about getting additional information.
2. Run the API request that updates the cache of storage system configuration information.

It takes about 10 seconds or longer to update the cache information. Depending on the storage system usage status, it might take as long as 20 minutes to receive a response for this API request. Also, if multiple operations for changing the configuration are running concurrently, it might take a long time to receive a response for this API request.

We recommend that you lock the target resources before running this API request.



Note:

This API request might fail depending on the number of configuration change operations and the number of resources such as LDEVs. If such a failure occurs, the HTTP status code 503 will be returned. In such a case, wait a while, and then run the request again.

3. Run the API request that obtains information about the resources whose configuration has been changed.

Execution permission

Storage Administrator (View)

Request line

```
POST base-URL/v1/services/storage-cache-service/actions/refresh/invoke
```

Request message

Object ID

None.

Query parameters

None.

Body

None.

Response message

Body

None.

Action template

None.

Status codes

For details on the status codes of the request for this operation, see the description of HTTP status codes.

Coding example

```
curl -v -H "Accept:application/json" -H "Content-Type:application/json" -H  
"Authorization:Session d7b673af189048468c5af9bcf3b66b6f" -X POST https://  
192.0.2.100/ConfigurationManager/v1/services/storage-cache-service/actions/  
refresh/invoke -d ""
```

Appendix B: Implementing retry processing

This section describes points to consider when you implement retry processing in scripts that use the REST API.

Implementing retry processing

When you use the REST API to create a client program, implement the retry processing properly so that the program is executed as intended. After executing the retry processing, we recommend that you verify the client program in a system configuration similar to the production environment.

Retry conditions

Sometimes a REST API request cannot be executed, because for example, the network or server is temporarily busy or resources of the storage system are locked. In such cases, you might be able to resume processing of the request by implementing processing to retry failed requests. To determine whether an error can be handled by retrying the request, check the response information, such as HTTP status codes and error codes. The following describes the conditions under which errors can be handled by retrying the failed request.

A request can be retried when one of the following conditions is met:

- The returned HTTP status code is 503 (Service unavailable).
- When a job cannot be executed, RETRY is returned for solutionType of the error object.
- When REST API is used for a long period, the following response is returned (VSP E series, VSP G350, G370, G700, G900, VSP F350, F370, F700, F900).
 1. The HTTP status code is 500, and a response body is returned in HTML format for a several minutes..
 2. When executing the API except discarding the sessions API, a blank response body is returned with the status code 200.

After that, the symptom described in 1. occurs.

In this case, execute the API again until an HTML format response is not returned with the status code 500.

- A specific message ID or an error code of the storage system is returned to the error object.

Whether the error can be handled by retrying the request depends on the error object. You can get the error object from either of the following:

- Response returned when the API request is issued
- Response from the API request that gets job information

| Error object | Message ID | Error codes from the storage system | | |
|---|-------------|-------------------------------------|------|-----------|
| | | SSB1 | SSB2 | errorCode |
| Response returned when the API request is issued | KART00003-E | -- | -- | -- |
| | KART00006-E | | | |
| | KART30003-E | | | |
| | KART30090-E | | | |
| | KART30095-E | | | |
| | KART30096-E | | | |
| | KART30097-E | | | |
| | KART40042-E | | | |
| | KART40049-E | | | |
| | KART40051-E | | | |
| | KART40052-E | | | |
| Response from the API request that gets job information | KART30000-E | 2E11 | 2205 | -- |
| | KART30008-E | -- | -- | -- |
| | KART30072-E | | | |

(Legend)

--: Not applicable

- When the API request is for locking a resource group, a specific message ID or error code is returned to the error object.

The following table describes the retry conditions for the API request that locks a resource group.

| Error object | Message ID | Error codes from the storage system | | |
|---|----------------------------|-------------------------------------|------|-----------|
| | | SSB1 | SSB2 | errorCode |
| Response returned when the API request is issued | -- | -- | -- | -- |
| Response from the API request that gets job information | KART40050-E KART40052-E | -- | -- | -- |
| | KART30000-E | -- | -- | EX_EACCES |

(Legend)

--: Not applicable

Verifying client programs

Verify client programs in a system configuration similar to the production environment.

Verify them from the following viewpoints:

- Whether client programs in which retry conditions are implemented are executable
- Whether client programs end within the expected execution time

If the verification result is not as expected, check and, if necessary, revise the programs from the following viewpoints:

- Adjust the retry count and retry time of clients' API requests.
- Reduce the number of API requests to be executed at the same time, and reduce the retry frequency of clients' API requests.

For VSP E series, VSP G350, G370, G700, G900 or VSP F350, F370, F700, F900, you need to pay attention to the maximum number of concurrent executions for the following API requests. See the estimated maximum number.

| API requests for which the number of concurrent executions is limited | Maximum number of requests that can be executed at the same time |
|--|--|
| API request for getting a list of resource groups | 2 |
| API request for getting volume information (the number of volumes to be obtained: 2,049 or more) | 2 |
| API request for getting port information (when executed with <code>detailInfoType=logins</code> specified in the query) | 2 (number of ports: 8) 1 (number of ports: 40) |
| API request for getting information about host groups or iSCSI targets (when executed without specifying <code>portId</code> as a query parameter) | 13 (number of ports: 32) 6 (number of ports: 80) |
| API request for getting global-active device pair information | 2 |
| API request for getting information about virtual LDEVs (the number of virtual LDEVs to be obtained is 2,049 or more) | 2 |

Appendix C: Operations performed on QoS groups by using REST API requests that include simple in the request line

The following is an overview of REST API requests that include simple in the request line, and describes operations performed on QoS groups by using REST API requests that include simple in the request line. These operations can be performed for VSP 5000 series storage systems.

Overview of REST API requests that include simple in the request line

Review general information about API requests, how to specify managed resources to use REST API requests that include simple in the request line, the information needed to execute an API request, and the information that is output when an API request is executed.

Specifying resources to manage (URL)

For REST API requests that include simple in the request line, the resources to manage must be specified in URL format.

To specify resources to manage, specify the URL in the following format:

```
protocol://host:port/application/version/domain
```

- `protocol`

Specify `https` or `http`.

We recommend specifying `https` for security.

- `host`

Specify the IP address of the SVP or a host name that can be resolved.

- `port`

Specify the port number to use for communication.

The default port number is 443 (for SSL communication) and 80 (for non-SSL communication). The port number can be omitted if the default port number is used for communications.

- `application`

Specify `ConfigurationManager/simple`.



Note:

In this document, `protocol://host:port/ConfigurationManager` is indicated as a base URL.

- `version`

Specify the version of the REST API request that includes `simple` in the request line. Currently, only `v1` can be specified.

- `domain`

Specify the domain. Currently only `objects` can be specified.

The URL formats are as follows.

Under `objects`, specify the type of object on which operations will be performed:

- `performances`
- `qos-groups`

The following tables describe the URL formats supported for object type.

Resources for the object type `performances`:

| URL formats (excluding the base URL) | HTTP method | Processing method | Operations |
|---|-------------|-------------------|--|
| <code>/simple/v1/objects/performances/qos-groups/object-ID</code> | GET | Synchronous | Getting performance information for a specific QoS group |

Resources for the object type qos-groups:

| URL formats (excluding the base URL) | HTTP method | Processing method | Operations |
|---|-------------|-------------------|--|
| /simple/v1/objects/qos-groups | GET | Synchronous | Getting a list of QoS groups |
| /simple/v1/objects/qos-groups/ <i>object-ID</i> | GET | Synchronous | Getting information for a specific QoS group |

REST API requests that include simple in the request line have the following processing methods:

- Synchronous processing

The processing results are returned as the response.

**Note:**

A maximum of 16 requests can be executed at the same time.

Specifying an object ID

An object ID is used to uniquely identify a resource.

An object ID is used when specifying a specific resource in a URL. To specify an object ID, execute the GET operation and then obtain the object ID from the execution results.

Example: If the object ID of a QoS group is 10

```
qos-groups/10
```

**Note:**

When the GET operation is performed to obtain an object ID, the REST API server sometimes returns a value encoded according to RFC 3986, as the value of the attribute obtained by the GET operation. To use the object ID obtained by performing the GET operation in a request of another operation, use the object ID without decoding it.

Supported HTTP methods

Specify operations to perform on resources in the HTTP method.

REST API requests that include simple in the request line support the following HTTP methods.

| HTTP method | Description |
|-------------|---|
| GET | <p>This method gets object information. Alternatively, this method gets a list of objects.</p> <p>When information about multiple objects is obtained, the information is not sorted by object ID . For this reason, filter the information to obtain by specifying query parameters. Alternatively, if you know the object IDs of the objects for which you want to get information, run the API request for obtaining information about specific objects.</p> |

Request headers

Request headers are request messages sent from REST API clients to the REST API server.

The following table lists the request headers supported by REST API requests that include simple in the request line.

| Header | Category | Description |
|-----------------|----------|---|
| Accept | Optional | <p>Specifies the media type of the response.</p> <p>Specifiable value: */* (json)</p> <p>Default value: */* (json)</p> |
| Accept-Language | Optional | <p>Specifies the language of the messages received by the client.</p> <p>Specify ja to set the language to Japanese. If any language other than Japanese is specified, or if this header is omitted, the language will be set to English (en).</p> |
| Content-Type | Optional | <p>Specifies the media type of the request body.</p> <p>Specifiable value: application/json</p> <p>Default value: application/json</p> |
| Content-Length | Optional | <p>Specifies the size of the request body.</p> <p>You can specify the Content-Length header when specifying a request body. This header is automatically assigned depending on the specifications of the client software.</p> <p>Specifiable value: Specify the header, in bytes.</p> <p>Default value: None.</p> |

| Header | Category | Description |
|---------------|----------|--|
| Authorization | Required | <p>Specifies the authorization method and authorization credentials.</p> <p><i>Session token</i></p> <p>Specify a token that was obtained when the session was generated.</p> <p>For details about how to use the API request for generating sessions, see the description of the following API request.</p> <p>POST <i>base-URL/v1/objects/sessions</i></p> |

If a header other than the above is specified, the specified header is ignored.

Response headers

The response headers are response messages from the REST API server to REST API clients.

The following table describes the response headers returned by the REST API server.

| Header | Description |
|-------------------|---|
| Content-Type | <p>Indicates the media type of the response data.</p> <p>Default: <code>application/json; charset=UTF-8</code></p> |
| Content-Length | <p>Indicates the size of the response data.</p> <p>If the size of the response data is large, instead of this header, <code>Transfer-Encoding: chunked</code> is returned, indicating that the response data has been divided and then transferred.</p> |
| Transfer-Encoding | <p>Indicates the encoding format used when the response data was transferred.</p> <p>When a large amount of response data is divided and then transferred, <code>chunked</code> is returned.</p> |
| Retry-After | <p>Indicates the recommended wait time (in seconds) before the request can be retried.</p> <p>When the HTTP status code 503 is returned, this header is sometimes set.</p> |
| WWW-Authenticate | <p>Indicates that authentication is required when the HTTP status code 401 is returned.</p> |

| Header | Description |
|--------|--|
| | Default: <ul style="list-style-type: none"> ▪ Authentication by using a session <pre>Session realm="Block storage"</pre> |

HTTP status codes

REST API requests that include simple in the request line use the following standard HTTP status codes to indicate the processing results.

| HTTP status codes | Description |
|-------------------|--|
| 200 | OK The request was processed correctly. |
| 400 | Bad Request The request header, the query parameter, the object ID, or the request body is invalid. |
| 401 | Unauthorized The Authorization header is not specified in the request header. Alternatively, authentication by using the information specified in the Authorization header fails. |
| 403 | Forbidden You do not have the permission required to perform the operation. |
| 404 | Not Found The resource specified by the URL could not be found. Alternatively, there are no resources for the specified URL. |
| 406 | Not acceptable The media type specified in the Accept header is not supported. |
| 415 | Unsupported Media Type The specified media type is not supported. |
| 500 | Internal Server Error An internal error occurred on the server. Only the most critical error is returned. |
| 503 | Service Unavailable |

| HTTP status codes | Description |
|-------------------|---|
| | <p>Indicates that the service is temporarily unavailable because it is busy or under maintenance. Only the most critical error is returned.</p> <p>If the response header includes <code>Retry-After</code>, wait for the period of time indicated by the return value (the recommended wait time, given in seconds), and then run the request again.</p> |
| 504 | <p>Gateway Timeout</p> <p>No response was received from the device in the allotted time. Only the most critical error is returned.</p> |

Request and response formats

JSON format is used for getting the results of resource information (GET).

The supported character encoding is UTF-8.

Request format

- If you specified a null character for a string-type attribute, the value of the attribute is assumed to be null.
- If you specified a null character for an attribute whose type is not string, the attribute is assumed to be unspecified.

Response format

- If the API processing succeeds, a response is returned in JSON format.
- If the processing fails, depending on the contents of the error, a response in HTML format, instead of JSON format, might be returned.

To resolve the error based on the HTTP status code in the program, check the value of Content-Type in the response header.

Query parameters

If the GET method is used to obtain an object, query parameters can be specified to filter the execution results based on specific conditions.

Query parameters can be specified at the end of the URL in the following format:

```
?parameter=value
```

To specify multiple parameters, concatenate them by using ampersands (&). Multiple parameters are specified in the following example:

```
?parameter=value&parameter=value...
```

For details on parameters that can be specified for queries, see the section explaining the specific API request.

Parameters are case-sensitive. If you specify a parameter other than those that can be specified for each API, the invalid parameter is ignored, and only the valid parameters are used to filter the execution results.

Data type

This section describes the data types that can be specified by using REST API requests that include simple in the request line.

The following table shows the data types supported by REST API requests that include simple in the request line and the corresponding JSON data types.

| Data type | JSON type | Description |
|---------------|-----------|---|
| boolean | boolean | A type that represents <code>true</code> or <code>false</code> . Example: <code>true</code> |
| int | number | A type that represents a 32-bit signed integer. Example: <code>100</code> |
| long | number | A type that represents a 64-bit signed integer. Example: <code>1048576</code> |
| string | string | A type that represents a character string. Example: <code>"DKR5D-J900SS"</code> |
| ISO8601string | string | A type that represents time in the ISO 8601 extended format (<code>YYYY-MM-DDThh:mm:ssZ</code>). The only time zone that you can specify is UTC. Example: <code>"2017-09-30T09:27:35Z"</code> |

In addition to the preceding data types, the following JSON data types are also used:

Object type

The character string, in which the attribute and value are connected with a colon (:), is enclosed in { and }. If more than one attribute-value pair exists, the pairs are separated by commas.

Array type

The character string, in which multiple values are separated by commas, is enclosed in [and].

Output format

After an API request is issued, a response is returned based on the API processing method, the API processing type, and the execution result.

The following table shows the response output formats when the processing of the request is successful.

| API processing method | API processing type | Status code of the execution result | Output format |
|------------------------|--------------------------------|-------------------------------------|--|
| Synchronous processing | GET (getting a single object) | 200 | See the description in the response message for each API function. |
| | GET (getting multiple objects) | 200 | Data object |

If the processing of the request fails, an error object is returned as a response.

Data object

Data object is an object for returning the object list.

The following table shows the data object schema.

| Attribute | Data type | Description |
|-----------|-----------|-------------|
| data | array | Object list |

The following attributes are displayed along with the data object.

| Attribute | Data type | Description |
|-----------|-----------|-------------------|
| count | int | Number of objects |

Error object

The following describes the error object that is returned together with an HTTP status code if an error occurs during the processing of a request.

The following table explains the schema of an error object.

| Attribute | Data type | Description |
|-------------|-----------|---|
| errorSource | string | URL where the error occurs |
| messageld | string | Message ID |
| message | string | Content of the error message |
| cause | string | Cause of the error |
| solution | string | Solution to the error |
| errorCode | string | <p>Error code from the storage system</p> <p>A value is returned only if an error occurs in the storage system.</p> <p>The error codes are as follows:</p> <ul style="list-style-type: none"> ▪ SSB1 code ▪ SSB2 code <p>Storage system error codes are required for maintenance of the storage system.</p> |

The following is an example of an error object when an error occurs:

```
{
  "errorSource": "/ConfigurationManager/simple/v1/objects/qos-groups/10",
  "messageId": "KART70006-E",
  "message": "The specified resource does not exist or is an unmanaged
resource. If you are accessing an unmanaged resource, use other management
interfaces."
}
```

Operations on QoS groups

Gain an understanding about operations on QoS groups performed by using REST API requests that include simple in the request line.



Important: For details on common specifications (how to specify resources, the information required to run an API request, and information that can be checked by running the API request) for running REST API requests that include simple in the request line, see the overview of REST API requests in the appendix.

Getting a list of QoS groups

This request gets a list of QoS group information.

Appendix C: Operations performed on QoS groups by using REST API requests that include simple in the request line

**Note:**

This API request can be used when the storage system is VSP 5000 series.

Execution permission

Storage Administrator (View Only)

Request line

```
GET base-URL/simple/v1/objects/qos-groups
```

Request message**Object ID**

None.

Query parameters

None.

Body

None.

Response message**Body**

```
{
  "data": [
    {
      "id": 10,
      "threshold": {
        "isUpperIopsEnabled": false,
        "isUpperTransferRateEnabled": false
      },
      "alertSetting": {
        "isUpperAlertEnabled": false
      },
      "alertTime": {}
    },
    {
      "id": 200,
      "threshold": {
        "isUpperIopsEnabled": true,
        "upperIops": 2000,
        "isUpperTransferRateEnabled": true,
        "upperTransferRate": 20000
      },
      "alertSetting": {
```

```

        "isUpperAlertEnabled": true,
        "upperAlertAllowableTime": 10
    },
    "alertTime": {
        "upperAlertTime": "2020-10-21T07:10:17Z"
    }
}
],
"count": 2
}

```

| Attribute | Type | Description |
|-----------|--------|---|
| id | int | ID of the QoS group |
| threshold | object | <p>Information about the QoS settings of the QoS group</p> <ul style="list-style-type: none"> ▪ <code>isUpperIopsEnabled</code> (boolean) Whether the upper limit on the IOPS is enabled <ul style="list-style-type: none"> • true: Enabled • false: Disabled ▪ <code>upperIops</code> (int) Upper limit on the IOPS This information is not output if <code>isUpperIopsEnabled</code> is false. ▪ <code>isUpperTransferRateEnabled</code> (boolean) Whether the upper limit on the amount of data that can be transferred is enabled <ul style="list-style-type: none"> • true: Enabled • false: Disabled ▪ <code>upperTransferRate</code> (int) Upper limit on the amount of data that can be transferred per second (Mbps) This information is not output if <code>isUpperTransferRateEnabled</code> is false. |

| Attribute | Type | Description |
|--------------|--------|--|
| alertSetting | object | <p>Information about the alert settings of the QoS group</p> <ul style="list-style-type: none"> ▪ <code>isUpperAlertEnabled</code> (boolean) Whether alerts are output if the IOPS or the amount of data transferred not achieve the upper limit for a continuous period of time <ul style="list-style-type: none"> • <code>true</code>: Output • <code>false</code>: Not output ▪ <code>upperAlertAllowableTime</code> (int) Amount of time to wait before issuing an alert when an upper limit is exceeded for a continuous period of time (in seconds) This information is not output if <code>isUpperAlertEnabled</code> is <code>false</code>. |
| alertTime | object | <p>The time[#] when an alert was issued for the QoS group</p> <ul style="list-style-type: none"> ▪ <code>upperAlertTime</code> (ISO8601string) Time when the last alert was issued because the IOPS or the amount of data transferred per second had exceeded the upper limit for a continuous period of time (UTC) |

[#]: If you change the time zone of the storage system, the times displayed for alerts that were issued before the change will be invalid.

Status codes

For details on the status codes of the API, see the description on HTTP status codes.

Coding example

```
curl -v -H "Accept:application/json" -H "Content-Type:application/json" -H
"Authorization:Session b74777a3f9f04ea8bd8f09847fac48d3" -X GET https://
192.0.2.100/ConfigurationManager/simple/v1/objects/qos-groups
```

Getting information for a specific QoS group

This request gets information about QoS group.



Note:

This API request can be used when the storage system is VSP 5000 series.

Execution permission

Storage Administrator (View Only)

Request lineGET *base-URL/simple/v1/objects/qos-groups/object-ID***Request message****Object ID**

Specify the value of `id` that is obtained when you get information about the QoS group.

| Attribute | Type | Description |
|-----------|------|--------------------------------|
| id | int | (Required) ID of the QoS group |

Query parameters

| Parameter | Type | Description |
|---------------|---------|--|
| withVolumelds | boolean | (Optional) Specify whether to get information about the LDEV numbers that belong to the QoS group. <ul style="list-style-type: none"> ▪ <code>true</code>: Obtain the LDEV numbers. ▪ <code>false</code>: Do not obtain the LDEV numbers. If this value is omitted, <code>false</code> is assumed. |

Body

None.

Response message**Body**

```
{
  "id": 200,
  "threshold": {
    "isUpperIopsEnabled": true,
    "upperIops": 2000,
    "isUpperTransferRateEnabled": true,
    "upperTransferRate": 20000
  },
  "alertSetting": {
```

```

    "isUpperAlertEnabled": true,
    "upperAlertAllowableTime": 10
  },
  "alertTime": {
    "upperAlertTime": "2020-10-21T07:10:17Z"
  },
  "volumeIds": [
    10000,
    10001
  ]
}

```

| Attribute | Type | Description |
|-----------|--------|---|
| id | int | ID of the QoS group |
| threshold | object | <p>Information about the QoS settings of the QoS group</p> <ul style="list-style-type: none"> ▪ <code>isUpperIopsEnabled</code> (boolean) Whether the upper limit on the IOPS is enabled: <ul style="list-style-type: none"> • true: Enabled • false: Disabled ▪ <code>upperIops</code> (int) Upper limit on the IOPS This information is not output if <code>isUpperIopsEnabled</code> is false. ▪ <code>isUpperTransferRateEnabled</code> (boolean) Whether the upper limit on the amount of data that can be transferred is enabled: <ul style="list-style-type: none"> • true: Enabled • false: Disabled ▪ <code>upperTransferRate</code> (int) Upper limit on the amount of data that can be transferred per second (MBps) This information is not output if <code>isUpperTransferRateEnabled</code> is false. |

| Attribute | Type | Description |
|--------------|--------|---|
| alertSetting | object | <p>Information about the alert settings of the QoS group</p> <ul style="list-style-type: none"> ▪ <code>isUpperAlertEnabled</code> (boolean) Whether alerts are output if the IOPS or the amount of data transferred not achieve the upper limit for a continuous period of time: <ul style="list-style-type: none"> • <code>true</code>: Output • <code>false</code>: Not output ▪ <code>upperAlertAllowableTime</code> (int) Amount of time to wait before issuing an alert when an upper limit is exceeded for a continuous period of time (in seconds) This information is not output if <code>isUpperAlertEnabled</code> is <code>false</code>. |
| alertTime | object | <p>The time[#] when an alert was issued for the QoS group</p> <ul style="list-style-type: none"> ▪ <code>upperAlertTime</code> (ISO8601string) Time when the last alert was issued because the IOPS or the amount of data transferred per second had exceeded the upper limit for a continuous period of time (UTC) |
| volumelds | int[] | <p>The LDEV numbers that belong to the QoS group</p> <p>This attribute is displayed only if you specified <code>true</code> for <code>withVolumeIds</code> in the query parameters.</p> |

[#]: If you change the time zone of the storage system, the times displayed for alerts that were issued before the change will be invalid.

Status codes

For details on the status codes of the API, see the description on HTTP status codes.

Coding example

```
curl -v -H "Accept:application/json" -H "Content-Type:application/json" -H
"Authorization:Session d7b673af189048468c5af9bcf3b6bb6f" -X GET https://
192.0.2.100/ConfigurationManager/simple/v1/objects/qos-groups/200?
withVolumeIds=true
```

Getting performance information for a specific QoS group

The following request gets performance information about a QoS group for the specified QoS group ID.



Note:

This API request can be used when the storage system is VSP 5000 series.

Execution permission

Storage Administrator (View Only)

Request line

```
GET base-URL/simple/v1/objects/performances/qos-groups/object-ID
```

Request message

Object ID

Specify the value of `id` that is obtained when you get information about the QoS group.

| Attribute | Type | Description |
|-----------|------|--------------------------------|
| id | int | (Required) ID of the QoS group |

Query parameters

None.

Body

None.

Response message

Body

```
{
  "id": 10,
  "receivedCommands": 0,
  "transferRateOfReceivedCommands": 0,
  "iops": 0,
  "transferRate": 0,
  "responseTime": 0,
  "monitorTime": "2020-10-08T05:54:07Z"
}
```

| Attribute | Type | Description |
|--------------------------------|---------------|---|
| id | int | ID of the QoS group |
| receivedCommands | int | Number of commands received from hosts (IOPS) |
| transferRateOfReceivedCommands | int | Amount of data transferred by commands received from hosts (KBps) |
| iops | int | Number of commands processed by the storage system (IOPS) |
| transferRate | int | Amount of transferred data processed by the storage system (KBps) |
| responseTime | long | Response time (microseconds) |
| monitorTime | ISO8601string | Time at which the performance information was obtained (UTC) |

Status codes

For details on the status codes of the API, see the description on HTTP status codes.

Coding example

```
curl -v -H "Accept:application/json" -H "Content-Type:application/json" -H
"Authorization:Session d7b673af189048468c5af9bcf3b66b6f" -X GET https://
192.0.2.100/ConfigurationManager/simple/v1/objects/performances/qos-
groups/10
```

Appendix D: Notes and restrictions

The following restrictions apply when using the REST API.

Notes and restrictions

Notes on the VSP N series

In this manual, the phrase "VSP Gx00 models, VSP Fx00 models" should be interpreted to also include the following storage system models: VSP N400, VSP N600, VSP N800.

Executing an asynchronous processing API function to the REST API server

When a user executes an asynchronous processing API function job that takes two hours or more to process, the KART30031-E error occurs and the job fails.

This problem occurs if the user executes an API function command to perform one of the following tasks and the job takes two hours or more to complete.

- Deleting a journal volume from a journal
- Formatting a volume
- Shredding a volume
- Formatting a parity group
- Deleting a parity group
- Initializing the capacity-saving function for a pool
- Shrinking a pool
- Restoring a pool
- Relocating a pool

Even though the KART30031-E error occurs, the request might have succeeded. Confirm the status of the resources.

Display of the pair concordance rate and the processing progress rate in the Thin Image pair information

If all of the following conditions are met, the `progressRate` attribute, which indicates the progress of processing, is displayed:

- The `isClone` attribute of the pair is set to `false`.
- The `canCascade` attribute of the pair is set to `false`.
- The pair status is `COPY`, `RCPY`, `SMPP`, or `PSUP`.

In the above case, the value displayed for the `progressRate` attribute is actually the value of the `concordanceRate` attribute.

Problems related to the synchronization of the date and time between the NTP server and the storage system in REST API

A difference of several hours between the storage system's date and time and the NTP server's date and time occurs if all of the following conditions are met:

- A time zone for which daylight saving time is supported is set.
- Automatic adjustment of daylight saving time is enabled.
- You synchronize the storage system with the NTP server during the transition period from standard time to daylight saving time or the transition period from daylight saving time to standard time.

To recover from this problem, synchronize with the NTP server again after the transition period from standard time to daylight saving time or the transition period from daylight saving time to standard time.

Problems related to automatic adjustments for daylight saving time in the date and time of the storage system in REST API

The symptoms of this problem occur if all of the following conditions are met:

- A time zone for which daylight saving time is supported is set.
- Automatic adjustment of daylight saving time is enabled.

Symptom 1:

- An NTP server synchronization time that was set during standard time incorrectly changes to one hour earlier than the actual time when daylight saving time begins.
- An NTP server synchronization time that was set during daylight saving time incorrectly changes to one hour later than the actual time when daylight saving time ends.

To resolve this problem, reset the NTP server synchronization time by re-executing the API function to change the date and time of the storage system after daylight saving time begins or ends.

Symptom 2:

- When the date and time of the REST server is in daylight saving time and the date and time of the storage system is in standard time, a time one hour earlier than the time you request as the time of synchronization with the NTP server is set as the synchronization time for the storage system.
- When the date and time of the REST server is in standard time and the date and time of the storage system is in daylight saving time, a time one hour later than the time you request as the time of synchronization with the NTP server is set as the synchronization time for the storage system.

To resolve this problem, set the same date and time for the REST server and the NTP server, and then re-set the NTP server synchronization time by re-executing the API function to change the date and time of the storage system.

Error on the API which multiple operations are performed internally

If the error occurred by using the following API, a part of the resource might be created.

- HDT pool creation

When the error occurred, check the status of the resource, delete the resource created partially, and perform the API again.

Creating Thin Image pairs

If the following conditions are met, attempts to create Thin Image pairs fail, and the KART00000-E message is output.

1. The specified snapshot group name is already being used for another snapshot group.
2. The API command to create a Thin Image pair is executed when the API command to delete a Thin Image pair is executed at the same time, and both APIs are using the same `pvolLdevId` attribute without `svolLdevId` attribute.

If this problem occurs, re-execute the API command to create a Thin Image pair.

Restriction that applies when the maximum number of storage system resources is exceeded as a result of resource creation

If the maximum number of resources already exist on the storage system and you use one of the following API commands to create a new resource, the job might fail and the KART30013-E message might be output:

- Creating a host group (without specifying `hostGroupNumber`)
- Creating an LU path (without specifying `lun`)

If an error occurs and the KART30013-E message is output, obtain a list of the target resources and then check whether the number of the existing resources has reached the maximum number of resources allowed on the storage system. For details about the maximum number of resources that can be created on a storage system, see the *Provisioning Guide*.

Creating Thin Image pair

Creating Thin Image pair API may fail with KART40188-E or KART4009-E when `clonesAutomation=true` or `autoSplit=true` is specified.

Execute cloning Thin Image pair API or storing snapshot data API after confirming if pair status of Thin Image is "PAIR".

Getting a list of external path groups

When getting a list of external path groups in an environment where number of external path is 10000 or more, all of the information may not be obtained.

Perform the follow actions after checking the `nextPageHeadPathGroupId` in the external path group:

- When the value of `nextPageHeadPathGroupId` is other than `-1`, execute the getting list of external path group API with specifying the value of `nextPageHeadPathGroupId` by the value of the previous `headPathGroupId`, and obtain the list of the external path groups in the range that could not be acquired.
- When the value of `nextPageHeadPathGroupId` is `-1`, no additional action is required.

affectedResources when a job is executed by using the REST API

When any of the following operations is executed, `affectedResources` displays an incorrect URL.

- Unmapping an external volume

```
DELETE base-URL/v1/objects/external-parity-groups/object-ID
```

- Removing an external path from an external path group

```
POST base-URL/v1/objects/external-path-groups/object-ID/actions/remove-path/invoke
```

- Disconnecting from an external volume

```
POST base-URL/v1/objects/external-parity-groups/object-ID/actions/disconnect/invoke
```

- Performing migration

```
POST base-URL/v1/objects/local-clone-copypairs/object-ID/actions/migrate/invoke
```

- Performing migration for an entire copy group

```
POST base-URL/v1/objects/local-clone-copygroups/object-ID/actions/migrate/invoke
```

To check whether the above operations were successful, execute the following APIs.

- Unmapping an external volume

```
GET base-URL/v1/objects/external-path-groups
```

- Removing an external path from an external path group

```
GET base-URL/v1/objects/external-path-groups/object-ID
```

- Disconnecting from an external volume

```
GET base-URL/v1/objects/external-path-groups
```

- Performing migration #

```
GET base-URL/v1/objects/local-clone-copypairs/object-ID
```

- Performing migration for an entire copy group #

```
GET base-URL/v1/objects/local-clone-copygroups/object-ID
```

#: The possible pair statuses are as follows.

If the pair status is PSUS: Migration succeeded.

If the pair status is PSUE: Migration failed.

Device group name

Do not specify "dummydevgroup" as a device group name.

If "dummydevgroup" is specified as a device group name, API response takes much time, or error might occur with KART20022-E message.

Recovery procedure when REST API doesn't respond for a long period (VSP E series, VSP G350, G370, G700, G900, VSP F350, F370, F700, F900)

When REST API doesn't respond for a long period, reboot the GUM that the CTL has a problem by using maintenance utility. If REST API still doesn't respond after GUM is rebooted, detailed investigation is required. Collect the normal dump and contact the support center.

Copy group names and device group names for copy groups, and snapshot group IDs for snapshot groups

If any attribute of the following object IDs contains a comma ("," or "%2c"), the KART40014-E error occurs when an API for managing copy groups or snapshot groups is executed:

- pvolDeviceGroupName
- svolDeviceGroupName
- localDeviceGroupName
- remoteDeviceGroupName
- copyGroupName
- copyPairName
- snapshotGroupId

Note that, when an object ID includes commas for combining attribute values, such commas do not cause the KART40014-E error.

About the operation of the pair

Do not register a pair with the same device group, when operating a pair over 2,048.

Divide the different device group, when create a pair over 2,048.

API operating a storage system becomes slow or fails to error in KART20022-E, when create a pair over 2,048 in the same device group.

Get list of remote copy groups limitations on running the API with the query "detailInfoType = Pair"

In case that the remote Storage System is one of VSP E series, VSP G350, G370, G700, G900, VSP F350, F370, F700, F900, some attributes are not displayed.

- If the volume on the Remote Storage System is P-VOL, the following attributes are not displayed:
 - pvolStatus
 - pvolIOMode
 - copyPace
- If the volume on the Remote Storage System is S-VOL, the following attributes are not displayed:
 - svolStatus
 - svolIOMode

In case that a remote Storage system is one of Virtual Storage Platform, HUS VM, do not displayed some attributes of the TrueCopy pair.

- If the volume on the Remote Storage System is P-VOL, the following attributes are not displayed:
 - pvolStatus
 - copyPace
- If the volume on the Remote Storage System is S-VOL, the following attributes are not displayed:
 - svolStatus

Note on the management of VSP 5000 series storage systems

If an API request is executed during controller maintenance or when a controller failure has occurred, the API request might fail, and one of the following error messages might be output: KART40047-E, KART30102-E, KART30011-E, KART00007-E or KART20022-E.

If an error occurs, wait until the maintenance work is complete, and then execute the API request again.

The problem persists with KART30043-E after you handled solutions.

If the problem persists after you handled solutions that is described in KART30043-E, confirm the storage system supports functions you are trying to retrieve or perform.

Notes when a resource is locked after a specific REST API fails.

If the resource is still locked after the following REST API fails to run, unlock the resource forcibly by using Storage Navigator.

- PATCH *base-URL/v1/objects/auditlog-syslog-servers/instance*
- POST *base-URL/v1/objects/clprs*
- DELETE *base-URL/v1/objects/clprs/object-ID*
- PATCH *base-URL/v1/objects/clprs/object-ID*
- POST *base-URL/v1/objects/actions/file-upload/invoke*
- PATCH *base-URL/v1/objects/journals/object-ID*
- POST *base-URL/v1/objects/resource-groups*
- DELETE *base-URL/v1/objects/resource-groups/object-ID*
- POST *base-URL/v1/objects/resource-groups/object-ID/actions/add-resource/invoke*
- POST *base-URL/v1/objects/resource-groups/object-ID/actions/remove-resource/invoke*
- PATCH *base-URL/v1/objects/snmp-settings/instance*
- POST *base-URL/v1/objects/users*
- DELETE *base-URL/v1/objects/users/object-ID*
- PATCH *base-URL/v1/objects/users/object-ID*
- POST *base-URL/v1/objects/users/object-ID/actions/add-user-group/invoke*

- POST *base-URL/v1/objects/users/object-ID/actions/remove-user-group/invoke*
- POST *base-URL/v1/objects/user-groups*
- DELETE *base-URL/v1/objects/user-groups/object-ID*
- PATCH *base-URL/v1/objects/user-groups/object-ID*
- POST *base-URL/v1/objects/user-groups/object-ID/actions/add-resource-group/invoke*
- POST *base-URL/v1/objects/user-groups/object-ID/actions/remove-resource-group/invoke*

Adding resources to or removing resources from a resource group that is a virtual storage machine (VSP 5000 series, VSP E series, VSP G350, G370, G700, G900, VSP F350, F370, F700, F900)

When the resources that include a host group, an iSCSI target, or an LDEV to which an LU path is mapped are added to or removed from a resource group that is a virtual storage machine, the following API requests fail with the KART40206-E error.

Delete the LU path before executing these API requests.

Applicable API requests:

- Adding a resource to a resource group
POST *base-URL/v1/objects/resource-groups/object-ID/actions/add-resource/invoke*
- Removing a resource from a resource group
POST *base-URL/v1/objects/resource-groups/object-ID/actions/remove-resource/invoke*

Creating a resource group by specifying a virtual storage machine on VSP E series

To create a resource group by specifying a virtual storage machine on VSP E series, specify `virtualStorageDeviceId` instead of `virtualStorageId`.

Applicable API request:

- Creating a resource group
POST *base-URL/v1/objects/resource-groups*

The `ipAddress` attribute of the API for getting a list of sessions

The `ipAddress` attribute of the API for getting a list of sessions might not display a string (the content of the X-Forwarded-For header received by the REST API server) that is a concatenation of the IP addresses of the client and an intermediate server. Reference this attribute only when referencing the IP address of a client that communicated directly with the REST API server.

Setting TLS for storage system of VSP 5100, 5500, 5100H, 5500H

If TLS1.2 is disabled for VSP 5100, 5500, 5100H, 5500H, attempts to perform a remote copy operation on a combination of the VSP E series, VSP G350, G370, G700, G900, VSP F350, F370, F700, F900 and the VSP 5100, 5500, 5100H, 5500H fail with KART40097-E or KART40098-E.

When you run those operations, set the TLS1.2.

To perform TLS settings on storage system of the VSP 5100, 5500, 5100H, 5500H, see *Setting SSL/TLS communications using Device Manager - Storage Navigator* in the *System Administrator Guide for VSP 5000 series*.

Applicable API request:

- POST *base-URL/v1/objects/remote-storages*
- DELETE *base-URL/v1/objects/remote-storages/object-ID*
- GET *base-URL/v1/objects/remote-mirror-copygroups*
- GET *base-URL/v1/objects/remote-mirror-copygroups/object-ID*
- DELETE *base-URL/v1/objects/remote-mirror-copygroups/object-ID*
- GET *base-URL/v1/objects/remote-mirror-copygroups/object-ID/actions/split*
- POST *base-URL/v1/objects/remote-mirror-copygroups/object-ID/actions/split/invoke*
- GET *base-URL/v1/objects/remote-mirror-copygroups/object-ID/actions/resync*
- POST *base-URL/v1/objects/remote-mirror-copygroups/object-ID/actions/resync/invoke*
- POST *base-URL/v1/objects/remote-mirror-copygroups/object-ID/actions/takeover/invoke*
- GET *base-URL/v1/objects/remote-mirror-coppairs/object-ID*
- POST *base-URL/v1/objects/remote-mirror-coppairs*
- DELETE *base-URL/v1/objects/remote-mirror-coppairs/object-ID*
- GET *base-URL/v1/objects/remote-mirror-coppairs/object-ID/actions/split*
- POST *base-URL/v1/objects/remote-mirror-coppairs/object-ID/actions/split/invoke*
- GET *base-URL/v1/objects/remote-mirror-coppairs/object-ID/actions/resync*
- POST *base-URL/v1/objects/remote-mirror-coppairs/object-ID/actions/resync/invoke*
- POST *base-URL/v1/objects/remote-mirror-coppairs/object-ID/actions/takeover/invoke*

Hitachi Vantara



Corporate Headquarters
2535 Augustine Drive
Santa Clara, CA 95054 USA
HitachiVantara.com | community.HitachiVantara.com

Contact Information
USA: 1-800-446-0744
Global: 1-858-547-4526
HitachiVantara.com/contact