

# Hitachi Virtual Storage Platform G400, G600

83-05-2x

---

## Hardware Reference Guide

This document provides information about the system hardware components, mechanical, and environmental specifications for the Hitachi Virtual Storage Platform G400 and VSP G600 storage systems.

© 2015, 2021Hitachi, Ltd. All rights reserved.

No part of this publication may be reproduced or transmitted in any form or by any means, electronic or mechanical, including copying and recording, or stored in a database or retrieval system for commercial purposes without the express written permission of Hitachi, Ltd., or Hitachi Vantara LLC (collectively "Hitachi"). Licensee may make copies of the Materials provided that any such copy is: (i) created as an essential step in utilization of the Software as licensed and is used in no other manner; or (ii) used for archival purposes. Licensee may not make any other copies of the Materials. "Materials" mean text, data, photographs, graphics, audio, video and documents.

Hitachi reserves the right to make changes to this Material at any time without notice and assumes no responsibility for its use. The Materials contain the most current information available at the time of publication.

Some of the features described in the Materials might not be currently available. Refer to the most recent product announcement for information about feature and product availability, or contact Hitachi Vantara LLC at [https://support.hitachivantara.com/en\\_us/contact-us.html](https://support.hitachivantara.com/en_us/contact-us.html).

**Notice:** Hitachi products and services can be ordered only under the terms and conditions of the applicable Hitachi agreements. The use of Hitachi products is governed by the terms of your agreements with Hitachi Vantara LLC.

By using this software, you agree that you are responsible for:

1. Acquiring the relevant consents as may be required under local privacy laws or otherwise from authorized employees and other individuals; and
2. Verifying that your data continues to be held, retrieved, deleted, or otherwise processed in accordance with relevant laws.

**Notice on Export Controls.** The technical data and technology inherent in this Document may be subject to U.S. export control laws, including the U.S. Export Administration Act and its associated regulations, and may be subject to export or import regulations in other countries. Reader agrees to comply strictly with all such regulations and acknowledges that Reader has the responsibility to obtain licenses to export, re-export, or import the Document and any Compliant Products.

Hitachi and Lumada are trademarks or registered trademarks of Hitachi, Ltd., in the United States and other countries.

AIX, AS/400e, DB2, Domino, DS6000, DS8000, Enterprise Storage Server, eServer, FICON, FlashCopy, GDPS, HyperSwap, IBM, Lotus, MVS, OS/390, PowerHA, PowerPC, RS/6000, S/390, System z9, System z10, Tivoli, z/OS, z9, z10, z13, z14, z/VM, and z/VSE are registered trademarks or trademarks of International Business Machines Corporation.

Active Directory, ActiveX, Bing, Excel, Hyper-V, Internet Explorer, the Internet Explorer logo, Microsoft, the Microsoft Corporate Logo, MS-DOS, Outlook, PowerPoint, SharePoint, Silverlight, SmartScreen, SQL Server, Visual Basic, Visual C++, Visual Studio, Windows, the Windows logo, Windows Azure, Windows PowerShell, Windows Server, the Windows start button, and Windows Vista are registered trademarks or trademarks of Microsoft Corporation. Microsoft product screen shots are reprinted with permission from Microsoft Corporation.

All other trademarks, service marks, and company names in this document or website are properties of their respective owners.

Copyright and license information for third-party and open source software used in Hitachi Vantara products can be found at <https://www.hitachivantara.com/en-us/company/legal.html>.

---

# Contents

<b>Preface.....</b>	<b>6</b>
Intended audience.....	6
UEFI Development Kit 2010.....	6
Product version.....	7
Release notes.....	7
Changes in this revision.....	7
Document conventions.....	7
Conventions for storage capacity values.....	9
Accessing product documentation.....	10
Getting help.....	10
Comments.....	10
<b>Chapter 1: Hitachi Virtual Storage Platform G400, G600 hardware overview.....</b>	<b>11</b>
Block configuration.....	11
Unified configuration.....	12
VSP G400 model.....	12
VSP G600 model.....	15
Features.....	18
Scalability.....	19
Examples of supported VSP G400 configurations.....	19
Examples of supported VSP G600 configurations.....	19
Maximum number of mounted drive trays.....	20
<b>Chapter 2: Virtual Storage Platform G400, G600 controller.....</b>	<b>23</b>
CBLM controller.....	23
CBLM with front panel bezel.....	23
CBLM front panel LEDs (without bezel).....	24
CBLM rear panel.....	26
CBLM power supply unit LEDs and connectors.....	28
Host, Network, and Drive Tray Ports and LEDs.....	28
Front-end modules.....	28
10-Gbps iSCSI board LEDs and connectors (optical).....	29
10-Gbps iSCSI board LEDs and connectors (copper).....	29
or 32-Gbps Fibre Channel (4-port) board LEDs and connectors.....	29

16-Gbps Fibre Channel (2-port) board LEDs and connectors.....	29
LAN blade LEDs and connectors.....	31
Back-end modules.....	31
<b>Chapter 3: Drive trays.....</b>	<b>33</b>
Small form-factor drive tray (DBS/DBSE).....	33
SFF with front panel bezel.....	33
SFF front panel without bezel.....	34
SFF rear panel.....	35
SFF and LFF AC power supply unit LEDs and connectors.....	36
SFF power supply unit LEDs and connectors.....	37
Large form-factor drive tray (DBL/DBLE).....	37
LFF with front panel bezel.....	38
LFF front panel without bezel.....	38
LFF rear panel.....	39
SFF and LFF AC power supply unit LEDs and connectors.....	40
SFF power supply unit LEDs and connectors.....	41
Flash module drive tray (DBF).....	41
FMD with front panel bezel.....	42
FMD front panel without bezel.....	43
FMD rear panel.....	44
High-density intermix drive tray (DB60).....	45
Dense intermix drive tray with front panel bezel.....	46
Dense intermix drive tray display LEDs.....	47
Dense intermix drive tray rear panel.....	48
<b>Chapter 4: Host port expansion chassis.....</b>	<b>50</b>
Host port expansion chassis front panel bezel LEDs.....	50
PCIe switchboard.....	50
Host port expansion chassis fan.....	51
PCIe cable connector.....	52
Host port expansion chassis power supply.....	53
<b>Chapter 5: NAS module.....</b>	<b>55</b>
NAS Module Ports and LEDs.....	55
<b>Chapter 6: Maintaining the storage system.....</b>	<b>57</b>
Storing the storage system.....	57
Powering off the storage system.....	57
Battery unit.....	58
Removing cables.....	58

<b>Appendix A: Mechanical specifications for VSP G400, G600 .....</b>	<b>60</b>
VSP G400 and VSP G600 mechanical specifications.....	60
<b>Appendix B: Electrical specifications for VSP G400, G600.....</b>	<b>69</b>
Electrical specifications.....	69
<b>Appendix C: Environmental specifications for VSP G400, G600.....</b>	<b>71</b>
Environmental specifications.....	71
<b>Appendix D: iSCSI standards and specifications.....</b>	<b>77</b>
iSCSI standards.....	77
iSCSI specifications.....	77
<b>Appendix E: Replacement parts.....</b>	<b>82</b>
Battery unit.....	82
<b>Appendix F: Data and power cables.....</b>	<b>83</b>
Required cables.....	83
Fibre Channel cables.....	85
iSCSI cables.....	88
iSCSI standards.....	90
iSCSI specifications.....	91
Managing cables.....	94
AC power cables.....	96
Power cable assemblies.....	97
AC connections.....	98
Power cable usage guidelines.....	100
Three-phase power considerations for racks.....	101
Cable management.....	101
<b>Appendix G: Port address mapping.....</b>	<b>102</b>
Port address mapping.....	102
<b>Appendix H: Non-Hitachi racks.....</b>	<b>104</b>
Non-Hitachi rack support .....	104
Hitachi Universal V2 Rack rail kits.....	104
Hitachi Universal V2 Rack accessories.....	105
Third-party rack support for DB60 dense intermix drive trays.....	105
<b>Appendix I: Regulatory compliance.....</b>	<b>107</b>
<b>Appendix J: Environmental notices.....</b>	<b>109</b>

---

## Preface

This guide describes the hardware features and specifications of the VSP G400, G600 models.

### Intended audience

This document is intended for Hitachi Vantara representatives, system administrators, authorized service providers, or customers who install, configure, and operate the storage system.

Readers of this document should be familiar with the following:

- Data processing and RAID storage systems and their basic functions
- RAID storage system hardware components and operational specifications

### UEFI Development Kit 2010

This product includes UEFI Development Kit 2010 written by the UEFI Open Source Community. For more information, see the UEFI Development Kit website:

<http://sourceforge.net/apps/mediawiki/tianocore/index.php?title=UDK2010>

© 2004, Intel Corporation.

All rights reserved.

Redistribution and use in source and binary forms, with or without modification, are permitted provided that the following conditions are met:

Redistributions of source code must retain the above copyright notice, this list of conditions and the following disclaimer.

Redistributions in binary form must reproduce the above copyright notice, this list of conditions and the following disclaimer in the documentation and/or other materials provided with the distribution.

Neither the name of the Intel Corporation nor the names of its contributors might be used to endorse or promote products derived from this software without specific prior written permission.

THIS SOFTWARE IS PROVIDED BY THE COPYRIGHT HOLDERS AND CONTRIBUTORS “AS IS” AND ANY EXPRESS OR IMPLIED WARRANTIES, INCLUDING, BUT NOT LIMITED TO, THE IMPLIED WARRANTIES OF MERCHANTABILITY AND FITNESS FOR A PARTICULAR PURPOSE ARE DISCLAIMED. IN NO EVENT SHALL THE COPYRIGHT OWNER OR CONTRIBUTORS BE LIABLE FOR ANY DIRECT, INDIRECT, INCIDENTAL, SPECIAL, EXEMPLARY, OR CONSEQUENTIAL DAMAGES (INCLUDING, BUT NOT LIMITED TO, PROCUREMENT OF SUBSTITUTE GOODS OR SERVICES; LOSS OF USE, DATA, OR PROFITS; OR BUSINESS INTERRUPTION) HOWEVER CAUSED AND ON ANY THEORY OF LIABILITY, WHETHER IN CONTRACT, STRICT LIABILITY, OR TORT (INCLUDING NEGLIGENCE OR OTHERWISE) ARISING IN ANY WAY OUT OF THE USE OF THIS SOFTWARE, EVEN IF ADVISED OF THE POSSIBILITY OF SUCH DAMAGE.

## Product version

This document revision applies to the following product versions:

- VSP G400, G600 firmware 83-05-2x or later
- Hitachi Storage Virtualization Operating System (SVOS) 7.4.0 or later
- Hitachi NAS firmware version 13.1 or later

## Release notes

Read the release notes before installing and using this product. They may contain requirements or restrictions that are not fully described in this document or updates or corrections to this document. Release notes are available on Hitachi Vantara Support Connect: <https://knowledge.hitachivantara.com/Documents>.

## Changes in this revision

- Added support for DW-F800-NASR (RoHS Compliant)



## Document conventions

This document uses the following typographic conventions:

Convention	Description
<b>Bold</b>	<ul style="list-style-type: none"> <li>▪ Indicates text in a window, including window titles, menus, menu options, buttons, fields, and labels. Example: Click <b>OK</b>.</li> <li>▪ Indicates emphasized words in list items.</li> </ul>

Convention	Description
<i>Italic</i>	<ul style="list-style-type: none"> <li>Indicates a document title or emphasized words in text.</li> <li>Indicates a variable, which is a placeholder for actual text provided by the user or for output by the system. Example: <pre>pairdisplay -g group</pre> <p>(For exceptions to this convention for variables, see the entry for angle brackets.)</p> </li> </ul>
Monospace	Indicates text that is displayed on screen or entered by the user. Example: <code>pairdisplay -g oradb</code>
< > angle brackets	Indicates variables in the following scenarios: <ul style="list-style-type: none"> <li>Variables are not clearly separated from the surrounding text or from other variables. Example: <pre>Status-&lt;report-name&gt;&lt;file-version&gt;.csv</pre> </li> <li>Variables in headings.</li> </ul>
[ ] square brackets	Indicates optional values. Example: [ a   b ] indicates that you can choose a, b, or nothing.
{ } braces	Indicates required or expected values. Example: { a   b } indicates that you must choose either a or b.
vertical bar	Indicates that you have a choice between two or more options or arguments. Examples: [ a   b ] indicates that you can choose a, b, or nothing. { a   b } indicates that you must choose either a or b.

This document uses the following icons to draw attention to information:

Icon	Label	Description
	Note	Calls attention to important or additional information.
	Tip	Provides helpful information, guidelines, or suggestions for performing tasks more effectively.
	Caution	Warns the user of adverse conditions and/or consequences (for example, disruptive operations, data loss, or a system crash).



Icon	Label	Description
	WARNING	Warns the user of a hazardous situation which, if not avoided, could result in death or serious injury.

## Conventions for storage capacity values

Physical storage capacity values (for example, disk drive capacity) are calculated based on the following values:

Physical capacity unit	Value
1 kilobyte (KB)	1,000 ( $10^3$ ) bytes
1 megabyte (MB)	1,000 KB or $1,000^2$ bytes
1 gigabyte (GB)	1,000 MB or $1,000^3$ bytes
1 terabyte (TB)	1,000 GB or $1,000^4$ bytes
1 petabyte (PB)	1,000 TB or $1,000^5$ bytes
1 exabyte (EB)	1,000 PB or $1,000^6$ bytes

Logical capacity values (for example, logical device capacity, cache memory capacity) are calculated based on the following values:

Logical capacity unit	Value
1 block	512 bytes
1 cylinder	Mainframe: 870 KB Open-systems: <ul style="list-style-type: none"> <li>▪ OPEN-V: 960 KB</li> <li>▪ Others: 720 KB</li> </ul>
1 KB	1,024 ( $2^{10}$ ) bytes
1 MB	1,024 KB or $1,024^2$ bytes
1 GB	1,024 MB or $1,024^3$ bytes
1 TB	1,024 GB or $1,024^4$ bytes
1 PB	1,024 TB or $1,024^5$ bytes

Logical capacity unit	Value
1 EB	1,024 PB or 1,024 <sup>6</sup> bytes

## Accessing product documentation

Product user documentation is available on the Hitachi Vantara Support Website: <https://knowledge.hitachivantara.com/Documents>. Check this site for the most current documentation, including important updates that may have been made after the release of the product.

## Getting help

The [Hitachi Vantara Support Website](https://support.hitachivantara.com/en_us/contact-us.html) is the destination for technical support of products and solutions sold by Hitachi Vantara. To contact technical support, log on to the Hitachi Vantara Support Website for contact information: [https://support.hitachivantara.com/en\\_us/contact-us.html](https://support.hitachivantara.com/en_us/contact-us.html).

[Hitachi Vantara Community](https://community.hitachivantara.com) is a global online community for Hitachi Vantara customers, partners, independent software vendors, employees, and prospects. It is the destination to get answers, discover insights, and make connections. **Join the conversation today!** Go to [community.hitachivantara.com](https://community.hitachivantara.com), register, and complete your profile.

## Comments

Please send us your comments on this document to [doc.comments@hitachivantara.com](mailto:doc.comments@hitachivantara.com). Include the document title and number, including the revision level (for example, -07), and refer to specific sections and paragraphs whenever possible. All comments become the property of Hitachi Vantara LLC.

**Thank you!**

---

# Chapter 1: Hitachi Virtual Storage Platform G400, G600 hardware overview

Hitachi Virtual Storage Platform G400, G600 are modular, rack-mountable, all-flash arrays that deliver high performance, high reliability, and flash-accelerated scalability.

The storage system contain dual controllers, each controller contains its own processor, dual in-line cache memory modules (DIMMs), cache flash memory (CFM), battery, fans and iSCSI and Fibre Channel I/O modules. Each controller also has an Ethernet connection for out-of-band management. If the data path through one controller fails, all data drives remain available to data hosts using a redundant data path through the other controller.

The storage system can be equipped with embedded network-attached storage (NAS) modules. The NAS modules provide file access through CIFS and NFS protocols and block access by using iSCSI protocols.

All storage system models allow defective drives to be replaced without the interruption of data availability to hosts. A hot spare drive can be configured to replace a failed drive automatically, securing the fault-tolerant integrity of the logical drives. Self-contained, hardware-based RAID logical drives provide maximum performance in compact external enclosures.

Essential hardware components are implemented with a redundant configuration so that the storage system can remain operational if a component fails. Adding and replacing components, along with firmware upgrades, can be conducted while the storage system is active.

## Block configuration

A storage system configured for block-level storage provides the ability to access and provision raw storage volumes using protocols such as Fibre Channel and iSCSI.

A block configuration consists of the following:

- Two controllers
- One or more drive trays
- Optional service processor (SVP)

## Unified configuration

A unified configuration includes embedded NAS modules that support file system protocols such as CIFS and NFS and operate across a block-level setup using iSCSI or FC connections.

- Two controllers
- Two NAS modules for file operations and storage
- One or more drive trays for block-level storage
- One 1U block service processor server (SVP)

## VSP G400 model

The VSP G400 is a highly reliable storage system that offers high storage capacity with full redundancy to better protect data and manage storage operations.

The storage system consists of a 4U enclosure that includes two controllers and two NAS modules to support file operations. Drives are supported using drive trays connected to the controllers. The maximum number of drives supported is 384 (480 with dense intermix drive tray).

The storage system supports 128 GB of high-speed cache memory. The DIMMs are arranged as 64 GB per controller.

Storage system interfaces consist of:

- 10-Gbps iSCSI: 28 ports per system (or 32 ports per systems for systems without drives or 12 ports per systems when NAS Modules are installed)
- 10-Gbps iSCSI (Copper): 28 ports per system (or 32 ports per systems for systems without drives or 12 ports per systems when NAS Modules are installed)
- 8-Gbps Fibre Channel: 56 ports per system (or 64 ports per systems for systems without drives or 24 ports per systems when NAS Modules are installed)
- 16-Gbps Fibre Channel (2-port): 28 ports per system (or 32 ports per systems for systems without drives or 12 ports per systems when NAS Modules are installed)
- 16-Gbps Fibre Channel (4-port): 56 ports per system (or 64 ports per systems for systems without drives or 24 ports per systems when NAS Modules are installed)
- 32-Gbps Fibre Channel (4-port): 56 ports per system (or 64 ports per systems for systems without drives or 24 ports per systems when NAS Modules are installed)

Controller	Controller chassis	Controller model	Height
CBLM	DW800-CBL	DW-F800-CTLM	4U (174.3 mm)

Controller	Model number	Description
NAS	<ul style="list-style-type: none"> <li>▪ DW-F800-NAS</li> <li>▪ DW-F800-NASR</li> </ul>	NAS modules provide file support.

Drive tray	Drive tray model name	Supported drive type	Number of drives supported	Height
SFF drive tray	<ul style="list-style-type: none"> <li>▪ DW-F800-DBS (power supply, contains BNST)</li> <li>▪ DW-F800-DBSC (Silver-rated power supply)</li> <li>▪ DW-F800-DBSE (Platinum-rated power supply)</li> </ul>	2.5-inch SFF	24	2U (86.2 mm)
LFF drive tray	<ul style="list-style-type: none"> <li>▪ DW-F800-DBL (power supply, contains BNST)</li> <li>▪ DW-F800-DBLC (Silver-rated power supply)</li> <li>▪ DW-F800-DBLE (Platinum-rated power supply)</li> </ul>	3.5-inch LFF	12	2U (86.2 mm)
FMD tray	<ul style="list-style-type: none"> <li>▪ DW-F800-DBF</li> </ul>	5.25-inch FMD	12	2U (86.2 mm)

Drive tray	Drive tray model name	Supported drive type	Number of drives supported	Height
Dense intermix drive tray	<ul style="list-style-type: none"> <li>▪ DW-F800-DB60 (power supply, contains BNST)</li> <li>▪ DW-F800-DB60C</li> </ul>	3.5-inch LFF	60	4U (174.3 mm)

### Disk drives

The VSP G400 storage system supports the listed disk drive capacities.

Model number	Drive type	Drive capacity
DKC-F810I-600JCM	SFF disk drive	600 GB
DKC-F810I-1R2JCM	SFF disk drive	1.2 TB
DKC-F810I-1R2J5M	LFF disk drive	1.2 TB
DKC-F810I-2R4JGM	SFF disk drive	2.4 TB
DKC-F810I-2R4J8M	LFF disk drive	2.4 TB
DKC-F810I-6R0H9M	LFF disk drive	6 TB
DKC-F810I-10RH9M	LFF disk drive	10 TB

### Flash module drives

The VSP G400 storage system supports the listed flash module drive capacities.

Model number	Drive type	Drive capacity
DKC-F810I-7R0FP	FMD	7 TB
DKC-F810I-14RFP	FMD	14 TB

### Solid-state drives

The VSP G400 storage system supports the listed SSD capacities.

Model number	Drive type	Drive capacity
--------------	------------	----------------

Model number	Drive type	Drive capacity
DKC-F810I-1R9MGM	SSD	1.9 TB
DKC-F810I-3R8MGM	SSD	3.8 TB
DKC-F810I-7R6MGM	SSD	7.6 TB

## VSP G600 model

The VSP G600 is a highly reliable storage system that offers high storage capacity with full redundancy to better protect data and manage storage operations.

The storage system consists of a 4U enclosure that includes two controllers and two NAS modules to support file operations. Drives are supported using drive trays connected to the controllers. The maximum number of drives supported is 576 (720 with dense intermix drive tray).

The storage system supports 256 GB of high-speed cache memory. The DIMMs are arranged as 128 GB per controller.

Storage system interfaces consist of:

- 10-Gbps iSCSI: 28 ports per system (or 32 ports per systems for systems without drives or 12 ports per systems when NAS Modules are installed)
- 10-Gbps iSCSI (Copper): 28 ports per system (or 32 ports per systems for systems without drives or 12 ports per systems when NAS Modules are installed)
- 8-Gbps Fibre Channel: 56 ports per system (or 64 ports per systems for systems without drives or 24 ports per systems when NAS Modules are installed)
- 16-Gbps Fibre Channel (2-port): 28 ports per system (or 32 ports per systems for systems without drives or 12 ports per systems when NAS Modules are installed)
- 16-Gbps Fibre Channel (4-port): 56 ports per system (or 64 ports per systems for systems without drives or 24 ports per systems when NAS Modules are installed)
- 32-Gbps Fibre Channel (4-port): 56 ports per system (or 64 ports per systems for systems without drives or 24 ports per systems when NAS Modules are installed)

Controller	Controller chassis	Controller model	Height
CBLM	DW800-CBL	DW-F800-CTLM	4U (174.3 mm)

Controller	Model number	Description
NAS	<ul style="list-style-type: none"> <li>▪ DW-F800-NAS</li> <li>▪ DW-F800-NASR</li> </ul>	NAS modules provide file support.

Drive tray	Drive tray model name	Supported drive type	Number of drives supported	Height
SFF drive tray	<ul style="list-style-type: none"> <li>▪ DW-F800-DBS (power supply, contains BNST)</li> <li>▪ DW-F800-DBSC (Silver-rated power supply)</li> <li>▪ DW-F800-DBSE (Platinum-rated power supply)</li> </ul>	2.5-inch SFF	24	2U (86.2 mm)
LFF drive tray	<ul style="list-style-type: none"> <li>▪ DW-F800-DBL (power supply, contains BNST)</li> <li>▪ DW-F800-DBLC (Silver-rated power supply)</li> <li>▪ DW-F800-DBLE (Platinum-rated power supply)</li> </ul>	3.5-inch LFF	12	2U (86.2 mm)
FMD tray	<ul style="list-style-type: none"> <li>▪ DW-F800-DBF</li> </ul>	5.25-inch FMD	12	2U (86.2 mm)



Drive tray	Drive tray model name	Supported drive type	Number of drives supported	Height
Dense intermix drive tray	<ul style="list-style-type: none"> <li>▪ DW-F800-DB60 (power supply, contains BNST)</li> <li>▪ DW-F800-DB60C</li> </ul>	3.5-inch LFF	60	4U (174.3 mm)

### Disk drives

The VSP G600 storage system supports the listed disk drive capacities.

Model number	Drive type	Drive capacity
DKC-F810I-600JCM	SFF disk drive	600 GB
DKC-F810I-1R2JCM	SFF disk drive	1.2 TB
DKC-F810I-1R2J5M	LFF disk drive	1.2 TB
DKC-F810I-2R4JGM	SFF disk drive	2.4 TB
DKC-F810I-2R4J8M	LFF disk drive	2.4 TB
DKC-F810I-6R0H9M	LFF disk drive	6 TB
DKC-F810I-10RH9M	LFF disk drive	10 TB

### Flash module drives

The VSP G600 storage system supports the listed flash module drive capacities.

Model number	Drive type	Drive capacity
DKC-F810I-7R0FP	FMD	7 TB
DKC-F810I-14RFP	FMD	14 TB

### Solid-state drives

The VSP G600 storage system supports the listed SSD capacities.

Model number	Drive type	Drive capacity
DKC-F810I-1R9MGM	SSD	1.9 TB
DKC-F810I-3R8MGM	SSD	3.8 TB
DKC-F810I-7R6MGM	SSD	7.6 TB

## Features

The features described in the table are included with VSP G400 and VSP G600.

Feature		Value
Maximum cache memory supported		VSP G400: 128 GB VSP G600: 256 GB
Maximum number of spare drives		32
Maximum number of RAID groups		VSP G400: 240 VSP G600: 240
Maximum volume size		3 TB (4 TB when using the LDEVs of other Storage Systems)
Maximum number of volumes per RAID group		2,048
Maximum number of DP pool volumes		4,096
Maximum number of DP pools		64
Maximum number of iSCSI hosts connected through a network switch		255
Maximum number of Fibre Channel devices connected through a Fibre Channel switch		255
Maximum storage system capacity (physical capacity)	Using 2.4 TB HDD	VSP G400: 885 TB VSP G600: 1,328 TB
	Using 10 TB HDD	VSP G400: 4,699 TB VSP G600: 7,049 TB
	Using 7.6 TB SSD	VSP G400: 2,904 TB VSP G600: 4,356 TB

Feature	Value
Using 14 TB FMD	VSP G400: 2,702 TB VSP G600: 4,053 TB

## Scalability

All storage systems offer pay-as-you-grow scalability by allowing you to hot-add drives as you need them.

### Examples of supported VSP G400 configurations

The following table lists the maximum number of drive trays and drives supported in a system configuration. A diskless configuration does not include any drive trays.

Drive tray	Maximum number of drive trays supported	Maximum number of drives supported
SFF drive tray	16	384 HDDs or SSDs
LFF drive tray	16	192 HDDs or SSDs
FMD tray	16	192 Hitachi Accelerated Flash (HAF) flash module drives
Dense intermix drive tray	8	-



**Note:** If a drive is inserted into a slot of a dense intermix drive tray when the installed number of drives exceeds 240 slots per path, the drive is blocked.

### Examples of supported VSP G600 configurations

The following table lists the maximum number of drive trays and drives supported in a system configuration. A diskless configuration does not include any drive trays.

Drive tray	Maximum number of drive trays supported	Maximum number of drives supported
SFF drive tray	24	576 HDDs or SSDs
LFF drive tray	24	288 HDDs or SSDs
FMD tray	24	288 HAF flash module drives

Drive tray	Maximum number of drive trays supported	Maximum number of drives supported
Dense intermix drive tray	12	-



**Note:** If a drive is inserted into a slot of a dense intermix drive tray when the installed number of drives exceeds 240 slots per path, the drive is blocked.

## Maximum number of mounted drive trays

The following table lists the maximum number of mountable drive trays and mountable drives for each drive type.



**Note:** If a drive is inserted into a slot of a dense intermix drive tray when the installed number of drives exceeds 240 slots per path, the drive is blocked.

VSP G400 controller	Drive trays	Maximum number of trays	Maximum number of drives
CBLM	SFF	16	384 HDDs or SSDs
	LFF	16	192 HDDs or SSDs
	FMD	16	192 FMDs (HAF)
	Dense intermix drive tray	8	480 HDDs or SSDs <sup>1</sup>
<b>Note:</b>			
<sup>1</sup> The following SSD capacities (200 GB and 400 GB) are supported in a dense intermix drive tray.			

VSP G600 controller	Drive trays	Maximum number of trays	Maximum number of drives
CBLM	SFF	24	576 HDDs or SSDs
	LFF	24	288 HDDs or SSDs
	FMD	24	288 FMDs (HAF)
	Dense intermix drive tray	12	720 HDDs or SSDs <sup>1</sup>
<b>Note:</b>			
<sup>1</sup> The following SSD capacities (200 GB and 400 GB) are supported in a dense intermix drive tray.			

VSP G400 controller	Number of mounted drive trays (Maximum 12 per path)		Maximum number of mounted drives	
	SFF, LFF drives	Dense intermix drive tray	SFF drive + dense intermix drive tray	LFF drive + dense intermix drive tray
CBLM	16	0	384	192
	13	1	372	216
	12	2	408	264
	9	3	396	288
	8	4	432	336
	5	5	420	360

VSP G400 controller	Number of mounted drive trays (Maximum 12 per path)		Maximum number of mounted drives	
	SFF, LFF drives	Dense intermix drive tray	SFF drive + dense intermix drive tray	LFF drive + dense intermix drive tray
	4	6	456	408
	1	7	444	432
	0	8	480	480

VSP G600 controller	Number of mounted drive trays (Maximum 12 per path)		Maximum number of mounted drives	
	SFF, LFF drives	Dense intermix drive tray	SFF drive + dense intermix drive tray	LFF drive + dense intermix drive tray
CBLM	24	0	576	288
	21	1	564	312
	20	2	600	360
	17	3	588	384
	16	4	624	432
	13	5	612	456
	12	6	648	504
	9	7	636	528
	8	8	672	576
	5	9	660	600
	4	10	696	648
	1	11	684	672
	0	12	720	720

## Chapter 2: Virtual Storage Platform G400, G600 controller

The Virtual Storage Platform G400, G600 models are equipped with dual controllers for communicating with a data host.

Each controller includes the following internal components such as a processor, dual in-line cache memory modules (DIMMs), cache flash memory (CFM), battery, and fans. The controller has an Ethernet connection for out-of-band management using Hitachi Device Manager - Storage Navigator. If the data path through one controller fails, all drives remain available to data hosts using a redundant data path through the other controller. The controller is equipped with LED indicators for monitoring its operating conditions and notifying possible component replacement.

### CBLM controller

The CBLM controller includes specific functional LEDs located on the front and rear of controller and power supplies to provide its operating status.

#### CBLM with front panel bezel

The following table describes the definitions of the CBLM controller front panel bezel LEDs.

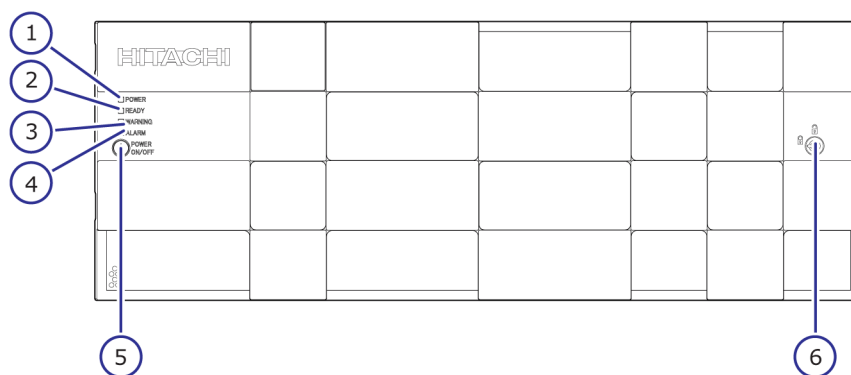

Number	Item	Description
1	POWER LED	Green: Storage system is powered on. Amber: Storage system is receiving power.

Number	Item	Description
2	READY LED	Green: Normal operation.
3	WARNING LED	Off: Normal operation. Amber: Component requires maintenance. Blink: Failure requires maintenance. <b>Note:</b> When System Option Mode 1097 is set to ON, the WARNING LED does not blink, even if the following failure service information messages (SIM) are issued: 452xxx, 462xxx, 3077xx, 4100xx, and 410100. LED might turn off during user maintenance.
4	ALARM LED	Off: Normal operation. Red: Processor failure (system might be down). For assistance, contact customer support: <a href="https://support.hitachivantara.com/en_us/contact-us.html">https://support.hitachivantara.com/en_us/contact-us.html</a> .
5	POWER ON/OFF (main switch)	Powers the storage system.
6	Lock	Locks and unlocks the front panel bezel by using the supplied key.



**Note:** Removing a controller can cause the POWER, READY, WARNING, and ALARM LEDs on the front panel to turn off. These LEDs return to the on status after the storage system recovers from the controller replacement.

## CBLM front panel LEDs (without bezel)

The following table describes the definitions of the CBLM controller front panel LEDs.



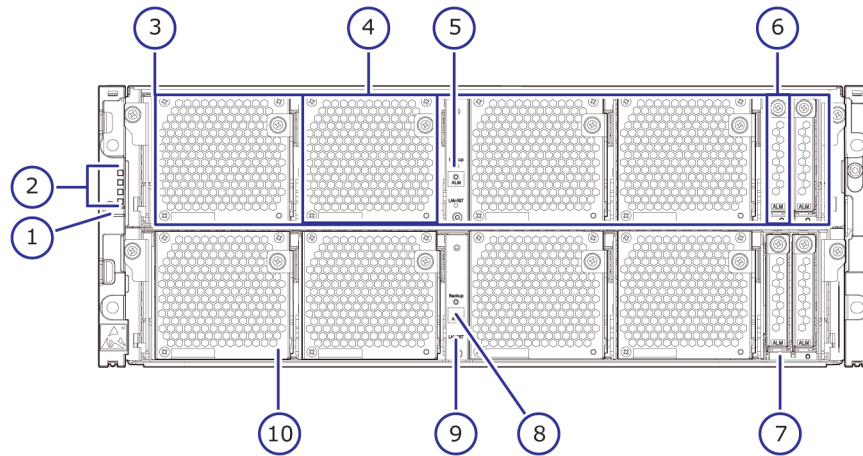

Number	Item	Description
1	POWER ON/OFF (main switch)	Powers the storage system.
2	POWER, READY, WARNING, and ALARM LEDs	<b>Note:</b> When System Option Mode 1097 is set to ON, the WARNING LED does not blink, even if the following failure service information messages (SIM) are issued: 452xxx, 462xxx, 3077xx, 4100xx, and 410100.
3	Controllers	Controller 1 (bottom) and Controller 2 (top).
4	Backup module	N/A
5	BACKUP STTS LED	Green: Power restoration in progress following power outage. Fast blink green: Restoring. Slow blink green: Restoring, or sequential shutdown in progress.
6	Cache flash memory	N/A
7	ALM LED (for cache flash memory)	Red: Cache flash memory can be removed.
8	CTL ALM LED	Red: Controller can be removed.

Number	Item	Description
		<p>Blink red: Failure with the power supply unit of the controller.</p> <p>Amber: LAN reset switch was pressed.</p>
9	LAN-RST switch	Use only when instructed by customer support.
10	STATUS LED (for BKMF)	<p>Green: Charging of the battery in the backup module is complete.</p> <p>Red: Backup module can be removed.</p> <p>Blink red one time: Main battery failure.</p> <p>Blink red two times: Backup battery failure.</p> <p>Blink red three times: Both batteries failed or preventive maintenance replacement of batteries can run.</p> <p>Off: Battery is not mounted, battery-mounting failure occurred, or firmware is being upgraded. Off is normal status for configurations without batteries (for example, BKMF-10 and BKMF-20).</p>

## CBLM rear panel

The following table describes the definitions of the CBLM controller rear panel LEDs.

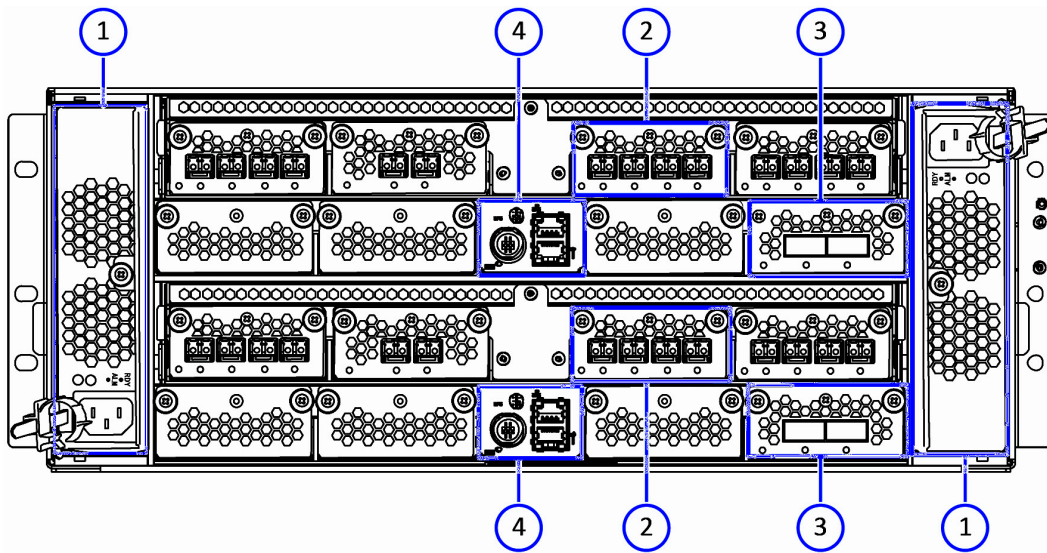

Number	Item
1	Power supply unit
2	Front end module
3	Back end module
4	LAN blade

**Rear view (includes NAS modules)**

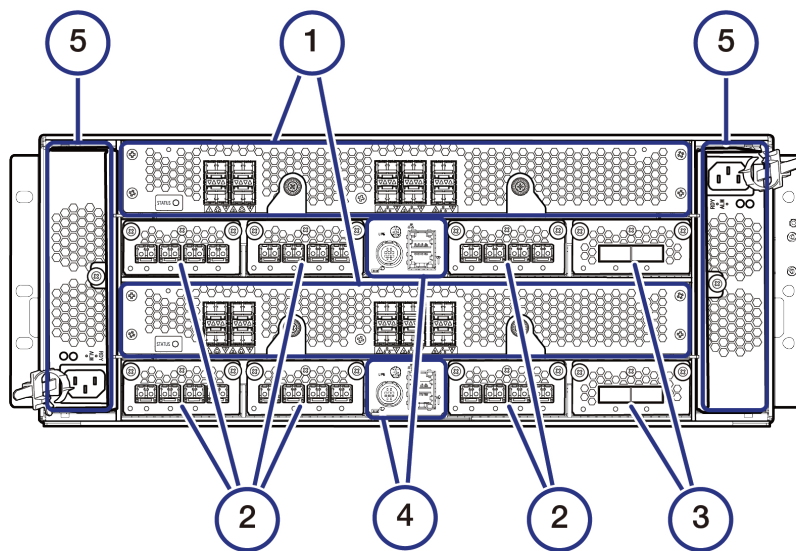

Number	Item
1	NAS module
2	Front end module
3	Back end module
4	LAN blade
5	Power supply unit

## CBLM power supply unit LEDs and connectors

The following table lists the definitions of the CBLM power supply unit LEDs and connectors.

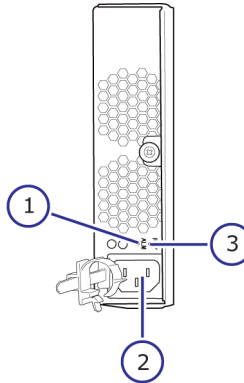

Number	Item	Description
1	ALM / RDY LED	Red: Power supply unit can be replaced.
2	Receptacle	Connects to the power cable provided with the storage system.
3	RDY LED	Green: Normal operation.

## Host, Network, and Drive Tray Ports and LEDs

The controllers are equipped with specific interfaces for connecting, powering, configuring, and managing the storage system. The component LEDs display the operating status of the storage system.

### Front-end modules

10-Gbps iSCSI board LEDs and connectors (optical)

10-Gbps iSCSI board LEDs and connectors (copper)

or 32-Gbps Fibre Channel (4-port) board LEDs and connectors

16-Gbps Fibre Channel (2-port) board LEDs and connectors

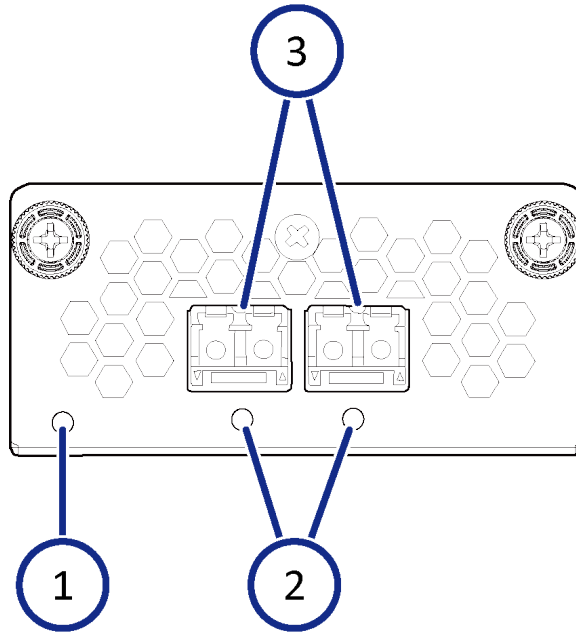

Number	Item	Description
1	STATUS LED	Green: Front end module is in the power-on state. Red: Front end module can be removed safely.
2	PORT LED	Red: Small form-factor pluggable can be removed. Blue: Normal link status at 16-Gbps. Green: Normal link status at 4-Gbps or 8-Gbps.
3	Fibre Channel connectors	Connect to Fibre Channel cables.

**Port assignments**

CHB number	16-Gbps Fibre Channel ports (left to right)	
	Port 1	Port 2
CHB-1A	1A	3A
CHB-1B	1B	3B
CHB-1C	1C	3C
CHB-1D	1D	3D
CHB-1E	1E	3E
CHB-1F	1F	3F
CHB-1G	1G	3G
CHB-1H	1H	3H
CHB-2A	2A	4A
CHB-2B	2B	4B
CHB-2C	2C	4C
CHB-2D	2D	4D
CHB-2E	2E	4E
CHB-2F	2F	4F
CHB-2G	2G	4G
CHB-2H	2H	4H

### LAN blade LEDs and connectors

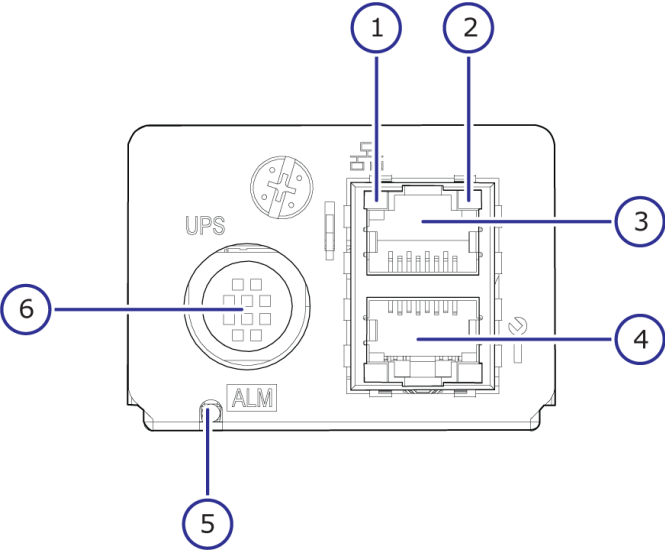

Number	Item	Description
1	LINK LED	Green: Link status is normal.
2	ACT LED	Orange: Data is being transferred.
3	LAN 2	LAN port used by the user.
4	LAN 1	Maintenance LAN port used by service personnel.
5	LAN ALARM LED	Red: LAN blade can be removed.
6	Uninterruptible power supply (UPS) port	N/A

### Back-end modules

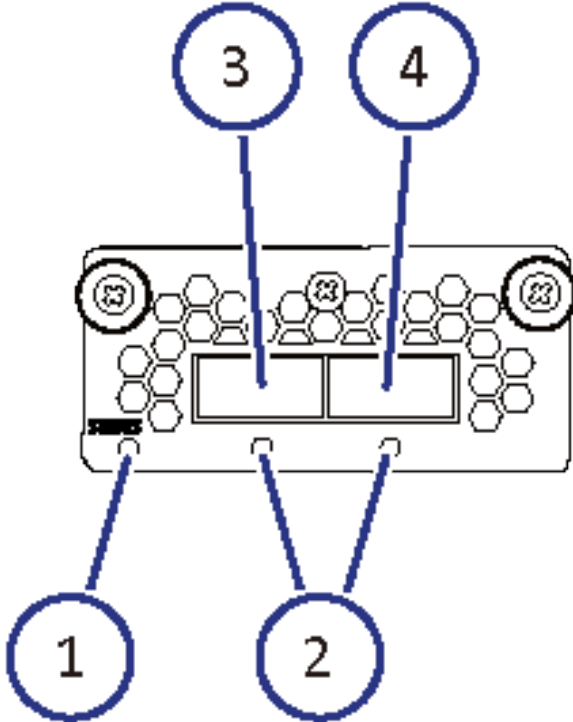

Number	Item	Description
1	STATUS LED	Green: Back-end module is in the power-on state. Red: Back-end module can be removed safely.
2	PORT LED	Blue: Link status is normal.
3	PATH 0 connector	Connect to a drive tray.
4	PATH 1 connector	Connects to a drive tray.



## Chapter 3: Drive trays

The drive tray contains data drives, power supplies, fans, and status LEDs. Each drive tray provides interfaces for connecting to controllers and other drive trays. The all-flash storage arrays have various fixed storage capacity configurations with flash storage devices. To deliver consistent low latency host response times and highest IOP performance across all host connection ports, conventional hard disk drives (HDD) are not included or configurable with all-flash arrays.

### Small form-factor drive tray (DBS/DBSE)

The following describes the physical specifications of the small form-factor drive tray.

Name	Model name	Height	Number of drive slots	Drive type
DBS	DW-F800-DBSC	2U (88.2 mm)	24	2.5 inch (SFF)
DBSE	DW-F800-DBSE	2U (88.2 mm)	24	2.5 inch (SFF)

### SFF with front panel bezel

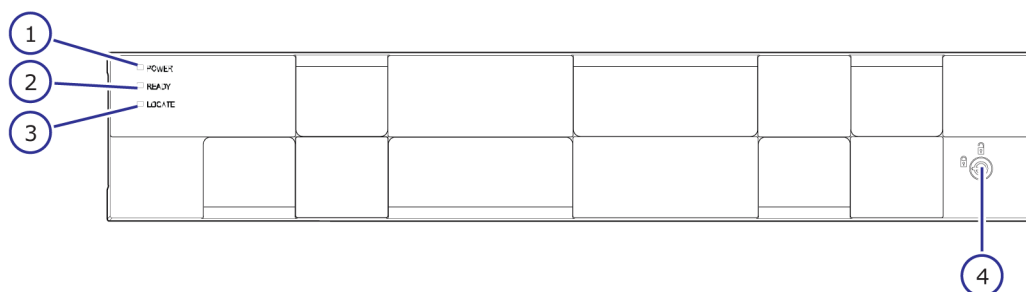

Number	Item	Description
1	POWER LED	Green: Drive tray is powered on.
2	READY LED	Green: Drive tray is operational.

Number	Item	Description
3	Locate LED	Amber: <ul style="list-style-type: none"> <li>Indicates the location of the chassis.</li> <li>Can be turned on or turned off by the maintenance utility.</li> </ul>
4	Lock	Locks and unlocks the front panel bezel by using the supplied key.

### SFF front panel without bezel

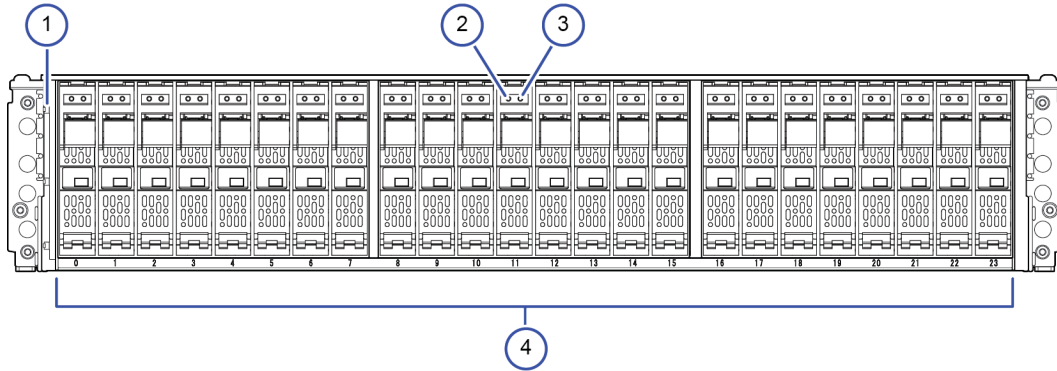

Number	Item	Description
1	POWER, READY, and LOCATE LEDs	Green: Drive tray is powered on. Green: Drive tray is operational. Amber: <ul style="list-style-type: none"> <li>Indicates the location of the chassis.</li> <li>Can be turned on or turned off by the maintenance utility.</li> </ul>
2	ALM LED	Red: Drive stopped due to a failure and can be replaced.
3	ACT LED	Green: Normal operation.

Number	Item	Description
		Blink green: Drive is being accessed.
4	Small form-factor drives	The twenty-four 2.5-inch small form factor drives are positioned vertically. The slots are organized from 0 to 23.

## SFF rear panel

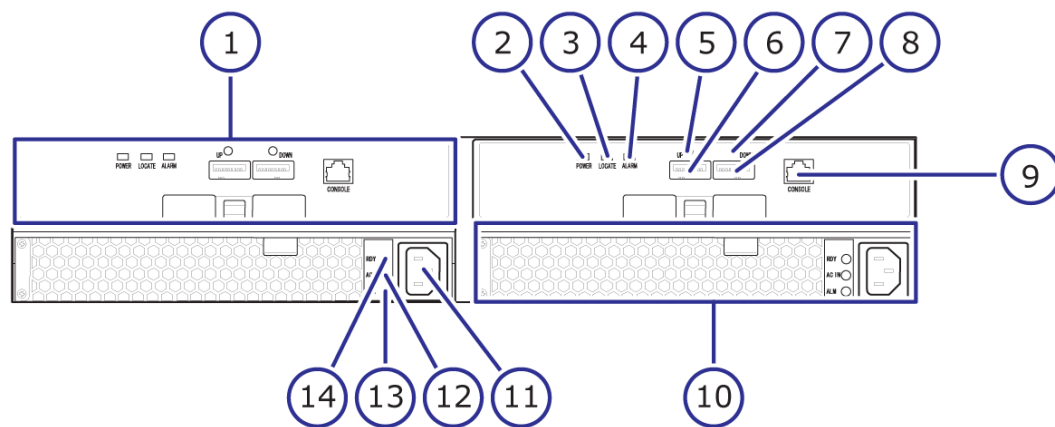

Number	Item	Description
1	ENC	N/A
2	POWER LED	Green: ENC is in the power-on state.
3	Locate LED	Amber: <ul style="list-style-type: none"> <li>Indicates the location of the chassis.</li> <li>Can be turned on or turned off by the maintenance utility.</li> </ul>
4	ALARM LED	Red: ENC can be replaced.
5	PATH (IN) LED	Blue: IN side port is linked up.
6	PATH (IN) connector	Connects to a controller or drive tray.

Number	Item	Description
7	PATH (OUT) LED	Blue: OUT side port is linked up.
8	PATH (OUT) connector	Connects to a drive tray.
9	Console	This port is reserved.
10	Power supply unit	N/A
11	Receptacle	Connects to the power cable provided with the storage system.
12	AC IN LED	Green: Normal operation.
13	ALM LED	Red: Power supply unit can be replaced.
14	RDY LED	Green: Normal operation.

## SFF and LFF AC power supply unit LEDs and connectors

Both SFF and LFF drive trays are equipped with AC power supply units. The AC power supply units include LEDs to display its operating status.



### Note:

The DBS and DBL power supply has a Silver efficiency rating.

The DBSE and DBLE power supply has a Platinum efficiency rating.

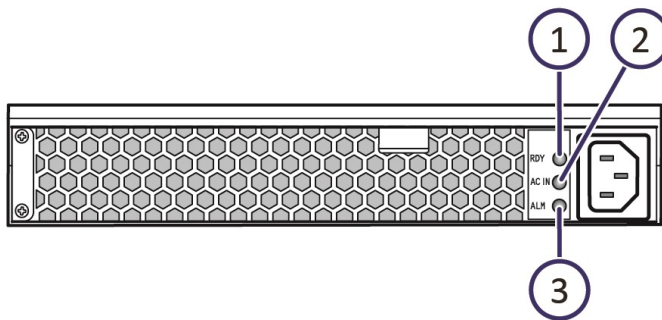

Number	Item	Description
1	RDY LED	Green: Normal operation.
2	ACI IN LED	Green: AC input is operating normally.

Number	Item	Description
3	ALM LED	Red: Power supply unit can be replaced.

## SFF power supply unit LEDs and connectors

Both SFF and LFF drive trays are equipped with DC power supply units. The DC power supply units include LEDs to display its operating status.

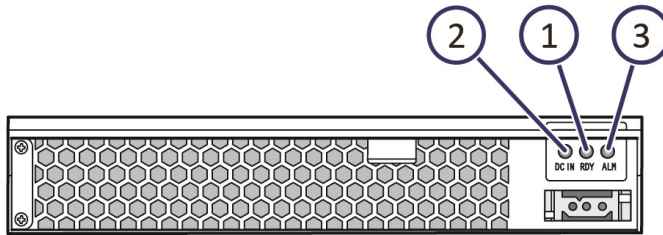

Number	Item	Description
1	RDY LED	Green: Normal operation.
2	DC IN LED	Green: DC input is operating normally.
3	ALM LED	Red: Power supply unit can be replaced.

## Large form-factor drive tray (DBL/DBLE)

The following describes the physical specifications of the large form-factor drive tray.

Name	Model name	Height	Number of drive slots	Drive type
DBL	DW-F800-DBLC	2U (88.2 mm)	12	3.5 inch (LFF)
DBLE	DW-F800-DBLE	2U (88.2 mm)	12	3.5 inch (LFF)

### LFF with front panel bezel

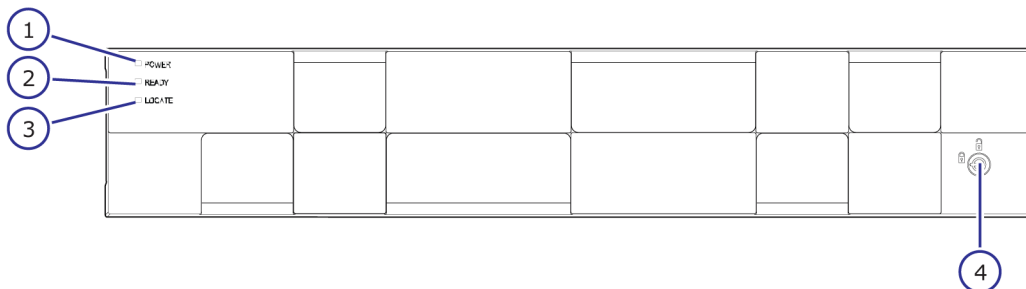

Number	Item	Description
1	POWER LED	Green: Drive tray is powered on.
2	READY LED	Green: Drive tray is operational.
3	Locate LED	Amber: <ul style="list-style-type: none"> <li>▪ Indicates the location of the chassis.</li> <li>▪ Can be turned on or turned off by the maintenance utility.</li> </ul>
4	Lock	Locks and unlocks the front panel bezel by using the supplied key.

### LFF front panel without bezel

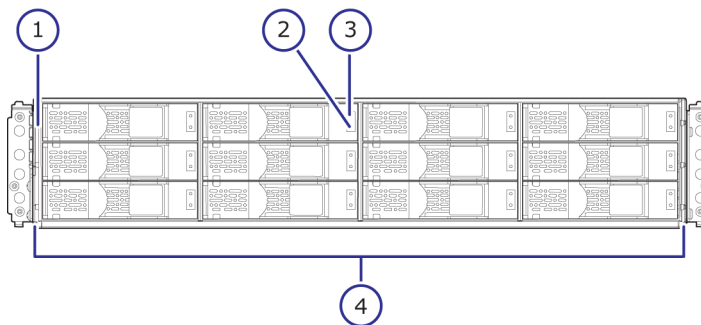

Number	Item	Description
1	POWER, READY, and LOCATE LEDs	Green: Drive tray is powered on.

Number	Item	Description												
		Green: Drive tray is operational.												
		Amber: <ul style="list-style-type: none"> <li>Indicates the location of the chassis.</li> <li>Can be turned on or turned off by the maintenance utility.</li> </ul>												
2	ACT LED	Green: Normal operation. Blink green: Drive is being accessed.												
3	ALM LED	Red: Drive stopped due to a failure and can be replaced.												
4	Large form-factor drives	The twelve 3.5-inch large form factor drives are positioned horizontally. The slots are organized in the following order: <table border="1" style="margin-left: 20px;"> <tbody> <tr> <td>8</td> <td>9</td> <td>10</td> <td>11</td> </tr> <tr> <td>4</td> <td>5</td> <td>6</td> <td>7</td> </tr> <tr> <td>0</td> <td>1</td> <td>2</td> <td>3</td> </tr> </tbody> </table>	8	9	10	11	4	5	6	7	0	1	2	3
8	9	10	11											
4	5	6	7											
0	1	2	3											

## LFF rear panel

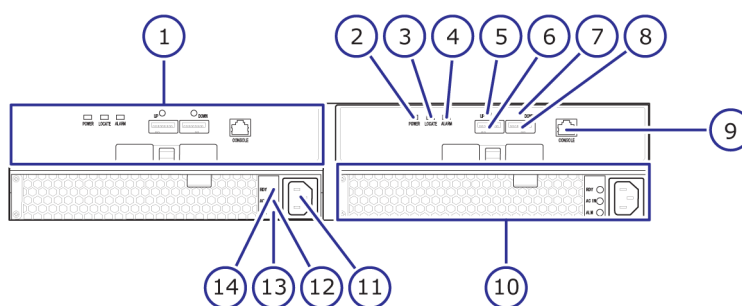

Number	Item	Description
1	ENC	N/A
2	POWER LED	Green: ENC is in the power-on state.

Number	Item	Description
3	Locate LED	Amber: <ul style="list-style-type: none"> <li>Indicates the location of the chassis.</li> <li>Can be turned on or turned off by the maintenance utility.</li> </ul>
4	ALARM LED	Red: ENC can be replaced.
5	PATH (IN) LED	Blue: IN side port is linked up.
6	PATH (IN) connector	Connects to a controller or drive tray.
7	PATH (OUT) LED	Blue: OUT side port is linked up.
8	PATH (OUT) connector	Connects to a drive tray.
9	Console	This port is reserved.
10	Power supply unit	N/A
11	Receptacle	Connects to the power cable provided with the storage system.
12	AC IN LED	Green: Normal operation.
13	ALM LED	Red: Power supply unit can be replaced.
14	RDY LED	Green: Normal operation.

## SFF and LFF AC power supply unit LEDs and connectors

Both SFF and LFF drive trays are equipped with AC power supply units. The AC power supply units include LEDs to display its operating status.



### Note:

The DBS and DBL power supply has a Silver efficiency rating.

The DBSE and DBLE power supply has a Platinum efficiency rating.



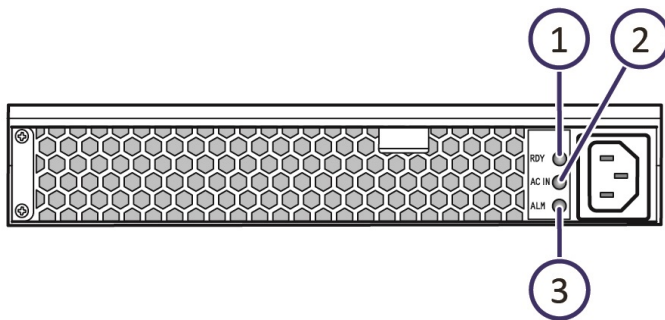

Number	Item	Description
1	RDY LED	Green: Normal operation.
2	ACI IN LED	Green: AC input is operating normally.
3	ALM LED	Red: Power supply unit can be replaced.

### SFF power supply unit LEDs and connectors

Both SFF and LFF drive trays are equipped with DC power supply units. The DC power supply units include LEDs to display its operating status.

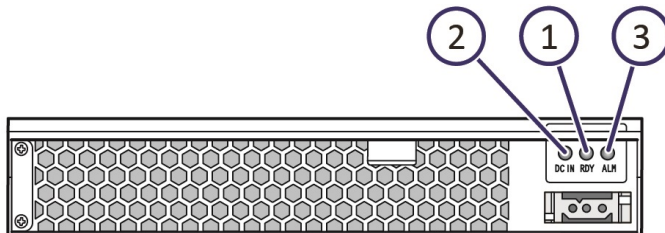

Number	Item	Description
1	RDY LED	Green: Normal operation.
2	DC IN LED	Green: DC input is operating normally.
3	ALM LED	Red: Power supply unit can be replaced.

### Flash module drive tray (DBF)

The following describes the physical specifications of the flash module drive tray.

Name	Model name	Height	Number of drive slots	Drive type
DBF	DW-F800-DBF	2U (87 mm)	12	Flash module drive (FMD)

### FMD with front panel bezel

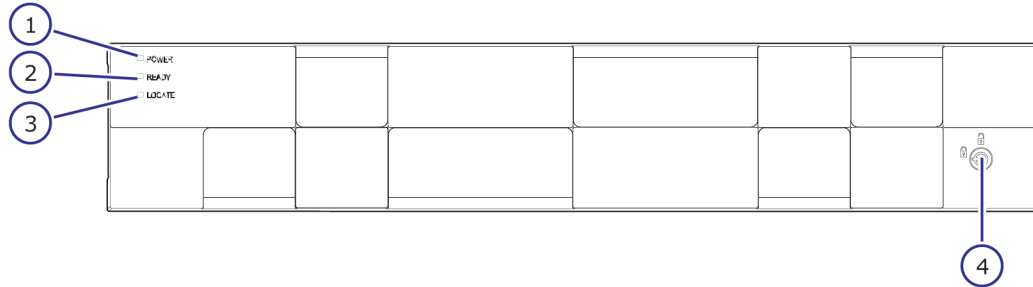

Number	Item	Description
1	POWER LED	Green: Drive tray is powered on.
2	READY LED	Green: Drive tray is operational.
3	Locate LED	Amber: <ul style="list-style-type: none"> <li>Indicates the location of the chassis.</li> <li>Can be turned on or turned off by the maintenance utility.</li> </ul>
4	Lock	Locks and unlocks the front panel bezel by using the supplied key.

## FMD front panel without bezel

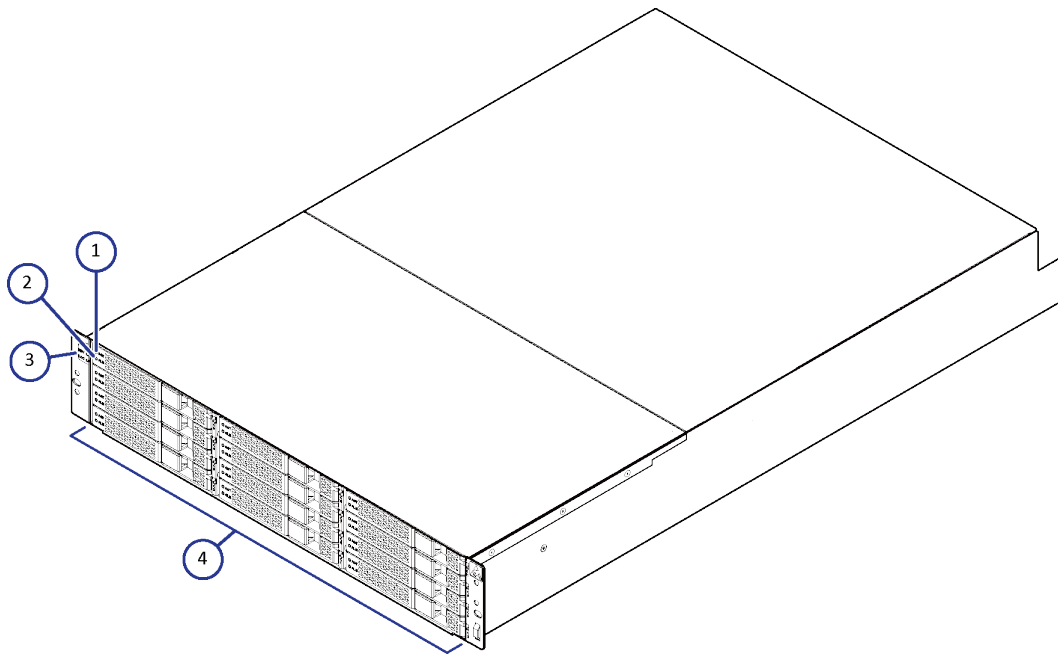

Number	Item	Description
1, 2	ACT LED	Green: Normal operation.
		Blink: Drive is being accessed.
1, 2	ALM LED	Slow blink indicates the FMD is in the process of startup. When powered, the LED blinks for about two to five minutes until the startup processing is complete.
		Red: Drive stopped due to a failure and can be replaced. <b>Note:</b> ACT indicator is only printed on some types of FMDs.
3	POWER, READY, and LOCATE LEDs	Green: Drive tray is powered on.
		Green: Drive tray is operational.

Number	Item	Description
		<p>Amber:</p> <ul style="list-style-type: none"> <li>Indicates the location of the chassis.</li> <li>Can be turned on or turned off by the maintenance utility.</li> </ul>
4	Flash module drives	<p>Twelve flash module drives. Slots are organized the following way:</p> <p>9, 10, 11</p> <p>6, 7, 8</p> <p>3, 4, 5</p> <p>0, 1, 2</p>

### FMD rear panel

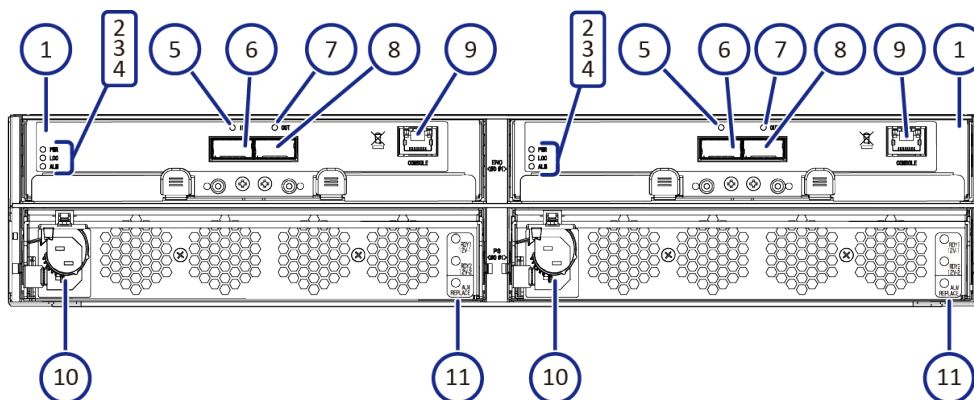

Number	Item	Description
1	ENC	N/A
2	POWER LED	Green: ENC is in the power-on state.
3	Locate LED	<p>Amber:</p> <ul style="list-style-type: none"> <li>Indicates the location of the chassis.</li> <li>Can be turned on or turned off by the maintenance utility.</li> </ul>

Number	Item	Description
4	ALARM LED	Red: ENC can be replaced.
5	PATH (IN) LED	Blue: IN side port is linked up.
6	PATH (IN) connector	Connects to a controller or drive tray.
7	PATH (OUT) LED	Blue: OUT side port is linked up.
8	PATH (OUT) connector	Connects to a drive tray.
9	Console	This port is reserved.
10	Receptacle	Connects to the power cable provided with the storage system.
11	Three LEDS, top to bottom: RDY LED AC IN LED ALM REPLACE LED	Green: Power supply unit is operating normally.
		Green: Power supply unit is operating normally.
		Red: Power supply unit can be replaced.

## High-density intermix drive tray (DB60)

The following describes the physical specifications of the high-density drive tray.

Name	Model name	Height	Number of drive slots	Drive type
DB60	DW-F800-DB60C	4U (176 mm)	60	3.5 inch (LFF)

## Dense intermix drive tray with front panel bezel

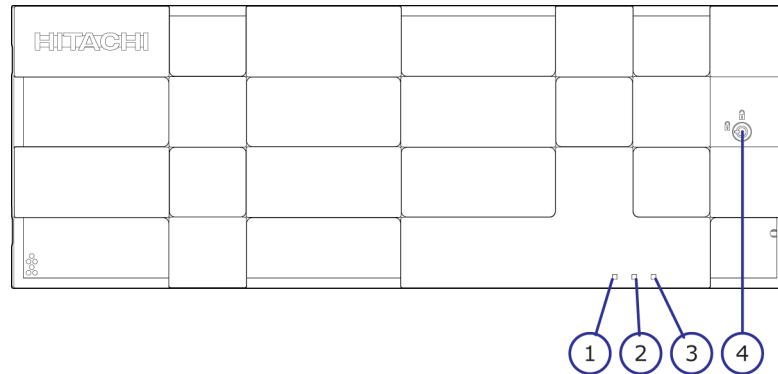

Number	Item	Description
1	POWER LED	Green: Drive tray is powered on.
2	READY LED	Green: Drive tray is operational.
3	Locate LED	Amber: <ul style="list-style-type: none"> <li>Indicates the location of the chassis.</li> <li>Can be turned on or turned off by the maintenance utility.</li> </ul>
4	Lock	Locks and unlocks the front panel bezel by using the supplied key.

## Dense intermix drive tray display LEDs

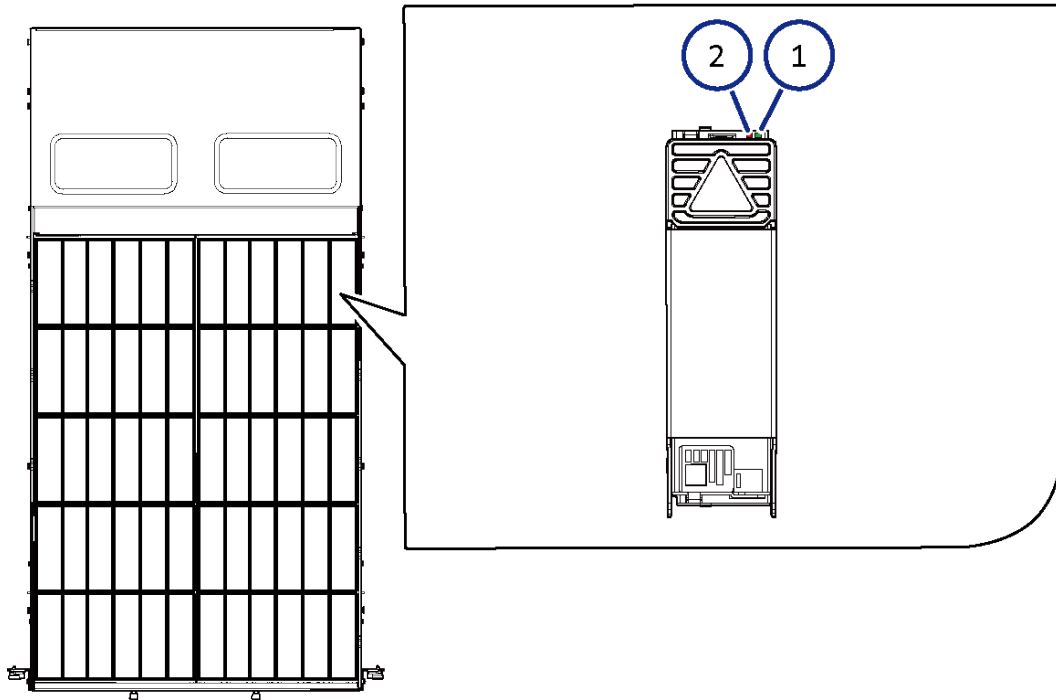

Number	Item	Description
1	ACT	Green: Normal operation. Blink: Drive is being accessed.
2	ALM LED	Red: Drive stopped due to a failure and can be replaced.



**Note:** At the rear of the drive tray, the drives are organized from left to right. On the left side of the preceding figure, the rear of the drive tray is at the top.

- Rear of drive tray: 48-59
- 36-47
- 24-35
- 12-23
- Front of drive tray: 00-11

## Dense intermix drive tray rear panel

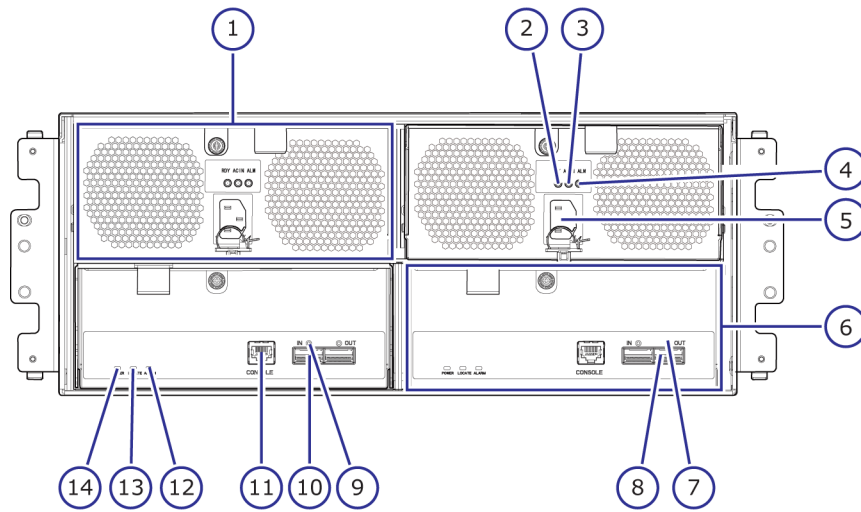

Number	Item	Description
1	Power supply unit	N/A
2	RDY LED	Green: Normal operation.
3	AC IN LED	Green: Normal operation.
4	ALM LED	Red: Power supply unit can be replaced.
5	Receptacle	Connects to the power cable provided with the storage system.
6	ENC	N/A
7	PATH (OUT) LED	Blue: OUT side port is linked up.
8	PATH (OUT) connector	Connects to a drive tray.
9	PATH (IN) LED	Blue: IN side port is linked up.
10	PATH (IN) connector	Connects to a controller or drive tray.
11	Console	This port is reserved.
12	ALARM LED	Red: ENC can be replaced.



Number	Item	Description
13	Locate LED	Amber: <ul style="list-style-type: none"><li data-bbox="1073 317 1398 380">▪ Indicates the location of the chassis.</li><li data-bbox="1073 401 1349 495">▪ Can be turned on or turned off by the maintenance utility.</li></ul>
14	POWER LED	Green: ENC is in the power-on state.

---

## Chapter 4: Host port expansion chassis

The host port expansion chassis contains various interconnect adapters that connect a host system to storage and other network devices. The interconnect adapters include PCIe boards and iSCSI and FC cards. For more information, contact customer support.

### Host port expansion chassis front panel bezel LEDs

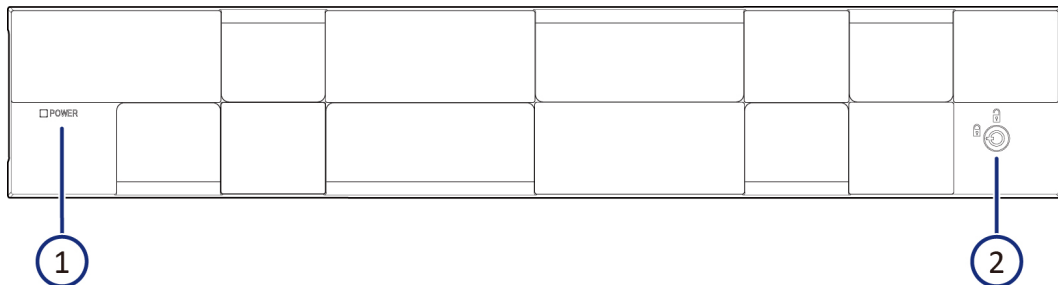

Number	Item	Description
1	POWER LED	Green: Host port expansion is turned on. Amber: PCIe module is turned on. Off: PCIe module is turned off.
2	Safety lock	Lock or unlock the front bezel.

### PCIe switchboard

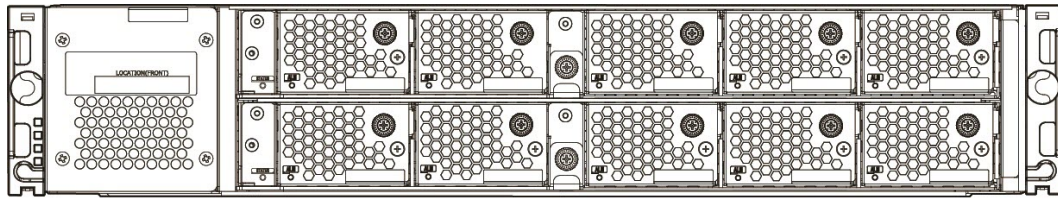

Front view of Expansion Chassis

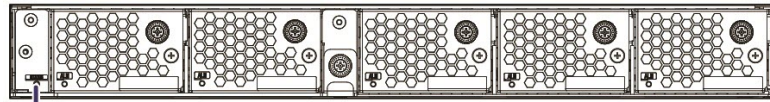

1

PCIe Switchboard

Number	Item	Description
1	STATUS LED	Green: PCIe switchboard is powered on. Red: PCIe switchboard can be replaced safely. Off: PCIe switchboard is powered off.

## Host port expansion chassis fan

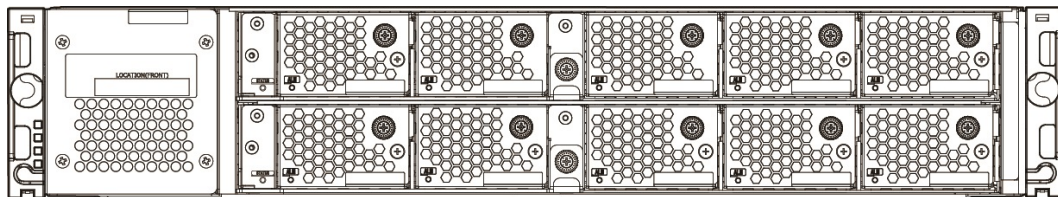

Front View of Expansion Chassis

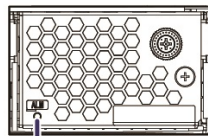

1

Expansion Chassis Fan

Number	Item	Description
1	ALM LED	Red: Fan failure has occurred. Off: Normal operation.

## PCIe cable connector

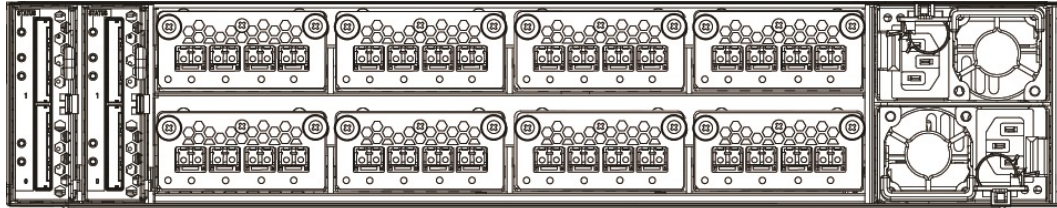

Rear View of Expansion Chassis

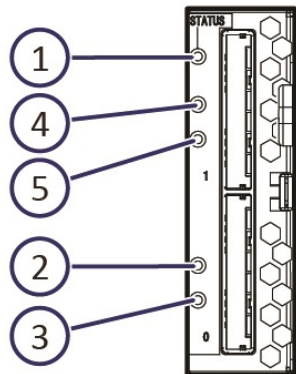

PCIe Cable Connector

Number	Item	Description
1	STATUS LED	Green: PCIe cable connector is powered on. Red: PCIe cable connector can be replaced safely. Off: PCIe cable connector is powered off.
2	Link Basic LED	Green: Basic PCIe Gen-3.0 (8-Gbps) is linked up normally. Off: Basic PCIe is not linked up (PCIe cable might not be connected). If a cable is connected, it can be removed safely.
3	InAct Basic LED	Amber: Basic PCIe status changed from link up to link down and cables. Cables can be removed safely. Off: Basic PCIe is normal or not set.

Number	Item	Description
4	Link Option LED	Green: Option PCIe Gen-3.0 (8-Gbps) is linked up normally. Off: Option PCIe is not linked up (PCIe cable might not be connected). If a cable is connected, it can be removed safely.
5	InAct Option LED	Amber: Option PCIe status changed from link up to link down and cables. Cables can be removed safely. Off: Option PCIe is normal or not set.

## Host port expansion chassis power supply

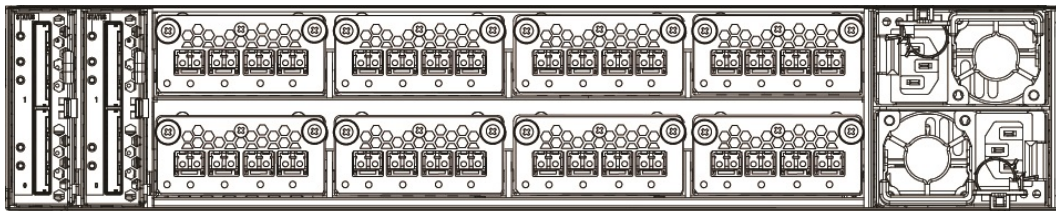

Rear View of the Expansion Chassis

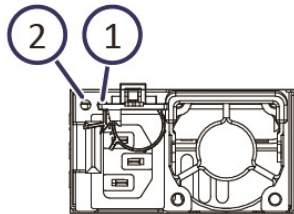

Expansion Chassis Power Supply 2

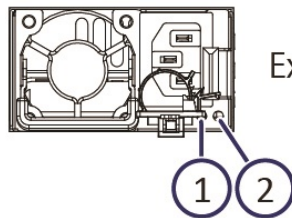

Expansion Chassis Power Supply 1

Number	Item	Description
1	ALM / RDY LED	Red: Host port expansion chassis power supply can be replaced safely. Green: Normal operation.

Number	Item	Description
2	AC IN LED	Blue: AC input is normal.

## Chapter 5: NAS module

The NAS module provides communication ports to support file system protocols in a block- or file-system configuration.

### NAS Module Ports and LEDs

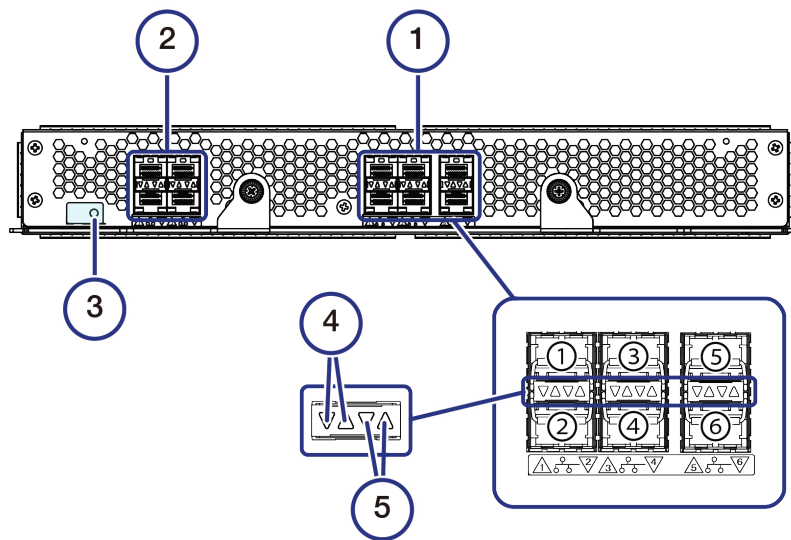

Legend	Name	Color	Description
1	User LAN port	-	This is used with the file level access.

Legend	Name	Color	Description
			<ol style="list-style-type: none"> <li>1. Target group 1</li> <li>2. Target group 2</li> <li>3. Target group 3</li> <li>4. Target group 4</li> <li>5. Target group 5</li> <li>6. Target group 6</li> </ol>
2	Cluster port	-	Reserved for future use
3	Status LED	Green	NAS modules are functioning normally.
		Red	NAS modules can be removed.
4	Link LED	Blue	Displays link status.
5	Fail LED	Red	A failure has occurred.



---

## Chapter 6: Maintaining the storage system

Ongoing proper maintenance of the storage system maintains the reliability of the storage system and its constant availability to all hosts connected to it.

For more complex maintenance activities, contact customer support.

### Storing the storage system

If the storage system does not receive power for more than six months, the battery can become discharged and possibly damaged. To avoid this situation, charge the battery for more than three hours at least once every six months.



**Note:** Do not store the equipment in an environment with temperatures of 104°F (40°C) or higher because battery life will be shortened.

### Powering off the storage system

Use the following procedure to power off the storage system. The main switch on the controller chassis is used to power off the storage system.

#### Before you begin

- Ensure that all software-specific shutdown procedures have been completed. Refer to the applicable user manuals for details.
- Ensure that all I/O activity to the storage system has stopped. You can vary paths offline and shut down the attached hosts.

#### Procedure

1. Press the main switch on the controller chassis for approximately three seconds until the `POWER` LED on the front of the chassis changes from solid green to a blinking status.
2. Release the main switch and the `POWER` LED returns to solid green after blinking for approximately three seconds.  
The power-off process begins. The process takes approximately 18 minutes or longer depending on the amount of data that needs to be written. The `POWER` LED is solid green during the powering off process. The `POWER` LED changes from green to amber when the process is completed.
3. Verify the `POWER` LED on the front of the storage system changes from green to amber.
4. To stop the power supply, remove the power cables from the power supply units on the controller chassis and drive box.

If the storage system is connected to a PDU, you can stop the power supply by turning off the PDU breaker.



**Note:** If the storage system does not receive power for more than six months, the battery can become discharged and possibly damaged. To avoid this situation, charge the battery for more than three hours at least once every six months.

## Battery unit

### Battery lifetime

The battery life time is affected by the battery temperature. The battery temperature changes depending on the intake temperature and height of the storage system, the configuration, operation of the controller boards and drives, charge-discharge count and others. The battery lifetime will be three to five years.

### Treatment

Use the storage system in a place where the ambient temperature is 86°F (30°C) or less on average.

Periodic parts replacement is required. If you have a maintenance service contract, parts are replaced periodically according to the terms of the contract.



**Note:** The battery protects the data in the cache memory in an emergency, such as a sudden power failure. In these cases, follow the normal power down procedure. If not, the battery might reach its lifespan earlier than expected and become unusable within three years. When replacing the battery, follow the given procedure for disposing a used battery.

### Replacement period

The battery lifetime (intake temperature is 30 degrees C or less.) in the standard environment is as shown below.

## Removing cables

Observe the following instructions when removing cables from the storage system.

To remove a SAS cable, pull the tab of the SAS cable (1) to release the latch and remove the SAS cable (2).

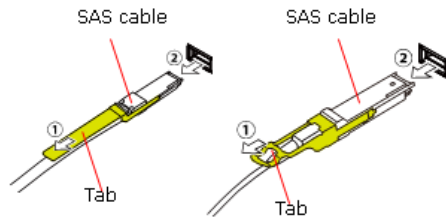

To remove an optical cable, push the top of the connector of the optical cable (1) to release the latch and remove the SAS cable (2).

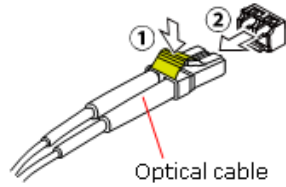

To remove a LAN cable, push the top of the LAN cable connector (1) to release the latch and remove the LAN cable (2).

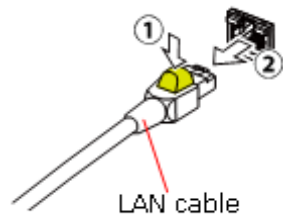

---

## Appendix A: Mechanical specifications for VSP G400, G600

The storage system mechanical specifications are described for VSP G400, G600.

### VSP G400 and VSP G600 mechanical specifications

#### Controller

Quantity	Component	Description
1	CBLM	A 4U controller chassis consisting of controllers, channel boards, disk boards, NAS module, AC or DC power supplies, and batteries with cooling fans.

**Drive trays**

Quantity	Component	Description
1	SFF drive tray	A drive tray that supports 2.5-inch disk drives and 2.5-inch flash drives. The drive tray consists of an ENC, cooling fans, and AC-DC power supplies or DC-DC power supplies.
1	LFF drive tray	A drive tray that supports 3.5-inch disk drives and 3.5-inch flash drives. The drive tray consists of an ENC, cooling fans, and AC-DC power supplies or DC-DC power supplies.
1	FMD tray	A drive tray that supports flash module drives and consists of an ENC and AC-DC power supplies equipped with built-in cooling fans.
1	Dense intermix drive tray (DB60)	A drive chassis that supports a variety of drive types such as 2.5-inch drives, 3.5-inch drives, and flash drives. The chassis consists of an ENC and AC-DC power supplies equipped with built-in cooling fans.

**NAS module**

Component	Description
NAS module	Component for block and file storage configuration

**Drive size**

Component	Specification
2.5-inch drive (SFF)	3.21 x 8.10 x 0.74 inches (81.6 x 205.7 x 18.7 mm)
3.5-inch drive (LFF and dense intermix drive tray - DB60)	4 x 5.78 x 1.02 inches (101.6 x 147.0 x 26.1 mm)
Flash Module Drive (flash module drive tray)	5.74 x 14.44 x 0.78 inches (146 x 366.8 x 19.8 mm)

**Data capacity (GB)**

Component	Specification
2.5-inch drive (SFF)	196.92, 288.20, 393.85, 472.61, 576.39, 945.23, 1152.79, 1729.29, 1890.46, 2305.58, 3780.92, 7561.85 GB
3.5-inch drive (LFF and dense intermix drive tray - DB60)	393.85, 1152.79, 1729.29, 2305.58*, 3916.14, 5874.22, 9790.36 GB
FMD	1759.21, 3518.43, 7036.87, 14073.74 GB
*Only available for DB60/DB60C dense intermix drive tray.	

**Rotational speed (min<sup>-1</sup>)**

Component	Specification
2.5-inch drive (SFF)	288.20 GB: 15,000 RPM 576.39 GB: 10,000 or 15,000 RPM 1152.79 GB: 10,000 RPM 1729.29 GB: 10,000 RPM 2305.58 GB: 10,000 RPM
3.5-inch drive (LFF and dense intermix drive tray - DB60)	2305.58 GB: 10,000 RPM* 3916.14 GB: 7,200 RPM 5874.22 GB: 7,200 RPM 9790.36 GB: 7,200 RPM
*Only available for DB60/DB60C dense intermix drive tray.	

**Maximum mountable quantity**

Mixing SFF, LFF, FMD, and dense intermix drive trays might affect the maximum number of drives that can be mounted.

Component	Specification
SFF	24
LFF	12
Flash module drive tray	12
Dense intermix drive tray (DB60)	60
Maximum number of flash module drives	VSP G400: 192 VSP G600: 288
Maximum number of spare drives	32

**Battery specifications**

Storage system intake temperature	CBLM
Up to 75.2° F (24° C)	5 years
Up to 86° F (30° C)	5 years
Up to 93.2° (34° C)	4 years
Up to 104° (40° C)	3 years

**Host interface**

Item	Component	Specification
Interface type	Fibre Channel optical	8-Gbps, 16-Gbps, 32-Gbps
	iSCSI optical	10-Gbps
	iSCSI copper	10-Gbps
	NAS module	10-Gbps (Fibre Channel optical)
Data transfer speed (maximum speed for transfer to host)	Fibre Channel optical	800-Mbps (Fibre Channel)
		1600-Mbps (Fibre Channel)
		3200-Mbps (Fibre Channel)

Item	Component	Specification
	iSCSI optical	10-Gbps (iSCSI optical)
	iSCSI copper	10-Gbps (iSCSI copper)
	NAS module (Fibre Channel)	1000 Mbs
Number of ports	8-Gbps Fibre Channel optical	64
	16-Gbps Fibre Channel optical (2-port)	32
	16-Gbps Fibre Channel optical (4-port)	64
	32-Gbps Fibre Channel optical (4-port)	64
	10-Gbps optical iSCSI	32
	10-Gbps copper iSCSI	32
Number of ports (NAS Module not installed)	8-Gbps Fibre Channel optical	64
	16-Gbps Fibre Channel optical (2-port)	32
	16-Gbps Fibre Channel optical (4-port)	64
	32-Gbps Fibre Channel optical (4-port)	64
	10-Gbps optical iSCSI	32
	10-Gbps copper iSCSI	32
Number of ports (NAS Module installed)	8-Gbps Fibre Channel optical	24
	16-Gbps Fibre Channel optical (2-port)	12
	16-Gbps Fibre Channel optical (4-port)	24
	32-Gbps Fibre Channel optical (4-port)	24
	10-Gbps optical iSCSI	12
	10-Gbps copper iSCSI	12



Item	Component	Specification
	10-Gbps Fibre Channel optical	12
Transferred block size		512 bytes
Maximum number of hosts using a Fibre Channel switch		255
Maximum number of hosts using a network switch		255

### RAID specifications

D: Data drive, P: Parity drive.

Although the storage system with a configuration of RAID 1, RAID 5, or RAID 6 provides data reliability enhanced by redundancy, there is a chance that user data could be lost due to an unexpected host, storage system hardware, or software failure. Therefore, users are requested to back up all data.

RAID Level	SAS, SAS 7.2k, flash drives mounted
RAID 1	2D+2D, 4D+4D
RAID 5	3D+1P, 4D+1P, 6D+1P, 7D+1P
RAID 6	6D+2P, 12D+2P, 14D+2P

Item	Specification
Maximum number of RAID groups	VSP G400 :160 VSP G600: 240
Maximum volume size	3 TB (or 4 TB when using the LDEVs of other storage systems)
Maximum volumes/host groups and iSCSI targets	2048
Maximum number of volumes per RAID group	2048

### Shared memory and data assurance

Item	Specification
Flash memory	32 MB
L3 Cache memory	4 MB
SDRAM	1 GB
Data bus	Parity
Cache memory	ECC (1 bit for correction, 2 bits for detection)
Drive	Data assurance code

### Start-up time

Item
Standard: 5-to-8 minutes. The start-up time may be longer in proportion to the number of drive trays connected. With a maximum configuration 1 controller tray and 19 drive trays, start-up time is approximately 8 minutes.

### Chassis size

Component	Specification (WxDxH)
CBLM	19.01 x 35.10 x 6.86 inches (483 x 891.7 x 174.3 mm)
SFF	18.97 x 22.24 x 3.47 inches (482 x 565 x 88.2 mm)
LFF	18.97 x 22.24 x 3.47 inches (482 x 565 x 88.2 mm)
DBF	19.01 x 30 x 3.42 inches (483 x 762 x 87 mm)
Dense intermix drive tray (DB60)	18.97 x 40.51 x 6.92 inches (482 x 1,029 x 176 mm) (includes the depth of the cable-management arms)

**Mass**

The table lists the values of a maximum configuration when all controllers and drives are mounted.

Component	Specification
CBLM	187.39 pounds (85 kg)
SFF	Approx 50.70 inches (23 kg)
LFF	Approx 59.52 inches (27 kg)
DBF	Approx. 83.77 pounds (38 kg)
Dense intermix drive tray (DB60)	Approx. 198.41 pounds (90 kg)

**Required height**

Component	Specification
CBLM	4 U
SFF	2 U
LFF	2 U
DBF	2 U
Dense intermix drive tray (DB60)	4 U  If a drive is inserted into a slot of a dense intermix drive tray when the installed number of drives exceeds 240 slots per path, the drive is blocked.

**Cache specifications**

Item	Specification
Capacity (GB)	VSP G400: 128 VSP G600: 256
NAS module Cache Capacity	DDR3 DIMM 8GB x 12 [Slot]

Item	Specification
	Note: <ul style="list-style-type: none"> <li>▪ All 12 slots must be fully installed with DIMMs.</li> <li>▪ Each DIMM is replaceable when they fail.</li> <li>▪ The DIMM is not common and cannot be used with DKC DIMM.</li> </ul>
Control method	Read LRU, Write after
Battery backup	Provided
Backup duration	Unrestricted (saving to a nonvolatile memory)

Data in the cache memory is preserved against power failures. If a power outage occurs, data in cache memory is written to drives.

When the storage system enters Cache Backup mode, the amber **WARNING** LED goes on to when the system starts. This warning indicates that the battery charge has dropped significantly and the remaining battery capacity is not sufficient; the storage system will continue operating with the Write Cache function disabled.

When the battery is charged, the warning indication disappears, and the storage system continues the operation in the Write Cache function.

The warning indication disappears within six hours. Even when the warning is shown, normal operation is assured in Write-Through. Read and write performance is lowered because the Write Cache function is disabled.

If the storage system is not charged for more than six months, the battery can become overcharged and sustain unrecoverable damage. To avoid this situation, charge the battery more than 3 hours every six months.

### Insulation performance

Item	Specification
Insulation withstand voltage	AC 1,500 V (100 mA, 1 min)
Insulation resistance	DC 500 V, 10 M $\Omega$ or more

## Appendix B: Electrical specifications for VSP G400, G600

The electrical specifications are described for the storage systems.

### Electrical specifications

Item	Controller	Drive tray
Input voltage (operable voltage range) (V)	AC 200-240 +6%/-11%	SFF, LFF, FMD, and dense intermix drive tray: AC 200-240 +6%/-11%
Frequency (Hz)	50/60 ±1	
Number of phases, cabling	Single-phase with protective grounding	
Steady-state current 100V/200V <sup>1, 2</sup>	CBLM: 4.0x2	SFF drive tray: 2.4x2/1.2x2 LFF drive tray: 1.9x2/1.0x2 FMD drive tray: 2.6x2/1.3x2 Dense intermix drive tray: -/ 3.0x2
Current rating of breaker/fuse (A)	16.0 (each electrical)	
Heat value (normal) (kJ/h)	CBLM: 2160 or less	SFF drive tray: 1120 or less LFF drive tray: 940 or less FMD drive tray: 1520 or less Dense intermix drive tray: 3460 or less
Steady-state power (VA/W) <sup>3</sup>	CBLM: 1600/1560 or less	SFF drive tray: 480/460 or less LFF drive tray: 380/350 or less FMD drive tray: 520/490 or less

Item	Controller	Drive tray
		Dense intermix drive tray: 1200/1160 or less
Power consumption (VA/W)	CBLM: 640/600 or less	SFF drive tray: 320/310 or less  LFF drive tray: 280/260 or less  FMD drive tray: 440/420 or less  Dense intermix drive tray: 1000/960 or less
<p><b>Notes:</b></p> <ol style="list-style-type: none"> <li>1. The power current of Nx2 described in this table is required for a single power unit.</li> <li>2. If one power unit fails, another power unit requires electric current for the two power units. Therefore, plan the power supply facility so that the current-carrying capacity for one power unit can provide the total capacity for two power units.</li> <li>3. This table shows the power requirement (100 V or 200 V) for the maximum configuration . The actual required power might exceed the value shown in the table when the tolerance is included.</li> </ol>		

## Appendix C: Environmental specifications for VSP G400, G600

The environmental specifications are described for the storage systems.

### Environmental specifications

#### Temperature

**⚠ Caution:** The following storage system components are not supported in high-temperature environments. Do not operate the following components at temperatures of 40°C or higher:

- DB60 dense drive tray
- HDS provided service processor (SVP) server
- First-generation FMDs (non-DC2 FMDs)

State	Controller	SFF, LFF drive trays	Dense intermix drive tray
Operating	50°F to 104°F (10°C to 40°C)	50°F to 104°F (10°C to 40°C)	50°F to 95°F (10°C to 35°C)
Non-operating	14°F to 122°F (-10°C to 50°C)	14°F to 122°F (-10°C to 50°C)	14°F to 122°F (-10°C to 50°C)
Transport, storage	-22°F to 140°F (-30°C to 60°C)	-22°F to 140°F (-30°C to 60°C)	-22°F to 140°F (-30°C to 60°C)
Temperature change rate (°C/h)	10 or less		

State	Controller	FMD drive trays
Operating	50°F to 104°F (10°C to 40°C)	DKC-F710I-1R6FM or DKC-F710I-3R2FM drive is installed: 50°F to 95°F (10°C to 35°C)

State	Controller	FMD drive trays
Operating	50°F to 104°F (10°C to 40°C)	DKC-F810I-1R6FN/3R2FN/6R4FN/7R0FP/14RFP drive is installed: 50°F to 104°F (10°C to 40°C)
Non-operating	14°F to 122°F (-10°C to 50°C)	14°F to 95°F (-10°C to 35°C)
Transport, storage	-22°F to 140°F (-30°C to 60°C)	-22°F to 122°F (-30°C to 50°C)
Temperature change rate (°C/h)	10 or less	

### Humidity

State	Percentage
Operating	8 to 80
Non-operating	8 to 90
Transport, storage (%)	5 to 95
Maximum wet bulb temperature (°C)	29 (non-condensing)

### Vibration

State	m/s <sup>2</sup>
Operating	2.5 or less Within 5 seconds (resonance point: 10 Hz or less)
Non-operating	5.0 or less at 5 Hz to 300 Hz (no damage to product) 9.8 (1.0 G) Within 5 seconds (resonance point: 10 Hz or less)
Transport (packed)	5.0 or less



**Impact**

State	m/s <sup>2</sup>
Operating	20 or less (10 ms, half sine wave)
Non-operating	50 or less (10 ms, half sine wave)
Transport (packed)	80 or less

**Altitude**

State	Controller	FMD drive
Operating (m)	3,000 (Environmental temperature: 10°C to 32°C)  900 (Environmental temperature: 10°C to 40°C)	3,000 (Environmental temperature 10°C to 32°C)  OR  900 (Environmental temperature: 10°C to 35°C) when DKC-F710I-1R6FM or DKC-F710I-3R2FM drive is installed.
Operating (m)	3,000 (Environmental temperature: 10°C to 32°C)  900 (Environmental temperature: 10°C to 40°C)	3,000 (Environmental temperature: 10°C to 32°C)  OR  900 (Environmental temperature: 10°C to 40°C) when DKC-F810I-1R6FN/3R2FN/6R4FN/7R0FP/14RFP drive is installed.
Non-operating (m)	-60 to 12,000	N/A

State	Controller	SFF and LFF drives	Dense intermix drive tray
Operating (m)	3,000 (Environmental temperature: 10°C to 32°C)	3,000 (Environmental temperature: 10°C to 32°C)	3,000 (Environmental temperature: 10°C to 28°C) 1,000 (Environmental temperature: 10°C to 35°C)
	900 (Environmental temperature: 10°C to 40°C)	900 (Environmental temperature: 10°C to 40°C)	
Non-operating (m)		N/A	

### Atmosphere

Avoid areas exposed to corrosive gas and salty air.

### Acoustic Noise

State	Controller	SFF, LFF	Dense intermix drive tray
Operating	60 dB (Environmental temperature 32°C or less) <sup>1</sup>	60 dB (Environmental temperature 32°C or less) <sup>1</sup>	71 dB (Environmental temperature 32°C or less) <sup>1, 2, 3, 4</sup>
Non-operating	55 dB	55 dB	71 dB (Environmental temperature 32°C or less) <sup>1, 2, 3, 4</sup>

State	Controller	SFF, LFF	Dense intermix drive tray
<p><b>Notes:</b></p> <ol style="list-style-type: none"> <li>1. The system's internal temperature controls the rotating speed of the fan module. Therefore, this standard value might be exceeded if the maximum load continues under high-temperature environment or if a failure occurs in the system.</li> <li>2. Sound pressure level (LA) changes from 66 dB or 75 dB, according to the ambient temperature, drive configuration, and operating status. Maximum volume can reach 79 dB during maintenance procedure for a failed ENC or power supply.</li> <li>3. Acoustic power level (LwA) measured by the ISO 7779 standard is 7.2 B. This value changes from 7.2 B to 8.1 B, according to the ambient temperature, drive configuration, and operating status.</li> <li>4. When accessing the dense intermix drive tray, do not work for long times at the rear of the rack.</li> </ol>			

State	Controller	FMD	
Operating	60 dB (Environmental temperature 32°C or less) <sup>1</sup>	60 dB (Environmental temperature 32°C or less) <sup>1, 2, 3</sup> (When accessing the dense intermix drive tray, do not work for long times at the rear of the rack.)	
Non-operating	55 dB (Environmental temperature 32°C or less) <sup>1, 2, 3, 4</sup> 55 dB		
<p><b>Notes:</b></p> <ol style="list-style-type: none"> <li>1. The system's internal temperature controls the rotating speed of the fan module. Therefore, this standard value might be exceeded if the maximum load continues under high-temperature environment or if a failure occurs in the system.</li> <li>2. Sound pressure level (LA) changes from 66 dB or 75 dB, according to the ambient temperature, drive configuration, and operating status. Maximum volume can reach 79 dB during maintenance procedure for a failed ENC or power supply.</li> <li>3. Acoustic power level (LwA) measured by the ISO 7779 standard is 7.2 B. This value changes from 7.2 B to 8.1 B, according to the ambient temperature, drive configuration, and operating status.</li> </ol>			

**Noise Level**

State	Condition
Operating (Recommended)	90 dB or less*
<p><b>Note:</b></p> <p>*Fire suppression systems and acoustic noise:</p> <p>Some data center inert gas fire suppression systems when activated release gas from pressurized cylinders that moves through the pipes at very high velocity. The gas exits through multiple nozzles in the data center. The release through the nozzles could generate high-level acoustic noise. Similarly, pneumatic sirens could also generate high-level acoustic noise. These acoustic noises may cause vibrations to the hard disk drives in the storage systems resulting in I/O errors, performance degradation in and to some extent damage to the hard disk drives. Hard disk drives (HDD) noise level tolerance may vary among different models, designs, capacities and manufactures. The acoustic noise level of 90 dB or less in the operating environment table represents the current operating environment guidelines in which Hitachi storage systems are designed and manufactured for reliable operation when placed 2 meters from the source of the noise.</p> <p>Hitachi does not test storage systems and hard disk drives for compatibility with fire suppression systems and pneumatic sirens. Hitachi also does not provide recommendations or claim compatibility with any fire suppression systems and pneumatic sirens. The customer is responsible to follow their local or national regulations.</p> <p>To prevent unnecessary I/O error or damages to the hard disk drives in the storage systems, Hitachi recommends the following options:</p> <ol style="list-style-type: none"> <li>1. Install noise-reducing baffles to mitigate the noise to the hard disk drives in the storage systems.</li> <li>2. Consult the fire suppression system manufacturers on noise reduction nozzles to reduce the acoustic noise to protect the hard disk drives in the storage systems.</li> <li>3. Locate the storage system as far as possible from noise sources such as emergency sirens.</li> <li>4. If it can be safely done without risk of personal injury, shut down the storage systems to avoid data loss and damages to the hard disk drives in the storage systems.</li> </ol> <p>Damage to the hard disk drives from fire suppression systems or pneumatic sirens will void the hard disk drive warranty.</p>	

---

## Appendix D: iSCSI standards and specifications

The following tables describe the standards and specifications for using iSCSI in a hosting environment.

### iSCSI standards

The following standards apply to the management, maintenance, and iSCSI data ports. To configure this system, use switches that comply with the following standards:

- IEEE 802.1D STP
- IEEE 802.1w RSTP
- IEEE 802.3 CSMA/CD
- IEEE 802.3u Fast Ethernet
- IEEE 802.3z 1000 BASE-X
- IEEE 802.1Q Virtual LANs
- IEEE 802.3ae 10 Gigabit Ethernet
- RFC 768 UDP
- RFC 783 TFTP
- RFC 791 IP
- RFC 793 TCP
- RFC 1157 SNMP v1
- RFC 1231 MIB II
- RFC 1757 RMON
- RFC 1901 SNMPv2

### iSCSI specifications

Item	Specification	Comments
iSCSI target function	Supported	N/A
iSCSI target function	Supported	TrueCopy® only

Item	Specification	Comments
iSCSI ports	2 per interface board	Maximum 32 per iSCSI system
Connection methods	Direct and switch connections	
Host connections	255 (maximum per iSCSI port)	With Linux software initiator, the maximum number decreases.
Path failover	HDLM <sup>1</sup>	Supports Microsoft MPIO (Multi Path I/O)
Link	10 Gbps SFP+	N/A
Transfer speed	10 Gbps	N/A
Connector type	LC	N/A
Cable	Optical OM3, OM2 MMF cable	N/A
Network switch	L2 or L3 switch	Should comply with IEEE802.3ae
Switch cascading	Maximum: 5 switches or fewer	Minimum number of cascading switches is recommended.
MAC address	Per port (fixed value)	Factory setting: World Wide Unique value. Cannot be changed.
Maximum transfer unit (MTU)	1,500, 4,500, 9,000 bytes (Ethernet frame)	Jumbo frame, MTU size greater than 1500
Link aggregation	Not supported	N/A
Tagged VLAN	Supported	N/A
IPv4	Supported	N/A

Item	Specification	Comments
IPv6	Supported	<p>Note the following precautions:</p> <ul style="list-style-type: none"> <li>▪ When iSCSI Port IPv6 is set to Enabled, if the IPv6 global address is set to automatic, the address is determined by acquiring a prefix from an IPv6 router.</li> <li>▪ If the IPv6 router does not exist in the network, the address cannot be determined. As a result, an iSCSI connection might be delayed. When an iSCSI Port IPv6 is set to Enabled, verify the IPv6 router is connected to the same network, and then set IPv6 global address automatically.</li> </ul>
Subnet mask	Supported	N/A
Gateway address	Supported	N/A
DHCP	N/A	N/A
DNS	N/A	N/A
Ping (ICMP ECHO) Transmit, Receive	Supported	N/A
IPsec <sup>2</sup>	N/A	N/A

Item	Specification	Comments
TCP port number	3260	Changeable among 1 to 65,535. Observe the following if changing values: <ul style="list-style-type: none"> <li>▪ The setting of the corresponding host should also be changed to log in the new port number.</li> <li>▪ The new port number might conflict with other network communication or be filtered on some network equipment, preventing the storage system from communicating through the new port number.</li> </ul>
iSCSI name	Both iqn <sup>3</sup> and eui <sup>4</sup> types are supported	The unique iqn value is automatically set when a target is made. iSCSI name is configurable.
Error recovery level	0 (zero)	Error recovery by retrying from host. Does not support Level 1 and Level 2.
Header digest	Supported	Detects header error or data error with iSCSI communication. The storage system follows the host's digest setting. If digest is enabled, the performance degrades. The amount of the degradation depends on factors such as host performance of host and transaction pattern.
Data digest	Supported	
Maximum iSCSI connections at one time	255 per iSCSI port	N/A
CHAP	Supported	Authentication: login request is sent properly from host to storage. CHAP is not supported during discovery session.



Item	Specification	Comments
Mutual (2-way) CHAP	Supported (not available if connected to Linux software initiator)	Authentication: login request is sent properly from host to storage.
CHAP user registration	Max 512 users per iSCSI port	N/A
iSNS	Supported	With iSNS (name service), a host can discover a target without knowing the target's IP address.
<p><b>Note:</b></p> <ol style="list-style-type: none"> <li>1. JP1, HiCommand Dynamic Link Manager. Pass switching is achieved. Not supported on Windows Vista and Windows 7 operating systems.</li> <li>2. IP Security. Authentication and encryption of IP packets. The storage system does not support IPsec.</li> <li>3. iqn: iSCSI Qualified Name. The iqn consists of a type identifier, "iqn," a date of domain acquisition, a domain name, and a character string given by the individual who acquired the domain. Example: <u>iqn.1994-04.jp.co.hitachi:rsd.d7m.t.10020.1b000.tar</u></li> <li>4. eui: 64-bit Extended Unique Identifier. The eui consists of a type identifier, "eui," and an ASCII-coded, hexadecimal, EUI-64 identifier. Example: <u>eui.0123456789abcdef</u></li> </ol>		

---

## Appendix E: Replacement parts

Part replacement is essential for maintaining the high performance of the system. Replacing system components is covered by the maintenance service contract.

### Battery unit

#### Battery lifetime

The battery life time is affected by the battery temperature. The battery temperature changes depending on the intake temperature and height of the storage system, the configuration, operation of the controller boards and drives, charge-discharge count and others. The battery lifetime will be three to five years.

#### Treatment

Use the storage system in a place where the ambient temperature is 86°F (30°C) or less on average.

Periodic parts replacement is required. If you have a maintenance service contract, parts are replaced periodically according to the terms of the contract.



**Note:** The battery protects the data in the cache memory in an emergency, such as a sudden power failure. In these cases, follow the normal power down procedure. If not, the battery might reach its lifespan earlier than expected and become unusable within three years. When replacing the battery, follow the given procedure for disposing a used battery.

#### Replacement period

The battery lifetime (intake temperature is 30 degrees C or less.) in the standard environment is as shown below.

---

## Appendix F: Data and power cables

The storage system supports a variety of data and power cables for specific hosting environments.

### Required cables

The quantities and lengths of the cables required for storage system installation vary according to the specific storage system and network configuration. Fibre Channel and iSCSI cables are used to connect the controllers to a switch or host. Serial-attached SCSI (SAS) cables are used to connect drive trays to controllers and other drive trays.

The following table describes the cables required to perform storage system connections at the time of installation.

Interface type	Connector type	Cable requirements
Fibre Channel	LC-LC	Use a Fibre Channel cable to connect the Fibre Channel ports on each controller to a host computer (direct connection), or to several host computers via a Fibre Channel switch. See the note and table below.
iSCSI (optical)	LC-LC	Use an optical Ethernet cable to connect the iSCSI 10 Gb SFP ports on each controller to a host computer (direct connection), or to several host computers via an Ethernet switch.
iSCSI (copper)	RJ-45	Use a shielded Category 5e or 6a Ethernet cable to connect the iSCSI 10 Gb RJ-45 ports on each controller to a host computer (direct connection), or to several host computers via an Ethernet switch.
SAS	SAS optical	Connects the controller to a drive tray or a drive tray to another drive tray. Two SAS cables are provided with each drive tray. SAS cables are also used to connect NAS modules to switches.
Ethernet	RJ-45	Four shielded Category 5e or 6a Ethernet cables are required for connecting the SVP to the controllers, management console PC, and network switch.



**Note:** The maximum distances in a typical Fibre Channel SAN depend on the kind of optical fiber used and its diameter. The following table lists the maximum supported Fibre Channel cable length based on cable size and port speed.

Cable size	Speed	Maximum cable length
9 micron	1 Gbps	1 km (3281 ft)
	2 Gbps	2 km (6562 ft)
50 micron	2 Gbps	300 m

Cable size	Speed	Maximum cable length
		(984.2 ft)
	4 Gbps	150 m (492.1 ft)
	8 Gbps	50 m (164 ft)
	16 Gbps	35 m (115 ft)
62.5 micron	2 Gbps	100 m (328.1 ft)
	4 Gbps	70 m (230 ft)
	8 Gbps	21 m (69 ft)

## Fibre Channel cables

The storage system supports Fiber Channel connections to hosts. For details about configuring FC host connections, see the *Provisioning Guide*.



**Note:** Due to high-speed serial data transfer via Fibre Channel, use high-quality FC cables that comply with the Fibre Channel-PH standard.

The following figure shows FC direct connection and FC connection through a switch.

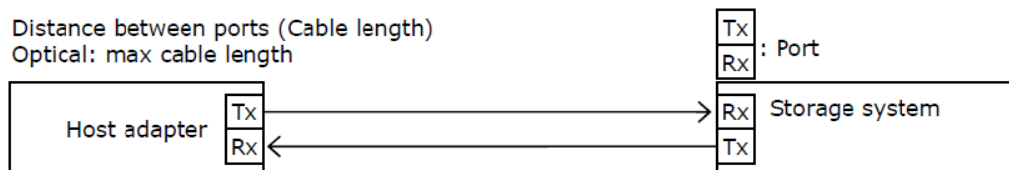

(a) Direct Connection

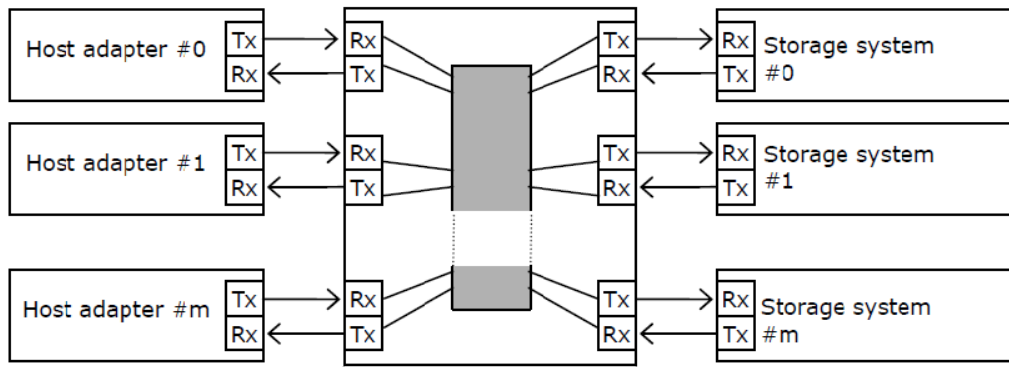

SW configuration  
(b) Fibre Channel Switch Connection

The following table lists the data transfer rates and provides the maximum cable lengths.

Data transfer rate	Maximum length of cable			
	Multimode cable			Single mode cable
	OM2	OM3	OM4	
2 Gbps	984.25 ft (300 m)	1640.4 ft (500 m)	—	3280.8 ft (10 km)
4 Gbps	493 ft (150 m)	1246.72 ft (380 m)	1312.3 ft (400 m)	
8 Gbps	164.04 ft (50 m)	493 ft (150 m)	623.36 ft (190 m)	
16 Gbps	114.8 ft (35 m)	328.08 ft (100 m)	410.1 ft (125 m)	—
32 Gbps	65.62 ft (20 m)	229.7 ft (70 m)	328.08 ft (100 m)	—

The following table lists specifications of the Fibre Channel interface cable.

Cable type	Interface	Cable mode name	Nominal		
			Cable	Connector	
				One side	Other side
LC-LC cable (shortwave)	Optical	Equivalent to DXLC-2P-PC-xxM-GC50, 125-2SR (OMx)	50, 125 µm, 62.5, 125 µm Multimode Wavelength: 850 nm	LC connector	LC connector
LC-LC cable (longwave)		DXLC-2PS-SPC-xxM-SMC 10/125-2SR	9/125 µm Singlemode Wavelength: 1300 nm		

The following figure shows the connector used for optical interfaces.

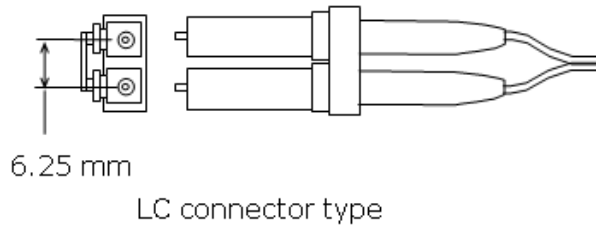

The following figure shows the type of optical connector that connects the storage system Fibre Channel ports.

- LC connector type
- **Connector type:** LC duplex receptacle connector
- **Interval:** 6.25 mm flat type, two rows

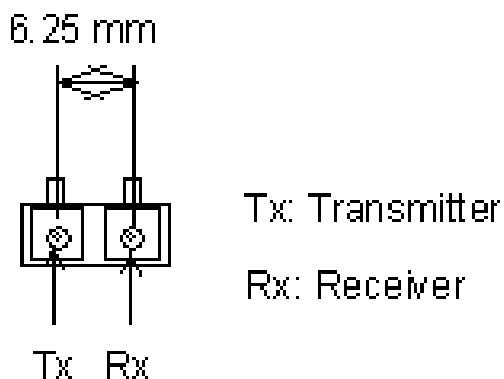

LC connector type

## iSCSI cables

The storage system supports iSCSI connections to hosts. For details about configuring iSCSI host connections, see the Provisioning Guide.

### Cable specifications for iSCSI optical interface

Cable type	Interface	Cable mode name	Nominal		
			Cable	Connector	
				One side	Other side
LC-LC cable	Optical	Equivalent to DXLC-2P-PC-xxM-GC50, 125-2SR (OMx)	50, 125 mm Multimode Wavelength: 850 nm	LC connector	LC connector



The following figure shows the connector used for optical interfaces.

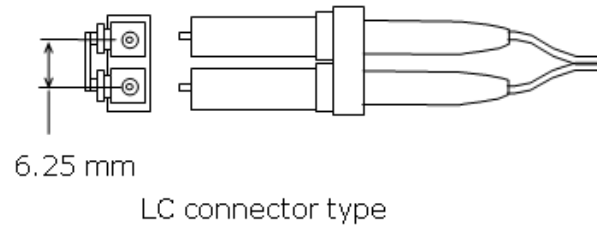

The following figure shows the type of optical connector that connects the storage system optical iSCSI ports.

- LC connector type
- **Connector type:** LC duplex receptacle connector
- **Interval:** 6.25 mm flat type, two rows

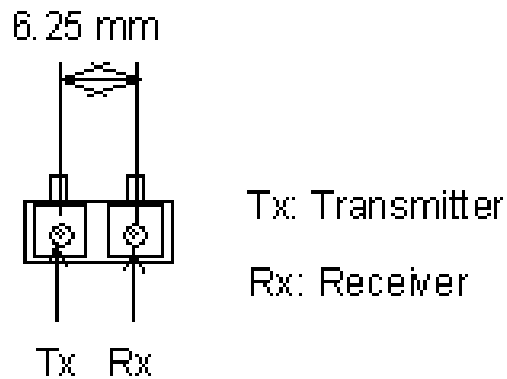

LC connector type

#### Cable specifications for 10 Gbps iSCSI copper interface

Cable type	Maximum cable connection length	Data transfer	Transmission band	Cable	Connector
Category 5e or 6a LAN cable	100 m	1 Gbps	1000BASE-T	STP ( use an STP cable that suppresses radio noise)	RJ-45
Category 6a LAN cable	50 m	10 Gbps	10GBASE-T	STP ( use an STP cable that suppresses radio noise)	RJ-45

The following figure shows a 10 Gbps iSCSI cable.

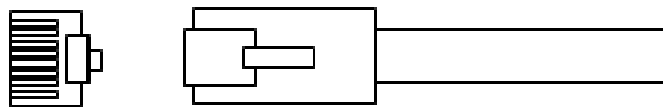

## iSCSI standards

The following standards apply to the management, maintenance, and iSCSI data ports. To configure this system, use switches that comply with the following standards:

- IEEE 802.1D STP
- IEEE 802.1w RSTP
- IEEE 802.3 CSMA/CD
- IEEE 802.3u Fast Ethernet
- IEEE 802.3z 1000 BASE-X
- IEEE 802.1Q Virtual LANs
- IEEE 802.3ae 10 Gigabit Ethernet
- RFC 768 UDP
- RFC 783 TFTP
- RFC 791 IP
- RFC 793 TCP
- RFC 1157 SNMP v1
- RFC 1231 MIB II
- RFC 1757 RMON
- RFC 1901 SNMPv2

## iSCSI specifications

Item	Specification	Comments
iSCSI target function	Supported	N/A
iSCSI target function	Supported	TrueCopy® only
iSCSI ports	2 per interface board	Maximum 32 per iSCSI system
Connection methods	Direct and switch connections	
Host connections	255 (maximum per iSCSI port)	With Linux software initiator, the maximum number decreases.
Path failover	HDLM <sup>1</sup>	Supports Microsoft MPIO (Multi Path I/O)
Link	10 Gbps SFP+	N/A
Transfer speed	10 Gbps	N/A
Connector type	LC	N/A
Cable	Optical OM3, OM2 MMF cable	N/A
Network switch	L2 or L3 switch	Should comply with IEEE802.3ae
Switch cascading	Maximum: 5 switches or fewer	Minimum number of cascading switches is recommended.
MAC address	Per port (fixed value)	Factory setting: World Wide Unique value. Cannot be changed.
Maximum transfer unit (MTU)	1,500, 4,500, 9,000 bytes (Ethernet frame)	Jumbo frame, MTU size greater than 1500
Link aggregation	Not supported	N/A
Tagged VLAN	Supported	N/A
IPv4	Supported	N/A

Item	Specification	Comments
IPv6	Supported	<p>Note the following precautions:</p> <ul style="list-style-type: none"> <li>▪ When iSCSI Port IPv6 is set to Enabled, if the IPv6 global address is set to automatic, the address is determined by acquiring a prefix from an IPv6 router.</li> <li>▪ If the IPv6 router does not exist in the network, the address cannot be determined. As a result, an iSCSI connection might be delayed. When an iSCSI Port IPv6 is set to Enabled, verify the IPv6 router is connected to the same network, and then set IPv6 global address automatically.</li> </ul>
Subnet mask	Supported	N/A
Gateway address	Supported	N/A
DHCP	N/A	N/A
DNS	N/A	N/A
Ping (ICMP ECHO) Transmit, Receive	Supported	N/A
IPsec <sup>2</sup>	N/A	N/A

Item	Specification	Comments
TCP port number	3260	Changeable among 1 to 65,535. Observe the following if changing values: <ul style="list-style-type: none"> <li>▪ The setting of the corresponding host should also be changed to log in the new port number.</li> <li>▪ The new port number might conflict with other network communication or be filtered on some network equipment, preventing the storage system from communicating through the new port number.</li> </ul>
iSCSI name	Both iqn <sup>3</sup> and eui <sup>4</sup> types are supported	The unique iqn value is automatically set when a target is made. iSCSI name is configurable.
Error recovery level	0 (zero)	Error recovery by retrying from host. Does not support Level 1 and Level 2.
Header digest	Supported	Detects header error or data error with iSCSI communication. The storage system follows the host's digest setting. If digest is enabled, the performance degrades. The amount of the degradation depends on factors such as host performance of host and transaction pattern.
Data digest	Supported	
Maximum iSCSI connections at one time	255 per iSCSI port	N/A
CHAP	Supported	Authentication: login request is sent properly from host to storage. CHAP is not supported during discovery session.

Item	Specification	Comments
Mutual (2-way) CHAP	Supported (not available if connected to Linux software initiator)	Authentication: login request is sent properly from host to storage.
CHAP user registration	Max 512 users per iSCSI port	N/A
iSNS	Supported	With iSNS (name service), a host can discover a target without knowing the target's IP address.
<p><b>Note:</b></p> <ol style="list-style-type: none"> <li>1. JP1, HiCommand Dynamic Link Manager. Pass switching is achieved. Not supported on Windows Vista and Windows 7 operating systems.</li> <li>2. IP Security. Authentication and encryption of IP packets. The storage system does not support IPsec.</li> <li>3. iqn: iSCSI Qualified Name. The iqn consists of a type identifier, "iqn," a date of domain acquisition, a domain name, and a character string given by the individual who acquired the domain. Example: <code>iqn.1994-04.jp.co.hitachi:rsd.d7m.t.10020.1b000.tar</code></li> <li>4. eui: 64-bit Extended Unique Identifier. The eui consists of a type identifier, "eui," and an ASCII-coded, hexadecimal, EUI-64 identifier. Example: <code>eui.0123456789abcdef</code></li> </ol>		

## Managing cables

Organize cables to protect the integrity of your connections and allow proper airflow around your storage system.

### Observing bend radius values

Never bend cables beyond their recommended bend radius. The following table provides general guidelines for minimum bend radius values, but you should consult the recommendation of your cable manufacturer.

Cable type	Minimum bend radius values
Fibre Channel	40 mm (1.73 inch)
iSCSI optical	40 mm (1.73 inch)
Category 5 Ethernet	Four times the outside diameter of the cable
SAS	40 mm (1.73 inch)

## Protecting cables

Damage to the cables can affect the performance of your storage system. Observe the following guidelines to protect the cables:

- Keep cables away from sharp edges or metal corners.
- When bundling cables, do not pinch or constrict the cables.
- Do not use zip ties to bundle cables. Instead, use Velcro hook-and-loop ties that do not have hard edges and which you can remove without cutting.
- Never bundle network cables with power cables. If network and power cables are not bundled separately, electromagnetic interference (EMI) can affect your data stream.
- If you run cables from overhead supports or from below a raised floor, include vertical distances when calculating necessary cable lengths.
- If you use overhead cable supports:
  - Verify that your supports are anchored adequately to withstand the weight of bundled cables.
  - Gravity can stretch and damage cables over time. Therefore, do not allow cables to sag through gaps in your supports.
  - Place drop points in your supports that permit cables to reach racks without bending or pulling.
- Unintentional unplugging or unseating of a power cable can have a serious impact on the operation of an enterprise storage system. Unlike data cables, power connectors do not have built-in retention mechanisms to prevent this from happening.

To prevent accidental unplugging or unseating of power cables, the storage system includes a rubber cable-retention strap near the AC receptacle on each controller. These straps, shown in the following image, loop around the neck of a power cable connector, and the notched tail is slipped over the hook of the restraining bar fixed to the storage system.

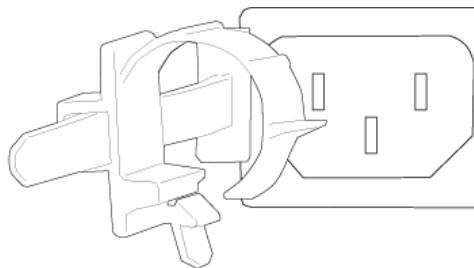

## Cabling full-width modules

When cabling full-width modules, such as NAS modules as shown in the following figure, route the cables horizontally, so that they do not interfere when replacing a module.

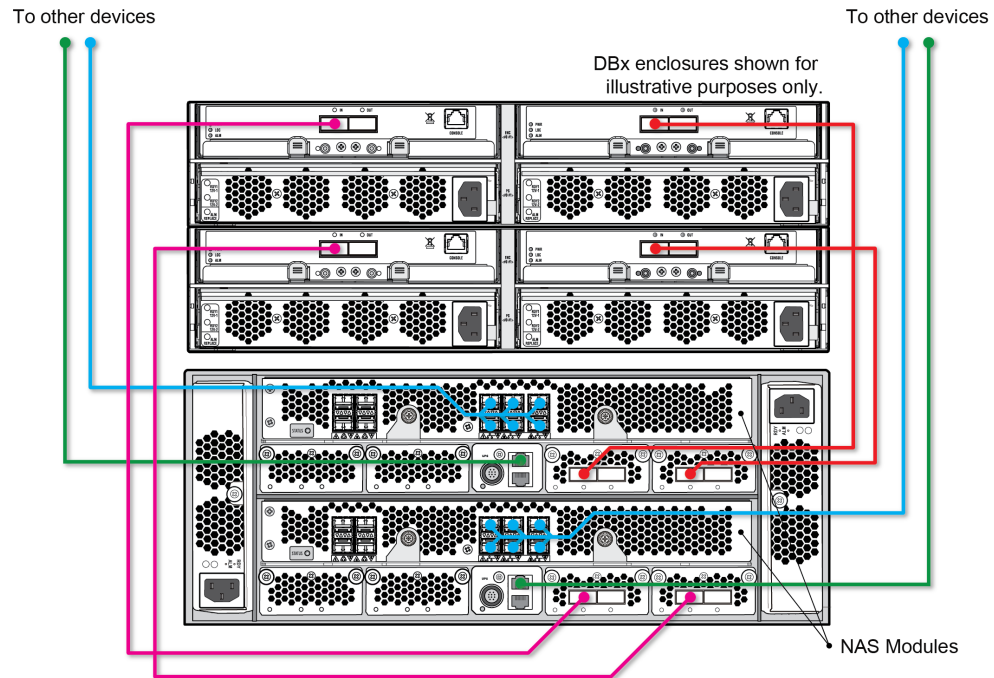

### Ensuring adequate airflow

Bundled cables can obstruct the movement of conditioned air around your storage system.

- Secure cables away from fans.
- Keep cables away from the intake holes at the front of the storage system.
- Use flooring seals or grommets to keep conditioned air from escaping through cable holes.

### Preparing for future maintenance

Design your cable infrastructure to accommodate future work on the storage system. Give thought to future tasks that will be performed on the storage system, such as locating specific pathways or connections, isolating a fault, or adding or removing components.

- Purchase colored cables or apply colored tags.
- Label both ends of every cable to denote the port to which it connects.

## AC power cables

Utility AC power standards for connector types and voltage levels vary by country. Hitachi provides a variety of power cables that facilitate using storage systems around the world. Hitachi power cables meet the safety standards for the country for which they are intended.



## Power cable assemblies

For information about racks and power distribution units (PDUs), refer to the *Hitachi Universal V2 Rack Reference Guide*.

Hitachi power cables consist of three parts:

- **Plug:** Male connector for insertion into the AC outlet providing power. The physical design and layout of the plug's contact meet a specific standard.
- **Cord:** Main section of insulated wires of varying length, whose thickness is determined by its current rating.
- **Receptacle:** Female connector to which the equipment attaches. The physical design and layout of the receptacle's contacts meet a specific standard. Common standards are the IEC C13 receptacle for loads up to 10 amperes (A) and the IEC C19 receptacle for loads up to 15 A.

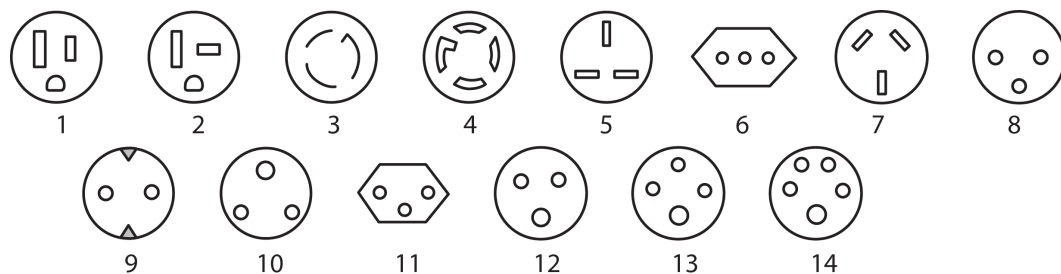

Number	Country or region	Voltage rating (VAC)	Current rating (amperes)	Plug type
1 <sup>1</sup>	North America	100-127	15	NEMA 5-15P
	Brazil	200-240	10, 20	NEMA 5-15P
	Japan	100-127	12	JIS C8303
	Taiwan	100-127	12, 16	CNS 690
2	North America	100-127	20	NEMA 5-20P
3	North America	200-240	20	NEMA L6-20P
3	North America	200-240	30	NEMA L6-30P
4 <sup>2</sup>	North America	200-240	30	NEMA L15-30P
5 <sup>3</sup>	Hong Kong	200-240	13	BS-1363
	Singapore	200-240	13	BS-1363
6	Chile	200-240	10, 16	CEI 23-50
	Italy	200-240	10, 16	CEI 23-50
7	Argentina	200-240	10, 15	IRAM 2073

Number	Country or region	Voltage rating (VAC)	Current rating (amperes)	Plug type
	Australia	200-240	10, 15	AS-3112
	China	200-240	10, 16	GB-1002
	New Zealand	200-240	10, 15	AS-3112
8	Denmark	200-240	10	DK 2-5
	Israel	200-240	10, 16	SI-32
9 <sup>4</sup>	Europe	200-240	CEE 7, 7	
10 <sup>5</sup>	India	200-240	6, 16	IS-1293
	South Africa	200-240	10, 16	SABS-164
11	Switzerland	200-240	10	SEV 1011
12 <sup>6</sup>	International	200-240	20	IEC 309
13 <sup>7</sup>	United Kingdom	200-240	13	BS-1363
	International	200-240	20	IEC 309
14 <sup>8</sup>	International	200-240	30	IEC 309
<p><b>Notes:</b></p> <ol style="list-style-type: none"> <li>Also used for 200-240 VAC applications in Korea and Philippines.</li> <li>Three-phase AC.</li> <li>Also Malaysia and Ireland.</li> <li>Also known as "Schuko" connector and used in Austria, Belgium, Finland, France, Germany, Greece, Hungary, Indonesia, Netherlands, Norway, Poland, Portugal, Russia, Spain, and Sweden.</li> <li>Supersedes type BS 546.</li> <li>3-wire (two-phase and earth). Physical variations (connector size and color) indicate amperage rating. Used in Switzerland for a true 16 A application.</li> <li>4-wire (three-phase and earth). Physical variations (connector size and color) indicate amperage rating.</li> <li>5-wire (three-phase, earth and neutral). Physical variations (connector size and color) indicate amperage rating.</li> </ol>				

## AC connections

The following table shows and describes the types of AC connections on your storage system.

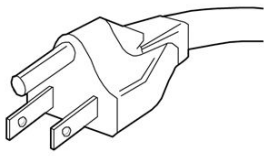
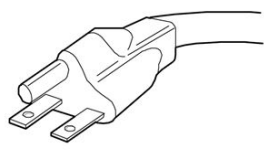
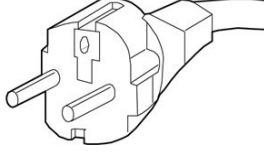
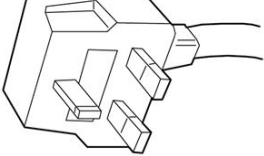
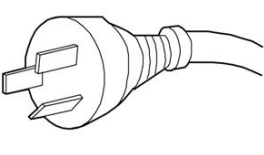
Description	Receptacle	Input rating	Reference standards
NEMA 5-15P		100V-120V (standard attachment)	1 ANSI C73.11 2 NEMA 5-15P 3 IEC 83
NEMA L6-20P		200V-240V	1 ANSI C73.11 2 NEMA 6-15P 3 IEC 83
CEE 7/7		200V-240V	4 CEE (7) II, IV, VII 3 IEC 83
BS-1363		200V-240V	5 BS 1365 3 IEC 83
AS-3112		200V-240V	6 AS C112

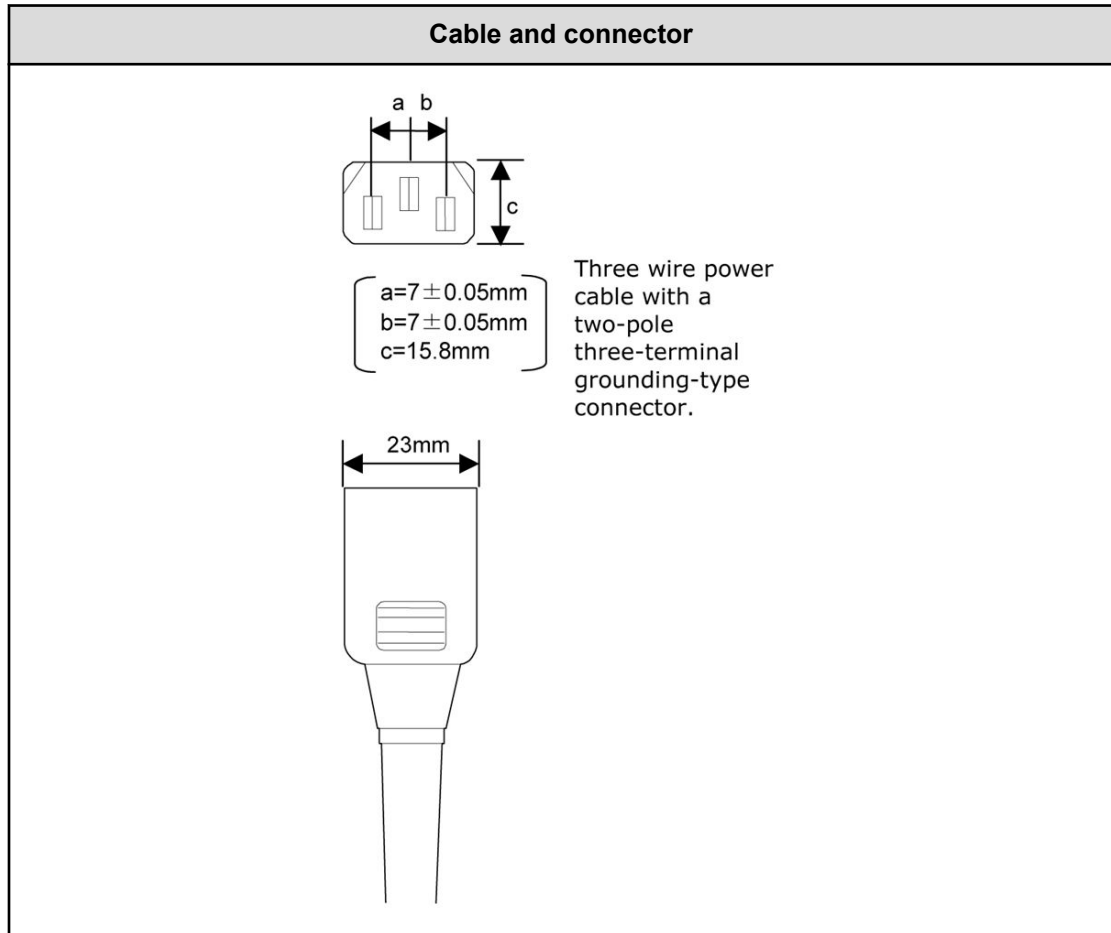

## Power cable usage guidelines

Hitachi storage systems are intended for rack installation and ship with power cords. Installation and service requirements may require additional cords and cables to be ordered. The type of power cable required by a given installation is determined primarily by the:

- Type of AC line feed provided by the facility.
- Type of AC source (wall outlet or modular and monitored PDU) to be used.
- Serviceability of components to be connected.

Storage systems require a country-specific power cable for direct connection to a facility AC feed.

Storage systems are designed to allow replacement of hot-pluggable components without removing the chassis from the rack. As a result, power cables can be short because cable movement is of minimal consideration.

## Three-phase power considerations for racks

Increasing power requirements for racks are making the use of three-phase power at the rack level compelling.

- With single-phase power, at any given time the voltage across the hot and neutral conductors can be anywhere between its peak (maximum) and zero. Electrical conductors must be large to meet high amperage requirements.
- Three-phase power uses three cycles that are 120 degrees out of phase, which never allows the voltage to drop to zero. The more consistent voltage derived from the three hot conductors results in smoother current flow and allows small-gauge conductors to be used to distribute the same amount of AC power. As a result, the load balancing and increased power handling capabilities of three-phase distribution can result in more efficient and less costly installations that require fewer AC cables and PDUs.

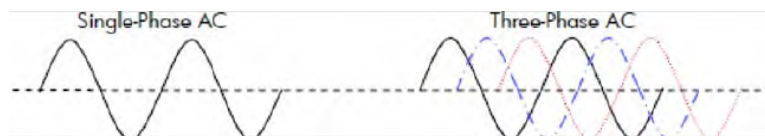

## Cable management

Rack installations should be planned for operational efficiency, ease of maintenance, and safety. Hitachi offers the Backend Configuration Utility (BECK), a graphical, cable-management application that can relieve the typical cable congestion created when populating a rack with storage systems and their accessories.

---

## Appendix G: Port address mapping

### Port address mapping

Each Fibre Channel port has a default port address (AL\_PA) of EF. You do not have to change this value because the storage system port can connect to the host bus adapter (HBA) with the current setting.

If you want to change the AL\_PA value, however, select a value from the following table.

If you use a value that is not in the following table or is already used by the HBA, the host might not be able to recognize the VOL. If this problem or other problems occur, revert to the default value of EF.

The following addresses are available for setting Fibre Channel ports.

AL-PA	Loop ID (0~29)	AL-PA	Loop ID (30~59)	AL-PA	Loop ID (60~89)	AL-PA	Loop ID (90~119)	AL-PA	Loop ID (120~125)
EF	0	B4	30	76	60	49	90	10	120
E8	1	B3	31	75	61	47	91	0F	121
E4	2	B2	32	74	62	46	92	08	122
E2	3	B1	33	73	63	45	93	04	123
E1	4	AE	34	72	64	43	94	02	124
E0	5	AD	35	71	65	3C	95	01	125
DC	6	AC	36	6E	66	3A	96	-	-
DA	7	AB	37	6D	67	39	97	-	-
D9	8	AA	38	6C	68	36	98	-	-
D6	9	A9	39	6B	69	35	99	-	-
D5	10	A7	40	6A	70	34	100	-	-
D4	11	A6	41	69	71	33	101	-	-
D3	12	A5	42	67	72	32	102	-	-
D2	13	A3	43	66	73	31	103	-	-

AL-PA	Loop ID (0~29)	AL-PA	Loop ID (30~59)	AL-PA	Loop ID (60~89)	AL-PA	Loop ID (90~119)	AL-PA	Loop ID (120~125)
D1	14	9F	44	65	74	2E	104	-	-
CE	15	9E	45	63	75	2D	105	-	-
CD	16	9D	46	5C	76	2C	106	-	-
CC	17	9B	47	5A	77	2B	107	-	-
CB	18	98	48	59	78	2A	108	-	-
CA	19	97	49	56	79	29	109	-	-
C9	20	90	50	55	80	27	110	-	-
C7	21	8F	51	54	81	26	111	-	-
C6	22	88	52	53	82	25	112	-	-
C5	23	84	53	52	83	23	113	-	-
C3	24	82	54	51	84	1F	114	-	-
BC	25	81	55	4E	85	1E	115	-	-
BA	26	80	56	4D	86	1D	116	-	-
B9	27	7C	57	4C	87	1B	117	-	-
B6	28	7A	58	4B	88	18	118	-	-
B5	29	79	59	4A	89	17	119	-	-

---

## Appendix H: Non-Hitachi racks

All storage systems can be installed into non-Hitachi racks.

The following describes the requirements and guidelines for installing the storage system into a non-Hitachi rack.

### Non-Hitachi rack support

The storage system supports non-Hitachi racks that meet Hitachi specifications.

Observe the following mounting guidelines for non-Hitachi racks:

- The storage system supports any 4-post, EIA-310-D compliant rack that has adequate airflow and weight capacity.
- PDUs must be mounted properly to avoid any issues while servicing the storage system. The PDU receptacles must face toward the back (not toward each other). The area behind the storage system and between the vertical 19-inch mounting posts must be free of PDUs and cable loops.

### Hitachi Universal V2 Rack rail kits

Use rail kits to mount the Hitachi Virtual Storage Platform family storage system in a Hitachi Universal V2 Rack.

The following tables list the rail kit information for the specified storage systems.

**Table 1 Rail kits**

Rail kit	Hitachi Universal V2 Rack	Third-party rack
Controller	UNI <sup>1</sup>	UNI <sup>1</sup>
DBS/DBSE, DBL/DBLE, and DBF drive trays	CGR <sup>2</sup>	UNI <sup>1</sup>
DB60 dense intermix drive tray	Use the rail kit supplied with the DB60 dense intermix drive tray.	
SVP server	Use the rail kit supplied with the SVP server.	
<b>Notes:</b>		
1. UNI: Universal rail kit A34V-600-850-UNI.		



Rail kit	Hitachi Universal V2 Rack	Third-party rack
2. CGR: Corner guide rail kit A3BF-HK-GL-740-1.		

## Hitachi Universal V2 Rack accessories

The following table provides rack accessory information for VSP G series storage systems.

**Table 2 Accessories for the Hitachi Universal V2 Rack**

Front door	Rear door	Side panels
Optional, must be ordered separately (A3BF-DR).	Included with rack	Not included with rack, must be ordered separately. A quantity of two must be ordered per rack (A3BF-Z-PAN-1200).

## Third-party rack support for DB60 dense intermix drive trays

Due to the size and weight of the DB60 dense intermix drive trays used with VSP Gx00 models, pay close special attention when mounted in third-party racks.

When mounting DB60 dense intermix drive trays in third-party racks, observe the following guidelines and see the following figure.

- Use anti-tilt floor plates or ceiling-mounted fixing brackets to stabilize the rack.
- Use a rack that is at least 40.94 in. (1040 mm) deep to accommodate the DB60 dense intermix drive tray and cable-management arms.
- Dense tray rail kits require square mounting holed racks.
- Use a ladder to service the DB60 dense intermix drive tray if the drive tray is mounted above shelf height RU32.



---

## Appendix I: Regulatory compliance

This equipment has been tested and certified for compliance with the following standards.

**Table 3 Country Specifications and Certifications**

<b>Standard</b>	<b>Specification</b>	<b>Product marking or logo</b>	<b>Country regulation</b>
Electronic emission controls	FCC part 15 Subpart B:2013	FCC	USA and Canada
	ICES-003 Issue 5:2012	ICES-003	USA and Canada
	AS/NZS CISPR 22:2009+A1	RCM	Australia and New Zealand
	TP TC 020/2011	EAC	Russia, Belarus, and Kazakhstan
	CNS 13438	BSMI	Taiwan
	KN22	KC	Korea
	KN24	KC	Korea
Electronic emission certifications	EN5522: 2010	CE	EU
	EN5524: 2010	CE	EU
	EN61000-3.2:2006+A1+A2	CE	EU
	EN61000-3.3:2008	CE	EU
Safety certifications	UL and CSA 60950-1:2007	cTUVus	USA and Canada
	EN60950-1:2006+A1	TUV	Germany
	IEC60950-1:2005+A1	N/A	All CB countries
	IEC60950-1:2005+A1	S-Mark	Argentina
	TP TC 004/2011	EAC	Russia
	CNS 14336-1	BSMI	Taiwan
	EN60950-1:2006+A1	CE	EU
Radio interference voluntary control	VCCI V-3/2013.04	VCCI	Japan

---

## Appendix J: Environmental notices

### Disposal



This symbol on the product or on its packaging means that your electrical and electronic equipment should be disposed at the end of life separately from your household wastes.

There are separate collection systems for recycling in the European Union. For more information, contact the local authority or the dealer where you purchased the product.

### Recycling

A nickel-metal hydride battery is used in the Cache Backup Battery.

A nickel-metal hydride battery is a resource that can be recycled. When you want to replace the Cache Backup Battery, call the service personnel. They will dispose of it for you. This nickel-metal hydride battery, which is designated as recycling product by a recycling promotion law, must be recycled.

The mark posted on the Cache Backup Battery is a three-arrow mark that indicates a recyclable part.



**Hitachi Vantara**



Corporate Headquarters  
2535 Augustine Drive  
Santa Clara, CA 95054 USA  
[HitachiVantara.com](http://HitachiVantara.com) | [community.HitachiVantara.com](http://community.HitachiVantara.com)

Contact Information  
USA: 1-800-446-0744  
Global: 1-858-547-4526  
[HitachiVantara.com/contact](http://HitachiVantara.com/contact)