

# Hitachi Virtual Storage Platform 5000 Series

SVOS RF 9.6

---

## Hitachi TrueCopy<sup>®</sup> for Mainframe User Guide

Hitachi TrueCopy software for Mainframe (TCz) enables you to perform synchronous backup of critical data in a remote location.

© 2019, 2021 Hitachi, Ltd. All rights reserved.

No part of this publication may be reproduced or transmitted in any form or by any means, electronic or mechanical, including copying and recording, or stored in a database or retrieval system for commercial purposes without the express written permission of Hitachi, Ltd., or Hitachi Vantara LLC (collectively "Hitachi"). Licensee may make copies of the Materials provided that any such copy is: (i) created as an essential step in utilization of the Software as licensed and is used in no other manner; or (ii) used for archival purposes. Licensee may not make any other copies of the Materials. "Materials" mean text, data, photographs, graphics, audio, video and documents.

Hitachi reserves the right to make changes to this Material at any time without notice and assumes no responsibility for its use. The Materials contain the most current information available at the time of publication.

Some of the features described in the Materials might not be currently available. Refer to the most recent product announcement for information about feature and product availability, or contact Hitachi Vantara LLC at <https://support.hitachivantara.com/en-us/contact-us.html>.

**Notice:** Hitachi products and services can be ordered only under the terms and conditions of the applicable Hitachi agreements. The use of Hitachi products is governed by the terms of your agreements with Hitachi Vantara LLC.

By using this software, you agree that you are responsible for:

1. Acquiring the relevant consents as may be required under local privacy laws or otherwise from authorized employees and other individuals; and
2. Verifying that your data continues to be held, retrieved, deleted, or otherwise processed in accordance with relevant laws.

**Notice on Export Controls.** The technical data and technology inherent in this Document may be subject to U.S. export control laws, including the U.S. Export Administration Act and its associated regulations, and may be subject to export or import regulations in other countries. Reader agrees to comply strictly with all such regulations and acknowledges that Reader has the responsibility to obtain licenses to export, re-export, or import the Document and any Compliant Products.

Hitachi and Lumada are trademarks or registered trademarks of Hitachi, Ltd., in the United States and other countries.

AIX, AS/400e, DB2, Domino, DS6000, DS8000, Enterprise Storage Server, eServer, FICON, FlashCopy, GDPS, HyperSwap, IBM, Lotus, MVS, OS/390, PowerHA, PowerPC, RS/6000, S/390, System z9, System z10, Tivoli, z/OS, z9, z10, z13, z14, z/VM, and z/VSE are registered trademarks or trademarks of International Business Machines Corporation.

Active Directory, ActiveX, Bing, Excel, Hyper-V, Internet Explorer, the Internet Explorer logo, Microsoft, the Microsoft Corporate Logo, MS-DOS, Outlook, PowerPoint, SharePoint, Silverlight, SmartScreen, SQL Server, Visual Basic, Visual C++, Visual Studio, Windows, the Windows logo, Windows Azure, Windows PowerShell, Windows Server, the Windows start button, and Windows Vista are registered trademarks or trademarks of Microsoft Corporation. Microsoft product screen shots are reprinted with permission from Microsoft Corporation.

All other trademarks, service marks, and company names in this document or website are properties of their respective owners.

Copyright and license information for third-party and open source software used in Hitachi Vantara products can be found at <https://www.hitachivantara.com/en-us/company/legal.html>.

---

# Contents

<b>Preface</b> .....	<b>11</b>
Intended audience.....	11
Product version.....	11
Release notes.....	11
Changes in this revision.....	12
Conventions for storage capacity values.....	12
Accessing product documentation.....	13
Getting help.....	13
Comments.....	13
<b>Chapter 1: Overview of Hitachi TrueCopy® for Mainframe</b> .....	<b>14</b>
Hitachi TrueCopy® for Mainframe.....	14
System components .....	15
Storage systems.....	16
Volume pairs .....	17
Data path.....	17
Consistency groups .....	18
User interfaces .....	18
Failover software .....	19
Error reporting communications.....	19
Initial copy and update copy operations .....	19
Initial copy operations .....	19
Update copy operations .....	20
Pair status.....	21
<b>Chapter 2: Requirements and specifications</b> .....	<b>22</b>
System requirements and specifications.....	22
Business Continuity Manager specifications.....	27
Options not supported by Business Continuity Manager.....	27
Command device.....	28
F/M = FB message output control option.....	29
PPRC specifications and restrictions.....	30
TrueCopy for Mainframe operations performed with PPRC.....	30
TrueCopy for Mainframe options not supported with PPRC.....	30
PPRC and BCM command comparison.....	31

SAID values for CESTPATH/YKBLDPTH.....	33
P/DAS support and restrictions.....	38
P/DAS restrictions.....	38
GDPS support.....	39
RMF™ PPRC link path statistical information support.....	39
Planning for Basic HyperSwap®, TPC-R, and CSM operations.....	44
Requirements for Basic HyperSwap®, TPC-R, and CSM operations.....	45
Recommendations for Basic HyperSwap®, TPC-R, and CSM operations...	45
Planning for Extended Address Volume.....	45
zHyperWrite function support.....	46
CCI support for TrueCopy for Mainframe operations.....	48
Supported operations and options.....	48
<b>Chapter 3: Planning for TrueCopy for Mainframe.....</b>	<b>52</b>
Storage system preparation.....	52
Cache and shared memory requirements.....	53
Adding and removing cache memory .....	53
DFW requirements.....	53
Requirements for pairing VSP 5000 series with other storage systems.....	53
Remote replication options.....	54
Round trip time option.....	54
Minimum number of remote paths option.....	58
Maximum initial copy activities option.....	58
Blocked path monitoring option.....	59
Blocked path SIM monitoring option.....	59
Services SIM of remote copy option.....	59
PPRC support CU option.....	59
Analyzing workload and planning data paths.....	60
Data path requirements and configurations.....	61
Bandwidth requirements.....	62
Fibre Channel requirements.....	62
Supported data path configurations for Fibre Channel.....	63
Direct connection.....	63
Switch connection.....	64
Extender connection.....	65
Fibre Channel used as remote paths.....	66
Ports.....	66
Port requirements .....	67
Port attributes .....	67
Swapping between P-VOL and S-VOL in a CESTPATH/CDELPATH command.....	67
Pair and pair volumes planning.....	68

Pair volume requirements and recommendations.....	68
Precautions for duplicate VOLSERs.....	70
Allowing I/O to the S-VOL.....	71
Allowing I/O to the P-VOL after a split: Fence Level options.....	72
Differential data.....	72
Maximum number of pairs supported.....	73
Calculating the maximum number of pairs.....	73
Initial copy priority option and scheduling order.....	75
Restrictions when creating an LU whose LU number is 2048 or greater.....	76
Consistency group planning.....	77
Consistency group for pairs in one primary and one secondary storage system.....	78
Consistency group for pairs in multiple primary and secondary storage systems.....	79
System configurations for consistency groups.....	80
Registering pairs to a new consistency group when creating a new TCz pair.....	81
Registering pairs to a new consistency group when creating a new TC or TCz pair.....	82
Registering pairs to a new consistency group when using existing TCz pairs.....	82
Registering pairs to a new consistency group when using existing TC or TCz pairs.....	82
Registering pairs to an existing consistency group when creating a new TCz pair.....	83
Registering pairs to an existing consistency group when creating a new TC or TCz pair.....	83
Registering pairs to an existing consistency group when using existing TCz pairs.....	83
Registering pairs to an existing consistency group when using existing TC or TCz pairs.....	84
Consistency group requirements .....	85
Requirements for a CTG for one primary and one secondary system....	85
Requirements for a CTG for multiple primary and secondary systems..	85
Assigning pairs to a consistency group.....	86
Assigning pairs belonging to one primary system and secondary system.....	86
Assigning pairs belonging to multiple primary and secondary systems..	86
Assigning TC and TCz pairs to the same consistency group.....	86
Using a new CTG.....	88
Using an existing CTG.....	88
Split behaviors for pairs in a CTG.....	89
Host access after split.....	90

Pair status before and after a split operation .....	91
Resynchronizing and removing pairs using Business Continuity Manager .....	92
Error reporting communications.....	93
<b>Chapter 4: Sharing TrueCopy for Mainframe volumes.....</b>	<b>94</b>
Volume types that can be shared with TrueCopy for Mainframe.....	94
Cache Residency Manager .....	97
Compatible XRC and CC.....	98
Dynamic Provisioning for Mainframe .....	98
Performance Monitor.....	100
ShadowImage for Mainframe.....	100
Configurations with ShadowImage for Mainframe P-VOLs.....	101
Configurations with ShadowImage for Mainframe S-VOLs.....	104
Status reporting and data currency.....	105
Universal Replicator for Mainframe.....	106
Virtual LVI .....	106
Volume Migration .....	107
Restrictions to using a TrueCopy for Mainframe volume as a Volume Migration volume.....	107
Volume Retention Manager.....	107
Soft Fence.....	108
<b>Chapter 5: TCz configuration.....</b>	<b>111</b>
Configuration workflow.....	111
Defining port attributes .....	111
Adding remote connections.....	113
Setting the remote replication options.....	115
Changing the SCP time.....	118
Completing SIMs for TCz .....	119
<b>Chapter 6: TCz pair operations.....</b>	<b>121</b>
Pair operations workflow.....	121
Checking pair status.....	122
Creating pairs.....	122
Splitting pairs.....	125
Resynchronizing pairs.....	127
Deleting pairs.....	129
<b>Chapter 7: Monitoring and maintaining the TCz system.....</b>	<b>131</b>
Monitoring pair status and license capacity.....	131
How pair status changes.....	132
Pair status definitions .....	133

CCI pair status names.....	137
Split types.....	137
System behavior.....	139
Monitoring TCz pair synchronization rate.....	139
Monitoring TCz operations history.....	140
Operations listed in the History window.....	141
Changing P-VOL fence level and CFW data.....	142
Forcibly deleting pairs.....	143
Saving pair information to a text file .....	144
Monitoring copy operations and I/O statistical data.....	145
Monitoring and maintaining remote connections and paths .....	145
Remote path status definitions.....	147
Configuring additional remote paths.....	148
Changing remote connection options.....	148
Deleting remote paths.....	150
Adding SSIDs on the secondary system.....	151
Deleting SSIDs on the secondary system.....	152
Deleting remote connections.....	153
ICKDSF Considerations for TCz Volumes.....	154
Running ICKDSF on a TCz P-VOL.....	154
Running ICKDSF on a TCz S-VOL.....	155
Managing power-off for systems and network devices.....	155
How powering off for a planned outage affects primary and secondary systems.....	155
Planned outage of the primary system.....	156
Planned outage of the secondary system or remote path.....	156
Planned outage of both primary and secondary systems.....	157
<b>Chapter 8: Data migration.....</b>	<b>158</b>
Migration overview.....	158
Migrating data.....	158
<b>Chapter 9: Disaster recovery.....</b>	<b>160</b>
Disaster recovery overview.....	160
Sense information shared between sites.....	160
File and database recovery.....	161
CSUSPEND/QUIESCE TSO command.....	161
IEA494I system console message.....	162
Switching operations to the secondary site.....	162
Switching operations to the secondary site by deleting pairs.....	162
Switching operations to the secondary site by not deleting pairs.....	163
Checking S-VOL consistency with the P-VOL.....	163

Transferring operations back to the primary site.....	165
Transferring operations back to the primary site if pairs were deleted.....	165
Transferring operations back to the primary site if pairs were not deleted	166
<b>Chapter 10: Troubleshooting TrueCopy for Mainframe.....</b>	<b>167</b>
Device Manager - Storage Navigator error codes and messages.....	167
General troubleshooting.....	167
Remote path status problems.....	169
Split pair problems.....	172
Changing microcode problem .....	174
Troubleshooting using CCI.....	175
SSB2 error codes when SSB1 = 2E31/B901/B90A/B90B/B912/D004.....	175
SSB2=B992 error codes when SSB1 = B901 or B90A.....	189
SSB2 error codes when SSB1 = B90B.....	189
Service information messages (SIMs).....	190
TPC-R/CSM troubleshooting .....	190
Resynchronization fails due to shortage of host resources.....	190
Cache failure, unregistered TPC-R/CSM error .....	190
Pinned track recovery.....	191
<b>Appendix A: Pair operations using PPRC.....</b>	<b>192</b>
Overview of PPRC commands.....	192
Options not supported by PPRC.....	194
Requirements, restrictions, and notes.....	194
Conventions used in TSO commands.....	197
CESTPATH command.....	197
Requirements.....	197
CESTPATH command syntax.....	197
CESTPATH parameters.....	198
I/O control after failure with CGROUP FREEZE/RUN.....	200
CGROUP FREEZE/RUN requirements.....	201
Pair status before and after CGROUP FREEZE/RUN.....	201
Using CGROUP.....	202
Command sequence example.....	202
Other TSO commands used with CGROUP.....	203
Example output for CQUERY.....	203
IEA494I and IEA491E console messages.....	205
IEA494I message.....	206
IEA491E message.....	206
Storage system response characteristics to failure conditions.....	206
GDPS and TrueCopy for Mainframe features.....	211



<b>Appendix B: TCz CLI reference.....</b>	<b>216</b>
Configuration commands and options.....	216
Pair operation commands and options.....	218
Monitoring commands and options.....	219
Maintenance commands and options.....	220
Parameter range for CCI options.....	221
<b>Appendix C: TCz GUI reference.....</b>	<b>223</b>
Replication window.....	223
Remote Replication window.....	226
Remote Connections window.....	245
Add Remote Connection wizard.....	249
Add Remote Connection window.....	249
Add Remote Connection confirmation window.....	253
View Remote Connection Properties window.....	254
Remove Remote Connections window.....	257
Edit Remote Connection Options wizard.....	258
Edit Remote Connection Options window.....	258
Edit Remote Connection Options confirmation window.....	259
Add Remote Paths wizard.....	260
Add Remote Paths window.....	260
Add Remote Paths confirmation window.....	263
Remove Remote Paths wizard.....	264
Remove Remote Paths window.....	264
Remove Remote Paths confirmation window.....	267
Edit Remote Replica Options wizard.....	268
Edit Remote Replica Options window.....	268
Change CU Options window.....	271
Edit Remote Replica Options confirmation window.....	272
Edit SCP Time wizard.....	273
Edit SCP Time window.....	273
Change SCP Time window.....	274
Edit SCP Time confirmation window.....	275
Create Pairs wizard.....	275
Create TC Pairs window or Create UR Pairs window.....	275
Change Settings window.....	288
Create Pairs confirmation window.....	293
Split Pairs wizard.....	297
Split Pairs window.....	297
Split Pairs confirmation window.....	299
Resync Pairs wizard.....	301

Resync Pairs window.....	301
Resync Pairs confirmation window.....	304
Delete Pairs wizard.....	306
Delete Pairs window.....	306
Delete Pairs confirmation window.....	308
Force Delete Pairs (TC Pairs) window.....	309
Edit Pair Options wizard.....	310
Edit Pair Options window.....	310
Edit Pair Options confirmation window.....	312
View Pair Properties (Remote) window.....	313
View Pair Synchronization Rate window.....	316
Add SSIDs wizard.....	318
Add SSIDs window.....	318
Add SSIDs confirmation window.....	320
Remove SSIDs wizard.....	321
Remove SSIDs window.....	321
Remove SSIDs confirmation window.....	323
History window.....	323
Edit Ports window.....	326
Complete SIMs (TC) window .....	331

---

## Preface

The Hitachi TrueCopy® for Mainframe product enables you to perform synchronous backup of critical data in a remote location.

Read this document carefully to understand how to use this product, and maintain a copy for reference purposes.

### Intended audience

This document is intended for system administrators, Hitachi Vantara representatives, and authorized service providers who install, configure, and operate the VSP 5000 series storage system.

Readers of this document should be familiar with the following:

- Data processing and RAID systems and their basic functions.
- The Hitachi Device Manager - Storage Navigator software and the *System Administrator Guide*.
- Remote replication and disaster recovery configurations for enterprise storage data centers.

### Product version

This document revision applies to the following product versions:

- VSP 5000 series: 90-06-01 or later
- SVOS RF 9.6 or later

### Release notes

Read the release notes before installing and using this product. They may contain requirements or restrictions that are not fully described in this document or updates or corrections to this document. Release notes are available on Hitachi Vantara Support Connect: <https://knowledge.hitachivantara.com/Documents>.

## Changes in this revision

- VSP 5000 series models display in the **Add Remote Connection** and **History** windows.

## Conventions for storage capacity values

Physical storage capacity values (for example, disk drive capacity) are calculated based on the following values:

Physical capacity unit	Value
1 kilobyte (KB)	1,000 ( $10^3$ ) bytes
1 megabyte (MB)	1,000 KB or $1,000^2$ bytes
1 gigabyte (GB)	1,000 MB or $1,000^3$ bytes
1 terabyte (TB)	1,000 GB or $1,000^4$ bytes
1 petabyte (PB)	1,000 TB or $1,000^5$ bytes
1 exabyte (EB)	1,000 PB or $1,000^6$ bytes

Logical capacity values (for example, logical device capacity, cache memory capacity) are calculated based on the following values:

Logical capacity unit	Value
1 block	512 bytes
1 cylinder	Mainframe: 870 KB Open-systems: <ul style="list-style-type: none"> <li>▪ OPEN-V: 960 KB</li> <li>▪ Others: 720 KB</li> </ul>
1 KB	1,024 ( $2^{10}$ ) bytes
1 MB	1,024 KB or $1,024^2$ bytes
1 GB	1,024 MB or $1,024^3$ bytes
1 TB	1,024 GB or $1,024^4$ bytes
1 PB	1,024 TB or $1,024^5$ bytes
1 EB	1,024 PB or $1,024^6$ bytes

## Accessing product documentation

Product user documentation is available on the Hitachi Vantara Support Website: <https://knowledge.hitachivantara.com/Documents>. Check this site for the most current documentation, including important updates that may have been made after the release of the product.

## Getting help

The [Hitachi Vantara Support Website](https://support.hitachivantara.com/en_us/contact-us.html) is the destination for technical support of products and solutions sold by Hitachi Vantara. To contact technical support, log on to the Hitachi Vantara Support Website for contact information: [https://support.hitachivantara.com/en\\_us/contact-us.html](https://support.hitachivantara.com/en_us/contact-us.html).

[Hitachi Vantara Community](https://community.hitachivantara.com) is a global online community for Hitachi Vantara customers, partners, independent software vendors, employees, and prospects. It is the destination to get answers, discover insights, and make connections. **Join the conversation today!** Go to [community.hitachivantara.com](https://community.hitachivantara.com), register, and complete your profile.

## Comments

Please send us your comments on this document to [doc.comments@hitachivantara.com](mailto:doc.comments@hitachivantara.com). Include the document title and number, including the revision level (for example, -07), and refer to specific sections and paragraphs whenever possible. All comments become the property of Hitachi Vantara LLC.

**Thank you!**

---

# Chapter 1: Overview of Hitachi TrueCopy® for Mainframe

An overview of the different components that are a part of Hitachi TrueCopy® for Mainframe helps you to understand its function and capabilities.

## Hitachi TrueCopy® for Mainframe

Hitachi TrueCopy® for Mainframe (TCz) provides a continuous, nondisruptive, host-independent remote data-replication solution for disaster recovery or data migration purposes. Using the TrueCopy for Mainframe Remote Replication software, you can create and maintain mirror images of production volumes at a remote location. TrueCopy for Mainframe Remote Replication software can be deployed with Hitachi Universal Replicator for Mainframe software's asynchronous replication capabilities to provide advanced data replication among multiple data centers. In addition, TrueCopy for Mainframe Remote Replication software can be integrated with Hitachi ShadowImage® for Mainframe Replication software to enable robust business-continuity solutions. This lets you create a remote copy of primary site or production data that is automatically updated for executing test and development tasks, or for operations against production data.

The TrueCopy for Mainframe primary storage system contains the primary volume (P-VOL) of a copy pair, and the secondary storage system contains the secondary volume (S-VOL). When the primary storage system accepts a write operation for a P-VOL, the data is written on the primary volume and then sent by the primary storage system to the secondary storage system through the dedicated data paths connecting the storage systems. Subsequent write operations are not accepted by the primary volume until acknowledgement is received from the secondary storage system for the previous write operation, ensuring that the data in the secondary volume stays synchronized with the primary volume.

To reduce the overhead associated with these remote copy activities and maximize data transfer, the primary storage system uses a special write command for TrueCopy for Mainframe remote copy operations. This command transfers the control parameters and the FBA-format data for consecutive updated records in a track using a single write operation. The special write command eliminates the overhead required for performing FBA-to-CKD and CKD-to-FBA conversions.

TrueCopy for Mainframe operations can be performed using the TrueCopy for Mainframe Remote Replication software on Hitachi Device Manager - Storage Navigator, Business Continuity Manager, IBM® PPRC commands, and the Command Control Interface (CCI) command-line interface software. This document describes and provides instructions for performing TrueCopy for Mainframe operations using the TrueCopy for Mainframe software on Device Manager - Storage Navigator. For details about using Business Continuity Manager, IBM® PPRC commands, and CCI to perform TrueCopy for Mainframe operations, see the appropriate user documentation.

## System components

TrueCopy for Mainframe operations involve the storage systems and volumes at the primary site and secondary (remote) site, the physical communications paths between these storage systems, and the TrueCopy for Mainframe software. A TrueCopy for Mainframe system configuration consists of the following components:

- **Primary and secondary storage systems:** The primary storage system contains the primary volumes and is connected to the hosts that access the primary volumes. The secondary storage system is connected to the primary storage system using the data paths. TrueCopy for Mainframe supports remote copy operations between various storage system models. This document provides instructions for performing TrueCopy for Mainframe operations.
- **Main control units (MCUs) and remote control units (RCUs):** The MCU is the control unit in the primary storage system that controls the P-VOLs of the TrueCopy for Mainframe pairs. The MCU communicates with the RCU through the dedicated remote copy connections. The MCU controls the host I/O operations to the P-VOLs as well as the TrueCopy for Mainframe remote copy operations between the P-VOLs and S-VOLs. The MCU also manages the TrueCopy for Mainframe pair status and configuration information.

The RCU is the control unit in the secondary storage system that controls the S-VOLs of the TrueCopy for Mainframe pairs. The RCU assists in managing the TrueCopy for Mainframe pair status and configuration (for example, rejects write I/Os to S-VOLs). The RCU executes the remote copy operations issued by the MCU. The RCUs should be attached to a host system to allow sense information to be reported in case of a problem with a secondary volume or remote storage system and to provide disaster recovery capabilities.

- **Hosts:** The hosts at the primary site are connected to the primary storage system. Hosts at the secondary site are connected to the secondary storage system for use in disaster recovery operations. If it is not possible to have hosts at the secondary site, the host at the primary site must be in communication with the secondary system for disaster recovery operations.
- **Volumes:** The primary volumes (P-VOLs) on the primary storage system are copied to the secondary volumes (S-VOLs) on the secondary system. The P-VOLs contain the original data, and the S-VOLs are the mirrored volumes that contain the backup or duplicate data. During normal TrueCopy for Mainframe operations, the P-VOL remains available to all hosts at all times for read and write I/O operations and the secondary storage system rejects all host-requested write I/Os for the S-VOLs. The S-VOL write enable option allows write access to an S-VOL while the pair is split, and the S-VOL and P-VOL differential data is used to resynchronize the pair.
- **Data paths:** Dedicated data paths, also called remote copy connections, are used for data transfer between the primary and secondary storage systems. You should establish at least two independent remote copy connections (one per cluster) between each MCU and RCU to provide hardware redundancy for this critical communications path.
- **Hitachi TrueCopy® for Mainframe software:** The TrueCopy for Mainframe software must be installed on both the primary and secondary storage systems and is used to perform TrueCopy for Mainframe configuration and pair operations.

- Business Continuity Manager. Business Continuity Manager (BCM) commands and ISPF panels can be used to perform TrueCopy for Mainframe pair operations from the mainframe environment. These functions can be integrated with system automation to automate various operational scenarios.
- IBM® Peer-to-Peer Remote Copy (PPRC). IBM® PPRC commands can be used to perform TrueCopy for Mainframe pair operations from the mainframe host. These commands can be used with system automation products for various operational scenarios.
- **CCI**: The Command Control Interface (CCI) command-line interface software can also be used for TrueCopy for Mainframe configuration and pair operations as well as disaster recovery operations.

The following figure shows a typical TrueCopy for Mainframe environment.

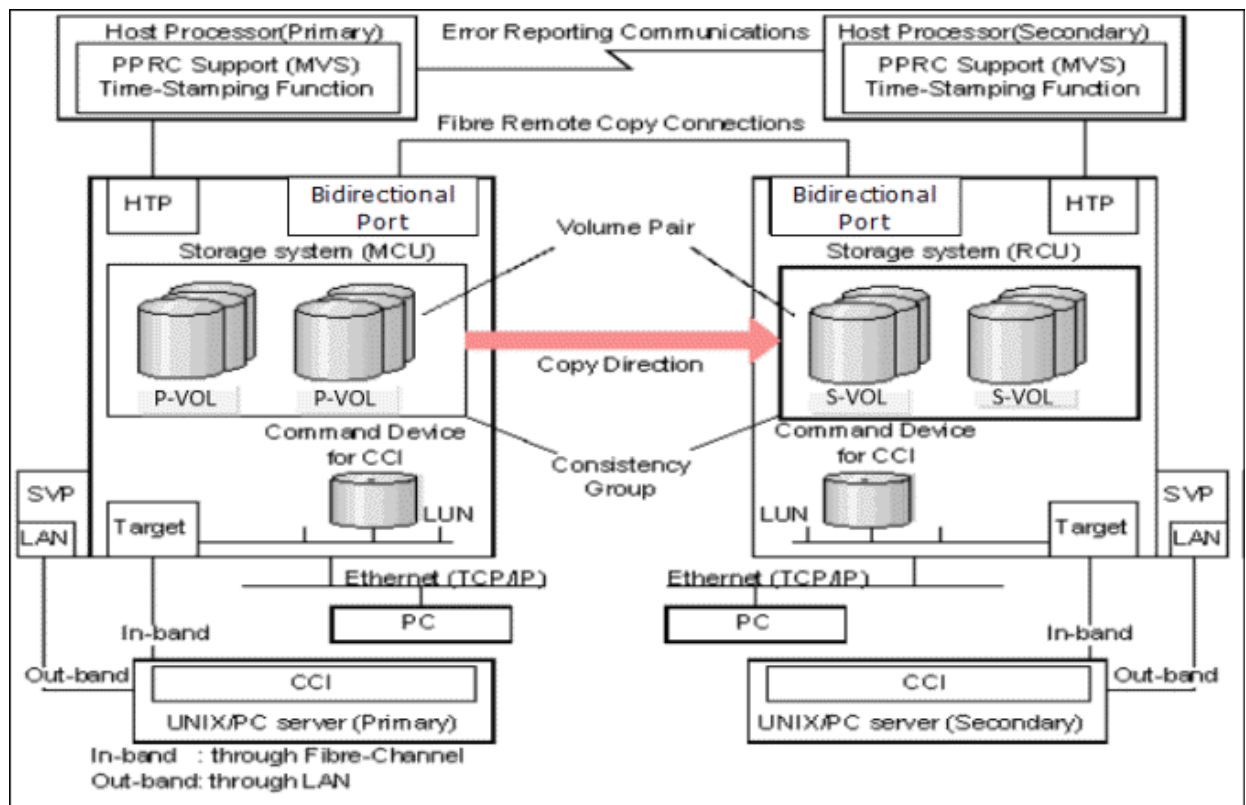

## Storage systems

TrueCopy for Mainframe operations take place between a primary storage system and a secondary storage system. The primary storage system communicates with the secondary storage system over dedicated Fibre Channel data paths called remote copy connections.

The primary storage system is responsible for the following:

- Managing host I/O operations to the P-VOL.
- Managing initial copy and update copy operations between the P-VOL and the S-VOL.
- Managing pair status and configuration information.



The secondary storage system is responsible for the following:

- Managing copy operations issued by the primary storage system to the S-VOL.
- Assisting in the management of pair status and configuration (for example, rejecting write I/Os to the S-VOL).

If the primary storage system is VSP 5000 series, the secondary system can be VSP 5000 series, VSP G1x00, VSP F1500, or VSP.

For VSP 5000 series, the CU can function simultaneously as a primary storage system for one or more P-VOLs and as a secondary storage system for one or more S-VOLs. This configuration requires that data paths and ports are configured for both copy directions.

## Volume pairs

Each TrueCopy for Mainframe volume pair consists of the P-VOL, which contains the original data, and the S-VOL, which contains the synchronous copy of the data on the P-VOL. After creating a copy pair, you can use the TrueCopy for Mainframe software to split, resynchronize, and reverse resynchronize pairs, and you can delete pairs as needed to return the volumes to an unpaired status.

- When paired, the volumes are synchronized.
- When split, new data is sent to the P-VOL but not the S-VOL.
- When resynchronized, data that changed while the pair was split is copied to the S-VOL.
- When necessary, data in the S-VOL can be copied to the P-VOL.

During normal operations, the P-VOL remains available to the host for read and write I/O operations. The secondary system rejects write I/Os for the S-VOL. The S-VOL can only be written to when the pair is split and when the write-enable option is specified for the S-VOL. In this instance, S-VOL and P-VOL track maps keep track of differential data and are used to resynchronize the pair.

## Data path

TrueCopy for Mainframe operations are carried out between primary and secondary storage systems connected by a Fibre Channel interface. The data path, also referred to as the remote copy connection, connects ports on the primary storage system to the ports on the secondary storage system. Ports are assigned attributes that allow them to send and receive data.

One data path connection is required, but two or more independent connections are recommended for hardware redundancy. A maximum of eight paths per control unit (CU) can be used.

## Consistency groups

A consistency group is a group of pairs on which copy operations are performed simultaneously and in which the status of the pairs remains consistent. A consistency group can include pairs that reside in up to four primary and secondary systems.

You can issue a TrueCopy for Mainframe command to a consistency group to perform the operation on all pairs in the group at the same time. The status of the pairs changes at the same time, though this depends on the group options you have set. Some pair operations take priority under certain circumstances. For details, see [Consistency group planning \(on page 77\)](#).

## User interfaces

You can perform TrueCopy for Mainframe operations using one of the following user interfaces:

- Hitachi Device Manager - Storage Navigator (HDvM - SN) is a browser-based graphical user interface (GUI) that allows you to perform TrueCopy for Mainframe operations from any LAN-attached computer.
  - The primary storage system must be LAN-attached to a Device Manager - Storage Navigator computer.
  - For disaster recovery purposes, the secondary storage system must be LAN-attached to a separate Device Manager - Storage Navigator computer at the secondary site so that you can perform operations on the secondary storage system in the event that the primary site is not available.
- Command Control Interface (CCI) is a command-line interface that allows you to perform TrueCopy for Mainframe operations by issuing commands to the storage system either from a client or server through the host Fibre Channel interface (in-band method) or from a LAN-attached computer (out-of-band method). CCI provides a scripting capability that enables you to automate replication operations.
- Business Continuity Manager (BCM) is an ISPF or command-line interface that allows you to perform TrueCopy for Mainframe pair operations and monitor pair status. BCM is mainframe host software and supports functions that are not supported by other management options.
- The IBM® Peer-to-Peer Remote Copy (PPRC) product enables you to perform most TrueCopy for Mainframe operations from the mainframe host. The VSP 5000 series storage system supports IBM® PPRC host software functions.

## Failover software

Host failover software is used to transfer information between host servers at the primary and secondary sites and is a critical component of a disaster recovery solution.

- When TrueCopy for Mainframe is used as a disaster recovery tool, host failover is required to ensure effective recovery operations.
- When TrueCopy for Mainframe is used as a data migration tool, host failover is recommended.

TrueCopy for Mainframe does not provide host failover functions. Use the failover software most suitable for your platform and requirements (for example, Copy Services Manager).

## Error reporting communications

Error reporting communications (ERC) transfer information between host processors at the primary and secondary sites. ERC is a critical component of a disaster recovery effort.

## Initial copy and update copy operations

When you create a copy pair, the initial copy operation is performed to copy all of the data in the P-VOL to the S-VOL. Once the pair is synchronized, the primary storage system performs update copy operations when it receives write I/Os for the P-VOL. The update copy operation ensures that host updates are performed on the P-VOL and the S-VOL at the same time.

The following figure illustrates the initial copy and update copy operations.

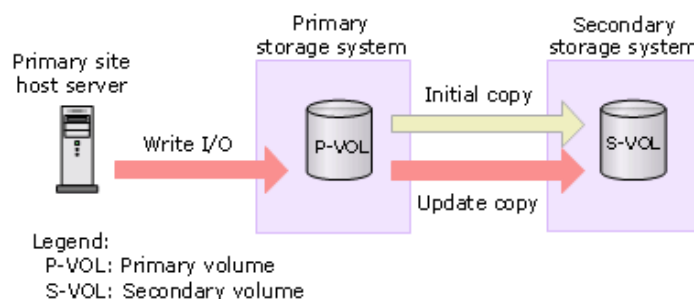

## Initial copy operations

When you create a copy pair, the contents of the P-VOL are copied to the S-VOL track by track (not including diagnostic and unassigned alternate tracks). The initial copy operation synchronizes the P-VOL and S-VOL independently of host I/O processes.

If you know that the data in the P-VOL and S-VOL are already identical, or if the P-VOL does not yet contain any data, you can select the None initial copy option. When you select this option, the pair becomes synchronized (PAIR status) immediately. You can also specify the following options to control the impact of the initial copy operations on the storage system performance:

- **Copy Pace.** Specifies the number of tracks that are copied simultaneously before the P-VOL accepts another host I/O request. If more tracks are copied, the initial copy operation is completed more quickly. If fewer tracks are copied, storage system performance (for example, host I/O response time) is maintained at a higher level. You can set this option when you create pairs using Device Manager - Storage Navigator or CCI. The following table lists the values for the copy pace and the transfer size per remote I/O (RIO).

Copy pace	Transfer size
3390 BCM	
1	174 KB (58 KB x 3)
3	870 KB (58 KB x 15)
Other than 3390 BCM	
1 to 3	174 KB (58 K x 3)
4 to 15	870 KB (58 KB x 15)

- **Maximum Initial Copy Activities.** Specifies the maximum number of concurrent initial copy operations.
- **Initial Copy Priority.** Specifies the order in which the initial copy operations are performed. This option applies when you create more pairs at the same time than the maximum initial copy activity setting. When using CCI, you can specify the order of initial copy operations for LUs and LDEVs by changing the order they are specified in the configuration definition file.
- **Round Trip Time.** You can specify the time limit for data to travel from the P-VOL to the S-VOL. This value is used by the storage system to control initial copy pace when update copying is in progress.

## Update copy operations

When the primary storage system accepts a host write operation for a P-VOL, the primary storage system performs an update copy operation to write the data on both the P-VOL and the S-VOL. The primary storage system does not accept another write operation for the P-VOL until it receives confirmation from the secondary storage system that the write operation was completed successfully on the S-VOL. This ensures that the data on the P-VOL and S-VOL remains synchronized.

Update copy operations have a higher priority than initial copy operations. However, if an initial copy operation is in progress when the host issues a write operation to a P-VOL, the update copy operation must wait until the completion of the number of tracks specified in the copy pace setting. For example, if the copy pace setting is 15 tracks, the update copy must wait until all 15 tracks (1 cylinder) in the initial copy operation are copied. At that time the update copy operation is performed, and then the initial copy operation is resumed.

## Pair status

The pair status is managed by the primary storage system which manages the P-VOLs.

- The primary storage system is able to change the pair status of the P-VOL and the S-VOL.
- The secondary storage system can change the pair status of the S-VOLs, but cannot change the pair status of the P-VOLs. The primary storage system detects the change of the pair status of S-VOL, and then change the status of P-VOL.
- The pair status changes as follows:
  - If the volume is not assigned to a TrueCopy for Mainframe pair, the volume status is *Simplex*.
  - When the initial copy begins to create a pair, the primary storage system changes the status of both volumes to *Pending* (volumes to be copying).
  - When the initial copy completes, the primary storage system changes the status of both volumes to *Duplex* (volumes become a pair).
  - When user splits the pair from the primary storage system or the secondary storage system, the status of the P-VOL and the S-VOL are changed to *Suspend*.
  - The primary storage system cannot keep the synchronization of the P-VOL and the S-VOL by some reasons, for example errors, the primary storage system changes the status of the P-VOL and the S-VOL to *Suspend*.
  - When the user removes the pair from the primary storage system, the primary storage system changes the status of the P-VOL and the S-VOL to *Simplex*.
  - When the user removes the pair from the secondary storage system, the secondary storage system changes the status of the S-VOL to *Simplex*, and then the primary storage system detects the removal of the pair at the secondary system (if the path is normal), the primary storage system changes the status of the P-VOL to *Suspend*.

---

## Chapter 2: Requirements and specifications

You need to know the basic system requirements, along with specifications for BCM, PPRC, and other mainframe-related interfaces and functions before using TrueCopy for Mainframe.

In addition to the information here, [Planning for TrueCopy for Mainframe \(on page 52\)](#) provides many specifications, recommendations, and restrictions for the elements of a TrueCopy for Mainframe system that require attention before setting up and using TrueCopy for Mainframe.

### System requirements and specifications

You should review and understand the general system requirements before configuring and using TrueCopy for Mainframe.

Item	Requirement
Control unit (CU)	<ul style="list-style-type: none"><li>▪ Number of CUs: 255</li><li>▪ Range of CUs: 0x00 to 0xfe</li></ul>
Supported emulation types	<ul style="list-style-type: none"><li>▪ 3390-A, 3390-3, 3390-9, 3390-L, 3390-M</li><li>▪ Earlier model emulation types that can be used: 3390-3R</li></ul>
RAID levels supported	RAID 1, RAID 5, and RAID 6 configurations.
Supported storage systems	<p>VSP 5000 series can be connected to:</p> <ul style="list-style-type: none"><li>▪ VSP 5000 series: 90-01-4x/xx or later</li><li>▪ VSP G1x00 and VSP F1500: 80-06-70-00/00 or later</li><li>▪ VSP: 70-06-63-00/00 or later</li></ul> <p>Use VSP 5000 series with microcode 90-01-01-00/00 or later at both the primary site and the secondary site so that you can perform operations at the secondary site during a disaster recovery.</p> <p>For details, see <a href="#">Requirements for pairing VSP 5000 series with other storage systems (on page 53)</a>.</p>

Item	Requirement
TrueCopy for Mainframe	<ul style="list-style-type: none"> <li>▪ Must be installed on the primary and secondary systems.</li> <li>▪ Separate license codes are required for each storage system.</li> <li>▪ For VSP 5000 series, TrueCopy can co-exist with TrueCopy.</li> </ul> <p>For information about exceeding licensed capacity and license expiration, see the <i>System Administrator Guide</i>.</p>
Other required licenses	<p>None.</p> <p>However, when combining TrueCopy for Mainframe and Dynamic Provisioning for Mainframe, the following licensed capacity limitations apply:</p> <ul style="list-style-type: none"> <li>▪ If using a DP-VOL for the TrueCopy for Mainframe P-VOL or S-VOL, the capacity of the allocated pages for the DP-VOL will be counted as the licensed capacity of TrueCopy for Mainframe.</li> <li>▪ If the actual licensed capacity exceeds the available licensed capacity, TrueCopy for Mainframe can be used as usual for 30 days. After 30 days, only split or release operations will be allowed.</li> </ul>
Supported mainframe host platforms	<p>For the supported version, refer to the Hitachi Vantara interoperability matrix at <a href="https://support.hitachivantara.com/en_us/interoperability.html">https://support.hitachivantara.com/en_us/interoperability.html</a>.</p> <ul style="list-style-type: none"> <li>▪ MVS</li> <li>▪ OS/390</li> <li>▪ VOS3</li> <li>▪ z/Linux RedHat</li> <li>▪ z/Linux SuSE</li> <li>▪ z/OS</li> <li>▪ z/VM</li> <li>▪ z/VSE</li> </ul>
Mainframe operations	<ul style="list-style-type: none"> <li>▪ IBM® PPRC is supported.</li> <li>▪ Optional error report communications (ERC) function requires MVS/DFP 3.2.0 or later.</li> <li>▪ If configuring an S-VOL of TCz to a P-VOL of URz with multiple hosts at primary site and secondary site, a SYSPLEX timer is required to synchronize the time on all hosts.</li> <li>▪ ICKDSF R16 + PTF functions require VM/ESA 2.1.0 or later.</li> </ul> <p>Contact customer support for the latest information.</p>

Item	Requirement
Data path	<p>A maximum of eight data paths are supported from primary system CU to secondary system CU.</p> <p>Fibre Channel with either direct or switch connections.</p> <p>For details, see <a href="#">Data path requirements and configurations (on page 61)</a>.</p>
Remote paths	<ul style="list-style-type: none"> <li>▪ A maximum of eight remote paths are supported from the primary system CU to the secondary system CU.</li> <li>▪ A primary system CU supports a maximum of 32 remote paths (8 paths per secondary system CU × 4 supported secondary system CUs per primary system CU).</li> <li>▪ Remote paths are established separately for primary and secondary system CUs.</li> <li>▪ Fibre Channel, iSCSI, direct, and switch connections are supported. For details, see <a href="#">Data path requirements and configurations (on page 61)</a>.</li> </ul>
Maximum number of secondary systems (CU)	<ul style="list-style-type: none"> <li>▪ A primary system CU can be paired with up to four secondary system CUs.</li> <li>▪ A primary system can have up to 1,020 paired secondary system CUs (255 primary system CUs × maximum of 4 secondary system CUs).</li> <li>▪ Each secondary system CU must be added (paired) individually to a primary system CU.</li> </ul>
Pair volumes	<ul style="list-style-type: none"> <li>▪ The S-VOL must be equal-to or larger-than the P-VOL. However, when the S-VOL is larger than the P-VOL, it is not possible to copy data from the S-VOL to P-VOL (for example, swap operation). Therefore, for normal remote copy operations, the P-VOL and S-VOL capacity should be equal.</li> <li>▪ Maximum capacity of P-VOL and S-VOL are: <ul style="list-style-type: none"> <li>• DP-VOL: Same as the maximum capacity of a mainframe emulation DP-VOL. For details, see the <i>Provisioning Guide for Mainframe Systems</i>.</li> <li>• Other than DP-VOL: 262,668 cylinders.</li> </ul> </li> <li>▪ A P-VOL can be copied to only one S-VOL.</li> <li>▪ P-VOLs and S-VOLs can be shared with other Hitachi software product volumes.</li> <li>▪ A volume (LDEV) from a parity group with accelerated compression enabled cannot be used directly as a pair volume. Such volumes must be used as pool volumes for an HDP or HDT pool.</li> </ul>



Item	Requirement
	For more information, see <a href="#">Pair and pair volumes planning (on page 68)</a> .
Number of pairs	<ul style="list-style-type: none"> <li>▪ VSP 5000 series : 65,280</li> </ul> <p>When BCM or CCI is used, a command device must be defined. In this case, the maximum number of pairs is calculated by subtracting 1 from the above number.</p>
Number of consistency groups	<ul style="list-style-type: none"> <li>▪ VSP 5000 series: Maximum: 256 (0 to 255)</li> <li>▪ Maximum: 256 (0x00 to 0xFF)</li> </ul>
Disk track format	<p>The track format for the P-VOL and S-VOL must meet the following requirements:</p> <ul style="list-style-type: none"> <li>▪ The P-VOL and S-VOL must have the same track format.</li> <li>▪ Record zero (R0) must be standard format, with key length of zero and data length of eight. If R0 is not standard format, the primary system aborts the initial copy operation.</li> <li>▪ The CCHH (logical cylinder address and logical head address) of R0 must be identical to the physical cylinder address and physical head address of the track.</li> <li>▪ The CCHH of each user record in a track must be unique.</li> </ul>
Error Reporting Communications (ERC) software	<ul style="list-style-type: none"> <li>▪ Required for disaster recovery.</li> <li>▪ Recommended for data migration.</li> </ul> <p>For details, see <a href="#">Error reporting communications (on page 93)</a>.</p>

Item	Requirement
Interfaces	<ul style="list-style-type: none"> <li>▪ Device Manager - Storage Navigator is required. <ul style="list-style-type: none"> <li>• The following HDvM - SN roles are required to operate: <ul style="list-style-type: none"> <li>- Storage Administrator (Remote Copy)</li> <li>- Storage Administrator (System Resource Management)</li> <li>- Storage Administrator (Provisioning)</li> </ul> </li> <li>• The primary system must be LAN-attached to a Device Manager - Storage Navigator computer.</li> <li>• The secondary system must be attached using a separate LAN at the secondary site.</li> </ul> </li> <li>▪ CCI is optional. <ul style="list-style-type: none"> <li>• When using virtual storage machine volumes, specify the logical device (LDEV) ID, serial number, and virtual information in the configuration definition file.</li> <li>• For information about setting up and using CCI, see the <i>Command Control Interface User and Reference Guide</i>.</li> <li>• For additional information, see <a href="#">CCI support for TrueCopy for Mainframe operations (on page 48)</a>.</li> </ul> </li> <li>▪ BCM is optional. <ul style="list-style-type: none"> <li>• A command device is required.</li> <li>• For details, see <a href="#">Business Continuity Manager specifications (on page 27)</a>.</li> </ul> </li> <li>▪ PPRC is optional. For details, see <a href="#">PPRC specifications and restrictions (on page 30)</a>.</li> </ul>
LU number	<p>LU number: 0 to 4095.</p> <ul style="list-style-type: none"> <li>▪ The number of LU paths that can be created can be up to 4096 for VSP 5000 series whose DKCMAIN program version is 90-02-0x-xx/xx or later.</li> <li>▪ The number of LU paths that can be created when connecting a VSP 5000 series with an earlier DKCMAIN program version is limited to 2048.</li> </ul> <p>For details, see <a href="#">Restrictions when creating an LU whose LU number is 2048 or greater (on page 76)</a>.</p>

## Business Continuity Manager specifications

Pair operations can be performed using Business Continuity Manager (BCM) commands from the host system to the storage system. You can use BCM commands to add, split, resynchronize, and delete pairs and to monitor pair status. You can also use BCM to create the TrueCopy for Mainframe association between the primary and secondary systems (add RCU).

- For the correspondence between the LINK parameters (ports) and SAID values, see [SAID values for CESTPATH/YKBLDPTH](#) (on page 33).
- For corresponding PPRC functionality, see [PPRC and BCM command comparison](#) (on page 31).
- Although the same TrueCopy for Mainframe pair operations can be performed by using Business Continuity Manager or PPRC, Business Continuity Manager and PPRC are independent functions. Do not use Business Continuity Manager and PPRC for the same pair operation.

For details, see the *Business Continuity Manager User's Guide*.

## Options not supported by Business Continuity Manager

Not all TrueCopy for Mainframe operation options are supported by Business Continuity Manager. The following table shows the default values used when you run the operation using Business Continuity Manager. Use Device Manager - Storage Navigator to change these options.

Operation	HDvM - SN	Option	Default value used by BCM
Pair create: YKMAKE	Create TC Pairs	Initial Copy Priority	Disabled <sup>2, 3</sup>
		CFW Data	Secondary Volume Copy <sup>1</sup>
		DFW to Secondary Volume	Not Require <sup>6</sup>
Pair split: YKSUSPND	Split Pairs	SSB Transfer (F/M = FB)	Disable <sup>7</sup>
		Primary Volume Write	Depends on Primary Volume Fence Level <sup>7</sup>
Pair resync: YKRESYNC	Resync Pairs	Copy Priority	Disable <sup>3, 4</sup>
	Edit Pair Options	CFW Data	Secondary Volume Copy <sup>1</sup>
Add remote connection: YKBLDPTH <sup>5</sup>	Add Remote Connection	Minimum Number of Paths	1
		RIO MIH Time	15 seconds
		FREEZE Option	Disable
		Round Trip Time	1ms

Operation	HDvM - SN	Option	Default value used by BCM
	Change CU Options	PPRC support by host	Yes or No <sup>8</sup>
		Services SIM of Remote Copy	No Report

**Notes:**

1. To change options, see [Changing P-VOL fence level and CFW data \(on page 142\)](#).
2. The initial copy operation follows the YKMAKE execution order.
3. For details about initial copy priority, see [Initial copy priority option and scheduling order \(on page 75\)](#).
4. The resync operation follows the YKRESYNC execution order. When YKRESYNC is performed for a consistency group, the operation begins with the pair having the lowest number within the group.
5. To change these options, see [Setting the remote replication options \(on page 115\)](#).
6. If you want to assign a different value to this option, use the Device Manager - Storage Navigator Add Pair operation. For details, see [Creating pairs \(on page 122\)](#).
7. If you want to assign a different value to this option, use the Device Manager - Storage Navigator Suspend Pair operation. For details, see [Splitting pairs \(on page 125\)](#).
8. When you add remote connection using Business Continuity Manager, if either of the following conditions is met, No is set. If neither of the following conditions are met, Yes is set:
  - Remote connection is added (YKBLDPTH) to a storage system at the other site using remote DKC control function.
  - Remote connection is added (YKBLDPTH) without using the remote DKC control function, and one of the following conditions is met:
    - System option mode 163 is enabled.
    - The primary system CU specified by Add Remote Connection (YKBLDPTH) is used as TPF.
    - The CU emulation type of the port connected to the Business Continuity Manager host is other than I-2107.

## Command device

Business Continuity Manager requires a command device for TrueCopy for Mainframe. The command device for BCM must be independent of any command device used for TrueCopy.

**Note:**

- If you do not use a command device for Business Continuity Manager, BCM commands are issued from the host to the scanned device. Because internal processing such as host I/O (Read / Write) processing and copy processing are operating in the scanned device, a conflict occurs between internal processing and BCM command processing. As a result, phenomena such as host I/O response delay or throughput decrease might occur, and moreover it might become MIH (Missing Interrupt Handler). Therefore, make sure to use the command device for BCM so as not to affect the host site
- Missing Interrupt Handler (MIH) values are used as I/O monitoring time for volumes used as command devices. Make sure to set the MIH value to at least 45 seconds from the host.

For more information and instructions, see the *Business Continuity Manager User Guide*.

## F/M = FB message output control option

In Business Continuity Manager, when a pair in DUPLEX status is suspended to the S-VOL, the status of the P-VOL becomes Suspend and the F/M = FB message is output to the host connected to the primary system. You are able to stop output of the message by setting system option mode 776.

However, the F/M = FB message is output even with system option mode 776 = ON when the pair status is Suspend due to failure. Also, if PPRC support by host = No is selected on the Change CU Options window, the F/M = FB message is not output regardless of the mode 776 setting.

The following table shows the conditions when the F/M=FB message is output (Yes) or stopped (No).

Cause of P-VOL suspend	Settings			
	SOM 776 = ON		SOM 776 = OFF	
	PPRC support by host = Yes	PPRC support by host = No	PPRC support by host = Yes	PPRC support by host = No
Suspended by suspend operation from BCM to S-VOLs	No	No	Yes	No
Suspended by failure	Yes	No	Yes	No

## PPRC specifications and restrictions

Most TrueCopy for Mainframe operations can be performed using PPRC TSO or ICKDSF PPRCOPY commands from the host system console. The VSP 5000 series supports IBM® PPRC host software functions.

### TrueCopy for Mainframe operations performed with PPRC

You can perform the following operations using PPRC:

- Create, suspend, resynchronize, and delete TrueCopy for Mainframe pairs.
- Split, resynchronize, and delete TrueCopy for Mainframe consistency groups.
- Establish and delete remote paths.
- View path and pair status.

The following applies when using PPRC commands:

- If required, VSP 5000 series storage system automatically changes the port configuration in response to the TSO CESTPATH and CDELPATH commands. That is, the remote path from the primary system to the secondary system changes to the copy path from the secondary system to the primary system.

The storage system verifies that the specified primary system port is offline to the host and automatically configures it as a sending port of TrueCopy for Mainframe command data, if required. Similarly, the corresponding secondary system port is configured as a receiving port of TrueCopy for Mainframe when required.

When the CDELPATH command is issued, TrueCopy for Mainframe remote paths are removed. If there are no more TrueCopy for Mainframe remote paths on the port, the port is automatically changed from the sending port to the receiving port of TrueCopy for Mainframe command data.

- For Fibre Channel interface, do not use the CESTPATH and CDELPATH commands when using the LUN Manager SCSI path definition function. Fibre Channel ports must be configured as bidirectional ports before the CESTPATH and CDELPATH commands are issued.



**Note:** Ensure that the relevant paths are offline before issuing the CESTPATH command. If active remote paths exist, the add path operation fails because the port attribute cannot be changed.

### TrueCopy for Mainframe options not supported with PPRC

The TrueCopy for Mainframe options in the following table are not supported with PPRC. Use Device Manager - Storage Navigator to change these options:

Operation	Device Manager - Storage Navigator screen	Option	Default value used by PPRC
Add the remote connection (CESTPATH)	Add Remote Connection	Minimum Number of Paths	1
		RIO MIH Time	15 sec.
		Round Trip Time	1 ms
		FREEZE Option	CGROUP option in CESTPATH command will be applied.
	Change CU Options	PPRC support by host	Yes
		Services SIM of Remote Copy	No Report
Create pair (CESTPAIR)	Create TC Pairs	Initial Copy Priority	0
		CFW Data	Secondary Volume Copy <sup>1</sup>
		DFW to Secondary Volume	Not Require <sup>2</sup>
<p><b>Notes:</b></p> <ol style="list-style-type: none"> <li>1. If you select the Primary Volume Only value for CFW Data option to create a TCz pair, the dataset that is updated by CFW in the P-VOL cannot be used in the S-VOL. To use this dataset in the S-VOL, release the pair and format the dataset. You can set the CFW data = Primary Volume Only using PPRC when the Remote Copy Function Switch is used. Before you use the Remote Copy Function Switch to specify CFW data = Primary Volume Only, confirm that system option mode (SOM) 1091 is OFF. If you specify Primary Volume Only when SOM 1091 is ON, the I/O to the S-VOL might terminate abnormally. For details about SOM 1091, contact customer support for more information.</li> <li>2. This setting does not affect P-VOL I/O performance. If one side of cache is closed due to a secondary system failure, the copy operation still uses DFW. The difference between Not Require and Require is that new pairs cannot be established with the required option when one side of RCU cache is closed. In this case, the Add Pair operation fails.</li> </ol>			

## PPRC and BCM command comparison

BCM and PPRC are independent functions. Do not use BCM and PPRC for the same pair operation.

The following table lists the PPRC commands and the corresponding BCM commands.

PPRC command	Parameter	BCM command	Support type
CESTPATH	DEVN	YKBLDPTH	config
	PRIM		config
	SEC		config
	LINK		config
	CGROUP		Not supported
	RESETHP		Not supported
CESTPAIR	DEVN	YKMAKE or YKRESYNC	config
	PRIM		config
	SEC		config
	MODE		Command (RESYNC) Parameter (NOCOPY)
	PACE		config (CopyPace)
	CRIT		config (ErrorLevel)
	MSGREQ		Not supported
	ONLINSEC		Not supported
CSUSPEND	DEVN	YKSUSPND*	config
	PRIM		config
	SEC		config
	PRIMARY		Not supported
	QUIESCE		Not supported
CDELPAIR	DEVN	YKDELETE	config
	PRIM		
	SEC		
CRECOVER	DEVN	YKRECOVER	config
	PRIM		
	SEC		
	ID		
CQUERY	DEVN	YKQUERY	config



PPRC command	Parameter	BCM command	Support type
	FORMAT or UNFORMAT		Not supported
	VOLUME/PATHS		Not supported
CGROUP	DEVN	YKFREEZE or YKRUN	config
	PRIM		config
	SEC		config
	FREEZE/RUN		command
CDELPATH	DEVN	YKDELPTH	config
	PRIM		config
	SEC		config

\*The YKSUSPEND command supports only the pair suspend command for the P-VOL.

## SAID values for CESTPATH/YKBLDPTH

The following tables show the correspondence between the LINK parameters (ports) and SAID (system adapter ID) values in:

- [SAID values for PATH LINK \(CBX#0\) \(on page 34\)](#)
- [SAID values for PATH LINK \(CBX#1\) \(on page 34\)](#)
- [SAID values for PATH LINK \(CBX#2\) \(on page 35\)](#)
- [SAID values for PATH LINK \(CBX#3\) \(on page 36\)](#)
- [SAID values for PATH LINK \(CBX#4\) \(on page 37\)](#)
- [SAID values for PATH LINK \(CBX#5\) \(on page 37\)](#)



**Note:** The SAID values for the LINK parameter used in CESTPATH/YKBLDPTH differ from the SAID values for RMF™ PPRC link path statistical information. For details about the SAID values for RMF™ PPRC link path statistical information, see the tables in [RMFTM PPRC link path statistical information support \(on page 39\)](#).

## SAID values for PATH LINK (CBX#0)

Package location	Port	SAID	Package location	Port	SAID
CHB-01A	CL1-A	X'0000'	CHB-02A	CL1-B	X'0001'
	CL3-A	X'0020'		CL3-B	X'0021'
	CL5-A	X'0040'		CL5-B	X'0041'
	CL7-A	X'0060'		CL7-B	X'0061'
CHB-01B	CL1-C	X'0002'	CHB-02B	CL1-D	X'0003'
	CL3-C	X'0022'		CL3-D	X'0023'
	CL5-C	X'0042'		CL5-D	X'0043'
	CL7-C	X'0062'		CL7-D	X'0063'
CHB-01E	CL1-E	X'0004'	CHB-02E	CL1-F	X'0005'
	CL3-E	X'0024'		CL3-F	X'0025'
	CL5-E	X'0044'		CL5-F	X'0045'
	CL7-E	X'0064'		CL7-F	X'0065'
CHB-01F	CL1-G	X'0006'	CHB-02F	CL1-H	X'0007'
	CL3-G	X'0026'		CL3-H	X'0027'
	CL5-G	X'0046'		CL5-H	X'0047'
	CL7-G	X'0066'		CL7-H	X'0067'

## SAID values for PATH LINK (CBX#1)

Package location	Port	SAID	Package location	Port	SAID
CHB-11A	CL2-A	X'0010'	CHB-12A	CL2-B	X'0011'
	CL4-A	X'0030'		CL4-B	X'0031'
	CL6-A	X'0050'		CL6-B	X'0051'
	CL8-A	X'0070'		CL8-B	X'0071'
CHB-11B	CL2-C	X'0012'	CHB-12B	CL2-D	X'0013'
	CL4-C	X'0032'		CL4-D	X'0033'

Package location	Port	SAID	Package location	Port	SAID
	CL6-C	X'0052'		CL6-D	X'0053'
	CL8-C	X'0072'		CL8-D	X'0073'
CHB-11E	CL2-E	X'0014'	CHB-12E	CL2-F	X'0015'
	CL4-E	X'0034'		CL4-F	X'0035'
	CL6-E	X'0054'		CL6-F	X'0055'
	CL8-E	X'0074'		CL8-F	X'0075'
CHB-11F	CL2-G	X'0016'	CHB-12F	CL2-H	X'0017'
	CL4-G	X'0036'		CL4-H	X'0037'
	CL6-G	X'0056'		CL6-H	X'0057'
	CL8-G	X'0076'		CL8-H	X'0077'

## SAID values for PATH LINK (CBX#2)

Package location	Port	SAID	Package location	Port	SAID
CHB-21A	CL1-J	X'0008'	CHB-22A	CL1-K	X'0009'
	CL3-J	X'0028'		CL3-K	X'0029'
	CL5-J	X'0048'		CL5-K	X'0049'
	CL7-J	X'0068'		CL7-K	X'0069'
CHB-21B	CL1-L	X'000A'	CHB-22B	CL1-M	X'000B'
	CL3-L	X'002A'		CL3-M	X'002B'
	CL5-L	X'004A'		CL5-M	X'004B'
	CL7-L	X'006A'		CL7-M	X'006B'
CHB-21E	CL1-N	X'000C'	CHB-22E	CL1-P	X'000D'
	CL3-N	X'002C'		CL3-P	X'002D'
	CL5-N	X'004C'		CL5-P	X'004D'
	CL7-N	X'006C'		CL7-P	X'006D'
CHB-21F	CL1-Q	X'000E'	CHB-22F	CL1-R	X'000F'

Package location	Port	SAID	Package location	Port	SAID
	CL3-Q	X'002E'		CL3-R	X'002F'
	CL5-Q	X'004E'		CL5-R	X'004F'
	CL7-Q	X'006E'		CL7-R	X'006F'

## SAID values for PATH LINK (CBX#3)

Package location	Port	SAID	Package location	Port	SAID
CHB-31A	CL2-J	X'0018'	CHB-32A	CL2-K	X'0019'
	CL4-J	X'0038'		CL4-K	X'0039'
	CL6-J	X'0058'		CL6-K	X'0059'
	CL8-J	X'0078'		CL8-K	X'0079'
CHB-31B	CL2-L	X'001A'	CHB-32B	CL2-M	X'001B'
	CL4-L	X'003A'		CL4-M	X'003B'
	CL6-L	X'005A'		CL6-M	X'005B'
	CL8-L	X'007A'		CL8-M	X'007B'
CHB-31E	CL2-N	X'001C'	CHB-32E	CL2-P	X'001D'
	CL4-N	X'003C'		CL4-P	X'003D'
	CL6-N	X'005C'		CL6-P	X'005D'
	CL8-N	X'007C'		CL8-P	X'007D'
CHB-31F	CL2-Q	X'001E'	CHB-32F	CL2-R	X'001F'
	CL4-Q	X'003E'		CL4-R	X'003F'
	CL6-Q	X'005E'		CL6-R	X'005F'
	CL8-Q	X'007E'		CL8-R	X'007F'

## SAID values for PATH LINK (CBX#4)

Package location	Port	SAID	Package location	Port	SAID
CHB-41A	CL9-A	X'0080'	CHB-42A	CL9-B	X'0081'
	CLB-A	X'00A0'		CLB-B	X'00A1'
	CLD-A	X'00C0'		CLD-B	X'00C1'
	CLF-A	X'00E0'		CLF-B	X'00E1'
CHB-41B	CL9-C	X'0082'	CHB-42B	CL9-D	X'0083'
	CLB-C	X'00A2'		CLB-D	X'00A3'
	CLD-C	X'00C2'		CLD-D	X'00C3'
	CLF-C	X'00E2'		CLF-D	X'00E3'
CHB-41E	CL9-E	X'0084'	CHB-42E	CL9-F	X'0085'
	CLB-E	X'00A4'		CLB-F	X'00A5'
	CLD-E	X'00C4'		CLD-F	X'00C5'
	CLF-E	X'00E4'		CLF-F	X'00E5'
CHB-41F	CL9-G	X'0086'	CHB-42F	CL9-H	X'0087'
	CLB-G	X'00A6'		CLB-H	X'00A7'
	CLD-G	X'00C6'		CLD-H	X'00C7'
	CLF-G	X'00E6'		CLF-H	X'00E7'

## SAID values for PATH LINK (CBX#5)

Package location	Port	SAID	Package location	Port	SAID
CHB-51A	CLA-A	X'0090'	CHB-52A	CLA-B	X'0091'
	CLC-A	X'00B0'		CLC-B	X'00B1'
	CLE-A	X'00D0'		CLE-B	X'00D1'
	CLG-A	X'00F0'		CLG-B	X'00F1'
CHB-51B	CLA-C	X'0092'	CHB-52B	CLA-D	X'0093'
	CLC-C	X'00B2'		CLC-D	X'00B3'

Package location	Port	SAID	Package location	Port	SAID
	CLE-C	X'00D2'		CLE-D	X'00D3'
	CLG-C	X'00F2'		CLG-D	X'00F3'
CHB-51E	CLA-E	X'0094'	CHB-52E	CLA-F	X'0095'
	CLC-E	X'00B4'		CLC-F	X'00B5'
	CLE-E	X'00D4'		CLE-F	X'00D5'
	CLG-E	X'00F4'		CLG-F	X'00F5'
CHB-51F	CLA-G	X'0096'	CHB-52F	CLA-H	X'0097'
	CLC-G	X'00B6'		CLC-H	X'00B7'
	CLE-G	X'00D6'		CLE-H	X'00D7'
	CLG-G	X'00F6'		CLG-H	X'00F7'

## P/DAS support and restrictions

TrueCopy for Mainframe supports the IBM® PPRC dynamic address switching (P/DAS) host software function. P/DAS allows you to relocate or migrate data by redirecting all application I/Os from the P-VOL to the S-VOL without interrupting access to the data. For important information about the requirements and procedures for P/DAS operations, see the following IBM® publications: *Planning for IBM Remote Copy (SG24-2595)*, *Advanced Copy Services (SC35-0355)*, *DFSMS MVS V1 Remote Copy Guide and Reference (SC35-0169)*.

### P/DAS restrictions

The following restrictions apply to the use of P/DAS with TrueCopy for Mainframe:

- P/DAS through channel extenders is not supported.
- P/DAS does not support CFW operations. You must stop CFW applications before performing P/DAS operations on TrueCopy for Mainframe volumes.
- P/DAS swap option #2 (switch pair & swap) is supported for P/DAS between the VSP 5000 series and older storage system models (for example, VSP).

For the latest information about P/DAS support, contact customer support.

## GDPS support

TrueCopy for Mainframe provides remote copy support for the IBM® Geographically Dispersed Parallel Sysplex (GDPS) facility. GDPS is an IBM® service for mirroring data and balancing workload on storage systems spread across two or more sites up to 40 km (20 miles) apart. With this support, users who are running IBM® Parallel Sysplex® systems can take advantage of numerous remote copy options for data availability.

GDPS operations feature automatic control of groups of PPRC-managed volumes using host-based scripts and PPRC commands, for example, CGROUP (FREEZE/RUN). GDPS support can have additional installation requirements for TrueCopy for Mainframe primary and secondary systems, depending on the microcode and TrueCopy for Mainframe versions. Check with customer support.

VSP 5000 series does not support controlling the FREEZE Option through the CESTPATH LINK parameter. The FREEZE Option must be controlled using the CGROUP option of CESTPATH. Make changes as needed to the CESTPATH LINK definitions in your GDPS configuration files or configuration database.



**Note:** When you use TrueCopy for Mainframe in a GDPS environment, the total number of paths for remote copy connections that is calculated for each CU might exceed 160. If this happens, a time-out error might occur in the HyperSwap function, and the HyperSwap operation might fail. Contact customer support when the total number exceeds 160.

For more information about GDPS, see the following IBM® publications: *Geographically Dispersed Parallel Sysplex: the S/390 Multi-site Application Availability Solution, Executive Summary (GF22-5114)* and *Geographically Dispersed Parallel Sysplex: the S/390 Multi-site Application Availability Solution (GF22-5063)*.

## RMF™ PPRC link path statistical information support

When you use IBM® Resource Measurement Facility™ (RMF™) and specify the IBM® TotalStorage Enterprise Storage Server® (ESS), you can acquire PPRC fibre link path statistical information.

If the total size of the data for the data-acquisition interval is 100 KB or less, zero might be reported for the data size.

For details about the SAID values for the LINK parameters (ports) that are displayed when PPRC link path statistical information is acquired with RMF™, see:

- [SAID values for PATH LINK \(CBX#0\) \(on page 40\)](#)
- [SAID values for PATH LINK \(CBX#1\) \(on page 40\)](#)
- [SAID values for PATH LINK \(CBX#2\) \(on page 41\)](#)
- [SAID values for PATH LINK \(CBX#3\) \(on page 42\)](#)
- [SAID values for PATH LINK \(CBX#4\) \(on page 43\)](#)
- [SAID values for PATH LINK \(CBX#5\) \(on page 43\)](#)

## SAID values for PATH LINK (CBX#0)

Package location	Port	SAID	Package location	Port	SAID
CHB-01A	CL1-A	X'0000'	CHB-02A	CL1-B	X'0010'
	CL3-A	X'0001'		CL3-B	X'0011'
	CL5-A	X'0002'		CL5-B	X'0012'
	CL7-A	X'0003'		CL7-B	X'0013'
CHB-01B	CL1-C	X'0004'	CHB-02B	CL1-D	X'0014'
	CL3-C	X'0005'		CL3-D	X'0015'
	CL5-C	X'0006'		CL5-D	X'0016'
	CL7-C	X'0007'		CL7-D	X'0017'
CHB-01E	CL1-E	X'0008'	CHB-02E	CL1-F	X'0018'
	CL3-E	X'0009'		CL3-F	X'0019'
	CL5-E	X'000a'		CL5-F	X'001a'
	CL7-E	X'000b'		CL7-F	X'001b'
CHB-01F	CL1-G	X'000c'	CHB-02F	CL1-H	X'001c'
	CL3-G	X'000d'		CL3-H	X'001d'
	CL5-G	X'000e'		CL5-H	X'001e'
	CL7-G	X'000f'		CL7-H	X'001f'

## SAID values for PATH LINK (CBX#1)

Package location	Port	SAID	Package location	Port	SAID
CHB-11A	CL2-A	X'0020'	CHB-12A	CL2-B	X'0030'
	CL4-A	X'0021'		CL4-B	X'0031'
	CL6-A	X'0022'		CL6-B	X'0032'
	CL8-A	X'0023'		CL8-B	X'0033'
CHB-11B	CL2-C	X'0024'	CHB-12B	CL2-D	X'0034'
	CL4-C	X'0025'		CL4-D	X'0035'



Package location	Port	SAID	Package location	Port	SAID
	CL6-C	X'0026'		CL6-D	X'0036'
	CL8-C	X'0027'		CL8-D	X'0037'
CHB-11E	CL2-E	X'0028'	CHB-12E	CL2-F	X'0038'
	CL4-E	X'0029'		CL4-F	X'0039'
	CL6-E	X'002a'		CL6-F	X'003a'
	CL8-E	X'002b'		CL8-F	X'003b'
CHB-11F	CL2-G	X'002c'	CHB-12F	CL2-H	X'003c'
	CL4-G	X'002d'		CL4-H	X'003d'
	CL6-G	X'002e'		CL6-H	X'003e'
	CL8-G	X'002f'		CL8-H	X'003f'

**SAID values for PATH LINK (CBX#2)**

Package location	Port	SAID	Package location	Port	SAID
CHB-21A	CL1-J	X'0040'	CHB-22A	CL1-K	X'0050'
	CL3-J	X'0041'		CL3-K	X'0051'
	CL5-J	X'0042'		CL5-K	X'0052'
	CL7-J	X'0043'		CL7-K	X'0053'
CHB-21B	CL1-L	X'0044'	CHB-22B	CL1-M	X'0054'
	CL3-L	X'0045'		CL3-M	X'0055'
	CL5-L	X'0046'		CL5-M	X'0056'
	CL7-L	X'0047'		CL7-M	X'0057'
CHB-21E	CL1-N	X'0048'	CHB-22E	CL1-P	X'0058'
	CL3-N	X'0049'		CL3-P	X'0059'
	CL5-N	X'004a'		CL5-P	X'005a'
	CL7-N	X'004b'		CL7-P	X'005b'
CHB-21F	CL1-Q	X'004c'	CHB-22F	CL1-R	X'005c'

Package location	Port	SAID	Package location	Port	SAID
	CL3-Q	X'004d'		CL3-R	X'005d'
	CL5-Q	X'004e'		CL5-R	X'005e'
	CL7-Q	X'004f'		CL7-R	X'005f'

**SAID values for PATH LINK (CBX#3)**

Package location	Port	SAID	Package location	Port	SAID
CHB-31A	CL2-J	X'0060'	CHB-32A	CL2-K	X'0070'
	CL4-J	X'0061'		CL4-K	X'0071'
	CL6-J	X'0062'		CL6-K	X'0072'
	CL8-J	X'0063'		CL8-K	X'0073'
CHB-31B	CL2-L	X'0064'	CHB-32B	CL2-M	X'0074'
	CL4-L	X'0065'		CL4-M	X'0075'
	CL6-L	X'0066'		CL6-M	X'0076'
	CL8-L	X'0067'		CL8-M	X'0077'
CHB-31E	CL2-N	X'0068'	CHB-32E	CL2-P	X'0078'
	CL4-N	X'0069'		CL4-P	X'0079'
	CL6-N	X'006a'		CL6-P	X'007a'
	CL8-N	X'006b'		CL8-P	X'007b'
CHB-31F	CL2-Q	X'006c'	CHB-32F	CL2-R	X'007c'
	CL4-Q	X'006d'		CL4-R	X'007d'
	CL6-Q	X'006e'		CL6-R	X'007e'
	CL8-Q	X'006f'		CL8-R	X'007f'

## SAID values for PATH LINK (CBX#4)

Package location	Port	SAID	Package location	Port	SAID
CHB-41A	CL9-A	X'0080'	CHB-42A	CL9-B	X'0090'
	CLB-A	X'0081'		CLB-B	X'0091'
	CLD-A	X'0082'		CLD-B	X'0092'
	CLF-A	X'0083'		CLF-B	X'0093'
CHB-41B	CL9-C	X'0084'	CHB-42B	CL9-D	X'0094'
	CLB-C	X'0085'		CLB-D	X'0095'
	CLD-C	X'0086'		CLD-D	X'0096'
	CLF-C	X'0087'		CLF-D	X'0097'
CHB-41E	CL9-E	X'0088'	CHB-42E	CL9-F	X'0098'
	CLB-E	X'0089'		CLB-F	X'0099'
	CLD-E	X'008a'		CLD-F	X'009a'
	CLF-E	X'008b'		CLF-F	X'009b'
CHB-41F	CL9-G	X'008c'	CHB-42F	CL9-H	X'009c'
	CLB-G	X'008d'		CLB-H	X'009d'
	CLD-G	X'008e'		CLD-H	X'009e'
	CLF-G	X'008f'		CLF-H	X'009f'

## SAID values for PATH LINK (CBX#5)

Package location	Port	SAID	Package location	Port	SAID
CHB-51A	CLA-A	X'00a0'	CHB-52A	CLA-B	X'00b0'
	CLC-A	X'00a1'		CLC-B	X'00b1'
	CLE-A	X'00a2'		CLE-B	X'00b2'
	CLG-A	X'00a3'		CLG-B	X'00b3'
CHB-51B	CLA-C	X'00a4'	CHB-52B	CLA-D	X'00b4'
	CLC-C	X'00a5'		CLC-D	X'00b5'

Package location	Port	SAID	Package location	Port	SAID
	CLE-C	X'00a6'		CLE-D	X'00b6'
	CLG-C	X'00a7'		CLG-D	X'00b7'
CHB-51E	CLA-E	X'00a8'	CHB-52E	CLA-F	X'00b8'
	CLC-E	X'00a9'		CLC-F	X'00b9'
	CLE-E	X'00aa'		CLE-F	X'00ba'
	CLG-E	X'00ab'		CLG-F	X'00bb'
CHB-51F	CLA-G	X'00ac'	CHB-52F	CLA-H	X'00bc'
	CLC-G	X'00ad'		CLC-H	X'00bd'
	CLE-G	X'00ae'		CLE-H	X'00be'
	CLG-G	X'00af'		CLG-H	X'00bf'

## Planning for Basic HyperSwap<sup>®</sup>, TPC-R, and CSM operations

The Basic HyperSwap<sup>®</sup> function, IBM<sup>®</sup> Tivoli Storage Productivity Center for Replication (TPC-R), and Copy Services Manager (CSM) operations are supported by TrueCopy for Mainframe operations with TPC-R or CSM. The following figure illustrates TrueCopy for Mainframe operations with TPC-R or CSM.

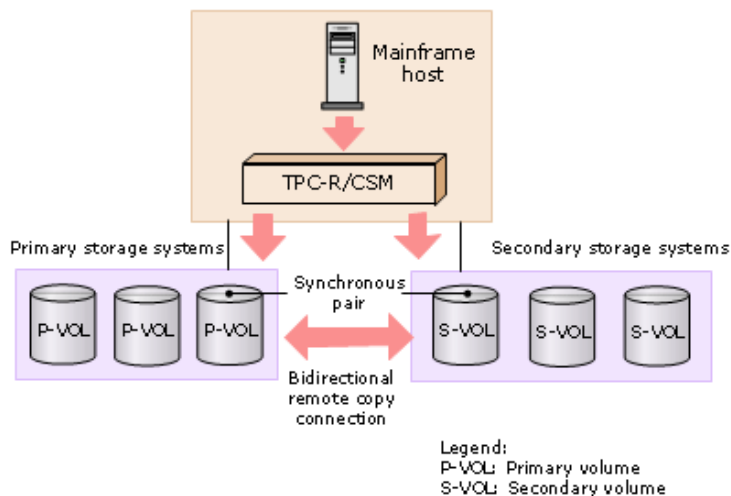

## Requirements for Basic HyperSwap<sup>®</sup>, TPC-R, and CSM operations

- System option mode 484, 573, and 769 are set to ON.
- A bidirectional path between the primary system and the secondary system must be in place.

## Recommendations for Basic HyperSwap<sup>®</sup>, TPC-R, and CSM operations

- For best performance, the maximum number of pairs for the Basic HyperSwap<sup>®</sup> function is 1,000 per CHA.
- If you perform the Basic HyperSwap function from TPC-R or CSM, the MIH value of host I/O and the host operation is about one second. This value allows MIH to be reported for host I/O or for the host operation.
- Resources in the host system must be adequate. If a shortage occurs, resynchronization of TrueCopy for Mainframe pairs might fail.
- Before you execute the FREEZE command, make sure that the FREEZE operation can be completed within 20 seconds to avoid failure. Configure your system as follows:
  - $(\text{Number of Host paths}) \times (\text{Number of LPARs}) \times (\text{Number of CGROUPs (Number of CUs)}) \leq 160$
  - Number of pairs  $\leq 4,096$
- When switching the P-VOL and the S-VOL using the Basic HyperSwap function, use an existing path to resynchronize the TCz pair.  
If no paths are created, you cannot switch the volumes using the Basic HyperSwap function.
- Use the same model and the same microcode version for storage systems at the primary and secondary sites. Otherwise, supported functions differ between the primary storage system and the secondary storage systems.

After switching the P-VOL and the S-VOL using Basic HyperSwap function, if a command for an unsupported function is issued, the command might terminate abnormally.

## Planning for Extended Address Volume

Extended Address Volume (EAV) can be assigned to a TrueCopy for Mainframe pair. EAV is a Hitachi function to define a large capacity VOL that is not supported by existing 3390 type volumes. You can create a pair with and/or without EAV. The following table shows EAV availability for P-VOLs and S-VOLs.

P-VOL (Device emulation type)	S-VOL (device emulation type)	
	EAV (3390-A)	No EAV (3390-X*)
EAV (3390-A)	Available	Not available

P-VOL (Device emulation type)	S-VOL (device emulation type)	
	EAV (3390-A)	No EAV (3390-X*)
non-EAV (3390-X*)	Available	Available
* 3390-X indicates the 3390 series other than 3390-A. For these other supported 3390 emulation types, see the table in <a href="#">System requirements and specifications (on page 22)</a> .		

Emulation type 3390 combined with non-3390 device types is not available.

To enable data migration from existing storage to the EAV (3390-A), you can combine a non-EAV (3390-X) as the P-VOL and an EAV (3390-A) as the S-VOL. However, a reversed combination in which EAV (3390-A) is the P-VOL and non-EAV (3390-X) is the S-VOL is not supported.



**Note:** You can use data migration from an earlier storage model P-VOL to an EAV S-VOL. When you do this, note that the following two field values for the S-VOL in the Device Manager - Storage Navigator Detailed Information dialog box:

- The emulation type is shown as .....
- If the number of cylinders in the S-VOL is greater than 65,535, the number of cylinders is still displayed as 65,535.

## zHyperWrite function support

VSP 5000 series is compatible with the zHyperWrite function of the IBM® DS8000® disk system. The zHyperWrite function enables hosts to write DB2® logs directly to the TCz P-VOL and the TCz S-VOL. To use the zHyperWrite function on the storage system, the following are required:

- PTF
- z/OS® V2R1 or later
- The Basic HyperSwap® function of TPC-R/CSM, or the HyperSwap® function of GDPS

For details, see the IBM® documentation.

**Note:**

- The zHyperWrite function cannot be used in a 3DC URz/TCz configuration. I/Os reject commands when you use the zHyperWrite function in the 3DC URz/TCz configuration (F/M=0F, Reason Code=78). In addition, if you copy data in a 3DC configuration, do not specify a volume in which DB2® logs exist as the operation target.
- The zHyperWrite function and the Preserve Mirror FlashCopy® function can be used together. However, if the Preserve Mirror FlashCopy® function is used to back up the log volume being updated with zHyperWrite, there might be a difference in the backup data between the two Compatible FlashCopy® target volumes. This is expected behavior as an IBM® zHyperWrite program.

If there is a difference in the backup data between the target volumes, the storage system data can be recovered by re-quiring the backup data using the Preserve Mirror FlashCopy® function when there is no update by zHyperWrite.

- If CFW data is set to Primary Volume Only, the zHyperWrite function cannot be used. In this case, to use the function, delete TCz pairs, disable the function switch #12, and then re-create the pairs.
- If you use the zHyperWrite function for created TCz pairs, delete them first, disable the function switch #12, and then re-create the pairs.

To enable the zHyperWrite function, you must set system option mode (SOM) 1091 to ON on both the MCU and the RCU. When SOM 1091 is set to ON on the MCU and RCU, the host recognizes that the storage systems at the primary and secondary sites support the function, and then the function is enabled. To disable the zHyperWrite function, set SOM 1091 to OFF on the MCU. (When the SOM is OFF on the MCU, the function is invalidated at both sites.) The SOMs can only be set by your service representative.

In some cases, the zHyperWrite function is not enabled (or disabled) after SOM 1091 is set to ON (or OFF). After SOM 1091 is set to ON (or OFF), verify that the zHyperWrite function is enabled (or disabled) by using RMF to see if the host is writing DB2® logs directly to the S-VOL of a TCz pair in which the DB2® log dataset is stored. If the host is writing DB2® logs directly to the S-VOL, the zHyperWrite function is enabled.

When SOM 1091 is set to ON (or OFF) but the zHyperWrite function is not enabled (or disabled), perform the following procedure to enable (or disable) the function.

The setting of CFW data for PPRC/TCz pairs must be set to Secondary Volume Copy. CFW data is copied to the S-VOL. If this is not set, zHyperWrite will not function.

**Procedure**

1. Execute the `validate` command of z/OS® for volumes in the same CU. Executing this command for volumes that are not paired as TCz pairs is recommended.

```
ds qd,DEV#,validate
```

2. Verify that the zHyperWrite function is enabled (or disabled) by using RMF to see if the host is writing DB2® logs directly to the S-VOL of a TCz pair in which the DB2® log dataset is stored.

3. If the zHyperWrite function is not enabled (or disabled), execute the `Vary Path ONLINE` command of z/OS® for volumes in the same CU. Executing this command for volumes that are not paired as TCz pairs is recommended. In addition, execute the command for one of the paths connected to volumes for which the command is executed from the target host.

```
v path(DEV#,CHPID#),online
```

After executing the command, verify that the zHyperWrite function is enabled (or disabled). Then repeat step 2.

4. If the function is still not enabled (or disabled), execute the `Vary ON DEVICE` command for volumes in the same CU. Executing this command for volumes that are not paired as TCz pairs is recommended.

```
v DEV#,online
```

After executing the command, verify that the zHyperWrite function is enabled (or disabled). Then repeat step 2.

5. If the function is still not enabled (or disabled), split and then resynchronize the TCz pairs, and then check again to see if the function is enabled (or disabled). Then repeat step 2.
6. Verify that the CFW data setting for the **PPRC/TCz** pair is set to **Secondary Volume Copy**. Make sure that the CFW data setting for the PPRC/TCz pairs is set to **Secondary Volume Copy** so that CFW data is copied to the S-VOL. If this is not set, zHyperWrite will not function. For more information on creating pairs, see [Creating pairs \(on page 122\)](#).
7. If the function is still not enabled (or disabled), or the TCz pairs are not split or resynchronized, restart the host.

## CCI support for TrueCopy for Mainframe operations

You can use CCI to perform pair operations and path operations for both TrueCopy for Mainframe and TrueCopy.

For details about performing CCI operations from open-systems hosts (in-band method) and from LAN-attached computers (out-of-band method), see the user documentation for CCI.

### Supported operations and options

The following table lists the Device Manager - Storage Navigator operations and options and indicates whether the operation or option is supported by CCI.



Category	HDvM - SN operation	Option	CCI support	
Pair operations	Create TC pairs	(no option)	Yes	
		Initial Copy Type	Yes	
		Copy Pace <sup>1</sup>	Yes	
		Initial Copy Priority	No (fixed to 32)	
		Difference Management	No (fixed to Auto)	
		CFW Data	No (fixed to S-VOL) <sup>2</sup>	
		DFW to Secondary Volume	No (fixed to DFW not required)	
		Host I/O Time Stamp Transfer	No (fixed to Disable) <sup>3</sup>	
	Split pairs	(no option)	Yes	
		SSB Transfer (F/M = FB)	No (fixed to Disable)	
		Primary Volume Write	No (fixed to S-VOL)	
	Resync pairs	(no option)	Yes	
		Primary Volume Fence Level	Yes	
		Copy Pace <sup>1</sup>	Yes	
		Copy Priority	No (fixed to 32)	
		CFW Data (not in HDvM - SN for this operation)	No (fixed to S-VOL) <sup>2</sup>	
		Host I/O Time Stamp Transfer	No (fixed to Disable) <sup>3, 4</sup>	
	Delete pairs	(no option)	Yes	
		Delete Mode	No (fixed to Normal) <sup>3, 4</sup>	
	Edit pair options	(no option)	No	
	Path operations	Add remote connections	(no option)	Yes
			Minimum Paths	No (fixed to 1)
			RIO MIH Time (sec)	No (fixed to 15 sec.)
FREEZE Option			No (fixed to Disable)	
Round Trip Time (msec)			No (fixed to 1 msec)	

Category	HDvM - SN operation	Option	CCI support
	Remove remote connections	(no option)	Yes
	Add/remove remote paths	(no option)	Yes
	Add/remove SSIDs	(no option)	Yes
	Change RCU options	(no option)	Yes
		Minimum Paths	Yes
		RIO MIH Time (sec)	Yes
		FREEZE Option	Yes
		Round Trip Time (msec)	Yes
Other operations	Edit remote replica options	(no option)	No
	Change CU options	(no option)	No
	Performance Monitor	(no option)	No
	View history	(no option)	No

**Notes:**

1. With Device Manager - Storage Navigator you select 3 or 15 tracks for Copy Pace. For CCI, you use the track size parameter with basically the same track settings: if you specify 1-3, 3 tracks are used, and if you specify 4-15, 15 tracks are used.
2. For the CFW Data option, you can specify Primary Volume Only only if Remote Copy Function Switch #12 is also enabled. If you select CFW Data = Primary Volume Only, the data set that is updated by CFW in the P-VOL cannot be used in the S-VOL. To use this data set in the S-VOL, delete the pair and format the data set.
3. You can only enable the Host I/O Time Stamp Transfer option if Remote Copy Function Switch #36 is also enabled.

Enable the Host I/O Time Stamp Transfer option for the following functions:

- ATTIME Suspend when used in a 3DC cascade configuration. The Host I/O Time Stamp Transfer option is necessary to support the ATTIME Suspend of an Slz pair that is cascaded with the TCz S-VOL/URz P-VOL in the intermediate site.
- In a 3DC cascade configuration when the related URz remote journal is in an extended consistency group.

Category	HDvM - SN operation	Option	CCI support
<p>4. You cannot enable or disable the Host I/O Time Stamp Transfer option when the pair is resynchronized in CCI. Unless you delete the pair, you can only disable the Host I/O Time Stamp Transfer option by resynchronizing using Host I/O Time Stamp Transfer = Disable in Device Manager - Storage Navigator.</p>			

---

## Chapter 3: Planning for TrueCopy for Mainframe

You must plan and prepare primary and secondary systems, pair volumes, data paths, and other elements to use TrueCopy for Mainframe.

### Storage system preparation

The following preparations are required for the storage systems in a TrueCopy for Mainframe pair relationship.

- Device Manager - Storage Navigator must be LAN-attached to the primary system and the secondary system. For details, see the *System Administrator Guide*.
- The primary and secondary systems must be set up for TrueCopy for Mainframe operations. For details, see [Cache and shared memory requirements \(on page 53\)](#) and [DFW requirements \(on page 53\)](#). Make sure to consider the amount of Cache Residency Manager data that will be stored in cache when determining the amount of cache for TrueCopy for Mainframe operations.
- Set the system option modes on the primary and secondary systems for your TrueCopy for Mainframe configuration. For details, contact customer support.
- Make sure that the storage system is configured to report sense information by connecting storage system and host. It is required to connect the host to both the primary and secondary systems. If dedicated host cannot be connected to secondary system, connect secondary system and host at primary site.
- On the host operating system, make sure that the missing interrupt handler (MIH) value (also called host I/O patrol time) is set high enough to accommodate the number of pairs, the cable length between the primary and secondary systems, and the initial copy pace. The recommended MIH value for TrueCopy for Mainframe operations is 60 seconds. For MVS, the MIH value is specified in the SYS1.PARMLIB file. The recommended MIH value for Compatible XRC is different than for TrueCopy for Mainframe. If you are performing TrueCopy for Mainframe and Compatible XRC operations on the same storage system at the same time, contact customer support.
- Install the data path between the primary and secondary systems. Distribute data paths between different storage clusters and extenders or switches to provide maximum flexibility and availability. The remote paths between the primary and secondary systems must be different than the remote paths between the host and secondary system. For details, see [Data path requirements and configurations \(on page 61\)](#).

## Cache and shared memory requirements

Cache must be operable for the primary and secondary systems. If not, pairs cannot be created. The secondary system cache must be configured to adequately support TrueCopy for Mainframe remote copy workloads and any local workload activity.



### Note:

Neither cache nor shared memory can be added to or removed from the storage system when pair status is COPY. When either of these tasks is to be performed, first split any pairs in COPY status, and then resynchronize the pairs when the cache or shared memory operation is completed.

## Adding and removing cache memory

Use the following workflow to add or remove cache memory in a storage system in which TCz pairs already exist:

1. Identify the status of the TCz volumes in the storage system.
2. If a TCz volume is in the Pending status, wait until the status changes to Duplex, or split the TCz pair.

Do not add or remove cache memory when any volumes are in the Pending status.

3. When the status of all volumes has been confirmed, cache memory can be added to or removed from the storage system by your service representative. Contact customer support for adding or removing cache memory.
4. After the addition or removal of cache memory is complete, resynchronize the pairs that you split in step 2.

## DFW requirements

DASD fast write (DFW) is required at the primary and secondary systems only when Required is specified for the PPRC DFW to Secondary Volume option. If DFW to an S-VOL is blocked, but the pair was established with the Required option specified, the primary system detects DFW OFF at the S-VOL and splits the pair. The default for TrueCopy for Mainframe pairs created using PPRC commands is Not Required, therefore they are not split when DFW to Secondary Volume is blocked.

The DFW to Secondary Volume setting does not affect P-VOL I/O performance. If one side of cache is closed due to a secondary system failure, the copy operation still uses DFW. The difference between not required and required is that new pairs cannot be established with the required option when one side of secondary system cache is closed. In this case, the Add Pair operation fails.

## Requirements for pairing VSP 5000 series with other storage systems

You can pair VSP 5000 series volumes with volumes in the following storage systems:

- VSP G1000
- VSP G1500 and VSP F1500
- VSP

Contact customer support for information regarding the supported microcode versions.



**Note:** When specifying the VSP 5000 series serial number using CCI, add a "5" at the beginning of the serial number. For example, if the serial number is 12345, enter 512345.

## Remote replication options

Synchronous copy operations affect the I/O performance on the host and on the primary and secondary systems. TrueCopy for Mainframe provides options for monitoring and controlling the impact of copy operations and for maximizing the efficiency and speed of copy operations to achieve the best level of backup data integrity. You can set the following remote replication options:

- [Round trip time option \(on page 54\)](#)
- [Minimum number of remote paths option \(on page 58\)](#)
- [Maximum initial copy activities option \(on page 58\)](#)
- [Blocked path monitoring option \(on page 59\)](#)
- [Blocked path SIM monitoring option \(on page 59\)](#)
- [Services SIM of remote copy option \(on page 59\)](#)
- [PPRC support CU option \(on page 59\)](#)

To optimize performance you also need to determine the proper bandwidth for your workload environment. For details, see [Analyzing workload and planning data paths \(on page 60\)](#).

### Round trip time option

When you set up the TrueCopy for Mainframe association between the primary and secondary systems, you specify a time limit in milliseconds (ms) for data to travel from the P-VOL to the S-VOL, which is called the round trip (RT) time. RT time is used to control the initial copy pace while update copy operations are in progress.

**Note:**

- If the difference between the RT time you set and the remote I/O response time is significant, the storage system slows down or can even interrupt the initial copy operation.

An example of a significant difference is 1 ms RT time and 500 ms remote I/O response time.

- If the difference between the RT time and the remote I/O response time is insignificant, initial copying is allowed to continue at the specified pace.

An example of an insignificant difference is 1 ms RT time and 5 ms remote I/O response time.

- You can adjust the RT time when the distance between the primary and secondary systems is long, or when there is a delay caused by the line equipment. There can be a delay in completing the initial copy operation if it is performed with the default RT time instead of the appropriate value.
- The default RT time is 1 ms.

RT time can be set between 1 ms and 500 ms, depending on the following scenarios:

The following equation lets you set the appropriate RT time, in ms:

*RT-time = RT-time-between-the-primary-and-secondary-storage-systems × number-of-responses + initial-copy-response-time (ms)*

If the physical path between the primary and secondary storage systems uses Fibre Channel technology, the number of responses depends on the host mode option (HMO) 51 setting.

Host mode option 51	Number of responses
OFF	2
ON	1

When HMO 51 is OFF (default), you must double the RT time because each data transfer between the primary and secondary storage systems involves two response sequences for each command issued.

When HMO 51 is ON, you do not need to double the value of the RT time, because the sequence is one response for each command issued.

If the physical path between the primary and secondary storage systems is an iSCSI, the number of response sequence is determined in proportion to the initial copy speed because the transferred data is divided into 64 KB.

Initial copy speed	Number of responses
1	6
2	10
3	14
4	18

- Use the `ping` command when setting the RT time, or contact customer support. If you do not use channel extenders between the primary and secondary systems, specify "1".
- The *initial-copy-response-time* is the response time required for multiple initial copy operations.

Use the following equation to determine the initial copy response time of the initial copy pace, the number of maximum initial copy, and the bandwidth of the channel extender communication lines between the primary and secondary systems.

Initial copy response time equation
<p><b>Notes:</b></p> <ol style="list-style-type: none"> <li>1. When you connect the primary system and secondary system without channel extenders, set the data path speed between the primary and secondary systems to one of the following values according to link speed: <ul style="list-style-type: none"> <li>▪ 4 Gbps: 0.34 MB/ms</li> <li>▪ 8 Gbps: 0.68 MB/ms</li> <li>▪ 10 Gbps: 0.85 MB/ms</li> <li>▪ 16 Gbps: 1.36 MB/ms</li> <li>▪ 32 Gbps: 2.72 MB/ms</li> </ul> </li> <li>2. For details about <i>initial-copy-pace</i>, see the next table.</li> <li>3. For <i>maximum-initial-copy-activities</i>, use the value set up per storage system. The default is 64.</li> <li>4. Even if the maximum initial copy activities or the number of <i>data-paths-between-primary-and-secondary-systems</i> is larger than 16, specify it as 16.</li> </ol>

The following table shows the initial copy pace used in the initial copy response time equation.



Interface	Initial copy only in progress	Initial, update copy in progress	
		When initial copy pace specified at the time of pair creation is 1 to 8	When initial copy pace specified at the time of pair creation is 9 to 15
Business Continuity Manager	User-specified value	User-specified value between 1 and 8	8
Device Manager - Storage Navigator	User-specified value	User-specified value between 1 and 8	8
PPRC command (TSO/ICKDSF) and CU emulation is I-2107	15*	8*	

\* When a PPRC command (TSO/ICKDSF) is used and the CU emulation type is I-2107, the initial copy pace specified is invalid. Therefore, the fixed value will be set.

The following table shows examples for RT time settings for multiple initial copy operations.

Round trip time between primary and secondary system (ms)	Data path speed between primary and secondary systems (MB/ms)	Number of data paths between primary and secondary systems	Initial copy pace	Maximum initial copy activities	Round trip time specified (ms)
0	0.1	4	15	64	160
30	0.1	4	15	64	220
100	0.1	4	15	64	360

## Minimum number of remote paths option

When you set up the TCz association between the primary and secondary systems, you specify the minimum number of remote paths to the secondary system using the Minimum Number of Paths option (range = 1-8, default = 1). If the number of remote paths in Normal status drops below the specified minimum, the primary storage system splits the pairs to prevent remote copy operations from impacting host performance in the primary storage system.

- To maintain host performance in the primary storage system, set the minimum number of remote paths to at least 2 to ensure that remote copy operations are performed only when multiple paths are available.
- To continue remote copy operations even when there is only one remote path in Normal status, set the minimum number of remote paths to 1. Use this setting only when keeping pairs synchronized is more important than maintaining high performance in the primary storage system.



**Note:** You can use the fence level option to keep a P-VOL and S-VOL synchronized even if the pair is split because the number of remote paths drops below the minimum setting. The fence level setting, which you specify when you create a pair, determines whether the P-VOL continues to accept write I/Os after the pair is split due to an error. For details, see [Allowing I/O to the P-VOL after a split: Fence Level options \(on page 72\)](#).

## Maximum initial copy activities option

TCz initial copy activities can impact the performance of the primary site, depending on the amount of I/O activity and the number of pairs being created at the same time. The maximum initial copy activities option allows you to specify the maximum number of concurrent initial copy operations that the storage system can perform. For example, when the maximum initial copy activities is set to 64 and you add 65 TCz pairs at the same time, the primary system starts the first 64 pairs and will not start the 65th pair until one of the first 64 pairs is synchronized.

You can also enable or disable the CU option for the maximum initial copy activities setting. If the CU option is enabled, you can specify the maximum concurrent initial copy operations for each CU (range = 1-16, default = 4), and if it is disabled, you cannot specify the setting separately for each CU. If the CU option is enabled and you set a value larger than the system setting for maximum initial copy activities for a CU, the system setting for maximum initial copy activities is observed.

The default maximum initial copy activities setting is 64 volumes. You can set a number from 1 to 512. If the maximum initial copy activities setting is too large, pending processes in the secondary site can increase, and this can impact the remote I/O response time to the update I/Os. You can change this setting using the Edit Remote Replica Options window. For instructions, see [Setting the remote replication options \(on page 115\)](#).

## Blocked path monitoring option

The blocked path monitoring setting allows you to specify the time (in seconds) for the system to monitor blocked paths. The range is from 2 to 45 seconds. The default is 40 seconds.

If all paths become monitored because of a path error, an MIH might occur in the host. Therefore, the time you specify must be less than the host's MIH timer setting.

If iSCSI is used in a remote path, the blocked path monitoring option must be set to at least 40 seconds (default). If blocked path monitoring is less than 40 seconds, the path might be blocked due to a delay in the network such as many switches in a spanning tree protocol (STP) network or a long distance connection.

## Blocked path SIM monitoring option

The blocked path SIM monitoring setting allows you to specify the time (in seconds) for the system to monitor SIMs reported for blocked paths. The range is from 2 to 100 seconds. The default is 70 seconds.

The blocked path SIM monitoring setting must be larger than the blocked path monitoring setting.

## Services SIM of remote copy option

The services SIM of remote copy option allows you to specify whether services SIMs are reported to the host. During TCz operations, the primary and secondary storage systems generate a service SIM each time the pair status of the P-VOL or S-VOL changes for any reason, including normal status transitions (for example, when a newly created pair becomes synchronized). SIMs generated by the primary storage system include the P-VOL device ID (byte 13), and SIMs generated by the secondary storage system include the S-VOL device ID (byte 13).

If you enable the services SIM of remote copy option for the storage system, all CUs will report services SIMs to the host. If desired, you can enable this option at the CU level to configure specific CUs to report services SIMs to the host.

## PPRC support CU option

The PPRC support CU option allows you to specify whether the CU will generate sense information that is compatible with PPRC. This option is extremely important for TCz disaster recovery planning and must be set for each CU.

- If the host does not support PPRC, select No to configure the CU to report SIMs. The default is No.
- If the host system supports PPRC, select Yes to configure the CU to generate PPRC-compatible sense information when a TCz pair is suspended instead of a SIM. You must select Yes for each CU in the primary and secondary storage systems. If Yes is selected, the MCU will still report moderate- and serious-level SIMs, as well as DF40 and DF48 device SIMs. If you plan to utilize the CGROUP (FREEZE/RUN) command for TCz pairs, you must select Yes.

When you change the PPRC support option for the P-VOL, you do not need to split and resync the pair. When you change the PPRC support option for the S-VOL, you need to change the option in the primary storage system and then split and resync the pair.

When a pair is split, whether user requested or due to failure, the primary system generates sense information to notify the hosts. If the host system supports PPRC and the PPRC support CU option is enabled, this notification results in an IEA494I and/or IEA491E system console message, which indicates the reason for suspension.

## Analyzing workload and planning data paths

You can optimize copy operations and system performance by carefully planning bandwidth, number of data paths, number of host interface paths, and number of ports. Check with customer support for more information.

- Analyze write-workload. You need to collect workload data (MB/s and IOPS) and analyze your workload to determine the following parameters:
  - Amount of bandwidth
  - Number of data paths
  - Number of host interface paths
  - Number of ports used for TrueCopy for Mainframe operations on the primary and secondary systems

Thorough analysis and careful planning of these key parameters can enable your system to operate free of bottlenecks under all workload conditions.

- If you are setting up TrueCopy for Mainframe for disaster recovery, make sure that secondary systems are attached to a host server to enable both the reporting of sense information and the transfer of host failover information. If the secondary site is unattended by a host, you must attach the secondary storage systems to a host server at the primary site so that the system administrator can monitor conditions at the secondary site.

The following table lists conditions that affect storage system performance and provides recommendations for addressing the conditions.

Condition	Description	Recommendation
Write-intensive workloads	Write-intensive workloads, such as database logging volumes, can have a significant impact on storage system I/O response times.	Spread write-intensive data across several volumes to minimize queuing.
Large block size	Workloads with large write block sizes, such as DB deferred writes, can impact performance.	Spread workloads with large write block sizes across several volumes.

Condition	Description	Recommendation
High host channel demand	The demand on the primary system host channels can affect performance.	Spread the workload across several storage systems to use additional channels.
Sequential write operations	TrueCopy for Mainframe operations can have a negative impact on workloads with a high percentage of sequential write operations, such as batch processing operations (for example, dump/restore, sort operations).	Avoid performing restore operations to volumes that belong to TrueCopy for Mainframe pairs. Instead, restore data to a scratch volume, and then create the TrueCopy for Mainframe pair.
Cache size	Large cache size improves read performance, which allows more storage system resources to be devoted to write operations. Insufficient cache resources result in command retries, state-change-pending (SCP) notifications, and puncture conditions.	Consider increasing the cache size of the TrueCopy for Mainframe storage systems to improve overall performance. For best results, the cache and NVS capacity of the primary and secondary systems should be the same. This allows the secondary site to function adequately during disaster recovery.
Remote system performance	The secondary system's performance directly affects the performance of the primary system. If a secondary system becomes overloaded with heavy update activity, host and primary system performance can also be degraded.	Distribute TrueCopy for Mainframe remote copy operations among several secondary systems to avoid overloading any one system.
Data paths	An inadequate number of data paths decreases performance. Performing copy operations over long distances also degrades performance.	Install a sufficient number of data paths to meet all write-workload levels. This is especially important for systems containing both P-VOLs and S-VOLs.

## Data path requirements and configurations

A data path must be designed to adequately manage all possible amounts of data that could be generated by the host and sent to the P-VOL and S-VOL. This topic provides requirements and planning considerations for the following key elements of the data path:

- [Bandwidth requirements \(on page 62\)](#)
- [Fibre Channel requirements \(on page 62\)](#)

- [Supported data path configurations for Fibre Channel \(on page 63\)](#)
- [Ports \(on page 66\)](#)

**Note:**

- Create at least two independent data paths (one per cluster) between the primary and secondary systems for hardware redundancy for this critical element.
- When creating more than 4,000 pairs, restrict the number of pairs so that a maximum of 4,000 pairs use one physical path to distribute the loads on the physical paths.
- When you set up secondary-to-primary data paths, specify the same path group ID as specified for the primary-to-secondary paths.
- You can reverse the primary-to-secondary data path to the secondary-to-primary direction using the PPRC TSO CESTPATH and CDELPATH commands.

## Bandwidth requirements

Sufficient bandwidth must be present to handle data transfer of all workload levels. The amount of bandwidth required for your TrueCopy for Mainframe system is based on the amount of I/O sent from the host to the primary system. You determine required bandwidth by measuring write-workload. Workload data is collected using performance monitoring software. Consult customer support for more information.

## Fibre Channel requirements

The primary and secondary systems must be connected using multimode or single-mode optical fibre cables. As shown in the following table, the cables and data path relay equipment required depend on the distance between the P-VOL and S-VOL storage systems.

Distance	Fibre cable type	Data path relay equipment
0 km to 1.5 km (4,920 feet)	Multimode shortwave Fibre Channel interface cables.	Switch is required for 0.5 km to 1.5 km.
1.5 km to 10 km (4,920 feet to 6.2 miles)	Single-mode longwave <sup>2</sup> optical fibre cables.	Not required.
10 km to 30 km (6.2 miles to 18.6 miles)	Single-mode longwave <sup>2</sup> Fibre Channel interface cables.	Switch is required.
Greater than 30 km (18.6 miles) <sup>1</sup>	Communications lines are required.	Approved third-party channel extender products. <sup>3</sup>
<b>Notes:</b>		

Distance	Fibre cable type	Data path relay equipment
<ol style="list-style-type: none"> <li>1. TrueCopy for Mainframe operations typically do not exceed 30 km.</li> <li>2. Longwave cannot be used for FCoE.</li> <li>3. For more information about approved channel extenders, contact Hitachi Vantara.</li> </ol>		

With Fibre Channel connections using switches, no special settings are required for the physical storage system.

Direct connections up to 10 km with single-mode longwave Fibre Channel interface cables are supported. Link speed determines the maximum distance you can transfer data and still achieve good performance. The following table shows maximum distances at which performance is maintained per link speed, over single-mode longwave Fibre Channel.

Link speed	Distance maximum performance maintained
4 Gbps	3 km
8 Gbps	2 km
16 Gbps	1 km
32 Gbps	0.6 km

Customer support can provide the latest information about the availability of serial-channel TrueCopy for Mainframe connections.

## Supported data path configurations for Fibre Channel

Three Fibre Channel configurations are supported for TrueCopy for Mainframe:

- [Direct connection \(on page 63\)](#)
- [Switch connection \(on page 64\)](#)
- [Extender connection \(on page 65\)](#)

For direct and switch connections, host I/O response time can be improved on long distance connections (longwave, up to 10 km for direct connection and 100 km for switch connection) by improving the I/O response time between storage systems and by using host mode option 51, the Round Trip Set Up option. The firmware supporting this function must be installed on both the primary and secondary systems.

A Hitachi Vantara-approved channel extender is required.

### Direct connection

The following figure shows a direct connection, in which two devices are connected directly together.

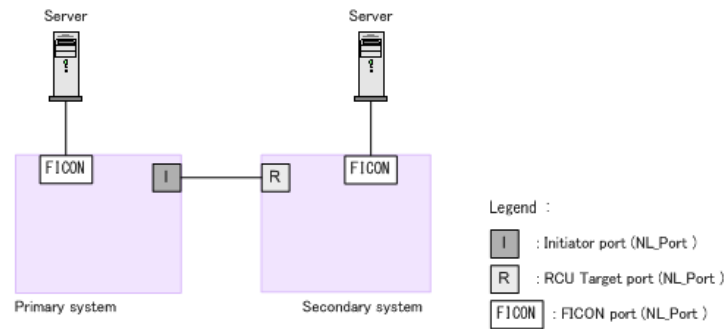

As shown in the following table, Fab settings, topology settings, and available link speed depend on the settings of the packages and protocols used for the storage system connections, as well as whether the host mode option 51 is used. Host Mode Option 51 (Round Trip Set Up) improves host I/O response time for long distance (10 km) switch connections.

**Note:** If you connect storage systems using iSCSI, host mode option settings become invalid.

Package name	Protocol	Host mode option 51	Fab	Bidirectional port topology	Available link speed
CHB(FC32G )	32GbpsFC	OFF	OFF	FC-AL	<ul style="list-style-type: none"> <li>▪ 4 Gbps</li> <li>▪ 8 Gbps</li> </ul>
		ON	OFF	FC-AL	<ul style="list-style-type: none"> <li>▪ 4 Gbps</li> <li>▪ 8 Gbps</li> </ul>
		OFF	OFF	Point-to-Point	<ul style="list-style-type: none"> <li>▪ 16 Gbps</li> <li>▪ 32 Gbps</li> </ul>
		ON	OFF	Point-to-Point	<ul style="list-style-type: none"> <li>▪ 16 Gbps</li> <li>▪ 32 Gbps</li> </ul>

## Switch connection

The following figure shows a switch connection.



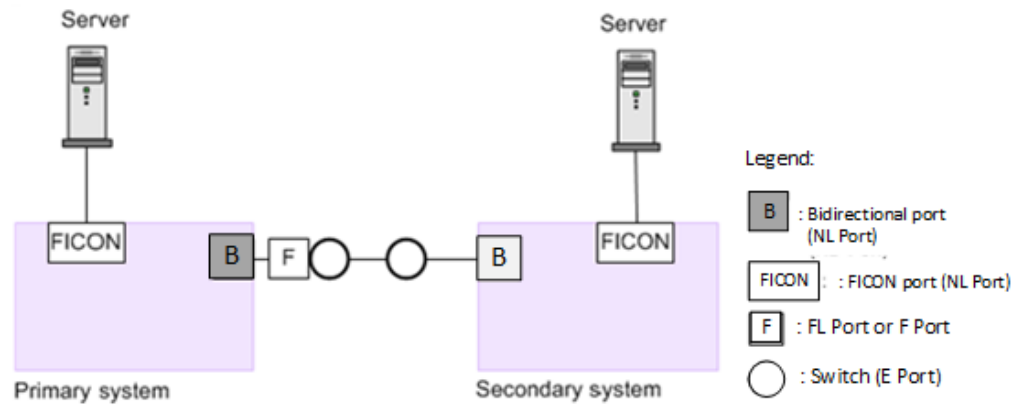

Some switch vendors require F port connectivity (for example, McData ED5000).

As shown in the following table, Fab settings, topology settings, and available link speed depend on the settings of the packages and protocols used for the storage system connections, as well as whether the host mode option 51 is used.

For details about HMOs, see the *Provisioning Guide* for the storage system.

Package name	Protocol	HMO 51 setting	Fabric setting	Topology: Initiator and RCU Target	Link speed that can be specified
CHB(FC32G )	32GbpsFC	OFF	ON	Point-to-Point	<ul style="list-style-type: none"> <li>▪ 4 Gbps</li> <li>▪ 8 Gbps</li> <li>▪ 16 Gbps</li> <li>▪ 32 Gbps</li> </ul>

**⚠ Caution:** HMO51 should only be used with configurations more than 1 km in distance. If HMO51 is set with a distance of less than 1 km, a data transfer error might occur on the secondary system.

## Extender connection

The following figure shows an extender connection, in which channel extenders and switches are used to connect the devices across large distances. Host Mode Option 51 (Round Trip Set Up) improves host I/O response time for long distance (100 km) switch connections. Make sure that the extender supports remote I/O. For more information contact customer support.

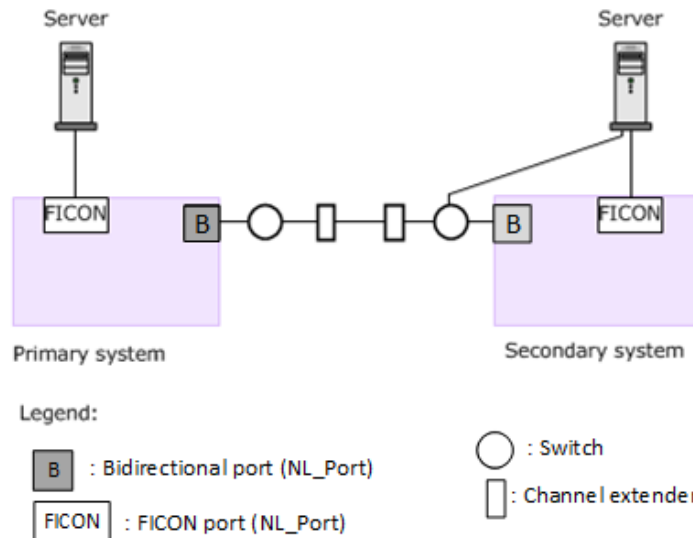

Set the Fabric to ON for the bidirectional port, and then set the topology to Point-to-Point.



**Caution:** Data traffic might concentrate on one switch when you perform the following actions:

- Use a switch to connect the primary system and the secondary systems with an extender
- Gather several remote copy paths in one location

If you are using a Hitachi switch to make the connection, contact customer support.

## Fibre Channel used as remote paths

Before configuring a system using Fibre Channel, there are restrictions that you need to consider.

For details about Fibre Channel, see the *Provisioning Guide* for your system.

- When you use Fibre Channel as a remote path, if you specify Auto for Port Speed, specify 10 seconds or more for Blocked Path Monitoring. If you want to specify 9 seconds or less, do not set Auto for Port Speed.
- If the time specified for Blocked Path Monitoring is not long enough, the network speed might be slowed down or the period for speed negotiation might be exceeded. As a result, paths might be blocked.

## Ports

Data is transferred along the data path from the bidirectional ports on the primary storage system to the bidirectional ports on the secondary storage systems. The amount of data each of these ports can transfer is limited.

Therefore, you must know the amount of data that will be transferred (that is, the write-workload) during peak periods. You can then ensure that bandwidth meets data transfer requirements, that the primary storage system has a sufficient number of bidirectional ports, and that the secondary storage system has a sufficient number of bidirectional ports to handle peak workload levels.

## Port requirements

Data is sent from the primary storage system port through the data path to the port on the secondary storage system. The reverse is also available.

- One secondary system port can be connected to a maximum of 16 ports on a primary system.
- The number of remote paths that can be specified does not depend on the number of ports configured for TrueCopy for Mainframe. You can specify the number of remote paths for each remote connection.
- The storage system automatically configures a Fibre Channel port as an initiator port or RCU target port in response to the TSO CESTPATH and CDELPATH commands. For details, contact customer support.
- Do not run the CESTPATH or CDELPATH command to configure a Fibre Channel port at the same time that the SCSI path definition function is in use.

## Port attributes

Plan and define the following Fibre Channel port attributes for TrueCopy for Mainframe:

- **Target port:** Connects the storage system and a host. When the host issues a write request, the request is sent to a volume on the system through a target port on the storage system.
- **Bidirectional port:** Connects the remote copy and external storage systems as a Initiator port or a Target port. This port has the following three kinds of port attributes. The host server connections can be shared through the port set as Bidirectional, however this is not recommend for improving performance.
  - Initiator ports, which send data. One initiator port can be connected to a maximum of 64 RCU target ports. Configure initiator ports on both the primary and secondary systems for TrueCopy for Mainframe disaster recovery operations.
  - RCU target ports, which receive data. Configure RCU target ports on both the primary and secondary systems for TrueCopy for Mainframe disaster recovery operations.
  - External port: Required for Universal Volume Manager copy operations. This port is not used for TrueCopy for Mainframe copy operations.

## Swapping between P-VOL and S-VOL in a CESTPATH/CDELPATH command

You can swap between P-VOL and S-VOL using TrueCopy for Mainframe PPRC CESTPATH and CDELPATH commands.

When a CESTPATH TSO command is issued, if HOST logical path does not exist, a logical path of TrueCopy for Mainframe is established. If a CDELPATH TSO command is issued, a logical path of TrueCopy for Mainframe is deleted.

Do not use the CESTPATH command, the CDELPATH command, and the SCSI path definition function of LUN Manager at the same time for the Fiber Channel interface. Also, before using the CESTPATH command and the CDELPATH command, set the target Fiber Channel port to the bidirectional port.

### Procedure

1. Set the attribute of the port used for remote connection to Bidirectional.
2. Issue a CESTPATH TSO command to the storage system at the primary site.  
A remote connection from the primary site to the secondary site is created.
3. Issue a FREEZE command to the storage system at the primary site.
4. Issue a CDELPATH TSO command to the storage system at the primary site.
5. Issue a CESTPATH TSO command to the storage system at the secondary site.  
A remote connection from the secondary site to the primary site is created.

## Pair and pair volumes planning

Before you create pairs and pair volumes, you should understand requirements, options, and settings that you need.

### Pair volume requirements and recommendations

The following is provided to help you prepare TrueCopy for Mainframe volumes:

- A volume can be assigned to only one pair.
- Volumes on the primary and secondary storage systems must be defined and formatted prior to pairing.
- The S-VOL must be equal-to or larger-than the P-VOL. However, if the S-VOL is larger than the P-VOL, the swap operation cannot be performed.
- TrueCopy for Mainframe requires a one-to-one relationship between the P-VOL and S-VOL. The P-VOL cannot be copied to more than one S-VOL, and an S-VOL cannot have more than one P-VOL.

- Logical Volume Images (LVIs)
  - All basic mainframe LVIs that can be configured on the storage system (for example, 3390-3, -9, -L) are supported for TrueCopy for Mainframe.
  - Multiplatform volumes (3390-3A/B/C) are not supported.
  - Data can be copied between volumes with the same emulation and capacity (for example, 3390-3R to 3390-3R).
  - Data can be copied from smaller volumes to larger volumes (for example, 3390-3 to 3390-9) of the same emulation (VTOC expansion must be used).

However, Hitachi Vantara strongly recommends that you limit copying from a smaller volume to a larger volume to data migration purposes and not disaster recovery. Under the disaster recovery scenario, you would not be able to perform TrueCopy for Mainframe operations in the reverse direction, from the secondary system to the primary system, because a larger volume cannot be copied to a smaller volume.

Also, with larger-to-smaller volumes, if the BCM SUSPEND command is issued, you cannot use the secondary system R/W option and Reverse option.

- Pair volumes have the following disk track format requirements. TrueCopy for Mainframe cannot detect exceptions to these requirements. The primary system will abort the initial copy operation if the track format for both the P-VOL and S-VOL does not meet the following requirements:
  - The P-VOL and S-VOL must have the same track format.
  - Record zero (R0) must be standard format, with key length of zero and data length of eight. The primary system will abort the initial copy operation if R0 is not standard format.
  - The CCHH (logical cylinder address and logical head address) of R0 must be identical to the physical cylinder address and physical head address of the track.
  - The CCHH of each user record in a track must be unique.
- TrueCopy for Mainframe operates on volumes rather than on datasets. Multi-volume datasets require special attention. For complete duplication and recovery of a multi-volume dataset (for example, a large database file that spans several volumes), make sure that all volumes of the file are copied to TrueCopy for Mainframe S-VOLs.
- TrueCopy for Mainframe pair volumes can be shared with non-TrueCopy for Mainframe Hitachi software products. For details, see [Sharing TrueCopy for Mainframe volumes \(on page 94\)](#).

- TrueCopy for Mainframe supports Virtual LVI. This allows you to configure LVIs that are smaller than fixed-size LVIs. When custom-size LVIs are assigned to a TrueCopy for Mainframe pair, the P-VOL size must be smaller than or equal to the S-VOL size.
- Before creating multiple pairs during the Create Pairs operation, make sure to set up S-VOL LDEVs to allow the system to correctly match them to P-VOLs.

In HDvM - SN, even though you select multiple volumes as P-VOLs, you specify just one S-VOL. The system automatically assigns subsequent secondary system LDEVs as S-VOLs based on the option you specify for Selection Type. These are the options:

- Interval: The interval you specify will be skipped between LDEV numbers in the secondary system.

For example, suppose you specify LDEV 01 as the initial (base) S-VOL, and specify 3 for Interval. This results in secondary system LDEV 04 being assigned to the next P-VOL, 07 assigned to the subsequent P-VOL, and so on. To use Interval, you set up secondary system LDEV numbers according to the interval between them.

- Relative Primary Volume. The difference is calculated between the LDEV numbers of two successive P-VOLs. S-VOLs are assigned according to the closest LDEV number.

For example, if the LDEV numbers of three P-VOLs are 01, 05, and 06 and you set LDEV numbers for the initial S-VOL (Base Secondary Volume) at 02, the LDEV numbers of the three S-VOLs will be set at 02, 06, and 07, respectively.

## Precautions for duplicate VOLSERS

For the TrueCopy for Mainframe initial copy operation, P-VOL VOLSER (Volume Serial Number) is also copied to the S-VOL when Entire Volume is selected for the Initial Copy Type. Therefore, the P-VOL and S-VOL have the same VOLSER. Because the host operating system does not allow duplicate VOLSERS, the host system administrator must take precautions to prevent system problems related to duplicate VOLSERS (such as defining S-VOLs not to come online automatically).

If the volumes that become S-VOLs are physically attached to the same system images as the volumes that become the P-VOLs, the following possible error conditions can occur:

- If the secondary system is online when a pair is established using the TSO CESTPAIR command (allowed by PPRC, not allowed by TCz), a duplex secondary could be online to a host image. The results of this situation are not predictable.
- When a pair is released, the previous S-VOL is usually offline. Then, when a host system is IPL'd (initial program loaded), the operator is offered both volumes and asked which volume should be left offline. You can avoid duplication of the VOLSER as follows:
  1. Identify the volumes that are not accessed by the host system.
  2. Perform CHP OFF or some other operation to ensure that the volumes are inaccessible.
  3. When performing IPL, make sure to perform LOAD CLEAR.

To avoid these possible error conditions:

- Hitachi Vantara strongly recommends that you specify OFFLINE=YES if the secondary volumes are to be generated in the production host's IOCP and system generation.
- If you cannot create a pair because the S-VOL is online with hosts, all paths must be offline from all hosts. If you cannot identify the hosts that are online, contact customer support. You can obtain the information about online paths from SSBLOG of the SVP.

## Allowing I/O to the S-VOL

By specifying the Read option for the S-VOL, you can read the S-VOL from the host while the pair is split without deleting the pair from the secondary storage system. Differential data is managed using bitmaps by track and is used when the pair is resynchronized.

- The S-VOL read and VOLSER write option (mode 20), and the S-VOL read and VTOC write option (mode 190) must be enabled by customer support.
- When you read an S-VOL from the host, the reference date in the VTOC might be updated. In this case, you must permit update of the VTOC by enabling the mode 190.
- The CSUSPEND command to the S-VOL of a split pair will be rejected when the S-VOL read option is enabled, for I-2107 controller emulation.
- If system mode 20 is enabled, the VOLSER of the split S-VOL can be changed, which allows the S-VOL to be online to the same host as the P-VOL while the pair is split. All other write I/Os to the S-VOL are rejected. The primary system copies the P-VOL VOLSER to the S-VOL when the pair is resynchronized.
- For write-access to an S-VOL, release the pairs, or enable the write option and then split the pairs.

## Allowing I/O to the P-VOL after a split: Fence Level options

You can specify whether the host is denied access or continues to access the P-VOL when the pair is split due to an error. This is done with the Primary Volume Fence Level setting. You specify one of the following Fence Level options during the initial copy and resync operations. You can also change the Fence Level option outside these operations.

- **Data** – the P-VOL is fenced if an update copy operation fails. This prevents the host from writing to the P-VOL during a failure. This setting should be considered for the most critical volumes for disaster recovery. This setting reduces the amount of time required to analyze the consistency of S-VOL data with the P-VOL during disaster recovery efforts.

This setting is functionally equivalent to the **CRIT (YES-ALL)** parameter for the **CESTPAIR** command.

- **Status** – the P-VOL is fenced only if the primary system is not able to change S-VOL status to Suspend when an update copy operation fails. If the primary system successfully changes S-VOL pair status to Suspend, subsequent write I/O operations to the P-VOL will be accepted, and the system will keep track of updates to the P-VOL. This allows the pair to be resynchronized quickly. This setting also reduces the amount of time required to analyze S-VOL consistency during disaster recovery.

This setting is functionally equivalent to the **CRIT (YES PATHS)** parameter for the **CESTPAIR** command.

- **Never** – the P-VOL is never fenced. This setting should be used when I/O performance outweighs data recovery. "Never" ensures that the P-VOL remains available to applications for updates, even if all TrueCopy for Mainframe copy operations have failed. The S-VOL might no longer be in sync with the P-VOL, but the primary system keeps track of updates to the P-VOL while the pair is suspended. Host failover capability is essential if this fence level setting is used. For disaster recovery, the consistency of the S-VOL is determined by using the sense information transferred by host failover or by comparing the S-VOL contents with other files confirmed to be consistent.

This setting is functionally equivalent to the **CRIT (NO)** parameter for the **CESTPAIR** command.

## Differential data

Differential data is managed with bitmaps in units of tracks. Tracks that receive a write instruction while a pair is being split are managed as differential bitmaps.

With storage systems, data is stored in units of tracks using bitmaps, and is then used to resynchronize the pair.

- If your primary system is other than VSP G1x00, and VSP F1500, and the secondary system is VSP G1x00, or VSP F1500, specify track as the differential data management unit in the primary system. VSP 5000 series support only tracks. Therefore, if you specify cylinders, TCz pairs cannot be created.
- When you use Business Continuity Manager, you can specify track or cylinder as the differential data management unit. Only track will be used because VSP 5000 series storage systems support only track as the differential data management unit.



- If you use CCI, you cannot specify the differential data management unit. Track will be used.
- If you are making a TCz pair with a DP-VOL whose volume capacity is larger than 262,668 cylinders, the differential data is managed by control cylinder information written in pages that are assigned in the TCz pair volume. In this case, one page of pool capacity for differential management data is required for each increment of 4,096 cylinders.

When pages are not assigned to the TCz pair volume, pages for recording control cylinder information might be created during the creation of TCz pairs. However, if the pages have been assigned for all of the area in the volume, it is not required to add pool capacity for managing differential data since the page format for control cylinder information and for user data is the same. The control cylinder information for TCz, Slz, URz, and Compatible FlashCopy® are recorded in the same pages.

- After creating a TCz pair with DP-VOL whose volume capacity is larger than 262,668 cylinders, data management might fail due to insufficient P-VOL or S-VOL pool capacity. In this case, all the P-VOL data is copied to the S-VOL in units of tracks when performing the TCz pair resync operation. You can prevent the failure if your pool has more than 1 page (672 tracks) of physical capacity for every 4096 cylinders of user capacity.

## Maximum number of pairs supported

TrueCopy supports a maximum of 65,280 pairs. If Command Control Interface is used, a command device must be defined for each product and the maximum number of pairs is calculated by subtracting 1 from the maximum number of pairs shown in the specification.

## Calculating the maximum number of pairs

It is necessary to calculate the maximum number of pairs you can have on the storage system. The maximum number is based on the following:

- The number of cylinders in the volumes, which must be calculated.
- The number of bitmap areas required for a TrueCopy for Mainframe volume, which is calculated using the number of cylinders.

The bitmap area is not be used for DP-VOLs with volume capacity larger than 262,668 cylinders. Therefore, if you are creating TCz pairs using DP-VOLs with volume capacity larger than 262,668 cylinders, you do not need to calculate the maximum number of pairs for the storage system.



**Note:** In the following formulas: for `ceil()`, round up the result within the parentheses to the nearest integer, and for `floor()`, round down the result within the parentheses to the nearest integer.

### Procedure

1. Calculate the number of cylinders.
  - a. Calculate the system's number of logical blocks.

`Number of logical blocks = Volume capacity (bytes) / 512`

- b. Calculate the number of cylinders.

For 3390:

```
Number of cylinders = ceil ( (ceil (Number of logical
blocks / 116) ) / 15)
```

2. Calculate the number of bitmap areas per volume.

In the following calculation, differential data is measured in bits. 122,752 bits is the amount of differential data per bitmap area.

```
Number of bitmap areas = ceil ( (Number of cylinders × 15) /
122,752)
```



**Note:**

Performing this calculation for multiple volumes can result in inaccuracies. Perform the calculation for each volume separately, and then total the bitmap areas. The following examples show correct and incorrect calculations. Two volumes are used: one volume of 10,017 cylinders, and another volume of 32,760 cylinders

**Correct calculation**

```
ceil ((10,017 × 15) / 122,752) = 2
```

```
ceil ((32,760 × 15) / 122,752) = 5
```

**Total: 7**

**Incorrect calculation**

```
10,017 + 32,760 = 42,777 cylinders
```

```
ceil ((42,777 × 15) / 122,752) = 6
```

**Total: 6**

3. Calculate the maximum number of pairs, which is restricted by the following:

- The number of bitmap areas required for TrueCopy for Mainframe (calculated above).
- The total number of bitmap areas in the storage system. The number of bitmap areas is 65,536.

Bitmap areas are also used by TrueCopy for Mainframe, Universal Replicator, Universal Replicator for Mainframe, and global-active device.

Therefore, when you use these software applications together, reduce the number of bitmap areas for each software application from the total number of bitmap areas for the storage system before calculating the maximum number of pairs for TrueCopy for Mainframe in the following formula.

Also, when TrueCopy for Mainframe and Universal Replicator, Universal Replicator for Mainframe share the same volume, regardless of whether the shared volume is primary or secondary, reduce the number of bitmap areas for each software application from the total number of bitmap areas for the storage system before calculating the maximum number of pairs for TrueCopy for Mainframe in the following formula. For more information on calculating the number of bitmap areas required for each software application, see the relevant user guide.

Use the following formula:

Maximum number of pairs = floor (Total number of bitmap areas in the storage system / Required number of bitmap areas)

If the calculated maximum number of pairs exceeds the total number of LDEVs of the storage system, and the total number of LDEVs of the storage system is less than 65,280, then the total number of LDEVs of the storage system becomes the maximum number of pairs.

## Initial copy priority option and scheduling order

When you create more pairs than the maximum initial copy activities, you can control the order in which the initial copy operations are performed using the Initial Copy Priority option.

The following two examples illustrate how to use the Initial Copy Priority option.



**Note:** The Initial Copy Priority option can be specified only by using HDVM - SN. When you create pairs using CCI, PPRC, or BCM, the initial copy operations are performed according to the order in which the commands are issued.

### Example 1: Creating more pairs than the Maximum Initial Copy Activities setting

In this example, you are creating four pairs at the same time, and the Maximum Initial Copy Activities option is set to 2. To control the order in which the pairs are created, you set the Initial Copy Priority option in the Create TC Pairs window as shown in the following table.

P-VOL	Initial Copy Priority setting
LDEV 00	2
LDEV 01	3
LDEV 02	1
LDEV 03	4

The following table shows the order in which the initial copy operations are performed and the Initial Copy Priority settings for the P-VOLs.

Order of the initial copy operations	P-VOL	Initial Copy Priority setting
1	LDEV 02	1
2	LDEV 00	2
3	LDEV 01	3
4	LDEV 03	4

Because the Maximum Initial Copy Activities setting is 2, the initial copy operations for LDEV 02 and LDEV 00 are started at the same time. When one of these initial copy operations is completed, the initial copy operation for LDEV 01 is started. When the next initial copy operation is completed, the initial copy operation for LDEV 03 is started.

**Example 2: New pairs added with initial copy operations in progress**

In this example, you have already started the initial copy operations for the four pairs shown above (LDEVs 00-03) with the Maximum Initial Copy Activities option set to 2, and then you create two more pairs (LDEVs 10 and 11) while the initial copy operations for the first four pairs are still in progress. To control the order in which the pairs are created, you set the Initial Copy Priority option for the new pairs as shown in the following table.

P-VOL	Initial Copy Priority setting
LDEV 10	2
LDEV 11	1

The two new initial copy operations are started after all four of the previously scheduled initial copy operations are completed. The following table shows the order in which the initial copy operations are performed for all six pairs and the Initial Copy Priority setting for each pair.

Order of the initial copy operations	P-VOL	Initial Copy Priority setting	Remarks
1	LDEV 02	1	Previously scheduled.
2	LDEV 00	2	Previously scheduled.
3	LDEV 01	3	Previously scheduled.
4	LDEV 03	4	Previously scheduled.
5	LDEV 11	1	Scheduled later.
6	LDEV 10	2	Scheduled later.

**Restrictions when creating an LU whose LU number is 2048 or greater**

A pair can be created using LUs whose LU numbers are 2048 to 4095 if you connect VSP 5000 series, whose DKCMAIN program version is 90-02-0x-xx/xx or later, as the source storage system.

Do not try to create a pair using LUs whose LU numbers are 2048 to 4095 unless the storage system to which you are connecting is also VSP 5000 series, whose DKCMAIN program version is 90-02-0x-xx/xx or later. Failures, such as Pair Suspend, might occur if you try to create a pair using LUs whose LU numbers are 2048 or greater and the storage system to which you are connecting is one of the following:

- A storage system other than a VSP 5000 series
- A VSP 5000 series whose DKCMAIN program version is earlier than 90-02-0x-xx/xx.

For VSP 5000 series whose DKCMAIN program version is 90-02-0x-xx/xx or later, up to 4096 LU paths are possible for a Fibre Channel port or iSCSI port.

- If you set a host group for a Fibre Channel port, up to 4096 LU paths can be set for a host group. In addition, up to 4096 LU paths can be set for a port through the host group.
- If you configure an iSCSI target for an iSCSI port, you can configure up to 4096 LU paths for an iSCSI target. In addition, up to 4096 LU paths can be set for a port through the iSCSI target.

The following table lists LU numbers that can be used when different source storage systems and DKCMAIN program versions are connected to VSP 5000 series, whose DKCMAIN program version is 90-02-0x-xx/xx or later.

Connecting target storage system	Connecting source storage system		Restrictions	
	Storage system	Program version of DKCMAIN	LU number that can create a pair	Number of LU paths that can be set for a port
VSP 5000 series (90-02-0x-xx/xx or later)	VSP G1x00, VSP F1500	Earlier than 80-06-7x-xx/xx	Disabled	Disabled
		80-06-7x-xx/xx or later	0 to 2047	0 to 2048
	VSP 5000 series	Earlier than 90-02-0x-xx/xx	0 to 2047	0 to 2048
		90-02-0x-xx/xx or later	0 to 4095	0 to 4096

## Consistency group planning

You determine which storage system pairs to include in each consistency group based on business criteria for keeping the status consistent across a group of pairs, and for performing specific operations at the same time on all pairs in the group.

Consistency groups allow you to perform one operation on all pairs in the group at the same time. Consistency groups also ensure that all pairs are managed in a consistent status.

A consistency group has the following characteristics:

- A maximum of four storage system pairings can be placed in one consistency group.
- A consistency group can consist of the following:
  - TCz pairs only using one primary and one secondary storage system
  - TCz pairs only using more than one primary and secondary storage system
  - Both TC and TCz pairs using one primary and one secondary storage system
  - Both TC and TCz pairs using more than one primary and secondary storage system

## Consistency group for pairs in one primary and one secondary storage system

You can create, update, and copy TCz pairs or both TC pairs and TCz pairs in a consistency group of one primary storage system and one secondary storage system.

TC and TCz pairs between one primary system and secondary system can be placed in the same consistency group, as shown in the following figure.

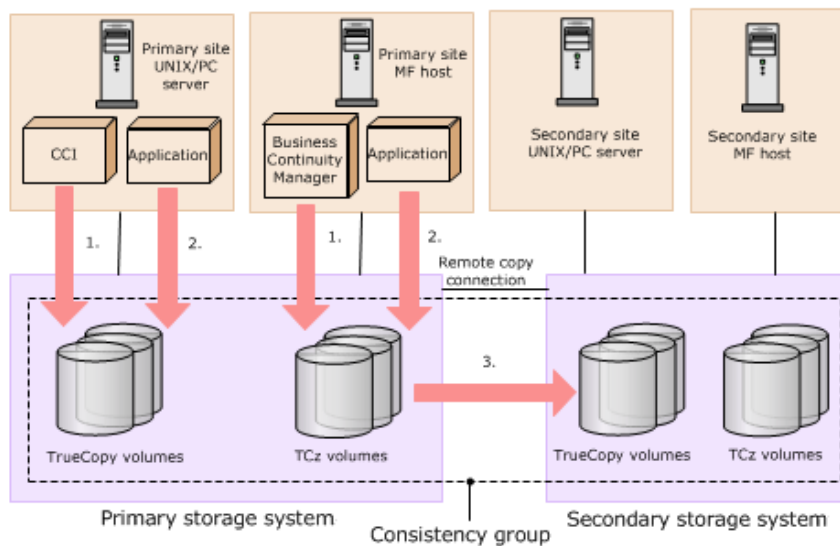

Figure notes:

1. TC pairs are assigned to a consistency group using CCI.  
TCz pairs are assigned to a consistency group using Business Continuity Manager (BCM).
2. Open and mainframe volumes (P-VOLs) receive I/O requests from their applications at the primary (main) site, and data in the volumes is updated.
3. TC or TCz runs copy operations in the consistency group.

For information on creating a TC pair and assigning it to a consistency group using CCI, see the *Command Control Interface User and Reference Guide* and the *Command Control Interface Command Reference*.

For information on creating a TCz pair and assigning it to a consistency group using BCM, see the *Hitachi Business Continuity Manager User Guide* and the *Hitachi Business Continuity Manager Reference Guide*.

## Consistency group for pairs in multiple primary and secondary storage systems

You can create, update, and copy TCz pairs or both TC pairs and TCz pairs in a consistency group of multiple primary storage systems and multiple secondary storage systems.

TC and TCz pairs in multiple primary and secondary systems can be placed in the same consistency group. A maximum of four storage system pairings can be placed in the same consistency group.

In a consistency group for multiple primary and secondary storage systems, you cannot use Business Continuity Manager to perform operations, including registrations, for TrueCopy for Mainframe pairs.

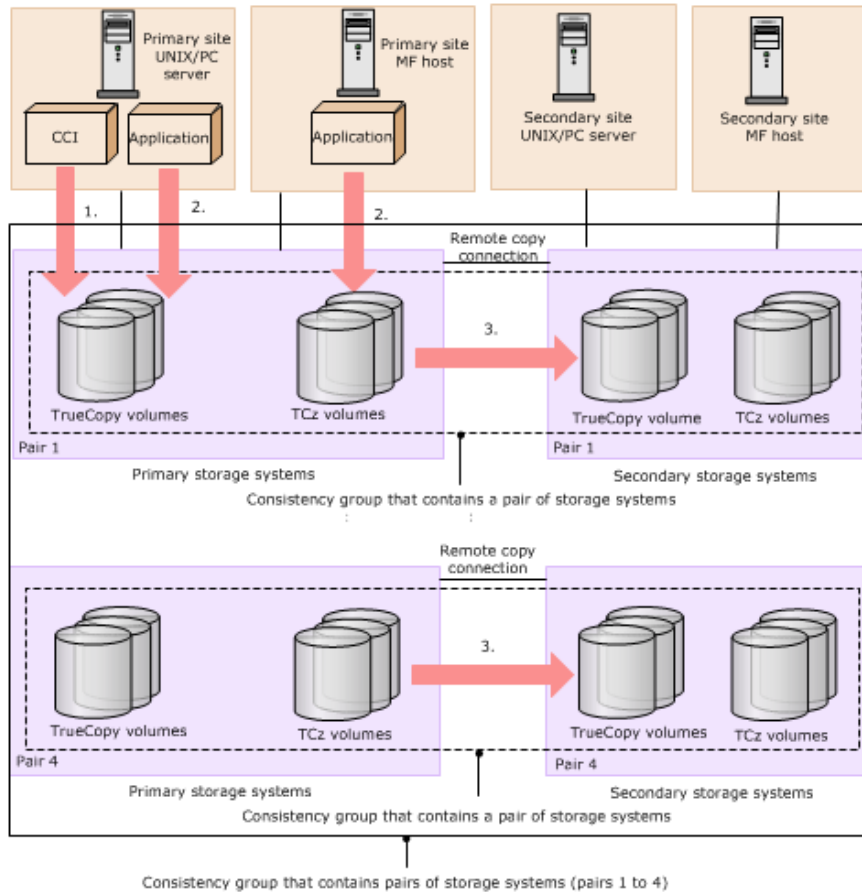

Figure notes:

1. CCI manages the consistency group that contains multiple storage systems.
2. Open and mainframe primary volumes (P-VOLs) receive I/O requests from their applications at the primary (main) site, and data in the volumes is updated.
3. TrueCopy or TrueCopy for Mainframe runs the copy operation in the consistency group.

When the open or mainframe host system guarantees the update order, data consistency in P-VOLs and S-VOLs is ensured. When the host system does not guarantee update order, data consistency is not ensured.

## System configurations for consistency groups

Data consistency between secondary volumes in a consistency group of multiple primary and secondary storage systems is guaranteed for various system configurations.



System configuration	Update sequence of data in a higher system*	Guaranteed range of data consistency between secondary volumes
Open server only	Update sequence of data is guaranteed between servers	TC secondary volumes in multiple storage systems at secondary sites
Open server/mainframe host mixed	Update sequence of data is guaranteed between open servers and mainframe hosts	TC, TCz secondary volumes in multiple storage systems at secondary sites
	Update sequence of data is not guaranteed between open servers and mainframe hosts	No consistency between TC and TCz secondary volumes
	Update sequence of data is guaranteed between open servers	TC secondary volumes in multiple storage systems at secondary sites
	Update sequence of data is guaranteed between mainframe hosts	TCz secondary volumes in multiple storage systems at secondary sites
Mainframe host only	Update sequence of data is guaranteed between mainframe hosts	TCz secondary volumes in multiple storage systems at secondary sites
* If the update sequence of data in a higher system is not guaranteed (data update sequence is unnecessary), data consistency between secondary volumes is not guaranteed.		

## Registering pairs to a new consistency group when creating a new TCz pair

You can configure a consistency group of multiple primary and secondary storage systems when creating new TCz pairs.

The consistency group of multiple primary and secondary storage systems can consist of TCz pairs only.

### Procedure

1. Create CCI configuration definition file C for a configuration of multiple primary and secondary storage systems.
2. Specify the consistency group for registration, and register TC or TCz pairs using configuration definition file C created in step 1.

## Registering pairs to a new consistency group when creating a new TC or TCz pair

You can configure a consistency group of multiple primary and secondary storage systems when creating new TC or TCz pairs.

The consistency group of multiple primary and secondary storage systems can consist of a combination of TC and TCz pairs.

### Procedure

1. Create CCI configuration definition file C for a configuration of multiple primary and secondary storage systems.
2. Specify the consistency group for registration, and register TC or TCz pairs using configuration definition file C created in step 1.

## Registering pairs to a new consistency group when using existing TCz pairs

You can configure a consistency group of multiple primary and secondary storage systems when using existing TCz pairs.

The consistency group of multiple primary and secondary storage systems consists of TCz pairs only.

### Procedure

1. Create CCI configuration definition file A.
2. In CCI, split pairs using CCI configuration definition file A created in step 1.
3. In CCI, resume pair operation using CCI configuration definition file A without specifying a consistency group.
4. In CCI, split pairs using CCI configuration definition file A.
5. Create CCI configuration definition file C for a configuration of multiple pairs of storage systems.
6. In CCI, register pairs to a consistency group, and resume pair operation using CCI configuration definition file C.

### Next steps

After removing existing TCz pairs, you can use the procedure to register pairs to a new consistency group when creating TCz pairs.

## Registering pairs to a new consistency group when using existing TC or TCz pairs

You can configure a consistency group of multiple primary and secondary storage systems when using existing TC or TCz pairs.

The consistency group of multiple primary and secondary storage systems consists of a combination of TC and TCz pairs.

### Procedure

1. Create CCI configuration definition file A.
2. In CCI, split pairs using CCI configuration definition file A created in step 1.

3. In CCI, resume pair operation using CCI configuration definition file A without specifying a consistency group.
4. In CCI, split pairs using CCI configuration definition file A.
5. Create CCI configuration definition file C for a configuration of multiple pairs of storage systems.
6. In CCI, register pairs to a consistency group, and resume pair operation using CCI configuration definition file C.

### **Next steps**

After removing existing TC or TCz pairs, you can use the procedure to register pairs to a new consistency group when creating TC or TCz pairs.

## **Registering pairs to an existing consistency group when creating a new TCz pair**

You can register TCz pairs in a consistency group of multiple primary and secondary storage systems to an existing consistency group when you create a new TCz pair.

The consistency group of multiple primary and secondary storage systems consist of TCz pairs.

### **Procedure**

1. Add information of a TCz pair you want to add to CCI configuration definition file B to create CCI configuration definition file C.
2. In CCI, create a TCz pair using CCI configuration definition file C.

## **Registering pairs to an existing consistency group when creating a new TC or TCz pair**

You can register TC or TCz pairs in a consistency group of multiple primary and secondary storage systems to an existing consistency group when you create a new TC or TCz pair.

The consistency group of multiple primary and secondary storage systems consist of a combination of TC and TCz pairs.

### **Procedure**

1. Add information of a TC or TCz pair you want to add to CCI configuration definition file B to create CCI configuration definition file C.
2. In CCI, create a TC or TCz pair using CCI configuration definition file C.

## **Registering pairs to an existing consistency group when using existing TCz pairs**

You can register TCz pairs in a consistency group of multiple primary and secondary storage systems to an existing consistency group when using existing TCz pairs.

The consistency group of multiple primary and secondary storage systems consist of TCz pairs.

### **Procedure**

1. Create CCI configuration definition file A.

2. In CCI, split pairs using CCI configuration definition file A.
3. In CCI, resume pair operation using CCI configuration definition file A without specifying a consistency group.
4. In CCI, split pairs using CCI configuration definition file A.
5. Use CCI configuration definition file B to split pairs in the existing configuration of multiple primary and secondary storage systems.
6. Add information of the TCz pair you want to add to CCI configuration definition file B for the existing configuration of multiple primary and secondary storage systems to create CCI configuration definition file C.
7. In CCI, create a TCz pair using CCI configuration definition file C.

### **Next steps**

After deleting existing TCz pairs, you can use the procedure to register pairs to an existing consistency group when creating TCz pairs.

## **Registering pairs to an existing consistency group when using existing TC or TCz pairs**

You can register TC or TCz pairs in a consistency group of multiple primary and secondary storage systems to an existing consistency group when using existing TC or TCz pairs.

The consistency group of multiple primary and secondary storage systems consists of a combination of TC and TCz pairs.

### **Procedure**

1. Create CCI configuration definition file A.
2. In CCI, split pairs using CCI configuration definition file A.
3. In CCI, resume pair operation using CCI configuration definition file A without specifying a consistency group.
4. In CCI, split pairs using CCI configuration definition file A.
5. Use CCI configuration definition file B to split pairs in the existing configuration of multiple primary and secondary storage systems.
6. Add information of the TC or TCz pair you want to add to CCI configuration definition file B for the existing configuration of multiple primary and secondary storage systems to create CCI configuration definition file C.
7. In CCI, create a TC or TCz pair using CCI configuration definition file C.

### **Next steps**

After deleting existing TC or TCz pairs, you can use the procedure to register pairs to an existing consistency group when creating TC or TCz pairs.

## Consistency group requirements

Requirements are provided for the following consistency group (CTG) configurations.

- [Consistency group for pairs in one primary and one secondary storage system \(on page 78\)](#)
- [Consistency group for pairs in multiple primary and secondary storage systems \(on page 79\)](#)

### Requirements for a CTG for one primary and one secondary system

- A pair can be assigned to one consistency group only.
- A maximum of 256 (00 to FF) consistency groups can be created. A maximum of 8,192 pairs can be registered to a consistency group.
- TC pairs and TCz pairs can be contained in a consistency group.
- Assign a consistency group ID in a range from 00-FF. The ID must be unused.
- If you use Command Control Interface to resynchronize a TCz pair in an open/mainframe consistency group with one primary system and secondary system, all pairs in the consistency group are resynchronized. A TC pair is also resynchronized with the others, even if its TC S-VOL is being accessed by a host. Make sure to check the status of all pairs in the consistency group before resynchronizing.
- If you use Command Control Interface to delete a TCz pair in an open/mainframe consistency group with one primary system and secondary system, only the TCz pairs are deleted. Use CCI to delete the TC pairs.
- To set or use TrueCopy Synchronous pairs with TC open/MF consistency groups specified, you must install TrueCopy Synchronous. In addition, TrueCopy consistency groups and open/MF consistency groups described in the Hitachi TrueCopy® for Mainframe User Guide are the same. For details about TrueCopy for Mainframe consistency groups, see [Consistency group planning \(on page 77\)](#).

### Requirements for a CTG for multiple primary and secondary systems

- All requirements for a consistency group between one primary and one secondary system apply to a consistency group between multiple primary and secondary systems.
- The primary and secondary systems must be VSP 5000 series, VSP G1x00, VSP F1500, or VSP. No other models can be used.
- A consistency group can consist of a maximum of four primary and four secondary (paired) systems.

- The microcode for both primary and secondary systems must support consistency groups between multiple primary and secondary systems. If it does not, pair creation results in failure.
  - If a storage system at the primary site does not support the consistency group functionality for multiple primary and secondary storage systems, a pair for a consistency group of one primary and one secondary storage system is created.
  - If a storage system at the secondary site does not support the consistency group functionality for multiple primary and secondary storage systems, no pairs can be created.
- You must install the CCI version that supports a consistency group containing multiple primary systems and secondary systems.
- Pair operations can be performed only from CCI. Pair operations from Device Manager - Storage Navigator are not supported.
- Cascade configurations with Universal Replicator for Mainframe pairs are not supported.
- Compatible FlashCopy<sup>®</sup> configurations are not supported.

## Assigning pairs to a consistency group

The procedure to assign pairs depends on the number of storage systems in the consistency group.

### Assigning pairs belonging to one primary system and secondary system

The method for assigning pairs to a consistency group differs according to the management software used to create the pairs:

- When using CCI, see the *Command Control Interface User and Reference Guide*
- When using Business Continuity Manager, see the *Business Continuity Manager User Guide*.

### Assigning pairs belonging to multiple primary and secondary systems

Assigning pairs in multiple primary and secondary systems to a consistency group depends on whether you are assigning to a new consistency group or an existing consistency group.

You can use CCI when creating and assigning pairs to a consistency group on multiple storage systems. Business Continuity Manager is not supported for this configuration.

### Assigning TC and TCz pairs to the same consistency group

TrueCopy pairs can be in the same consistency group as TrueCopy for Mainframe pairs. Use the same consistency group ID for both types. Determine the consistency group ID by using CCI or Business Continuity Manager in advance. Use an unused consistency group ID.

Before defining pairs in CCI, specify the consistency group ID. In Business Continuity Manager, use the Copy Group Attributes (TC) window to set the consistency group ID, and then define pairs. For details about the Copy Group Attributes (TC) window, see the *Business Continuity Manager User Guide*.

When performing a split operation for each group through CCI or Business Continuity Manager, TrueCopy pairs and TrueCopy for Mainframe pairs assigned in the same consistency group are split, and then the data of TrueCopy pairs and TrueCopy for Mainframe pairs is guaranteed until the time that the split operations are accepted. At that time, the YKFREEZE and YKRUN are not required.

When write I/Os are received in the P-VOL of the TrueCopy pairs or the TrueCopy for Mainframe pairs in the target consistency group during the processing of step 2 through step 5, if the volume pair in which I/Os are received is not split, split the pair, and then perform the write I/O operations.

The data consistency is ensured by differentiating data instead of copying data in the S-VOL because the pairs have been split during the write I/O operations.

The following figure shows the pair split processing for each group when TrueCopy pairs #1 and #2, and TrueCopy pairs #3 and #4 are assigned to the same consistency group.

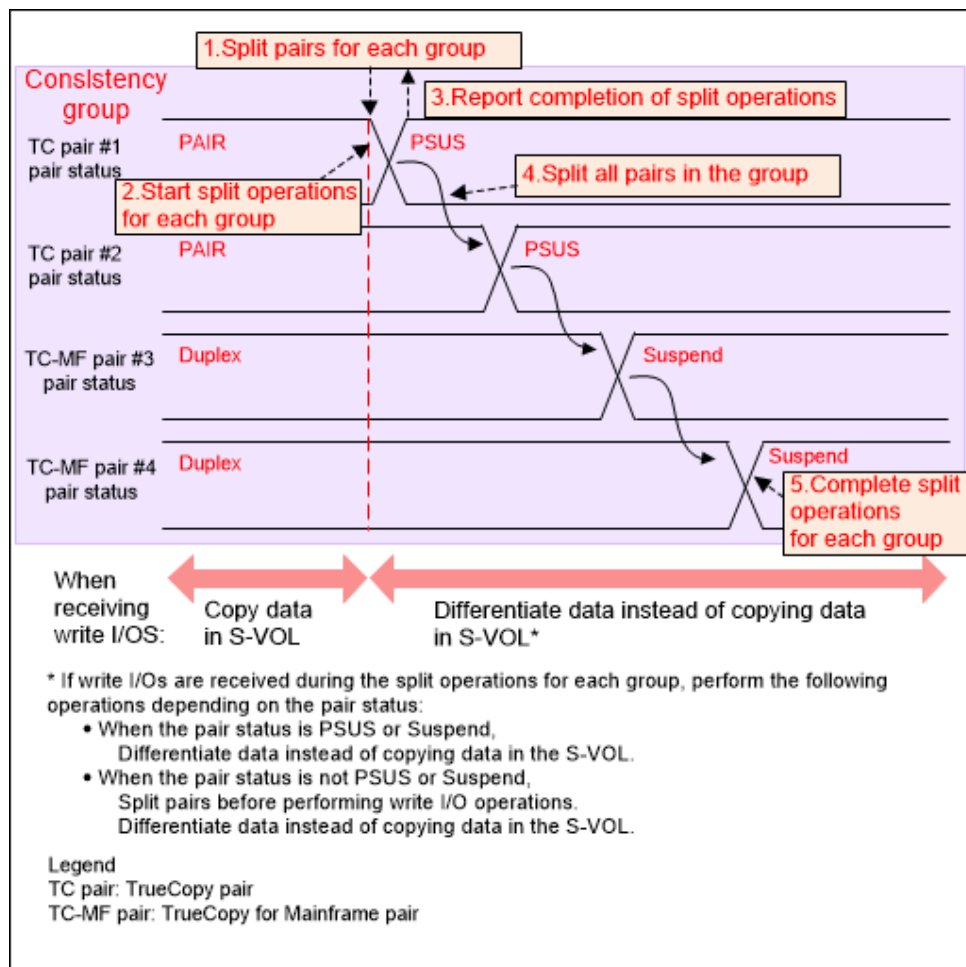

The following is the procedure for pair split processing for each group when TrueCopy and TrueCopy for Mainframe pairs are assigned in the same consistency group.

**Procedure**

1. Accept a split operation for each group through CCI or Business Continuity Manager.
2. Start the split operation for each group.

3. Report the completion of split operation to the requester of the split operation.
4. Split all TrueCopy pairs and TrueCopy for Mainframe pairs belonging to the target consistency group asynchronously.
5. Complete the split operations of all pairs belonging to the target consistency group.

## Using a new CTG

You can assign new pairs or existing pairs to a new consistency group.

### To assign new pairs to a new consistency group

1. Create CCI configuration definition file C for a multiple primary and secondary system configuration.
2. Perform the paircreate operation according to configuration definition file C created in Step 1.

### To assign existing pairs to a new consistency group

1. Create CCI configuration definition file A with which to use CCI for pair operations.
2. Perform the pairsplit operation according to configuration definition file A created in Step 1.
3. Perform the pairresync operation without designating a consistency group. Do this using configuration definition file A.
4. Perform the pairsplit operation again using configuration definition file A.
5. Create CCI configuration definition file C for the multiple primary and secondary system configuration.
6. Perform the pairresync operation and register them to configuration definition file C.



**Tip:** After deleting existing pairs, you can perform steps to assign new pairs to a new consistency group.

## Using an existing CTG

You can assign new pairs or existing pairs to an existing consistency group.

### To assign new pairs to an existing consistency group

1. Add pair information to the existing configuration definition file B, which consists of pairs in multiple storage systems.
2. Copy and create CCI configuration definition file C.
3. Perform the paircreate operation and register them to configuration definition file C.

### To assign existing pairs to an existing consistency group

1. Create CCI configuration definition file A to use with CCI for pair operations.
2. Perform the pairsplit operation on pairs that you want to register in the existing CTG with multiple systems. Do this using configuration definition file A.
3. Perform the pairresync operation without designating a consistency group. Do this using configuration definition file A.



4. Perform the pairsplit operation again using configuration definition file A.
5. Perform the pairsplit operation to the existing configuration definition file B, which consists of the pairs in the multiple primary and secondary system configuration.
6. Add pair information to existing configuration definition file B.
7. Delete then re-create the pairs, registering them in configuration definition file C.



**Tip:** After deleting existing pairs, you can perform steps to assign new pairs to an existing consistency group.

## Split behaviors for pairs in a CTG

When the pairs in a consistency group receive updates while in the process of being split or suspended, or when they are about to be split or suspended, S-VOL data consistency is managed as follows:

- If I/O processing is in progress on pairs in the same consistency group, and the split or suspend operation begins, the I/O processing completes first, and then the split/suspend operation is performed.

The following figure shows that I/O processing is completed first, and then the pair split operation for the pair on Volume B is completed.

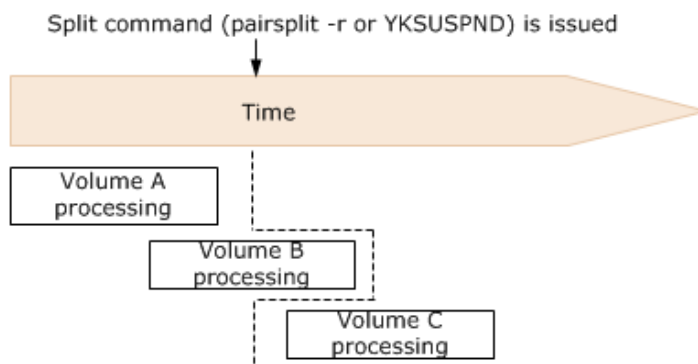

The following figure shows data in track 2 being copied to the S-VOL, and the data in track 3 becomes differential data. In this case, track 2 is used for I/O processing to the volume in the consistency group when the split command is issued to the pair.

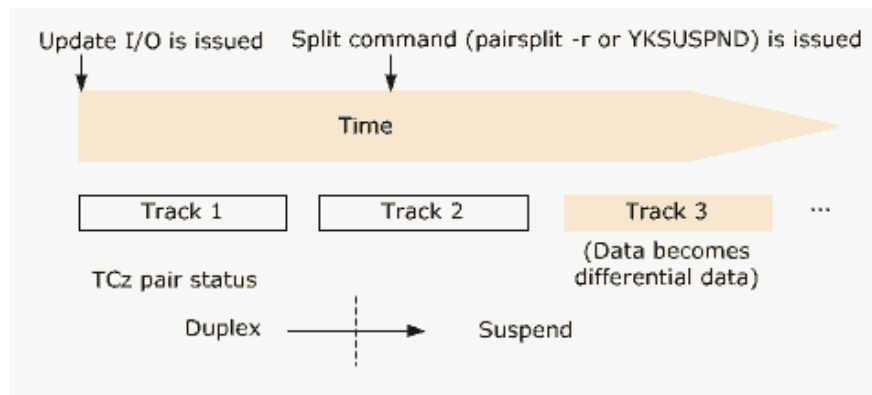

- If a split operation is in progress when I/O processing on the pairs begins, the split operation on the pairs is given priority. After the pair is split, the I/O processing begins.  
In a split operation, the IEA491E message is displayed on the mainframe host when the pair status changes to pair split-error.  
In a split operation, the IEA491E message is displayed on the mainframe host when the pair status changes to pair split-error.
- Data consistency cannot be ensured when all of the following conditions exist:
  - A port is blocked.
  - A split command is in progress.
  - I/O processing begins.
 In such a case, resynchronize the consistency group, and then issue the split command again.

## Host access after split

When splitting the pair using the `pairsplit` command, you can specify settings for read/write access control for the P-VOL and S-VOL in consistency groups after pair split.

These settings are specified using CCI or Business Continuity Manager.

- The CCI settings for TC are optional.
- The Business Continuity Manager settings for TCz are required.

The following tables show the effects of the settings on read and write access.

Interface	Setting	TC P-VOL		TCz P-VOL	
		Read	Write	Read	Write
CCI ( <code>pairsplit</code> command)*	Write access prohibited ( <code>-p</code> option)	Y	N	Y	N
	No option selected	Y	Y	Y	Y

Interface	Setting	TC P-VOL		TCz P-VOL	
		Read	Write	Read	Write
Business Continuity Manager	Write access prohibited	Y	N	Y	N
	Write access permitted	Y	Y	Y	Y
* The effect on read/write shown in this table applies to the TC P-VOL. When CCI is used with a TCz P-VOL, the effect is the same as "No option selected".					

Interface	Setting	TC S-VOL		TCz S-VOL	
		Read	Write	Read	Write
CCI ( <i>pairsplit</i> command)*	Read access permitted (-r option)	Y	N	N	N
	Read/Write access permitted (-rw option)	Y	Y	Y	Y
	No option selected	Y	N	N	N
Business Continuity Manager	Write access prohibited	Y	N	N	N
	Write access permitted	Y	Y	Y	Y
* The effect on read/write shown in this table applies to the TC S-VOL. When CCI is used with a TCz S-VOL, the effect is the same as "No option selected".					

### Pair status before and after a split operation

Pairs in the same consistency group must be in PAIR/Duplex status when you begin the split operation in order to maintain consistency. Otherwise, when the operation completes, pair status will be inconsistent.

This is shown in the following table, in which font angle indicates the following:

- *Italics font*: Pair status before the split operation on the consistency group
- **Regular font**: Status after the split operation

For CCI

Pair statuses		TCz pairs		
		All = Duplex	Some = Duplex, some = Suspend	All = Suspend
TC pairs	All = PAIR	TC: PSUS TCz: Suspend	TC: PSUS TCz: Suspend	TC: PSUS TCz: Suspend
	Some = PAIR, some = PSUS	TC: PSUS TCz: Suspend	TC: PSUS TCz: Suspend	TC: PSUS TCz: Suspend
	All = PSUS	TC: PSUS TCz: Duplex	TC: PSUS TCz: Duplex/Suspend	TC: PSUS TCz: Suspend

For BCM

Pair statuses		TCz pairs		
		All = Duplex	Some = Duplex, some = Suspend	All = Suspend
TC pairs	All = PAIR	TC: PSUS TCz: Suspend	TC: PSUS TCz: Suspend	TC: PSUS TCz: Suspend
	Some = PAIR, some = PSUS	TC: PSUS TCz: Suspend	TC: PSUS TCz: Suspend	TC: PSUS TCz: Suspend
	All = PSUS	TC: PSUS TCz: Suspend	TC: PSUS TCz: Suspend	TC: PSUS TCz: Suspend

## Resynchronizing and removing pairs using Business Continuity Manager

When you resynchronize the TrueCopy for Mainframe pair in the Open/MF consistency group which consists of one pair of the primary storage system and the secondary storage system by Business Continuity Manager, all pairs in the consistency group are resynchronized. If the host is accessing the S-VOL of the TrueCopy pair, the TrueCopy pair is also resynchronized simultaneously. Resynchronize the pair after you reconfirm the status of all TrueCopy pairs and all TrueCopy for Mainframe pairs in the consistency group.

When you remove the TrueCopy for Mainframe pair in the Open/MF consistency group which consists of one pair of the primary storage system and the secondary storage system by Business Continuity Manager, only the TrueCopy for Mainframe pairs in the consistency group are removed. If you want to remove the TrueCopy pair simultaneously, you must remove the pairs by CCI.

## **Error reporting communications**

Error reporting communications (ERC) transfers information between host processors at the primary and secondary sites. It is a critical component of a disaster recovery effort.

You can configure ERC using channel to channel communications, NetView technology, or other inter-connection technologies depending on your installation requirements and standards. TrueCopy for Mainframe does not provide ERC between the primary and secondary sites.

- When TrueCopy for Mainframe is used as a disaster recovery tool, ERC is required to ensure effective recovery operations.
- When TrueCopy for Mainframe is used as a data migration tool, ERC is recommended.
- When a pair is split due to an error condition, the primary system generates sense information that results in an IEA491E system console message. This information should be transferred to the secondary site using ERC for effective disaster detection and recovery.

---

## Chapter 4: Sharing TrueCopy for Mainframe volumes

You can share TrueCopy for Mainframe (TCz) pair volumes with non-TCz volumes. All of the software products that can be used with TCz are discussed here.

### Volume types that can be shared with TrueCopy for Mainframe

You can use other software product volumes as TrueCopy for Mainframe P-VOL or S-VOL, if you have those other software products.

The following table lists the types of volumes by software product and indicates whether the volume can also be used as a TCz P-VOL or a TCz S-VOL.

Functions and volumes	Used as P-VOL?	Used as S-VOL?
<b>Active flash for mainframe</b>		
DP-VOL	Yes	Yes
Pool-VOL	No	No
<b>Cache Residency Manager</b>		
Volume with CRM data	Yes	Yes
<b>Compatible FlashCopy® V2</b>		
S-VOL	Yes	Yes
T-VOL	Yes <sup>1, 3, 5</sup>	No
<b>Hitachi Compatible Software for IBM® FlashCopy® SE<sup>4</sup></b>		
S-VOL	Yes	Yes
T-VOL	No	No
<b>Compatible PAV</b>		
Compatible PAV volume	Yes	Yes
<b>Compatible XRC</b>		

Functions and volumes	Used as P-VOL?	Used as S-VOL?
P-VOL	Yes	No
S-VOL	Yes	No
<b>Concurrent Copy (CC)</b>		
CC volume	Yes	No
<b>Cross-OS File Exchange</b>		
Volume for mainframe and open-systems use	No	No
<b>Dynamic Provisioning for Mainframe</b>		
DP-VOL	Yes	Yes
Pool-VOL	No	No
<b>Dynamic Tiering for Mainframe</b>		
DP-VOL	Yes	Yes
Pool-VOL	No	No
<b>ShadowImage for Mainframe</b>		
P-VOL in Split/SUSPOP status	Yes	Yes
P-VOL in Resync-R/REVERSY status	No	No
P-VOL when also used as a URz primary or secondary volume	No	No
P-VOL (none of the above)	Yes	Yes
S-VOL in Split/SUSPOP status	Yes	No
S-VOL (none of the above)	No	No
Reserved volume	No <sup>1, 3, 5</sup>	No
<b>Soft Fence</b>		
Volume for which Soft Fence is set	No	No
<b>Universal Replicator for Mainframe</b>		
P-VOL (primary system) in Pending status	No	No

Functions and volumes	Used as P-VOL?	Used as S-VOL?
P-VOL in Duplex status	Yes <sup>6</sup>	No. The volume can be used as an S-VOL only when you restore a TCz pair or perform a BCM YKRESYNC REVERSE operation.
P-VOL in Suspend status	Yes <sup>6</sup>	No. The volume can be used as S-VOL only when you restore a TCz pair or perform a BCM YKRESYNC REVERSE operation.
P-VOL suspended due to a failure	Yes <sup>6</sup>	No. The volume can be used as S-VOL only when you restore a TCz pair or perform a BCM YKRESYNC REVERSE operation.
S-VOL (secondary volume) in Pending status	No	No
S-VOL in Duplex status	No	No
S-VOL in Suspend status	Yes <sup>6</sup>	No
S-VOL in Swapping status	Yes <sup>6</sup>	No
S-VOL suspended due to a failure	Yes <sup>6</sup>	No
<b>Universal Volume Manager</b>		
Mapped external volume	Yes	Yes
<b>Virtual Partition Manager (VPM)</b>		
Volume belonging to the Virtual Partition Manager CLPR	Yes	Yes
Virtual LVI		
Virtual LVI volume	Yes	Yes
<b>Volume Migration<sup>2</sup></b>		
Source volume (when volume migration is in progress)	Yes. If the source volume is used as a P-VOL, volume migration stops.	Yes. If the source volume is used as an S-VOL, volume migration stops.



Functions and volumes	Used as P-VOL?	Used as S-VOL?
Source volume (after volume migration finishes)	Yes	Yes
Target volume	No	No
Reserved volume	No	No
<b>Volume Retention Manager</b>		
Volume with Read/Write attribute	Yes	Yes
Volume with Read Only attribute	Yes	Yes
Volume with Protect attribute	No	No
<b>Volume Security</b>		
Volume registered in a security group	Yes	Yes. If the volume is disabled for use as S-VOL, the volume cannot be used as S-VOL.
<p><b>Notes:</b></p> <ol style="list-style-type: none"> <li>1. The volume performs differently according to the type of difference management.</li> <li>2. For more information, contact customer support.</li> <li>3. If you use TCz with Compatible FlashCopy® V2, the TCz pairs must be created without using the consistency groups.</li> <li>4. See the section about compatible software in the <i>Hitachi Compatible FlashCopy/FlashCopy SE User Guide</i>.</li> <li>5. When you create Compatible FlashCopy® V2 Preserve Mirror relationships in COPY mode, both copies are not synchronized. If you issue Withdraw during the copy operation, both copies of the relationship are suspended. Therefore, the consistency of the data between P-VOL and S-VOL is not ensured even though the TCz pair is in Duplex status. To release this status, delete the TCz pair.</li> <li>6. In a 3DC multi-target or 3DC cascade configuration with three URz sites, the volume shared with two URz pairs cannot be used with TCz. Likewise, a volume used with TCz cannot be used as a volume shared with two URz pairs.</li> </ol>		

## Cache Residency Manager

The volumes which set the Cache Residency Manager can be assigned as the TrueCopy for Mainframe pair. You can perform Cache Residency Manager operations on TCz P-VOLs and S-VOLs. For more information, see the *Performance Guide*.

## Compatible XRC and CC

VSP 5000 series is functionally compatible with the IBM® Extended Remote Copy (XRC) function and the IBM® I-2107 Concurrent Copy (CC) function. For more information about XRC and/or I-2107 CC, see the applicable IBM® documentation.

## Dynamic Provisioning for Mainframe

You can create a Universal Replicator pair by specifying a DP-VOL (Dynamic Provisioning virtual volume). DP-VOLs can be assigned to both the TCz P-VOL and S-VOL, or to one of them. However, the following restrictions apply:

- DP-VOL use is limited by emulation type, as indicated in the following table.

P-VOL	S-VOL		
	DP-VOL/3390-A	Ordinary volume/ 3390-A	Ordinary volume/ 3390-X <sup>1, 2</sup>
DP-VOL/3390-A	Yes	Yes	No
Ordinary volume/3390-A	Yes	Yes	No
Ordinary volume/3390-X <sup>1</sup>	Yes	Yes	Yes

**Notes:**

- 3390 series other than 3390-A.
- DP-VOL use in other than the 3390 series emulation type is not supported for TrueCopy for Mainframe.

- Migrating existing data to DP-VOL/3390-A or ordinary volume/3390-A, DP-VOL 3390-X P-VOL, DP-VOL/3390-A S-VOL, and ordinary volume/3390-A configurations are supported. Swapping to DP-VOL/3390-A or ordinary volume/3390-A P-VOL, and to ordinary volume/3390-X S-VOL is not supported.
- You can use DP-VOLs that are also used in a ShadowImage for Mainframe or Compatible FlashCopy® V2 pair, or in a Volume Migration migration plan. Before creating the TCz pair, delete the Slz or Compatible FlashCopy® V2 pair, or disable the Volume Migration setting. After the pair is created, re-create the pair or migration plan.



**Note:** This is necessary only if both TCz pair volumes are DP-VOLs.

- When a DP-VOL has pages allocated to an S-VOL, used pool capacity is temporarily larger than the actual capacity because pages must be reallocated in the DP-VOL. Therefore, before creating the pair, make sure of the following:
  - DP-VOL pool capacity is sufficient.
  - Pool-VOLs that are added to a pool are not blocked. If Pool-VOLs are blocked, restore the volume status and then create the pair.
- Regarding page and license capacity:
  - When you create a TCz pair with a DP-VOL, the page capacity allocated to the DP-VOL is accumulated on the TCz license capacity. However, Dynamic Provisioning for Mainframe automatically releases pages with reclaiming zero pages in the DP-VOL, thus increasing usable capacity.
 

Pages that include control cylinder information are not released (see next).
  - If a pair does not include a DP-VOL, volume capacity is counted toward TCz license capacity.
 

If a pair includes a DP-VOL, only the allocated page capacity of volume capacity is counted toward TCz license capacity.

If a DP-VOL and a non-DP-VOL are included in a pair, the page capacity and/or license capacity counted in the P-VOL and the S-VOL might be different. This applies even when both P-VOL and S-VOL include DP-VOLs, because the page capacity of the P-VOL or the S-VOL changes by a relocated pool or released page or other action.
  - Page or license capacity can also differ between the P-VOL and S-VOL for the following reasons:
    - The TCz copy process overwrites S-VOL track data, even when the track is assigned to pages with no records in the P-VOL. This happens because when S-VOL track data is overwritten, TCz updates the control cylinder information, which manages track information. Additional pages might result for holding control cylinder information in the S-VOL, and these pages cannot be released. Thus, the number of pages in the S-VOL might be greater than in the P-VOL.
    - When you update the S-VOL in Suspend status, a page that includes control cylinder information might be assigned. Pages that include the control cylinder information are not released, so the number of pages in the S-VOL can be greater than the number of pages in the P-VOL.
    - When the TCz copy process is run for zero data pages in the P-VOL, the S-VOL might not assign zero data pages, so there might be fewer pages in the S-VOL.
  - When you create a pair for TCz, even if there are no allocated pages in the P-VOL, one allocated page occurs for every 4,060 Cyl in the S-VOL volume for the control cylinder. As a result, S-VOL might have more pages than the P-VOL.
  - TCz license capacity can be less than DP-VOL page capacity, however it cannot exceed page capacity.

- If the volume you will use for a TCz S-VOL is a DP-VOL and its capacity is more than the P-VOL capacity, before you create the pair you must delete the datasets on the S-VOL using the z/OS® Security Server RACF® (Resource Access Control Facility) function. For details, see the applicable IBM® documents.
- If both the TCz P-VOL and S-VOL are DP-VOLs and the TCz S-VOL is also used as the Compatible FlashCopy® SE S-VOL (source volume), all data might be copied between TCz pair volumes.

For more information, see the *Provisioning Guide for Mainframe Systems*.

## Performance Monitor

Performance Monitor software provides detailed information about I/O activity and hardware performance in the storage system. Storage system usage and performance data is collected and displayed by Performance Monitor. This information helps you to:

- Identify the optimum timing for performing TCz operations.
- Determine the best locations for the TCz S-VOL (for example, parity groups with less-frequently accessed volumes to avoid bottlenecks of backend activity).
- Monitor system performance during TCz operations and during testing activities.

See the *Performance Guide* for more information.

## ShadowImage for Mainframe

You can assign ShadowImage for Mainframe volumes to TCz pairs, and you can assign TCz volumes to Slz pairs.

The following table shows the configurations that are possible.

TCz volume	Slz P-VOL	Slz S-VOL
P-VOL	Yes	Yes
S-VOL	Yes	No

Note the following when sharing TCz volumes with Slz volumes.

- L1 and L2 Slz pairs can be shared with TCz volumes. Both node and leaf S-VOLs are considered secondary volumes by TCz.
- When using PPRC, the Split status cannot be distinguished from the V-Split status. If you share an Slz S-VOL with a TCz P-VOL, either use the PPRC command to perform the Steady Split operation, or use Device Manager - Storage Navigator to confirm the pair statuses. Perform the Steady Split operation using the CSUSPEND parameters (specify the serial number of the PRIM as MPS00).

## Configurations with ShadowImage for Mainframe P-VOLs

TCz can share an Siz P-VOL in three configurations:

- In the following figure, the TCz P-VOL also functions as an Siz P-VOL. This configuration allows you to use Siz for on-site data backup in case of TCz failure. Or, the TCz S-VOL can be used to provide remote backup of the Siz P-VOL in case of an Siz failure.

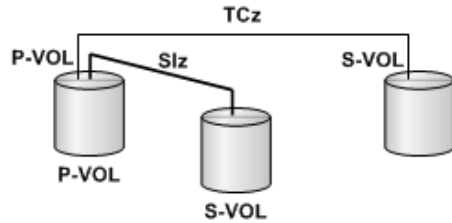

**Figure 1 Shared TCz P-VOL with Siz P-VOL**

In this configuration, you can only delete TCz pairs when the Siz P-VOL status is Resync-R/REVRSY. The following table shows possibilities of TCz pair operations according to the Siz P-VOL status.

Siz P-VOL status	TCz pair operations				
	Create	Split	Resync	Delete	Switch operations between the primary and secondary sites (horctakeover)
PENDING SP-Pend/ TRANS Resync/ PENDING	Yes	Yes	Yes	Yes	Yes
DUPLEX	Yes	Yes	Yes	Yes	Yes
V-Split/SUSPVS	Yes	Yes	Yes	Yes	Yes
Split/SUSPOP Suspend/ SUSPER	Yes	Yes	Yes	Yes	Yes
Resync-R/ REVRSY	No	No	No	Yes	No

- In the following figure, the TCz S-VOL also functions as an Slz P-VOL. In this configuration, Slz provides another (or several more) backup copies of a TCz P-VOL.

When an Slz P-VOL is shared with the TCz S-VOL, the write operation to the TCz P-VOL takes a longer time than normal. This is especially true when the Slz pair is in the V-Split/ SUSPVS status and is caused by the Slz copying process. The processing time is increased by the processing time for Slz added to the normal TCz unit copy processing. The processing time might be increased by dozens of milliseconds with the addition of Slz.

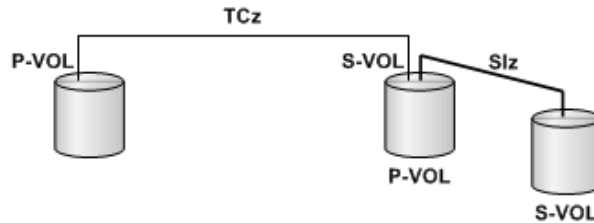

**Figure 2 Shared TCz S-VOL with Slz P-VOL**

In this configuration, you can only delete TCz pairs when the Slz P-VOL status is Resync-R/REVRSY. The following table shows possibilities of TCz pair operations according to the Slz P-VOL status.

Slz P-VOL status	TCz pair operations				
	Create	Split	Resync	Delete	Switch operations between the primary and secondary sites (horctakeover)
PENDING SP-Pend/ TRANS Resync/ PENDING	Yes*	Yes	Yes	Yes	Yes
DUPLEX	Yes*	Yes	Yes	Yes	Yes
V-Split/ SUSPVS	Yes*	Yes	Yes	Yes	Yes
Split/ SUSPOP Suspend/ SUSPER	Yes*	Yes	Yes	Yes	Yes
Resync-R/ REVRSY	No	No	No	Yes	No

\* When the P-VOL and the S-VOL of a TrueCopy for Mainframe pair are used as the DP-VOL of Dynamic Provisioning for Mainframe, if you share the P-VOL of a

Slz P-VOL status	TCz pair operations				
	Create	Split	Resync	Delete	Switch operations between the primary and secondary sites (horctakeover)
ShadowImage for Mainframe pair with the S-VOL of the TrueCopy for Mainframe pair, you must delete the ShadowImage for Mainframe pair before creating the TrueCopy for Mainframe pair. For details, see <a href="#">Dynamic Provisioning for Mainframe (on page 98)</a> .					

- In the following figure, the configurations shown in the previous two figures are combined. Both the TCz P-VOL and S-VOL function as Slz P-VOLs, providing multiple copies at the primary and secondary sites.

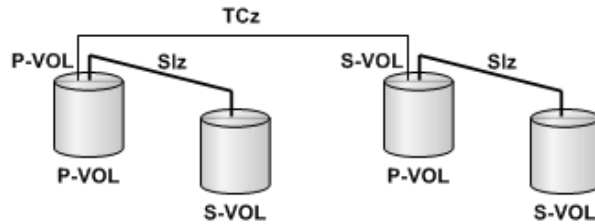

**Figure 3 Shared TCz P-VOL, S-VOL with multiple Slz P-VOLs**

In this configuration, you can only delete TCz pairs when the Slz P-VOL status is Resync-R/REVRSY. The following table shows possibilities of TCz pair operations according to the Slz P-VOL status.

Slz P-VOL status	TCz pair operations				
	Create	Split	Resync	Delete	Switch operations between the primary and secondary sites (horctakeover)
PENDING SP-Pend/ TRANS Resync/ PENDING	Yes	Yes	Yes	Yes	Yes
DUPLEX	Yes	Yes	Yes	Yes	Yes
V-Split/ SUSPVS	Yes	Yes	Yes	Yes	Yes
Split/ SUSPOP	Yes	Yes	Yes	Yes	Yes

Slz P-VOL status	TCz pair operations				
	Create	Split	Resync	Delete	Switch operations between the primary and secondary sites (horctakeover)
Suspend/ SUSPER					
Resync-R/ REVRSY	No	No	No	Yes	No

## Configurations with ShadowImage for Mainframe S-VOLs

In the following figure, an Slz S-VOL also functions as a TCz P-VOL. This configuration requires that the Slz pair is split before the TCz pair is created.

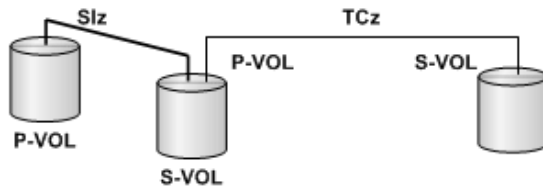

**Figure 4 Shared Slz S-VOL with TCz P-VOL**

In this configuration, before creating a TCz pair, you must set the Slz in the DUPLEX status, split the Slz pair, and then set it in the Split/SUSPOP status. The following table shows possibilities of TCz pair operations according to the Slz S-VOL status.

Slz S-VOL status	TCz pair operations				
	Create	Split	Resync	Delete	Switch operations between the primary and secondary sites (horctakeover)
PENDING SP-Pend/ TRANS Resync/ PENDING	No	No	No	Yes	No
DUPLEX	No	No	No	Yes	No
V-Split/ SUSPVS	No	No	No	Yes	No



Slz S-VOL status	TCz pair operations				
	Create	Split	Resync	Delete	Switch operations between the primary and secondary sites (horctakeover)
Split/ SUSPOP  Suspend/ SUSPER	Yes	Yes	Yes	Yes	No
Resync-R/ REVRSY	No	No	No	Yes	No

## Status reporting and data currency

The following table shows the pair status that is reported for different combinations of shared volumes.

Number of TCz pairs	Number of Slz S-VOLs	Pair status
0	0	It does not display in pair list.
0	1	Slz pair status
0	2 or more	Slz pair status for the S-VOL with lowest LDEV ID.
1	0	TCz pair status
1	1	TCz pair status
1	2 or more	TCz pair status

- TCz pair status is reported to the host if you query the TCz P-VOL or S-VOL. To obtain the Slz pair status, query the Slz P-VOL pair.
- Slz supports multiple S-VOLs for each of its P-VOLs, but when you issue a pair status query, the status is returned only for the pair whose S-VOL has the lowest LDEV ID. To check pair status for the other S-VOLs, direct a host query to the specific S-VOL using the S-VOL's LDEV ID in the host command.

Device Manager - Storage Navigator displays the status of all S-VOLs.

The following table shows when data is current on a shared TCz/Slz volume based on the pair statuses.

TCz pair status	Slz pair status							
	Pending	Duplex	Split/ SUSPOP Pending	V-Split/ SUSPVS	Split/ SUSPO P	Resync/ Pending	Resync -R/ REVRS Y	Suspend / SUSPER
Pending	Not Current	Not Current	Not Current	Not Current	Current	Not Current	-	Not Current
Duplex	Not Current	Not Current	Not Current	Not Current	Current	Not Current	-	Not Current
- Suspend (Secondary Volume by Operator) - Suspend	Not Current	Current	Current	Current	Current	Current	Current	Not Current

## Universal Replicator for Mainframe

TCz and Universal Replicator for Mainframe can share the same pair volumes. Using a combined TCz and Universal Replicator for Mainframe configuration can extend disaster recovery options to a third data center.

Like TCz, a Universal Replicator for Mainframe pair maintains a copy of the production volume in a second location. However, unlike TCz, the Universal Replicator for Mainframe S-VOL is asynchronous, and the secondary system can be located much greater distances from the primary and secondary TCz sites.

Creating both a TCz and a Universal Replicator for Mainframe backup ensures that a copy in a third location is available in the event that the primary site or one of the systems fails.

Configurations consisting of TCz and Universal Replicator for Mainframe pair volumes are covered extensively in the *Hitachi Universal Replicator for Mainframe User Guide*.

## Virtual LVI

Virtual LVI volumes can be assigned to TCz pairs, but there are restrictions.

The following are restrictions:

- The S-VOL must have the same capacity as the P-VOL.
- When performing Virtual LVI operations on an existing TCz P-VOL or S-VOL, you must release the pair first to return the volume to Simplex status.

For more information, see the *Provisioning Guide for Mainframe Systems*.

## Volume Migration

TCz volumes can be used as Volume Migration volumes when pairs are in certain statuses.

The following table specifies the status when TCz volumes can be used.

Volume/pair status	Used as Volume Migration volume?
P-VOL/S-VOL in Pending status	No
P-VOL/S-VOL in Duplex status	Yes
P-VOL/S-VOL in Suspend status	Yes

### Restrictions to using a TrueCopy for Mainframe volume as a Volume Migration volume

There are certain restrictions when a TCz volume in Duplex status is used as a Volume Migration volume.

The following restrictions must be followed:

- Set I/O rates less than 50 IOPS while migrating volumes. If the I/O rate is more than 50 IOPS, volumes might not be migrated.
- If a data path failure occurs, remove the failure and then migrate the volume.
- If an external volume or a DP-VOL is used, information from before the volume was migrated is displayed in the secondary system Device Manager - Storage Navigator window. If the Volume Migration is completed and the TCz pair is suspended and resynchronized, the volume's information is updated.
- Do not migrate a P-VOL and S-VOL at the same time. If you do, a host I/O timeout error can occur.
- Do not change the status of a volume during migration. If you do, the status might not change.

## Volume Retention Manager

Volume Retention Manager access attributes can be assigned to TrueCopy for Mainframe pair volumes. The following table shows how access attributes change.

Note that the Protect attribute cannot be successfully assigned because it causes pair suspension.

Access attribute of P-VOL	VRM	Access attribute of S-VOL					
		Read/Write enabled		Read Only		Protect	
		Enabled	Disabled	Enabled	Disabled	Enabled	Disabled
Read/Write enabled	Enabled	P-VOL/S-VOL Read/Write enabled	P-VOL/S-VOL Read/Write enabled	P-VOL/S-VOL Read/Write enabled	P-VOL Read/Write enabled, S-VOL Read only	Pairs cannot be created	Pairs cannot be created
	Disabled	P-VOL/S-VOL Read/Write enabled	P-VOL/S-VOL Read/Write enabled	P-VOL Read/Write enabled, S-VOL Read only	P-VOL Read/Write enabled, S-VOL Read only	Pairs cannot be created	Pairs cannot be created
Read Only	Enabled	P-VOL/S-VOL Read only	Pairs cannot be created	P-VOL/S-VOL Read only	Pairs cannot be created	Pairs cannot be created	Pairs cannot be created
	Disabled	P-VOL Read only, S-VOL Read/Write enabled	P-VOL Read only, S-VOL Read/Write enabled	P-VOL/S-VOL Read only	P-VOL/S-VOL Read only	Pairs cannot be created	Pairs cannot be created
Protect	Enabled	Pairs cannot be created	Pairs cannot be created	Pairs cannot be created	Pairs cannot be created	Pairs cannot be created	Pairs cannot be created
	Disabled	Pairs cannot be created	Pairs cannot be created	Pairs cannot be created	Pairs cannot be created	Pairs cannot be created	Pairs cannot be created

## Soft Fence

Soft Fence is a volume protection function for disaster recovery provided by IBM. You should know what happens for remote path operations in volumes for which Soft Fence is set.

For details about Soft Fence, see the *Provisioning Guide for Mainframe Systems* and IBM® documentation. For information about how to check whether Soft Fence is set, see the *Provisioning Guide for Mainframe Systems*.

The following table describes remote path operations in volumes for which Soft Fence is set.

Operation	Soft Fence setting		Operation result
	P-VOL	S-VOL	
Add remote paths	Set	Not set	Terminates abnormally*
	Not set	Set	Terminates normally
	Set	Set	Terminates abnormally*
	Not set	Not set	Terminates normally
Delete remote paths	Set	Not set	Terminates abnormally*
	Not set	Set	Terminates normally
	Set	Set	Terminates abnormally*
	Not set	Not set	Terminates normally

\*Terminates normally if CCI and Device Manager - Storage Navigator are used.

The following table describes pair operations when Soft Fence is set for TCz pairs.

Operation	Soft Fence setting		Operation result
	P-VOL	S-VOL	
Create pairs	Set	Not set	Terminates abnormally
	Not set	Set	Terminates abnormally
	Set	Set	Terminates abnormally
	Not set	Not set	Terminates normally
Resynchronize pairs	Set	Not set	Terminates abnormally
	Not set	Set	Terminates abnormally
	Set	Set	Terminates abnormally

Operation	Soft Fence setting		Operation result
	P-VOL	S-VOL	
	Not set	Not set	Terminates normally
Split pairs	Set	Not set	Terminates abnormally*
	Not set	Set	Terminates normally
	Set	Set	Terminates abnormally*
	Not set	Not set	Terminates normally
Delete pairs	Set	Not set	Terminates abnormally*
	Not set	Set	Terminates normally
	Set	Set	Terminates abnormally*
	Not set	Not set	Terminates normally
*Operations for pairs registered in consistency groups specified by CCI or Business Continuity Manager terminate normally.			



**Note:** If you set Soft Fence for a TCz S-VOL during host I/Os or initial copy, the TCz pair might be suspended by failure.

---

## Chapter 5: TCz configuration

Configuring TrueCopy for Mainframe requires you to understand and follow a configuration workflow.

### Configuration workflow

You must have Storage Administrator (Remote Copy) role to perform most TrueCopy for Mainframe operations using Device Manager - Storage Navigator.

Configuration consists of the following operations.

- Check prerequisites for each procedure.
- See [Pair and pair volumes planning \(on page 68\)](#).
- On the primary and secondary systems, install the data paths. See [Data path requirements and configurations \(on page 61\)](#).
- On the primary and secondary systems, define the Fibre Channel port attribute (Bidirectional) that will be used for TrueCopy for Mainframe operations. See [Ports \(on page 66\)](#) and [Defining port attributes \(on page 111\)](#) for details.
- On the primary system, create the TrueCopy for Mainframe association with the secondary system. See [Adding remote connections \(on page 113\)](#). Remote paths between the systems are added during this procedure.

You can also perform these additional procedures prior to the initial copy:

- Add additional remote paths. For instructions, see [Configuring additional remote paths \(on page 148\)](#).
- Specify the maximum number of volumes to copy at the same time. See [Setting the remote replication options \(on page 115\)](#).

Unless otherwise stated, this user guide assumes a configuration in which the primary storage system connects to the P-VOL and the secondary storage system connects to the S-VOL. The local storage system refers to the storage system connected to the management client or CCI. The remote storage system refers to the system connected to the local storage system.

### Defining port attributes

Bidirectional ports must be set up on the primary and secondary systems for TrueCopy for Mainframe command and data transfer.

**Before you begin**

- Storage Administrator (System Resource Management) is required.
- The number of hosts connected to a Target port must be limited to 128 or fewer to avoid disconnection.
- See [Ports \(on page 66\)](#) for information about Target, and Bidirectional ports.
- If you are changing a Target port to a Bidirectional port, prepare the port for the change as follows:
  - Confirm that the port is offline.
  - Disconnect the port from the host.
  - Remove all channel paths to the port.
- If you are changing a Fibre channel port from a Bidirectional port to a Target port, prepare the port for the change as follows:
  - Release all pairs using the ports.
  - Delete the paths from the Bidirectional port to the remote storage system.
  - Disconnect the connection from the local storage system to the remote storage system. See [Deleting remote connections \(on page 153\)](#).

**Procedure**

1. Click **Storage Systems**, and then expand the Storage Systems tree.
2. In the Storage Systems tree, click **Ports/Host Groups/iSCSI Targets**.
3. In the **Ports/Host Groups/iSCSI Targets** window, click the **Ports** tab, select the port to be changed, and click **Edit Ports**.
4. In the **Edit Ports** window, select a **Port Attribute: Bidirectional**.

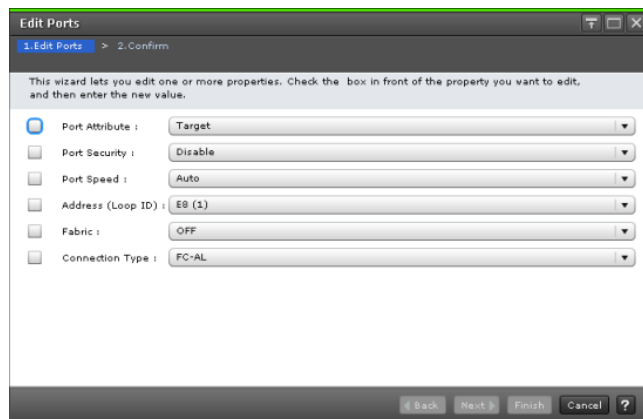

For all other settings, see the *Provisioning Guide for Mainframe Systems*.

5. Click **Finish**.
6. In the **Confirm** window, review the settings and enter a task name in the **Task Name** box.
7. Click **Apply** to save your settings.



## Adding remote connections

You can configure the storage systems for TrueCopy for Mainframe by adding a remote connection from the primary to the secondary system.

Adding the connection and setting up remote paths prepares the systems for TCz commands and operations.

Depending on the system configuration, remote connection from the secondary storage system to the primary storage system is also added.



### Caution:

Do not add or delete a remote connection or add a remote path at the same time that the SCSI path definition function is in use.

### Before you begin

- The local and remote systems must be ready for TCz operations. See [Storage system preparation \(on page 52\)](#).
- The data path must be set up. See [Data path requirements and configurations \(on page 61\)](#).
- The port attributes on the local and remote systems must be configured for TrueCopy for Mainframe. See [Defining port attributes \(on page 111\)](#).
- The remote system serial number, LDKC, controller ID, and port numbers are required.
- One of the fields, Round Trip Time, is covered extensively in [Round trip time option \(on page 54\)](#).
- Another field, Minimum Number of Paths, is also covered in more detail in [Minimum number of remote paths option \(on page 58\)](#).
- Remote path settings are required to perform TCz pair operations and check pair status in Device Manager - Storage Navigator. Make sure to complete the procedure. If you cancel remote path settings, you will be unable to perform operations and check status.
- Operations involving remote paths cannot be performed when changing the firmware. Make sure a firmware change completes before beginning operations involving remote paths.
- When using virtual storage machine volumes, make sure to specify the physical serial number of the storage system, not the serial number of the virtual storage machine.
- Operations involving remote paths cannot be performed if changing the microcode is interrupted due to an error or operation cancellation. Make sure a microcode change completes before beginning operations involving remote paths.

### Procedure

1. Click **Storage Systems**, and then expand the Storage Systems tree.
2. In the Storage Systems tree, click **Replication > Remote Connections**.
3. In the **Remote Connections** window, click the **Connections (To)** tab.
4. In the **Connections (To)** tab, click **Add Remote Connection**.

5. In the **Add Remote Connection** window, select the **Connection Type**:

- For TC, select **System** (connects system by system).
- For TCz, select **CU** (connects CU by CU).



**Note:** When using virtual storage machine volumes, make sure to specify the physical serial number of the storage system, not the serial number of the virtual storage machine.

6. In the **Remote Storage System** box, specify the following:

- a. For **Model**, select the storage system model and number. Select 8 for VSP 5000 series, 7 for VSP G1x00, VSP F1500, and 6 for VSP.
- b. For **Serial Number**, enter one of the following remote storage system serial numbers.
  - VSP 5000 series: 1 to 99999 (5 digits)
  - VSP G1x00, and VSP F1500: 1 to 99999 (5 digits)
  - VSP: 1 to 99999 (5 digits)



**Note:**

- When the remote storage system is VSP 5000 series, specify 5 + serial number (6 digits in total) in CCI, or specify the serial number only (5 digits in total) in Device Manager - Storage Navigator.
- When the remote storage system is VSP G1x00 or VSP F1500, specify 3 + serial number (6 digits in total) in CCI, or specify the serial number only (5 digits in total) in Device Manager - Storage Navigator.

- c. For **Remote CU**, select the secondary system's CU number in a range from 00 to FE.
- d. For **SSID**, select the secondary system's SSID. The range is from 0004 to FEFF. If two or more valid SSIDs display, the - button is available. Clicking deletes the SSID text box.

You can add or remove an SSID whenever necessary. The maximum is four.

7. In the **Remote Paths** box, specify the following:

- a. For **Minimum Number of Paths**, select the minimum number of paths between the remote storage and local storage system. If the number of paths drops below the minimum, the local storage system splits the pair. The range is 1-8, and the default is 1.
- b. In the path ports boxes, select the ports used by the remote path. You can add more remote paths by clicking the **Add Path** button. See [Configuring additional remote paths \(on page 148\)](#) for more information.



**Note:** Set 1 for Minimum Number of Paths if the local storage system has a TrueCopy for Mainframe pair that contains critical data for disaster recovery. By setting 1, you can continue TrueCopy for Mainframe operation even when there is only one path to the remote storage system.

To maintain high performance operation in the local storage system, set 2 or a greater value (8 as the maximum number of paths for a path group) for Minimum Number of Paths.

If the number of paths goes below the minimum number of paths and the TrueCopy for Mainframe pair is split, deciding whether to fence the P-VOL of the pair (to reject all write I/Os) is determined according to the primary volume fence level.

8. In **Select Type**, select the port type.
9. Select the port to use for the local storage system and the remote storage system.
10. Click **Options** to access additional settings, which are optional.
  - a. For **RIO MIH Time**, enter an interval in seconds that, if exceeded, causes the data-transfer operation to be reported as failed by the system.  
The range is 10-100 seconds, and the default is 15. RIO MIH (remote I/O missing interrupt handler) time is the waiting time from when copy starts until when it ends. This value applies to the slots which received the request of copying data between storage systems.
  - b. For **Round Trip Time**, enter a time limit for data copy from P-VOL to S-VOL in ms. The range is 1-500 ms, and the default is 1.
  - c. For **FREEZE Option, Enable or Disable CGROUP (FREEZE/RUN) PPRC TSO command support**.
    - This option enabled also requires the PPRC Support by Host option to be enabled. See [Setting the remote replication options \(on page 115\)](#).
    - Make sure remote paths are added before enabling this option.
11. Click **Finish**.
12. In the **Confirm** window, review the settings and enter a task name in the **Task Name** box.
13. Click **Apply** to save your settings.

If you selected **Go to tasks window for status**, the **Tasks** window is displayed.

## Setting the remote replication options

You can set storage system and CU options for Maximum initial copy activities, Blocked path monitoring, Blocked path SIM monitoring, Services SIM of remote copy, and PPRC support.



**Note:** If iSCSI is used in a remote path, the blocked path monitoring remote replica option must be set to at least 40 seconds (default). If blocked path monitoring is less than 40 seconds, the path might be blocked due to a delay in the network such as many switches in a spanning tree protocol (STP) network or a long distance connection.

### Before you begin

You must have the role of Storage Administrator (Remote Copy).

### Procedure

1. Open the **Replication** window.
  - a. Click **Storage Systems**, and then expand the Storage Systems tree.
  - b. In the Storage Systems tree, click **Replication**.
2. In the **Replication** window, click **Edit Options > Remote Replication**.
3. In the **Edit Remote Replica Options** window, for **Copy Type**, select **TC** or **TC/TCMF**.

This wizard lets you edit one or more properties. Enter the new value and click Finish to confirm.

Copy Type: TC/TCMF

Storage System Options:

Maximum Initial Copy Activities: 64 (1-512)

Blocked Path Monitoring: 40 Second(s) (2-45)

Blocked Path SIM Monitoring: 70 Second(s) (2-100)

Services SIM of Remote Copy:  Report  No Report

CU Options:

Maximum Initial Copy Activities:  Enable  Disable

CU	Maximum Initial Copy Activities	PPRC Support	Services SIM
00	-	No	No Report
01	-	No	No Report
02	-	No	No Report
03	-	No	No Report
04	-	No	No Report
05	-	No	No Report
06	-	No	No Report
07	-	No	No Report
08	-	No	No Report
09	-	No	No Report

Change CU Options Selected: 0 of 255

Back Next Finish Cancel ?

4. Change **Storage System Options** as needed. Settings apply to the storage system.
  - a. For **Maximum Initial Copy Activities**, specify the number of volumes to be copied concurrently per initial copy operation.

The range is from 1 to 512 volumes. The default is 64. The default setting might not limit the impact on performance, depending on your number of data paths, pairs, and so on. You should consider these factors when making a selection. When you change the maximum initial copy activities setting, the new setting applies to pairs created or resynchronized after the setting was changed, not to existing pairs.

If the value is too large, the number of pending processing in a remote storage system increases, and the response time of a remote I/O for the update I/O might be affected. For example, if you set 64 for **Maximum Initial Copy Activities**, and register 65 TrueCopy for Mainframe pairs, the local storage system starts creating the 64 pairs first. It does not start creating the 65th pair before one of the pairs is synchronized.

- b. For **Blocked Path Monitoring**, enter the number of seconds for the system to monitor blocked paths. The range is 2-45 seconds, and the default is 40.  
If all paths become monitored because of path error, an MIH may occur in the host. Therefore, the time you specify must be less than the host's MIH timer setting.
  - c. For **Blocked Path SIM Monitoring**, enter the number of seconds for the system to monitor SIMs reported for blocked paths. The range is from 2 to 100 seconds.
  - d. For **Services SIM of Remote Copy**, specify whether or not services SIMs in the remote CU are reported to the host.
5. Change **CU Options** as needed. Settings apply to the selected CU only.
    - a. For **Maximum Initial Copy Activities**, select one of the following:
      - **Enable** to enable and set or reset the maximum number of initial copies.
      - **Disable** to place no restriction on number of initial copies and rely only on the Initial Copy Priority setting in the Create Pairs wizard.
    - b. Select the **CU** with the options to be changed, and then click **Change CU Options**. If you do not want to change CU options, click **Finish**.
    - c. In the **Change CU Options** dialog box, for **Maximum Initial Copy Activities**, specify the number of volumes to be copied concurrently per initial copy operation for the CU. The range is from 1 to 16 volumes.  
This option is available only when **Maximum Initial Copy Activities** is **Enable**.
    - d. For **PPRC support by host**, specify whether to create sense information having compatibility with IBM<sup>®</sup> PPRC.
      - When you change the PPRC support option for the P-VOL, the pair split/resync operations are unnecessary.
      - When changing PPRC support option for the S-VOL, change the option in the primary storage system and then split and resync the pairs.
    - e. For **Services SIM of Remote Copy**, specify whether or not services SIMs in the remote CU are reported to the host.
    - f. Click **OK**.
  6. In the **Edit Remote Replica Options** window, click **Finish**.
  7. In the **Confirm** window, review the settings and enter a task name in the **Task Name** box.
  8. Click **Apply** to save your settings.

## Changing the SCP time

The SCP (state change pending) time is the interval that I/O from the host is suspended. Because the SCP time is shared between TrueCopy for Mainframe and Compatible FlashCopy<sup>®</sup> V2, make sure to take into account the amount of time required by both products when setting the value.

### Procedure

1. In Hitachi Command Suite:

- a. On the **Resources** tab, expand the Storage Systems tree, right-click the target storage system and click **Replication Dashboard**.
- b. In the **Replication** window, click **Edit Options > SCP Time**.

In Device Manager - Storage Navigator:

- a. Click **Storage Systems**, and then expand the Storage Systems tree.
- b. In the Storage Systems tree, click **Replication**.
- c. In the **Replication** window, click **Edit Options > SCP Time**.

2. In the **Edit SCP Time** window, select the CU with the SCP time to be changed, and then click **Change SCP Time**.

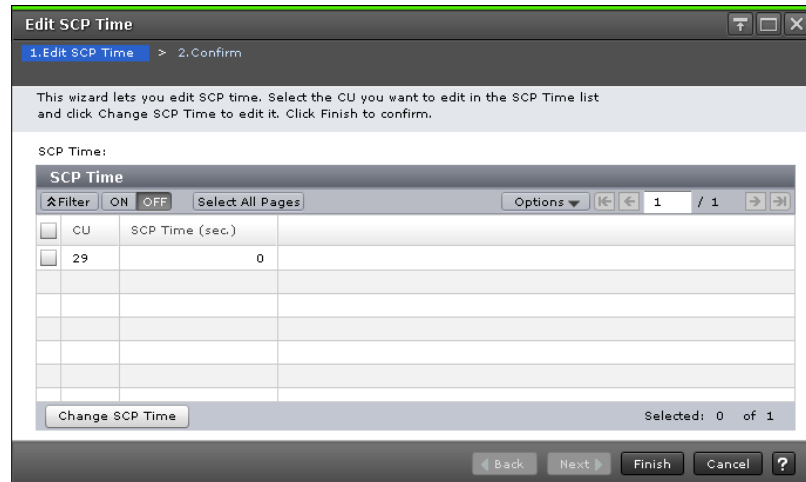

3. In the **Change SCP Time** window, enter the new SCP time. The range is from 0 to 518,400 seconds.

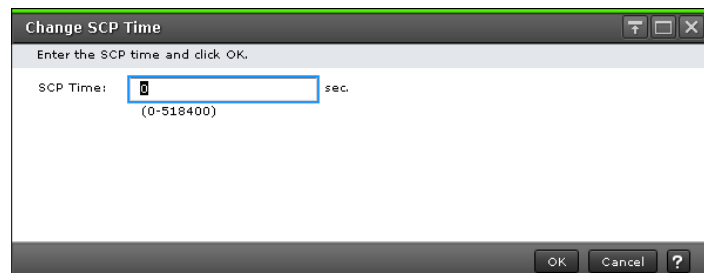

4. Click **OK**.
5. In the **Edit SCP Time** window, click **Finish**.
6. In the **Confirm** window, review the settings and enter a task name in the **Task Name** box.
7. Click **Apply** to save your settings.

## Completing SIMs for TCz

When the cause of a SIM for TCz has been resolved, you need to complete the SIM by using the Complete SIMs (TC) window. Completing the SIM changes the SIM status to Completed and removes the SIM alert from the header of the Device Manager - Storage Navigator window.



**Note:** Performing this task completes all uncompleted SIMs for both TC and TCz operations. If the cause of any of the SIMs has not been resolved, new SIMs will be issued.

### Before you begin

- Required role: Storage Administrator (System Resource Management)

### Procedure

1. Resolve the cause of the SIM.
2. Open the **Complete SIMs (TC)** window.

In Device Manager - Storage Navigator:

- a. From the Device Manager - Storage Navigator menu, click **Actions**.
- b. Click **Remote Replication > Complete SIMs (TC)**.

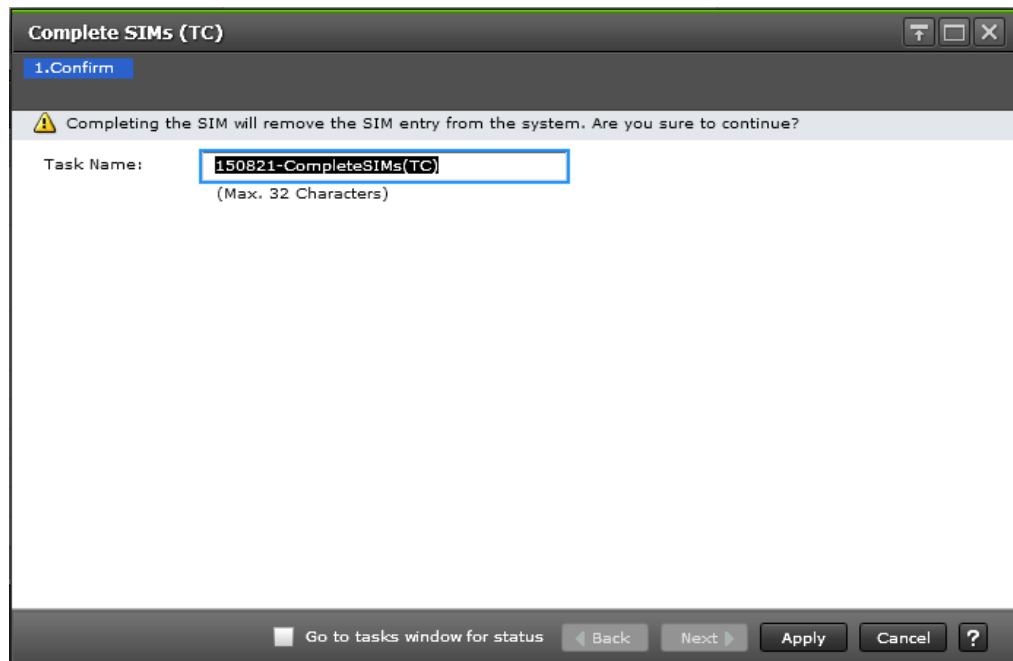

3. If desired, select **Go to tasks window for status**.
4. Click **Apply**.

If you selected **Go to tasks window for status**, the **Tasks** window is displayed.



---

## Chapter 6: TCz pair operations

You perform different tasks on TrueCopy for Mainframe pairs in day to day operations as a Storage Administrator.

### Pair operations workflow

You must have Storage Administrator (Remote Copy) role to perform TrueCopy for Mainframe operations.

Basic TrueCopy for Mainframe operations consist of the following operations.

- Check prerequisites for each procedure.
- Always check pair status. Each TrueCopy for Mainframe operation requires the pair to be in a specific status.
- Create a pair, in which the S-VOL becomes a duplicate of the P-VOL.
- Split a pair, which separates the P-VOL and S-VOL and allows read/write access to the S-VOL if desired.
- Resynchronize a pair, in which the S-VOL again mirrors the on-going, current data in the P-VOL.
- Delete a pair.

Disaster recovery procedures are discussed in [Disaster recovery \(on page 160\)](#).



#### Note:

- Pair operations cannot be performed when changing the firmware, nor if firmware changes are cancelled. If you start a firmware change, make sure it is complete before performing pair operations.
- When any of the following conditions occur during TCz pair duplication, sometimes the TCz pair splits to prioritize refresh I/O rather than TCz pair duplication.
  - The MP unit processor operation rate which the P-VOL belongs is 70% or higher in the primary system.
  - Refresh I/O inflow for the P-VOL is large in the primary system.
  - MP unit write-pending which S-VOL belongs is 65% or higher in the secondary system.

When creating or resynchronizing TCz pairs, be aware of the load of the storage systems at each site.

## Checking pair status

Every TrueCopy for Mainframe operation requires that the pairs have a specific status. Before performing any operation, check the pair status.

- The prerequisite information for each operation includes the pair status requirements for the operation.
- To view pair status or review status definitions, see [Monitoring pair status and license capacity \(on page 131\)](#).

## Creating pairs

You create TrueCopy pairs to maintain an up-to-date copy of data in a volume.

When you create a pair, the initial copy operation copies all data in the P-VOL to the S-VOL. The P-VOL remains available to the host for I/O operations during the initial copy operation.

You can perform this task using the **YKMAKE** command. For details see the BCM documentation.

### Before you begin

- Required role: Storage Administrator (Remote Copy)
- Required status: Both volumes must be simplex (unpaired).
- The initial copy must be performed from the primary system.
- S-VOLs must be offline to all hosts.
- Ports must be configured for TrueCopy for Mainframe. See [Defining port attributes \(on page 111\)](#) for more information.
- The primary and secondary systems must be configured for TrueCopy for Mainframe. See [Adding remote connections \(on page 113\)](#) for more information.
- The logical devices on the primary and secondary storage systems must be defined and formatted prior to pairing.
- The P-VOL capacity and S-VOL capacity must be the same (same number of cylinders). To view the capacity in cylinders, click Options > Capacity Unit > Cyl in the **Logical Devices** window. If the capacity is displayed in GB or TB, a slight difference in P-VOL and S-VOL capacity might not be displayed.
- Stop Performance Monitor before the initial copy to avoid overloading with TCP/IP traffic.
- During this operation, you select P-VOLs and S-VOLs by CU and/or LDEV numbers.
- During this operation, you can specify multiple P-VOLs to be paired, but only one S-VOL. To plan how the system assigns subsequent S-VOLs, see [Pair volume requirements and recommendations \(on page 68\)](#).

- During this operation, you can specify whether to fence the P-VOL when an error occurs. This is discussed in detail in [Allowing I/O to the P-VOL after a split: Fence Level options \(on page 72\)](#).
- During this operation, you can specify the priority for initial copy operations. When performing more initial copy operations than specified for Maximum Initial Copy Activities (during configuration), see [Initial copy priority option and scheduling order \(on page 75\)](#).

## Procedure

1. Click **Storage Systems**, and then expand the Storage Systems tree.
2. In the Storage Systems tree, click **Replication > Remote Replication**.
3. In the **Remote Replication** window, select the **TC Pairs** tab and click **Create TC Pairs**.
4. In the **Create TC Pairs** window, for **Copy Type**, select **TrueCopy for Mainframe**.

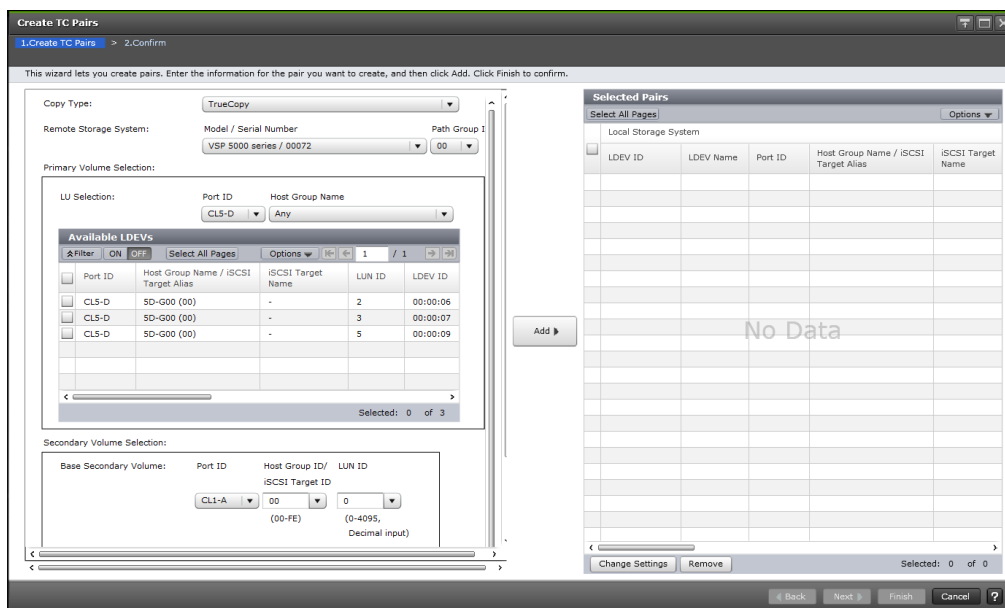

5. For **Local CU**, select the primary system's CU number (00 to FE).
6. For **Remote Storage System**, select the following:
  - The **Model/Serial Number** of the secondary system.
  - The **CU/SSID** of the secondary system, if a CU number is selected for Local CU.
7. In the **Primary Volume Selection** box, volumes that can be used as P-VOLs display in the **Available LDEVs** table. No action is required at this time.
8. In the **Secondary Volume Selection** box, specify the following:
  - a. For **Base Secondary Volume**, select the initial S-VOL's **CU** number and **LDEV** number. If you are selecting only one P-VOL, this LDEV is the secondary volume. If you select multiple P-VOLs for pairing, this LDEV is the base S-VOL that is assigned to the first P-VOL and from which subsequent S-VOL LDEVs are assigned to the list of P-VOLs.

- b. For **Selection Type**, select the method for assigning S-VOLs when multiple primary volumes are selected.
    - For **Interval**, specify an interval the system skips between secondary system LDEV numbers.
    - For **Relative Primary Volume**, the system assigns secondary system LDEV numbers based on proximity to P-VOL LDEV numbers.
9. Click **Options** to define the following optional settings:
- a. For **Primary Volume Fence Level**, specify whether the primary system allows or rejects write operations to the P-VOL when the pair is split due to an error.
    - **Data**: The P-VOL cannot be written to.
    - **Status**: The P-VOL can be written to if the primary system can change the S-VOL status to Suspend. If the primary system is not able to change the S-VOL status to Suspend, the P-VOL cannot be written to.
    - **Never**: The P-VOL can always be written to.
  - b. For **Initial Copy Type**, specify whether to copy data from P-VOL to S-VOL during the operation.
    - **Entire Volume** creates the pair and copies data to the S-VOL. (Default).
    - **None** creates the pair but data is not copied to the S-VOL. This requires that data in the P-VOL and S-VOL are already identical.
  - c. For **Copy Pace**, specify the number of tracks to be copied per remote I/O during the operation. The default is 15 (fast copy pace). To change the copy pace, specify 3 or 15. This option affects performance as follows:
    - The speed of 3 is a slow copy pace, and is used to reduce impact on host I/O.
    - The speed of 15 is a fast copy pace, and the host I/O performance might be degraded.
  - d. For **Initial Copy Priority**, specify the scheduling order for the initial copy operation. The range is 1-256, and the default is 32.  
 If you perform initial copy operation over the number of times set for **Maximum Initial Copy Activities** in the **Edit Remote Replica Options** window, you can set the order (priority) for the additional initial copy operations.  
 The initial copy priority is determined within the range of the number of initial copy operations performed concurrently. Because of this, the additional initial copy operations are not performed until the first batch completes.  
 If a time-out error occurs during this operation, the order specified in **Initial Copy Priority** may not run as expected. A time-out error can occur because of the CU configuration or data path error. Review the error, delete the pair with an error, and then retry the operation.
  - e. For **CFW Data**, specify whether CFW (DASD fast write) data is copied to the S-VOL.
    - **Primary Volume Only**: CFW data is not copied to the S-VOL.
    - **Secondary Volume Copy**: CFW data is copied to the S-VOL.



**Note:** Do not specify **Primary Volume Only** if system option mode (SOM) 1091 is ON. If you do, I/O to the S-VOL might terminate abnormally. For details, contact customer support.

- f. For **DFW to Secondary Volume**, specify whether the primary system splits the pair in the event that the secondary system cannot copy DFW data to the S-VOL.

- **Require:** The pair is split.

- **Not Require:** The pair is not split.

The interaction of DFW required and the P-VOL fence level setting can cause a host application to fail with a permanent I/O error when attempting to update a P-VOL. Keep track of which pairs have the DFW required setting, and make sure that DFW to the S-VOL is not blocked.

If a TCz pair is established using PPRC commands, the DFW to Secondary Volume option is set to the **DFW not required** setting.

- g. For **Host I/O Time Stamp Transfer**, specify whether the host I/O time stamp is transferred from P-VOL to S-VOL. **Enable** transfers, **Disable** does not transfer. The default is **Disable**.

10. Back again in the **Primary Volume Selection** box, select the primary volume to be copied first and click **Add**. The volume and pair information moves to the **Selected Pairs** table.

In the **Selected Pairs** table, you can change pair options by selecting it and clicking **Change Settings**. Remove a pair by selecting it and clicking **Remove**.

11. Click **Finish**.
12. In the **Confirm** window, review the settings and enter a task name in the **Task Name** box.
13. Click **Apply** to save your settings.

## Splitting pairs

You split TrueCopy pairs when you migrate data, when you recover data, or when you perform tasks on TrueCopy pairs, like assigning pairs to consistency groups.

Splitting pairs suspends data copying to the S-VOL.

When you split a pair, the following occurs:

- I/O writes from the host continue to the P-VOL, but stop to the S-VOL.
- Any current update copy operation completes to the S-VOL, ensuring data consistency to the point of the split operation.
- Pair status changes to Suspend.
- The primary system records the updated tracks to the P-VOL that occur after the split as differential data. This data is copied to the S-VOL when the pair is resynchronized.
- To access an S-VOL of which write option is enabled, the pair must be split.

- When a pair is split, the secondary storage system completes pending copy operation before changing the pair status to ensure pair synchronization.
- You can set an option to block updates to the P-VOL while the pair is split. This results in the P-VOL and S-VOL staying synchronized.
- Another option is to enable system write to the S-VOL from a host. The secondary system records the updated tracks as differential bitmaps. When the pair is resynchronized, the secondary system sends the differential bitmaps to the primary system, which merges all differential bitmaps to determine which tracks are out-of-sync.

### Before you begin

- Required role: Storage Administrator (Remote Copy)
- Required status: Pair status must be Pending or Duplex

### Procedure

1. Click **Storage Systems**, and then expand the Storage Systems tree.
2. In the Storage Systems tree, click **Replication > Remote Replication**.
3. In the **Remote Replication** window, click the **TC Pairs** tab, and then select the pair to be split.
4. In the **TC Pairs** tab, click **Split Pairs**.
5. In the **Split Pairs** window, ensure that the pair to be split appears in the **Selected Pairs** table.

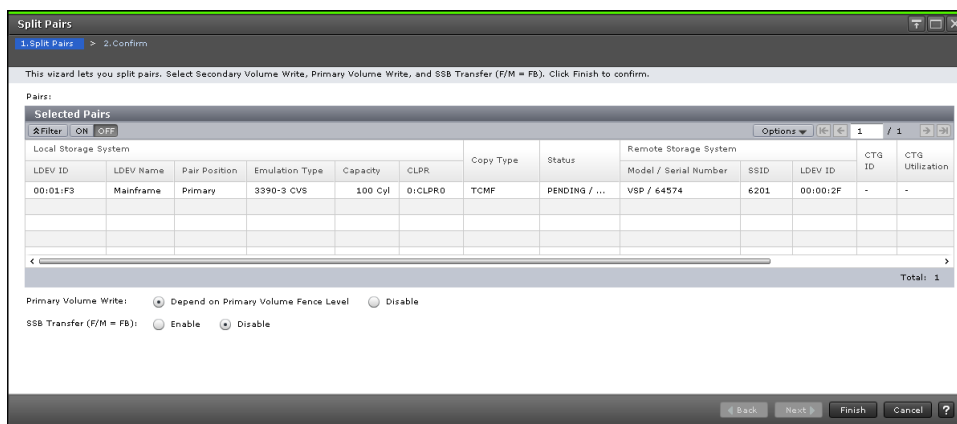

6. For **Primary Volume Write**, specify whether writing to the P-VOL is enabled while the pair is split.
  - **Depends on Primary Volume Fence Level:** Writing to the P-VOL is based on fence level specified during the Create Pairs operation. This is the default.
  - **Disable:** Write I/Os to the P-VOL are rejected regardless of the fence level. Select this option to maintain synchronization of the P-VOL and S-VOL. Do not select this option if the P-VOL is necessary for host system operations.

Disable is only available when performing the split operation from the pair's primary storage system.



**Note:** When the pair must be split and its P-VOL is required for system operations, you must select **Depends on Primary Volume Fence Level**, so that the P-VOL continues to accept I/Os.

- For **SSB Transfer (F/M=FB)**, specify **Enable** to report SSB (sense byte) to the host, or **Disable** to not report (default).

Enable is only available when performing the split operation from the pair's primary storage system.

When SSB Transfer (F/M=FB) is enabled and PPRC Support By Host = Yes (Change CU Options window), the primary system reports the SSB to the all connected hosts ("F/M" means, "Format/Message"). This option must always be enabled.

If PPRC Support By Host = No, the x'FB' sense information will be reported to the host, even if the SSB (F/M=FB) suspend option is enabled.

- Click **Finish**.
- In the **Confirm** window, review the settings and enter a task name in the **Task Name** box.
- Click **Apply** to save your settings.

After the pair is split, make sure that the TrueCopy for Mainframe pair is displayed correctly (in the Suspend status) in the **Remote Replication** window.

To check the pair split operation status, click the update button at the upper right corner of the Device Manager - Storage Navigator main window to update the information in the **Remote Replication** window, or view the detailed status information in the **View Pair Properties (Remote)** window.

## Resynchronizing pairs

You resynchronize TrueCopy pairs when you recover data from a disaster or when you perform tasks on TrueCopy pairs, like assigning pairs to consistency groups.

While a TrueCopy for Mainframe pair is split, the primary system does not perform update copy operations to the S-VOL. Resynchronizing the pair updates the S-VOL with differential data accumulated since the split, so that its data is again identical with the P-VOL's data. Update copy operations begin again to the S-VOL.

You can perform this task using the **YKRESYNC** command. For details, see the BCM documentation.

### Before you begin

- Required role: Storage Administrator (Remote Copy)
- Required status: Both volumes must be suspended (Suspend).
- This operation is performed from the primary system only.

### Procedure

- Click **Storage Systems**, and then expand the Storage Systems tree.
- In the Storage Systems tree, click **Replication > Remote Replication**.

3. In the **Remote Replication** window, click the **TC Pairs** tab, and then select the pair to be resynchronized.
4. In the **TC Pairs** tab, click **Resync Pairs**.
5. In the **Resync Pairs** window, ensure that the pair to be resynchronized appears in the **Selected Pairs** table.

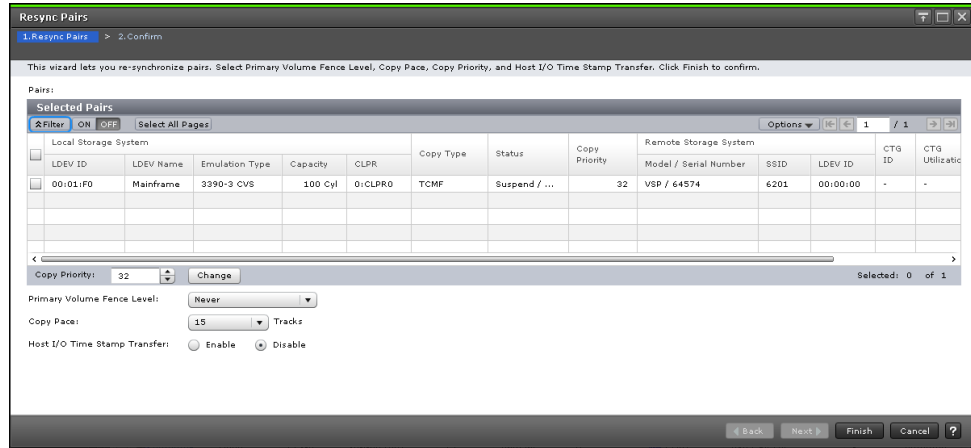

6. For **Primary Volume Fence Level**, specify whether the primary system rejects write operations to the P-VOL when the pair is split due to an error.

- **Status:** The P-VOL cannot be written to only if the primary system is not able to change S-VOL status to Suspend.
- **Never:** The P-VOL can always be written to.
- **Data:** The P-VOL cannot be written to when the update copy fails.

For more information, see [Allowing I/O to the P-VOL after a split: Fence Level options \(on page 72\)](#).

7. For **Copy Pace**, specify the number of tracks to be copied per remote I/O during the operation. The default is 15 (fast copy pace). To change the copy pace, specify 3 or 15. This option affects performance as follows:
  - The speed of 3 is a slow copy pace, and is used to reduce impact on host I/O.
  - The speed of 15 is a fast copy pace, and the host I/O performance might be degraded.
8. For **Copy Priority**, enter the priority, or scheduling order, for the resync operation. You can set priority from 0 to 256. The default is 32. For details about priority, see [Initial copy priority option and scheduling order \(on page 75\)](#).
9. For **Host I/O Time Stamp Transfer**, specify whether the host I/O time stamp is transferred from P-VOL to S-VOL. **Enable** transfers, **Disable** does not transfer. The default is **Disable**.
10. Click **Finish**.
11. In the **Confirm** window, review the settings and enter a task name in the **Task Name** box.



12. Click **Apply** to save your settings.

After the pair is resynchronized, make sure that the TrueCopy for Mainframe pair is displayed correctly (in the PAIR status) in the **Remote Replication** window.

To check the pair resynchronization operation status, click the update button at the upper right corner of the Device Manager - Storage Navigator main window to update the information in the **Remote Replication** window, or view the detailed status information in the **View Pair Properties** window.

## Deleting pairs

You delete a TrueCopy for Mainframe pair when you no longer need an up-to-date remote copy of the data or if you are recovering data from a disaster.

Deleting a TrueCopy for Mainframe pair deletes the TCz relationship, but not the volumes or their data. The following happens when you delete a TrueCopy for Mainframe pair:

- When it is no longer necessary to maintain a remote copy of the P-VOL, delete a pair from the primary system only. All update operations are stopped and pair status for both the P-VOL and S-VOL changes to unpaired.

When a pair is deleted, the primary system continues to accept write I/O to the former P-VOL but does not keep track of the updates.

- Delete a pair from the secondary system only for disaster recovery purposes. When you do this, the secondary system changes the S-VOL pair status to unpaired, the primary system detects that the S-VOL status is unpaired and then changes the P-VOL status to Suspend-delete pair to RCU.

The CDELPAIR TSO command can be used to delete pairs from the primary system.

To restart a pair that was deleted from the secondary system, you must delete the pair from the primary system and then create the pair from the primary system.



**Note:** When you delete a pair from the secondary system, make sure that the S-VOL and P-VOL are identical, including the volume labels. Take all necessary steps to prevent system problems due to duplicate volumes.

You can perform this task using the **YKDELETE** command. For details, see the BCM documentation.

### Before you begin

- Required role: Storage Administrator (Remote Copy)

### Procedure

1. Click **Storage Systems**, and then expand the Storage Systems tree.
2. In the Storage Systems tree, click **Replication > Remote Replication**.
3. In the **Remote Replication** window, click the **TC Pairs** tab, and then select the pair or pairs to be deleted.
4. In the **Delete Pairs** window, ensure that the pairs to be deleted appear in the **Selected Pairs** table.

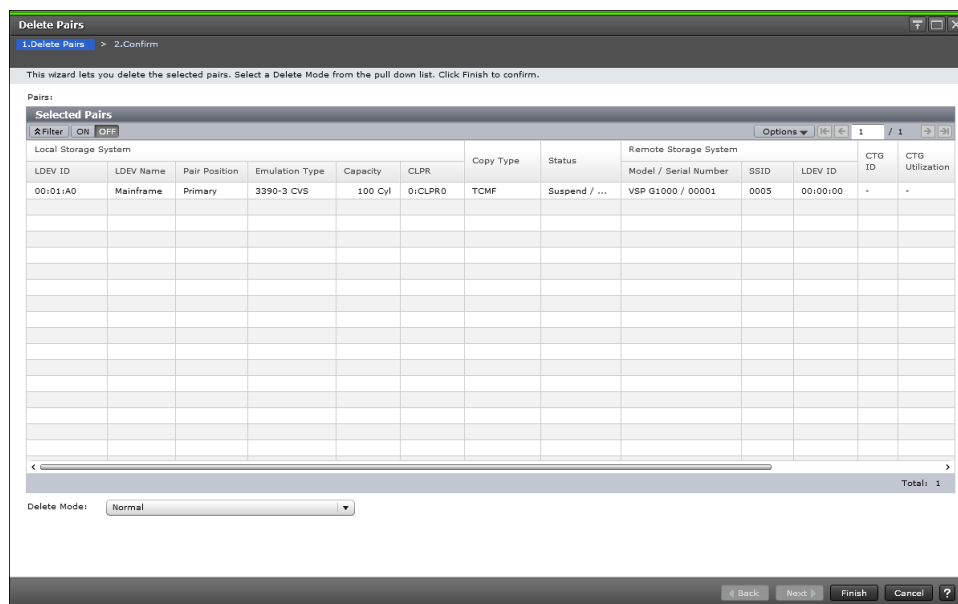

5. For **Delete Mode**, specify one of the following:
  - **Normal**: Deletes the pair only if the primary system can change both P-VOL and S-VOL to unpaired volumes.
  - **Force**: Forcibly deletes pairs even when the primary system cannot communicate with the secondary system.
 

Releases the host waiting for the I/O completion signal from the local storage system which cannot communicate with the remote storage system, and then allows host operations to continue. Force allows host operations to continue.
  - **Force (All pairs in the same remote connections)**: Deletes forcibly all pairs using the same remote connection.
6. Click **Finish**.
7. In the **Confirm** window, review the settings and enter a task name in the **Task Name** box.
8. Click **Apply** to save your settings.

After the pair is deleted, make sure that the TrueCopy for Mainframe pair is not displayed in the **Remote Replication** window.

To check the pair deletion operation status, click the update button at the upper right corner of the Device Manager - Storage Navigator main window to update the information in the **Remote Replication** window, or view the detailed status information in the **View Pair Properties (Remote)** window.

---

## Chapter 7: Monitoring and maintaining the TCz system

You perform some maintenance tasks in response to conditions discovered during system monitoring. You can also change certain settings as needed to meet changing operational requirements.

### Monitoring pair status and license capacity

You should monitor the TrueCopy for Mainframe system frequently to keep track of and maintain the copy pairs.

The following are a couple of examples of when you would check the status of a pair:

- Check the status before performing a pair operation. Each operation requires a specific status or set of statuses.
- Check status to see that pairs are operating correctly and that data is updated from P-VOLs to S-VOLs in Duplex status, or that differential data management is performed in Split status. Pair status changes when an operation is performed.

You can check the TC pair status by Business Continuity Manager (BCM) or HDvM - SN. Monitoring should be repeated frequently. Email notifications of problems can be set up using HDvM - SN or Maintenance Utility.

You can perform this task using the **YKQUERY** command. For details, see the BCM documentation.

#### Procedure

1. Click **Storage Systems**, and then expand the Storage Systems tree.
2. In the Storage Systems tree, click **Replication > Remote Replication**.
3. In the **Remote Replication** window, click the **TC Pairs** tab, and then locate the pair volume with the status you want to review.
4. In the **TC Pairs** tab, click **More Actions > View Pair Properties** and review **Status**.

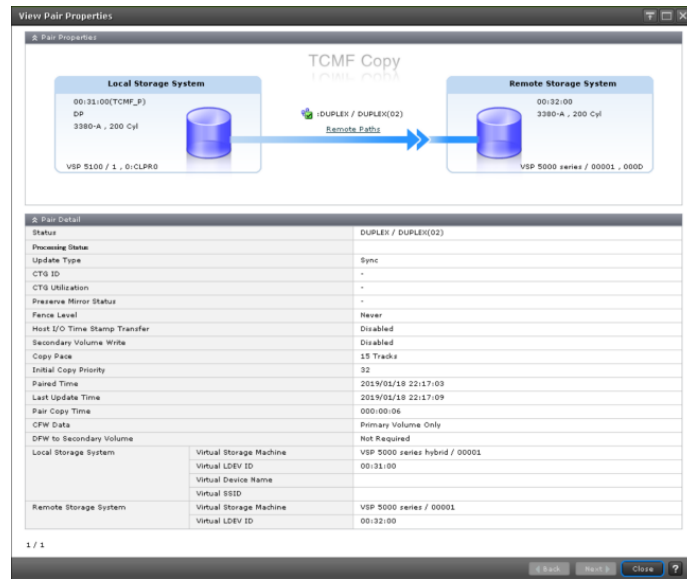

For more information, see [Pair status definitions \(on page 133\)](#).

### Next steps

To monitor license capacity, see the Summary area in the **Replication** window.

## How pair status changes

The primary system changes and maintains the status of the P-VOL and is responsible for keeping the P-VOL and its S-VOL synchronized. The secondary system maintains the status of the S-VOL.

- The primary system can change the status of the P-VOL and S-VOL.
- The secondary system can change the status of the S-VOL but not the P-VOL. When an operation is performed from the secondary system, the primary system detects a status change in the S-VOL and then changes the P-VOL status accordingly.
- The status indicates the state of the volume or pair:
  - When volumes are not assigned to TrueCopy, these are unpaired volumes (Simplex).
  - When an initial copy operation starts pair creation, the primary system changes the status of the P-VOL and S-VOL to Pending. When the initial copy operation is complete, the primary system changes the status of both volumes to Duplex.
  - When you split a pair, the system changes the status of the P-VOL and S-VOL to PSUS.
  - When a pair is suspended due to an error condition in the primary system, the primary system changes the P-VOL and S-VOL status to PSUE, if possible.
  - When a pair is deleted from the primary system, that system changes the status of the P-VOL and S-VOL to Simplex.
  - When a pair is deleted from the secondary system, that system changes the S-VOL status to Simplex, and the primary system detects the pair release (when the path is in normal status) and changes the P-VOL status to PSUS.



## Pair status definitions

Both Device Manager - Storage Navigator and Business Continuity Manager pair status names appear in the Status column, except when the names are the same. When they are the same, the Business Continuity Manager (BCM) status does not appear.

The following table shows both types of status names and their descriptions. In some cases, a particular status has no exact parallel status in the other interface. This is noted.

When checking the pair status, click **Refresh** to display the latest information. The P-VOL access and S-VOL access columns in the following table indicate whether the volumes accept read/write.

(For CCI status names, see [CCI pair status names \(on page 137\)](#).)

HDvM - SN status	BCM status	Description	P-VOL access	S-VOL access
Unpaired in HDvM - SN	SIMPLEX	This volume is not currently assigned to a TrueCopy for Mainframe pair.	Read/Write	Read/Write
 Pending*	PENDING (01)	The initial copy operation for this pair is in progress. This pair is not yet synchronized.	Read/Write	No
 Duplex	DUPLEX (02)	<ul style="list-style-type: none"> <li>▪ The pair is synchronized</li> <li>▪ Updates from the host to the P-VOL are duplicated in the S-VOL.</li> </ul>	Read/Write	No
 Suspend (See also <a href="#">Split types (on page 137)</a> .)	SUSPOP (03), SUSPOP (04), SWAPPING (04), SUSPOP (05), SUSPER (07), SUSPOP (0A)	<ul style="list-style-type: none"> <li>▪ The pair was split by a user.</li> <li>▪ The pair is not synchronized.</li> <li>▪ When you split the pair in the primary system, that system changes the status of the P-VOL and S-VOL to this status.</li> </ul>	Read/Write	Read Only if Mode=20 is ON, otherwise No.

HDvM - SN status	BCM status	Description	P-VOL access	S-VOL access
		<ul style="list-style-type: none"> <li>▪ In this status, updates to the S-VOL stop. The storage system keeps track of updates to the P-VOL in order to update the S-VOL when the pair is resynchronized.</li> <li>▪ When you split the pair in the secondary system, that system changes the status of the S-VOL to this status. The primary system detects this and changes the P-VOL to this status.</li> <li>▪ When you release the pair in the secondary system, that system changes the S-VOL status to Simplex . The primary system detects this and changes the P-VOL to this status. The pair must be released from the primary system in order to change P-VOL status to Simplex.</li> </ul> <p>BCM suspend statuses initiated by the user:</p> <ul style="list-style-type: none"> <li>▪ SUSPOP (03): The user suspended the pair from the P-VOL.</li> <li>▪ SUSPOP (04): The user suspended the pair from the S-VOL. If the P-VOL is updated, it is recorded as differential data.</li> </ul>		

HDvM - SN status	BCM status	Description	P-VOL access	S-VOL access
		<ul style="list-style-type: none"> <li>▪ SWAPPING (04): The user suspended the pair in the reverse direction (S-VOL to P-VOL).</li> <li>▪ SUSPOP (05): The secondary system received a split request from the primary system and suspended the pair.</li> <li>▪ SUSPER (07): The user deleted the pair from the secondary system. The primary system detected this and suspended the P-VOL.</li> <li>▪ SUSPOP (0A): The pair was suspended because the user issued PPRC's FREEZE command on the primary system.</li> </ul>		
 Suspend (See also <a href="#">Split types (on page 137)</a> .)	SUSPCU (06) (by error), SUSPCU (08), SUSPER (09), SUSPER (50)	<ul style="list-style-type: none"> <li>▪ The primary or secondary system splits the pair due to an error.</li> <li>▪ If the primary system cannot keep the pair synchronized for any reason, it changes the status of the P-VOL and S-VOL (if possible) to this status.</li> <li>▪ The pair is not synchronized.</li> <li>▪ CCI PSUE indicates that although the paired status is retained, updates to the S-VOL is sopped due to an error status. CCI PSUE is PSUS (SSUS) caused by an internal error.</li> </ul>	Read/Write.  Read only if Primary Volume Fence Level is Data.	Read Only if Mode=20 is ON, otherwise No.

HDvM - SN status	BCM status	Description	P-VOL access	S-VOL access
		<p>BCM also includes the following:</p> <ul style="list-style-type: none"> <li>▪ SUSPCU (08): The pair was suspended when the primary system detected an error during the communication with the secondary system, or detected an I/O error during update copy.</li> <li>▪ SUSPER (09): The pair was suspended because the primary system detected volatilization of pair control information on memory when power was ON (IMPL). This error occurs when power-off status of the primary system continues beyond the backup time for the nonvolatile memory.</li> <li>▪ SUSPER (50): The pair was suspended because data mismatch between P-VOL and S-VOL was detected during the initial copy operation. The cause of the error is invalid track format.</li> </ul>		
-	SSWS	<ul style="list-style-type: none"> <li>▪ CCI SSWS status indicates that the pair status is retained. The P-VOL and the S-VOL of the pair is switched and then they are resynchronized (horctakeover).</li> </ul>		



HDvM - SN status	BCM status	Description	P-VOL access	S-VOL access
* When the pair status is Pending, neither cache nor shared memory can be added to or removed from the storage system. When either of these tasks is to be performed, wait until the pair status changes to Duplex, or split the TC pair, and then resynchronize when the cache or shared memory operation is completed.				

## CCI pair status names

CCI pair status names are different than Device Manager - Storage Navigator status names. The following shows the corresponding names.

Device Manager - Storage Navigator pair status name	CCI pair status name
Unpaired	SMPL
Pending	COPY
Duplex	PAIR
Suspend (by operation)	PSUS
Suspend (by error)	PSUE

## Split types

This topic discusses pairs that are split by user operation, and pairs that are suspended by the system because of failure.

- You can split a pair when the initial copy operation is complete.
  - You must split a pair to access a volume which has the Secondary Volume Write option enabled. TrueCopy for Mainframe pairs are also split when the CGROUP FREEZE command is processed.
  - To synchronize data of the primary and secondary sites after the split, complete the update copy operation before splitting a pair.
- Pairs are split by the primary system only, for any of the following reasons:
  - You released the pair from the secondary system.
  - An error condition related to the secondary system, the S-VOL, or an update-copy operation.
  - When the secondary system cannot run DFW (DASD fast write) to Secondary Volume (only when Required is selected for DFW to Secondary Volume option).
  - The primary system cannot communicate with the secondary system.

Split types appear in the Status field on the View Pair Properties window. The following table describes the split types. (CCI does not display split types.)

Split type			Volume applies to	Description
HDvM - SN	BCM	PPRC		
Primary Volume by Operator	SUSPOP(03)	SUSPEND(03)	P-VOL	The user operated the pair split from the primary system by selecting Disable for the Primary Volume Write field. The S-VOL split type is, "by Local Storage System".
Secondary Volume by Operator	SUSPOP(04) SWAPPING(04)	SUSPEND(04)	P-VOL S-VOL	The user operated the pair split from the primary or secondary system by selecting Disable for the Primary Volume Write field.
by Local Storage System	SUSPOP(05)	SUSPEND(05)	S-VOL	The secondary system received a request from the primary system to split the pair. The P-VOL split type is Suspend-Primary Volume by Operator or Suspend-Secondary Volume by Operator.
by Remote Storage System	SUSPCU(06)	SUSPEND(06)	P-VOL	The primary system detected an error condition at the secondary system (RCU), that caused the primary system to split the pair. The S-VOL split type is S-VOL Failure.
Delete pair to RCU	SUSPER(07)	SUSPEND(07)	P-VOL	The primary system detected that the S-VOL status changed to Simplex because the user released the pair from the secondary system. The pair cannot be resynchronized because the S-VOL does not have the Suspend status.
S-VOL failure	SUSPCU(08)	SUSPEND(08)	P-VOL	The primary system detected an error during communication with the secondary system, or an error during update copy. In this case, the S-VOL split type is usually S-VOL Failure. This split type is also used when the number of paths falls below the minimum number of paths setting on the Add Remote Connection window.

Split type			Volume applies to	Description
HDvM - SN	BCM	PPRC		
MCU IMPL	SUSPER(09)	SUSPEND(09)	P-VOL S-VOL	The primary system could not find valid control information in its nonvolatile memory during IMPL. This condition occurs only if the primary system is without power for more than 48 hours (that is, power failure and fully discharged backup batteries).
by FREEZE	SUSPOP(0A)	SUSPEND(0A)	P-VOL S-VOL	The pair was split by the CGROUP/FREEZE TSO command.
Initial copy failed	SUSPER(50)	SUSPEND(08)	P-VOL S-VOL	The pair was split before the initial copy operation was complete. The data on the S-VOL is not identical to the data on the P-VOL.

## System behavior

Note the following behaviors for split pairs:

- The primary system stops performing update operations to the S-VOL. It may or may not continue accepting write I/Os to the P-VOL depending on the P-VOL fence level setting and split option.
- If an update fails, the primary system reports a unit check and notifies the host that Write fails. This ensures that both the host system and application program regard the write operation to the P-VOL as failed.
- If the primary system accepts subsequent write I/Os for a split P-VOL, the system records the updated data in the P-VOL tracks as differential data. When a split pair is resynchronized, the primary system copies the out of sync P-VOL tracks to the S-VOL as differential data.
- TCz does not allow access to an S-VOL while the pair is split (when mode20=ON, Read access is accepted).
- When a pair is split, whether user requested or due to failure, the primary system generates sense information to notify the hosts. If the host system supports IBM® PPRC (and the "PPRC support by host" CU option is enabled), this notification results in an IEA494I and/or IEA491E system console message, which indicates the reason for suspension.

## Monitoring TCz pair synchronization rate

You can check on the percentage of synchronized data between the P-VOL and S-VOL.

**Procedure**

1. Click **Storage Systems**, and then expand the Storage Systems tree.
2. In the Storage Systems tree, click **Replication > Remote Replication**.
3. In the **Remote Replication** window, click the **TC Pairs** tab, and then select the pair whose rate you want to display.
4. In the **TC Pairs** tab, click **More Actions > View Pair Synchronization Rate**. Click **Refresh** to display the latest synchronization rate.

The screenshot shows a window titled "View Pair Synchronization Rate" with a "Pairs" tab. Below the tab is a table with the following columns: LDEV ID, LDEV Name, Pair Position, CLPR, Virtual Storage Machine, Virtual LDEV ID, Virtual Device Name, Virtual SSID, Copy Type, and Status. The table contains one row of data:

LDEV ID	LDEV Name	Pair Position	CLPR	Virtual Storage Machine	Virtual LDEV ID	Virtual Device Name	Virtual SSID	Copy Type	Status
00:20:00		Primary	0:CLPRO	VSP G1000 / 00002	00:20:00			TCMF	PENDING / ...

At the bottom of the window, there is a "Refresh" button and a "Total: 1" indicator.

## Monitoring TCz operations history

In HDvM - SN, you can review the history of operations for a pair, including the operation's description, date and time it took place, primary and secondary system information, and other details.

**Procedure**

1. Click **Storage Systems**, and then expand the Storage Systems tree.
2. In the Storage Systems tree, click **Replication**.
3. In the **Replication** window, click **View History > Remote Replication**.
4. In the **History** window, for **Copy Type**, select **TCMF**. The **Description** column displays operations, which are explained below.



Operation displayed	Description
Pair Add Start	Creation of the pair started.
Pair Add Complete	Creation of the pair completed.
Pair Delete	The pair was deleted.
Pair Suspend (Operation)	The pair was split.
Pair Suspend (Failure)	The pair was split (suspended) because of a failure.
Pair Resync. start	Resynchronization of the pair was started.
Pair Resync. Complete	Resynchronization of the pair was completed.

## Changing P-VOL fence level and CFW data

You can change the P-VOL's fence level, which specifies when to reject write operations to the P-VOL under certain failure circumstances. You can also change whether CFW (cache fast write) data is copied to the S-VOL.

For more information on fence levels, see [Allowing I/O to the P-VOL after a split: Fence Level options \(on page 72\)](#).

### Before you begin

- Required status: Both volumes must be Pending or Duplex.
- The **Edit Pair Options** window is used for the following procedure. If you select multiple pairs, the values do not display but are blank. When you change a value, the change applies to all selected pairs.

### Procedure

1. Click **Storage Systems**, and then expand the Storage Systems tree.
2. In the Storage Systems tree, click **Replication > Remote Replication**.
3. In the **Remote Replication** window, click the **TC Pairs** tab then select the pair whose options are to be changed.
4. In the **TC Pairs** tab, click **More Actions > Edit Pair Options**.
5. In the **Edit Pair Options** window, for **Primary Volume Fence Level** box, select the fence level for the pairs.
  - **Never:** The P-VOL can always be written to.
  - **Data:** The P-VOL cannot be written to.
  - **Status:** The P-VOL cannot be written to only if the primary system is not able to change S-VOL status to PSUE.

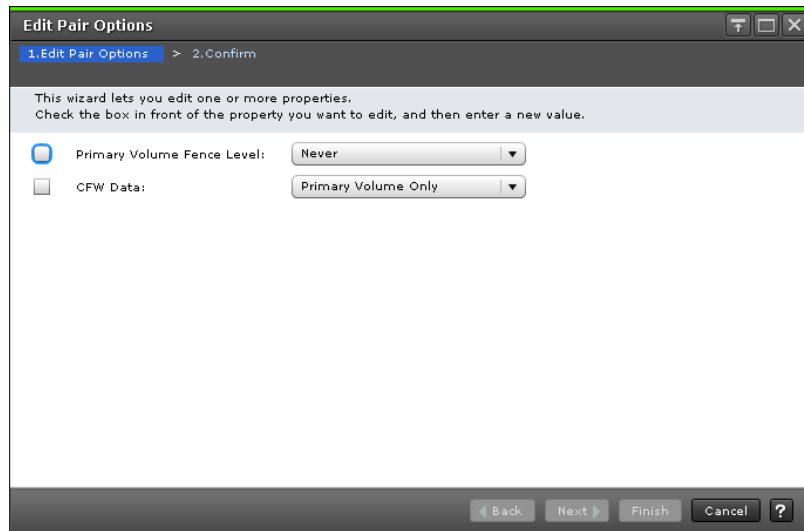

6. For **CFW Data**, select whether CFW data is copied to the S-VOL.
  - **Primary Volume Only**: CFW data is not copied to the S-VOL.
  - **Secondary Volume Copy**: CFW data is copied to the S-VOL.

**Note:**

- To apply the pair option that is set on the P-VOL to the S-VOL, split and then resynchronize the TCz pair.
- Do not specify **Primary Volume Only** if system option mode (SOM) 1091 is ON. If you do, I/O to the S-VOL might terminate abnormally.
- Do not set SOM 1091 to ON if you changed the CFW data setting after you created the TCz pair. If you do, I/O to the S-VOL might terminate abnormally.

For details about SOM 1091, contact customer support.

7. Click **Finish**.
8. In the **Confirm** window, review the settings and enter a task name in the **Task Name** box.
9. Click **Apply** to save your settings in the system.

## Forcibly deleting pairs

You forcibly delete a pair using HDvM - SN for the following reasons: A currently unpaired volume that was previously in a pair is unusable because previous pair information is still in the volume, or the pair cannot be connected to the remote storage system because of a communication error.

In the case of a communication error, delete the pair forcibly in both the local and the remote storage systems.





### Procedure

1. Click **Storage Systems**, and then expand the Storage Systems tree.
2. In the Storage Systems tree, click **Replication > Remote Replication**.
3. In the **Remote Replication** window, click **More Actions > Export**.
4. If necessary, follow instructions in online Help.

## Monitoring copy operations and I/O statistical data

In HDvM - SN, you can monitor copy operations and I/O statistical data.

For details, see the *Performance Guide*.

## Monitoring and maintaining remote connections and paths

You can access information about remote connections and paths to determine their status. This information is useful when you are diagnosing connectivity between the primary and secondary systems.

### Procedure

1. Click **Storage Systems**, and then expand the Storage Systems tree.
2. In the Storage Systems tree, click **Replication > Remote Connections**.
3. View connection properties and path information by clicking **View Remote Connection Properties** in the **Remote Connections** window.



Connection Type	Local CU	Remote Storage System	Path Group ID	Status	Number of Remote Paths
		Model / Serial Number CU SSID			
System	-	VSP G1000 / 00020 - -	00	Normal	1
CU	20	VSP G1000 / 00020 00 0820	-	Normal	1

## Remote path status definitions

You can understand the status of connections and paths better by knowing the definition of the status that you observe.

The following table provides remote path status descriptions.

Status	Definition
Normal	This path has been successfully established and can be used for TrueCopy for Mainframe remote copy activities.
Initialization Failed	The link initialization procedure with the secondary system has failed, because the physical path connection between either the primary and secondary system, or between the primary system and the host, was missing.
Communication Timeout	A timeout error has occurred between the primary and secondary system.
Path Rejected	The remote path link function has been rejected by the secondary system. All remote path resources in the secondary system might be used for other connections.
Serial Number Mismatch	The serial number of the control unit that is connected to this remote path does not match the serial number specified by the Add Remote Connection window.
Invalid Port Mode	The specified port does not have the initiator attribute.
RCU Port Number Mismatch	There are three possible causes: <ul style="list-style-type: none"> <li>The specified port in the secondary system is physically disconnected from the primary system.</li> <li>The port is not configured as an RCU target port.</li> <li>The specified port number is not available.</li> </ul>
RCU Port Type Mismatch	The microcode on the remote side does not support the fibre remote copy function, or the specified port type is not RCU target.

Status	Definition
Communication Failed	A timeout error has occurred on the path between the primary and secondary system.
Logical Blockade	This remote path was blockaded because a path error or a link error occurred continuously.
Program Error	This remote path was blockaded because a program error occurred.
In Progress	This remote path is in progress of changing the attribute of port.

## Configuring additional remote paths

You can configure additional remote paths as needed. A maximum of eight remote paths are supported.

### Before you begin

- Review path-related prerequisites.
- Required role: Storage Administrator (Remote Copy).

### Procedure

1. Click **Storage Systems**, and then expand the Storage Systems tree.
2. In the Storage Systems tree, click **Replication > Remote Connections**.
3. In the **Remote Connections** window, click the **Connections (To)** tab.
4. In the **Connections (To)** tab, select the remote connection where the remote path is to be added.
5. In the **Connections (To)** tab, click **More Actions > Add Remote Paths**.
6. In the **Add Remote Paths** window, add a new remote path by selecting ports for the primary (left side) and secondary systems. You can make multiple selections. To add paths, click **Add Path**.
7. Click **Finish**.
8. In the **Confirm** window, review the settings and enter a task name in the **Task Name** box.
9. Click **Apply** to save your settings in the system.

## Changing remote connection options

You can change remote connection options to optimize TrueCopy for Mainframe performance.

The following remote connection options affect how copy operations are performed:

- Number of minimum paths for a pair. You can find detailed information in [Minimum number of remote paths option \(on page 58\)](#)
- RIO MIH Time, which is the waiting time from when copy starts until when it ends. This value applies to the slots which received the request of copying data from the local storage system to the remote storage system.
- FREEZE option, which defines support for the CGROUP (FREEZE/ RUN) PPRC TSO command.
- Round trip time, which is the time limit for copying data to the S-VOL. For more information, see [Round trip time option \(on page 54\)](#).

### Before you begin

- Required role: Storage Administrator (Remote Copy).

### Procedure

1. Click **Storage Systems**, and then expand the Storage Systems tree.
2. In the Storage Systems tree, click **Replication > Remote Connections**.
3. Click the **Connections (To)** tab, and then select the remote connection whose options you want to change.
4. In the **Connections (To)** tab, click **Edit Remote Connection Options**.
5. In the **Edit Remote Connection Options** window, for **Minimum Number of Paths**, select the minimum number of paths between the secondary and primary system.

6. For **RIO MIH Time**, enter an interval in seconds that, if exceeded, causes the data-transfer operation to be reported as failed by the system.  
The RIO MIH Time is the waiting time from when copy starts until when it ends. This value applies to the slots which received the request of copying data from the local storage system to the remote storage system. The range is 10-100 seconds, and the default is 15.
7. For **Round Trip Time**, enter a time limit for data copy from P-VOL to S-VOL in ms. The range is 1-500 ms, and the default is 1.

8. For **FREEZE Option, Enable** or **Disable** CGROUP (FREEZE/RUN) PPRC TSO command support.
  - PPRC support by the host must be enabled to use this option.
  - Make sure remote paths are added before enabling this option.
9. Click **Finish**.
10. In the **Confirm** window, review the settings and enter a task name in the **Task Name** box.
11. Click **Apply** to save your settings in the system.

## Deleting remote paths

You can delete a remote path between a primary system and secondary system if you do not need that path.

### Before you begin

- Delete remote paths from the primary system.
- Make sure that the remaining number of paths is equal to or greater than the minimum number of paths setting on the **Add Remote Connection** window, otherwise the delete path operation will fail.
- Required role: Storage Administrator (Remote Copy).

### Procedure

1. Click **Storage Systems**, and then expand the Storage Systems tree.
2. In the Storage Systems tree, click **Replication > Remote Connections**.
3. In the **Remote Connections** window, click the **Connections (To)** tab.
4. In the **Connections (To)** tab, select the remote connection with the path to be deleted.
5. Click **More Actions > Remove Remote Paths**.
6. In the **Remove Remote Paths** window, select the type of path to be removed (**Fibre** or **iSCSI**), and click **Remove** for each remote path to be removed. Note that remote paths become unselectable when the minimum number of paths is reached.

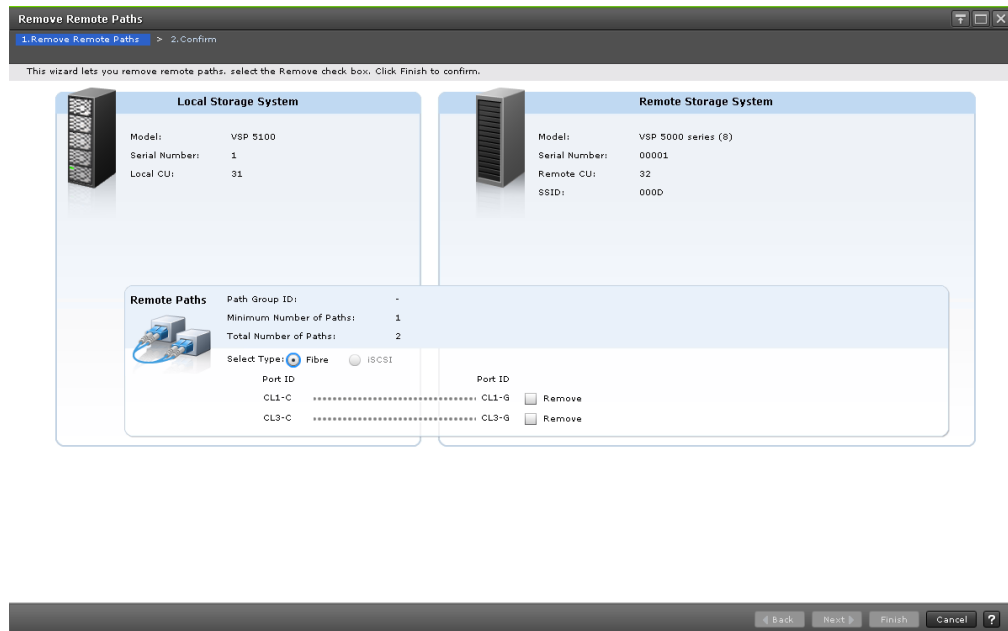

7. Click **Finish**.
8. In the **Confirm** window, review the settings and enter a task name in the **Task Name** box.
9. Click **Apply** to save your settings in the system.

## Adding SSIDs on the secondary system

When new LDEVs are added to the secondary system, you make them available for TCz operations by adding the associated SSIDs.

When an LDEV is deleted from the secondary system, delete the associated SSID from the system to avoid mis-operation.

### Before you begin

- You can add four SSIDs to each secondary system.
- Before adding an SSID, make sure that the remote path is properly installed.
- SSIDs cannot be added when the remote connection is added by System.
- Before deleting an SSID, make sure that the remaining SSIDs are still valid, otherwise the remote paths will be lost.

### Procedure

1. In Hitachi Command Suite:
  - a. On the **Resources** tab, expand the Storage Systems tree, right-click the target storage system and click **Remote Connection**.
- In Device Manager - Storage Navigator:
  - a. Click **Storage Systems**, and then expand the Storage Systems tree.
  - b. In the Storage Systems tree, click **Replication > Remote Connection**.

2. In the **Remote Connections** window, click the **Connections (To)** tab.
3. In the **Connections (To)** tab, select the remote connection where you want to add an SSID.
4. From the **Actions** menu, click **Remote Connection > Add SSIDs**.
5. In the **Add SSIDs** window, for **SSID**, enter the SSID. The range of values is from 0004 to FEFF.

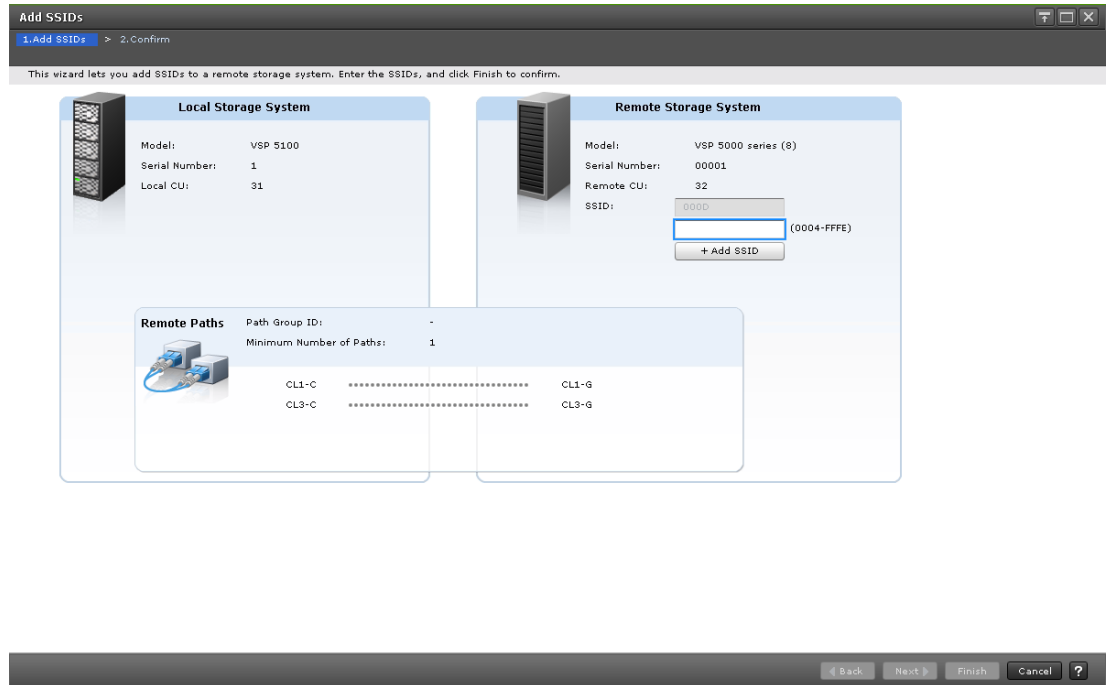

6. Click **Add SSID**. You can add up to four SSIDs.
7. Click **Finish**.
8. In the **Confirm** window, review the settings and enter a task name in the **Task Name** box.
9. Click **Apply** to save your settings in the system.

## Deleting SSIDs on the secondary system

### Procedure

1. In Hitachi Command Suite:
  - a. On the **Resources** tab, expand the Storage Systems tree, right-click the target storage system and click **Remote Connection**.
 In Device Manager - Storage Navigator:
  - a. Click **Storage Systems**, and then expand the Storage Systems tree.
  - b. In the Storage Systems tree, click **Replication > Remote Connection**.
2. In the **Remote Connections** window, click the **Connections (To)** tab.
3. In the **Connections (To)** tab, select the remote connection where you want to delete an SSID.



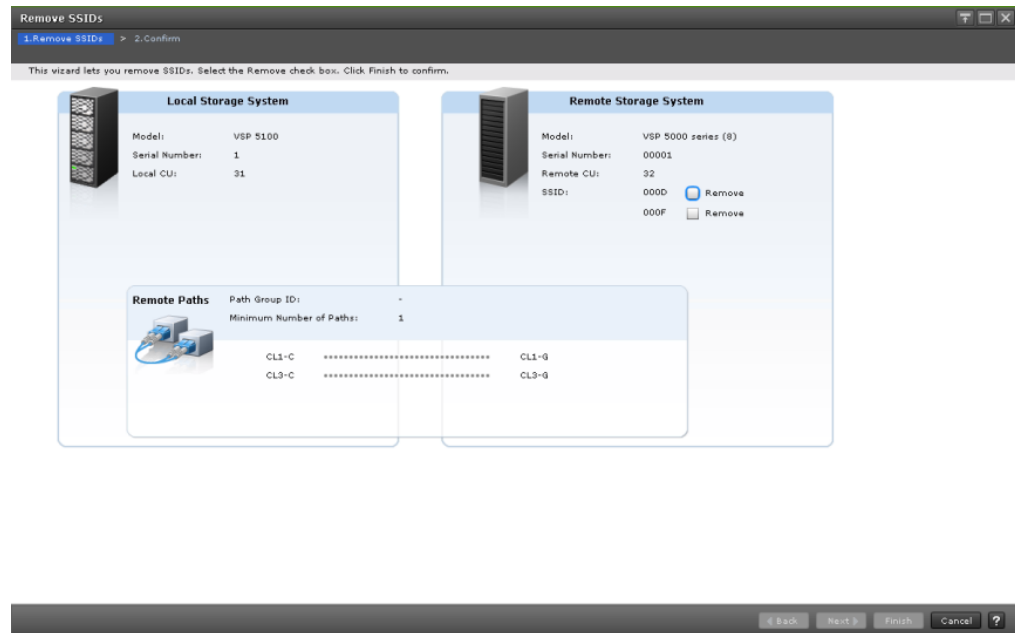

4. From the **Actions** menu, click **Remote Connection > Remove SSIDs**.
5. In the **Remove SSIDs** window, locate the SSID to be deleted and click **Remove**.
6. Click **Finish**.
7. In the **Confirm** window, review the settings and enter a task name in the **Task Name** box.
8. Click **Apply** to save your settings in the system.

## Deleting remote connections

You can delete the remote connection from the local storage system to a remote storage system.

When you delete a remote connection, the local storage system deletes all remote paths to the selected remote storage systems.

Deleting the TCz relationship with a specific remote system does not affect TCz operations between other local systems and the remote system.

After a remote system is deleted, you can reconfigure the remote path to then connect another remote system to the local system. You can also delete the remote connection and reconfigure the local system ports (bidirectional ports to ordinary target ports for fibre) to provide additional host channels for the local system.

### Before you begin

- All TCz pairs must be deleted before removing the connection.
- When the remote connection is deleted, all remote paths are deleted.
- Required role: Storage Administrator (Remote Copy).

**Procedure**

1. Click **Storage Systems**, and then expand the Storage Systems tree.
2. In the Storage Systems tree, click **Replication > Remote Connections**.
3. In the **Remote Connections** window, click the **Connections (To)** tab.
4. In the **Connections (To)** tab, select the remote connection to be deleted.
5. Click **More Actions > Remove Remote Connections**.
6. In the **Remove Remote Connections** window, from the **Selected Remote Connections** table, select the connection to be removed.

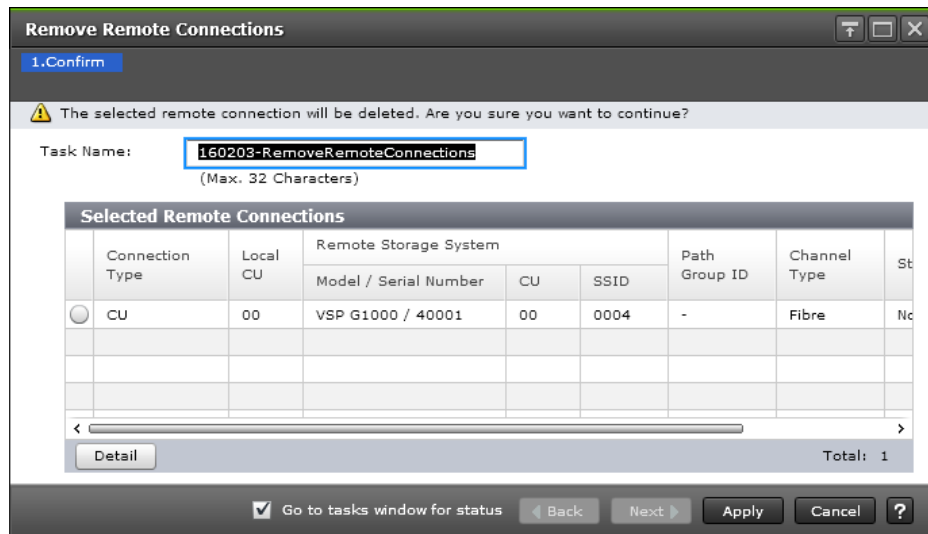

(You can review information about the connection by clicking **Detail**.)

7. Click **Apply**.

## ICKDSF Considerations for TCz Volumes

VSP 5000 series supports the use of the ICKDSF utility program. ICKDSF performs functions for the installation, use, and maintenance of DASD and service functions, error detection. For further information about ICKDSF, see the IBM® document, *ICKDSF R16 Refresh User's Guide (GC35 0033)*, or other IBM® documents on ICKDSF R16 or later. See the *Mainframe Host Attachment and Operations Guide* for further information about using ICKDSF with the storage system.

### Running ICKDSF on a TCz P-VOL

ICKDSF activities involve write I/O operations with device support authorization instead of normal authorization. Because the primary system does not duplicate write I/O operations with device support authorization at the S-VOL, you must split a pair before running ICKDSF on the P-VOL.

**Procedure**

1. Split the pair from the primary system, using the S-VOL split option. You can also use the CSUSPEND TSO command.

2. After the P-VOL status changes to Suspend(Secondary Volume by Operator), run ICKDSF to repair the P-VOL.
3. When volume repairs are complete, resynchronize the TCz pair. You can also use the CESTPAIR (MODE=RESYNC) command to resynchronize the pair.

## Running ICKDSF on a TCz S-VOL

If you need to run ICKDSF on an S-VOL, you must change the status of the S-VOL to unpaired to allow write access. The pair must then be restarted using the appropriate initial copy options.

### Procedure

1. You can stop write I/Os to the P-VOL while the S-VOL is being repaired. To do this, split the pair from the primary system, specifying **Disable** for the **Primary Volume Write** option. You can also use the CSUSPEND TSO command.
2. In the secondary system's Remote Replication window, select the S-VOL to be repaired, and then delete the pair. You can also use the CRECOVER command.
3. If necessary, change the S-VOL VOLSER to avoid problems due to duplicate VOLSERS.
4. Vary the S-VOL online, and run ICKDSF to repair the S-VOL. When the volume repairs are complete, vary the S-VOL offline.
5. In the primary system's Remote Replication window, select the P-VOL, and then delete the pair.
6. Recreate the pair with the **Create Pairs** wizard. Specify **Entire Volume** for **Initial Copy Type**. This will resynchronize the P-VOL and S-VOL. (You can specify **None** if the P-VOL and S-VOL are still identical.)

You can also use the CESTPAIR TSO command to recreate the pair.

## Managing power-off for systems and network devices

You might have to have a planned outage of the primary system, the secondary system, or both to maintain the systems.

Though you are responsible for controlling power-off activities, it is advisable to check with customer support.

### How powering off for a planned outage affects primary and secondary systems

Before you power off a primary or secondary system for a planned outage, you should understand how powering off primary or secondary systems affects those systems.

Review the following system behaviors regarding powering off:

- TCz pairs are not affected when power is removed from a primary system while operations are in progress.
- When power is restored on the primary system, the system communicates with the secondary systems to confirm S-VOL pair status(es). Make sure that TCz communications are fully restored (all paths have normal status) before beginning I/O operations to the P-VOL.

If the primary system accepts an I/O for a P-VOL when the path status is not normal, the primary system will split the pair. P-VOL status will change to Suspend (by RCU) but the primary system cannot change the pair status of the S-VOL.

- If power is removed from a secondary system or from a data path component while TCz operations are in progress, the primary system detects the communication failure, splits all affected pairs, and generates SIMs reporting the failures. The primary system changes the P-VOL status to Suspend (by RCU) but cannot change the status of the S-VOLs.
- If a primary or secondary system is powered off and the backup batteries are fully discharged while pairs are split, differential data is retained to SSD. In this unlikely case, primary system copies differential data to secondary system when the pairs are resynchronized.

## Planned outage of the primary system

A planned outage of the primary system does not affect TrueCopy for Mainframe.

## Planned outage of the secondary system or remote path

You must split the pairs in a secondary system prior to a planned outage of the system or to a data path component (for example, switch, channel extender).

### Procedure

1. Identify the P-VOLs that are paired with S-VOL in the secondary system that is to be powered off.

For data path outage, identify all P-VOLs in the primary system that use the path or component to be powered off. You need to know the primary system, CU, and LDEV IDs for each of the P-VOLs.

- a. When powering off storage systems at the secondary site, identify all P-VOLs paired with the S-VOLs of storage systems to be powered off.
- b. When powering off remote copy connections, identify all P-VOLs of storage systems at the primary site that use paths, switches, or channel extenders to be powered off.

2. Connect to each primary system that contains to-be-affected P-VOLs, and split all to-be-affected pairs.

Confirm the changed pair status in the **Remote Replication** window or the **View Pair Properties** window in HDvM - SN.

You can perform this step using the YKQUERY command. For details, see the BCM documentation.

3. Perform the planned outage of the secondary system or remote copy connections.
4. When the secondary system is fully powered on and ready, resynchronize the affected pairs at each primary system. Confirm the pair status changes.

## **Planned outage of both primary and secondary systems**

When you plan an outage of a TrueCopy for Mainframe primary and secondary systems at the same time, the primary system must be powered off first, and then powered on last.

### **Procedure**

1. Perform the planned outage of the primary system first. Because a planned outage does not affect pairs, nothing out of the ordinary must be done regarding the TCz system or operations. Do not power on the primary system at this time.
2. If a secondary system to be powered off is connected to a primary system that is not powered off, split the pairs before powering off the secondary system. Confirm that the pair status changes.
3. Perform the planned outage of the secondary systems as described in [Planned outage of the secondary system or remote path \(on page 156\)](#).
4. Power on the secondary systems. Make sure that secondary systems and remote connections are fully operational and ready to resynchronize operations before powering on the primary system.
5. Power on the primary system, and make sure the primary storage system and remote connections are operational and ready to resynchronize operations. If you split any pairs in step 2, you can also resynchronize those pairs now.

---

## Chapter 8: Data migration

You can use TrueCopy for Mainframe to migrate data from one storage system to another.

### Migration overview

TrueCopy for Mainframe can be used to move data from one volume to another.

You do not need to use host migration software for data migration when using TrueCopy for Mainframe. Also, TrueCopy for Mainframe data migration does not affect the host.

TrueCopy for Mainframe operations within one storage system can only be performed if the ShadowImage for Mainframe option is not active on the storage system. If you are migrating data between storage systems using P/DAS, both storage systems must be the same type (for example, migration between VSP 5000 series and VSP G1000 using P/DAS is not supported).

In a data migration, the entire contents of a volume are copied to the secondary volume (P-VOL to S-VOL). The volumes are identical when the copy operation completes. The volumes are then usually released from the TrueCopy for Mainframe pair.

If you need to migrate data from other vendors' storage system, contact customer support.

### Migrating data

You typically migrate data to copy data to a new volume, to temporarily move data from an LDEV to accommodate other activities (for example, to make repairs), or to relocate LDEVs in order to balance workloads and distribute I/O activity evenly within or across storage systems.

#### Procedure

1. Make sure that the data path is installed, and TrueCopy for Mainframe configuration procedures are completed.
2. Verify the target volume (S-VOL) is offline from all attached hosts. The source volume (P-VOL) can remain online.
3. Connect to the storage system that contains the volume to be migrated, and then start Device Manager - Storage Navigator.  
Set a data path, change the port attribute to Bidirectional, and then register the target storage system.
4. In the **Create Pairs** window of HDvM - SN, create a TrueCopy for Mainframe pair.

5. When pair status changes to Duplex, the operation is completed.  
You can monitor the progress of the operation from the **Remote Replication** window of HDvM - SN.  
You can perform this step using the **YKQUERY** command. For details, see the BCM documentation.
6. Use the IBM® P/DAS host software function to redirect all application I/Os to the S-VOLs nondisruptively. If the host system does not support P/DAS, use the following procedure to stop using the P-VOLs and switch to the S-VOLs:
  - a. Quiesce all applications using the P-VOLs.
  - b. When all update activity to the P-VOLs has stopped, connect to the primary system, select the correct CU, and release the TCz pairs.
  - c. If the P-VOLs and S-VOLs are attached to the same host, vary the P-VOLs offline first, and then vary the S-VOLs online. The P-VOLs and S-VOLs have the same VOLSERS and cannot be online to the same hosts at the same time.
  - d. If an S-VOL contains more cylinders than its P-VOL, update the S-VOL volume table of contents (VTOC) using ICKDSF/REFORMAT.
  - e. If you want to keep the volumes synchronized, establish the same TCz pairs in the reverse direction by setting None for initial copy type in the **Create TC Pairs** window. If the original P-VOLs will be temporarily unavailable for update copy operations, you can suspend the new pairs so that the new primary system keeps track of changes.
  - f. Start the applications with the S-VOLs. When the original P-VOLs become available, you can resynchronize the pairs.

### Result

If the original P-VOL is temporarily unavailable for update copy operations, split the new pair so that the new primary system keeps track of changes.

CFW data is not migrated when you specify Primary Volume Only for the CFW Data option in the **Edit Pair Options** window. Note that there is a possibility that I/O will terminate abnormally if you access the corresponding data set when you use the S-VOL after migrating data.

---

## Chapter 9: Disaster recovery

You can use the disaster recovery overview to prepare volumes and groups for disaster recovery.

### Disaster recovery overview

Preparing for disaster recovery involves the following major steps:

1. Identify the volumes and groups that contain important files and data for disaster recovery.
2. Create TrueCopy for Mainframe pairs, paying special attention to the options in P-VOL Fence Level Settings to ensure that the system responds the way you want in the event of a failure (see [Allowing I/O to the P-VOL after a split: Fence Level options \(on page 72\)](#)).
3. Install and configure host failover software between the primary and secondary sites.
4. Establish file and database recovery procedures. These procedures for recovering volumes due to control unit failure must already be in place.
5. Make sure that the host system at the primary site is configured to receive sense information from the primary storage system (for example, using SNMP). This must also be done at the secondary site if a host is connected to it.



**Note:** Procedures for disaster recovery involve releasing pairs. However, when using Business Continuity Manager you can perform disaster recovery without releasing pairs. To do this, when setting up TrueCopy for Mainframe, add remote paths between the secondary system and primary system. For VSP 5000 series, connect the Bidirectional port in the secondary storage system and the Bidirectional port in the primary storage system via a remote path in advance. Then add a remote connection from the secondary system CU to the primary system CU.

Remote copy and disaster recovery procedures are complex. Consult customer support on sense-level settings and recovery procedures.

### Sense information shared between sites

When the primary system splits a TrueCopy for Mainframe pair due to an error condition, the primary and secondary systems send sense information with unit check status to the appropriate hosts. This sense information is used during disaster recovery to determine the consistency of the S-VOL and must be transferred to the secondary site using the host failover software.



If the host system supports IBM® PPRC and receives PPRC compatible sense information related to a TrueCopy for Mainframe pair, the host OS will perform the following actions:

1. Temporarily split all application I/O operations to the P-VOL.
2. Enter an IEA491E message in the system log (SYSLOG) that indicates the time that the P-VOL was split. Make sure that the system log is common to both the primary and secondary operating systems.
3. Place specific information about the failure (SIM) in the SYS1.LOGREC dataset for use by service personnel. See [Service information messages \(SIMs\) \(on page 190\)](#) for more information about SIM.
4. Wait for the IEA491E message to reach the secondary system.
5. Resume all host application I/O operations to the P-VOL. If the P-VOL fence level setting does not allow subsequent updates, the primary system will return a unit check for all subsequent write I/O operations, and the application will terminate.

Make sure that the primary and secondary systems are configured to report the service level SIMs to the host. Select the Services SIM of Remote Copy = Report setting on the Change CU Options window.

## File and database recovery

File recovery procedures for disaster recovery should be the same as those used for recovering a data volume that becomes inaccessible due to control unit failure.

TrueCopy for Mainframe does not provide a procedure for detecting and retrieving lost updates. To detect and recreate lost updates, you must check other current information (for example, database log file) that was active at the primary system when the disaster occurred.

The detection and retrieval process can take some time. Your disaster recovery scenario should be designed so that detection and retrieval of lost updates is performed after the application has been started at the secondary site.

You should prepare for file and database recovery using files for file recovery (for example, database log files that have been verified as current). You can also use the sense information with system time-stamp that is transferred by the ERC.

## CSUSPEND/QUIESCE TSO command

See the IBM® documents SG24 2595, SC35 0355, and SC35 0169 for important information about the optional QUIESCE parameter for the CSUSPEND TSO command.

The QUIESCE option of the CSUSPEND command has been disabled by APAR OW15247 or APAR OW15248. Refer to either of these APARs and the latest IBM® PPRC documentation for detailed information about the QUIESCE option of the CSUSPEND command. Check with customer support before using the CSUSPEND command with the QUIESCE option to suspend TCz pairs on the storage systems. If the CSUSPEND command with the QUIESCE option is issued to certain volumes (for example, active SPOOL, PAGE, or CATALOG datasets, active SYSRES volume), the attached hosts might enter a deadlock condition, and a storage control IML might be required to correct the condition.

## IEA494I system console message

The IEA494I message is recommended as a trigger for automation over the IEA491E message, because the IEA494I message is reported to all attached MVS hosts each time the P-VOL pair status changes, whereas the IEA491E message is reported to only one host system.

## Switching operations to the secondary site

If a disaster or failure occurs at the primary site, the first disaster recovery activity is to switch your operations to the secondary site. S-VOLs are recovered individually based on the pair status and P-VOL fence level information for each pair.

You can switch operations to the secondary site either by deleting pairs and then re-establishing them when recovery is completed, or by not deleting pairs. Both methods are presented below.

## Switching operations to the secondary site by deleting pairs

### Procedure

1. Check the pair status and fence level of each S-VOL.
2. Analyze the consistency of the S-VOLs, based on pair status and Primary Volume Fence Level setting in the **Create TC Pairs** window. See [Checking S-VOL consistency with the P-VOL \(on page 163\)](#).
  - BCM YKQUERY
3. Perform file recovery as needed.
4. Split all pairs from the secondary system using one of the following:
  - BCM YKSUSPND
  - PPRC CSUSPEND
5. Release all pairs using one of the following:
  - BCM YKRECOVER
  - PPRC CRECOVER



**Note:** When the S-VOL is no longer paired, it cannot be distinguished from a non-TrueCopy for Mainframe volume. Use the appropriate means to change the S-VOL volume labels.

If necessary, use ICKDSF REFORMAT to change the labels (VOLSERs) of the S-VOLs.

6. Complete file recovery procedures.
7. Vary the S-VOLs online.
8. If an IPL of the remote host system is not required, bring the S-VOLs online. If an IPL is required:

- a. Remote copy SIMs must be cleared from the secondary systems before OS IPL. For instructions on clearing the remote copy SIMs, see [Completing SIMs for TCz \(on page 119\)](#). To clear the remote copy SIMs on other storage system models, contact your service representative.
  - b. Perform an IPL of the remote host system.
  - c. Wait until the IPL is complete, and then vary the S-VOLs online (if they did not come online automatically).
9. At the secondary site, start critical host operations, with the previous S-VOLs now the P-VOLs.

## Switching operations to the secondary site by not deleting pairs

### Procedure

1. Record the pair status and fence level of each S-VOL.
2. Analyze the consistency of the S-VOLs, based on pair status and the Primary Volume Fence Level setting in the **Create TC Pairs** window. See [Checking S-VOL consistency with the P-VOL \(on page 163\)](#).
3. Perform file recovery as needed.
4. Run the BCM YKSUSPND REVERSE.
5. Complete file recovery procedures.
6. Vary the S-VOLs online.
7. If an IPL of the remote host system is not required, bring the S-VOLs online. If an IPL is required:
  - a. Remote copy SIMs must be cleared from the secondary systems before OS IPL. For instructions on clearing the remote copy SIMs, see [Completing SIMs for TCz \(on page 119\)](#). To clear the remote copy SIMs on other storage system models, contact your service personnel.
  - b. Perform an IPL of the remote host system.
  - c. Wait until the IPL is complete, and then vary the S-VOLs online (if they did not come online automatically).
8. At the secondary site, start critical host operations, with the previous S-VOLs now the P-VOLs.

## Checking S-VOL consistency with the P-VOL

An S-VOL's consistency refers to whether S-VOL data is identical to data in the P-VOL. This is dependent on your Fence Level setting, which determines whether data is copied to the P-VOL if an error occurs during an update to the S-VOL.

The following table shows S-VOL consistency information, based on Device Manager - Storage Navigator pair status and the P-VOL fence level setting. (For the corresponding CCI status names, see [CCI pair status names \(on page 137\)](#).)

S-VOL status			Split type	Fence level		Consistency of S-VOL
Device Manager - Storage Navigator	CCI	BCM		HDvM - SN	CCI	
Unpaired volume	SMPL	SIMPLX	--	Data, Status, Never	data, status, never	Not consistent. The S-VOL does not belong to a pair. Even if you have created a pair using this volume, if the pair status is still SMPL, you must regard its data as not consistent with the P-VOL.
Pending	COPY	PENDING	--	Data, Status, Never	data, status, never	Not consistent. The S-VOL is not synchronized because not all tracks have been copied from the P-VOL yet. This S-VOL must be initialized (or copied from the P-VOL at a later time).
Duplex	PAIR	DUPLEX	--	Data, Status	data, status	Consistent. The S-VOL is synchronized with its P-VOL.
				Never	never	Needs to be analyzed. The S-VOL requires further analysis to determine its level of consistency.
Suspend	PSUE	SUSPERR(50)	Initial Copy Failed	Data, Status, Never	data, status, never	Not consistent. The S-VOL is not synchronized because not all tracks have been copied from the P-VOL yet. The S-VOL must be initialized (or copied from the P-VOL at a later time).
Suspend	PSUS	SUSPOPP(04)	Secondary Volume by Operator	Data, Status, Never	data, status, never	Suspect. The S-VOL is not synchronized with its P-VOL if any write I/Os were issued to the P-VOL after the pair was split. The pair must be released and restarted using Entire Volume for the Initial Copy Type option. If you are sure that no data on the P-VOL changed, you can use None for Initial Copy Type.
Suspend	PSUE	SUSPOP/ SUSPERR(all other types)	All other types	Data	data	Consistent. The S-VOL is synchronized with its P-VOL.

S-VOL status			Split type	Fence level		Consistency of S-VOL
Device Manager - Storage Navigator	CCI	BCM		HDvM - SN	CCI	
				Status, Never	status, never	Suspect. The S-VOL is not synchronized with its P-VOL if any write I/Os were issued to the P-VOL after the pair was suspended. Restore the consistency of the S-VOL and update it, if required. The time of suspension indicated on the Last Update Time field of the Detailed Information dialog box (MCU SVP time) will help to determine the last time the S-VOL was updated.
<b>Legend:</b>						
Data: Data in the secondary volume						
Status: Status of the secondary volume						
For pairs whose P-VOL fence level in HDvM - SN is Never, or for pairs whose output results of the <code>pairdisplay</code> command for Fence in CCI is never, further analysis is required to determine the S-VOL consistency. This can be determined by using sense information transferred by host failover, or by comparing the contents of the S-VOL with other files that are confirmed to be consistent (for example, database log files). The S-VOLs should be recovered using the files that are confirmed to be consistent.						
<b>Note:</b> Actual data recovery must be done using recovery point data in the database operation log.						

## Transferring operations back to the primary site

When host operations are running at the secondary site, the primary site must be restored and operations transferred back.

Create a TrueCopy for Mainframe pair by specifying secondary site volume to primary volume and primary site volume to secondary volume.

Select the appropriate procedure below based on whether you deleted pairs to switch operations to the secondary site, or ran the Business Continuity Manager YKSUSPND REVERSE command.

### Transferring operations back to the primary site if pairs were deleted

#### Procedure

1. At the primary site, bring up the host. Make sure that TCz components are operational.

2. At the primary system, split all pairs on the primary system.  
Specify Force (All pairs in the same remote connections) in the Deleting Mode option to release all TCz pairs in each CU. Make sure to connect with all primary systems and all CUs to release all pairs.
3. At the primary system, delete the TCz association with the secondary systems (Remove Remote Connections).  
In Device Manager - Storage Navigator, connect to each primary system to make sure that all secondary systems are deleted.
4. At the secondary system, check that it is ready to create TrueCopy for Mainframe pair.
5. At the secondary system, create TrueCopy for Mainframe pair and synchronize S-VOL with P-VOL.  
Make sure to use Entire Volume for the Initial Copy Type option in HDvM - SN, or execute the **YKMAKE** command in BCM without specifying the **NOCOPY** option. Confirm that the pairs are created and that status is Duplex.
6. At the secondary system, halt host operations and vary the P-VOL (old S-VOL) offline. This maintains synchronization of the pairs.
7. At the secondary system, split the pairs and destage held data from cache.  
Confirm that the pairs are split and status is Suspend - S-VOL by operator before proceeding. If an error occurs, resolve it before proceeding.
8. At the secondary system, release the pairs. You do not need to use the Force Delete Pairs (TC Pairs) option.
9. At the primary system, check that it is ready to create TrueCopy for Mainframe pairs.
10. At the primary system, create TrueCopy for Mainframe pairs.  
If all P-VOL and S-VOL are synchronized, you can use None for the Initial Copy Type option in HDvM - SN, or execute the **paircreate** command in CCI by specifying the **nocopy** option. If P-VOL and S-VOL are not fully synchronized, use Entire Volume for Initial Copy Type.
11. Vary the primary system and P-VOLs online, and start host operations.

## Transferring operations back to the primary site if pairs were not deleted

### Procedure

1. At the primary site, bring up the host. Make sure that TCz components are operational.
2. Run the Business Continuity Manager **YKRESYNC REVERSE** command.
3. At the secondary system, halt host operations and vary the P-VOL (old S-VOL) offline. This maintains synchronization of the pairs.
4. Run the **YKSUSPND FORWARD** command.
5. Run **YKRESYNC FORWARD** command.
6. Verify the primary system and P-VOLs online, and start host operations at the primary site.

---

## Chapter 10: Troubleshooting TrueCopy for Mainframe

When issues occur with TrueCopy for Mainframe, there are a number of different troubleshooting options you can try.

### Device Manager - Storage Navigator error codes and messages

Error messages are displayed on the Device Manager - Storage Navigator computer when error conditions occur during TrueCopy for Mainframe operations. The message describes the error and provides a part code and error code.

The error message might also include an SVP error code. If you need to contact customer support, report the error codes. See the *Hitachi Device Manager - Storage Navigator Messages* for a list of the error codes.

### General troubleshooting

The following table provides a list of general error conditions and provides recommended action for each condition.

For troubleshooting information about PPRC and P/DAS operations, please refer to the IBM® PPRC and P/DAS user documentation: *Planning for IBM Remote Copy (SG24 2595)*, *Advanced Copy Services (SC35 0355)*, and *DFSMS MVS V1 Remote Copy Guide and Reference (SC35 0169)*.

Error	Corrective action
The Device Manager - Storage Navigator computer or management client hangs, or TrueCopy for Mainframe operations do not function properly.	<ul style="list-style-type: none"><li>Make sure that the problem is not being caused by the computer or Ethernet hardware or software, and restart the computer. Restarting the Device Manager - Storage Navigator computer does not affect storage system operations.</li><li>Make sure that all TrueCopy for Mainframe requirements and restrictions are met (for example, Track format, LVI, VOLSER, DFW).</li></ul>

Error	Corrective action
	<ul style="list-style-type: none"> <li>▪ Make sure that the primary and secondary systems and data paths are powered on and fully operational (NVS, cache, DFW).</li> <li>▪ Check all input values and parameters to make sure that you entered the correct information about the Device Manager - Storage Navigator computer (for example, remote storage system S/N and ID, path parameters, P-VOL and S-VOL IDs).</li> </ul>
An initiator channel-enabled LED indicator (on the control panel) is off or flashing.	Contact customer support.
The pairs or paths to the remote system are not displaying correctly.	Make sure that the correct CU is selected.
A TrueCopy for Mainframe error message is displayed on the Device Manager - Storage Navigator computer.	Resolve the error, and then try the TrueCopy for Mainframe operation again.
There is a problem with the Device Manager - Storage Navigator computer or TrueCopy for Mainframe software.	Make sure that the problem is not the computer or LAN hardware or software. Try restarting the computer and reconnecting to the storage system.
The remote system or secondary storage system path status is not normal.	Check the path status ( <b>Remote Connections</b> window), and see <a href="#">Remote path status problems (on page 169)</a> .
Pair status is Suspend (pair suspended-error).	See <a href="#">Split pair problems (on page 172)</a> .
Monitoring data is not updated though the Monitoring Switch option is set to Enable.	Because the time setting of SVP is changed, the monitoring data might not be updated. Disable Monitoring Switch, and then enable again. For more information about Monitoring Switch, see the <i>Performance Guide</i> of your storage system.



Error	Corrective action
A pair cannot be created or resynchronized.	Check if the controller board is blocked on the primary storage system. Restore the blocked controller board, and then retry the operation.

## Remote path status problems

Problems that you might encounter with remote path status are displayed by Device Manager - Storage Navigator. By understanding the displayed status, you can take the appropriate corrective action.

The following table provides a list of remote path status problems.

Path status	Description	Corrective action
Normal	This remote path has been successfully established and can be used for TrueCopy for Mainframe copy activities.	None required.
Initialization Failed	The link initialization procedure to the remote storage system failed because the physical path connection was missing between the local and remote storage system or between the local storage system and the switch.	<ul style="list-style-type: none"> <li>▪ Make sure that the local and remote storage systems or the local storage system and the switch are physically and correctly connected.</li> <li>▪ Make sure that you entered the correct remote storage system S/N, model name, and local and remote storage system port numbers.</li> <li>▪ Make sure that topologies (Fabric, FC-AL, Point-to-point) for the local and remote storage system ports are configured correctly.</li> </ul>
Communication Time Out	Communication between the local and remote storage systems timed out.	<ul style="list-style-type: none"> <li>▪ Make sure the remote storage system is powered on and that NVS and cache are fully functional.</li> <li>▪ Make sure that network relay devices are properly configured and functional. This includes cables, connectors, switches, extender devices, communication lines, and all other devices connected to the extenders.</li> </ul>

Path status	Description	Corrective action
Port Rejected	The local or remote storage system rejected the logical path link control function because all logical path resources in the local or remote storage system are used for other connections.	<ul style="list-style-type: none"> <li>▪ Delete all remote paths not in use in the <b>Remove Remote Paths</b> wizard of HDvM - SN, or by the <code>raidcom delete rcu_path</code> command of CCI.</li> <li>▪ Make sure that all local and remote storage system ports are properly configured as Bidirectional ports. If necessary, change to the correct port attribute.</li> <li>▪ Remove all remote storage systems currently not in use in the Remove Remote Connection window of HDvM - SN, or by the <code>raidcom delete rcu</code> command of CCI.</li> </ul>
Serial Number Mismatch	The primary storage system's S/N does not match the specified S/N.	<ul style="list-style-type: none"> <li>▪ Make sure that you entered the correct remote storage system S/N and model name, and local and remote storage system port numbers.</li> <li>▪ Make sure that topologies (Fabric, FC-AL, Point-to-point) for the local and remote storage system ports are configured correctly.</li> <li>▪ Make sure that data path relay equipment is properly configured and functional. This includes cables, connectors, switches, extender devices, communication lines, and all other devices connected to the extenders.</li> </ul>
Invalid Port	<p>The specified local storage system port is in the following status:</p> <ul style="list-style-type: none"> <li>▪ Not mounted.</li> <li>▪ The port attribute is not Bidirectional.</li> <li>▪ A remote path is already added.</li> </ul>	<ul style="list-style-type: none"> <li>▪ Make sure the correct port on the local storage system is installed or set to the initiator attribute.</li> <li>▪ Make sure that no two paths between local and remote storage system ports have the same settings.</li> <li>▪ Make sure that you entered the correct remote storage system S/N and model name, and local and remote storage system port numbers.</li> </ul>

Path status	Description	Corrective action
		<ul style="list-style-type: none"> <li>▪ Make sure that topologies (Fabric, FC-AL, Point-to-point) for the local and remote storage system ports are configured correctly.</li> <li>▪ Make sure that data path relay equipment is properly configured and functional. This includes cables, connectors, switches, extender devices, communication lines, and all other devices connected to the extenders.</li> </ul>
Pair-Port Number Mismatch	The specified port in the remote storage system is physically disconnected from the local storage system.	<ul style="list-style-type: none"> <li>▪ Make sure that you specified the correct remote storage system port number. Correct the port number if necessary.</li> <li>▪ Make sure that the cables between the local and remote storage system ports and between the remote storage system and the switch are connected correctly.</li> <li>▪ Make sure that the topology settings (Fabric, FC-AL, point-to-point) of the local and remote storage system ports are correct.</li> </ul>
Pair-Port Type Mismatch	The specified remote storage system port is not configured as a Bidirectional port.	Make sure that the remote storage system port is configured as a Bidirectional port.
Communication Failed	The local storage system connected to the remote storage system successfully, but logical communication timeout occurred.	<ul style="list-style-type: none"> <li>▪ Make sure that the remote storage system port and the relay equipment are configured correctly.</li> <li>▪ Make sure that data path relay equipment is properly configured and functional. This includes cables, connectors, switches, extender devices, communication lines, and all other devices connected to the extenders.</li> </ul>
In Progress	<p>Remote paths are being created or deleted.</p> <p>The port attribute is being changed.</p>	Wait until processing is completed.

Path status	Description	Corrective action
Path Blockade	Blockaded due to continual path or link failure.	See the corrective actions for the other path blockade issues.
	The local storage system port does not work.	Repair the port on the local storage system, and then restore the path if this problem occurs again after the repair.*
	The remote storage system port does not work.	Repair the port on the remote storage system, and then restore the path if this problem occurs again after the repair.*
	The path relay equipment does not work.	Repair the path relay equipment, and then restore the remote path if this problem occurs again after the repair.*
	The connection cable is physically broken.	Replace the broken cable, and then restore the remote path if this problem occurs again after the replacement.*
Program Error	A program error is detected.	Restore the remote path.*
<p>* To restore a remote path, it might be necessary to delete and then add the path again. To delete the remote system or path, see <a href="#">Deleting remote connections (on page 153)</a> or <a href="#">Deleting remote paths (on page 150)</a>. To re-register, see <a href="#">Adding remote connections (on page 113)</a>. You can also use PPRC (CDELPATH and CESTPATH commands) or Business Continuity Manager (YKDELPTH and YKBLDPTH commands) to delete and then re-register the remote path. If you cannot restore the path after performing these operations, contact customer support.</p>		

## Split pair problems

Problems that you might encounter with split pairs are displayed by Device Manager - Storage Navigator. By understanding the displayed pair status, you can take the appropriate corrective action.

The following table provides a list of split pair problem types.

Pair status/ type	Applies to	Description	Corrective action
Suspend/P-VOL by Operator	P-VOL	The user split the pair from the primary system specifying Disable for the Primary Volume Write option. The S-VOL split type is by MCU.	Resynchronize the pair from the primary system (Resume Pair).
Suspend/S-VOL by Operator	P-VOL, S-VOL	The user split the pair from the primary or secondary system specifying Disable for the Primary Volume Write option.	Resynchronize the pair from the primary system (Resume Pair).
Suspend/by MCU	S-VOL	The secondary system received a request from the primary system to split the pair. The P-VOL split type is P-VOL by Operator or S-VOL by Operator.	Resynchronize the pair from the primary system (Resume Pair).
Suspend/by RCU	P-VOL	The primary system detected an error condition at the secondary system, which caused the primary system to split the pair. The S-VOL split type is S-VOL Failure.	Clear the error condition at the secondary system or S-VOL, and then resynchronize the pair from the primary system.  If you need to access the S-VOL to clear the error conditions, release the pair from the secondary system. After you clear the error conditions from S-VOL, re-create the pair.
Suspend/Delete Pair to RCU	P-VOL	The primary system detected that the S-VOL status changed to Simplex because the user released the pair from the secondary system. The pair cannot be resynchronized because the S-VOL does not have the Suspend status.	Release the pair from the primary system, and then recreate the pair. Use Entire Volume for the Initial Copy Type option to resynchronize the pair. Use None only if data in the P-VOL is identical to data in the S-VOL.

Pair status/ type	Applies to	Description	Corrective action
Suspend/S-VOL Failure	P-VOL	The primary system detected an error during communication with the secondary system, or detected an I/O error during update copy. In this case, the split type for the S-VOL is usually S-VOL Failure.	<ul style="list-style-type: none"> <li>▪ Check the path status on the Remote Connections window. If errors occurred on the path, clear the error conditions.</li> <li>▪ Clear any error conditions at the secondary system or S-VOL, and then resynchronize the pair from the primary system.</li> <li>▪ If you need to access the S-VOL to clear the error conditions, release the pair from the secondary system. After you clear the error conditions, recreate the pair.</li> </ul>
Suspend/MCU IMPL	P-VOL, S-VOL	The primary system could not find valid control information in its nonvolatile memory during the IMPL procedure. This error occurs only if the system is without power for more than 48 hours (for example, power failure or fully discharged batteries).	Resynchronize the pair from the primary system. An entire initial copy operation will be performed in response to the Resume Pair request.
Suspend/Initial Copy Failed	P-VOL, S-VOL	The primary system split this pair during the initial copy operation due to invalid track format. The data on the S-VOL is not identical to the data on the P-VOL.	Release the pair from the primary system. Clear all error conditions on the primary system, P-VOL, secondary system, and S-VOL. Use ICKDSF to reformat the failed track. Perform initial copy again using the Create TCz Pairs window.
Suspend/by FREEZE	P-VOL, S-VOL	All TrueCopy for Mainframe pairs in the primary system are split by the CGROUP/FREEZE command.	Resynchronize the pairs from the primary system using Resume Pair or the CESTPAIR (MODE=RESYNC) TSO command.

## Changing microcode problem

The following table provides troubleshooting information for changing the microcode.

Error	Corrective action
The IEA498I message is reported when you change the microcode online.	If the controller emulation type of the host that is connected to the primary site is I-2107, and a TrueCopy for Mainframe pair exists, the IEA498I message that indicates the path blockade may be reported to the host when you change the microcode of the primary site or the secondary site online. If the IEA498I message is reported, confirm the path and the pair status of the primary site.

## Troubleshooting using CCI

When an error occurs in pair operations using CCI, you can identify the cause of the error by referring to the CCI operation log file.

The CCI operation log file is stored in the following directory by default:

/HORCM/log\*/curlog/horcmlog\_HOST/horcm.log

where:

- \* is the instance number.
- *HOST* is the host name.

Example:

It was rejected due to SKEY=0x05, ASC=0x20,SSB=0xB901,0xB992 on Serial#(64015)	
↓	↓
SSB1	SSB2

Error codes appear on the right of the equal symbol (=).

### SSB2 error codes when SSB1 = 2E31/B901/B90A/B90B/B912/D004

Error code (SSB2)	Description
47A3	The pair cannot be split because of one of the following conditions: <ul style="list-style-type: none"> <li>▪ Write access permitted in the S-VOL is unsupported.</li> <li>▪ Swap Suspend is unsupported.</li> </ul>

Error code (SSB2)	Description
47BA	The pair cannot be created because the specified P-VOL is one of the following: <ul style="list-style-type: none"> <li>▪ Used as an Siz S-VOL.</li> <li>▪ Intervention-required or protected.</li> </ul>
4A5C	The pair cannot be created because TCz asynchronous is not supported.
4A96	The pair cannot be created because CLPR to which the specified P-VOL belongs and CLPR for the registered consistency group are different.
4AF3	The pair cannot be split because Soft Fence is set for the specified volume.
4AF4	The pair cannot be deleted because Soft Fence is set for the specified volume.
4AF5	The pair cannot be created or resynchronized because Soft Fence is set for the specified volume.
4B02	A pair cannot be resynchronized because the request was for a consistency group without the open or mainframe consistency attribute defined from Business Continuity Manager.
4B04	The pair cannot be created because the specified P-VOL is defined as the command device.
4B22	The pair cannot be resynchronized because the specified volume is in failover in PPRC.
4B23	The pair cannot be split because the specified volume is in failover in PPRC.
4B2F	The pair operation was rejected because the online microcode is being replaced.
4B32	The pair cannot be created because the specified P-VOL is one of the following: <ul style="list-style-type: none"> <li>▪ Used by Compatible FlashCopy<sup>®</sup> V2</li> <li>▪ Used by Hitachi Compatible Software for IBM<sup>®</sup> FlashCopy<sup>®</sup> SE</li> <li>▪ A TSE volume</li> </ul>
4B85	The consistency group paircreate or pairresync was rejected because the specified P-VOL is a Compatible FlashCopy <sup>®</sup> V2 T-VOL.
4B86	The paircreate or pairresync (managed by cylinder) was rejected because the specified P-VOL is a Compatible FlashCopy <sup>®</sup> V2 T-VOL.
4BB2	The paircreate (Time Stamp mode) was rejected because the specified volume is already used in Compatible XRC.
4BE0	The pair operation was rejected because the necessary shared memory is not mounted in the primary system.
9100	The command cannot be executed because the user authentication is not performed.



Error code (SSB2)	Description
B920	The pair cannot be created because the system identifier is not correct.
B927	<p>You cannot run the following operations to a pair in a 2DC configuration:</p> <ul style="list-style-type: none"> <li>▪ Swap Suspend</li> <li>▪ Takeover</li> </ul>
B928	The pair cannot be created because the mirror ID is invalid.
B929	The pair operation was rejected because the microcode is being replaced.
B92A	The pair cannot be created because the specified volume is a command device.
B934	The pair cannot be created because TCz is not installed.
B935	S-VOL hide mode is not supported.
B93B	The specified volume is a P-VOL. The pair cannot be released because the P-VOL is specified as an S-VOL.
B941	The specified volume is an S-VOL. The pair cannot be released because the S-VOL is specified as a P-VOL.
B945	The command was rejected because the volume is unpaired.
B952	The specified LU is not defined. The DKC configuration might have been changed. Restart CCI.
B97B	The operation cannot run because pair status is either PSUS (by user) or PSUE (because of failure).
B97C	The command was rejected because the volume is unpaired.
B990	<p>The pair cannot be created because the consistency group ID is greater than is allowed.</p> <p>If this error occurred when you did not specify the consistency group ID, contact customer support.</p>
B994	The Swap Resync operation cannot be performed because the S-VOL is not in PSUS or SSWS status. (Swap Resync resynchronizes differential data when the S-VOL is swapped for the P-VOL.)
B998	The pair cannot be created because the secondary system path setting is invalid.
B99B	The pair cannot be created because TCz Asynchronous is not supported.
B9BD	The DKC LDEV configuration might have been changed while starting CCI. Restart CCI.

Error code (SSB2)	Description
B9C0	The resource of the command device has run out. In Hitachi Device Manager - Storage Navigator, set the command device to OFF, then to ON.
C05E	The pair split request was rejected because secondary system and primary system were not paired with the specified serial numbers and SSIDs.
C073	The pair deletion request was rejected because secondary system and primary system were not paired with the specified serial numbers and SSIDs.
C075	A request for a paircreate or pairresync operation was rejected because the TCz program product is not installed.
C0A1	The pair cannot be split because the S-VOL was not paired with the P-VOL.
C0A2	A request for a pairsplit -S operation was rejected because the S-VOL was not paired with the P-VOL using the paircreate command.
C0F2	The pair cannot be created because the specified DKC is the same for the primary and secondary system.
C162	The pair cannot be resynchronized because the pair was not in the PSUS or PSUE status.
C16B	The pair cannot be created because the S-VOL is not available.
C184	A request for a pairsplit -S operation was rejected because the status change of the S-VOL failed.
C189	A request for a pairsplit -S operation was rejected because the pair status was invalid.
C18A	A request for a pairsplit -S operation was rejected because the status of the volume is being changed or the group contains a pair of which status is being changed.
C194	The pair cannot be split because the S-VOL pair status was in transition.
C195	A request for a pairsplit -r operation was rejected because the pair status was already PSUS or PSUE.
C198	The group includes no pair that can be split.
C199	A request for a pairsplit -r operation was rejected because the status of the volume is being changed or the group contains a pair of which status is being changed.
C1BE	The pair's status cannot be changed during the power-on processing of the DKC.
C1D6	The command was rejected because it was issued to a non-TCz pair volume.
C211	The command was rejected because the specified volume is a P-VOL. If the error occurs when the volume is unpaired, select the volume in Device Manager - Storage Navigator, release the pair using the Force Delete Pairs (TC Pairs) window, and then run the command again.

Error code (SSB2)	Description
C212	The command was rejected because the specified volume is an S-VOL. If the error occurs when the volume is unpaired, select the volume in Device Manager - Storage Navigator, release the pair using the Force Delete Pairs (TC Pairs) window, and then run the command again.
C214	The command was rejected because the secondary system is not registered, or the registered secondary system information is invalid.
C215	The command was rejected because an internal logical error has occurred.
C218	The command was rejected because the pair status is invalid.
C21A	The command was rejected because the P-VOL status is other than PSUS or PSUE.
C21C	The command was rejected because the secondary system is not registered, or the registered secondary system information is invalid.
C22A	The command was rejected because the pair was deleted on a volume other than P-VOL.
C22C	The command was rejected because the volume is unpaired.
C22D	The command was rejected because the specified volume is the volume other than the P-VOL.
C22E	The command was rejected because the pairsplit command specifying -P option (write protection of P-VOL) was issued to a volume whose status is not PAIR.
C233	The command was rejected because the S-VOL status is unpaired.
C234/C235/ C236/C237	The command was rejected because an internal logical error has occurred.
C238	The command was rejected because the specified volume is the volume other than the P-VOL.
C239	The command was rejected because the pair was resynchronized on a volume whose status is other than PSUS or PSUE.
C23A	The command was rejected because an internal logical error has occurred.
C23B	The command was rejected because the volume is unpaired.
C23C	The command was rejected because the volume status is other than PAIR or COPY.
C23D	The command was rejected because the command for TCz asynchronous was issued to the TCz volume.
C23E	The command was rejected because the volume status is COPY.

Error code (SSB2)	Description
C267	The pair cannot be created because the command was issued to the command device.
C271	The command was rejected because the specified consistency group ID is invalid.
C28B	The command was rejected because the horctakeover command was issued to a volume whose status is not SSWS.
C28C	The command was rejected because the secondary system is not registered, or the registered secondary system information is invalid.
C28D	There is no volume to which the horctakeover command can run.
C28E	The command was rejected because an internal logical error has occurred.
C297	The command was rejected because the specified volume is used as an S-VOL.
C2A0	The pair cannot be created because the capacity that is used by software products other than TCz exceeds license capacity.
C2A1	The command was rejected because an internal logical error has occurred.
C2A3	The pair cannot be created because the used capacity exceeds the license capacity.
C2B3	The command was rejected because DP-VOL capacity is being changed.
C2B4	The command was rejected because an internal logical error has occurred.
C2B5	The pair cannot be created because the TCz P-VOL is being initialized by ShadowImage.
C2B6	The command was rejected because releasing pages in DP-VOL is in progress.
C300	A copy pair associated with URz cannot be created because the Remote Replication Extended program product is not installed on the primary system.
C301	A copy pair associated with URz cannot be created because the Remote Replication Extended program product is not installed on the secondary system.
C304	The pair cannot be created because the S-VOL is a DP-VOL.
C305	The pair cannot be created because the capacity that is used by TCz in the secondary system exceeds license capacity. Check license capacity, including for related software products.
C30D	The volume in the secondary system or another volume that belongs to the same group is changing to SMPL, PSUS, or PSUE status. Retry the operation after approximately 5 minutes.
C310	The NVS is not ON in the primary system.

Error code (SSB2)	Description
C311	The storage system level cache is not valid in the primary system.
C312	The P-VOL is not in unpaired status.
C313	The P-VOL is not in PSUS or PSUE.
C314	The P-VOL is not in unpaired status.
C315	The P-VOL includes PIN data.
C316	The P-VOL is in the process of drive copy for failure assistance.
C317	The P-VOL is in the process of drive copy for an SVP request.
C318	The P-VOL is terminating the copy task.
C319	The P-VOL is in the process of correction copy.
C31A	The P-VOL is in the process of correction access.
C31B	A request for creating or resynchronizing TC pairs was received, but the command was rejected because the physical volume with the specified P-VOL is blocked.
C31C	The P-VOL is blocked and cannot be accessed.
C31D	The P-VOL is being formatted.
C31E	The P-VOL is read only.
C320	The number of remote paths between primary and secondary systems is 0 (not specified).
C321	The number of remote paths between primary and secondary systems is smaller than the minimum required.
C322	The DKC type of the primary system does not support TCz.
C324	The secondary system's sequence number, SSID, or CU is invalid.
C325	The NVS is not ON in the secondary system.
C326	The storage system level cache is not valid in the secondary system.
C327	The pair cannot be created because the P-VOL is not available for remote copy.
C328	The track formats of the P-VOL and the S-VOL do not match.
C32A	The S-VOL is protected by Volume Retention Manager.
C32B	The P-VOL is protected by Volume Retention Manager.
C32C	The S-VOL is protected by Volume Retention Manager.

Error code (SSB2)	Description
C32D	The S-VOL is protected by Volume Retention Manager.
C32E	A request for a paircreate operation was rejected because the specified secondary system is an unsupported product.
C32F	The number of P-VOL cylinders in the TCz volume is not equal to or smaller than the number of S-VOL cylinders.
C330	P-VOL and S-VOL capacities are not the same.
C332	S-VOL cache is disabled.
C333	S-VOL DFW is disabled.
C335	The S-VOL is the TCz asynchronous P-VOL.
C336	The S-VOL includes PIN data.
C337	The S-VOL is in reserve status.
C338	<p>Copy pair cannot be created because of the either of the following reasons:</p> <ul style="list-style-type: none"> <li>▪ The S-VOL is requesting intervention, protected, or cannot be used.</li> <li>▪ The S-VOL is configured as the S-VOL or reserved volume of ShadowImage, reserved volume of Volume Migration, or the volume of URz pair.</li> </ul>
C339	The S-VOL is not available.
C33A	A request for a paircreate operation was rejected because the secondary system is not supported by TCz.
C33B	The corresponding volume cannot be specified as an S-VOL because the volume is used as another pair's S-VOL.
C33C	A request for a paircreate operation was rejected because the specified S-VOL was not mounted.
C33E	The pair cannot be created because the S-VOL is not installed or is blocked (DEV NOT READY status).
C33F	The corresponding volume cannot be specified as an S-VOL because the volume is already specified as a TCz pair volume.
C35C	The P-VOL is not accessible.
C370	There are fewer paths than the required minimum number because a path failure occurred or an invalid path was specified.
C371	The process that is performed after the copying process of Volume Migration in the S-VOL is in progress. Try again in a few minutes.

Error code (SSB2)	Description
C372	The process that is performed after the copying process of Volume Migration in the P-VOL is in progress. Try again in a few minutes.
C373	A request for a paircreate operation was rejected because the specified S-VOL is a ShadowImage for Mainframe reserved volume.
C378	The paircreate operation is rejected because the number of active paths is less than the dedicated number of minimum paths.
C379	The minimum number of paths that need to be set is not met because a path failure occurred or an invalid path was specified.
C37A	An internal error occurred.
C37B	The S-VOL is not available.
C37C	The storage system level cache is not valid in the secondary system.
C37D	The NVS is not ON in the secondary system.
C37E	The S-VOL cache is disabled.
C37F	The S-VOL DFW is disabled.
C380	The primary system cache is in transition to blockage on one side.
C381	The primary system cache is in the process of being restored.
C382	The primary system cache is either in transition to blockage on one side or in the process of being restored on one side.
C388	The pair cannot be created because the emulation type is not available for the specified volume.
C38B	The secondary system is already used by TCz.
C38D	The S-VOL is not available.
C38E	The S-VOL is a device which is not supported by TCz.
C390	The S-VOL status is not PSUS or PSUE.
C391	The S-VOL cannot be copied.
C392	The S-VOL is in reserve status or a pair of which copy type is not TrueCopy for Mainframe is already created.
C393	The S-VOL includes PIN data.
C394	The S-VOL is in online status.

Error code (SSB2)	Description
C395	The pair cannot be created or resynchronized because the specified S-VOL is blocked, physical volume with the S-VOL is blocked, correction access is in progress, or other reasons.
C398	The pair cannot be created because the emulation type is not available for the specified volume.
C39B	An internal error occurred.
C39E	The pair cannot be created because the capacity of the P-VOL exceeded the maximum volume capacity allowed to create a TCz pair.
C39F	The pair cannot be created because the capacity of the S-VOL exceeded the maximum volume capacity allowed to create a TCz pair.
C3A0	The P-VOL is a device not supported by TCz.
C3A5	The TCz pair cannot be created nor resynchronized because the specified data volume is in online status.
C3A6	The SSID or CU number of the secondary system is invalid.
C3A8	The device type combination between the P-VOL and S-VOL is invalid.
C3AA	The secondary system's cache is blocked on one side.
C3AB	The secondary system's cache is blocked on one side.
C3AC	TCz is not supported for this controller emulation type of the secondary system.
C3AD	The secondary system capacity exceeds the license capacity.
C3AE	TCz is not installed on the secondary system.
C3AF	The DKC type of the secondary system is not supported by TCz.
C3B1	The number of paths is smaller than the required minimum number of paths.
C3B3	An internal error occurred.
C3B5	The configuration combination of P-VOL and S-VOL is invalid
C3B6	The TCz P-VOL is an Slz pair volume.
C3B7	The TCz S-VOL is an Slz pair volume.
C3B8	An internal error occurred.
C3B9	The LUN for the specified S-VOL is not defined, or the LUN for the specified S-VOL contains an LDEV of which CU number is not supported by the primary storage system.



Error code (SSB2)	Description
C3BA	<p>A request for a paircreate operation was rejected because of one of the following reasons:</p> <ul style="list-style-type: none"> <li>▪ The secondary system's SSID or CU number is not supported.</li> <li>▪ Though the secondary system's SSID or CU number is supported, the microcode of the primary system device does not support them.</li> </ul>
C3BD	The P-VOL is in online status.
C3BE	<p>The following volumes cannot be specified as a TCz P-VOL:</p> <ul style="list-style-type: none"> <li>▪ Siz S-VOL not in PSUS status</li> <li>▪ Siz P-VOL in the process of reverse copy</li> </ul>
C3BF	An Siz S-VOL, Siz reserved volume, or Siz P-VOL in the process of reverse copy cannot be specified as a TCz S-VOL.
C3C0	When the P-VOL is the Siz S-VOL, the Siz volumes must be a one to one combination.
C3C7	A request for a paircreate operation was rejected because the specified volume was already part of a TCz or URz pair (including journal volumes).
C3CA	The S-VOL is reserved, or a secondary system, S-VOL, or the path between primary system and secondary system is in the busy status.
C3CD	The TCz S-VOL is an Siz pair volume.
C3D2	The DKC type of the secondary system is not supported by TCz.
C3D3	SSID or CU number is invalid for specified secondary system.
C3D4	A pair cannot be created because the P-VOL is being used by Volume Migration.
C3D6	The specified S-VOL is unavailable because the connecting port cannot recognize it.
C3D7	The pair status of secondary system's S-VOL is invalid.
C3D8	The pair cannot be created because the volume specified for the S-VOL is a system volume.
C3D9	<p>The pair operation cannot be performed if the TCz P-VOL or the TCz S-VOL meets any of the following conditions:</p> <ul style="list-style-type: none"> <li>▪ The volume is a DP-VOL, and paired using a reserved volume of an Siz pair or Volume Migration.</li> <li>▪ The volume is a DP-VOL and its capacity is being expanded, or pages are being released.</li> </ul>

Error code (SSB2)	Description
	<ul style="list-style-type: none"> <li>▪ The capacity of the P-VOL and the S-VOL is not the same</li> <li>▪ The volume is being initialized by Slz</li> </ul>
C3DB	S-VOL pair status is not PSUS or PSUE.
C410	<p>Operation failed due to either of the following reasons:</p> <ul style="list-style-type: none"> <li>▪ The S-VOL of a pair you selected is in the extended long busy state.</li> <li>▪ A communication time out error has occurred between the local storage system and the remote storage system.</li> </ul>
C4FC	The required amount of shared memory for the operation is not installed in the secondary system.
CB12	TC, TCz, and UR, URz cannot be mixed in the consistency group.
CB19	The secondary system consistency group cannot be deleted because reversing the P-VOL and S-VOL using the <code>horctakeover</code> command failed.
CB1A	Deletion of the secondary system consistency group was abnormally terminated because reversing the P-VOL and S-VOL using the <code>horctakeover</code> command failed.
CB1D	No dummy volume can be created in the S-VOL.
CB1F	The secondary system does not support TCz.
CB20	In referring to the function bit, the system information reference function was abnormally terminated.
CB21	In a Pairresync operation, all difference setting was abnormally terminated.
CB23	An internal error occurred.
CB60	TCz is not installed in the secondary system.
CB66	<p>The TCz pair cannot be created or resynchronized because the differential bitmap area is not available due to one of the following reasons:</p> <ul style="list-style-type: none"> <li>▪ Free area for shared memory in the secondary system is insufficient.</li> <li>▪ Free area for Dynamic Provisioning pool specified as the S-VOL is insufficient.</li> </ul>
CB67	An additional shared memory is not installed in the secondary system.
CB68	The pair cannot be created or resynchronized because the free area for shared memory in the primary system is insufficient and the differential bitmap area cannot be reserved.
CB69	The pair cannot be created because the number of pairs exceeds the maximum number that can be created in a single consistency group.

Error code (SSB2)	Description
CB6E	The paircreate operation cannot run because the P-VOL is a volume in a storage system from another company.
CB6F	The command was rejected because Soft Fence is set for the specified S-VOL.
CB71	The paircreate operation cannot run because the P-VOL is a migration volume in a storage system from another company.
CB73	The paircreate operation cannot run because the S-VOL is a migration volume in a storage system from another company.
CB75	The device is not recognized correctly.
CB76	The paircreate operation cannot run because the paths are specified per storage system.
CB77	The used capacity of the Volume Retention Manager software product on the secondary system exceeds the license capacity.
CB78	The paircreate operation cannot run because the specified S-VOL is defined as the command device.
CB7E	A request for a paircreate operation was rejected because the specified S-VOL belongs to a different CLPR than the registered consistency group's CLPR.
CB9E	<p>A request for a paircreate operation was rejected in the secondary system due to one of the following reasons:</p> <ul style="list-style-type: none"> <li>▪ The function for defining the same consistency group for open and mainframe systems is not supported.</li> <li>▪ The function for defining a consistency group that contains multiple pairs of storage systems is not supported.</li> <li>▪ The function for defining a consistency group for open systems is not supported.</li> <li>▪ The time stamp transfer mode is not supported.</li> </ul>
CBD7	The storage system is in internal processing. Try the operation again.
CBD8	<p>A pair cannot be created because the specified P-VOL is one of the following:</p> <ul style="list-style-type: none"> <li>▪ A journal volume used for URz.</li> <li>▪ A URz secondary volume that is not suspended.</li> </ul>
CBD9	The pair cannot be created because the specified S-VOL is used for Compatible FlashCopy <sup>®</sup> V2 or Hitachi Compatible Software for IBM <sup>®</sup> FlashCopy <sup>®</sup> SE, or is the TSE volume.
CBDA	The paircreate operation cannot run because the used capacity of Volume Retention Manager on the secondary system exceeds the license capacity.

Error code (SSB2)	Description
CBDC	A request for creating a TCz pair was received in the TCz-URz combination status. However, the command was rejected because the mirror ID of URz was 0.
CBDD	In configuring a TCz-URz multi-target configuration, a request for a TCz paircreate operation was rejected because the URz pair was in the process of copying.
CBE2	The paircreate operation cannot run because the P-VOL is a Dynamic Provisioning for Mainframe pool-VOL.
CBE3	The paircreate operation cannot run because the S-VOL is a Dynamic Provisioning for Mainframe pool-VOL.
CBE7	65,280 pairs or more cannot be created in one storage system.
CBEB	The pair cannot be created because the specified P-VOL is being shredded by Volume Shredder.
CBEC	The pair cannot be created because the specified S-VOL is being shredded by Volume Shredder.
CBED	The request for a paircreate operation was rejected because the specified S-VOL was a URz S-VOL or journal volume.
CBEE	<p>The request for a paircreate operation was rejected because the specified P-VOL is already paired for either of the following purposes:</p> <ul style="list-style-type: none"> <li>▪ P-VOL for the differential data resync in URz.</li> <li>▪ P-VOL for the primary site in the 3DC multi-target configuration with three URz sites.</li> </ul>
CBFA	<p>The pair creation failed because of one of the following reasons:</p> <ul style="list-style-type: none"> <li>▪ A CHA in the secondary system for connecting Mainframe is not installed.</li> <li>▪ All CHAs in the secondary system for connecting Mainframe is blocked.</li> </ul>
CBF3	<p>The pair was not created because the specified P-VOL is either of the following:</p> <ul style="list-style-type: none"> <li>▪ An external volume mapped for moving data online</li> <li>▪ An external volume of which data direct mapping attribute is enabled</li> </ul>
CBFC	The pair cannot be created because the consistency group ID is not within the supported range.
FD0B	<p>Operation cannot be completed due to either of the following reasons:</p> <ul style="list-style-type: none"> <li>▪ The S-VOL of a pair you selected is in the extended long busy state.</li> <li>▪ The storage system received the request normally. However, it is taking time to change the pair status.</li> </ul>

Error code (SSB2)	Description
FD0C	The pair cannot be created or resynchronized because the differential bitmap area cannot be reserved due to one of the following reasons: <ul style="list-style-type: none"> <li>Free area for shared memory in the primary system is insufficient.</li> <li>Free area for Dynamic Provisioning for Mainframe pool specified as the P-VOL is insufficient.</li> </ul>
FD0E	Internal processing is being processed in the specified S-VOL. Try again after a while.
FD0F	The pair was not created because the data direct mapping attribute of the specified P-VOL is enabled, and the function of R-DKC for mapping external volumes larger than 4 TB is not supported.

### SSB2=B992 error codes when SSB1 = B901 or B90A

Error Code (SSB1)	Error Code (SSB2)	Description
B901	B992	Pair cannot be created because DKC type does not support TCz Asynchronous.
B90A	B992	Consistency group information cannot be retrieved because TCz or URz is not installed.

### SSB2 error codes when SSB1 = B90B

Error Code (SSB1)	Error Code (SSB2)	Description
B90B	B9E0	The command was rejected because the function for deleting pairs forcibly is not supported.

## Service information messages (SIMs)

The storage system generates a service information message (SIM) to notify users of a possible service requirement. The SVP reports all SIMs related to TrueCopy for Mainframe operations. The SIMs reported to the zSeries and S/390 host are logged in the `SYS1.LOGREC` dataset of the host operating system.

SIMs are classified according to the following severities: service, moderate, serious, or acute.

For more information, see the *System Administrator Guide*.

The following figure shows a typical 32 byte SIM from the storage system. SIMs display on the host console by reference code (RC) and severity. The six digit RC (composed of bytes 22, 23, and 13) identifies the possible error and determines the severity. The SIM type (byte 28) indicates the component that experienced the error. When byte 22 = 21, the SIM is a control unit SIM. When byte 22 = dx, the SIM is a device SIM. When byte 22 = (d8 dc), the pair is TrueCopy for Mainframe. The SIM reference code dbfx indicates that the P-VOL status does not match with the S-VOL status, or the capacity of the paired volume in the secondary system exceeds the licensed capacity of Volume Retention Manager.

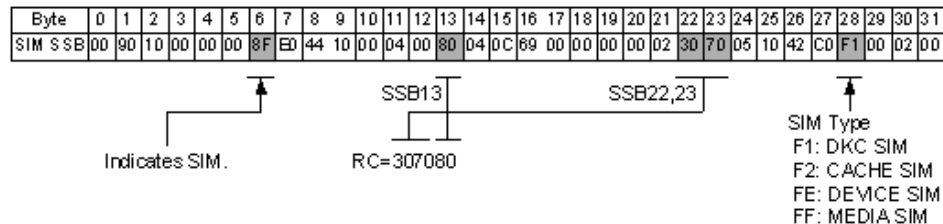

For further information about SNMP operations and SIMs, see the *System Administrator Guide*, *Hitachi Alert Notification Guide*, or contact customer support.

## TPC-R/CSM troubleshooting

The following failure conditions and recovery solutions are provided for the Basic HyperSwap function using TPC-R or CSM.

### Resynchronization fails due to shortage of host resources

If a shortage of resources occurs in the host system, resynchronization of the TrueCopy for Mainframe pair may fail with host system messages: IOSHM0803E (HyperSwap Disabled) and IOSHM0201I (Reason Code:40). In this case, first correct the shortage of host resources by ensuring adequate resources, and then delete the failed TCz pair from TPC-R or CSM and perform the pair create operation again.

### Cache failure, unregistered TPC-R/CSM error

Both the pair create and pair resynchronization operations can fail if a cache failure occurs on the storage system. You can receive an error code unregistered in TPC-R or CSM error messages, 0F0E, in either of these instances.

In both cases, you need to recover the cache failure first and then perform the pair operation again.



**Note:** If you resynchronize pairs before recovering from the cache failure, the resynchronization will fail, and TPC-R or CSM will delete the pair and then recreate the pair, copying the entire P-VOL to the S-VOL.

## Pinned track recovery

Use this procedure to ensure the pair's data integrity while recovering the pinned track.

### Procedure

1. Connect to the primary system of the pair containing a volume with the pinned track and select the CU where the P-VOL is located.
2. Release the pair that contains the volume with the pinned track.
3. Perform your usual procedure for recovering data from a pinned track. See the pinned track recovery procedures for your OS, or contact customer support in recovering the pinned track.
4. Recreate the pair from **Create TC Pairs** Window. Make sure to use Entire Volume in the **Initial Copy Type** option.

## Appendix A: Pair operations using PPRC

VSP 5000 series supports IBM® Peer to Peer Remote Copy (PPRC) TSO and ICKDSF commands for performing TrueCopy for Mainframe operations from the zSeries and S/390 host system. PPRC commands and requirements are described in this topic. However, not all instructions for using the commands are provided. Refer to the IBM® user documentation for more information.

### Overview of PPRC commands

The following operations can be performed using PPRC issued from JCL job cards:

- Port configuration using Device Manager - Storage Navigator (cannot be done using PPRC).

You can change port type (RCU target to initiator, and so on) as part of the pair creation operation using CESTPATH.

- Add and remove remote paths between the main and target systems
- Add and delete pairs
- Split and resume pairs.
- Display pair status and other information.

You cannot change options for remote connections, the CU, initial copy priority, or DFW to Secondary Volume using PPRC commands.

The following table describes TCz operations you perform using Device Manager - Storage Navigator and the corresponding TSO and ICKDSF commands.

HDvM - SN operation	PPRC Commands <sup>1</sup>		Issued to:	Description
	TSO <sup>2</sup>	ICKDSF <sup>3</sup>		
Add remote connection (and edit ports)	CESTPATH	PPRCOPY ESTPATH	primary system	Establishes remote paths from a primary system to a secondary system. The default secondary system options are used. See <a href="#">CESTPATH command (on page 197)</a> for more information.
Remove Remote Connections	CDELPATH	PPRCOPY DELPATH	primary system	Deletes all active paths between a primary system and a secondary system.



HDvM - SN operation	PPRC Commands <sup>1</sup> TSO <sup>2</sup> ICKDSF <sup>3</sup>		Issued to:	Description
View Remote Connection Properties	CQUERY/ PATHS	PPRCOPY QUERY/ PATHS	primary system	Displays the status of all paths for the CU specified by the DEVN parameter. TCz supports the optional FORMAT/ UNFORMAT and VOLUME/PATHS parameters.
Create TC Pairs	CESTPAIR( MODE= COPY)	PPRCOPY ESTPAIR	P-VOL	Creates a pair and sets the Initial Copy Priority and pair options (copy mode = synchronous only, Initial Copy Priority = 0, CFW data = Primary Volume Only, DFW to Secondary Volume = not required). TCz supports the optional MODE, PACE, and CRIT parameters. The MSGREQ parameter defaults to NO.
Split Pairs	CSUSPEND	PPRCOPY SUSPEND	P-VOL or S-VOL	Splits a pair. TCz supports the optional PRIMARY parameter. See WARNING about the QUIESCE parameter at the end of this topic.
Delete Pairs (from primary system)	CDELPAIR	PPRCOPY DELPAIR	P-VOL	Releases a pair from the primary system.
Delete Pairs (from secondary system)	CRECOVER	PPRCOPY RECOVER	S-VOL	Releases a pair from the secondary system.
View Pair Properties	CQUERY/ VOLUME	PPRCOPY QUERY/ VOLUME	P-VOL or S-VOL	Displays pair status of the volume. TCz supports the optional FORMAT/ UNFORMAT and VOLUME/PATHS parameters.
Resync Pairs	CESTPAIR( MODE=RES YNC)	PPRCOPY ESTPAIR	P-VOL	Resynchronizes a pair, and sets the initial copy options and pair options. TCz supports the optional MODE, PACE, and CRIT parameters.
-	P/DAS SWAP	-	primary and secondary system	Supported by TCz. Redirects application I/Os from the P-VOL to the S-VOL.
-	CGROUP (FREEZE/ RUN)	-	primary system (P-VOL or simplex)	Supported by TCz.

HDvM - SN operation	PPRC Commands <sup>1</sup> TSO <sup>2</sup> ICKDSF <sup>3</sup>	Issued to:	Description
<p><b>Notes:</b></p> <ol style="list-style-type: none"> <li>Parameters and format for PPRC commands are not described in this document. For details, see the IBM® publications <i>Advanced Copy Services</i> (SC35 0355), <i>DFSMS MVS V1 Remote Copy Guide and Reference</i> (SC35 0169), <i>ICKDSF User's Guide and Reference</i> (GC35 0033), and other IBM® documents on ICKDSF R16 or later.</li> <li>PPRC TSO commands are issued from the system console to the P-VOL or S-VOL.</li> <li>PPRCOPY ICKDSF commands are issued from JCL job cards.</li> </ol>			

## Options not supported by PPRC

You cannot change the following TCz options using PPRC commands:

- RCU options
- Initial copy priority option
- DFW to Secondary Volume pair options

## Requirements, restrictions, and notes

Note the following when using PPRC commands:

- TrueCopy for Mainframe must be installed on the storage system.
- IBM® PPRC must be installed on the host operating system.
- With CU emulation type I-2107, the `lss` parameter must be set for both the primary and secondary system.
- Command extensions are supported with I-2107 emulation.
- The TSO **CESTPATH** and PPRCOPY **ESTPATH** commands remove paths previously established and replace them with the paths you specify. Make sure to specify existing paths that you want to continue using, or specify new paths.

If you delete all paths prior to running the command because you want to specify new paths with the command, the pair operation might be suspended because no paths exist temporarily.

- With Fibre Channel, do not use the **CESTPATH** and **CDELPATH** commands at the same time that you use the SCSI path definition function of LUN Manager. FC ports need to be configured as Bidirectional ports before the **CESTPATH** and **CDELPATH** commands are issued.
- The **RESETHP** option used with the **CESTPATH** command causes host I/O operations to be rejected. Before you use the **RESETHP** option, stop I/O operations from the host.

- PPRC commands may be rejected if you have registered 0xFFXX to the primary and secondary system SSID. Specify the command excepting 0xFFXX. (**Note:** the 'XX' of 0xFFXX is given in hexadecimal.)
- When you issue the **QUERY** command with the **PATH** option to the S-VOL using ICKDSF, the command might be rejected. If this happens, you can check path status using the **CQUERY** command or Device Manager - Storage Navigator.
- When using I-2107 CU emulation type for the primary system when the host is online to the S-VOL, run the **CESTPAIR** command to create a TCz pair requires **ONLINSEC (YES)** . The operation fails if you do not use **ONLINSEC** or if you use **ONLINSEC (NO)** .

You cannot check whether a host system is online if the secondary system does not support I-2107 CU emulation type. In this case, you can still run the **CESTPAIR** command with **ONLINSEC (YES)** if the primary system is a VSP 5000 series and supports I-2107 CU emulation type.

- If the **PPRCOPY SUSPEND** command issued to a pair in Pending status is rejected, split the pair using Device Manager - Storage Navigator.



**Warning:** The **CSUSPEND** command **QUIESCE** option is disabled by APARs OW15247/48. Make sure to check with customer support before using this command and option on the storage system. If the command and option is issued to certain volumes (for example, active SPOOL, PAGE, or CATALOG datasets, active SYSRES volume), the attached host might enter a deadlock condition, requiring storage control IML to correct the condition.

See APAR OW15247 or 48 and the latest IBM® PPRC documentation for detailed information.

- Preserve Mirror FlashCopy function with Compatible FlashCopy® V2: When you create Compatible FlashCopy® V2 Preserve Mirror relationships in COPY mode, both copies are not synchronized. If you issue **Withdraw** during the copy operation, both copies of the relationship are suspended. Therefore, data consistency between the P-VOL and S-VOL is not ensured even though the TCz pair is in DUPLEX mode. This status can be confirmed by the **CQUERY** command.

The following figure provides an example of when **CQUERY** is issued to the TCz P-VOL using the **VOLUME** parameter. The message, **PAIR WAS THE TARGET OF A WITHDRAWN PRESERVE MIRROR RELATION**, is displayed. To release this status, delete the TCz pair. After creating TCz pairs, **Withdraw** might fail if there is a change in the remote path status without communication in the remote path. This remote path status change might be a path setting change or path blockage for example. This can be resolved by issuing an I/O to the TCz pairs or resynchronizing the pairs after splitting them. For details about the Preserve Mirror FlashCopy function, see the *Hitachi Compatible FlashCopy/FlashCopy SE User Guide*.

```
***** PPRC REMOTE COPY CQUERY - VOLUME *****
*
*              (PRIMARY) (SECONDARY) *
*              SSID CGA LSS SSID CGA LSS*
*DEVICE   LEVEL   STATE   PATH STATUS   SERIAL#   SERIAL#   *
*-----
* 2A1J    PRIMARY.. DUPLEX..  ACTIVE..    4300 10 00   4300 11 00   *
*              CRIT(NC)..... CGRPLB(NO)  00A7F000000  000000099999 *
* PAIR WAS THE TARGET OF A WITHDRAWN PRESERVE MIRROR RELATION *
* PATHS SAID DEST STATUS: DESCRIPTION *
* ----- *
* 1   aabbccdd   01   PATH ESTABLISHED.. *
*   -----   00   NO PATH..... *
*   -----   00   NO PATH..... *
*   -----   UU   NO PATH..... *
* IF STATE = PENDING/SUSPEND: TRACKS OUT OF SYNC = 47277 *
*                               TRACKS ON VOLUME = 50085 *
*                               PERCENT OF COPY COMPLETE = 6% *
* SUBSYSTEM          WWNN          LIO LEVEL *
* ----- *
* PRIMARY... 0000000C00000000    00.05.0300 *
*****
```

## Conventions used in TSO commands

The following table shows typefaces and symbols used in PPRC TSO commands.

Typeface or Symbol	Description	Example
Normal text	Used for command and keyword names or consoles.	CESTPATH
Italic text	Used for parameters that are to be replaced by the appropriate character or number string.	<i>ssid</i>
Square bracket [ ]	Used for keywords and parameters that can be abbreviated.	[CGROUP(YES)]
vertical dash	Used to separate selectable keywords.	(YES NO)

## CESTPATH command

Use the CESTPATH command to establish remote paths from a primary system to a secondary system when using fiber cable. CESTPATH also allows you to enter a Controller ID for the secondary system.

### Requirements

- Fibre Channel ports must be configured as initiator ports or RCU target ports before the CESTPATH and CDELPATH commands are issued.
- When system option mode 114 is enabled, ports are configured automatically when the CESTPATH and CDELPATH TSO commands are run (RCU target/initiator to initiator/RCU target). If this system option mode is disabled, ports must be configured using Device Manager - Storage Navigator.
- With Fibre Channel, do not use the CESTPATH and CDELPATH commands at the same time as the LUN Manager SCSI path definition function.

### CESTPATH command syntax

Use the following syntax for the CESTPATH command:

```
CESTPATH DEVN (X'dev#) PRIM (X'ssid' serial# X'lss') SEC (X'ssid'
serial# X'lss') LINK (X'aabbccdd') [CGROUP (YES|NO)]
```

When WWNN (World Wide Node Name) is specified, use the following syntax:

```
CESTPATH DEVN (X'dev#) PRIM (X'ssid' WWNN X'lss') SEC (X'ssid' WWNN
X'lss') LINK (X'aabbccdd') [CGROUP (YES|NO)]
```

**Note:**

- For CDELPATH, the syntax for both PRIM and SEC is the same as CESTPATH.
- A unit check is reported on earlier model storage systems that do not support the syntax above.

## CESTPATH parameters

When fibre is used, CESTPATH parameters are the following.

Parameter	Description
aa	Bit 0 - 3: secondary system controller ID x2 – xF: Number stands for secondary system controller ID. <ul style="list-style-type: none"> <li>▪ VSP 5000 series: x'8'</li> <li>▪ VSP G1000, VSP G1500, VSP F1500: x'7'</li> <li>▪ VSP: x'6'</li> </ul> Bit 4-7: Unused (x0 fixed)
bb	Primary system port number (0x00-0xff)
cc	Secondary system port number (0x00-0xff)
dd	Secondary system CU number (0x00-0xfe)

When WWNN is specified, CESTPATH parameters are the following.

Parameter	Description
aabb	Primary system SAID (x'00 and port number)
ccdd	Secondary system SAID (x'00 and port number)

WWN is the unique number for the controller and is indicated as follows.

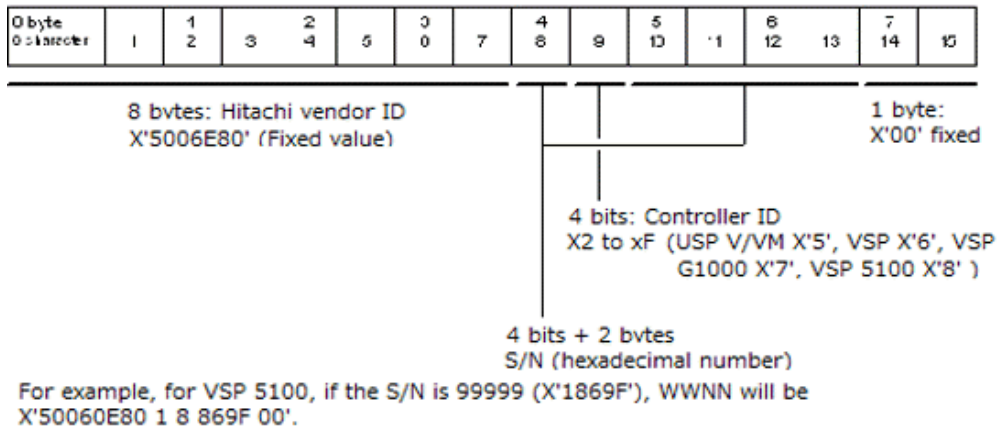

## I/O control after failure with CGROUP FREEZE/RUN

When a failure occurs in the P-VOL, you can stop host I/O and copy operations, and then restart them when conditions improve using the TSO **CGROUP** command with the **FREEZE** and **RUN** options.

- **CGROUP FREEZE:**

- Stops host I/O to specified P-VOLs

Presents state change pending (SCP) with extended long busy status to host I/O requests. This causes the host to queue I/Os for the P-VOLs. SCP is indicated until the **CGROUP/RUN** command is issued or until the SCP time expires. (Pairs registered in a consistency group are not in the SCP state, even after the **CGROUP/FREEZE** command is run.)

- Stops update copy operations to specified S-VOLs

Remote paths are blocked between the specified primary and secondary system to stop update copy operations to the S-VOLs.

- Splits pairs with P-VOLs on the specified primary system CU

(Pairs registered in a consistency group are not in the SCP state, even after the **CGROUP/FREEZE** command is run.)

When paths are established between all primary and secondary sites, check the SCP time currently set for the primary system in the **Edit SCP Time** window of Device Manager - Storage Navigator. After that, use the **CGROUP/FREEZE** command to specify the SCP time of the primary storage system. The range for the SCP time is 0 to 518,400 seconds (144 hours), and the default is 120 seconds.

If the specified primary system does not have the TCz primary volume, the **CGROUP/FREEZE** command ends normally, but the processing is not performed (paths are not blocked, and the state does not change to SCP).

Also, the SCP time specified from the CU Option dialog box of Device Manager - Storage Navigator is invalid for pairs created using a consistency group from Business Continuity Manager. You can, however, specify the SCP time for these pairs using the **YKFREEZE** command (range from 1 to 5 seconds). If pairs are suspended by failure, then the SCP time is fixed to 120 seconds and cannot be changed.

In an environment where the **CGROUP/FREEZE** command is not issued automatically, if you change the SCP time, SCP continues for the SCP time you set. In this case, during the SCP time, the host might not be able to access the P-VOL.

- **CGROUP RUN:**

- Starts host I/O to P-VOLs again

- Presents a state change interrupt (SCI) to the hosts, so that they reissue the I/Os that were waiting while the P-VOLs were in the SCP state.

- Changes the P-VOL fence level to Never (**PPRC CRIT=NO**), so that the split P-VOLs accept host write I/O operations.



The **CGROUP FREEZE/RUN** command is supported for VSP 5000 series when it functions as the primary system. The storage system provides all required host reporting for **CGROUP** operations (for example, IEA494I with extended long busy (ELB) state), which is a key component of operations in the IBM® Geographically Dispersed Parallel Sysplex (GDPS) environment, which also uses this command.

For disaster recovery implementations, VSP 5000 series systems must be used at both sites, because the secondary systems will be switched to primary systems.



**Caution:** VSP 5000 series also supports the Business Continuity Manager **Freeze** and **Run** commands, which are equivalent to the TSO **CGROUP** command. If both commands are performed simultaneously, the storage systems find the appropriate volumes and run the commands.

However, in this situation, the host cannot detect which command is performed. Therefore, it is important not to use the Business Continuity Manager **Freeze/Run** commands and the **CGROUP** command at the same time.

## CGROUP FREEZE/RUN requirements

The **CGROUP** command can only be issued to a P-VOL or a simplex volume in the primary system. If issued to an S-VOL, the secondary system rejects it with `F/M=0F, reason code=58`.

The requirements for **CGROUP FREEZE/RUN** support are:

- Storage system: The primary system to which the **CGROUP** command will be issued must be a VSP 5000 series system. The **CGROUP** command supports all mainframe systems, including those in a configuration where open systems and mainframe systems are mixed.
- PPRC: The host systems at the primary and secondary sites must have IBM® PPRC support and the PPRC ERP PTF.
- SSIDs: The primary system to which the **CGROUP** command will be issued must have consecutive SSIDs. The service representative configures the SSIDs on the SVP.



**Caution:**

MVS requires that the storage system be offline during SSID changes. Reconfiguring SSIDs is therefore a disruptive event that must be carefully planned.

- When you run **CGROUP FREEZE** or **RUN**, the following information must be specified:
  - The device, which is the P-VOL or simplex volume LDEV ID (DEVN parameter)
  - The primary system, which consists of the serial number and lowest SSID in the CU (PRIM parameter).
  - The secondary system, which consists of the serial number and lowest SSID in the CU (SEC parameter).

## Pair status before and after CGROUP FREEZE/RUN

The following table shows pair status for P-VOLs and S-VOLs before and after **CGROUP FREEZE/RUN** operations.

	Before CGROUP FREEZE/RUN		After CGROUP/FREEZE		After CGROUP/RUN	
	P-VOL	S-VOL	P-VOL	S-VOL	P-VOL	S-VOL
Status	Simplex	-	Simplex	-	Simplex	-
	Pending	Pending	Suspend	Pending	Suspend	Pending
	Duplex	Duplex	Suspend	Duplex	Suspend	Duplex
	Suspend	Suspend	Suspend	Suspend	Suspend	Suspend

## Using CGROUP

The following figure shows a simple example of the **CGROUP FREEZE/RUN** command implemented in a GDPS environment.

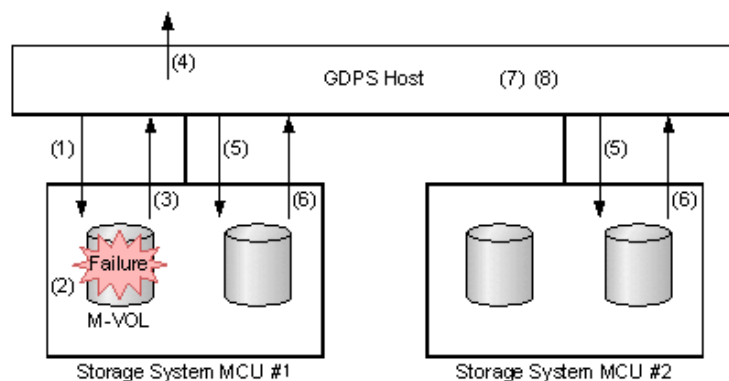

Figure key:

1. Read/write I/Os are issued from the host.
2. A failure occurs on a P-VOL, and the primary system suspends the pair.
3. Split and extended long busy state are reported to the host.
4. The host reports IEA494I with extended long busy state.
5. CGROUP/FREEZE commands are issued to groups.
6. SCP sense bytes are reported if an I/O is issued to a frozen volume.
7. I/Os are queued at the host.
8. Host operations are switched to secondary site.

## Command sequence example

You can issue **CGROUP FREEZE/RUN** commands manually or through automation (such as with GDPS). The following is an example sequence of actions you can implement.

1. Suspend host updates to all specified TCz P-VOL.

2. Block the specified primary-secondary system path to stop update copy operations to S-VOLs.

If the specified primary system does not have any P-VOLs, the FREEZE command is run without performing any operations (paths are not blocked, SCP is not indicated).

3. Change all P-VOLs to Suspend status.
4. Resume host updates to suspended P-VOLs.
5. Run the add secondary system operation to reestablish the blocked remote paths. After paths are established, make sure to specify the desired SCP time for the primary system using the Device Manager - Storage Navigator Edit SCP Time window. The range for SCP time is 0 to 518,400 seconds (144 hours), and the default is 120 seconds.



**Note:** If your specified SCP time is 601 seconds or longer, the microcode version cannot be downgraded to 70-03-xx-xx/xx or earlier. In this case, decrease the SCP time setting to 600 seconds or less, downgrade, and then reset to the desired time.

6. After the path is reestablished, run the resynchronize pair operation.

## Other TSO commands used with CGROUP

You can use the following TSO commands in your CGROUP FREEZE/RUN workflow:

- Use **CESTPATH** to recover a blocked primary-secondary path. Make sure to use the same parameters as when the path was established.
- After reestablishing the primary-secondary path that was blocked, use **CESTPAIR/RESYNC** to resynchronize the TCz pairs split by **CGROUP/FREEZE**.
- After reestablishing the primary-secondary path that was blocked, use **CDELPAIR** to release the pairs split by **CGROUP/FREEZE**. If **CDELPAIR** is issued to a pair whose primary-secondary path is still blocked, the primary system rejects the command (F/M=0F, TCz reason code=5A).
- Use **CRECOVER** to change a split S-VOL to simplex. This command is issued to the S-VOL and does not affect the split P-VOL.
- Use **CQUERY** to generate output about paths and volumes after running **CGROUP FREEZE/RUN**. See the next section for examples.

## Example output for CQUERY

The following examples show output for **CQUERY - PATHS/VOLUMES** after **CGROUP FREEZE** has run. Output is for illustration purposes only. Do not use.

### CQUERY - PATHS

The following figure shows example output when **CQUERY** is issued to a primary system to which **CGROUP/FREEZE** was issued.

```

***** PPRC REMOTE COPY CQUERY - PATHS *****
* PRIMARY UNIT: SERIAL# 00000090217 SSID= 00F8 *
*          FIRST          SECOND          THIRD          FOURTH *
*          SECONDARY      SECONDARY      SECONDARY      SECONDARY *
*SERIAL NO: ----- *
*          SSID: ----- *
*          PATHS:    0          0          0          0 *
*          SAID DEST S* SAID DEST S* SAID DEST S* SAID DEST S* *
*          ----- -- ----- -- ----- -- ----- -- *
*          1: ----- 00 ----- 00 ----- 00 ----- 00 *
*          2: ----- 00 ----- 00 ----- 00 ----- 00 *
*          3: ----- 00 ----- 00 ----- 00 ----- 00 *
*          4: ----- 00 ----- 00 ----- 00 ----- 00 *
* * *
* S* = PATH STATUS: *
* 00=NO PATH          01=ESTABLISHED          02=INIT FAILED *
* 03=TIME OUT        04=NO RESOURCES AT PRI 05=NO RESOURCES AT SEC*
* 06=SERIAL# MISMATCH 07=(RESERVED)          08=(RESERVED) *
* 09=(RESERVED)      10=CONFIGURATION ERROR *
*****

```

The following figure shows example output when CQUERY is issued to the secondary system that has a blocked path due to the CGROUP/FREEZE command.

```

***** PPRC REMOTE COPY CQUERY - PATHS *****
* PRIMARY UNIT: SERIAL# ----- SSID= 0000 *
*          FIRST          SECOND          THIRD          FOURTH *
*          SECONDARY      SECONDARY      SECONDARY      SECONDARY *
*SERIAL NO: ----- *
*          SSID: ----- *
*          PATHS:    0          0          0          0 *
*          SAID DEST S* SAID DEST S* SAID DEST S* SAID DEST S* *
*          ----- -- ----- -- ----- -- ----- -- *
*          1: ----- 00 ----- 00 ----- 00 ----- 00 *
*          2: ----- 00 ----- 00 ----- 00 ----- 00 *
*          3: ----- 00 ----- 00 ----- 00 ----- 00 *
*          4: ----- 00 ----- 00 ----- 00 ----- 00 *
* * *
* S* = PATH STATUS: *
* 00=NO PATH          01=ESTABLISHED          02=INIT FAILED *
* 03=TIME OUT        04=NO RESOURCES AT PRI 05=NO RESOURCES AT SEC*
* 06=SERIAL# MISMATCH 07=(RESERVED)          08=(RESERVED) *
* 09=(RESERVED)      10=CONFIGURATION ERROR *
*****

```

### CQUERY - VOLUME

The following figure provides example output when CQUERY is issued to a P-VOL that has been split by CGROUP/FREEZE. The output also shows the status of the FREEZE option: CGRPLB(YES) = enabled, CGRPLB(NO) = disabled.



**Note:** The values for WWNN and LIC LEVEL in this figure and the next are invalid. Do not use the values.

```

***** PPRC REMOTE COPY QUERY - VOLUME ***** M-VOL is suspended by
*                                     (PRIMARY) (SECONDARY) * CGROUP/FREEZE.
*                                     SSID CCA  SSID CCA  *
*DEVICE  LEVEL  STATE  PATH STATUS  SERIAL#  SERIAL#  *
*-----  -----  -----  -----  -----  -----  *
* 0F80  PRIMARY.. SUSPEND(A)  INACTIVE  00F8 00  00F8 02  *
*                                     GRIT (NO)..... CGRPLB (YES) 0000000217 000000090217 *
* PATHS SAID/DEST STATUS: DESCRIPTION *
*-----  -----  -----  -----  *
* 0 00  NO PATH..... *
* 00  NO PATH..... *
* 00  NO PATH..... *
* 00  NO PATH..... *
*                                     PERCENT OF COPY COMPLETE = 100% *
* SUBSYSTEM  WNNN  LIC LEVEL *
*-----  -----  ----- *
* PRIMARY... 0000000000000000 3.8.05.0000 *
*****

```

Annotations in the image: "M-VOL is suspended by CGROUP/FREEZE." points to the header. "FREEZE option is enabled." points to the SUSPEND(A) state. "Logical path is NO PATH" points to the NO PATH path status.

The following figure provides example output when **CQUERY** is issued to an S-VOL with a P-VOL has been split by the **CGROUP/FREEZE** command. The pair status and path status at the secondary system are not changed.

```

***** PPRC REMOTE COPY QUERY - VOLUME ***** No change to R-VOL pair
*                                     (PRIMARY) (SECONDARY) * status
*                                     SSID CCA  SSID CCA  *
*DEVICE  LEVEL  STATE  PATH STATUS  SERIAL#  SERIAL#  *
*-----  -----  -----  -----  -----  -----  *
* 0F82  SECONDARY DUPLEX...  ACTIVE...  00F8 00  00F8 02  *
*                                     ..... 000000090217 *
* PATHS SAID/DEST STATUS: DESCRIPTION *
*-----  -----  -----  -----  *
* 0 00  NO PATH..... *
* 00  NO PATH..... *
* 00  NO PATH..... *
* 00  NO PATH..... *
* SUBSYSTEM  WNNN  LIC LEVEL *
*-----  -----  ----- *
* PRIMARY... 0000000000000000 3.8.05.0000 *
*****

```

Annotations in the image: "No change to R-VOL pair status" points to the header. "No change to path status" points to the ACTIVE path status. "Logical path is NO PATH" points to the NO PATH path status.

## IEA494I and IEA491E console messages

When a pair is split, whether user-requested or caused by failure, the primary system generates sense information to notify the hosts. If the PPRC ERP PTF is installed and PPRC support by host = Yes is selected on the Device Manager - Storage Navigator Change CU Options window, this notification results in an IEA494I system console message and an IEA491E message. The IEA491E message indicates the reason for the split. The IEA494I and IEA491E messages are generated by the zSeries and S/390 host based upon SSBs (sense bytes) from the storage system and not SIMs from the storage system. Therefore, SIMs reported by the storage system to the host are not used by the GDPS scripting.

The IEA494I message is recommended as a trigger for automation over the IEA491E message. The IEA491E message is reported to only one host system, whereas the IEA494I message is reported to all attached MVS hosts each time the P-VOL pair status changes. GDPS uses the IEA494I message with extended long busy as a trigger for CGROUP (FREEZE/RUN).

If you have specified PPRC support by host = No, the host generates the system console message that includes the SIM instead of the IEA494I or IEA491E message.

## IEA494I message

When a TCz pair status changes, with the exception of the transition states suspending and deleting, the primary system reports state change interrupt (SCI) to all hosts. In response to the SCI, the IEA494I system console message is generated (if supported by the host). The storage system reports SCI for both online and offline devices, but the host system does not generate console messages for offline devices. Therefore, the IEA494I message is never generated with an S-VOL device address.

- The primary system reports SCI for all P-VOLs that are in the SCP state due to the CGROUP/FREEZE command. The following example shows an IEA494I message indicating the extended long busy state:

```
IEA494I 0FC3,RD0FC3,PPRC PAIR SUSPENDING,SSID=0FC0,CCA=03,
EXTENDED LONG BUSY STATE
```

- The primary system reports SCI for all P-VOLs that are split due to the CGROUP/FREEZE command. This IEA494I message indicates the extended long busy state.
- When the FREEZE option is enabled, the primary system reports SCI for a pair that is split due to a failure. When the host supports GDPS, this IEA494I message with extended long busy triggers the CGROUP (FREEZE/RUN) command.

## IEA491E message

When a pair is split due to a failure, the primary system reports SCI and unit check status and sense bytes with F/M = FB. In response to the F/M=FB sense bytes, the IEA491E system console message is generated (if supported by the host). The following is an example of an IEA491E message:

```
IEA491E DSLFC0,PPRC SUSPENDED, SECONDARY NOT READY,
INTERVENTION_REQUIRED, (PRI) SER=0113-90797, CCA=00
(SEC) SER=0113-90217, CCA=
```

If the host supports GDPS and the FREEZE option is enabled, the IEA494I system console message with extended long busy (which was generated in response to the SCI) triggers the CGROUP (FREEZE/RUN) command.

## Storage system response characteristics to failure conditions

VSP 5000 series supports **CGROUP** in the GDPS environment by performing PPRC-compatible actions and returning PPRC-compatible messages according to failure conditions.

In the Device Manager - Storage Navigator Change CU Options window, PPRC support by host must be enabled (Yes). If it is disabled (No), the host processor generates a system console message that includes the SIM instead of the IEA494I or IEA491E message.

The following figure shows failure conditions, with corresponding storage system response characteristics in the table following the figure.

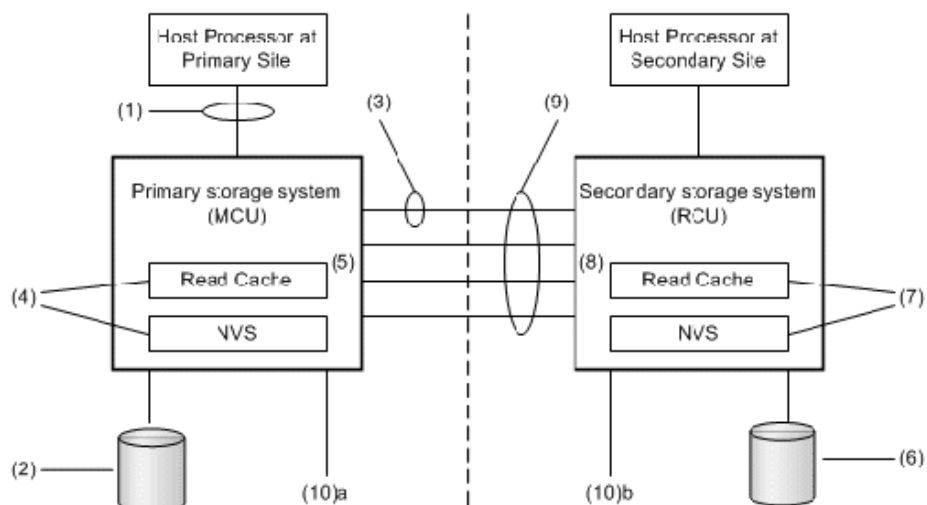

Failure condition		Pairs split?	Expected messages	FREEZE function
1. Failure of all channel interfaces on the primary system		No	No IEA480E, IEA491E, or IEA494I messages display.	Not activated <sup>1</sup>
2. Failure of a disk on the primary system	Failure of one physical disk in a parity group	No	(1) IEA480E message (SIM for blocked physical disk or disk's port) is displayed when the next I/O is issued to any volume in the parity group.  (2) No IEA491E or IEA494I messages display.	Not activated <sup>1</sup>
	Failure of two physical disks in a parity group	No	(1) IEA480E message (SIM for blocked LDEV) is displayed when the next I/O is issued to any volume in the parity group.  (2) No IEA491E or IEA494I messages display.	Not activated <sup>2</sup>
3. Failure of a link between the primary and secondary system		No	(1) IEA480E message (SIM for blocked TCz path) is reported when the next I/O to any device in this primary system is issued.  (2) No IEA491E or IEA494I messages display.	Not activated

Failure condition		Pairs split?	Expected messages	FREEZE function
4. Failure of NVS on the primary system, failure of primary system read cache	One side of primary system cache blocked due to failure	No <sup>3</sup>	(1) IEA480E (SIM for cache blocked) is reported when the next I/O to any device in this primary system is issued.  (2) No IEA491E or IEA494I messages display.	Not activated
	One side of primary system cache blocked due to maintenance	No <sup>3</sup>	No IEA480E, IEA491E, or IEA494I messages display.	Not activated
	One side of primary system cache blocked by SET CACHE OFF	No <sup>3</sup>	No IEA480E, IEA491E, or IEA494I messages display.	Not activated
5. Both sides of primary system cache blocked due to failure		No	No IEA480E, IEA491E, or IEA494I messages display. The primary system returns CC=3 for all I/Os.	Not activated
6. Failure of a disk on the secondary system	Failure of a disk in a parity group	No	(1) The secondary system reports IEA480E message (SIM for blocked disk or disk's port) to either the primary system or the host processor (whichever issues the next I/O first) when the next I/O is issued to any volume in the parity group. If primary system receives the SIM, it passes the SIM to the attached host processor, and the IEA480E message is reported when the next I/O to this primary system is issued to any P-VOL paired with the volume in the parity group.  (2) No IEA491E or IEA494I messages display.	Not activated



Failure condition		Pairs split?	Expected messages	FREEZE function
	Failure of two disks in a parity group	Yes	<p>(1) The secondary system reports IEA480E message (SIM for LDEV blocked) to either the primary system or the host processor (whichever issues the next I/O first) when the next I/O is issued to any volume in the parity group. If primary system receives the SIM, it passes the SIM to the attached host processor, and the IEA480E message is reported when the next I/O to this primary system is issued to any P-VOL paired with the volume in the parity group.</p> <p>(2) One or more IEA494I message showing EXTENDED LONG BUSY display.</p> <p>(3) One or more IEA491E or IEA494I message showing PAIR SUSPENDED display.</p>	Activated if the FREEZE option is enabled for the affected primary system pairs.
7. Failure of NVS on the secondary system, failure of secondary system read cache	One side of secondary system cache blocked due to failure	No	(1) The secondary system reports IEA480 message (SIM for cache blocked) to either the primary system or the host processor (whichever issues the next I/O first). If primary system receives the SIM, it passes the SIM to the attached host processor. Therefore, IEA480 is reported when the next I/O to any device in this primary system issued. (2) No IEA491E or IEA494I messages display.	Not activated
	One side of secondary system cache blocked due to maintenance	No	No IEA480, IEA491E, or IEA494I messages display.	Not activated

Failure condition		Pairs split?	Expected messages	FREEZE function
	One side of secondary system cache blocked by SET CACHE OFF	No	No IEA480, IEA491E, or IEA494I messages display.	Not activated
8. Both sides of secondary system cache blocked due to failure		Yes	<p>(1) No IEA480 (SIM for blocked cache) is displayed.</p> <p>(2) One or more IEA494I message showing EXTENDED LONG BUSY display.</p> <p>(3) One (or more) IEA491E and IEA494I messages showing PAIR SUSPENDED display.</p> <p>(4) If CGROUP FREEZE and RUN are issued, IEA494I messages showing PAIR SUSPENDED display when the primary system accepts CGROUP RUN. These messages are from the TCz pairs for which FREEZE option is enabled, and from main volumes that did not already report IEA491E/IEA494I at (3).</p>	Activated if the FREEZE option is enabled for the affected primary system pairs.
9. Failure of all links between the primary and secondary system		Yes	<p>(1) IEA480 (SIM for TCz path blocked) message is reported when the next I/O to any device in this primary system is issued.</p> <p>(2) One or more IEA494I message showing EXTENDED LONG BUSY display.</p> <p>(3) One or more IEA491E or IEA494I message showing PAIR SUSPENDED display.</p>	Activated if the FREEZE option is enabled for the affected primary system pairs.
10. Power failure	a. On the primary system	No	No IEA480, IEA491E, or IEA494I messages display.	Not activated

Failure condition		Pairs split?	Expected messages	FREEZE function
	b. On the secondary system	Yes	(1) IEA480 (SIM for blocked TCz path) message is reported when the next I/O to any device in this primary system is issued. (2) One or more IEA494I message showing EXTENDED LONG BUSY display. (3) One or more IEA491E or IEA494I message showing PAIR SUSPENDED display.	Activated if the FREEZE option is enabled for the affected primary system pairs.
<b>Notes:</b> <ol style="list-style-type: none"> <li>1. Because of the nature of the failure, there is no means of activating the FREEZE feature.</li> <li>2. FREEZE is not activated, though activation is possible with the relevant command.</li> <li>3. When one side of the primary system cache is blocked, TCz pairs in Duplex status are not affected, but Pending pairs are split. Splitting pairs in Pending status provides additional protection against unexpected events caused by cache failure.</li> </ol>				

## GDPS and TrueCopy for Mainframe features

The following table shows GDPS and TCz features supported by IBM 3990-6E, VSP 5000 series, VSP G1000, VSP G1500, VSP F1500, and VSP.



**Note:** The information shown might not be current. Contact the customer support for the latest GDPS TCz matrix information.

Feature	IBM® 3990 6E	VSP G1000, VSP G1500, VSP F1500	VSP 5000 series	VSP
GDPS				
Planned outage	Supported	Supported	Supported	Supported
Unplanned outage using IEA494I	Supported	Supported	Supported	Supported

Feature	IBM® 3990 6E	VSP G1000, VSP G1500, VSP F1500	VSP 5000 series	VSP
IEA494I Long Busy message	Default time of 120 sec for FREEZE after IEA494I message is issued.	Default time for FREEZE is 120 seconds. The range for this option is 0 to 518,400 seconds (144 hours) after IEA494I message is issued.	Default time for FREEZE is 120 seconds. The range for this option is 0 to 518,400 seconds (144 hours) after IEA494I message is issued.	Default time for FREEZE is 120 seconds. The range for this option is 0 to 518,400 seconds (144 hours) after IEA494I message is issued.
Peer-to-Peer Remote Copy	PPRC	TCz	TCz	TCz
Hardware based	3990-6 to 3990-6	VSP 5000 series, VSP G1000, VSP G1500, VSP F1500, VSP, and USP V/VM to VSP 5000 series, VSP G1000, VSP G1500, VSP F1500, VSP and USP V/VM.	VSP 5000 series, VSP G1000, VSP G1500, VSP F1500, and VSP to VSP 5000 series, VSP G1000, VSP G1500, VSP F1500, and VSP	VSP 5000 series, VSP G1000, VSP G1500, VSP F1500, VSP, USP V/VM, and TagmaStore USP/TagmaStore NSC to VSP 5000 series, VSP G1000, VSP G1500, VSP F1500, VSP, USP V/VM and TagmaStore USP/TagmaStore NSC.
Interface between storage systems	ESCON® – max of 43 km communication using channel extenders	Communication using switch and extender using Fibre Channel and Fibre Channel cable	Communication using switch and extender using Fibre Channel and Fibre Channel cable	Communication using switch and extender using Fibre Channel and Fibre Channel cable
Copy modes supported	Synchronous	Synchronous	Synchronous	Synchronous
Dual Copy combination support	Supported	Not Supported. Dual Copy is not supported by storage system.	Not Supported. Dual Copy is not supported by storage system.	Not Supported. Dual Copy is not supported by storage system.

Feature	IBM® 3990 6E	VSP G1000, VSP G1500, VSP F1500	VSP 5000 series	VSP
TSO command Support	Supported	Supported. Some additional options only available using Device Manager - Storage Navigator/SVP.	Supported. Some additional options only available using Device Manager - Storage Navigator/SVP.	Supported. Some additional options only available using Device Manager - Storage Navigator/SVP.
ICKDSF command support	Supported	Supported. Some additional options only available using Device Manager - Storage Navigator/SVP.	Supported. Some additional options only available using Device Manager - Storage Navigator/SVP.	Supported. Some additional options only available using Device Manager - Storage Navigator/SVP.
P/DAS support	Supported	Supported	Supported	Supported
Maximum pairs	64	65,280	65,280	32,768
Maximum paths between storage systems	4	8 per logical control unit	8 per logical control unit	8 per logical control unit
Number of copy operations on initial copy	4	Default is 4 per CU. Requires Device Manager - Storage Navigator to change value in range from 1 to 16.	Default is 4 per CU. Requires Device Manager - Storage Navigator to change value in range from 1 to 16.	Default is 4 per CU. Requires Device Manager - Storage Navigator to change value in range from 1 to 16.
Dedicated interface between storage systems	No	Requires main storage system port to be set to target by Device Manager - Storage Navigator (or SVP) or automatically in response to establish and delete path commands.	Requires main storage system port to be set to target by Device Manager - Storage Navigator (or SVP) or automatically in response to establish and delete path commands.	Requires main storage system port to be set to target by Device Manager - Storage Navigator (or SVP) or automatically in response to establish and delete path commands.

Feature	IBM® 3990 6E	VSP G1000, VSP G1500, VSP F1500	VSP 5000 series	VSP
PACE parameter initial copy option	1-255, default is 15 (setting of 1 copies a maximum of 3 tracks at a time, 2-255 copies a maximum of 15 tracks at a time)	3 or 15, default = 15 tracks	3 or 15, default = 15 tracks	3 or 15, default = 15 tracks
CRITICAL pair error options (Fence Level parameter)	Yes No – Default	S-VOL Data Never – Default S-VOL Status	S-VOL Data Never – Default S-VOL Status	S-VOL Data Never – Default S-VOL Status
CGROUP	FREEZE/RUN by logical controller SSID pair	FREEZE/RUN by logical controller SSID pair.	FREEZE/RUN by logical controller SSID pair.	FREEZE/RUN by logical controller SSID pair.
CQUERY	Supported	Supported.	Supported.	Supported.
TCz Unique Features specified using Device Manager - Storage Navigator or SVP only				
Remote Connection Options				
Minimum paths	Not supported	Default = 1. If the minimum number of primary system-secondary system active paths falls below this value, all pairs will be split based on the Primary Volume Fence Level option in effect.	Default = 1. If the minimum number of primary system-secondary system active paths falls below this value, all pairs will be split based on the Primary Volume Fence Level option in effect.	Default = 1. If the minimum number of primary system-secondary system active paths falls below this value, all pairs will be split based on the Primary Volume Fence Level option in effect.
CU Options				
PPRC support by host	Host must support PPRC	Default = YES - PPRC supported, optional capability to allow host support for non-PPRC capable operating systems.	Default = YES - PPRC supported, optional capability to allow host support for non-PPRC capable operating systems.	Default = YES - PPRC supported, optional capability to allow host support for non-PPRC capable operating systems.

Feature	IBM® 3990 6E	VSP G1000, VSP G1500, VSP F1500	VSP 5000 series	VSP
Secondary system to primary system SIM reporting	Not supported per IBM® document <i>Planning for IBM Remote Copy</i> (SG24-2594-009 p.184)	To any host or only to secondary system host	To any host or only to secondary system host	To any host or only to secondary system host
Secondary system to primary system service SIM reporting	Not supported per IBM® document <i>Planning for IBM Remote Copy</i> (SG24-2594-009 p.184)	Default = Not report. Designed for non-MVS operating systems that do not support SIM reporting.	Default = Not report. Designed for non-MVS operating systems that do not support SIM reporting.	Default = Not report. Designed for non-MVS operating systems that do not support SIM reporting.
Pair Options				
CFW Data	Not supported	Optional to S-VOL, default = Primary Volume Only	Optional to S-VOL, default = Primary Volume Only	Optional to S-VOL, default = only M-VOL
Max. volumes	256 per storage system	256 per CU	256 per CU	256 per CU
SIM/error messages	Per IBM® document	Per IBM® document	Per IBM® document	Per IBM® document
Local storage system interface	Parallel or ESCON®	FICON®	FICON®	FICON®
Remote storage system interface	Parallel or ESCON®	FICON®	FICON®	FICON®
Channel extender support	Yes	Contact customer support.	Contact customer support.	Contact customer support.

## Appendix B: TCz CLI reference

Commands and options for configuring, operating, monitoring, and maintaining TrueCopy for Mainframe pairs, and for working with consistency groups, are provided for CCI.

### Configuration commands and options

The following table lists the commands and options for configuring TCz.

Operation	Option	Avail. in HDvM - SN?	CCI command and options	BCM <sup>1</sup> command	PPRC <sup>2</sup> command and options
Edit Ports	Port Attribute	Yes	raidcom modify port <i>-port_attribute port attribute</i>	none	none
Add Remote Connection	Connection Type	Yes	none	none	none
	Remote Storage System	Yes	raidcom add rcu <i>-rcu serial# mcu# rcu# id</i>	YKBLDPTH	CESTPATH [Specify by serial#] <sup>3</sup> PRIM(mssid#, mserial#, mcu#) SEC(rssid#, rserial#, rcu#) [Specify by WWNN] <sup>4</sup> PRIM(mssid#, mwwnn#, mcu#) SEC(rssid#, rwwnn#, rcu#)
	Remote Paths	Yes	raidcom add rcu <i>-cu_free serial# id pid</i>	YKBLDPTH	CESTPATH [Specify by serial#] <sup>5</sup> LINK(x'abccdde', x'abccdde' ...) [Specify by WWNN] <sup>6</sup> LINK(x'ccccddd', x'ccccddd' ...)



Operation	Option	Avail. in HDvM - SN?	CCI command and options	BCM <sup>1</sup> command	PPRC <sup>2</sup> command and options
	RIO MIH Time	Yes	raidcom modify rcu -rcu_option <i>mpth rto rtt</i> [fzd fze]	none	none
Edit Remote Replica Options	Copy Type	Yes	none	none	none
	Maximum Initial Copy Activities	Yes	none	none	none
	Services SIM of Remote Copy	Yes	none	none	none
	PPRC support	Yes	none	none	CESTPATH none PPRC:"Yes" other than PPRC:"No"
	Blocked Path Monitoring	Yes	none	none	none
Edit SCP Time	None	Yes	none	none	none

**Notes:**

1. There are no BCM attribute definitions nor options for configuration commands.
2. TSO command/ICKDSF command.
3. mssid#: SSID# of CU to which primary volume belongs, mserial#: Serial number of Local Storage System, mcu#: CU# of primary volume, rssid#: SSID# of CU to which secondary volume belongs, rserial#: Serial# of Remote Storage System, rcu#: CU# of secondary volume
4. mssid#: SSID# of CU to which primary volume belongs, mwwnn#: WWNN(World Wide Nord Name) of Local Storage System, mcu#: CU# of primary volume, rssid#: SSID# of CU to which secondary volume belongs, rwwnn#: WWNN(World Wide Nord Name) of Remote Storage System, rcu#: CU# of secondary volume
5. a: Controller ID, b: "0" fixed, cc: Initiator Port, dd: RCU Target Port, ee: Secondary volume CU#
6. cc: Initiator Port, dd: RCU Target Port

## Pair operation commands and options

The following table lists the commands and options for performing TCz pair operations.

Operation	Option	Avail. in HDvM - SN?	CCI command and options	BCM		PPRC* command and options
				command and option	definition attribute	
Create TC Pairs	Copy Type	Yes	paircreate -fg -jp	YKMAKE none	Copy Group Type	CESTPAIR none
	Primary Volume Fence Level	Yes	paircreate -fg	YKMAKE none	FENCE LVL	CESTPAIR CRIT(yes no)
	Initial Copy Type	Yes	paircreate -nocopy	YKMAKE NOCOPY	none	CESTPAIR MODE(copy nocopy resync)
	Copy Pace	Yes	paircreate -c	YKMAKE none	COPY PACE (SLOW/NORMAL)	CESTPAIR none
	Initial Copy Priority	Yes	paircreate	YKMAKE none	none	none
	Differential Management	No	paircreate -m	YKMAKE none	DIF UNIT	CESTPAIR none
	DFW to Secondary Volume	Yes	none	YKMAKE none	none	CESTPAIR none
	Host I/O Time Stamp Transfer	Yes	none	YKMAKE none	TIMESTAMP	CESTPAIR none
	Secondary Volume Online permission	No	none	YKMAKE ONLINE	none	CESTPAIR
	FREEZE SCP	No	none	YKMAKE	FREEZE SCP	CESTPATH
Split Pairs	SSB transmission (F/M=FB)	Yes	none	none	none	CSUSPEND none

Operation	Option	Avail. in HDvM - SN?	CCI command and options	BCM		PPRC* command and options
				command and option	definition attribute	
	Secondary Volume Write	Yes	pairsplit -rw	YKSUSPND SVOL({PROTECT PERMIT})	PROT MODE	CSUSPEND none
	Suspend for Reverse Resync	No	none	YKSUSPND REVERSE	none	CESTPAIR ACTION(failover)
Resync Pairs	Primary Volume Fence Level	Yes	pairresync -fg	YKRESYNC none	FENCE LVL	CESTPAIR CRIT(yes no)
	Copy Pace	Yes	pairresync -c	YKRESYNC none	COPY PACE(SLOW/ NORMAL)	CESTPAIR none
	Host I/O Time Stamp Transfer	Yes	none	YKRESYNC none	TIMESTAMP	CESTPAIR none
	Reverse Resync	No	pairresync -restore	YKRESYNC REVERSE	none	CESTPAIR ACTION(failback)
	Secondary Volume Online permission	No	none	YKRESYNC ONLINE	none	CESTPAIR ONLINSEC(no/ yes)
	Switching OPEN CTG/ MF CTG	No	none	YKRESYNC OPENMFUP DATE	none	CESTPAIR none
Delete Pairs	Delete Mode	Yes	pairsplit -S	YKDELETE none	none	CDELP PAIR none
*TSO command/ICKDSF commands						

## Monitoring commands and options

The following table lists the commands and options for viewing TCz pair information.

Operation	Options	Avail. in HDvM - SN?	CCI command and options	BCM <sup>1</sup> command	PPRC <sup>2</sup> command and options
View Pair Properties	none	Yes	pairedisplay -m mode	YKQUERY	CQUERY none
View Pair Synchronization Rate	none	Yes	pairedisplay -m mode	YKQUERY	CQUERY none
View Remote Connection Properties	none	Yes	pairedisplay -m mode	YKQRYDEV	CQUERY PATHS

**Notes:**

1. There are no BCM attribute definitions nor options for monitoring commands.
2. TSO command/ICKDSF command.

## Maintenance commands and options

The following table lists the commands and options for maintaining TCz pairs.

Operation	Option	Avail. in HDvM - SN?	BCM command	PPRC command and options <sup>1</sup>
Edit Pair Options	CFW Data	Yes	none	none
Edit Remote Connection Options	RIO MIH Time	Yes	none	none
Add Remote Paths	none	Yes	YKBLDPTH	CESTPATH <sup>2</sup> [Specify by serial#] <sup>3</sup> LINK(x'abccdde', x'abccdde' ...) [Specify by WWNN] <sup>4</sup> LINK(x'ccccddd', x'ccccddd' ...)
Remove Remote Paths	none	Yes	none	CESTPATH <sup>5</sup> [Specify by serial#]

Operation	Option	Avail. in HDvM - SN?	BCM command	PPRC command and options <sup>1</sup>
				LINK(x'abccdde', x'abccdde' ...) <sup>6</sup> [Specify by WWNN] LINK(x'ccccddd', x'ccccddd' ...) <sup>7</sup>
Remove Remote Connections	none	Yes	YKDELPTH	CESTPATH [Specify by serial#] PRIM(mssid#, mserial#, mcu#) SEC(rssid#, rserial#, rcu#) <sup>8</sup> [Specify by WWNN] PRIM(mssid# , mwwnn# , mcu#) SEC(rssid#, rwwnn#, rcu#) <sup>9</sup>
<p><b>Notes:</b></p> <ol style="list-style-type: none"> <li>TSO command/ICKDSF commands</li> <li>Specify by adding the additional path to the registered logical path.</li> <li>a: Machine ID, b: "0" fixed, cc: Initiator Port, dd: RCU Target Port, ee: Secondary volume CU#</li> <li>cc: Initiator Port, dd: RCU Target Port</li> <li>Specify logical path only to leave.</li> <li>a: Controller ID, b: "0" fixed, cc: Initiator Port, dd: RCU Target Port, ee: Secondary volume CU#</li> <li>cc: Initiator Port, dd: RCU Target Port</li> <li>mssid#: SSID# of CU to which primary volume belongs, mserial#: Serial number of Local Storage System, mcu#: CU# of primary volume, rssid#: SSID# of CU to which secondary volume belongs, rserial#: Serial# of Remote Storage System, rcu#: CU# of secondary volume</li> <li>mssid#: SSID# of CU to which primary volume belongs, mwwnn#: WWNN(World Wide Nord Name) of Local Storage System, mcu#: CU# of primary volume, rssid#: SSID# of CU to which secondary volume belongs, rwwnn#: WWNN (World Wide Nord Name) of Remote Storage System, rcu#: CU# of secondary volume</li> </ol>				

## Parameter range for CCI options

The following table shows the range of parameters that can be set for CCI options. For details about CCI commands, see the *Command Control Interface Command Reference*.

Parameter	Range
Mirror ID (MU#)	0 to 3
CTG ID	0 to 255
Path group ID	0 to 63

# Appendix C: TCz GUI reference

As a reference, you can view Device Manager - Storage Navigator windows and fields used for TrueCopy for Mainframe.

**Important:** Procedures in this manual are tailored to the Device Manager - Storage Navigator (HDvM - SN) GUI. When using this GUI, "Local Storage System" is displayed for the system you have accessed on the HDvM - SN server.

Therefore, if you access the secondary site's HDvM - SN server, the GUI displays information for the pair's secondary (remote) system under "Local Storage System", and the GUI identifies the storage system connected to the accessed storage system as the "Remote Storage System".

In this manual, the term "primary storage system" and "primary system" refer to the storage system in which the primary volume (P-VOL) is located, and the terms "secondary storage system" and "secondary system" refer to the storage system in which the secondary volume (S-VOL) is located, unless otherwise noted.

## Replication window

Use this window to view information about pairs and pair volumes.

The screenshot shows the 'Replication' window in the TCz GUI. At the top, it displays 'storage(5/7624) > Replication' and 'Last Updated: 2014/05/13 10:20'. Below this, there are two main sections:

**Local Replication Summary:**

Local Replication	Licensed Capacity (Used/Licensed)	Remote Replication	Licensed Capacity (Used/Licensed)
SI	200.00 GB / Unlimited	TC	100.00 GB / Unlimited
TI	400.00 GB / Unlimited	UR	100.00 GB / Unlimited
SIMF	200.00 GB / Unlimited	TCMF	100.00 GB / Unlimited
FCV2	200.00 GB / Unlimited	URMF	100.00 GB / Unlimited
FCSE	200.00 GB / Unlimited	GAD	100.00 GB / Unlimited

Additional summary statistics:

- Number of Replica LDEVs: 16
- Number of FCV2/FCSE Relationships: 2
- Number of Differential Tables: 824 (Max Allowed: 419200)

**Replica LDEVs Table:**

LDEV ID	LDEV Name	Emulation Type	Capacity	Copy Type												
				SI-L1	SI-L2	TI	SIMF	FCV2	FCSE	TC	UR	TCMF	URMF	GAD		
00:10:00		OPEN-V CVS	100.00 GB	Primary	-	-	-	-	-	-	-	-	-	-	-	-
00:10:01		OPEN-V CVS	100.00 GB	Secondary	Primary	-	-	-	-	-	-	-	-	-	-	-
00:10:02		OPEN-V CVS	100.00 GB	-	Secondary	-	-	-	-	-	-	-	-	-	-	-
00:10:03		OPEN-V CVS	100.00 GB	-	-	Primary	-	-	-	-	-	-	-	-	-	-
00:10:04		OPEN-V CVS	100.00 GB	-	-	Secondary	-	-	-	-	-	-	-	-	-	-
00:10:05		OPEN-V CVS	100.00 GB	-	-	-	-	-	-	Primary	-	-	-	-	-	-
00:10:06		OPEN-V CVS	100.00 GB	-	-	-	-	-	-	Primary	-	-	-	-	-	-
00:10:07		3390-A	100.00 GB	-	-	-	Primary	-	-	-	-	-	-	-	-	-
00:10:08		3390-A	100.00 GB	-	-	-	-	S-Normal	-	-	-	-	-	-	-	-
00:10:09		3390-A	100.00 GB	-	-	-	-	-	S-Normal	-	-	-	-	-	-	-
00:10:10		3390-A	100.00 GB	-	-	-	Secondary	-	-	-	-	-	-	-	-	-
00:10:11		3390-A	100.00 GB	-	-	-	-	-	T-Normal	-	-	-	-	-	-	-
00:10:12		3390-A	100.00 GB	-	-	-	-	-	-	T-Normal	-	-	-	-	-	-
00:10:13		3390-A	100.00 GB	-	-	-	-	-	-	-	-	-	-	-	-	-
00:10:14		3390-A	100.00 GB	-	-	-	-	-	-	-	-	-	Primary	-	-	-
00:10:15		3390-A	100.00 GB	-	-	-	-	-	-	-	-	-	-	Primary	-	-
00:10:16		3390-A	100.00 GB	-	-	-	-	-	-	-	-	-	-	-	Primary	-
00:10:17		OPEN-V CVS	100.00 GB	-	-	-	-	-	-	-	-	-	-	-	-	Primary

In this topic, you can view the following tables.

- Summary section
- Replica LDEVs tab

### Summary section

Item	Description
Licensed Capacity (Used/ Licensed)	Used capacity and licensed capacity for each local and remote replication program product.
Number of Replica LDEVs	Number of LDEVs used in replication.
Number of FCv2/FCSE relationships	Number of Compatible FlashCopy <sup>®</sup> V2 and Compatible FlashCopy <sup>®</sup> SE relationships.
Number of differential tables	<p>The number and the maximum number of differential tables that are already used in local replication.</p> <p>The number of differential tables that are already used in remote replication is not included.</p> <p>Differential tables will not be used for the following operations. Therefore, number of differential tables will not change when you execute the following operations.</p> <ul style="list-style-type: none"> <li>▪ SI pair operations for a DP-VOL that exceeds 4 TB.</li> <li>▪ TI pair operations.</li> <li>▪ Slz pair operations for a DP-VOL that exceeds 262,668 cylinders.</li> <li>▪ Compatible FlashCopy<sup>®</sup> V2 or Compatible FlashCopy<sup>®</sup> SE relationship operations.</li> </ul>
View History - Local Replication	Opens the <b>History</b> window for local replication.
View History - Remote Replication	Opens the <b>History</b> window for remote replication.
Edit Options - Local Replication	Opens the <b>Edit Local Replica Options</b> window.
Edit Options - Remote Replication	Opens the <b>Edit Remote Replica Options</b> window.
Edit Options - SCP Time	Opens the <b>Edit SCP Time</b> window.



## Replica LDEVs tab

Item	Description
LDEV ID	LDEV identifier. Clicking the link opens the <b>LDEV Properties</b> window.
LDEV Name	LDEV name.
Emulation Type	LDEV's emulation type.
Capacity	LDEV's capacity.
Copy Type	<p>Copy and volume type of the pair.</p> <ul style="list-style-type: none"> <li>▪ SI-L1: ShadowImage L1 pair</li> <li>▪ SI-L2: ShadowImage L2 pair</li> <li>▪ SIMF: ShadowImage for Mainframe pair</li> <li>▪ TI: Thin Image</li> <li>▪ FCv2: Compatible FlashCopy® V2 relationship</li> <li>▪ FCSE: Compatible FlashCopy® SE relationship</li> <li>▪ TC: TrueCopy pair</li> <li>▪ TCMF: TrueCopy for Mainframe pair</li> <li>▪ UR: Universal Replicator pair</li> <li>▪ URMF: Universal Replicator for Mainframe pair</li> <li>▪ GAD: global-active device pair</li> </ul> <p>Volume types (SI, TI, SIMF, TC, UR, TCMF, URMF, GAD)</p> <ul style="list-style-type: none"> <li>▪ Primary: Primary volume</li> <li>▪ Secondary: Secondary volume</li> </ul> <p>Volume types (FCv2, FCSE)</p> <p>S indicates the source volume and T indicates the target volume:</p> <ul style="list-style-type: none"> <li>▪ S-Normal: Normal source volume</li> <li>▪ T-Normal: Normal target volume</li> <li>▪ ST-Normal: Normal volumes set for both the source and target volumes</li> <li>▪ S-Failed, S-Full, S-Full &amp; Failed: Abnormal source volume</li> <li>▪ T-Failed, T-Full, T-Full &amp; Failed: Abnormal target volume</li> <li>▪ ST-Failed, ST-Full, ST-Full &amp; Failed: Abnormal volume set for both the source and target volumes.</li> </ul>

Item	Description
	A hyphen (-) is displayed if no pair is set.
Virtual Storage Machine*	<p>Information about the LDEV's virtual storage machine and about the LDEV.</p> <ul style="list-style-type: none"> <li>▪ Model type/Serial number: Model type and serial number.</li> <li>▪ LDEV ID: Virtual LDEV identifier of the volume.</li> <li>▪ Device Name: Virtual device name of the volume, in the format: virtual emulation type/number of virtual LUSE volumes/virtual CVS attribute <ul style="list-style-type: none"> <li>• Only attributes that are specified are displayed.</li> <li>• If the virtual CVS attribute is specified, "CVS" is displayed at the end of the device name.</li> <li>• A blank indicates that no values are specified.</li> </ul> </li> <li>▪ SSID: Virtual SSID of the volume. A blank indicates that no virtual SSID is specified.</li> </ul>
Export	Opens the window for exporting the table information.
* This item does not appear in the window by default. To display this item, change the Column Settings option for the table.	

## Remote Replication window

Use this window to view information about remote replication pairs and mirrors UR / URz only.

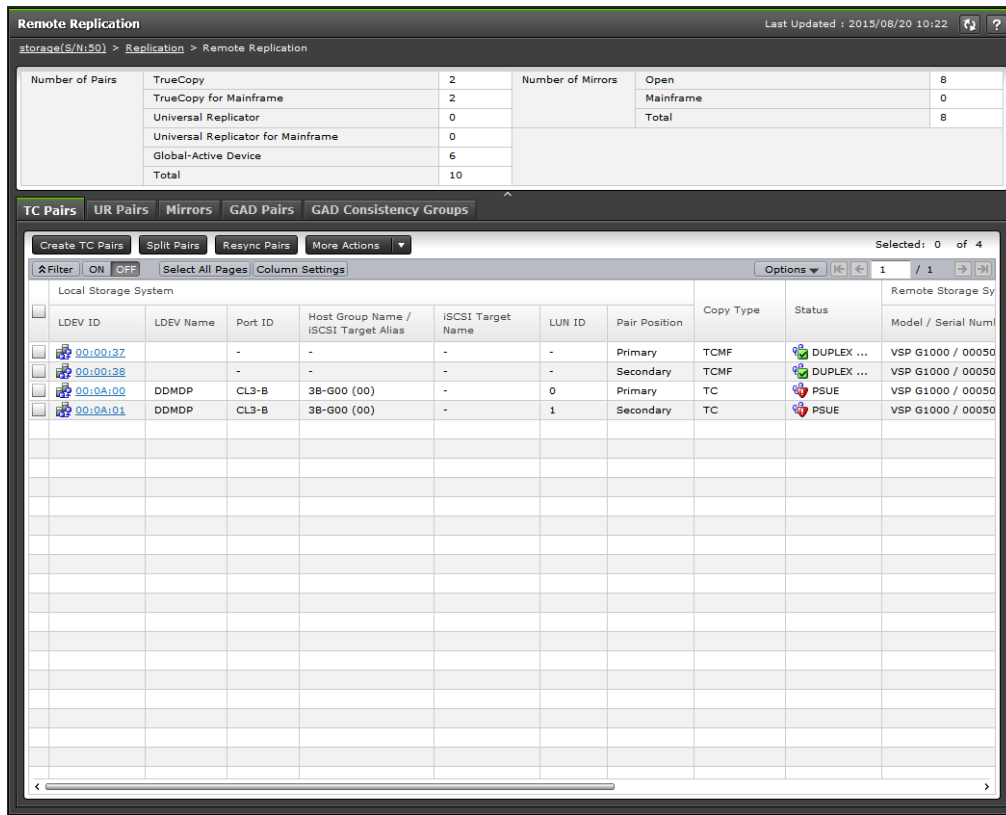

### Summary section

Item	Description
Number of Pairs	Number of pairs for each remote replication product and the total of all pairs.
Number of Mirrors	Open: Number of mirrors for open systems Mainframe: Number of mirrors for mainframe systems Total: Total number of mirrors

### TC Pairs tab

Only the pairs to which the volumes of the local storage system are allocated for each user are displayed.

Item	Description
Local Storage System	<p>Information about volumes in the accessed storage system.</p> <ul style="list-style-type: none"> <li>▪ LDEV ID: LDEV identifier. Click to open the <b>LDEV Properties</b> window.</li> <li>▪ LDEV Name: LDEV name.</li> <li>▪ Port ID: Port identifier. TC only. A hyphen (-) is displayed for TrueCopy for Mainframe pairs.</li> <li>▪ Host Group Name/iSCSI Target Alias: Host group name or iSCSI target alias. TC only. A hyphen (-) is displayed for TrueCopy for Mainframe pairs.</li> <li>▪ iSCSI Target Name: Volume's iSCSI target name. TC only. A hyphen (-) is displayed for TrueCopy for Mainframe pairs.</li> <li>▪ LUN ID: LUN identifier. TC only. A hyphen (-) is displayed for TrueCopy for Mainframe pairs.</li> <li>▪ Pair Position: Whether the volume is a primary or secondary volume.</li> <li>▪ Provisioning Type<sup>1</sup>: Provisioning type of the volume.</li> <li>▪ Emulation Type<sup>1</sup>: Emulation type of the volume.</li> <li>▪ Capacity<sup>1</sup>: Capacity of the volume.</li> <li>▪ CLPR<sup>1</sup>: CLPR ID of the volume.</li> </ul>

Item	Description
	<ul style="list-style-type: none"> <li>▪ Encryption<sup>1</sup>: Encryption information <ul style="list-style-type: none"> <li>• Enabled: Encryption of the parity group to which the LDEV belongs is enabled, or a V-VOL is associated with a pool in which a pool volume has encryption enabled.</li> <li>• Disabled: Encryption of the parity group to which the LDEV belongs is disabled, or a V-VOL is associated with a pool in which a pool volume has encryption disabled.</li> <li>• Mixed: The pool to which the LDEV belongs contains two or more of the following: <ul style="list-style-type: none"> <li>▪ Volume for which encryption is enabled</li> <li>▪ Volume for which encryption is disabled</li> <li>▪ External volume</li> </ul> <p><b>Note:</b> Encryption of data is not ensured in an LDEV with the Mixed encryption status. To manage data encryption, use an LDEV in which Encryption is Enabled or Disabled.</p> <p>For an external volume or migration volume, a hyphen (-) is displayed.</p> <p>For DP-VOL's, the pool to which the LDEV belongs is an external volume or blocked.</p> </li> </ul> </li> <li>▪ Capacity Saving<sup>1</sup>: Information on the capacity saving function. <ul style="list-style-type: none"> <li>• Compression: The compression function is used.</li> <li>• Deduplication and Compression: The deduplication function and the compression function are used.</li> <li>• Disabled: The capacity saving function is not used.</li> </ul> </li> <li>▪ T10 PI<sup>1</sup>: T10 PI attribute of the volume. <ul style="list-style-type: none"> <li>• Enabled: T10 PI attribute of the volume is enabled.</li> <li>• Disabled: T10 PI attribute of the volume is disabled.</li> </ul> <p>A hyphen (-) is displayed if the emulation type is other than OPEN-V.</p> </li> <li>▪ Virtual storage machine<sup>1</sup>: Virtual storage machine's model type and serial number.</li> <li>▪ Virtual LDEV ID<sup>1</sup>: Virtual LDEV identifier of the volume.</li> </ul>

Item	Description
	<ul style="list-style-type: none"> <li>▪ Virtual Device Name<sup>1</sup>: Virtual device name of the volume, in the format: virtual emulation type/number of virtual LUSE volumes/virtual CVS attribute               <ul style="list-style-type: none"> <li>• Only attributes that are specified are displayed.</li> <li>• If the virtual CVS attribute is specified, "CVS" is displayed at the end of the device name.</li> <li>• A blank indicates no values are specified.</li> </ul> </li> <li>▪ Virtual SSID<sup>1</sup>: Virtual SSID of the volume. A blank indicates that no virtual SSID is specified.</li> </ul>
Copy Type	<ul style="list-style-type: none"> <li>▪ TC: TrueCopy</li> <li>▪ TCMF: TrueCopy for Mainframe</li> </ul>
Status	<p>Pair status. In Storage Navigator, the pair status is displayed as pair-status-in-Storage Navigator/pair-status-in-CCI-or-Business-Continuity-Manager. If the pair status in Device Manager - Storage Navigator and the pair status in CCI or Business Continuity Manager are the same, the pair status in CCI or Business Continuity Manager is not displayed.</p>
Processing Status	<p>The processing status for a pair volume is displayed.</p> <ul style="list-style-type: none"> <li>▪ Expanding: The capacity of a TC pair volume is being expanded.</li> </ul> <p>If the volume capacity is not being expanded, or if V-VOLs other than DP-VOLs are used as pair volumes, this field remains blank.</p>
Remote Storage System	<p>Information about volumes in the storage system connected to the accessed system.</p> <ul style="list-style-type: none"> <li>▪ Model / Serial Number: Remote system's model and serial number.</li> <li>▪ SSID: Remote system's SSID number. TCz only.</li> <li>▪ LDEV ID: LDEV identifier.</li> <li>▪ Port ID: Port identifier when specifying an LDEV ID at pair creation. Note that this field does not change if the remote system path settings are changed. TC only. A hyphen (-) is displayed for TrueCopy for Mainframe pairs.</li> <li>▪ Host Group ID/iSCSI Target ID: Host group identifier or iSCSI target identifier when specifying an LDEV ID at pair creation. Note that this field does not change even if the remote system path settings are changed. TC only. A hyphen (-) is displayed for TrueCopy for Mainframe pairs.</li> </ul>

Item	Description
	<ul style="list-style-type: none"> <li>▪ LUN ID: LUN identifier. TC only. A hyphen (-) is displayed for TrueCopy for Mainframe pairs.</li> <li>▪ Virtual storage machine<sup>1</sup>: Virtual storage machine's model type and serial number.</li> <li>▪ Virtual LDEV ID<sup>1</sup>: Virtual LDEV identifier of the volume.</li> </ul>
Path Group ID	Path group identifier.
Update Type <sup>1</sup>	<p>One of the following:</p> <ul style="list-style-type: none"> <li>▪ Sync: It is a TC or TCMF pair which is not assigned to consistency group.</li> <li>▪ Sync (Specified CTG): It is a TC or TCMF pair created by specifying consistency group.</li> </ul>
CTG ID <sup>1</sup>	Pair's consistency group identifier.
CTG Utilization <sup>1</sup>	<p>Whether the consistency group is shared by multiple storage systems.</p> <ul style="list-style-type: none"> <li>▪ Single: The consistency group consists of a single pair of primary and secondary storage systems.</li> <li>▪ Multi: The consistency group consists of multiple storage systems.</li> </ul>
Preserve Mirror Status <sup>1</sup>	<ul style="list-style-type: none"> <li>▪ - (hyphen): Indicates that it is a Preserve Mirror status without any problem or it is not a Preserve Mirror pair.</li> <li>▪ Withdrawn: Indicates that pair volume data does not match due to suspending copy of Compatible FlashCopy<sup>®</sup> V2.</li> </ul>
Fence Level <sup>1</sup>	Specified P-VOL fence level.
Host I/O Time Stamp Transfer <sup>1</sup>	Whether the host time stamp is transferred to an S-VOL.
Create TC Pairs	Opens the Create TC Pairs window.
Split Pairs	Opens the <b>Split Pairs</b> window.
Resync Pairs	Opens the <b>Resync Pairs</b> window.
View Pair Synchronization Rate <sup>2</sup>	Opens the <b>View Pair Synchronization Rate</b> window when the pair's primary system is accessed.
View Pair Properties <sup>2</sup>	Opens the <b>View Pair Properties</b> window.
View Remote Connection Properties <sup>2</sup>	Opens the <b>View Remote Connection Properties</b> window.

Item	Description
Edit Pair Options <sup>2</sup>	Opens the <b>Edit Pair Options</b> window.
Delete Pairs <sup>2</sup>	Opens the <b>Delete Pairs</b> window.
Export <sup>2</sup>	Opens the window for exporting the table information.
<b>Notes:</b>	
<ol style="list-style-type: none"> <li>1. This item does not appear in the window by default. To display this item, change the Column Settings option for the table.</li> <li>2. This item is displayed when you select More Actions.</li> </ol>	

### UR Pairs tab

Only the pairs to which the volumes of the local storage system are allocated for each user are displayed.

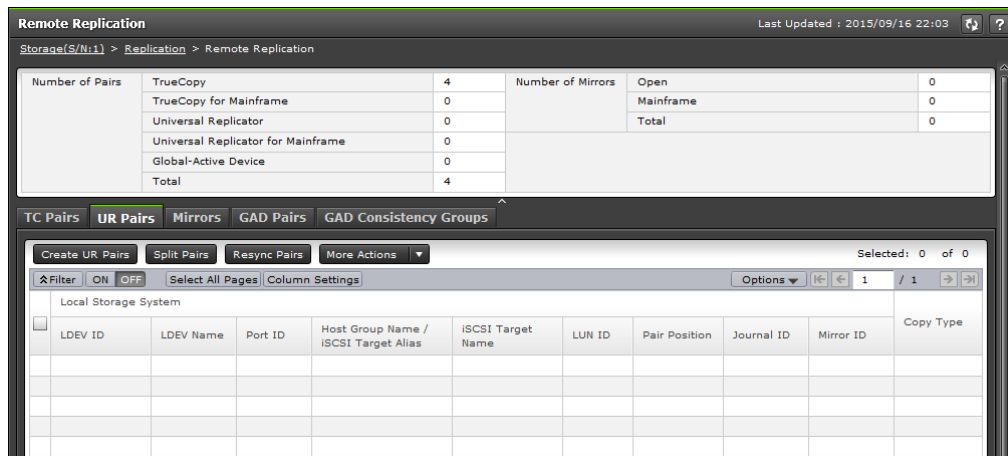

Item	Description
Local Storage System	<p>Information about volumes in the accessed storage system.</p> <ul style="list-style-type: none"> <li>▪ LDEV ID: LDEV identifier. Clicking the link opens the <b>LDEV Properties</b> window.</li> <li>▪ LDEV Name: LDEV name.</li> <li>▪ Port ID: Port identifier. UR only. A hyphen (-) is displayed for URz pairs.</li> <li>▪ Host Group Name/iSCSI Target Alias: Host group name or iSCSI target alias. UR only. A hyphen (-) is displayed for URz pairs.</li> <li>▪ iSCSI Target Name: iSCSI target name. UR only. A hyphen (-) is displayed for URz pairs.</li> </ul>



Item	Description
	<ul style="list-style-type: none"> <li>▪ LUN ID: LUN identifier. UR only. A hyphen (-) is displayed for URz pairs.</li> <li>▪ Pair Position: Whether the volume is a primary or secondary volume.</li> <li>▪ Journal ID: Journal identifier.</li> <li>▪ Mirror ID: Mirror identifier.</li> <li>▪ SLU ID: For an LDEV with the SLU attribute, the SLU ID is displayed. For an LDEV with other than the SLU attribute, a hyphen (-) is displayed. If the SLU ID is not set, a question mark (?) is displayed.</li> <li>▪ Provisioning Type<sup>1</sup>: Provisioning type of the volume.</li> <li>▪ Emulation Type<sup>1</sup>: Emulation type of the volume.</li> <li>▪ Capacity<sup>1</sup>: Capacity of the volume.</li> <li>▪ CLPR<sup>1</sup>: CLPR ID of the volume.</li> <li>▪ Encryption<sup>1</sup>: Encryption information <ul style="list-style-type: none"> <li>• Enabled: Encryption of the parity group to which the LDEV belongs is enabled, or a V-VOL is associated with a pool in which a pool volume has encryption enabled.</li> <li>• Disabled: Encryption of the parity group to which the LDEV belongs is disabled, or a V-VOL is associated with a pool in which a pool volume has encryption disabled.</li> <li>• Mixed: The pool to which the LDEV belongs contains two or more of the following: <ul style="list-style-type: none"> <li>▪ Volume for which encryption is enabled</li> <li>▪ Volume for which encryption is disabled</li> <li>▪ External volume</li> </ul> </li> </ul> <p><b>Note:</b> Encryption of data is not ensured in an LDEV with the Mixed encryption status. To manage data encryption, use an LDEV in which Encryption is Enabled or Disabled.</p> <p>For an external volume or migration volume, a hyphen (-) is displayed.</p> <p>For Dynamic Provisioning or Dynamic Provisioning for Mainframe virtual volumes, the pool to which the LDEV belongs is an external volume or blocked.</p> </li> </ul>

Item	Description
	<ul style="list-style-type: none"> <li>▪ Journal Encryption<sup>1</sup>: Journal's encryption status. <ul style="list-style-type: none"> <li>• Enabled: The journal contains encrypted volumes.</li> <li>• Disabled: The journal contains unencrypted volumes.</li> <li>• Mixed: The pool to which the journal volume belongs contains two or more of the following: <ul style="list-style-type: none"> <li>▪ Volume for which encryption is enabled</li> <li>▪ Volume for which encryption is disabled</li> <li>▪ External volume</li> </ul> </li> </ul> <p><b>Note:</b> Encryption of data is not ensured in an LDEV with the Mixed encryption status. To manage data encryption, use an LDEV in which Encryption is Enabled or Disabled.</p> <p>A hyphen (-) is displayed if the pool to which the journal volume belongs is an external volume, created by migration, or blocked.</p> </li> <li>▪ Capacity Saving<sup>1</sup>: Information on the capacity saving function. <ul style="list-style-type: none"> <li>• Compression: The compression function is used.</li> <li>• Deduplication and Compression: The deduplication function and the compression function are used.</li> <li>• Disabled: The capacity saving function is not used.</li> </ul> </li> <li>▪ T10 PI<sup>1</sup>: T10 PI attribute of the volume. <ul style="list-style-type: none"> <li>• Enabled: T10 PI attribute of the volume is enabled.</li> <li>• Disabled: T10 PI attribute of the volume is disabled.</li> </ul> <p>A hyphen (-) is displayed if the emulation type is other than OPEN-V.</p> </li> <li>▪ Virtual storage machine<sup>1</sup>: Virtual storage machine's model type and serial number.</li> <li>▪ Virtual LDEV ID<sup>1</sup>: Virtual LDEV identifier of the volume. When the virtual LDEV ID is not assigned, this item is blank.</li> </ul>

Item	Description
	<ul style="list-style-type: none"> <li>▪ Virtual Device Name<sup>1</sup>: Virtual device name of the volume, in the format: virtual emulation type/number of virtual LUSE volumes/virtual CVS attribute               <ul style="list-style-type: none"> <li>• Only attributes that are specified are displayed.</li> <li>• If the virtual CVS attribute is specified, "CVS" is displayed at the end of the device name.</li> <li>• A blank indicates no values are specified.</li> </ul> </li> <li>▪ Virtual SSID<sup>1</sup>: Virtual SSID of the volume. A blank indicates that no virtual SSID is specified.</li> </ul>
Copy Type	<ul style="list-style-type: none"> <li>▪ UR: Universal Replicator</li> <li>▪ URMF: Universal Replicator for Mainframe</li> </ul>
Status	Pair status.
Processing Status	<p>The processing status for a pair volume is displayed.</p> <ul style="list-style-type: none"> <li>▪ Expanding: The capacity of a UR pair volume is being expanded.</li> </ul> <p>If the volume capacity is not being expanded, or if V-VOLs other than DP-VOLs are used as pair volumes, this field remains blank.</p>
Remote Storage System	<p>Information about volumes in the system connected to the system you accessed.</p> <ul style="list-style-type: none"> <li>▪ Model / Serial Number: Remote system's model and serial number.</li> <li>▪ LDEV ID: LDEV identifier.</li> <li>▪ Port ID: Port identifier. UR only. A hyphen (-) is displayed for URz pairs.</li> <li>▪ Host Group ID/iSCSI Target ID: Host group identifier or iSCSI target identifier when specifying an LDEV ID at pair creation. Note that this field does not change even if the remote system path settings are changed. UR only. A hyphen (-) is displayed for URz pairs.</li> <li>▪ LUN ID: LUN identifier. UR only. A hyphen (-) is displayed for URz pairs.</li> <li>▪ Journal ID: Journal's identifier.</li> <li>▪ Virtual storage machine<sup>1</sup>: Virtual storage machine's model type and serial number.</li> <li>▪ Virtual LDEV ID<sup>1</sup>: Virtual LDEV identifier of the volume.</li> </ul>
Path Group ID	Path group identifier.

Item	Description
CTG ID <sup>1</sup>	Consistency group identifier.
Error Level <sup>1</sup>	The error level.
Create UR Pairs	Opens the Create UR Pairs window.
Split Pairs	Opens the <b>Split Pairs</b> window.
Resync Pairs	Opens the <b>Resync Pairs</b> window.
View Pair Synchronization Rate <sup>2</sup>	Opens the <b>View Pair Synchronization Rate</b> window when the pair's primary system is accessed.
View Pair Properties <sup>2</sup>	Opens the <b>View Pair Properties</b> window.
View Remote Connection Properties <sup>2</sup>	Opens the <b>View Remote Connection Properties</b> window. Displays only if Pair Position is Primary.
Edit Pair Options <sup>2</sup>	Opens the <b>Edit Pair Options</b> window.
Delete Pairs <sup>2</sup>	Opens the <b>Delete Pairs</b> window.
Split Mirrors <sup>2</sup>	Opens the <b>Split Mirrors</b> window.
Resync Mirrors <sup>2</sup>	Opens the <b>Resync Mirrors</b> window.
Delete Mirrors <sup>2</sup>	Opens the <b>Delete Mirrors</b> window.
Export <sup>2</sup>	Opens the window for exporting the table information.
<p><b>Notes:</b></p> <ol style="list-style-type: none"> <li>1. This item does not appear in the window by default. To display this item, change the Column Settings option for the table.</li> <li>2. This item is displayed when you select More Actions.</li> </ol>	

### Mirrors tab

UR / URz only. Only the mirrors to which all volumes are allocated for each user are displayed.

Remote Replication Last Updated : 2014/10/21 15:09

Storage(S/N:30180) > Replication > Remote Replication

Number of Pairs	TrueCopy	0	Number of Mirrors	Open	8
	TrueCopy for Mainframe	0		Mainframe	0
	Universal Replicator	0		Total	8
	Universal Replicator for Mainframe	0			
	Global-Active Device	13			
	Total	13			

TC Pairs UR Pairs **Mirrors** GAD Pairs GAD Consistency Groups

Split Mirrors Resync Mirrors Create UR Pairs More Actions Selected: 0 of 8

Filter ON OFF Select All Pages Column Settings Options 1 / 1

Journal ID	Mirror ID	Journal Type	Attribute	Status	Remote Storage System		Path Group ID	Number of Data VOLS	Data Capacity	Remote Device
					Model / Serial Number	Journal ID				
000	0	UR	Master	Active / ...	VSP G1000 / 30110	000	01	64	512.06 GB	-
000	1	UR	Initial	Initial / ...	-	-	-	0	0.00 GB	-
000	2	UR	Initial	Initial / ...	-	-	-	0	0.00 GB	-
000	3	UR	Initial	Initial / ...	-	-	-	0	0.00 GB	-
001	0	UR	Master	Active / ...	VSP G1000 / 30110	001	01	64	512.06 GB	-
001	1	UR	Initial	Initial / ...	-	-	-	0	0.00 GB	-
001	2	UR	Initial	Initial / ...	-	-	-	0	0.00 GB	-
001	3	UR	Initial	Initial / ...	-	-	-	0	0.00 GB	-

Item	Description
Journal ID	Journal identifier. Clicking opens the <b>Journal Volumes</b> window.
Mirror ID	Mirror identifier.
Journal Type	The journal's copy type and journal type option are displayed. If the journal type is standard, only the copy type is displayed.
Attribute	Whether the journal is Master, Restore, or Initial-registered but with no pair volumes assigned to it.
Status	Mirror status.
Remote Storage System	<ul style="list-style-type: none"> <li>Model / Serial Number: Remote system model and serial number.</li> <li>Journal ID: Remote system journal identifier</li> </ul>
Path Group ID	Path group identifier.
Number of Data VOLS	Number of volumes associated with the mirror.
Data Capacity	Total capacity of all the associated volumes.
Remote Command Device	<p>LDEV ID of the remote command device if it is assigned to the mirror.</p> <ul style="list-style-type: none"> <li>The column is blank if the remote command device is not assigned to the mirror.</li> <li>A hyphen (-) indicates the remote command device cannot be assigned to the mirror.</li> </ul>
CTG ID <sup>1</sup>	Displays the consistency group ID.

Item	Description
CTG Utilization <sup>1</sup>	<p>Whether the consistency group is shared by multiple storage systems.</p> <ul style="list-style-type: none"> <li>▪ Single: The consistency group consists of a single pair of primary and secondary storage systems.</li> <li>▪ Multi: The consistency group consists of multiple storage systems.</li> </ul>
EXCTG Setting <sup>1</sup>	<p>Displays the EXCTG ID and Super DKC (device name and serial number) if the journal belongs to the EXCTG.</p> <p>A hyphen (-) is displayed when no journal is registered in the EXCTG.</p>
Path Watch Time <sup>1</sup>	Displays the path watch time.
Path Watch Time Transfer <sup>1</sup>	<p>Specifies whether to forward the Path Watch Time value of the master journal to the secondary mirror. If the Path Watch Time value is forwarded from the master journal to the secondary mirror, both the primary and secondary mirrors will have the same Path Watch Time value.</p> <ul style="list-style-type: none"> <li>▪ Yes: The Path Watch Time value will be forwarded to the secondary mirror.</li> <li>▪ No: The Path Watch Time value will not be forwarded to the secondary mirror.</li> </ul>
Copy Pace <sup>1</sup>	Indicates the speed of initial copy of a volume. Slower, Medium, or Faster is displayed. A hyphen is displayed if the journal is a restore journal.
Transfer Speed <sup>1</sup>	Specifies the transfer speed (in Mbps (megabits per second)). Specify one of the following: 256, 100, 10, or 3.
Delta Resync Failure <sup>1</sup>	<p>Indicates the processing that must be performed if delta resync cannot be performed.</p> <ul style="list-style-type: none"> <li>▪ Entire Copy: Copies all data in the primary volume to the secondary volume if delta resync cannot be performed.</li> <li>▪ No Copy: Does not perform any processing if delta resync cannot be performed. Does not update the secondary volume.</li> </ul>
Split Mirrors	Opens the <b>Split Mirrors</b> window.
Resync Mirrors	Opens the <b>Resync Mirrors</b> window.
Create UR Pairs	Opens the Create UR Pairs window.
Edit Mirror Options <sup>2</sup>	Opens the <b>Edit Mirror Options</b> window.

Item	Description
View Remote Connection Properties <sup>2</sup>	Opens the <b>View Remote Connection Properties</b> window when the value for Attribute is "Master".
Delete Mirrors <sup>2</sup>	Opens the <b>Delete Mirrors</b> window.
Assign Remote Command Devices <sup>2</sup>	Opens the <b>Assign Remote Command Devices</b> window.
Release Remote Command Devices <sup>2</sup>	Opens the <b>Release Remote Command Devices</b> window.
Export <sup>2</sup>	Opens the window for exporting the table information.
<b>Notes:</b>	
<ol style="list-style-type: none"> <li>1. This item does not appear in the window by default. To display this item, change the Column Settings option for the table.</li> <li>2. This item is displayed when you select More Actions.</li> </ol>	

### GAD Pairs tab

Only the pairs to which the volumes of the local storage system are allocated for each user are displayed.

LDEV ID	LDEV Name	Port ID	Host Group Name / iSCSI Target Alias	iSCSI Target Name	LUN ID	Pair Position	Provisioning Type	Capacity	CLPR	Encryption	I/
00:10:A0		CL1-B	1B-G00 (00)	-	32	Primary	DP	2.00 GB	0:CLPRO	Disabled	Mi
00:10:A1		CL1-B	1B-G00 (00)	-	33	Primary	DP	2.00 GB	0:CLPRO	Disabled	Mi
00:10:A3		CL1-B	1B-G00 (00)	-	35	Secondary	DP	2.00 GB	0:CLPRO	Disabled	Mi

Item	Description
Local Storage System	<p>Information about volumes in the Local Storage System.</p> <ul style="list-style-type: none"> <li>▪ LDEV ID: LDEV identifier. Click to open the <b>LDEV Properties</b> window.</li> <li>▪ LDEV Name: LDEV name.</li> <li>▪ Port ID: Port identifier.</li> <li>▪ Host Group Name/iSCSI Target Alias: Host group name or iSCSI target alias.</li> </ul>

Item	Description
	<ul style="list-style-type: none"> <li>▪ iSCSI Target Name: iSCSI target name of the volume.</li> <li>▪ LUN ID: LUN identifier.</li> <li>▪ Pair Position: Whether the volume is a primary or secondary volume.</li> <li>▪ Provisioning Type<sup>1</sup>: Provisioning type of the volume.</li> <li>▪ Capacity<sup>1</sup>: Capacity of the volume.</li> <li>▪ CLPR<sup>1</sup>: CLPR ID of the volume.</li> <li>▪ Encryption<sup>1</sup>: Encryption information. <ul style="list-style-type: none"> <li>• Enabled: Encryption of the parity group to which the LDEV belongs is enabled, or a V-VOL is associated with a pool in which a pool volume has encryption enabled.</li> <li>• Disabled: Encryption of the parity group to which the LDEV belongs is disabled, or a V-VOL is associated with a pool in which a pool volume has encryption disabled.</li> <li>• Mixed: The pool to which the LDEV belongs contains two or more of the following: <ul style="list-style-type: none"> <li>▪ Volume for which encryption is enabled</li> <li>▪ Volume for which encryption is disabled</li> <li>▪ External volume</li> </ul> </li> </ul> <p><b>Note:</b> Encryption of data is not ensured in an LDEV with the Mixed encryption status. To manage data encryption, use an LDEV in which Encryption is Enabled or Disabled.</p> <p>For an external volume or migration volume, a hyphen (-) is displayed. For DP-VOLs, the pool to which the LDEV belongs is an external volume or blocked.</p> </li> <li>▪ I/O Mode: I/O Mode of the volume.</li> <li>▪ ALUA Mode: Information about the ALUA mode.</li> </ul>



Item	Description
	<ul style="list-style-type: none"> <li>▪ Capacity Saving<sup>1</sup>: Information on the capacity saving function.               <ul style="list-style-type: none"> <li>• Compression: The compression function is used.</li> <li>• Deduplication and Compression: The deduplication function and the compression function are used.</li> <li>• Disabled: The capacity saving function is not used.</li> </ul> </li> <li>▪ T10 PI<sup>1</sup>: T10 PI attribute of the volume.               <ul style="list-style-type: none"> <li>• Enabled: T10 PI attribute of the volume is enabled.</li> <li>• Disabled: T10 PI attribute of the volume is disabled.</li> </ul> </li> </ul>
Status	Pair status.
Processing Status	<p>The processing status for a pair volume is displayed.</p> <ul style="list-style-type: none"> <li>▪ Expanding: The capacity of a GAD pair volume is being expanded.</li> </ul> <p>If the volume capacity is not being expanded, or if V-VOLs other than DP-VOLs are used as pair volumes, this field remains blank.</p>
Failure Factor <sup>1</sup>	<p>Failure Factor.</p> <p>To check the failure factors, see the <a href="#">Failure Factors (on page 244)</a> for more details.</p>
Remote Storage System	<p>Information about volumes in the Remote Storage System.</p> <ul style="list-style-type: none"> <li>▪ Model / Serial Number: Remote system's model and serial number.</li> <li>▪ LDEV ID: LDEV identifier.</li> <li>▪ Port ID: Port ID when specifying an LDEV ID at pair creation. Note that this field does not change if the remote system path settings are changed.</li> <li>▪ Host Group ID/iSCSI Target ID: Host group identifier or iSCSI target ID when specifying an LDEV ID at pair creation. Note that this field does not change even if the remote system path settings are changed.</li> <li>▪ LUN ID: LUN identifier when specifying an LDEV ID at pair creation. Note that this field does not change even if the remote system path settings are changed.</li> </ul>
Path Group ID	Path group identifier.
Mirror ID	Mirror identifier.

Item	Description
Quorum Disk	Information about the quorum disk. <ul style="list-style-type: none"> <li>▪ ID: Quorum disk identifier</li> <li>▪ LDEV ID: LDEV identifier of the quorum disk. A hyphen (-) is displayed if no LDEV is set for the quorum disk.</li> </ul>
CTG ID	Consistency group identifier.
Pair Operating Mode When Quorum Disk Blocked	Displays the pair operating mode when the quorum disk is blocked. A hyphen (-) is displayed if no LDEV is set for the quorum disk or GAD pairs are split. <ul style="list-style-type: none"> <li>▪ Pair Retained (both Primary and Secondary Accessible): The server can access both the P-VOL and the S-VOL.</li> <li>▪ Pair Retained (Primary Accessible and Secondary Inaccessible): The server can access the P-VOL. The data written to the P-VOL is written to the S-VOL.</li> <li>▪ Pair Suspension: The server can access the P-VOL. The data written to the P-VOL is not written to the S-VOL.</li> </ul>
Virtual Storage Machine	Information about the LDEV's virtual storage machine. <ul style="list-style-type: none"> <li>▪ Model type/Serial number: Model type and serial number.</li> <li>▪ LDEV ID: Virtual LDEV identifier of the volume.</li> <li>▪ Device Name: Virtual device name of the volume, in the format: virtual emulation type/number of virtual LUSE volumes/virtual CVS attribute.               <ul style="list-style-type: none"> <li>• Only attributes that are specified are displayed.</li> <li>• If the virtual CVS attribute is specified, "CVS" is displayed at the end of the device name.</li> <li>• A blank indicates no values are specified.</li> </ul> </li> <li>▪ SSID: Virtual SSID of the volume. A blank indicates that no virtual SSID is specified.</li> </ul>
Create GAD Pairs	Opens the Create GAD Pairs window.
Suspend Pairs	Opens the <b>Suspend Pairs</b> window.
Resync Pairs	Opens the <b>Resync Pairs</b> window.
View Pair Synchronization Rate <sup>2</sup>	Opens the <b>View Pair Synchronization Rate</b> window when the pair's primary system is accessed.
View Pair Properties <sup>2</sup>	Opens the <b>View Pair Properties</b> window.
View Remote Connection Properties <sup>2</sup>	Opens the <b>View Remote Connection Properties</b> window.

Item	Description
Delete Pairs <sup>2</sup>	Opens the <b>Delete Pairs</b> window.
Export <sup>2</sup>	Opens the window for exporting the table information.
<b>Notes:</b>	
<ol style="list-style-type: none"> <li>This item does not appear in the window by default. To display this item, change the Column Settings option for the table.</li> <li>This item is displayed when you select More Actions.</li> </ol>	

### GAD Consistency Groups tab

Item	Description
CTG ID	Consistency group identifier.
Usage	Displays whether a consistency group is used. <ul style="list-style-type: none"> <li>Used</li> <li>Free</li> </ul>
Status	Consistency group status. See the <i>Global-Active Device User Guide</i> for status descriptions.
Quorum Disk	Information about the quorum disk. <ul style="list-style-type: none"> <li>ID: Quorum disk identifier</li> <li>LDEV ID: LDEV identifier of the quorum disk. A hyphen (-) is displayed if no LDEV is set for the quorum disk.</li> </ul>
Mirror ID	Mirror identifier.
Pair Position	Displays whether the GAD pair volume registered to the consistency group is a primary or secondary volume.

Item	Description
I/O Mode	Displays the I/O mode of the GAD pair that is registered to the consistency group.
Virtual Storage Machine	Displays the model type/serial number of the virtual storage machine.
Number of Pairs	Number of pairs registered to the consistency group.
Suspend Consistency Groups	Opens the <b>Suspend Consistency Groups</b> window.
Resync Consistency Groups	Opens the <b>Resync Consistency Groups</b> window.
Create GAD Pairs	Opens the Create GAD Pairs window.
Export	Opens the window for exporting the table information.

### Failure Factors

The following table shows failure factors displayed in the Failure Factor column and their meanings.

Failure Factor	Meanings
Local Volume Failure	A failure is detected on a volume in the local storage system.
Remote Path Failure	A failure is detected on the remote path.
Quorum Disk Failure	A failure is detected on the quorum disk.
Internal Error	An internal error is detected.
Not Failure	No failure is detected. The pair is suspended when the local storage system is turned on.
Remote Volume Failure	A failure is detected on a volume in the remote storage system.
Remote Side Unidentified Failure	A failure due to an unidentified factor is detected on a volume in the remote storage system.
blank cell	No failure is detected.

## Remote Connections window

Use this window to view information about remote connections and paths, and add additional remote connections and paths.

In this topic you can review the following tables:

- [Remote connections window \(on page 245\)](#)
- [Connections \(To\) tab \(on page 246\)](#)
- [Connections \(From\) tab \(on page 247\)](#)
- [Quorum Disks tab \(on page 248\)](#)

### Remote connections window

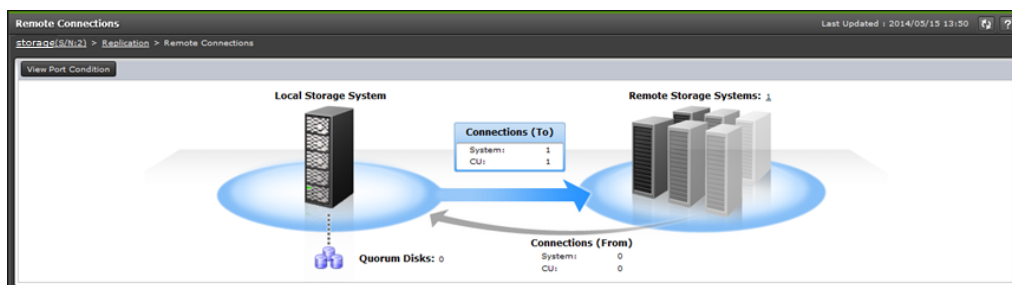

Item	Description
View Port Condition	Opens the <b>View Port Condition</b> window.
Connections (To)	<ul style="list-style-type: none"> <li>▪ System: Number of system-to-system connections from local to remote system.</li> <li>▪ CU: Number of CU-to-CU connections from local to remote system.</li> </ul>
Remote Storage System	Number of remote systems connected to the local system.
Connections (From)	<ul style="list-style-type: none"> <li>▪ System: Number of system-to-system connections from remote to local system.</li> <li>▪ CU: Number of CU-to-CU connections from remote to local system.</li> </ul> <p>Only the number of remote connections used for TC/TCz pairs is displayed as the number of connections.</p>
Quorum Disks	The number of quorum disks.
View Port Location	Opens the <b>View Port Location</b> window.

## Connections (To) tab

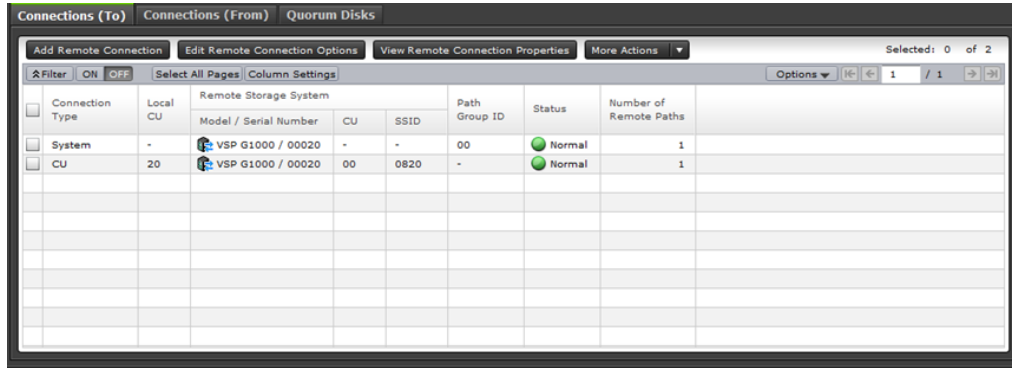

Use this tab to view information about the remote system.

Item	Description
Connection Type	<ul style="list-style-type: none"> <li>System: system-to-system connection (local to remote).</li> <li>CU: CU-to-CU connections (local to remote).</li> </ul>
Local CU	Local system CU number.
Remote Storage System	<ul style="list-style-type: none"> <li>Model / Serial Number: Model and serial number.</li> <li>CU: Remote Storage System's CU number.</li> <li>SSID: Remote Storage System's SSID number.</li> </ul>
Path Group ID	Path group identifier.
Status	Remote connection status. <ul style="list-style-type: none"> <li>Normal: All remote paths are normal.</li> <li>Failed: All remote paths are abnormal.</li> <li>Warning: Some remote paths are abnormal.</li> </ul>
Number of Remote Paths	Number of remote paths.
Minimum Number of Paths <sup>1</sup>	The specified minimum number of paths.
RIO MIH Time (sec.) <sup>1</sup>	The specified RIO MIH time in seconds.
Roundtrip Time (msec.) <sup>1</sup>	The specified roundtrip time in milliseconds.
FREEZE Option <sup>1</sup>	The specified the FREEZE option.
Add Remote Connection	Opens the <b>Add Remote Connection</b> window.
Edit Remote Connection Options	Opens the <b>Edit Remote Connection Options</b> window.
View Remote Connection Properties	Opens the <b>View Remote Connection Properties</b> window.

Item	Description
Add Remote Paths <sup>2</sup>	Opens the <b>Add Remote Paths</b> window.
Remove Remote Paths <sup>2</sup>	Opens the <b>Remove Remote Paths</b> window.
Add SSIDs <sup>2</sup>	Opens the <b>Add SSIDs</b> window.
Delete SSIDs <sup>2</sup>	Opens the <b>Delete SSIDs</b> window.
Remove Remote Connections <sup>2</sup>	Opens the <b>Remove Remote Connections</b> window.
Export <sup>2</sup>	Opens the window for exporting the table information.
<b>Notes:</b>	
<ol style="list-style-type: none"> <li>1. This item does not appear in the window by default. To display this item, change the Column Settings option for the table.</li> <li>2. This item is displayed when More Actions is clicked.</li> </ol>	

### Connections (From) tab

Use this tab to view information about the remote storage system. This information is displayed only when remote connections are used for TC and TCz pairs.

Item	Description
Connection Type	<ul style="list-style-type: none"> <li>▪ System: system-to-system connection from remote to local.</li> <li>▪ CU: CU-to-CU connections from remote to local.</li> </ul>
Local CU	Local system CU number.
Remote Storage System	<ul style="list-style-type: none"> <li>▪ Model / Serial Number: Model and serial number.</li> <li>▪ CU: CU number.</li> <li>▪ SSID: SSID number.</li> </ul>
Path Group ID	Path group identifier.
Export	Opens the window for exporting the table information.

## Quorum Disks tab

Use this tab to view information about quorum disks allocated to users.

Quorum Disk ID	LDEV ID	LDEV Name	Status	CLPR	Capacity	Remote Storage System	Read Response Guaranteed Time When Quorum Disk Blocked (sec)
00	00:00:56	QuorumDisk	Normal	0:CLPR0	20.00 GB	VSP G1000 / 00001	40
01	00:00:55	QuorumDisk	Normal	0:CLPR0	20.00 GB	VSP G1000 / 00001	40
02	00:00:54	QuorumDisk	Normal	0:CLPR0	20.00 GB	VSP G1000 / 00001	40
03	00:00:53	QuorumDisk	Normal	0:CLPR0	20.00 GB	VSP G1000 / 00001	40
04	00:00:52	QuorumDisk	Normal	0:CLPR0	20.00 GB	VSP G1000 / 00001	40
05	00:00:51	QuorumDisk	Normal	0:CLPR0	20.00 GB	VSP G1000 / 00001	40
06	00:00:50	QuorumDisk	Normal	0:CLPR0	20.00 GB	VSP G1000 / 00001	40
07	00:00:4F	QuorumDisk	Normal	0:CLPR0	20.00 GB	VSP G1000 / 00001	40
08	00:00:4E	QuorumDisk	Normal	0:CLPR0	20.00 GB	VSP G1000 / 00001	40
09	00:00:4C	QuorumDisk	Normal	0:CLPR0	20.00 GB	VSP G1000 / 00001	40
0A	00:00:4D	QuorumDisk	Normal	0:CLPR0	20.00 GB	VSP G1000 / 00001	40
0B	00:00:4B	QuorumDisk	Normal	0:CLPR0	20.00 GB	VSP G1000 / 00001	40

Item	Description
Quorum Disk ID	Quorum disk identifier.
Quorum Disk	<p>Below is some information about quorum disks.</p> <ul style="list-style-type: none"> <li>▪ LDEV ID: Virtual LDEV identifier of the volume. Click to open the <b>LDEV Properties</b> window. A hyphen (-) is displayed if no LDEV is set for the quorum disk.</li> <li>▪ LDEV Name: LDEV Name of the volume. A hyphen (-) is displayed if no LDEV is set for the quorum disk.</li> <li>▪ Status: Displays the status of the volume: <ul style="list-style-type: none"> <li>•  Normal: Volume is in normal status.</li> <li>•  Blocked: Volume is blocked. Access cannot be made from the host.</li> <li>•  Warning: Volume has a problem.</li> <li>•  Formatting: Volume is being formatted.</li> <li>•  Preparing Quick Format: Preparation for quick formatting is in progress.</li> <li>•  Quick Formatting: Volume is under quick formatting.</li> <li>•  Correction Access: Access attribute is being corrected.</li> <li>•  Copying: Volume data is being copied.</li> <li>•  Read Only: Volume is in Read Only status. Data cannot be written.</li> <li>•  Shredding: Volume is being shredded.</li> <li>•  - : Volume is in a status other than the above.</li> </ul> </li> </ul>



Item	Description
	<ul style="list-style-type: none"> <li>▪ CLPR: CLPR ID of the volume. A hyphen (-) is displayed if no LDEV is set for the quorum disk.</li> <li>▪ Capacity: Capacity of the volume. A hyphen (-) is displayed if no LDEV is set for the quorum disk.</li> </ul>
Remote Storage System	Model/Serial number of Remote Storage System.
Read Response Guaranteed Time When Quorum Monitoring Stopped	Displays the time elapses until the S-VOL pair status changes to PSUE (Block) after a remote path disconnection is detected if a quorum disk is blocked, or if no LDEV is set for the quorum disk.
Add Quorum Disk	Opens the window to add quorum disks.
Remove Quorum Disk	Opens the window to remove quorum disks.
Edit Quorum Disks	Opens the window to edit quorum disks.
Export	Opens the window to export the table information.

## Add Remote Connection wizard

Use this wizard to set up storage systems for replication.

## Add Remote Connection window

Use this window to connect storage systems for remote replication.

For complete UR or URz information, see the section on configuring primary and secondary systems in the *Hitachi Universal Replicator User Guide* or *Hitachi Universal Replicator for Mainframe User Guide*.

When Select Type is Fibre:

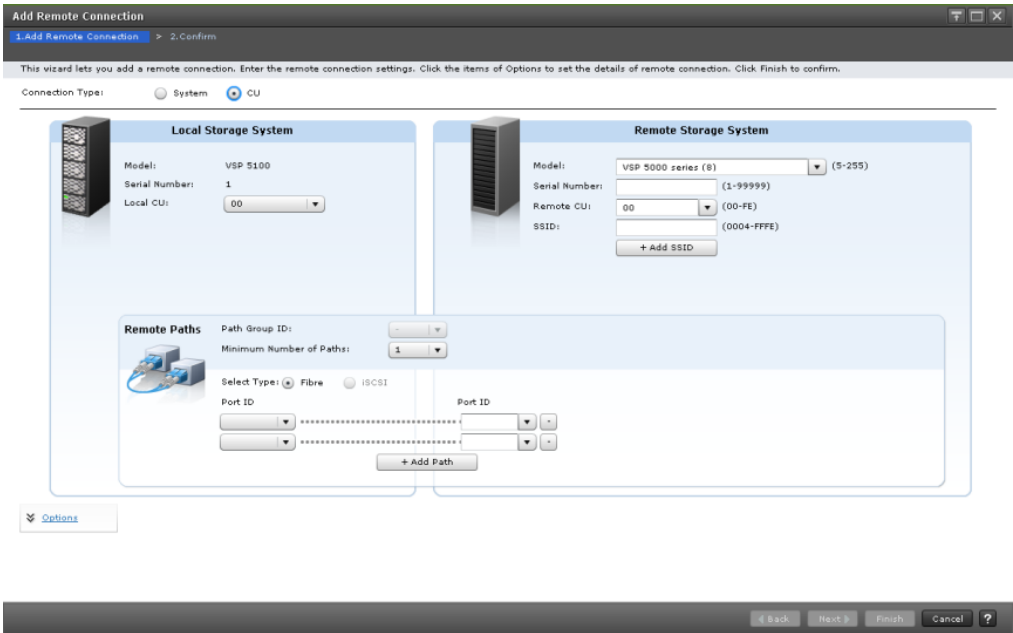

Item	Description
Connection Type	<ul style="list-style-type: none"> <li>▪ System: system-to-system connection. TC/UR/URz/GAD.</li> <li>▪ CU: CU-to-CU connections. TCz only.</li> </ul> By default, System is selected.

**Local Storage System**

Item	Description
Model	Local model.
Serial Number	Local serial number.
Local CU	Local system CU number (00 to FE), displayed when Connection Type is CU. A hyphen (-) is displayed when Connection Type is System.

## Remote Storage System

Item	Description
Model	<p>Remote system's model.</p> <ul style="list-style-type: none"> <li>▪ VSP 5000 series (8)</li> </ul> <p>If the local storage does not display VSP 5000 series (8) in the pull-down menu for Model, enter 8 to specify VSP 5000 series storage.</p> <ul style="list-style-type: none"> <li>▪ VSP G1x00, and VSP F1500 (7)</li> <li>▪ VSP (6)</li> </ul> <p>If a value other than the above is specified, it is regarded as a storage system that will be supported in the future. In this case, in the <b>Remote Connections</b> window, the specified value will be enclosed by parentheses, such as (255), is displayed.</p>
Serial Number	<p>Last five or six digits of the remote system serial number, as follows:</p> <ul style="list-style-type: none"> <li>▪ VSP 5000 series and VSP G1x00, VSP F1500: 1 to 99999 (5 digits)</li> <li>▪ VSP: 1 to 99999 (5 digits)</li> <li>▪ Future storage systems: 0 to 99999</li> </ul> <p>When using virtual storage machine volumes, make sure to specify the serial number of the physical storage system. Do not specify the serial number of a virtual storage machine.</p>
Remote CU	Remote system CU number, displayed when Connection Type is CU.
SSID	Remote system SSID in hexadecimal (0004 to FEFF). Can be selected when Connection Type is CU. If there are two or more SSID numbers, clicking the minus (-) button deletes the SSID text box.
Add SSIDs	Clicking adds the SSID to the remote system. The maximum is four. This button is not displayed if four SSID numbers are already added.

**Remote Paths**

Item	Description
Path Group ID	Path group identifier (00 to FF). Up to 64 path group IDs can be registered per storage system. Path group IDs can be selected when Connection Type is System.
Minimum Number of Paths	Minimum number of remote paths. <ul style="list-style-type: none"> <li>▪ TC and TCz: The range is from 1 to 8, and the default is 1.</li> <li>▪ UR and URz: The minimum number is set to 1, regardless of the number entered.</li> </ul>
Select Type	Select the port type. <ul style="list-style-type: none"> <li>▪ Fibre: Fibre Channel port</li> <li>▪ iSCSI: iSCSI port</li> </ul>
Port ID (for local storage systems)	Select the port identifier of the local storage system.
Virtual Port ID (for local storage systems)	Virtual port ID of the local storage system. Displayed when iSCSI is selected as the port type.
Port ID (for remote storage systems)	Select the port identifier of a remote storage system. A hyphen (-) is displayed if the number of valid paths is greater than the minimum number of paths. Clicking the hyphen deletes the text box of the port for the local and remote storage systems.
IP address	Select the IP type (IPv4 or IPv6) for the port of the remote storage system to enter the IP address. Displayed only when iSCSI is selected as the port type.
TCP Port Number	Enter the TCP port number of the remote storage system. Displayed only when iSCSI is selected as the port type.
Add Paths	Opens a dialog box for creating additional paths (maximum of eight).

**Options**

Item	Description
RIO MIH Time	Time limit between 10 and 100 seconds for the data-transfer operation to complete (15 is the default).

Item	Description
Roundtrip Time (msec.)	TC, TCz and GAD only. Time limit between 1 and 500 milliseconds for data copy from P-VOL to S-VOL (1 is the default).
FREEZE Option (Mainframe systems)	Enables or disables support for the CGROUP (FREEZE/RUN) PPRC TSO command. Can be selected when Connection Type is CU.

## Add Remote Connection confirmation window

Enter a name for the task. Confirm the settings in the list and click Apply to add the task in Tasks queue for execution.

Task Name:  (Max. 32 Characters)

Selected Remote Connection						
Connection Type	Local CU	Remote Storage System Model / Serial Number	CU	SSID	Path Group ID	Number of Remote Paths
CU	00	VSP G1000/G1500 and VSP F1500 / 12345	00	0004	-	1

Selected Remote Paths						
Local			Remote			
Port ID	Port Type	Virtual Port ID	Port ID	IP Address	TCP Port Number	
CL1-A	Fibre	-	CL5-A	-	-	

Total: 1

Go to tasks window for status | Back | Next | Apply | Cancel | ?

In this topic, you can view the following tables.

- [Selected Remote Connection table \(on page 253\)](#)
- [Selected Remote Paths table \(on page 254\)](#)

### Selected Remote Connection table

Item	Description
Connection Type	System or CU.
Local CU	TCz only.

Item	Description
	Specified local system CU number, displayed when Connection Type is CU.
Remote Storage System	<ul style="list-style-type: none"> <li>▪ Model / Serial Number: Model and serial number.</li> <li>▪ CU: CU number.</li> <li>▪ SSID: SSID.</li> </ul>
Path Group ID	Specified path group identifier.
Number of Remote Paths	Specified number of remote paths.
Minimum Number of Paths	Specified minimum number of remote paths.
RIO MIH Time (sec.)	Specified RIO MIH time.
Roundtrip Time (msec.)	Specified roundtrip time.
FREEZE Option	Specified FREEZE option.

**Selected Remote Paths table**

Item	Description
Local	Information about ports on the local storage system. <ul style="list-style-type: none"> <li>▪ Port ID: Port identifier</li> <li>▪ Port Type: Port type can be Fibre, iSCSI</li> <li>▪ Virtual Port ID: Virtual port ID. Displayed when the port type is iSCSI.</li> </ul>
Remote	Information about ports on the remote storage system. <ul style="list-style-type: none"> <li>▪ Port ID: Port identifier</li> <li>▪ IP Address (displayed only when the port type is iSCSI)</li> <li>▪ TCP Port Number (displayed only when the port type is iSCSI)</li> </ul>

**View Remote Connection Properties window**

Use this window to view information about remote connections and paths.



Item	Description
Path Group ID	Path group identifier.
Channel Type	Displays the channel type or type of data path. <ul style="list-style-type: none"> <li>▪ Fibre: Local port type of all remote paths in the remote connection is Fibre.</li> <li>▪ iSCSI: Local port type of all remote paths in the remote connection is iSCSI.</li> <li>▪ Mixed: Local port type of at least two remote paths in the remote connection is not the same.</li> </ul>
Status	Remote connection status. <ul style="list-style-type: none"> <li>▪ Normal: All remote path within remote connection are fine.</li> <li>▪ Failed: All remote path within remote connection has problem.</li> <li>▪ Warning: Some remote path within remote connection has problem.</li> </ul>
Minimum Number of Paths	The specified minimum number of remote paths.
RIO MIH Time	The specified RIO MIH time in seconds.
Roundtrip Time	The specified roundtrip time in milliseconds.
FREEZE Option	Whether the FREEZE option is enabled or disabled.
Registered Time	Date and time the connection was established.
Last Update Date	Date and time of the last update.
Number of Remote Paths	Number of paths specified in the remote connection.

**Remote Paths table**

Item	Description
Local	Information about ports on local storage systems. <ul style="list-style-type: none"> <li>▪ Port ID: Port identifier</li> <li>▪ Port Type: Port type (Fibre, iSCSI)</li> <li>▪ Virtual Port ID: Virtual port ID. Displayed when the port type is iSCSI.</li> </ul>



Item	Description
Remote	Information about ports on remote storage systems. <ul style="list-style-type: none"> <li>Port ID: Port identifier</li> <li>IP Address: IP address of the port. Displayed when the port type is iSCSI.</li> <li>TCP Port Number: TCP port number of the port. Displayed when the port type is iSCSI.</li> </ul>
Status	Remote path status.

## Remove Remote Connections window

Use this window to remove remote connections.

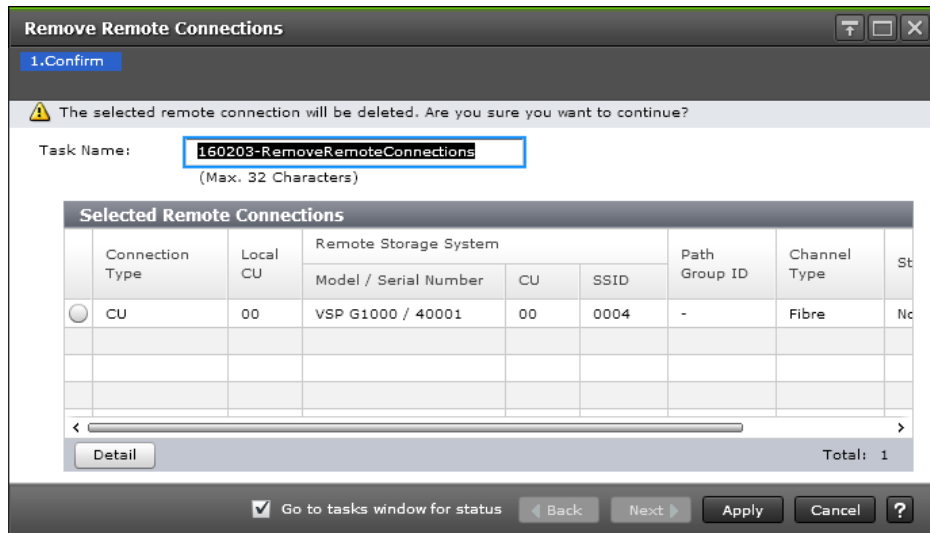

### Selected Remote Connections table

Item	Description
Connection Type	<ul style="list-style-type: none"> <li>System: system-to-system connection.</li> <li>CU: CU-to-CU connections.</li> </ul>
Local CU	Local system CU number.
Remote Storage System	<ul style="list-style-type: none"> <li>Model / Serial Number: Model and serial number.</li> <li>CU: CU number.</li> <li>SSID: SSID number. TCz only.</li> </ul>

Item	Description
Path Group ID	TC only. Path group identifier.
Channel Type	Channel type for remote connections. <ul style="list-style-type: none"> <li>▪ Fibre: Port type of all remote paths in the remote connection is Fibre.</li> <li>▪ iSCSI: Port type of all remote paths in the remote connection is iSCSI.</li> <li>▪ Mixed: Port type of all remote paths in the remote connection is not the same (at least two are different).</li> </ul>
Status	Path status.
Number of Remote Paths	Number of remote paths including those being added.
Detail	Opens the <b>View Remote Connection Properties</b> window.

## Edit Remote Connection Options wizard

Use this wizard to edit remote connection options.

## Edit Remote Connection Options window

You use this window to edit remote connection options, such as minimum paths and round trip time.

**Selected Remote Connection table**

Item	Description
Minimum Number of Paths	Minimum number of remote paths. <ul style="list-style-type: none"> <li>TC and TCz: The range is from 1 to 8, and the default is 1.</li> <li>UR and URz: The minimum number is set to 1, regardless of the number entered.</li> </ul>
RIO MIH Time	Time limit between 10 and 100 seconds (default = 15) for the data-transfer operation to complete.
Round Trip Time	TC, TCz, and GAD only.  Time limit between 1 and 500 milliseconds for data copy from P-VOL to S-VOL (1 is the default).
FREEZE Option	TCz only.  Enables or disables support for the <b>CGROUP (FREEZE/RUN) PPRC TSO</b> command. <ul style="list-style-type: none"> <li>Enable: The local storage system accepts and runs the <b>CGROUP</b> command.</li> <li>Disable: The local storage system rejects the <b>CGROUP</b> command (default).</li> </ul> Displayed only when Connection Type is CU.

**Edit Remote Connection Options confirmation window**

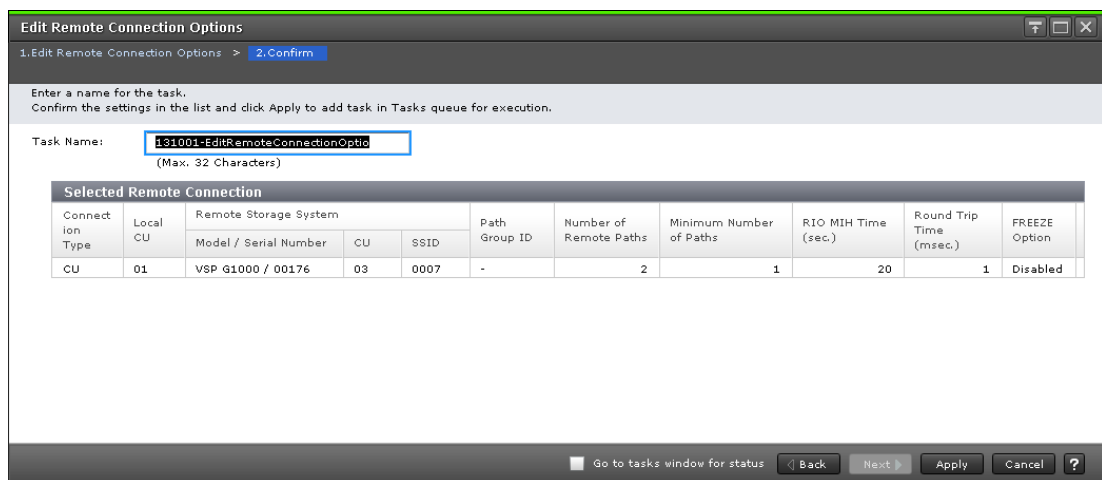

**Selected Remote Connection table**

Item	Description
Connection Type	<ul style="list-style-type: none"> <li>▪ System: system-to-system connection.</li> <li>▪ CU: CU-to-CU connections.</li> </ul>
Local CU	Local system CU number.
Remote Storage System	<ul style="list-style-type: none"> <li>▪ Model / Serial Number: Model and serial number.</li> <li>▪ CU: Remote Storage System's CU number.</li> <li>▪ SSID: Remote Storage System's SSID number. TCz only.</li> </ul>
Path Group ID	Path group identifier.
Number of Remote Paths	Number of remote paths including those being added.
Minimum Number of Paths	<p>Minimum number of remote paths.</p> <ul style="list-style-type: none"> <li>▪ TC and TCz: The range is from 1 to 8, and the default is 1.</li> <li>▪ UR and URz: The minimum number is set to 1, regardless of the number entered.</li> </ul>
RIO MIH Time	Time limit between 10 and 100 seconds (default = 15) for the data-transfer operation to complete.
Round Trip Time (msec.)	<p>TC, TCz, and GAD only.</p> <p>Time limit between 1 and 500 milliseconds for data copy from P-VOL to S-VOL (1 is the default).</p>
FREEZE Option	<p>TCz only.</p> <p>Enables or disables support for the CGROUP (FREEZE/RUN) PPRC TSO command.</p>

## Add Remote Paths wizard

Use this wizard to add remote paths to a remote connection.

## Add Remote Paths window

You use this window to add remote paths to a remote connection.

When Select Type is Fibre:

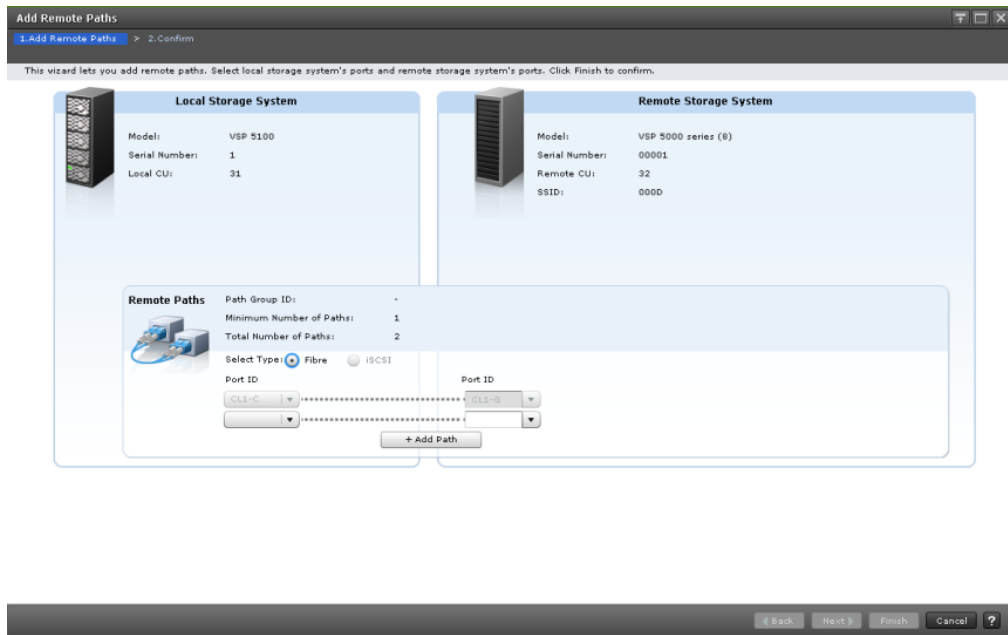

### Local Storage System

Item	Description
Model	Local system model.
Serial Number	Local system serial number.
Local CU	Local system CU number. A hyphen is displayed in case of system connection.

### Remote Storage System

Item	Description
Model	Remote system model.
Serial Number	Remote system serial number.
Remote CU	Remote system CU number. A hyphen is displayed in case of system connection.
SSID	Remote system SSID. A hyphen is displayed in case of system connection.

**Remote Paths**

Item	Description
Path Group ID	Path group identifier. A hyphen is displayed for CU connection.
Minimum Number of Paths	Specified minimum number of remote paths.
Total Number of Paths	Total number of paths. Total of the number of paths registered for remote connections and the number of paths to be added (including blank lines).
Select Type	Select the port type. <ul style="list-style-type: none"> <li>▪ Fibre: Fibre Channel port (default)</li> <li>▪ iSCSI: iSCSI port</li> </ul> For TCz and URz, Fibre is selected automatically because connections using iSCSI ports are not supported.
Port ID (for local storage systems)	Select the port identifier of the local storage system.
Virtual Port ID (for local storage systems)	Virtual port ID of the local storage system. Displayed when iSCSI is selected as the port type.
Port ID (for remote storage systems)	Select the port identifier of a remote storage system. A minus button is displayed if the number of valid paths is greater than the minimum number of paths. Clicking the minus button deletes the text box of the port for the local and remote storage systems.
IP address	Select the IP type (IPv4 or IPv6) for the port of the remote storage system to enter the IP address. Displayed only when iSCSI is selected as the port type.
TCP Port Number	Enter the TCP port number of the port on a remote storage system. Displayed only when iSCSI is selected as the port type.
Add Paths	Clicking adds more paths, up to eight.



Item	Description
Channel Type	Channel type for remote connections. <ul style="list-style-type: none"> <li>▪ Fibre: Port type of all remote paths in the remote connection is Fibre.</li> <li>▪ iSCSI: Port type of all remote paths in the remote connection is iSCSI.</li> <li>▪ Mixed: Port type of at least two remote paths in the remote connection is not the same.</li> </ul>
Number of Remote Paths	Number of remote paths including those being added.
Minimum Number of Paths	Specified minimum number of remote paths.

#### Selected Remote Paths table

Item	Description
Local	Information about ports on the local storage system. <ul style="list-style-type: none"> <li>▪ Port ID: Port identifier</li> <li>▪ Port Type: Port type (Fibre, iSCSI)</li> <li>▪ Virtual Port ID: Virtual port ID. Displayed when iSCSI is selected for Port Type.</li> </ul>
Remote	Information about ports on the remote storage system. <ul style="list-style-type: none"> <li>▪ Port ID: Port identifier</li> <li>▪ IP Address: IP address of the port. Displayed when iSCSI is selected for Port Type.</li> <li>▪ TCP Port Number: TCP port number of the port. Displayed when iSCSI is selected for Port Type.</li> </ul>

## Remove Remote Paths wizard

Use this wizard to remove paths from a remote connection.

### Remove Remote Paths window

Use this window to remove paths from a remote connection.

When Select Type is Fibre:



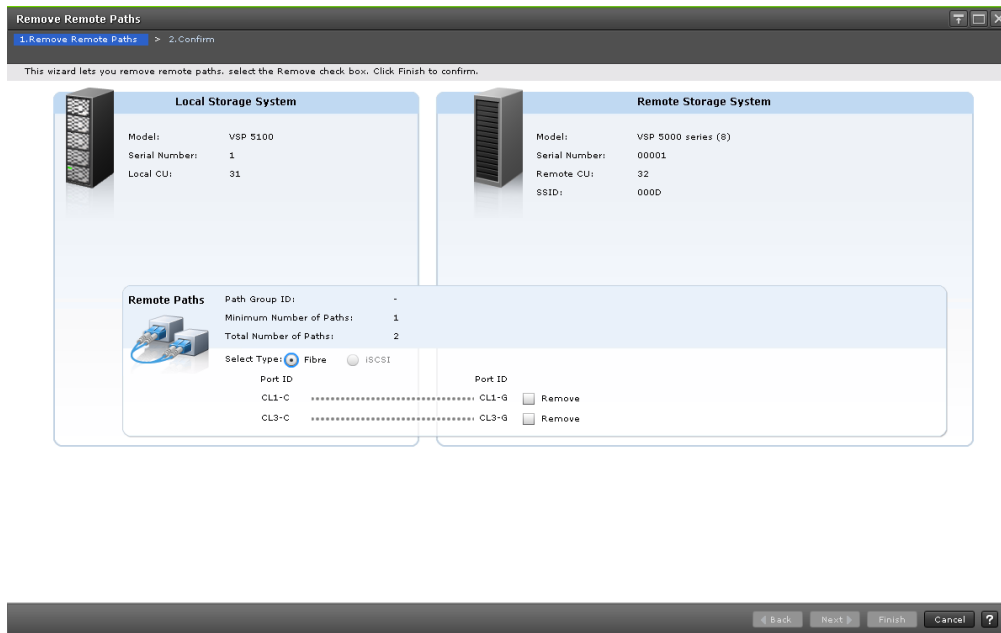

### Local Storage System

Item	Description
Model	Local system model.
Serial Number	Local system serial number.
Local CU	Local system CU number. A hyphen (-) is displayed in the case of system connection.

### Remote Storage System

Item	Description
Model	Remote system model.
Serial Number	Remote system serial number.
Remote CU	Remote system CU number. A hyphen (-) is displayed for system connection.
SSID	Remote system SSID. A hyphen (-) is displayed for system connection.

**Remote Paths**

Item	Description
Path Group ID	Path group identifier. A hyphen is displayed for CU connection.
Minimum Number of Paths	Specified minimum number of remote paths.
Total Number of Paths	Total number of paths. Displays the total number of path registered to remote connection and path to be added (includes blank line).
Select Type	Select the port type. <ul style="list-style-type: none"> <li>▪ Fibre: Fibre Channel port</li> <li>▪ iSCSI: iSCSI port</li> </ul> For TCz and URz, Fibre is selected automatically because connections using iSCSI ports are not supported.
Port ID (for local storage systems)	Port identifier of the local storage system. Information of the added paths.
Virtual Port ID (for local storage systems)	Virtual port ID of the local storage system. Displayed only when iSCSI is selected as the port type.
Port ID (for remote storage systems)	Port identifier of a remote storage system. Information of the added paths.
IP address	IP address of a port on a remote storage system. Displayed only when iSCSI is selected as the port type.
TCP Port Number	TCP port number of a port on a remote storage system. Displayed only when iSCSI is selected as the port type.
Remove	Check box for deleting the path from the remote connection.



Item	Description
Minimum Number of Paths	Specified minimum number of remote paths.

**Selected Remote Paths table**

Item	Description
Local	Information about ports on the local storage system. <ul style="list-style-type: none"> <li>▪ Port ID: Port identifier</li> <li>▪ Port Type: Port type (Fibre, iSCSI)</li> <li>▪ Virtual Port ID: Virtual port ID. Displayed when iSCSI is selected for Port Type.</li> </ul>
Remote	Information about ports on the remote storage system. <ul style="list-style-type: none"> <li>▪ Port ID: Port identifier</li> <li>▪ IP Address: IP address of the port. Displayed when iSCSI is selected for Port Type.</li> <li>▪ TCP Port Number: TCP port number of the port. Displayed when iSCSI is selected for Port Type.</li> </ul>

## Edit Remote Replica Options wizard

Use this wizard to change options that affect the replication system.

## Edit Remote Replica Options window

You use this window to change options that affect the replication system.

This wizard lets you edit one or more properties. Enter the new value and click Finish to confirm.

Copy Type: TC/TCMF

Storage System Options:

Maximum Initial Copy Activities: 64 (1-512)

Blocked Path Monitoring: 40 Second(s) (2-45)

Blocked Path SIM Monitoring: 70 Second(s) (2-100)

Services SIM of Remote Copy:  Report  No Report

CU Options:

Maximum Initial Copy Activities:  Enable  Disable

CU	Maximum Initial Copy Activities	PPRC Support	Services SIM
00	-	No	No Report
01	-	No	No Report
02	-	No	No Report
03	-	No	No Report
04	-	No	No Report
05	-	No	No Report
06	-	No	No Report
07	-	No	No Report
08	-	No	No Report
09	-	No	No Report

Change CU Options Selected: 0 of 255

Back Next Finish Cancel ?

In this topic, you can view the following tables.

- [Setting Fields \(on page 270\)](#)
- [Storage System Options \(on page 270\)](#)
- [CU Options \(on page 270\)](#)

## Setting Fields

Item	Description
Copy Type	Type of pair: <ul style="list-style-type: none"> <li>▪ TC/TCMF: TrueCopy or TrueCopy for Mainframe</li> <li>▪ UR/URMF: Universal Replicator or Universal Replicator for Mainframe</li> <li>▪ GAD: global-active device</li> </ul>
Maximum Initial Copy Activities	Number of volumes that can be copied per initial copy operation: 1 to 512 (default = 64). Displayed only when GAD is selected for Copy Type.

## Storage System Options

This area is not displayed when GAD is selected for Copy Type.

Item	Description
Maximum Initial Copy Activities	Number of volumes that can be copied per initial copy operation. When the selected Copy Type is TC/TCMF or GAD: 1 to 512 (default = 64) When the selected Copy Type is UR/URMF: 1 to 128 (default = 64)
Blocked Path Monitoring	Number of seconds for the system to monitor blocked paths: 2 to 45 (default = 40). Displayed for TC or TCz pairs. <b>Note:</b> When monitoring the path blockade in GAD or UR/URz, select TC/TCMF for Copy Type, then enter the value.
Blocked Path SIM Monitoring	Number of seconds for the system to monitor SIMs reported for blocked paths: 2 to 100 (default = 70). Displayed for TC or TCz pairs. <b>Note:</b> When monitoring a SIM reported by path blockade in GAD or UR/URz, select TC/TCMF for Copy Type, then enter the value.
Services SIM of Remote Copy	Whether services SIMs in the remote CU are reported to the host (default = No Report). Displayed for TC or TCz pairs.

## CU Options

The CU options are not displayed when the selected Copy Type is GAD.

Item	Description
Maximum Initial Copy Activities*	<ul style="list-style-type: none"> <li>Enable: Allows you to change the maximum initial copy activities setting for the selected CUs.</li> <li>Disable (default): The maximum initial copy activities setting for each CU cannot be set or changed.</li> </ul>
CU	CU number.
Maximum Initial Copy Activities*	Maximum initial copy activities setting for the CU (default = 4). A hyphen is displayed if Disable is selected in Maximum Initial Copy Activities.
PPRC Support*	Whether PPRC is supported by the host (default = No).
Services SIM	Whether remote copy service SIMs are reported to the host (default = No Report).
Change CU Options	Opens the <b>Change CU Options</b> window to allow you to change the CU options for the selected CUs. This button cannot be used if the Disable radio button is selected for Maximum Initial Copy Activities.
* These items are displayed only when the selected Copy Type is TC/TCMF.	

## Change CU Options window

This window allows you to change the CU options for the CUs selected on the **Edit Remote Replica Options** window.

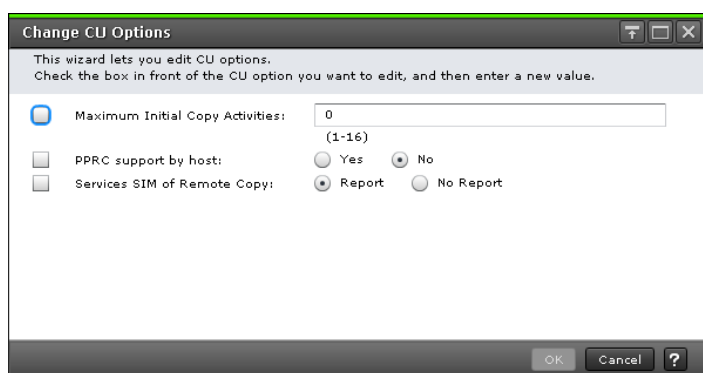

Item	Description
Maximum Initial Copy Activities	<p>Maximum number of volumes that can be copied concurrently for the CUs selected on the <b>Edit Remote Replica Options</b> window.</p> <p>This setting is available only when Enable is selected for Maximum Initial Copy Activities.</p>

Item	Description
PPRC support by host	TCz only. Whether PPRC is supported by the host.
Services SIM of Remote Copy	Whether services SIMs in the remote CU are reported to the host.

## Edit Remote Replica Options confirmation window

1.Edit Remote Replica Options > 2.Confirm

Enter a name for the task. Confirm the settings in the list and click Apply to add task in Tasks queue for execution.

Task Name:  (Max. 32 Characters)

TC/TCMF Storage System Options				
Maximum Initial Copy Activities	Blocked Path Monitoring (sec)	Blocked Path SIM Monitoring (sec)	Services SIM	
64	40	70	No Report	

TC/TCMF CU Options				
CU	Maximum Initial Copy Activities	PPRC Support	Services SIM	
00	-	No	No Report	
01	-	No	No Report	
02	-	No	No Report	
03	-	No	No Report	
04	-	No	No Report	
05	-	No	No Report	
06	-	No	No Report	
07	-	No	No Report	
08	-	No	No Report	
09	-	No	No Report	
0A	-	No	No Report	
0B	-	No	No Report	
0C	-	No	No Report	
0D	-	No	No Report	
0E	-	No	No Report	
0F	-	No	No Report	
10	-	No	No Report	
11	-	No	No Report	

Total: 255

Go to tasks window for status

In this topic, you can view the following tables.

- [Storage System Options \(on page 273\)](#)
- [CU Options \(on page 273\)](#)



**Storage System Options**

Item	Description
Maximum Initial Copy Activities	Number of volumes that can be copied per initial copy operation.
Blocked Path Monitoring (sec)	TC/TCz only. Number of seconds for the system to monitor blocked paths
Blocked Path SIM Monitoring (sec)	TC/TCz only. Number of seconds for the system to monitor SIMs reported for blocked paths
Services SIM	TC/TCz only. Whether services SIMs are reported to the host.

**CU Options**

Following will not be displayed if selecting GAD for Copy Type.

Item	Description
CU	CU number.
Maximum Initial Copy Activities	TC/TCz only. Number of volumes that can be copied per initial copy operation.
PPRC support by host	TC/TCz only. Whether PPRC is supported by the host.
Services SIM	Whether services SIMs are reported.

**Edit SCP Time wizard**

Use this wizard to edit the SCP time.

**Edit SCP Time window**

Use this window to edit the SCP time.

For complete information and instructions, see [Changing the SCP time \(on page 118\)](#).

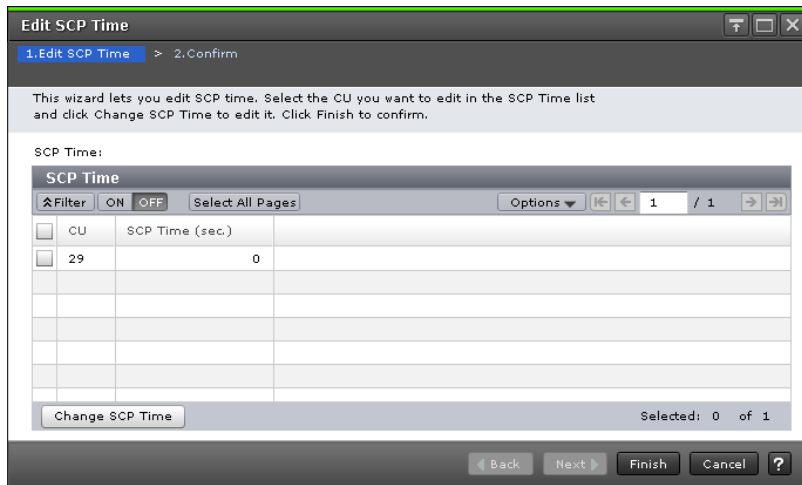

Item	Description
CU	CU number.
SCP Time (sec.)	Interval that I/O from the host is suspended. Shared with Compatible FlashCopy® V2.
Change SCP Time	Opens the <b>Change SCP Time</b> window.

## Change SCP Time window

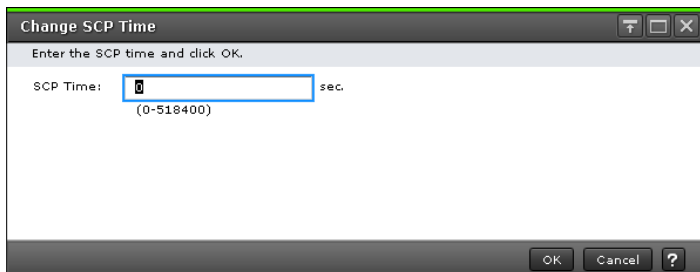

Item	Description
SCP Time	The new SCP time. You can specify a value between 0 and 518,400 (6 days).

## Edit SCP Time confirmation window

Item	Description
CU	CU number.
SCP Time (sec.)	New SCP time.

## Create Pairs wizard

Use this wizard to create pairs.

## Create TC Pairs window or Create UR Pairs window

Use this window to create pairs.

For complete information and instructions, see [Creating pairs \(on page 122\)](#).

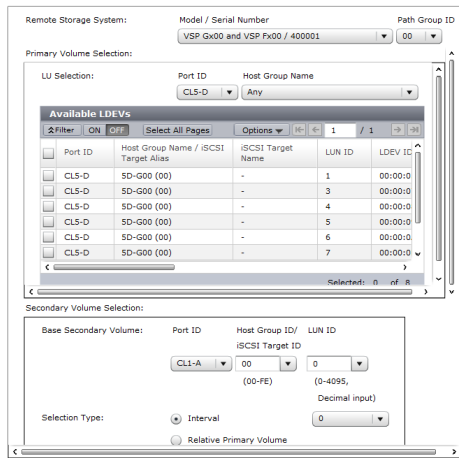
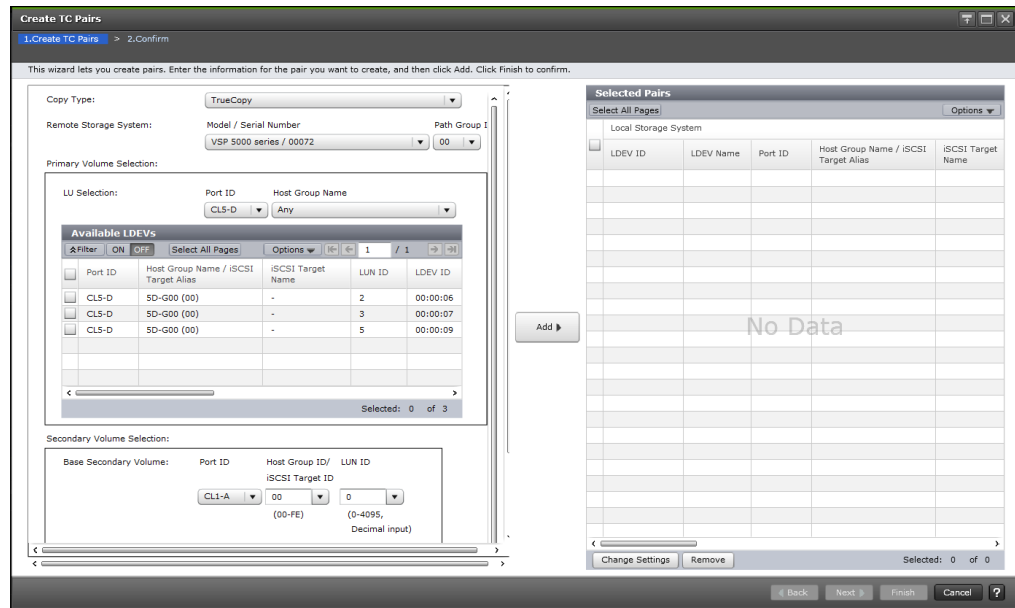

In this topic, you can view the following tables.

- [Settings \(on page 277\)](#)
- [Primary Volume Selection \(on page 277\)](#)
- [Secondary Volume Selection \(on page 280\)](#)
- [Mirror Selection \(on page 281\)](#)
- [Options \(on page 282\)](#)
- [Selected Pairs table \(on page 285\)](#)

**Settings**

Item	Description
Copy Type	Type of pair: <ul style="list-style-type: none"> <li>▪ TrueCopy</li> <li>▪ Universal Replicator</li> <li>▪ TrueCopy for Mainframe</li> <li>▪ Universal Replicator for Mainframe</li> </ul>
Local CU	TCz only. Local system's CU number. You can select the CU number of the local storage system between [00] and [FE].
Remote Storage System	Selections in the remote system. <ul style="list-style-type: none"> <li>▪ Model / Serial Number: Model and serial number.</li> <li>▪ Path Group ID: Select the ID of the path group. Does not display for TCz.</li> <li>▪ CU/SSID: CU number and SSID. TCz only. Specify this when you select a provisional CU number in Local CU.</li> </ul>

**Primary Volume Selection**

Item	Description
Use Existing Volumes of UR Pairs	UR only. <ul style="list-style-type: none"> <li>▪ Yes: Create a pair using the existing volumes of UR pairs. For , select this item when creating a pair with 3DC multi-target by 3 UR sites or with cascade configuration.</li> <li>▪ No: Create a pair without using the existing volumes of UR pairs. For , select this item when not creating a pair with 3DC multi-target by 3 UR sites or with cascade configuration.</li> </ul>

Item	Description
Use Existing Volumes of URMF Pairs	URz only. <ul style="list-style-type: none"> <li>▪ Yes: Create a pair using the existing volumes of URz pairs. Select this item when creating a pair with 3DC multi-target by 3 URz sites or with cascade configuration.</li> <li>▪ No: Create a pair without using the existing volumes of URz pairs. Select this item when not creating a pair with 3DC multi-target by 3 URz sites or with cascade configuration.</li> </ul>
LU Selection	TC and UR only. <ul style="list-style-type: none"> <li>▪ Port ID: Local system's port identifier.</li> <li>▪ Host Group Name: Host group name. If Any is selected, every LUN for the specified port is displayed in the Available LDEVs table or in the Available Primary Volumes table. Displayed when Fibre port is selected for Port ID.</li> <li>▪ iSCSI Target Alias: iSCSI target Alias. If Any is selected, every LUN for the specified port is displayed in the Available LDEVs table or in the Available Primary Volumes table. Displayed when iSCSI port is selected for Port ID.</li> </ul>
Available LDEVs table (TC/TCz)  Available Primary Volumes table (UR/URz)	Information about P-VOLs. Displayed when Fibre port is selected in Port ID for LU Selection. <ul style="list-style-type: none"> <li>▪ Port ID: Port identifier. TC and UR only.</li> <li>▪ Host Group Name/iSCSI Target Alias: Host group name or iSCSI target alias. TC and UR only.</li> <li>▪ iSCSI Target Name: iSCSI target name. TC and UR only.</li> <li>▪ LUN ID: LUN identifier. TC and UR only.</li> <li>▪ LDEV ID: LDEV identifier.</li> <li>▪ LDEV Name: LDEV name.</li> <li>▪ Pair Position: Whether the volume is a primary or secondary volume. A blank indicates an unpaired volume. UR/URz only.</li> <li>▪ Journal ID: Journal identifier. A blank indicates an unpaired volume. UR/URz only.</li> <li>▪ Mirror ID: Mirror identifier. A blank indicates an unpaired volume. UR/URz only.</li> <li>▪ Provisioning Type: Provisioning type of the volume. Whether the volume is Basic (internal) or External.</li> </ul>

Item	Description
	<ul style="list-style-type: none"> <li>▪ Attribute: <ul style="list-style-type: none"> <li>• ALU: The volume has the ALU attribute.</li> <li>• SLU: The volume has the SLU attribute.</li> <li>• Data Direct Mapping: The volume has the data direct mapping attribute.</li> </ul> <p>If the attribute is not set, a hyphen (-) is displayed. TC and UR only.</p> </li> <li>▪ Emulation Type: Emulation type. TC/TCz/URz only.</li> <li>▪ Capacity: LDEV's capacity.</li> <li>▪ CLPR: CLPR ID.</li> <li>▪ Encryption: Encryption information. <ul style="list-style-type: none"> <li>• Enabled: Encryption of the parity group to which the LDEV belongs is enabled, or a V-VOL is associated with a pool in which a pool volume has encryption enabled.</li> <li>• Disabled: Encryption of the parity group to which the LDEV belongs is disabled, or a V-VOL is associated with a pool in which a pool volume has encryption disabled.</li> <li>• Mixed: The pool to which the LDEV belongs contains two or more of the following: <ul style="list-style-type: none"> <li>▪ Volume for which encryption is enabled</li> <li>▪ Volume for which encryption is disabled</li> <li>▪ External volume</li> </ul> <p><b>Note:</b> Encryption of data is not ensured in an LDEV with the Mixed encryption status. To manage data encryption, use an LDEV in which Encryption is Enabled or Disabled.</p> <p>For an external volume or migration volume, a hyphen (-) is displayed.</p> <p>For V-VOLs of Dynamic Provisioning or Dynamic Provisioning for Mainframe, the pool to which the LDEV belongs is an external volume or blocked.</p> </li> </ul> </li> </ul>

Item	Description
	<ul style="list-style-type: none"> <li>▪ Paired Volume: Information about a paired volume. A blank indicates that the volume is not used by the pair. UR/URz only                             <ul style="list-style-type: none"> <li>• Model / Serial Number: Model and serial number.</li> <li>• LDEV ID: LDEV identifier.</li> <li>• Port ID: Volume's port identifier. UR only.</li> <li>• Host Group ID/iSCSI Target ID: Volume's host group ID or iSCSI target ID. UR only.</li> <li>• LUN ID: Volume's LUN identifier. UR only.</li> </ul> </li> <li>▪ Capacity Saving: Information on the capacity saving function.                             <ul style="list-style-type: none"> <li>• Compression: The compression function is used.</li> <li>• Deduplication and Compression: The deduplication function and the compression function are used.</li> <li>• Disabled: The capacity saving function is not used.</li> </ul> </li> <li>▪ T10 PI<sup>1</sup>: T10 PI attribute of the volume.                             <ul style="list-style-type: none"> <li>• Enabled: T10 PI attribute of the volume is enabled.</li> <li>• Disabled: T10 PI attribute of the volume is disabled.</li> </ul> <p>The T10 PI attribute status is displayed only for TC/UR pairs.</p> </li> </ul>

### Secondary Volume Selection

Item	Description
Base Secondary Volume	<p>Selections for the initial S-VOL. TC and UR only.</p> <ul style="list-style-type: none"> <li>▪ Port ID: Port identifier.</li> <li>▪ Host Group ID/iSCSI Target ID: Host group identifier or iSCSI target identifier.</li> <li>▪ LUN ID: LUN identifier.</li> </ul>



Item	Description
	<p>TCz and URz only.</p> <ul style="list-style-type: none"> <li>▪ LDKC: "00" is displayed, cannot be changed.</li> <li>▪ CU: For TCz: CU number of the volume. For URz: the CU number of the remote system, ranging from 00 to FF.</li> <li>▪ LDEV: LDEV number, ranging from 00 to FF.</li> </ul>
Selection Type	<p>Default is Interval.</p> <ul style="list-style-type: none"> <li>▪ Interval: Interval for allocating S-VOLs.</li> <li>▪ Relative Primary Volume: S-VOLs paired with P-VOLs relative to LUN or LDEV numbers.</li> </ul>

### Mirror Selection

UR and URz only.

Item	Description
Master Journal	<p>Master journal number and type.</p> <p>The journal type option is enclosed by parentheses.</p> <p>If Yes is selected for Use Existing Volumes of UR Pairs or Use Existing Volumes of URMF Pairs, Depend on Selected P-Vols is selected.</p>
Mirror ID	Mirror's identifier.
Restore Journal	Restore journal number. All journal IDs (000 to 0FF) are displayed.
Current Number of Master Journal Mirrors	Number of mirrors in the master journal.
Total Number of Master Journal Mirrors	<p>Displays the following:</p> <ul style="list-style-type: none"> <li>▪ Number of mirrors in the master journal.</li> <li>▪ Number of mirrors added during the Create UR Pairs operation.</li> <li>▪ Number of mirrors for the selected volume in Selected Pairs table.</li> </ul>
CTG ID	UR only.

Item	Description
	Displays the consistency groups registered in the storage system. An asterisk indicates that the group is assigned to a pair in the Select Pairs table.

### Options

Item	Description
Primary Volume Fence Level	<p>TC and TCz only</p> <p>Whether the P-VOL can be written to when the pair is split due to error.</p> <ul style="list-style-type: none"> <li>▪ Data: Cannot be written to.</li> <li>▪ Status: Can be written to only if the primary system can change the S-VOL status to PSUE for TC or Suspend for TCz. If the primary system cannot change the S-VOL status to PSUE for TC or Suspend for TCz, the P-VOL cannot be written to.</li> <li>▪ Never: Can be written to, even if the primary system cannot change the S-VOL status. The default.</li> </ul>
Initial Copy Type	<p>Whether data is copied to the S-VOL during this operation.</p> <ul style="list-style-type: none"> <li>▪ Entire Volume: Data is copied. The default.</li> <li>▪ None: Data is not copied.</li> <li>▪ Delta: Data is not copied. UR/URz only.</li> </ul>

Item	Description
Copy Pace	<p>Number of tracks to be copied per remote I/O during the operation. The default is 15. The range is different depending on the volume emulation type.</p> <ul style="list-style-type: none"> <li>▪ OPEN-V (TC): The range is 1 to 4. <ul style="list-style-type: none"> <li>• 1 is slow. This setting limits the impact on host I/O to maintain storage system performance.</li> <li>• 2 and 3 is medium.</li> <li>• 4 is fast. This setting increases the impact on host I/O and might result in decreased storage system performance.</li> </ul> <p>If you enter a number from 5 to 15, the speed of 4 (fast copy pace) is used.</p> </li> <li>▪ Other than OPEN-V (TCz): The range is 1 to 15. <ul style="list-style-type: none"> <li>• 1 to 5 are a slow copy pace, and are used to reduce impact on host I/O.</li> <li>• 6 to 10 are a medium copy pace.</li> <li>• 11 to 15 are a fast copy pace, and the host I/O performance might be degraded.</li> </ul> </li> <li>▪ TrueCopy for Mainframe: You can specify 3 or 15 from the list. <ul style="list-style-type: none"> <li>• 3 is slow. This setting limits the impact on host I/O to maintain storage system performance.</li> <li>• 15 is fast. This setting increases the impact on host I/O and might result in decreased storage system performance.</li> </ul> </li> </ul>
Initial Copy Priority	Scheduling order for the initial copy operation. The range is 1 to 256, and the default is 32.
CFW Data	<p>TCz only.</p> <p>Whether CFW (DASD fast write) data is copied to the S-VOL.</p> <ul style="list-style-type: none"> <li>▪ Primary Volume Only: Data is not copied to S-VOL (default).</li> <li>▪ Secondary Volume Copy: Data is copied to S-VOL.</li> </ul>
DFW to Secondary Volume	TCz only.

Item	Description
	<p>Whether the primary system splits the pair when the secondary system cannot copy DFW data to the S-VOL.</p> <ul style="list-style-type: none"> <li>▪ Require: Splits the pair.</li> <li>▪ Not Require: Does not split.</li> </ul> <p>Some combinations of the DFW setting and the primary volume fence level setting might cause an eternal I/O error in a host application when the P-VOL is updated. Track pairs for which DFW is set to Require to make sure that this item is not blocked.</p> <p>IBM PPRC commands do not support this item. If you use the CESTPAIR TSO command to create a TCz pair, this item is set to Not Require.</p>
Host I/O Time Stamp Transfer	<p>TCz only.</p> <p>Whether the host I/O time stamp is transferred from P-VOL to S-VOL.</p>
Error Level	<p>UR and URz only.</p> <p>Whether to split all pairs in the mirror if a failure occurs during this operation:</p> <ul style="list-style-type: none"> <li>▪ Mirror: Pairs in the mirror are split.</li> <li>▪ LU: Only the failed pair is split. UR only.</li> <li>▪ Volume: Only the failed pair is split. URz only.</li> </ul>
CFW	<p>URz only.</p> <p>Whether to copy cache fast write (CFW) data to the S-VOL.</p> <ul style="list-style-type: none"> <li>▪ Primary Volume Only: Does not copy. Default.</li> <li>▪ Secondary Volume Copy: Copies.</li> </ul>

**Selected Pairs table**

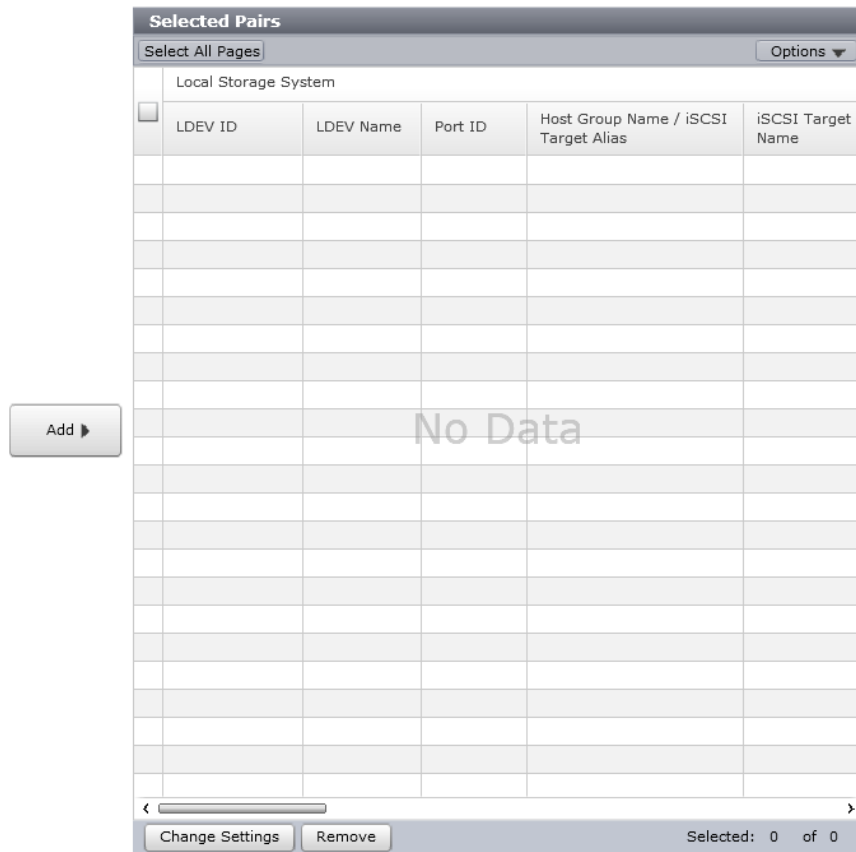

Item	Description
Local Storage System	<p>Information about volumes in the accessed system.</p> <ul style="list-style-type: none"> <li>▪ LDEV ID: LDEV identifier.</li> <li>▪ LDEV Name: LDEV name.</li> <li>▪ Port ID: Port identifier. TC/UR only.</li> <li>▪ Host Group Name/iSCSI Target Alias: Host group name or iSCSI target alias. TC/UR only.</li> <li>▪ iSCSI Target Name: iSCSI target name. TC/UR only.</li> <li>▪ LUN ID: LUN identifier. TC/UR only.</li> <li>▪ Pair Position: UR or URz only. Indicates whether the volume is the P-VOL or S-VOL of the pair.</li> <li>▪ Emulation Type: Emulation type of the volume. TCz/TC/URz only.</li> </ul>

Item	Description
	<ul style="list-style-type: none"> <li>▪ Attribute: <ul style="list-style-type: none"> <li>• ALU: The volume has the ALU attribute.</li> <li>• SLU: The volume has the SLU attribute.</li> <li>• Data Direct Mapping: The volume has the data direct mapping attribute.</li> </ul> <p>If the attribute is not set, a hyphen (-) is displayed. TC and UR only.</p> </li> <li>▪ Journal ID: Journal's identifier. UR or URz only.</li> <li>▪ Mirror ID: Mirror identifier. UR or URz only.</li> <li>▪ Capacity: Capacity of the volume.</li> <li>▪ CLPR: CLPR ID of the volume.</li> <li>▪ Encryption: Encryption information: <ul style="list-style-type: none"> <li>• Enabled: Encryption of the parity group to which the LDEV belongs is enabled, or a V-VOL is associated with a pool in which a pool volume has encryption enabled.</li> <li>• Disabled: Encryption of the parity group to which the LDEV belongs is disabled, or a V-VOL is associated with a pool in which a pool volume has encryption disabled.</li> <li>• Mixed: The pool to which the LDEV belongs contains two or more of the following: <ul style="list-style-type: none"> <li>▪ Volume for which encryption is enabled</li> <li>▪ Volume for which encryption is disabled</li> <li>▪ External volume</li> </ul> <p><b>Note:</b> Encryption of data is not ensured in an LDEV with the Mixed encryption status. To manage data encryption, use an LDEV in which Encryption is Enabled or Disabled.</p> <p>For an external volume, a hyphen (-) is displayed.</p> <p>For V-VOLs of Dynamic Provisioning or Dynamic Provisioning for Mainframe, the pool to which the LDEV belongs is an external volume or blocked.</p> </li> </ul> </li> </ul>

Item	Description
	<ul style="list-style-type: none"> <li>▪ Journal Encryption: Journal's encryption status. UR or URz only.                             <ul style="list-style-type: none"> <li>• Enabled: The journal contains encrypted volumes.</li> <li>• Disabled: The journal contains unencrypted volumes.</li> <li>• Mixed: The pool to which the journal volume belongs contains two or more of the following:                                     <ul style="list-style-type: none"> <li>▪ Volume for which encryption is enabled</li> <li>▪ Volume for which encryption is disabled</li> <li>▪ External volume</li> </ul> </li> </ul> <p><b>Note:</b> Encryption of data is not ensured in an LDEV with the Mixed encryption status. To manage data encryption, use an LDEV in which Encryption is Enabled or Disabled.</p> <p>A hyphen (-) is displayed if the pool to which the journal volume belongs is an external volume, created by migration, or blocked.</p> </li> <li>▪ Capacity Saving: Information on the capacity saving function.                             <ul style="list-style-type: none"> <li>• Compression: The compression function is used.</li> <li>• Deduplication and Compression: The deduplication function and the compression function are used.</li> <li>• Disabled: The capacity saving function is not used.</li> </ul> </li> <li>▪ T10 PI<sup>1</sup>: T10 PI attribute of the volume.                             <ul style="list-style-type: none"> <li>• Enabled: T10 PI attribute of the volume is enabled.</li> <li>• Disabled: T10 PI attribute of the volume is disabled.</li> </ul> <p>The T10 PI attribute status is displayed only for TC or UR pairs.</p> </li> </ul>
Remote Storage System	<p>Information about the remote system.</p> <ul style="list-style-type: none"> <li>▪ Model / Serial Number: Model and serial number.</li> <li>▪ Port ID: Port identifier. TC/UR only.</li> <li>▪ Host Group ID/iSCSI Target ID: Host group identifier or iSCSI target identifier. TC/UR only.</li> <li>▪ LUN ID: LUN identifier. TC/UR only.</li> <li>▪ SSID: SSID number. TCz only.</li> <li>▪ LDEV ID: LDEV identifier. TCz/URz only</li> <li>▪ Journal ID: Journal's identifier. UR/URz only.</li> </ul>

Item	Description
Path Group ID	Path group ID. Not used with TCz.
Fence Level	TC or TCz only. P-VOL fence level.
CTG ID	UR only. Consistency group identifier.
Initial Copy Type	Type of the pair create operation.
Copy Pace	TC or TCz only. Number of tracks copied per remote I/O operation.
Initial Copy Priority	Scheduling order for pair create operation.
CFW Data	TCz only. Whether CFW data is copied to the S-VOL.
DFW to Secondary Volume	TCz only. Whether the primary system splits pairs when the secondary system cannot copy DFW data to the S-VOL.
Host I/O Time Stamp Transfer	TCz only. Whether the host's time stamp is transferred to the S-VOL.
Error Level	UR or URz only. Whether all pairs in the mirror are split if a failure occurs during this operation.
CFW	URz only. Whether CFW data is copied to the S-VOL.
Change Settings	Opens the <b>Change Settings</b> window.
Delete	Deletes the specified pair from the table.

## Change Settings window

Use this window in the pair creation wizard to change options that affect how the pair is created.



Item	Description
Base Secondary Volume	Selections for the initial S-VOL. TC, UR and GAD only. <ul style="list-style-type: none"> <li>▪ Port ID: Port identifier.</li> <li>▪ Host Group ID/iSCSI Target ID: Host group identifier or iSCSI target identifier.</li> <li>▪ LUN ID: LUN identifier.</li> <li>▪ Interval: The interval for allocating S-VOLs to P-VOLs.</li> </ul> TCz and URz only. <ul style="list-style-type: none"> <li>▪ LDKC: "00" is displayed, cannot be changed.</li> <li>▪ CU: For TCz: the CU number of the volume. For URz: the CU number of the remote system, ranging from 00 to FF.</li> <li>▪ LDEV: LDEV number, ranging from 00 to FF.</li> </ul>
Primary Volume Fence Level	TC or TCz only

Item	Description
	<p>Whether the P-VOL can be written to when the pair is split due to error.</p> <ul style="list-style-type: none"> <li>▪ Data: The P-VOL cannot be written to.</li> <li>▪ Status: The P-VOL can be written to only if the primary system can change S-VOL status to PSUE (TC) or Suspend (TCz). If the primary system cannot change S-VOL status, the P-VOL cannot be written to.</li> <li>▪ Never: The P-VOL can be written to.</li> </ul>
Initial Copy Type	<p>Whether data is copied to the S-VOL when the pair is created.</p> <ul style="list-style-type: none"> <li>▪ Entire Volume: Data is copied. The default.</li> <li>▪ None: Data is not copied. If you choose this option, you must confirm the data be equal between the P-VOL and S-VOL.</li> <li>▪ Delta: Data is not copied. UR or URz only.</li> </ul> <p>For UR: The status is changed to HOLD or HOLDING as a pair for delta resync.</p> <p>For URz: The status is changed to Hold or Holding as a pair for delta resync.</p>

Item	Description
Copy Pace	<p>Number of tracks to be copied per remote I/O during the operation. The default is 15. The range is different depending on the volume emulation type.</p> <ul style="list-style-type: none"> <li>▪ OPEN-V (TC and GAD): The range is 1 to 4. <ul style="list-style-type: none"> <li>• 1 is slow. This setting limits the impact on host I/O to maintain storage system performance.</li> <li>• 2 and 3 is medium.</li> <li>• 4 is fast. This setting increases the impact on host I/O and might result in decreased storage system performance.</li> </ul> <p>If you enter a number from 5 to 15, the speed of 4 (fast copy pace) is used.</p> </li> <li>▪ Other than OPEN-V (TCz): The range is 1 to 15. <ul style="list-style-type: none"> <li>• 1 to 5 are a slow copy pace, and are used to reduce impact on host I/O.</li> <li>• 6 to 10 are a medium copy pace.</li> <li>• 11 to 15 are a fast copy pace, and the host I/O performance might be degraded.</li> </ul> </li> <li>▪ TrueCopy for Mainframe: You can specify 3 or 15 from the list. <ul style="list-style-type: none"> <li>• 3 is slow. This setting limits the impact on host I/O to maintain storage system performance.</li> <li>• 15 is fast. This setting increases the impact on host I/O and might result in decreased storage system performance.</li> </ul> </li> </ul>
ALUA Mode	<p>GAD only. Whether ALUA Mode is enabled:</p> <ul style="list-style-type: none"> <li>▪ Enabled: The LDEV is used in ALUA mode.</li> <li>▪ Disabled: The LDEV is not used in ALUA mode.</li> </ul>
Initial Copy Priority	<p>Scheduling order for the initial copy operation: range = 1 to 256, default = 32. Not displayed for GAD.</p>
CFW Data	<p>TCz only.</p> <p>Whether CFW (DASD fast write) data is copied to the S-VOL.</p> <ul style="list-style-type: none"> <li>▪ Primary Volume Only: Data not copied (default).</li> <li>▪ Secondary Volume Copy: Data is copied.</li> </ul>

Item	Description
	<p><b>Note:</b></p> <ul style="list-style-type: none"> <li>▪ To apply the pair option that is set on the P-VOL to the S-VOL, split and then resynchronize the TCz pair.</li> <li>▪ Do not specify Primary Volume Only if system option mode (SOM) 1091 is ON. If you do, I/O to the S-VOL might terminate abnormally.</li> <li>▪ Do not set SOM 1091 to ON if you changed the CFW data setting after you created the TCz pair. If you do, I/O to the S-VOL might terminate abnormally.</li> </ul>
DFW to Secondary Volume	<p>TCz only.</p> <p>Whether the primary system splits the pair when the secondary system cannot copy DFW data to the S-VOL</p> <ul style="list-style-type: none"> <li>▪ Require: Splits the pair.</li> <li>▪ Not Require: Does not split.</li> </ul> <p>Some combinations of the DFW setting and the primary volume fence level setting might cause an eternal I/O error in a host application when the P-VOL is updated. Track pairs for which DFW is set to Require to make sure that this item is not blocked.</p> <p>IBM PPRC commands do not support this item. If you use the CESTPAIR TSO command to create a TCz pair, this item is set to Not Require.</p>
Host I/O Time Stamp Transfer	<p>TCz only.</p> <ul style="list-style-type: none"> <li>▪ Enable: The host I/O time stamp is transferred from P-VOL to S-VOL (default).</li> <li>▪ Disable: The host I/O time stamp is not transferred from P-VOL to S-VOL.</li> </ul> <p>Whether the host I/O time stamp is transferred from P-VOL to S-VOL.</p>
Error Level	<p>UR and URz only.</p> <p>Whether to split all pairs in the mirror if a failure occurs during this operation:</p> <ul style="list-style-type: none"> <li>▪ LU: Only the failed pair is split. UR only.</li> <li>▪ Mirror: Pairs in the mirror are split.</li> <li>▪ Volume: Only the failed pair is split.</li> </ul>
CFW	URz only.

Item	Description
	Whether to copy cache fast write (CFW) data to the S-VOL. <ul style="list-style-type: none"> <li>▪ Primary Volume Only: Does not copy. Default.</li> <li>▪ Secondary Volume Copy: Copies.</li> </ul>

## Create Pairs confirmation window

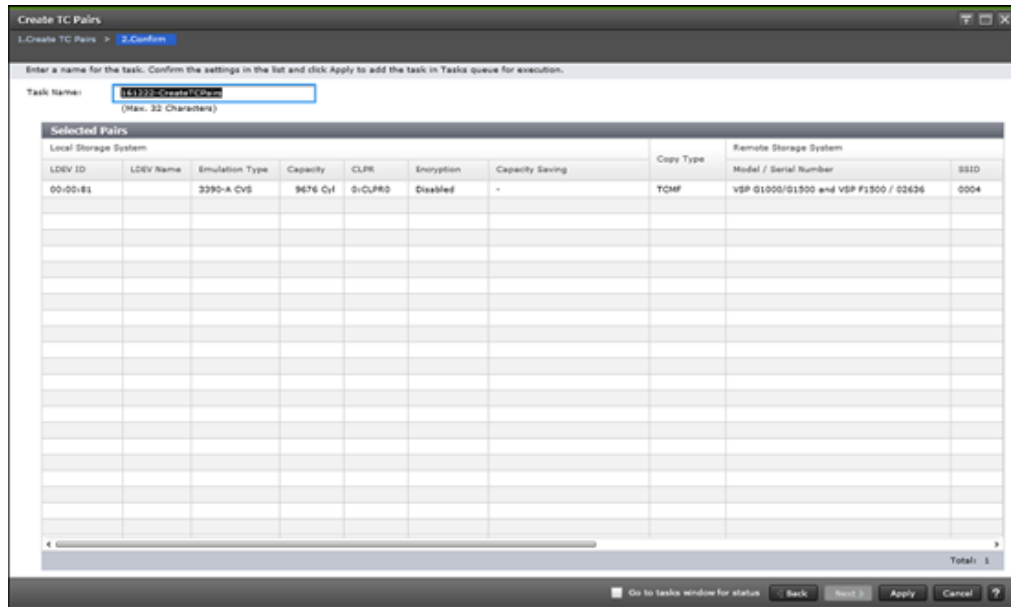

### Selected Pairs table

Item	Description
Local Storage System	Information about volumes in the accessed system. <ul style="list-style-type: none"> <li>▪ LDEV ID: LDEV identifier.</li> <li>▪ LDEV Name: LDEV name.</li> <li>▪ Port ID: Port identifier. TC/UR only.</li> <li>▪ Host Group Name/iSCSI Target Alias: Host group name or iSCSI target alias. TC/UR only.</li> <li>▪ iSCSI Target Name: iSCSI target name. TC/UR only.</li> <li>▪ LUN ID: LUN identifier. TC/UR only.</li> <li>▪ Pair Position: UR or URz only. Indicates whether the volume is the P-VOL or S-VOL of the pair.</li> </ul>

Item	Description
	<ul style="list-style-type: none"> <li>▪ Emulation Type: Emulation type of the volume. TCz/TC/URz only.</li> <li>▪ Attribute: <ul style="list-style-type: none"> <li>• ALU: The volume has the ALU attribute.</li> <li>• SLU: The volume has the SLU attribute.</li> <li>• Data Direct Mapping: The volume has the data direct mapping attribute.</li> </ul> <p>If the attribute is not set, a hyphen (-) is displayed. TC and UR only.</p> </li> <li>▪ Journal ID: Journal's identifier. UR or URz only.</li> <li>▪ Mirror ID: Mirror identifier. UR or URz only.</li> <li>▪ Capacity: Capacity of the volume.</li> <li>▪ CLPR: CLPR ID of the volume.</li> <li>▪ Encryption: Encryption information: <ul style="list-style-type: none"> <li>• Enabled: Encryption of the parity group to which the LDEV belongs is enabled, or a V-VOL is associated with a pool in which a pool volume has encryption enabled.</li> <li>• Disabled: Encryption of the parity group to which the LDEV belongs is disabled, or a V-VOL is associated with a pool in which a pool volume has encryption disabled.</li> <li>• Mixed: The pool to which the LDEV belongs contains two or more of the following: <ul style="list-style-type: none"> <li>▪ Volume for which encryption is enabled</li> <li>▪ Volume for which encryption is disabled</li> <li>▪ External volume</li> </ul> </li> </ul> <p><b>Note:</b> Encryption of data is not ensured in an LDEV with the Mixed encryption status. To manage data encryption, use an LDEV in which Encryption is Enabled or Disabled.</p> <p>For an external volume, a hyphen (-) is displayed.</p> <p>For V-VOLs of Dynamic Provisioning or Dynamic Provisioning for Mainframe, the pool to which the LDEV belongs is an external volume or blocked.</p> </li> </ul>

Item	Description
	<ul style="list-style-type: none"> <li>▪ Journal Encryption: Journal's encryption status. UR or URz only. <ul style="list-style-type: none"> <li>• Enabled: The journal contains encrypted volumes.</li> <li>• Disabled: The journal contains unencrypted volumes.</li> <li>• Mixed: The pool to which the journal volume belongs contains two or more of the following: <ul style="list-style-type: none"> <li>▪ Volume for which encryption is enabled</li> <li>▪ Volume for which encryption is disabled</li> <li>▪ External volume</li> </ul> </li> </ul> </li> </ul> <p><b>Note:</b> Encryption of data is not ensured in an LDEV with the Mixed encryption status. To manage data encryption, use an LDEV in which Encryption is Enabled or Disabled.</p> <p>A hyphen (-) is displayed if the pool to which the journal volume belongs is an external volume, created by migration, or blocked.</p> <ul style="list-style-type: none"> <li>▪ Capacity Saving: Information on the capacity saving function. <ul style="list-style-type: none"> <li>• Compression: The compression function is used.</li> <li>• Deduplication and Compression: The deduplication function and the compression function are used.</li> <li>• Disabled: The capacity saving function is not used.</li> </ul> </li> <li>▪ T10 PI<sup>1</sup>: T10 PI attribute of the volume. <ul style="list-style-type: none"> <li>• Enabled: T10 PI attribute of the volume is enabled.</li> <li>• Disabled: T10 PI attribute of the volume is disabled.</li> </ul> </li> </ul> <p>The T10 PI attribute status is displayed only for TC pairs and UR pairs.</p>
Copy Type	Type of pair: <ul style="list-style-type: none"> <li>▪ TC: TrueCopy</li> <li>▪ UR: Universal Replicator</li> <li>▪ TCMF: TrueCopy for Mainframe</li> <li>▪ URMF: Universal Replicator for Mainframe</li> </ul>
Remote Storage System	Information about volumes in the system connected to the system you accessed. <ul style="list-style-type: none"> <li>▪ Model / Serial Number: Model and serial number.</li> <li>▪ Port ID: Port identifier. TC/UR only.</li> </ul>

Item	Description
	<ul style="list-style-type: none"> <li>▪ Host Group ID/iSCSI Target ID: Host group identifier or iSCSI target identifier. TC/UR only.</li> <li>▪ LUN ID: LUN identifier. TC/UR only.</li> <li>▪ SSID: SSID number. TCz only.</li> <li>▪ LDEV ID: LDEV identifier. TCz/URz only.</li> <li>▪ Journal ID: Journal's identifier. UR or URz only.</li> </ul>
Path Group ID	Path group identifier. Not shown for TCz.
CTG ID	UR only. Consistency group identifier.
Fence Level	TC or TCz only Whether the P-VOL can be written to when the pair is split due to error. <ul style="list-style-type: none"> <li>▪ Data: Cannot be written to.</li> <li>▪ Status: Can be written to only if the primary system can change the S-VOL status to Suspend. If the primary system cannot change the S-VOL status, the P-VOL cannot be written to.</li> <li>▪ Never: Can be written to.</li> </ul>
Initial Copy Type	Pair creation operation type.
Copy Pace	TC or TCz only Number of tracks to be copied per remote I/O operation.
Initial Copy Priority	Scheduling order for the initial copy operation. The range is 1 to 256, and the default is 32.
CFW Data	TCz only. Whether CFW (DASD fast write) data is copied to the S-VOL. <ul style="list-style-type: none"> <li>▪ Primary Volume Only: Data not copied (default).</li> <li>▪ Secondary Volume Copy: Data is copied.</li> </ul> This is displayed only for TCz pairs.
DFW to Secondary Volume	TCz only. Whether the primary system splits the pair when the secondary system cannot copy DFW data to the S-VOL <ul style="list-style-type: none"> <li>▪ Require: Splits the pair.</li> <li>▪ Not Require: Does not split.</li> </ul>



Item	Description
Host I/O Time Stamp Transfer	TCz only. Whether the host I/O time stamp is transferred from P-VOL to S-VOL.
Error Level	UR or URz only. Whether to split all pairs in the mirror if a failure occurs during this operation: <ul style="list-style-type: none"> <li>▪ Mirror: Pairs in the mirror are split.</li> <li>▪ Volume: Only the failed pair is split.</li> </ul>
CFW	URz only. Whether to copy cache fast write (CFW) data to the S-VOL. <ul style="list-style-type: none"> <li>▪ Primary Volume Only: Does not copy. Default.</li> <li>▪ Secondary Volume Copy: Copies.</li> </ul>

## Split Pairs wizard

Use this wizard to split pairs.

## Split Pairs window

Use this window to split pairs.

For complete information and instructions, see [Splitting pairs \(on page 125\)](#).

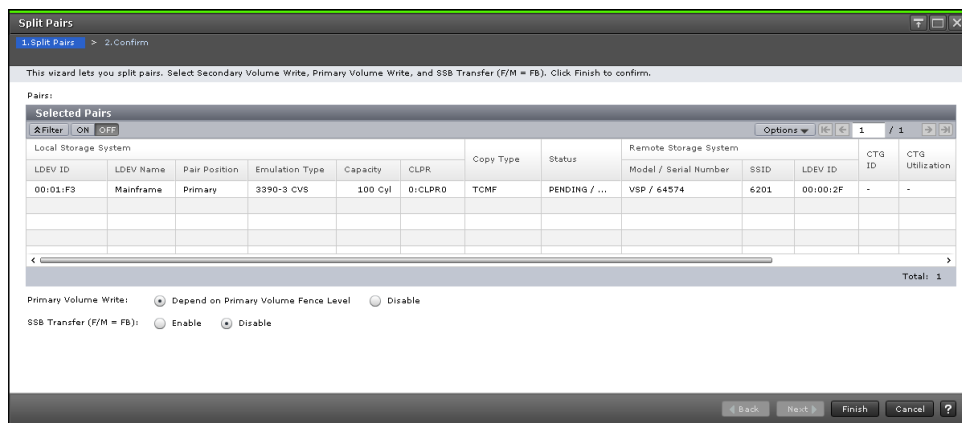

In this topic, you can view the following tables.

- [Selected Pairs table \(on page 298\)](#)
- [Setting Fields \(on page 299\)](#)

## Selected Pairs table

Item	Description
Local Storage System	Information about volumes in the accessed system. <ul style="list-style-type: none"> <li>▪ LDEV ID: LDEV identifier.</li> <li>▪ LDEV Name: LDEV name.</li> <li>▪ Pair Position: Whether volume is a P-VOL or S-VOL.</li> <li>▪ Emulation Type: Emulation type of the volume.</li> <li>▪ Capacity: Capacity of the volume.</li> <li>▪ CLPR: CLPR ID of the volume.</li> </ul>
Copy Type	Type of pair: <ul style="list-style-type: none"> <li>▪ TC: TrueCopy</li> <li>▪ TCMF: TrueCopy for Mainframe</li> </ul>
Status	Pair status.
Remote Storage System	Information about the remote system. <ul style="list-style-type: none"> <li>▪ Model / Serial Number: Model and serial number.</li> <li>▪ SSID: SSID number. TCz only.</li> <li>▪ LDEV ID: LDEV identifier.</li> </ul>
Path Group ID	TC only. Path group identifier.
CTG ID	Pair's consistency group identifier.
CTG Utilization	Whether the consistency group is shared by multiple storage systems. <ul style="list-style-type: none"> <li>▪ Single: The consistency group consists of a single pair of primary and secondary storage systems.</li> <li>▪ Multi: The consistency group consists: The consistency group consists of multiple storage systems.</li> </ul>
Preserve Mirror Status	TCz only. <ul style="list-style-type: none"> <li>▪ Blank: Indicates that it is a Preserve Mirror status without any problem or it is not a Preserve Mirror pair.</li> <li>▪ Withdrawn: Indicates that pair volume data does not match due to suspending copy of Compatible FlashCopy® V2.</li> </ul>
Fence Level	P-VOL fence level.

Setting Fields

Item	Description
Secondary Volume Write	TC only. Whether the S-VOL can be written to while the pair is split. <ul style="list-style-type: none"> <li>Enable: Can write to S-VOL. Available only when performing the split operation from the pair's primary storage system.</li> <li>Disable: Prevents writing to S-VOL. Default.</li> </ul>
Primary Volume Write	Whether the P-VOL can be written to while the pair is split. <ul style="list-style-type: none"> <li>Depends on Primary Volume Fence Level: Writing to P-VOL depends on the Primary Volume Fence Level Setting. Default.</li> <li>Disable: Prevents writing to the P-VOL. Available only when performing the split operation from the pair's primary storage system.</li> </ul>
SSB Transfer (F/M=FB)	TCz only. Whether to report SSB (sense byte) to the host. Enable/Disable (the default). Enable is available only when performing the split operation from the pair's primary storage system.

Split Pairs confirmation window

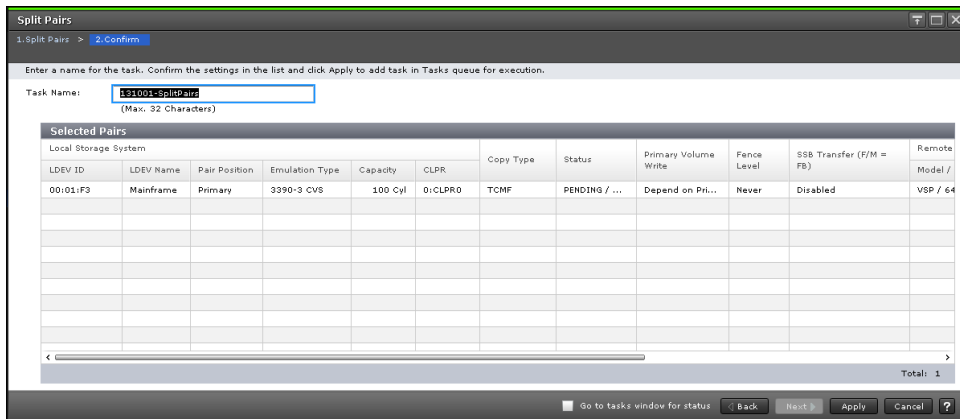

## Selected Pairs table

Item	Description
Local Storage System	Information about volumes in the accessed system. <ul style="list-style-type: none"> <li>▪ LDEV ID: LDEV identifier.</li> <li>▪ LDEV Name: LDEV name.</li> <li>▪ Pair Position: Whether volume is a P-VOL or S-VOL.</li> <li>▪ Emulation Type: Emulation type of the volume.</li> <li>▪ Capacity: Capacity of the volume.</li> <li>▪ CLPR: CLPR ID of the volume.</li> </ul>
Copy Type	Type of pair: <ul style="list-style-type: none"> <li>▪ TC: TrueCopy</li> <li>▪ TCMF: TrueCopy for Mainframe</li> </ul>
Status	Pair status.
Secondary Volume Write	TC only. Whether the S-VOL can be written to while the pair is split. <ul style="list-style-type: none"> <li>▪ Enable: Can write to S-VOL.</li> <li>▪ Disable (default): Prevents writing to S-VOL.</li> </ul> A hyphen is displayed if performing the split operation from the pair's secondary storage system, regardless of the selected option.
Primary Volume Write	Whether the P-VOL can be written to while the pair is split. <ul style="list-style-type: none"> <li>▪ Depends on Primary Volume Fence Level: Writing to P-VOL depends on the Primary Volume Fence Level Setting. Default.</li> <li>▪ Disable: Prevents writing to the P-VOL.</li> </ul> A hyphen is displayed if performing the split operation from the pair's secondary storage system, regardless of the selected option.
Fence Level	P-VOL's fence level setting.
SSB Transfer (F/M=FB)	TCz only. Whether to report SSB (sense byte) to the host. Enable/Disable. A hyphen is displayed if performing the split operation from the pair's secondary storage system, regardless of the selected option.

Item	Description
Remote Storage System	Information about the remote system. <ul style="list-style-type: none"> <li>▪ Model / Serial Number: Model and serial number.</li> <li>▪ SSID: SSID number. TCz only.</li> <li>▪ LDEV ID: LDEV identifier.</li> </ul>
Path Group ID	TC only. Path group identifier.
CTG ID	Pair's consistency group identifier.
CTG Utilization	Whether the consistency group is shared by multiple storage systems. <ul style="list-style-type: none"> <li>▪ Single: The consistency group consists of a single pair of primary and secondary storage systems.</li> <li>▪ Multi: The consistency group consists of multiple storage systems.</li> </ul>
Preserve Mirror Status	TCz only. <ul style="list-style-type: none"> <li>▪ Blank: Indicates that it is a Preserve Mirror status without any problem or it is not a Preserve Mirror pair.</li> <li>▪ Withdrawn: Indicates that pair volume data does not match due to suspending copy of Compatible FlashCopy® V2.</li> </ul>

## Resync Pairs wizard

Use this wizard to resynchronize pairs.

## Resync Pairs window

Use this window to resynchronize pairs.

For complete information and instructions, see [Resynchronizing pairs \(on page 127\)](#).

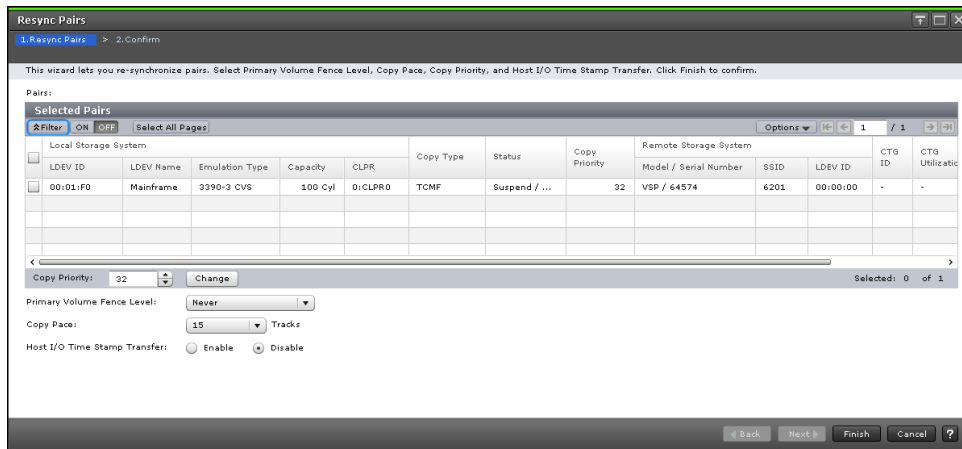

In this topic, you can view the following tables.

- [Selected Pairs table \(on page 302\)](#)
- [Setting Fields \(on page 303\)](#)

### Selected Pairs table

Item	Description
Local Storage System	Information about volumes in the accessed system. <ul style="list-style-type: none"> <li>▪ LDEV ID: LDEV identifier.</li> <li>▪ LDEV Name: LDEV name.</li> <li>▪ Emulation Type: Emulation type of the volume.</li> <li>▪ Capacity: Capacity of the volume.</li> <li>▪ CLPR: CLPR ID of the volume.</li> </ul>
Copy Type	Type of pair: <ul style="list-style-type: none"> <li>▪ TC: TrueCopy</li> <li>▪ TCMF: TrueCopy for Mainframe</li> </ul>
Status	Pair status.
Copy Priority	Order that pairs are resynchronized.
Remote Storage System	Information about the remote system. <ul style="list-style-type: none"> <li>▪ Model / Serial Number: Model and serial number.</li> <li>▪ SSID: SSID number. TCz only.</li> <li>▪ LDEV ID: LDEV identifier.</li> </ul>
Path Group ID	TC only. Path group identifier.

Item	Description
CTG ID	Pair's consistency group identifier.
CTG Utilization	Whether the consistency group is shared by multiple storage systems. <ul style="list-style-type: none"> <li>▪ Single: The consistency group consists of a single pair of primary and secondary storage systems.</li> <li>▪ Multi: The consistency group consists of multiple storage systems.</li> </ul>
Preserve Mirror Status	TCz only. <ul style="list-style-type: none"> <li>▪ Blank: Indicates that it is a Preserve Mirror status without any problem or it is not a Preserve Mirror pair.</li> <li>▪ Withdrawn: Indicates that pair volume data does not match due to suspending copy of Compatible FlashCopy® V2.</li> </ul>
Copy Priority	Order that pairs are resynchronized. Specify a value from 1 through 256 for TC, 0 through 256 for TCz.

### Setting Fields

Item	Description
Primary Volume Fence Level	Whether the P-VOL can be written to when the pair is split due to error. <ul style="list-style-type: none"> <li>▪ Data: The P-VOL cannot be written to.</li> <li>▪ Status: The P-VOL can be written to only if the primary system can change the S-VOL status to PSUE (TC) or Suspend (TCz). If the primary system cannot change the S-VOL status, the P-VOL cannot be written to.</li> <li>▪ Never: The P-VOL can be written to.</li> </ul>
Copy Pace	Maximum number of tracks to be copied per remote I/O during the operation. The default is 15. <ul style="list-style-type: none"> <li>▪ For TC pairs, enter a value from 1 to 15 . When the emulation type is OPEN-V, if you enter a number from 5 to 15, the speed of 4 (fast copy pace) is used.</li> <li>▪ For TCz pairs, specify 3 or 15 from the list.</li> </ul>

Item	Description
Host I/O Time Stamp Transfer	<p>TCz only.</p> <ul style="list-style-type: none"> <li>Enable: The host I/O time stamp is transferred from P-VOL to S-VOL.</li> <li>Disable: The host I/O time stamp is transferred from P-VOL to S-VOL.</li> </ul> <p>Whether the host I/O time stamp is transferred from P-VOL to S-VOL.</p>

## Resync Pairs confirmation window

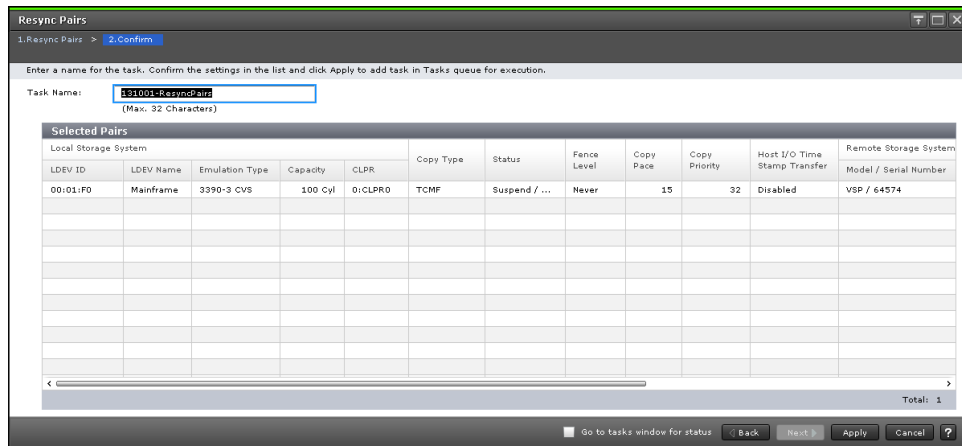

### Selected Pairs table

Item	Description
Local Storage System	<p>Information about volumes in the accessed system.</p> <ul style="list-style-type: none"> <li>LDEV ID: LDEV identifier.</li> <li>LDEV Name: LDEV name.</li> <li>Pair Position: Whether volume is a P-VOL or S-VOL.</li> <li>Emulation Type: Emulation type of the volume.</li> <li>Capacity: Capacity of the volume.</li> <li>CLPR: CLPR ID of the volume.</li> </ul>
Copy Type	<p>Type of pair:</p> <ul style="list-style-type: none"> <li>TC: TrueCopy</li> <li>TCMF: TrueCopy for Mainframe</li> </ul>



Item	Description
Status	Pair status.
Fence Level	<p>Whether the P-VOL can be written to when the pair is split due to error.</p> <ul style="list-style-type: none"> <li>▪ Data: Cannot be written to.</li> <li>▪ Status: Can be written to only if the primary system can change the S-VOL status to PSUE (open) or Suspend (mainframe). If the primary system cannot change the S-VOL status, the P-VOL cannot be written to.</li> <li>▪ Never: Can be written to.</li> </ul>
Copy Pace	Number of tracks to be copied per remote I/O during the operation.
Copy Priority	Order that pairs are resynchronized.
Host I/O Time Stamp Transfer	<p>TCz only.</p> <p>Whether the host I/O time stamp is transferred from P-VOL to S-VOL.</p>
Remote Storage System	<p>Information about the remote system.</p> <ul style="list-style-type: none"> <li>▪ Model / Serial Number: Model and serial number.</li> <li>▪ SSID: SSID number. TCz only.</li> <li>▪ LDEV ID: LDEV identifier.</li> </ul>
Path Group ID	<p>TC only.</p> <p>Path group identifier.</p>
CTG ID	Pair's consistency group identifier.
CTG Utilization	<p>Whether the consistency group is shared by multiple storage systems.</p> <ul style="list-style-type: none"> <li>▪ Single: The consistency group consists of a single pair of primary and secondary storage systems.</li> <li>▪ Multi: The consistency group consists of multiple storage systems.</li> </ul>
Preserve Mirror Status	<p>TCz only.</p> <ul style="list-style-type: none"> <li>▪ Blank: Indicates that it is a Preserve Mirror status without any problem or it is not a Preserve Mirror pair.</li> <li>▪ Withdrawn: Indicates that pair volume data does not match due to suspending copy of Compatible FlashCopy® V2.</li> </ul>

## Delete Pairs wizard

Use this wizard to delete pairs.

## Delete Pairs window

Use this window to delete pairs.

For complete information and instructions, see [Deleting pairs \(on page 129\)](#).

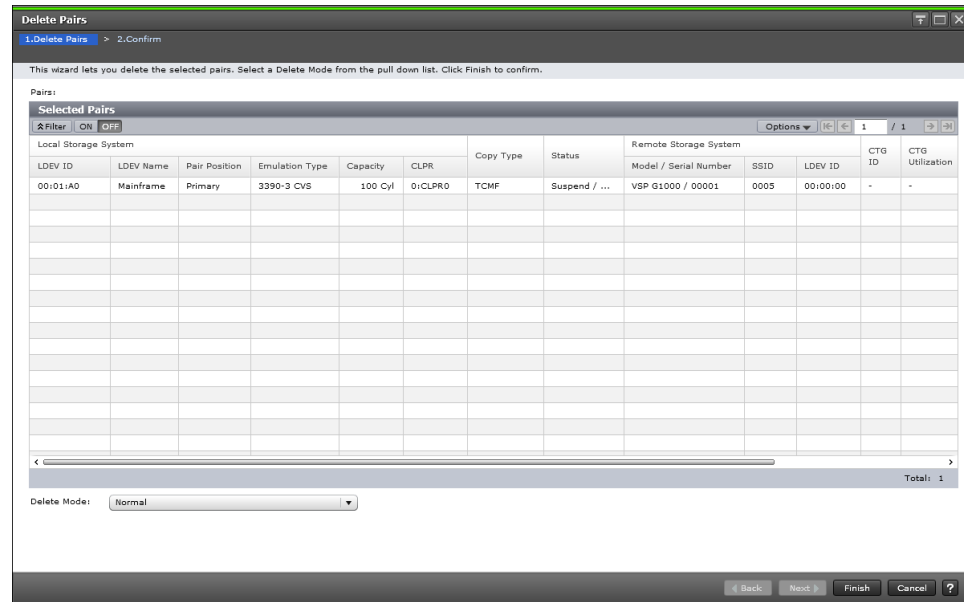

In this topic, you can view the following tables.

- [Selected Pairs table \(on page 306\)](#)
- [Settings \(on page 308\)](#)

### Selected Pairs table

Item	Description
Local Storage System	Information about volumes in the accessed system. <ul style="list-style-type: none"> <li>▪ LDEV ID: LDEV identifier.</li> <li>▪ LDEV Name: LDEV name.</li> <li>▪ Pair Position: Whether volume is a P-VOL or S-VOL.</li> <li>▪ Emulation Type: Emulation type of the volume.</li> <li>▪ Capacity: Capacity of the volume.</li> <li>▪ CLPR: CLPR ID of the volume.</li> </ul>

Item	Description
Copy Type	Type of pair: <ul style="list-style-type: none"> <li>▪ TC: TrueCopy</li> <li>▪ TCMF: TrueCopy for Mainframe</li> </ul>
Status	Pair status.
Remote Storage System	Information about the remote system. <ul style="list-style-type: none"> <li>▪ Model / Serial Number: Model and serial number.</li> <li>▪ SSID: SSID number. TCz only.</li> <li>▪ LDEV ID: LDEV identifier.</li> </ul>
Path Group ID	TC only. Path group identifier.
CTG ID	Pair's consistency group identifier.
CTG Utilization	Whether the consistency group is shared by multiple storage systems. <ul style="list-style-type: none"> <li>▪ Single: The consistency group consists of a single pair of primary and secondary storage systems.</li> <li>▪ Multi: The consistency group consists of multiple storage systems.</li> </ul>
Preserve Mirror Status	TCz only. <ul style="list-style-type: none"> <li>▪ Blank: Indicates that it is a Preserve Mirror status without any problem or it is not a Preserve Mirror pair.</li> <li>▪ Withdrawn: Indicates that pair volume data does not match due to suspending copy of Compatible FlashCopy® V2.</li> </ul>
Fence Level	Whether the P-VOL can be written to when the pair is split due to error. <ul style="list-style-type: none"> <li>▪ Data: The P-VOL cannot be written to.</li> <li>▪ Status: The P-VOL can be written to only if the primary system can change the S-VOL status to PSUE (TC) or Suspend (TCz). If the primary system cannot change the S-VOL status, the P-VOL cannot be written to.</li> <li>▪ Never: The P-VOL can be written to.</li> </ul>

## Settings

Item	Description
Delete Mode	<p>How the pair is deleted.</p> <ul style="list-style-type: none"> <li>▪ Normal: Deletes the pair if the local system can change both P-VOL and S-VOL to unpaired volumes. Default.</li> <li>▪ Force: Deletes the pair even when the local system cannot communicate with the remote system.</li> <li>▪ Force (All pairs in the same remote connections): Deletes forcibly all pairs using the same remote connection. TCz only.</li> </ul>

## Delete Pairs confirmation window

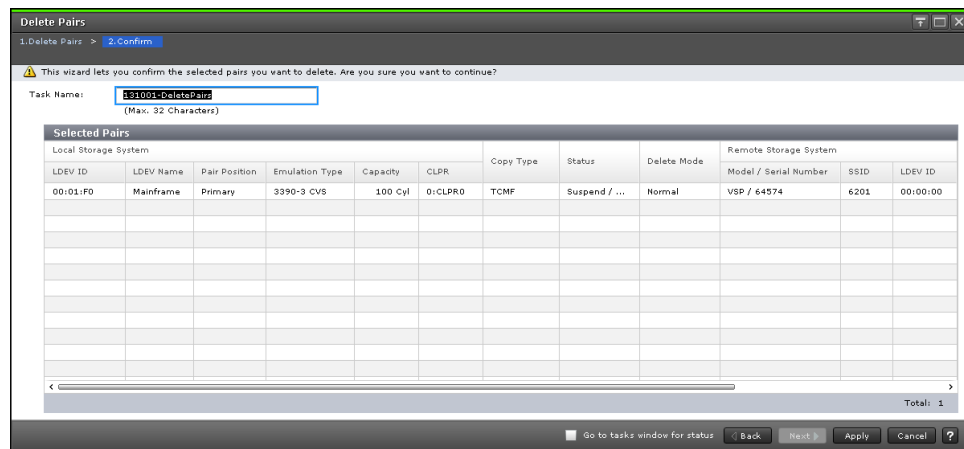

## Selected Pairs table

Item	Description
Local Storage System	<p>Information about volumes in the accessed system.</p> <ul style="list-style-type: none"> <li>▪ LDEV ID: LDEV identifier.</li> <li>▪ LDEV Name: LDEV name.</li> <li>▪ Pair Position: Whether volume is a P-VOL or S-VOL.</li> <li>▪ Emulation Type: Emulation type of the volume.</li> <li>▪ Capacity: Capacity of the volume.</li> <li>▪ CLPR: CLPR ID of the volume.</li> </ul>

Item	Description
Copy Type	Type of pair: <ul style="list-style-type: none"> <li>▪ TC: TrueCopy</li> <li>▪ TCMF: TrueCopy for Mainframe</li> </ul>
Status	Pair status.
Delete Mode	How the pair is deleted.
Remote Storage System	Information about the remote system. <ul style="list-style-type: none"> <li>▪ Model / Serial Number: Model and serial number.</li> <li>▪ SSID: SSID number. TCz only.</li> <li>▪ LDEV ID: LDEV identifier.</li> </ul>
Path Group ID	TC only. Path group identifier.
CTG ID	Pair's consistency group identifier.
CTG Utilization	Whether the consistency group is shared by multiple storage systems. <ul style="list-style-type: none"> <li>▪ Single: The consistency group consists of a single pair of primary and secondary storage systems.</li> <li>▪ Multi: The consistency group consists of multiple storage systems.</li> </ul>
Preserve Mirror Status	TCz only. <ul style="list-style-type: none"> <li>▪ Blank: Indicates that it is a Preserve Mirror status without any problem or it is not a Preserve Mirror pair.</li> <li>▪ Withdrawn: Indicates that pair volume data does not match due to suspending copy of Compatible FlashCopy<sup>®</sup> V2.</li> </ul>
Fence Level	P-VOL fence level.

## Force Delete Pairs (TC Pairs) window

Use this window to forcibly delete pairs.

For complete information and instructions, see [Forcibly deleting pairs \(on page 143\)](#).

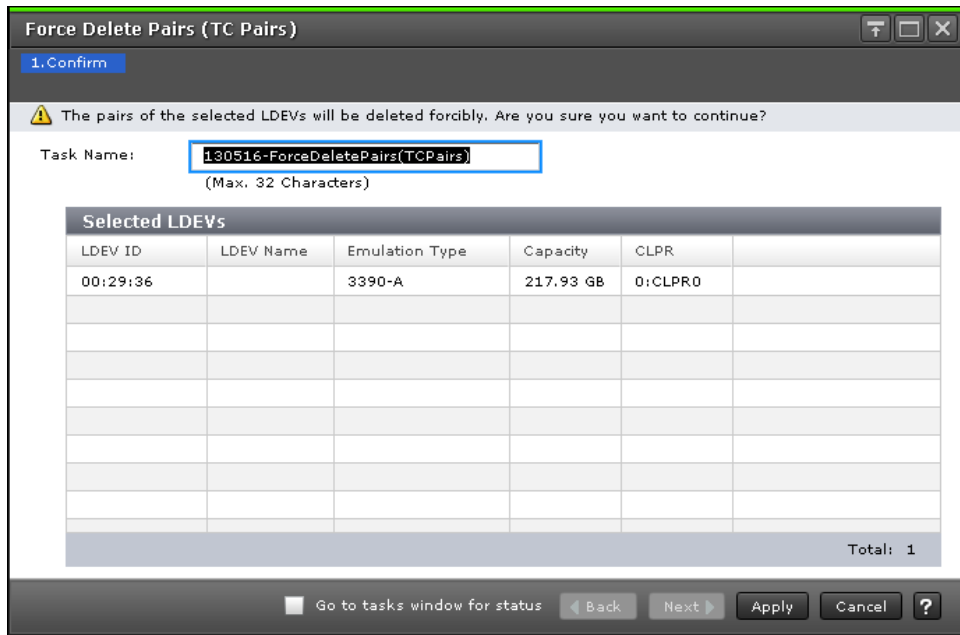

**Selected LDEVs table**

Item	Description
LDEV ID	LDEV identifier.
LDEV Name	LDEV name.
Emulation Type	Emulation type.
Capacity	Capacity.
CLPR	CLPR ID.

## Edit Pair Options wizard

Use this wizard to change pair options.

## Edit Pair Options window

Use this window to change pair options.

For complete information and instructions, see [Changing P-VOL fence level and CFW data \(on page 142\)](#).

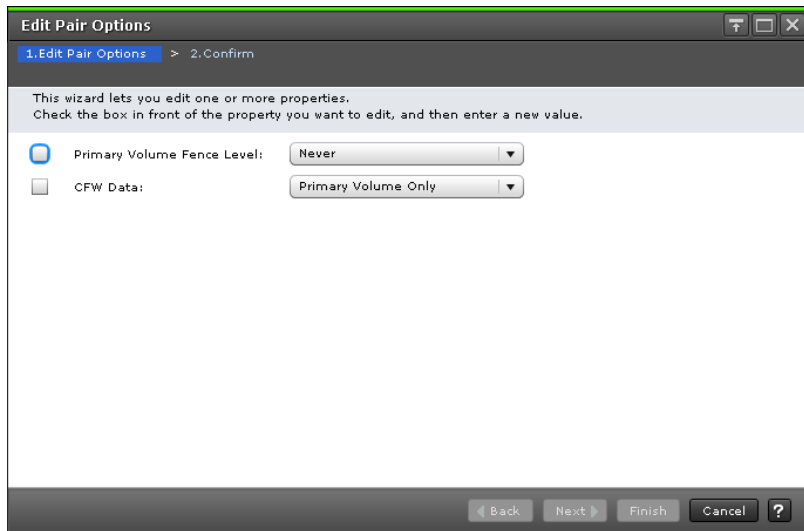

Item	Description
<p>Primary Volume Fence Level</p>	<p>Whether the P-VOL can be written to when the pair is split due to error.</p> <ul style="list-style-type: none"> <li>▪ Data: The P-VOL cannot be written to.</li> <li>▪ Status: The P-VOL can be written to only if the primary system can change the S-VOL status to PSUE (TrueCopy) or Suspend (TrueCopy for Mainframe). If the primary system cannot change the S-VOL status, the P-VOL cannot be written to.</li> <li>▪ Never: The P-VOL can be written to.</li> </ul> <p>The value set for the selected pair is the default.</p>
<p>CFW Data</p>	<p>TCz only.</p> <p>Whether CFW (DASD fast write) data is copied to the S-VOL.</p> <ul style="list-style-type: none"> <li>▪ Primary Volume Only: Data not copied (default).</li> <li>▪ Secondary Volume Copy: Data is copied.</li> </ul> <p>The value set for the selected pair is the default.</p> <p><b>Note:</b></p> <ul style="list-style-type: none"> <li>▪ To apply the pair option that is set on the P-VOL to the S-VOL, split and then resynchronize the TCz pair.</li> <li>▪ Do not specify Primary Volume Only if system option mode (SOM) 1091 is ON. If you do, I/O to the S-VOL might terminate abnormally.</li> <li>▪ Do not set SOM 1091 to ON if you changed the CFW data setting after you created the TCz pair. If you do, I/O to the S-VOL might terminate abnormally.</li> </ul>

## Edit Pair Options confirmation window

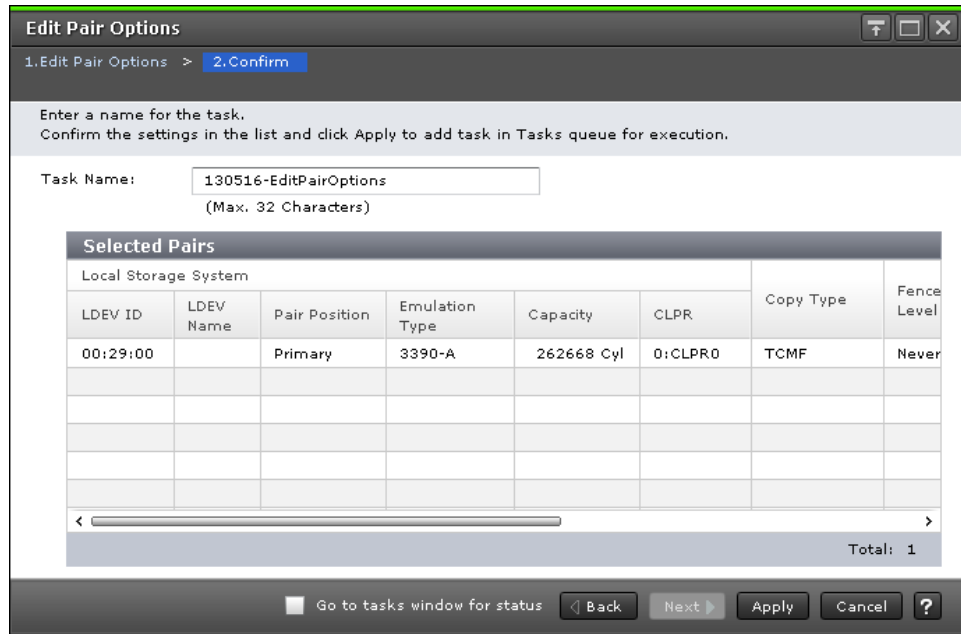

### Selected Pairs table

Item	Description
Local Storage System	Information about volumes in the accessed system. <ul style="list-style-type: none"> <li>▪ LDEV ID: LDEV identifier.</li> <li>▪ LDEV Name: LDEV name.</li> <li>▪ Pair Position: Whether volume is a P-VOL or S-VOL.</li> <li>▪ Emulation Type: Emulation type of the volume.</li> <li>▪ Capacity: Capacity of the volume.</li> <li>▪ CLPR: CLPR ID of the volume.</li> </ul>
Copy Type	Type of pair: <ul style="list-style-type: none"> <li>▪ TC: TrueCopy</li> <li>▪ TCMF: TrueCopy for Mainframe</li> </ul>
Fence Level	P-VOL fence level.
CFW Data	TCz only. Whether CFW data is copied to the S-VOL.



Item	Description
Remote Storage System	Information about the remote system. <ul style="list-style-type: none"> <li>Model / Serial Number: Model and serial number.</li> <li>SSID: SSID number. TCz only.</li> <li>LDEV ID: LDEV identifier.</li> </ul>
Path Group ID	TC only. Path group identifier.
Preserve Mirror Status	TCz only. <ul style="list-style-type: none"> <li>Blank: Indicates that it is a Preserve Mirror status without any problem or it is not a Preserve Mirror pair.</li> <li>Withdrawn: Indicates that pair volume data does not match due to suspending copy of Compatible FlashCopy® V2.</li> </ul>

## View Pair Properties (Remote) window

Use this window to view the data related to pairs and their volumes.

For complete information and instructions, see [Monitoring pair status and license capacity \(on page 131\)](#).

The screenshot displays the 'View Pair Properties' window. At the top, a diagram shows a 'Local Storage System' (VSP S100 / 1, 0:CLPR0) connected to a 'Remote Storage System' (VSP 5000 series / 00001\_0000) via a 'Remote Path' (DUPLX / DUPLX(02)). The main area contains a 'Pair Detail' table with the following data:

Pair Detail		DUPLX / DUPLX(02)
Status		DUPLX / DUPLX(02)
Power-on State		
Update Type		Sync
CTG ID		-
CTG Utilization		-
Preserve Mirror Status		-
Fence Level		Never
Host I/O Time Stamp Transfer		Disabled
Secondary Volume Write		Disabled
Copy Pace		15 Tracks
Initial Copy Priority		32
Paired Time		2019/01/18 22:17:09
Last Update Time		2019/01/18 22:17:09
Pair Copy Time		00:00:06
CFW Data		Primary Volume Only
DFW to Secondary Volume		Not Required
Local Storage System	Virtual Storage Machine	VSP 5000 series hybrid / 00001
	Virtual LDEV ID	00:31:00
	Virtual Device Name	
	Virtual SSID	
Remote Storage System	Virtual Storage Machine	VSP 5000 series / 00001
	Virtual LDEV ID	00:32:00

In this topic, you can view the following tables.

- [Pair Properties \(on page 314\)](#)
- [Pair Detail \(on page 315\)](#)

## Pair Properties

Item	Description
Local Storage System	<p>Displays the following information about the local system:</p> <ul style="list-style-type: none"> <li>▪ LDEV ID (LDEV name): P-VOL's LDEV identifier and name, which is displayed when you hover the cursor over it.</li> <li>▪ Number of Paths: Number of data paths between primary and secondary systems.</li> <li>▪ Provisioning Type, Encrypted: Provisioning type and encryption status of the volume in the local storage system.</li> </ul> <p>Encryption status is displayed only when the encryption status is Enabled or Mixed. If ... is displayed, place the cursor over ... to open the hidden contents as a tooltip.</p> <ul style="list-style-type: none"> <li>▪ Emulation Type, Capacity: Emulation type and capacity of the local system.</li> <li>▪ Model/Serial number, CLPR ID : CLPR name: Model, serial number, CLPR ID, and CLPR name of the local system.</li> </ul>
Copy Type, Status	Copy type and pair status of the pair.
Path Group	<p>Path group of the pair.</p> <p>If the P-VOL is in the primary storage system you can click one of the following to display the remote path list.</p> <ul style="list-style-type: none"> <li>▪ Path group ID (TC)</li> <li>▪ Remote Paths (TCz). Displayed only when the P-VOL is located at the local storage system.</li> </ul>
Remote Storage System	<p>Displays the following information about the remote system:</p> <ul style="list-style-type: none"> <li>▪ LDEV ID: S-VOL's LDEV identifier and name, which is displayed when you hover the cursor over it.</li> <li>▪ Port ID/Host Group ID or iSCSI Target ID/LUN ID: Port, host group or iSCSI target, and LUN identifiers. Information is useful when specifying an LDEV ID at pair creation. It does not change, even if path settings are changed. (TC only).</li> <li>▪ Emulation type: Remote system's volume emulation type.</li> <li>▪ Model/Serial number: Remote system's model, serial number.</li> </ul> <p>For CU-by-CU connection, SSID is also displayed.</p>

## Pair Detail

Item	Description
Status	Pair's status
Processing Status	<p>The processing status for a pair volume is displayed.</p> <ul style="list-style-type: none"> <li>▪ Expanding: The capacity of a TC pair volume is being expanded.</li> </ul> <p>If the volume capacity is not being expanded, or if V-VOLs other than DP-VOLs are used as pair volumes, this field remains blank.</p>
Update Type	<p>One of the following:</p> <ul style="list-style-type: none"> <li>▪ Sync: It is a TC or TCz pair which is not assigned to consistency group.</li> <li>▪ Sync (Specified CTG): It is a TC or TCz pair created by specifying consistency group.</li> </ul>
CTG ID	Consistency group identifier
CTG Utilization	<p>Whether the consistency group is shared by multiple storage systems.</p> <ul style="list-style-type: none"> <li>▪ Single: The consistency group consists of a single pair of primary and secondary storage systems.</li> <li>▪ Multi: The consistency group consists of multiple storage systems.</li> </ul>
Preserve Mirror Status	Preserve Mirror Status. A hyphen (-) is displayed for TC.
Fence Level	<p>Whether the P-VOL can be written to when the pair is split due to error.</p> <ul style="list-style-type: none"> <li>▪ Data: The P-VOL cannot be written to.</li> <li>▪ Status: The P-VOL cannot be written to only if the primary system cannot change the S-VOL status to PSUE (TC) or Suspend (TCz). If the primary system cannot change the S-VOL status, the P-VOL cannot be written to.</li> <li>▪ Never: The P-VOL can be written to.</li> </ul>
Host I/O Time Stamp Transfer	<p>TCz only.</p> <p>Specified time stamp transfer value.</p>
Secondary Volume Write	<p>Whether data can be written (Enabled) or not written (Disabled) to the S-VOL. The pair must be split for Enabled to display.</p> <p>If the volume accessed is an S-VOL and can be written to, Enabled/Received or Enabled/Not Received is displayed. Indicates whether a write operation is received from the host or not.</p>
Copy Pace	Speed that data is copied.

Item	Description
Initial Copy Priority	Scheduling order for the initial copy operation. The default is 32. The range is 1 to 256 for TC. The range is 0 to 256 for TCz.
Paired Time	Date and time pair-creation was completed.
Last Update Time	Date and time that the last update was run.
Pair Copy Time	Elapsed time for paircreate or pairresync operation.
CFW Data	Whether CFW data is copied to the S-VOL as specified during pair creation. A hyphen (-) is displayed for TC pairs.
DFW to Secondary Volume	Whether the primary system splits the TCz pair when the secondary system cannot copy DFW data to the S-VOL. A hyphen (-) is displayed for TC pairs.
Local Storage System	<ul style="list-style-type: none"> <li>▪ Virtual storage machine: Virtual storage machine's model type and serial number.</li> <li>▪ Virtual LDEV ID: Virtual LDEV identifier of the volume.</li> <li>▪ Virtual Device Name: Virtual device name of the volume, in the format: virtual emulation type/number of virtual LUSE volumes/virtual CVS attribute. <ul style="list-style-type: none"> <li>• Only attributes that are specified are displayed.</li> <li>• If the virtual CVS attribute is specified, "CVS" is displayed at the end of the device name.</li> <li>• A blank indicates no values are specified.</li> </ul> </li> <li>▪ Virtual SSID: Virtual SSID of the volume. A blank indicates that no virtual SSID is specified.</li> </ul>
Remote Storage System	<ul style="list-style-type: none"> <li>▪ Virtual storage machine: Virtual storage machine's model type and serial number.</li> <li>▪ Virtual LDEV ID: Virtual LDEV identifier of the volume.</li> </ul>

## View Pair Synchronization Rate window

Use this window to view the percentage of synchronized data between P-VOL and S-VOL.

For complete information and instructions, see [Monitoring TCz pair synchronization rate \(on page 139\)](#).

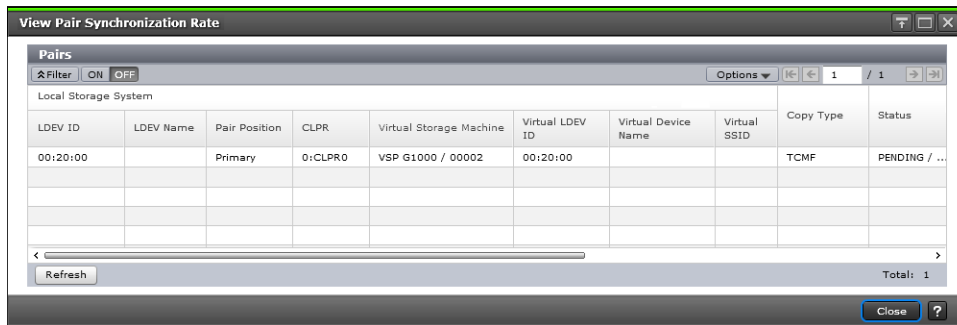

### Pairs table

Item	Description
Local Storage System	<p>Information about volumes in the local storage system.</p> <ul style="list-style-type: none"> <li>▪ LDEV ID: LDEV identifier. Clicking the link opens the <b>LDEV Properties</b> window.</li> <li>▪ LDEV Name: LDEV name.</li> <li>▪ Pair Position: Whether the volume is a primary or secondary volume.</li> <li>▪ CLPR: CLPR ID of the volume.</li> <li>▪ Virtual storage machine: Virtual storage machine's model type and serial number.</li> <li>▪ Virtual LDEV ID: Virtual LDEV identifier of the volume.</li> <li>▪ Virtual Device Name: Virtual device name of the volume, in the format: virtual emulation type/number of virtual LUSE volumes/virtual CVS attribute. <ul style="list-style-type: none"> <li>• Only attributes that are specified are displayed.</li> <li>• If the virtual CVS attribute is specified, "CVS" is displayed at the end of the device name.</li> <li>• A blank indicates no values are specified.</li> </ul> </li> <li>▪ Virtual SSID: Virtual SSID of the volume. A blank indicates that no virtual SSID is specified.</li> </ul>
Copy Type	<p>TC Pairs tab:</p> <ul style="list-style-type: none"> <li>▪ TC: TrueCopy</li> <li>▪ TCMF: TrueCopy for Mainframe</li> </ul>
Status	<p>Pair status.</p> <p>For status definitions, see <a href="#">Pair status definitions (on page 133)</a></p>

Item	Description
Synchronization Rate (%)	<p>Displays the synchronization rate between the P-VOL and S-VOL:</p> <ul style="list-style-type: none"> <li>▪ Initial copy progress rate is displayed during the initial copy process.</li> <li>▪ Data synchronization rate of the P-VOL and S-VOL is displayed during pair split.</li> <li>▪ "(Queuing)" is displayed if processing has not started.</li> </ul> <p>For a TC pair, when the local storage system volume is the P-VOL, the percentage is displayed regardless of the pair status. When the local storage system volume is the S-VOL, the percentage is displayed only if the pair status is other than COPY.</p> <p>For a TCz pair, when the local storage system volume is the P-VOL, the percentage is displayed regardless of the pair status. When the local storage system volume is the S-VOL, a hyphen (-) is displayed.</p>
Remote Storage System	<p>Information about volumes in the system connected to the system you accessed.</p> <ul style="list-style-type: none"> <li>▪ Model / Serial Number: Remote system's model and serial number.</li> <li>▪ SSID: Remote system's SSID number. TCz only.</li> <li>▪ LDEV ID: LDEV identifier.</li> <li>▪ Virtual storage machine: Virtual storage machine's model type and serial number.</li> <li>▪ Virtual LDEV ID: Virtual LDEV identifier of the volume.</li> </ul>
Path Group ID	Path group identifier. TC only.
Refresh	Updates the information.

## Add SSIDs wizard

Use this wizard to add SSIDs to the remote system.

## Add SSIDs window

Use this window to add SSIDs to the remote system.

For complete information and instructions, see [Adding SSIDs on the secondary system \(on page 151\)](#).

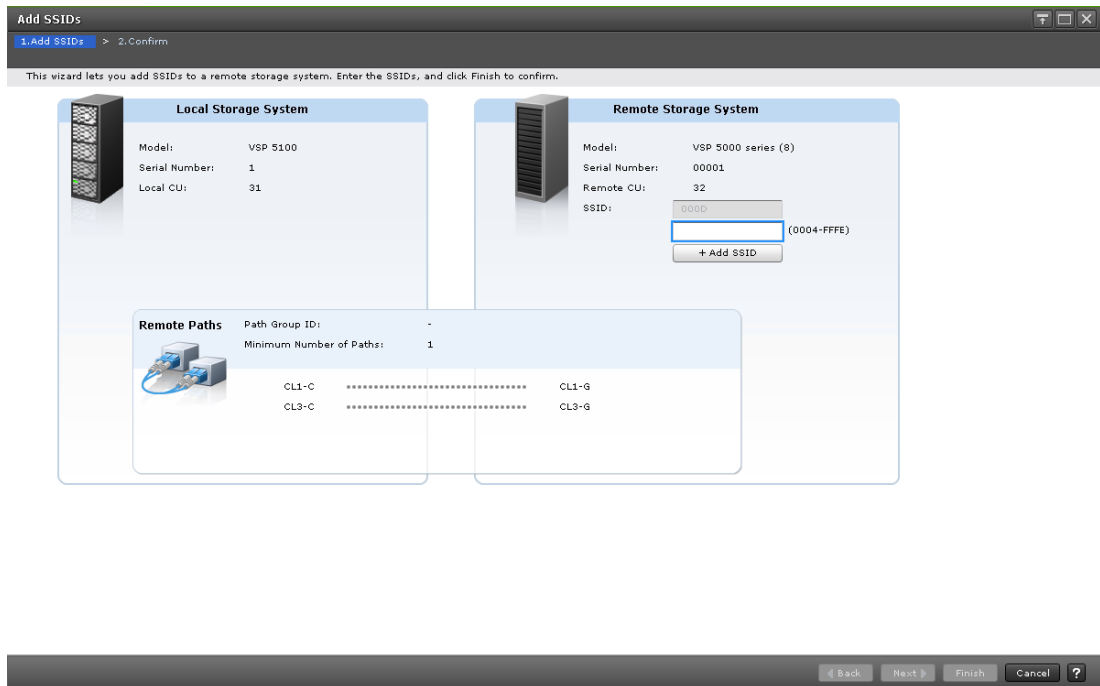

In this topic, you can view the following tables.

- [Local Storage System \(on page 319\)](#)
- [Remote Storage System \(on page 319\)](#)
- [Remote Paths \(on page 320\)](#)

### Local Storage System

Item	Description
Model	Local system model.
Serial Number	Local system serial number.
Local CU	Local system CU number.

### Remote Storage System

Item	Description
Model	Remote system model.
Serial Number	Remote system serial number.
Remote CU	Remote system CU number.

Item	Description
SSID	Remote system SSID. Range is 0004 to FEFF. Clicking the - (remove) button removes the SSID text box (present when two or more valid SSIDs).
Add SSIDs	Clicking adds the SSID to the remote system. The maximum is four.

### Remote Paths

Item	Description
Path Group ID	Path group identifier. A hyphen is always displayed.
Minimum Number of Paths	Specified minimum number of remote paths.
Port lists	<ul style="list-style-type: none"> <li>▪ Left side list: local system port identifier.</li> <li>▪ Right side list: remote system port identifier</li> </ul>

## Add SSIDs confirmation window

Item	Description
Connection Type	CU: Indicates CU-to-CU connections.
Local CU	Local system CU number.



Item	Description
Remote Storage System	Information about the remote system. <ul style="list-style-type: none"> <li>Model / Serial Number: Model and serial number.</li> <li>CU: CU number.</li> <li>SSID: SSID number.</li> </ul>
Path Group ID	Path group identifier.
Number of Remote Paths	Number of remote paths including those being added.
Minimum Number of Paths	Minimum number of remote paths. The range is from 1 to 8, and the default is 1.
SSID	The SSIDs to be added.

## Remove SSIDs wizard

Use this wizard to delete SSIDs.

## Remove SSIDs window

Use this window to delete SSIDs.

For complete information and instructions, see the procedure in [Adding SSIDs on the secondary system \(on page 151\)](#).

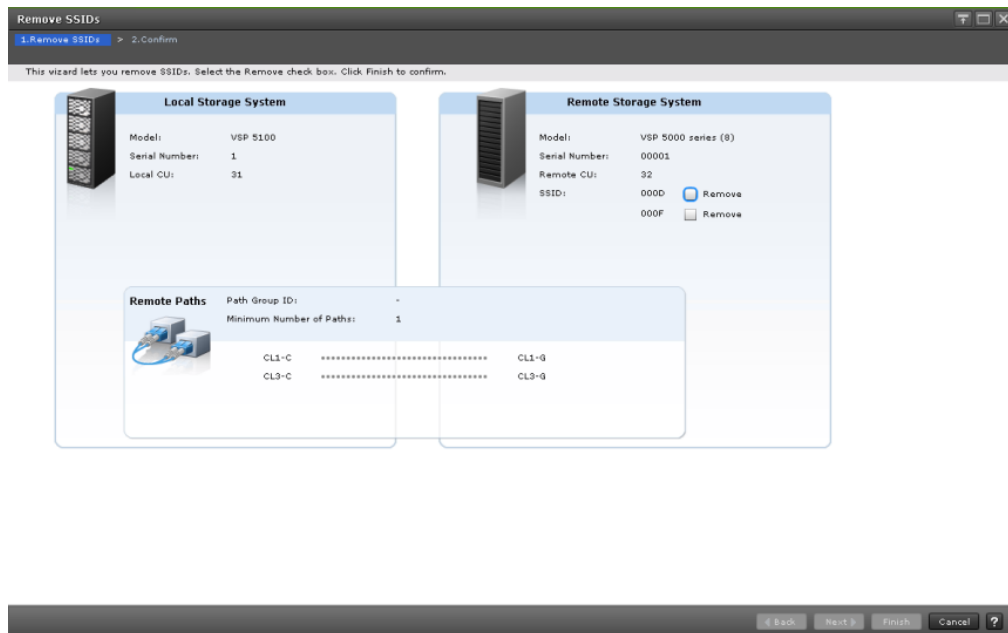

In this topic, you can view the following tables.

- [Local Storage System \(on page 322\)](#)
- [Remote Storage System \(on page 322\)](#)
- [Remote Paths \(on page 322\)](#)

### Local Storage System

Item	Description
Model	Local system model.
Serial Number	Local system serial number.
Local CU	Local system CU number.

### Remote Storage System

Item	Description
Model	Remote system model.
Serial Number	Remote system serial number.
Remote CU	Remote system CU number.
SSID	Remote system SSID.
Delete	Check box for deleting the SSID from the remote system.

### Remote Paths

Item	Description
Path Group ID	Path group identifier. A hyphen is always displayed.
Minimum Number of Paths	Specified minimum number of remote paths.
Port lists	<ul style="list-style-type: none"> <li>▪ List on the left: local system port identifier</li> <li>▪ List on the right: remote system port identifier</li> </ul>

## Remove SSIDs confirmation window

**Remove SSIDs**

1. Remove SSIDs > 2. Confirm

**⚠** This wizard lets you confirm the selected SSIDs you want to delete. Are you sure you want to continue?

Task Name:  (Max. 32 Characters)

Connection Type	Local CU	Remote Storage System			Path Group ID	Number of Remote Paths	Minimum Number of Paths
		Model / Serial Number	CU	SSID			
CU	01	VSP G1000 / 00176	01	0009	-	1	1

Selected SSIDs	
SSID	0008

Total: 1

Go to tasks window for status | Back | Next | Apply | Cancel | ?

Item	Description
Connection Type	<ul style="list-style-type: none"> <li>System: system-to-system connection.</li> <li>CU: CU-to-CU connections.</li> </ul>
Local CU	Local system CU number.
Remote Storage System	Information about the remote system. <ul style="list-style-type: none"> <li>Model / Serial Number: Model and serial number.</li> <li>CU: CU number.</li> <li>SSID: SSID number. TCz only.</li> </ul>
Path Group ID	Path group identifier.
Number of Remote Paths	Number of remote paths including those being added.
Minimum Number of Paths	Minimum number of remote paths. The range is from 1 to 8, and the default is 1.
SSID	SSID to be deleted.

## History window

Use this window to review the operations that have been performed on a pair.

History

Copy Type: **TCMF**

Last Updated: 2014/10/29 15:15:54

TCMF History (Page.1)

Filter ON OFF

Date and Time	Local Storage System		Remote Storage System		Description
	LDEV ID	Provisioning Type	LDEV ID	Provisioning Type	
2013/06/18 18:44:37	00:01:C6	Basic	00:03:25	Basic	Pair Delete
2013/06/18 18:44:37	00:01:E8	Basic	00:03:47	Basic	Pair Delete
2013/06/18 18:44:36	00:01:B3	Basic	00:03:12	Basic	Pair Delete
2013/06/18 18:44:36	00:01:EA	Basic	00:03:49	Basic	Pair Delete
2013/06/18 18:44:36	00:01:B9	Basic	00:03:18	Basic	Pair Delete
2013/06/18 18:44:36	00:01:B1	Basic	00:03:10	Basic	Pair Delete
2013/06/18 18:44:36	00:01:FA	Basic	00:03:59	Basic	Pair Delete
2013/06/18 18:44:36	00:01:FF	Basic	00:03:5E	Basic	Pair Delete
2013/06/18 18:44:36	00:01:F3	Basic	00:03:52	Basic	Pair Delete
2013/06/18 18:44:36	00:01:DC	Basic	00:03:3B	Basic	Pair Delete

Export Total: 10

Close ?

In this topic, you can view the following tables.

- [Settings \(on page 324\)](#)
- [History table \(when Copy Type is TC or TCMF\) \(on page 325\)](#)

## Settings

Item	Description
Copy Type	Type of pair: <ul style="list-style-type: none"> <li>▪ TC: TrueCopy</li> <li>▪ UR: Universal Replicator</li> <li>▪ TCMF: TrueCopy for Mainframe</li> <li>▪ URMF: Universal Replicator for Mainframe</li> <li>▪ GAD: global-active device</li> </ul>
Last Updated	Date and time of the last update. Displayed after Copy Type is specified.
Page Number	Page number. Click the button, turn over the page. Displayed after Copy Type is specified.

**History table (when Copy Type is TC or TCMF)**

Item	Description
Date and Time	Date and time of the operation.
Local Storage System	Information about volumes in the accessed system. <ul style="list-style-type: none"> <li>▪ LDEV ID: LDEV identifier.</li> <li>▪ Provisioning Type: Provisioning type of the volume.</li> <li>▪ Pair Position: Whether the volume is a primary or secondary volume. GAD only.</li> <li>▪ Journal ID: Journal's identifier. UR or URz only.</li> <li>▪ Mirror ID: Mirror's identifier. UR or URz only.</li> </ul>
Remote Storage System	Information about volumes in the system connected to the system you accessed. <ul style="list-style-type: none"> <li>▪ LDEV ID: LDEV identifier.</li> <li>▪ Model / Serial Number: Remote storage system's model and serial number. GAD only.</li> <li>▪ Provisioning Type: Provisioning type of the volume.</li> </ul>
EXCTG ID	EXCTG identifier. URz only.
Mirror ID	Mirror identifier. GAD only.
Quorum Disk ID	Quorum disk identifier. GAD only.
CTG ID	Consistency group identifier. GAD only.
Virtual Storage Machine	Information about volumes in the virtual storage machine. GAD only. <ul style="list-style-type: none"> <li>▪ Model / Serial Number: Virtual storage system's model and serial number.</li> <li>▪ LDEV ID: LDEV identifier of the volume.</li> </ul>
Description Code	Description code. GAD only.
Description	Describes the operation.
Copy Time	Elapsed time for create or resync pairs operation. When the Description is other than Pair Add Complete or Pair Resync Complete, a hyphen is displayed.
Started	Start time of create or resync pairs operation. When the Description is other than Pair Add Complete or Pair Resync Complete, a hyphen is displayed.
Export	Opens the window for exporting table information.

## Edit Ports window

### Fibre Channel

### For Fibre Channel ports

Item	Description
Port Attribute	Port I/O flow: <ul style="list-style-type: none"> <li>▪ Target: Receives I/O commands from a host</li> <li>▪ Bidirectional</li> </ul>
Port Security	LUN security (Enabled or Disabled)
Port Speed	Transfer speed, in Gbps, for the selected Fibre Channel port. If Auto is selected, the storage system automatically sets the data transfer speed to 4, 8, 16, or 32 Gbps. <b>Caution:</b> These cautions must be observed when setting speed on a Fibre Channel port: <ul style="list-style-type: none"> <li>▪ If a port supports 4, 8, 16 or 32 Gbps, use 4, 8, 16 or 32 Gbps for the port speed, respectively.</li> <li>▪ If the Auto Negotiation setting is required, some links might not be up when the server is restarted. Check the channel lamp. If it is flashing, disconnect the cable, and then reconnect it to recover from the link-down state.</li> <li>▪ If the port speed is set to Auto, some equipment might not be able to transfer data at the maximum speed.</li> </ul>

Item	Description
	<ul style="list-style-type: none"> <li>▪ When you start a storage system, HBA, or switch, check the host speed displayed in the Port list. If the transfer speed is different from the maximum speed, select the maximum speed from the list on the right, or disconnect, and then reconnect the cable.</li> <li>▪ The available port speed that is specified in Port Speed is limited due to the combination of the type of the Fibre Channel port and the topology that is specified in Connection Type.</li> <li>▪ If the transfer speed of the CHB (FC) port is set to Auto, the data might not be transferred at the maximum speed depending on the connected device. Confirm the transfer speed displayed in Speed in the Ports list when you start up the storage system, HBA, or switch. When the transfer speed is not the maximum speed, select the maximum speed from the list on the right or remove and reinsert the cable.</li> </ul>
Address (Loop ID)	Address of the selected port
Fabric	Whether a fabric switch is on or off
Connection Type	<p>Topology:</p> <ul style="list-style-type: none"> <li>▪ FC-AL: Fibre Channel arbitrated loop</li> <li>▪ P-to-P: Point-to-point</li> </ul> <p><b>Caution:</b> Some fabric switches require that you specify point-to-point topology. If you enable a fabric switch, check the documentation for the fabric switch to determine whether your switch requires point-to-point topology.</p>

## iSCSI

**Edit Ports**

1. Edit Ports > 2. Confirm

This wizard lets you edit one or more properties. Check the box in front of the property you want to edit, and then enter the new value.

**IPv4 Settings**

IP Address: 192.168.0.17

Subnet Mask: 255.255.255.0

Default Gateway: 0.0.0.0

IPv6 Mode:  Enable  Disable

**IPv6 Settings**

Link Local Address:  Auto  Manual  
FE80:0000:0000:0000: \_\_\_\_\_

Global Address:  Auto  Manual  
 Global Address: \_\_\_\_\_

Global Address 2: \_\_\_\_\_

Default Gateway: \_\_\_\_\_

Port Attribute: Target

Port Security:  Enable  Disable

Port Speed: 10 Gbps

TCP Port Number: 3260  
(1-65535)

Selective ACK:  Enable  Disable

Delayed ACK:  Enable  Disable

Maximum Window Size: 64KB

Ethernet MTU Size: 1500Bytes

Keep Alive Timer: 60 Seconds

Back Next Finish Cancel ?

## For iSCSI ports

Item	Description
IPv4 Settings	<ul style="list-style-type: none"> <li>IP Address: IP address of the port.</li> <li>Subnet Mask: Subnet mask of the port.</li> <li>Default Gateway: Default gateway of the port.</li> </ul> <p>If the iSCSI virtual port mode is enabled for the port, this item is not available.</p>
IPv6 Mode	<ul style="list-style-type: none"> <li>Enable: IPv6 mode is enabled. If Enable is selected, the IPv6 Settings can be specified.</li> <li>Disable: IPv6 mode is disabled.</li> </ul>



Item	Description
	If the iSCSI virtual port mode is enabled for the port, this item is not available.
IPv6 Settings	<ul style="list-style-type: none"> <li>▪ Link Local Address: Link local address for the port: <ul style="list-style-type: none"> <li>• Auto: Link local address is set automatically.</li> <li>• Manual: Link local address is set manually.</li> </ul> </li> <li>▪ Global Address: Global address for the port: <ul style="list-style-type: none"> <li>• Global Address: If Manual is selected, the global address must be entered.</li> <li>• Global Address 2: If Manual is selected, the global address 2 must be entered.</li> </ul> </li> <li>▪ Default Gateway: Default gateway address for the port.</li> </ul> <p>If the iSCSI virtual port mode is enabled for the port, this item is not available.</p>
Port Attribute	<p>Port I/O flow:</p> <ul style="list-style-type: none"> <li>▪ Target: Receives I/O command from a host</li> <li>▪ Bidirectional</li> </ul>
Port Security	<ul style="list-style-type: none"> <li>▪ Enable: LUN security is used on the port.</li> <li>▪ Disable: LUN security is not used on the port.</li> </ul>
Port Speed	The data transfer speed is fixed to 10 Gbps.
TCP Port Number	TCP port number. If the iSCSI virtual port mode is enabled for the port, this item is not available.
Selective ACK	<ul style="list-style-type: none"> <li>▪ Enable: Selective ACK is enabled.</li> <li>▪ Disable: Selective ACK is disabled.</li> </ul> <p>If the iSCSI virtual port mode is enabled for the port, this item is not available.</p>
Delayed ACK	<ul style="list-style-type: none"> <li>▪ Enable: Delayed ACK is enabled.</li> <li>▪ Disable: Delayed ACK is disabled.</li> </ul> <p>If the iSCSI virtual port mode is enabled for the port, this item is not available.</p>
Maximum Window Size	Maximum window size from 64 KB, 128 KB, 256 KB, 512 KB, or 1024 KB. If the iSCSI virtual port mode is enabled for the port, this item is not available.

Item	Description
Ethernet MTU Size	Ethernet MTU size from 1500 bytes, 4500 bytes, or 9000 bytes. If the iSCSI virtual port mode is enabled for the port, this item is not available.
Keep Alive Timer	Interval time to perform the keep alive timer option. If the iSCSI virtual port mode is enabled for the port, this item is not available.
VLAN Tagging Mode	<ul style="list-style-type: none"> <li>▪ Enable: VLAN tagging mode is enabled. VLAN ID must be entered.</li> <li>▪ Disable: VLAN tagging mode is disabled.</li> </ul> If the iSCSI virtual port mode is enabled for the port, this item is not available.
iSNS Server	<ul style="list-style-type: none"> <li>▪ Enable: iSNS server mode is enabled. The IP address and TCP port number must also be specified.</li> <li>▪ Disable: iSNS server mode is disabled.</li> </ul> If the iSCSI virtual port mode is enabled for the port, this item is not available.
IP Address	IP address for IPv4 or IPv6. If the iSCSI virtual port mode is enabled for the port, this item is not available.
TCP Port Number	TCP port number. If the iSCSI virtual port mode is enabled for the port, this item is not available.
CHAP User Name	CHAP user name
Secret	Secret to be used for host authentication
Re-enter Secret	Secret must be re-entered for confirmation

## Complete SIMs (TC) window

Complete SIMs (TC)

1.Confirm

⚠ Completing the SIM will remove the SIM entry from the system. Are you sure to continue?

Task Name:   
(Max. 32 Characters)

Go to tasks window for status    < Back    Next >    Apply    Cancel    ?

Item	Description
Task Name	Displays the default name of the task (date in the format <i>yymmdd</i> and description) and allows you to enter a different task name (maximum 32 characters).
Go to tasks window for status	When selected, the <b>Tasks</b> window opens automatically after you click Apply.

**Hitachi Vantara**



Corporate Headquarters  
2535 Augustine Drive  
Santa Clara, CA 95054 USA  
[HitachiVantara.com](http://HitachiVantara.com) | [community.HitachiVantara.com](http://community.HitachiVantara.com)

Contact Information  
USA: 1-800-446-0744  
Global: 1-858-547-4526  
[HitachiVantara.com/contact](http://HitachiVantara.com/contact)