



# Hitachi Virtual Storage Platform G400, G600

## Hardware Reference Guide

© 2015, 2017 Hitachi, Ltd. All rights reserved.

No part of this publication may be reproduced or transmitted in any form or by any means, electronic or mechanical, including copying and recording, or stored in a database or retrieval system for commercial purposes without the express written permission of Hitachi, Ltd., or Hitachi Data Systems Corporation (collectively "Hitachi"). Licensee may make copies of the Materials provided that any such copy is: (i) created as an essential step in utilization of the Software as licensed and is used in no other manner; or (ii) used for archival purposes. Licensee may not make any other copies of the Materials. "Materials" mean text, data, photographs, graphics, audio, video and documents.

Hitachi reserves the right to make changes to this Material at any time without notice and assumes no responsibility for its use. The Materials contain the most current information available at the time of publication.

Some of the features described in the Materials might not be currently available. Refer to the most recent product announcement for information about feature and product availability, or contact Hitachi Data Systems Corporation at [https://support.hds.com/en\\_us/contact-us.html](https://support.hds.com/en_us/contact-us.html).

**Notice:** Hitachi products and services can be ordered only under the terms and conditions of the applicable Hitachi agreements. The use of Hitachi products is governed by the terms of your agreements with Hitachi Data Systems Corporation.

By using this software, you agree that you are responsible for:

1. Acquiring the relevant consents as may be required under local privacy laws or otherwise from authorized employees and other individuals to access relevant data; and
2. Verifying that data continues to be held, retrieved, deleted, or otherwise processed in accordance with relevant laws.

**Notice on Export Controls.** The technical data and technology inherent in this Document may be subject to U.S. export control laws, including the U.S. Export Administration Act and its associated regulations, and may be subject to export or import regulations in other countries. Reader agrees to comply strictly with all such regulations and acknowledges that Reader has the responsibility to obtain licenses to export, re-export, or import the Document and any Compliant Products.

Hitachi is a registered trademark of Hitachi, Ltd., in the United States and other countries.

AIX, AS/400e, DB2, Domino, DS6000, DS8000, Enterprise Storage Server, eServer, FICON, FlashCopy, IBM, Lotus, MVS, OS/390, PowerPC, RS/6000, S/390, System z9, System z10, Tivoli, z/OS, z9, z10, z13, z/VM, and z/VSE are registered trademarks or trademarks of International Business Machines Corporation.

Active Directory, ActiveX, Bing, Excel, Hyper-V, Internet Explorer, the Internet Explorer logo, Microsoft, the Microsoft Corporate Logo, MS-DOS, Outlook, PowerPoint, SharePoint, Silverlight, SmartScreen, SQL Server, Visual Basic, Visual C++, Visual Studio, Windows, the Windows logo, Windows Azure, Windows PowerShell, Windows Server, the Windows start button, and Windows Vista are registered trademarks or trademarks of Microsoft Corporation. Microsoft product screen shots are reprinted with permission from Microsoft Corporation.

iPad is a trademark of Apple Inc., registered in the U.S. and other countries.

All other trademarks, service marks, and company names in this document or website are properties of their respective owners.



# Contents

Preface.....	7
Intended audience.....	8
Safety and environmental notices.....	8
Product version.....	9
Release notes.....	10
Changes in this revision.....	10
Document conventions.....	10
Conventions for storage capacity values.....	11
Accessing product documentation.....	12
Getting help.....	12
Comments.....	12
<b>1 Hitachi Virtual Storage Platform G400, G600 hardware overview.....</b>	<b>13</b>
Block configuration.....	15
Unified configuration.....	15
VSP G400 model.....	15
VSP G600 model.....	17
Features.....	18
Scalability.....	19
Examples of supported VSP G400 configurations.....	19
Examples of supported VSP G600 configurations.....	19
Maximum number of mounted drive trays.....	20
<b>2 Virtual Storage Platform G400, G600 controller.....</b>	<b>23</b>
CBLM controller.....	24
CBLM with front panel bezel.....	24
CBLM front panel LEDs (without bezel).....	25
CBLM rear panel.....	26
CBLM power supply unit LEDs and connectors.....	28
Host, Network, and Drive Tray Ports and LEDs.....	28
Front end module descriptions.....	28
10-Gbps iSCSI board LEDs and connectors (optical).....	29

10-Gbps iSCSI board LEDs and connectors (copper).....	29
8-Gbps, 16-Gbps, or 32-Gbps Fibre Channel (4-port) board LEDs and connectors .....	30
16-Gbps Fibre Channel (2-port) board LEDs and connectors.....	32
LAN blade LEDs and connectors.....	33
Back end module LEDs and connectors.....	34
<b>3 Storage system drive trays.....</b>	<b>37</b>
Small form-factor (SFF) drive tray.....	38
SFF with front panel bezel.....	38
SFF front panel without bezel.....	38
SFF rear panel.....	39
Large form-factor (LFF) drive tray.....	40
LFF with front panel bezel.....	40
LFF front panel without bezel.....	41
LFF rear panel.....	42
Flash module drive (FMD) tray.....	43
FMD with front panel bezel.....	43
FMD front panel without bezel.....	44
FMD rear panel.....	45
Dense intermix drive tray.....	46
Dense intermix drive tray with front panel bezel.....	46
Dense intermix drive tray display LEDs.....	47
Dense intermix drive tray rear panel.....	48
SFF and LFF AC power supply unit LEDs and connectors.....	49
<b>4 Host port expansion chassis.....</b>	<b>51</b>
Host port expansion chassis front panel bezel LEDs.....	52
PCIe switchboard.....	52
Host port expansion chassis fan.....	53
PCIe cable connector.....	53
Host port expansion chassis power supply.....	55
<b>5 NAS module.....</b>	<b>57</b>
NAS Module Ports and LEDs.....	58
<b>6 VSP service processor server.....</b>	<b>59</b>
Service processor description.....	60
SVP front panel.....	60
SVP rear panel.....	61
Service processor hardware specifications.....	62
<b>7 Maintaining the storage system.....</b>	<b>63</b>
Storing the storage system.....	64
Powering off the storage system.....	64
Removing cables.....	64



<b>A</b>	<b>Mechanical specifications for VSP G400, G600 .....</b>	<b>67</b>
	VSP G400 and VSP G600 mechanical specifications.....	68
<b>B</b>	<b>Electrical specifications for VSP G400, G600.....</b>	<b>75</b>
	Electrical specifications.....	76
<b>C</b>	<b>Environmental specifications for VSP G400, G600.....</b>	<b>77</b>
	Environmental specifications.....	78
<b>D</b>	<b>iSCSI standards and specifications.....</b>	<b>83</b>
	iSCSI standards.....	84
	iSCSI specifications.....	84
<b>E</b>	<b>Replacement parts.....</b>	<b>87</b>
	Battery unit.....	88
<b>F</b>	<b>Data and power cables.....</b>	<b>89</b>
	Fibre Channel cables.....	90
	iSCSI cables.....	93
	Managing data cables.....	95
	AC power cables.....	97
	Power cable assemblies.....	97
	AC connections.....	99
	Power cable usage guidelines.....	100
	Three-phase power considerations for racks.....	100
	Cable management.....	101
	Cable retention.....	101
<b>G</b>	<b>Port address mapping.....</b>	<b>103</b>
	Port address mapping.....	104
<b>H</b>	<b>Third-party racks.....</b>	<b>105</b>
	Third-party rack support for VSP Gx00 models.....	106
	Hitachi Universal V2 Rack rail kits.....	106
	Hitachi Universal V2 Rack accessories.....	106
	Third-party rack support for DB60 dense intermix drive trays.....	107
<b>I</b>	<b>Hitachi Universal V2 Rack power distribution units.....</b>	<b>109</b>
	Americas single-phase PDU 1P30A-8C13-3C19UL.P.....	110
	Americas single-phase PDU 1P30A-15C13-3C19UL.P.....	110
	Americas three-phase PDU 3P30A-8C13-3C19UL.P.....	111
	Americas three-phase PDU 3P30A-15C13-3C19UL.P.....	111
	Americas three-phase PDU 3P30A-24C13-6C19UL.P.....	112
	APAC and EMEA single-phase PDU 1P32A-9C13-3C19CE.P.....	113
	APAC and EMEA single-phase PDU 1P32A-18C13-3C19CE.P.....	113

APAC and EMEA three-phase PDU 3P16A-9C13-3C19CE.P.....	114
APAC and EMEA three-phase PDU 3P16A-15C13-3C19CE.P.....	114
APAC and EMEA three-phase PDU 3P32A-24C13-6C19CE.P.....	115
J Regulatory compliance.....	117
Index.....	119



# Preface

This guide describes the hardware features and specifications of the VSP Gx00 models.

- [Intended audience](#)
- [Safety and environmental notices](#)
- [Product version](#)
- [Release notes](#)
- [Changes in this revision](#)
- [Document conventions](#)
- [Conventions for storage capacity values](#)
- [Accessing product documentation](#)
- [Getting help](#)
- [Comments](#)

## Intended audience

This document is intended for customers inquiring about the features and specifications of the VSP Gx00 models.

Readers of this document should be familiar with the following:

- Data processing and RAID storage systems and their basic functions.
- The operating system and web browser software on the system hosting the storage management software.

## Safety and environmental notices

### Equipment warranty

The term of guarantee of normal operation of the storage system and free service is one year from date of purchase.

If a failure occurs multiple times, the storage system might shut off to avoid a serious accident.

### Notice of export controls

Export of technical data contained in this document might require an export license from the United States government, the government of Japan, or both. Contact the Hitachi Legal Department for guidance about any export compliance questions.

### Backup

Hitachi cannot guarantee against data loss due to failures. Therefore, back up your data to minimize chances for data loss.

Data backup is also critical when hardware components are added or replaced, because performing such hardware procedures restores parameter settings that can affect how data is managed on the storage systems.

### Disposal



This symbol on the product or on its packaging means that your electrical and electronic equipment should be disposed at the end of life separately from your household wastes.

There are separate collection systems for recycling in the European Union. For more information, contact the local authority or the dealer where you purchased the product.

### Recycling

A nickel-metal hydride battery is used in the Cache Backup Battery.

A nickel-metal hydride battery is a resource that can be recycled. When you want to replace the Cache Backup Battery, call the service personnel. They will dispose of it for you. This nickel-metal hydride battery, which is designated as recycling product by a recycling promotion law, must be recycled.

The mark posted on the Cache Backup Battery is a three-arrow mark that indicates a recyclable part.



**Ni-MH**

#### **UEFI Development Kit 2010**

This product includes UEFI Development Kit 2010 written by the UEFI Open Source Community. For more information, see the UEFI Development Kit website:

<http://sourceforge.net/apps/mediawiki/tianocore/index.php?title=UDK2010>

© 2004, Intel Corporation.

All rights reserved.

Redistribution and use in source and binary forms, with or without modification, are permitted provided that the following conditions are met:

Redistributions of source code must retain the above copyright notice, this list of conditions and the following disclaimer.

Redistributions in binary form must reproduce the above copyright notice, this list of conditions and the following disclaimer in the documentation and/or other materials provided with the distribution.

Neither the name of the Intel Corporation nor the names of its contributors might be used to endorse or promote products derived from this software without specific prior written permission.

THIS SOFTWARE IS PROVIDED BY THE COPYRIGHT HOLDERS AND CONTRIBUTORS "AS IS" AND ANY EXPRESS OR IMPLIED WARRANTIES, INCLUDING, BUT NOT LIMITED TO, THE IMPLIED WARRANTIES OF MERCHANTABILITY AND FITNESS FOR A PARTICULAR PURPOSE ARE DISCLAIMED. IN NO EVENT SHALL THE COPYRIGHT OWNER OR CONTRIBUTORS BE LIABLE FOR ANY DIRECT, INDIRECT, INCIDENTAL, SPECIAL, EXEMPLARY, OR CONSEQUENTIAL DAMAGES (INCLUDING, BUT NOT LIMITED TO, PROCUREMENT OF SUBSTITUTE GOODS OR SERVICES; LOSS OF USE, DATA, OR PROFITS; OR BUSINESS INTERRUPTION) HOWEVER CAUSED AND ON ANY THEORY OF LIABILITY, WHETHER IN CONTRACT, STRICT LIABILITY, OR TORT (INCLUDING NEGLIGENCE OR OTHERWISE) ARISING IN ANY WAY OUT OF THE USE OF THIS SOFTWARE, EVEN IF ADVISED OF THE POSSIBILITY OF SUCH DAMAGE.

#### **FDA radiation regulation**

The array complies with FDA radiation performance standard 21 CFR subchapter J.

#### **EMI regulation**

This equipment has been tested and found to comply with the limits for a Class A digital device, pursuant to Part 15 of the FCC Rules. These limits are designed to provide reasonable protection against harmful interference when the equipment is operated in a commercial environment. This equipment generates, uses, and can radiate radio frequency energy and, if not installed and used in accordance with the instruction manual, may cause harmful interference in which case the user will be required to correct the interference at his own expense. Testing was done with shielded cables. Therefore, in order to comply with the FCC regulations, you must use shielded cables with your installation.

The electromagnetic interference (EMI) test was done in the following configuration.

This product must not be used in residential areas.

This is a class A product. In a domestic environment this product can cause radio interference in which case the user can be required to take adequate measures.

## **Product version**

This document revision applies to the following product versions:

- VSP G400, G600 firmware 83-04-4x or later
- Hitachi Storage Virtualization Operating System (SVOS) 7.2 or later
- Hitachi NAS firmware version 13.1 or later

## Release notes

Read the release notes before installing and using this product. They may contain requirements or restrictions that are not fully described in this document or updates or corrections to this document. Release notes are available on Hitachi Data Systems Support Connect: <https://knowledge.hds.com/Documents>.

## Changes in this revision

- Added new single- and three-phase power distribution units and specifications
- Added third-party rack information





## Document conventions

This document uses the following typographic conventions:

Convention	Description
<b>Bold</b>	<ul style="list-style-type: none"> <li>• Indicates text in a window, including window titles, menus, menu options, buttons, fields, and labels. Example: Click <b>OK</b>.</li> <li>• Indicates emphasized words in list items.</li> </ul>
<i>Italic</i>	<ul style="list-style-type: none"> <li>• Indicates a document title or emphasized words in text.</li> <li>• Indicates a variable, which is a placeholder for actual text provided by the user or for output by the system. Example: <code>pairdisplay -g group</code></li> </ul> <p>(For exceptions to this convention for variables, see the entry for angle brackets.)</p>
Monospace	Indicates text that is displayed on screen or entered by the user. Example: <code>pairdisplay -g oradb</code>
< > angle brackets	Indicates variables in the following scenarios: <ul style="list-style-type: none"> <li>• Variables are not clearly separated from the surrounding text or from other variables. Example: <code>Status-&lt;report-name&gt;&lt;file-version&gt;.csv</code></li> <li>• Variables in headings.</li> </ul>
[ ] square brackets	Indicates optional values. Example: [ a   b ] indicates that you can choose a, b, or nothing.

Convention	Description
{ } braces	Indicates required or expected values. Example: { a   b } indicates that you must choose either a or b.
vertical bar	Indicates that you have a choice between two or more options or arguments. Examples:  [ a   b ] indicates that you can choose a, b, or nothing.  { a   b } indicates that you must choose either a or b.

This document uses the following icons to draw attention to information:

Icon	Label	Description
	Note	Calls attention to important or additional information.
	Tip	Provides helpful information, guidelines, or suggestions for performing tasks more effectively.
	Caution	Warns the user of adverse conditions and/or consequences (for example, disruptive operations, data loss, or a system crash).
	WARNING	Warns the user of a hazardous situation which, if not avoided, could result in death or serious injury.

## Conventions for storage capacity values

Physical storage capacity values (for example, disk drive capacity) are calculated based on the following values:

Physical capacity unit	Value
1 kilobyte (KB)	1,000 (10 <sup>3</sup> ) bytes
1 megabyte (MB)	1,000 KB or 1,000 <sup>2</sup> bytes
1 gigabyte (GB)	1,000 MB or 1,000 <sup>3</sup> bytes
1 terabyte (TB)	1,000 GB or 1,000 <sup>4</sup> bytes
1 petabyte (PB)	1,000 TB or 1,000 <sup>5</sup> bytes
1 exabyte (EB)	1,000 PB or 1,000 <sup>6</sup> bytes

Logical capacity values (for example, logical device capacity, cache memory capacity) are calculated based on the following values:

Logical capacity unit	Value
1 block	512 bytes

Logical capacity unit	Value
1 cylinder	Mainframe: 870 KB Open-systems: <ul style="list-style-type: none"> <li>• OPEN-V: 960 KB</li> <li>• Others: 720 KB</li> </ul>
1 KB	1,024 (2 <sup>10</sup> ) bytes
1 MB	1,024 KB or 1,024 <sup>2</sup> bytes
1 GB	1,024 MB or 1,024 <sup>3</sup> bytes
1 TB	1,024 GB or 1,024 <sup>4</sup> bytes
1 PB	1,024 TB or 1,024 <sup>5</sup> bytes
1 EB	1,024 PB or 1,024 <sup>6</sup> bytes

## Accessing product documentation

Product user documentation is available on Hitachi Data Systems Support Connect: <https://knowledge.hds.com/Documents>. Check this site for the most current documentation, including important updates that may have been made after the release of the product.

## Getting help

[Hitachi Data Systems Support Connect](#) is the destination for technical support of products and solutions sold by Hitachi Data Systems. To contact technical support, log on to Hitachi Data Systems Support Connect for contact information: [https://support.hds.com/en\\_us/contact-us.html](https://support.hds.com/en_us/contact-us.html).

[Hitachi Data Systems Community](#) is a global online community for HDS customers, partners, independent software vendors, employees, and prospects. It is the destination to get answers, discover insights, and make connections. **Join the conversation today!** Go to [community.hds.com](https://community.hds.com), register, and complete your profile.

## Comments

Please send us your comments on this document to [doc.comments@hds.com](mailto:doc.comments@hds.com). Include the document title and number, including the revision level (for example, -07), and refer to specific sections and paragraphs whenever possible. All comments become the property of Hitachi Data Systems Corporation.

**Thank you!**



# Hitachi Virtual Storage Platform G400, G600 hardware overview

Hitachi Virtual Storage Platform G400, G600 are modular, rack-mountable, all-flash arrays that deliver high performance, high reliability, and flash-accelerated scalability.

The storage system contain dual controllers, each controller contains its own processor, dual in-line cache memory modules (DIMMs), cache flash memory (CFM), battery, fans and iSCSI and Fibre Channel I/O modules. Each controller also has an Ethernet connection for out-of-band management. If the data path through one controller fails, all data drives remain available to data hosts using a redundant data path through the other controller.

The storage system can be equipped with embedded network-attached storage (NAS) modules. The NAS modules provide file access through CIFS and NFS protocols and block access by using iSCSI protocols.

All storage system models allow defective drives to be replaced without the interruption of data availability to hosts. A hot spare drive can be configured to replace a failed drive automatically, securing the fault-tolerant integrity of the logical drives. Self-contained, hardware-based RAID logical drives provide maximum performance in compact external enclosures.

Essential hardware components are implemented with a redundant configuration so that the storage system can remain operational if a component fails. Adding and replacing components, along with firmware upgrades, can be conducted while the storage system is active.

- [Block configuration](#)
- [Unified configuration](#)
- [VSP G400 model](#)
- [VSP G600 model](#)

- [Features](#)
- [Scalability](#)

## Block configuration

A storage system configured for block-level storage provides the ability to access and provision raw storage volumes using protocols such as Fibre Channel and iSCSI.

A block configuration consists of the following:

- Two controllers
- One or more drive trays
- One 1U service processor server (SVP)

## Unified configuration

A unified configuration includes embedded NAS modules that support file system protocols such as CIFS and NFS and operate across a block-level setup using iSCSI or FC connections.

- Two controllers
- Two NAS modules for file operations and storage
- One or more drive trays for block-level storage
- One 1U block service processor server (SVP)

## VSP G400 model

The VSP G400 is a highly reliable storage system that offers high storage capacity with full redundancy to better protect data and manage storage operations.

The storage system consists of a 4U enclosure that includes two controllers, two optional NAS modules to support file operations. Drives are supported using drive trays connected to the controllers. The maximum number of drives supported is 384 (480 with dense intermix drive tray).

The storage system supports 128 GB of high-speed cache memory. The DIMMs are arranged as 64 GB per controller.

Storage system interfaces consist of:

- 10-Gbps iSCSI: 28 ports per system (or 32 ports per systems for systems without drives or 12 ports per systems when NAS Modules are installed)
- 10-Gbps iSCSI (Copper): 28 ports per system (or 32 ports per systems for systems without drives or 12 ports per systems when NAS Modules are installed)
- 8-Gbps Fibre Channel: 56 ports per system (or 64 ports per systems for systems without drives or 24 ports per systems when NAS Modules are installed)

- 16-Gbps Fibre Channel (2-port): 28 ports per system (or 32 ports per systems for systems without drives or 12 ports per systems when NAS Modules are installed)
- 16-Gbps Fibre Channel (4-port): 56 ports per system (or 64 ports per systems for systems without drives or 24 ports per systems when NAS Modules are installed)
- 32-Gbps Fibre Channel (4-port): 56 ports per system (or 64 ports per systems for systems without drives or 24 ports per systems when NAS Modules are installed)

Controller	Controller chassis	Controller model	Height
CBLM	DW800-CBL	DW-F800-CTLM	4U (174.3 mm)

Controller	Model number	Description
NAS	DW-F800-NAS	Optional component for file storage configuration. NAS modules only provide file support.

Drive tray	Drive tray model name	Supported drive type	Number of drives supported	Height
SFF drive tray	<ul style="list-style-type: none"> <li>• DW-F800-DBS (power supply, contains BNST)</li> <li>• DW-F800-DBSC</li> </ul>	2.5-inch SFF	24	2U (86.2 mm)
LFF drive tray	<ul style="list-style-type: none"> <li>• DW-F800-DBL (power supply, contains BNST)</li> <li>• DW-F800-DBLC</li> </ul>	3.5-inch LFF	12	2U (86.2 mm)
FMD tray	<ul style="list-style-type: none"> <li>• DW-F800-DBF</li> </ul>	5.25-inch FMD	12	2U (86.2 mm)
Dense intermix drive tray	<ul style="list-style-type: none"> <li>• DW-F800-DB60 (power supply, contains BNST)</li> <li>• DW-F800-DB60C</li> </ul>	3.5-inch LFF	60	4U (174.3 mm)

### Related references

- [Examples of supported VSP G400 configurations](#) on page 19

## VSP G600 model

The VSP G600 is a highly reliable storage system that offers high storage capacity with full redundancy to better protect data and manage storage operations.

The storage system consists of a 4U enclosure that includes two controllers, two optional NAS modules to support file operations. Drives are supported using drive trays connected to the controllers. The maximum number of drives supported is 576 (720 with dense intermix drive tray).

The storage system supports 256 GB of high-speed cache memory. The DIMMs are arranged as 128 GB per controller.

Storage system interfaces consist of:

- 10-Gbps iSCSI: 28 ports per system (or 32 ports per systems for systems without drives or 12 ports per systems when NAS Modules are installed)
- 10-Gbps iSCSI (Copper): 28 ports per system (or 32 ports per systems for systems without drives or 12 ports per systems when NAS Modules are installed)
- 8-Gbps Fibre Channel: 56 ports per system (or 64 ports per systems for systems without drives or 24 ports per systems when NAS Modules are installed)
- 16-Gbps Fibre Channel (2-port): 28 ports per system (or 32 ports per systems for systems without drives or 12 ports per systems when NAS Modules are installed)
- 16-Gbps Fibre Channel (4-port): 56 ports per system (or 64 ports per systems for systems without drives or 24 ports per systems when NAS Modules are installed)
- 32-Gbps Fibre Channel (4-port): 56 ports per system (or 64 ports per systems for systems without drives or 24 ports per systems when NAS Modules are installed)

Controller	Controller chassis	Controller model	Height
CBLM	DW800-CBL	DW-F800-CTLM	4U (174.3 mm)

Controller	Model number	Description
NAS	DW-F800-NAS	Optional component for file storage configuration. NAS modules only provide file support.

Drive tray	Drive tray model name	Supported drive type	Number of drives supported	Height
SFF drive tray	<ul style="list-style-type: none"> <li>DW-F800-DBS (power supply, contains BNST)</li> <li>DW-F800-DBSC</li> </ul>	2.5-inch SFF	24	2U (86.2 mm)
LFF drive tray	<ul style="list-style-type: none"> <li>DW-F800-DBL (power supply, contains BNST)</li> <li>DW-F800-DBLC</li> </ul>	3.5-inch LFF	12	2U (86.2 mm)
FMD tray	<ul style="list-style-type: none"> <li>DW-F800-DBF</li> </ul>	5.25-inch FMD	12	2U (86.2 mm)
Dense intermix drive tray	<ul style="list-style-type: none"> <li>DW-F800-DB60 (power supply, contains BNST)</li> <li>DW-F800-DB60C</li> </ul>	3.5-inch LFF	60	4U (174.3 mm)

### Related references

- [Examples of supported VSP G600 configurations](#) on page 19

## Features

The features described in the table are included with VSP G400 and VSP G600.

Feature	Value
Maximum cache memory supported	VSP G400: 128 GB VSP G600: 256 GB
Maximum number of spare drives	32
Maximum number of RAID groups	VSP G400: 240 VSP G600: 240
Maximum volume size	3 TB (4 TB when using the LDEVs of other Storage Systems)
Maximum number of volumes per RAID group	2,048
Maximum number of DP pool volumes	4,096
Maximum number of DP pools	64
Maximum number of iSCSI hosts connected through a network switch	255

Feature	Value
Maximum number of Fibre Channel devices connected through a Fibre Channel switch	255

## Scalability

All storage systems offer pay-as-you-grow scalability by allowing you to hot-add drives as you need them.

### Examples of supported VSP G400 configurations

The following table lists the maximum number of drive trays and drives supported in a system configuration. A *diskless* configuration does not include any drive trays.

Drive tray	Maximum number of drive trays supported	Maximum number of drives supported
SFF drive tray	16	384 HDDs or SSDs
LFF drive tray	16	192 HDDs or SSDs
FMD tray	16	192 Hitachi Accelerated Flash (HAF) flash module drives
Dense intermix drive tray	8	-



**Note:** If a drive is inserted into a slot of a dense intermix drive tray when the installed number of drives exceeds 240 slots per path, the drive is blocked.

#### Related references

- [VSP G400 model](#) on page 15

### Examples of supported VSP G600 configurations

The following table lists the maximum number of drive trays and drives supported in a system configuration. A *diskless* configuration does not include any drive trays.

Drive tray	Maximum number of drive trays supported	Maximum number of drives supported
SFF drive tray	24	576 HDDs or SSDs
LFF drive tray	24	288 HDDs or SSDs
FMD drive tray	24	288 HAF flash module drives
Dense intermix drive tray	12	-



**Note:** If a drive is inserted into a slot of a dense intermix drive tray when the installed number of drives exceeds 240 slots per path, the drive is blocked.

### Related references

- [VSP G600 model](#) on page 17

## Maximum number of mounted drive trays

The following table lists the maximum number of mountable drive trays and mountable drives for each drive type.



**Note:** If a drive is inserted into a slot of a dense intermix drive tray when the installed number of drives exceeds 240 slots per path, the drive is blocked.

VSP G400 controller	Drive trays	Maximum number of trays	Maximum number of drives
CBLM	SFF	16	384 HDDs or SSDs
	LFF	16	192 HDDs or SSDs
	FMD	16	192 FMDs (HAF)
		4	48 FMDs
	FMD	1	8 FMDs + 1 spare (DC2)
Dense intermix drive tray	8	480 HDDs or SSDs <sup>1</sup>	
<b>Note:</b>			
<sup>1</sup> The following SSD capacities (200 GB and 400 GB) are supported in a dense intermix drive tray.			
VSP G600 controller	Drive trays	Maximum number of trays	Maximum number of drives
CBLM	SFF	24	576 HDDs or SSDs
	LFF	24	288 HDDs or SSDs
	FMD	24	288 FMDs (HAF)
		4	48 FMDs
	FMD	2	16 FMDs + 1 spare (DC2)
Dense intermix drive tray	12	720 HDDs or SSDs <sup>1</sup>	
<b>Note:</b>			
<sup>1</sup> The following SSD capacities (200 GB and 400 GB) are supported in a dense intermix drive tray.			



VSP G400 controller	Number of mounted drive trays (Maximum 12 per path)		Maximum number of mounted drives	
	SFF, LFF drives	Dense intermix drive tray	SFF drive + dense intermix drive tray	LFF drive + dense intermix drive tray
CBLM	16	0	384	192
	13	1	372	216
	12	2	408	264
	9	3	396	288
	8	4	432	336
	5	5	420	360
	4	6	456	408
	1	7	444	432
	0	8	480	480

VSP G600 controller	Number of mounted drive trays (Maximum 12 per path)		Maximum number of mounted drives	
	SFF, LFF drives	Dense intermix drive tray	SFF drive + dense intermix drive tray	LFF drive + dense intermix drive tray
CBLM	24	0	576	288
	21	1	564	312
	20	2	600	360
	17	3	588	384
	16	4	624	432
	13	5	612	456
	12	6	648	504
	9	7	636	528
	8	8	672	576
	5	9	660	600
	4	10	696	648
	1	11	684	672
	0	12	720	720



## Virtual Storage Platform G400, G600 controller

The Virtual Storage Platform G400, G600 models are equipped with dual controllers for communicating with a data host.

Each controller includes the following internal components such as a processor, dual in-line cache memory modules (DIMMs), cache flash memory (CFM), battery, and fans. The controller has an Ethernet connection for out-of-band management using Hitachi Device Manager - Storage Navigator. If the data path through one controller fails, all drives remain available to data hosts using a redundant data path through the other controller. The controller is equipped with LED indicators for monitoring its operating conditions and notifying possible component replacement.

- [CBLM controller](#)
- [Host, Network, and Drive Tray Ports and LEDs](#)

## CBLM controller

The CBLM controller includes specific functional LEDs located on the front and rear of controller and power supplies to provide its operating status.

### CBLM with front panel bezel

The following table describes the definitions of the CBLM controller front panel bezel LEDs.

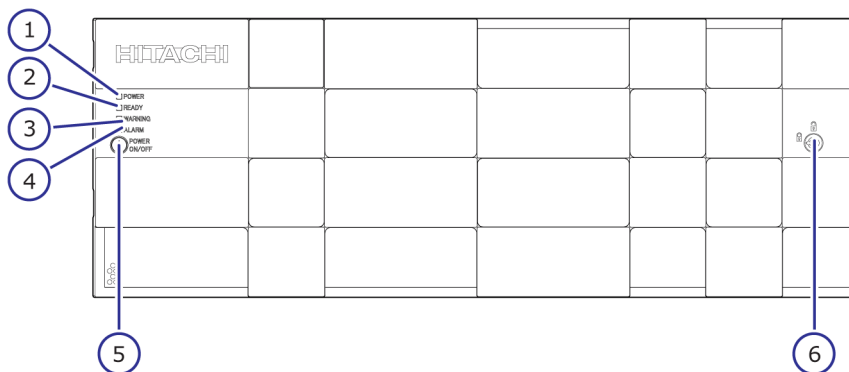

Number	Item	Description
1	POWER LED	Green: Storage system is powered on.  Amber: Storage system is receiving power.
2	READY LED	Green: Normal operation.
3	WARNING LED	Off: Normal operation.  Amber: Component requires maintenance.  Blink: Failure requires maintenance.  <b>Note:</b> When System Option Mode 1097 is set to ON, the WARNING LED does not blink, even if the following failure service information messages (SIM) are issued: 452xxx, 462xxx, 3077xx, 4100xx, and 410100.  LED might turn off during user maintenance.
4	ALARM LED	Off: Normal operation.

Number	Item	Description
		Red: Processor failure (system might be down). Go to the Customer Contact Us page at <a href="https://support.hds.com/en_us/contact-us.html">https://support.hds.com/en_us/contact-us.html</a> .
5	POWER ON/OFF (main switch)	Powers the storage system.
6	Lock	Locks and unlocks the front panel bezel by using the supplied key.



**Note:** Removing a controller can cause the POWER, READY, WARNING, and ALARM LEDs on the front panel to turn off. These LEDs return to the on status after the storage system recovers from the controller replacement.

### CBLM front panel LEDs (without bezel)

The following table describes the definitions of the CBLM controller front panel LEDs.

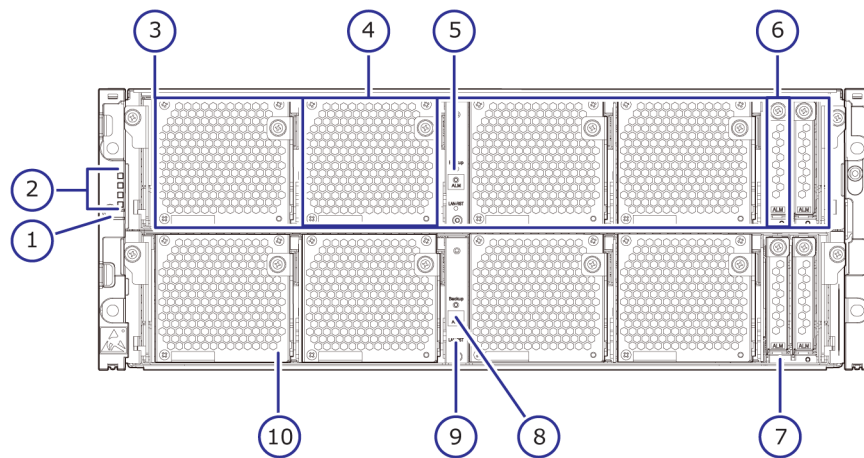

Number	Item	Description
1	POWER ON/OFF (main switch)	Powers the storage system.
2	POWER, READY, WARNING, and ALARM LEDs	<b>Note:</b> When System Option Mode 1097 is set to ON, the WARNING LED does not blink, even if the following failure service information messages (SIM) are issued: 452xxx, 462xxx, 3077xx, 4100xx, and 410100.
3	Controllers	Controller 1 (bottom) and Controller 2 (top).

Number	Item	Description
4	Backup module	N/A
5	BACKUP LED	Green: Power restoration in progress following power outage.  Fast blink green: Restoring.  Slow blink green: Restoring, or sequential shutdown in progress.
6	Cache flash memory	N/A
7	ALM LED (for cache flash memory)	Red: Cache flash memory can be removed.
8	CTL ALM LED	Red: Controller can be removed.  Blink red: Failure with the power supply unit of the controller.  Amber: LAN reset switch was pressed.
9	LAN-RST switch	Use only when instructed by customer support.
10	STATUS LED (for BKMF)	Green: Charging of the battery in the backup module is complete.  Red: Backup module can be removed.  Blink red one time: Main battery failure.  Blink red two times: Backup battery failure.  Blink red three times: Both batteries failed or preventive maintenance replacement of batteries can run.  Off: Battery is not mounted, battery-mounting failure occurred, or firmware is being upgraded. Off is normal status for configurations without batteries (for example, BKMF-10 and BKMF-20).

## CBLM rear panel

The following table describes the definitions of the CBLM controller rear panel LEDs.

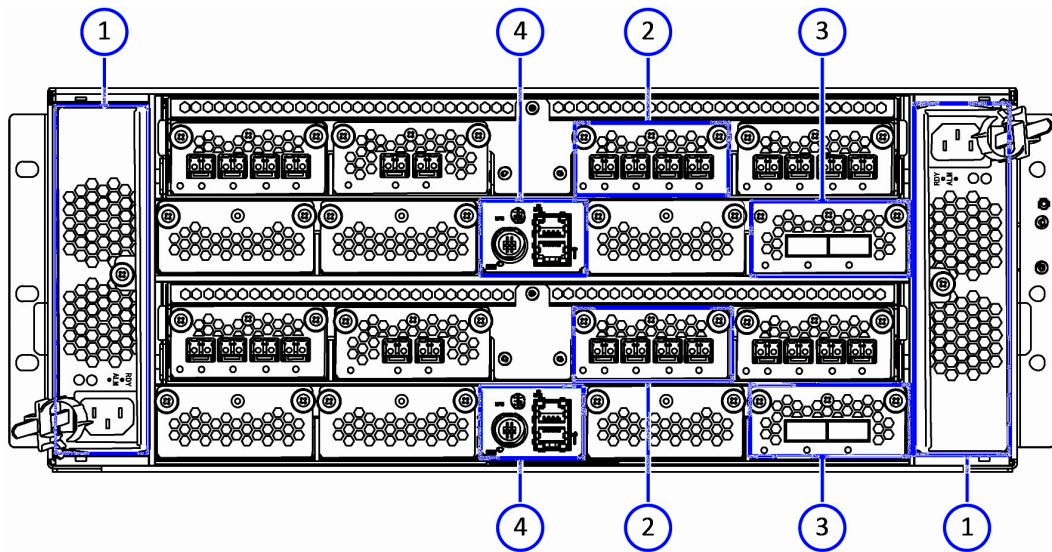

Number	Item
1	Power supply unit
2	Front end module
3	Back end module
4	LAN blade

**Rear view (includes NAS modules)**

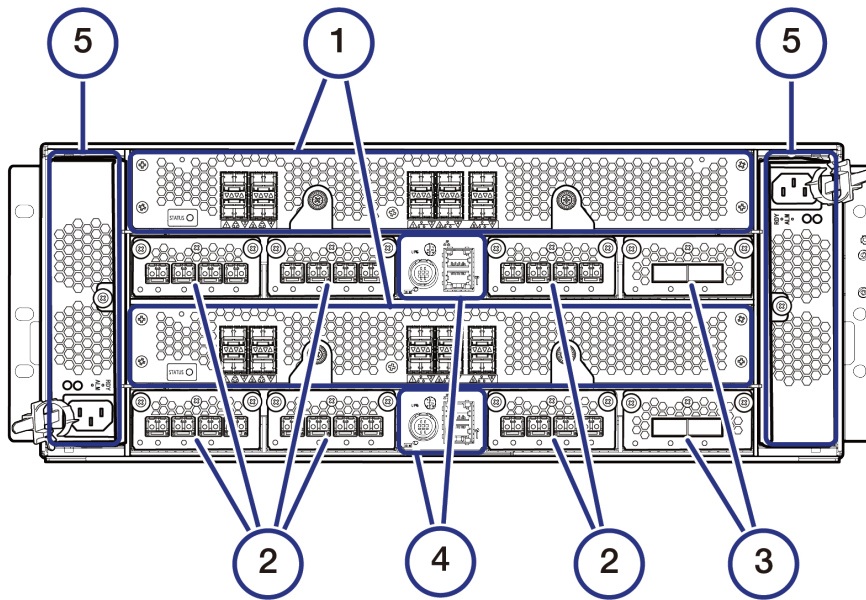

Number	Item
1	NAS module
2	Front end module
3	Back end module
4	LAN blade
5	Power supply unit

## CBLM power supply unit LEDs and connectors

The following table lists the definitions of the CBLM power supply unit LEDs and connectors.

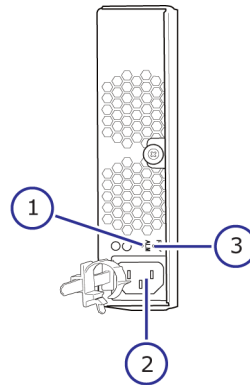

Number	Item	Description
1	ALM/RDY LED	Red: Power supply unit can be replaced.
2	Receptacle	Connects to the power cable provided with the storage system.
3	RDY LED	Green: Normal operation.

## Host, Network, and Drive Tray Ports and LEDs

The controllers are equipped with specific interfaces for connecting, powering, configuring, and managing the storage system. The component LEDs display the operating status of the storage system.

### Front end module descriptions

The front end module LEDs display the operating status of the module.



## 10-Gbps iSCSI board LEDs and connectors (optical)

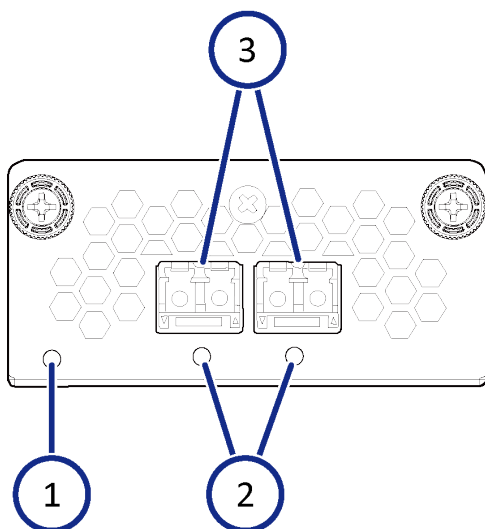

Number	Item	Description
1	STATUS LED	Green: Front end module is in the power-on state. Red: Front end module can be removed safely.
2	PORT LED	Red: Small form factor pluggable can be removed. Blue: Normal link status. Blink blue: Front end module is in communication status.
3	iSCSI connectors	Connect to Ethernet LAN cables.

## 10-Gbps iSCSI board LEDs and connectors (copper)

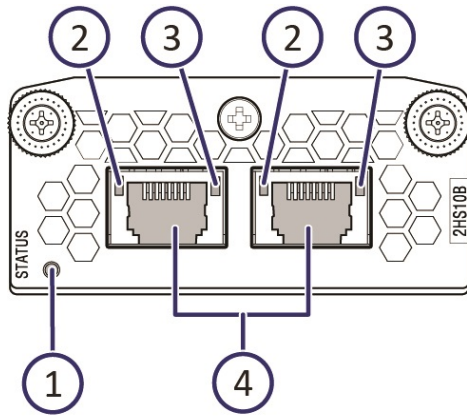

Number	Item	Description
1	STATUS LED	Green: Front end module is in the power-on state. Red: Front end module can be removed safely.
2	PORT (Link/Speed) LED	Yellow: 1-Gbps link. Green: 10-Gbps link. Off: No link connection.
3	PORT LED	Green: Link connection is established. Blinking: Communication is in progress. Off: No link connection or not ready to communicate.
4	iSCSI connectors	Connect to Ethernet LAN cables.

### 8-Gbps, 16-Gbps, or 32-Gbps Fibre Channel (4-port) board LEDs and connectors

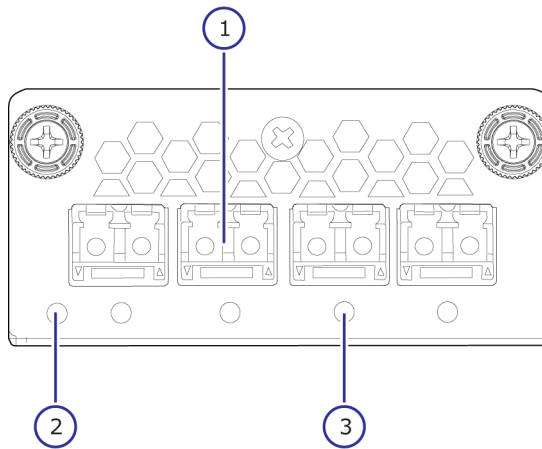

**Table 1 8-Gbps Fibre Channel**

Number	Item	Description
1	Fibre Channel connectors	Connect to Fibre Channel cables.
2	STATUS LED	Green: Front end module is in power-on state. Red: Front end module can be removed safely.
3	PORT LED	Red: Small form factor pluggable can be removed. Blue: Normal link status at 8-Gbps. Green: Normal link status at 2-Gbps or 4-Gbps.

**Table 2 32-Gbps, 16-Gbps Fibre Channel**

Number	Item	Description
1	Fibre Channel connectors	Connect to Fibre Channel cables.
2	STATUS LED	Green: Front end module is in power-on state. Red: Front end module can be removed safely.
3	PORT LED	Red: Small form factor pluggable can be removed. Blue: Normal link status at 16-Gbps (16-Gbps). Blue: Normal link status at 32-Gbps (32-Gbps).

Number	Item	Description
		Green: Normal link status at 4-Gbps or 8-Gbps (16-Gbps).  Green: Normal link status at 8-Gbps or 16-Gbps (32-Gbps).

### Port assignments

CHB number	8-Gbps, 16-Gbps, or 32-Gbps Fibre Channel Ports (left to right)			
	Port 1	Port 2	Port 3	Port 4
CHB-1A	1A	3A	5A	7A
CHB-1B	1B	3B	5B	7B
CHB-1C	1C	3C	5C	7C
CHB-1D	1D	3D	5D	7D
CHB-1E	1E	3E	5E	7E
CHB-1F	1F	3F	5F	7F
CHB-1G	1G	3G	5G	7G
CHB-1H	1H	3H	5H	7H
CHB-2A	2A	4A	6A	8A
CHB-2B	2B	4B	6B	8B
CHB-2C	2C	4C	6C	8C
CHB-2D	2D	4D	6D	8D
CHB-2E	2E	4E	6E	8E
CHB-2F	2F	4F	6F	8F
CHB-2G	2G	4G	6G	8G
CHB-2H	2H	4H	6H	8H

### 16-Gbps Fibre Channel (2-port) board LEDs and connectors

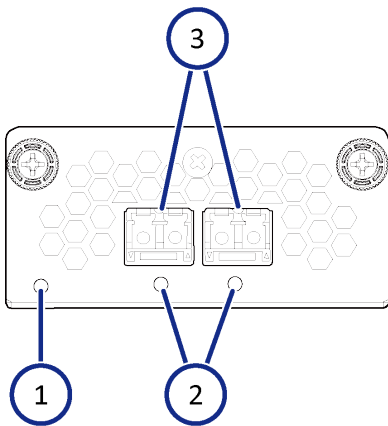

Number	Item	Description
1	STATUS LED	Green: Front end module is in the power-on state.  Red: Front end module can be removed safely.
2	PORT LED	Red: Small form factor pluggable can be removed.  Blue: Normal link status at 16-Gbps.  Green: Normal link status at 4-Gbps or 8-Gbps.
3	Fibre Channel connectors	Connect to Fibre Channel cables.

### Port assignments

CHB number	16-Gbps Fibre Channel Ports (left to right)	
	Port 1	Port 2
CHB-1A	1A	3A
CHB-1B	1B	3B
CHB-1C	1C	3C
CHB-1D	1D	3D
CHB-1E	1E	3E
CHB-1F	1F	3F
CHB-1G	1G	3G
CHB-1H	1H	3H
CHB-2A	2A	4A
CHB-2B	2B	4B
CHB-2C	2C	4C
CHB-2D	2D	4D
CHB-2E	2E	4E
CHB-2F	2F	4F
CHB-2G	2G	4G
CHB-2H	2H	4H

## LAN blade LEDs and connectors

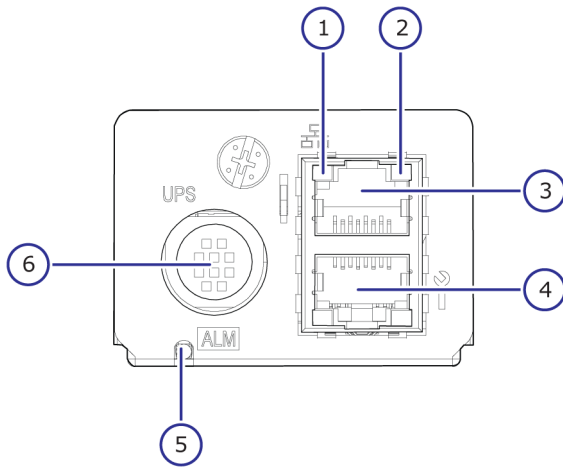

Number	Item	Description
1	ACT LED	Green: Data is being transferred.
2	LINK LED	Green: Link status is normal.
3	LAN 2	LAN port used by the user.
4	LAN 1	Maintenance LAN port used by service personnel.
5	LAN ALARM LED	Red: LAN blade can be removed.
6	Uninterruptible power supply (UPS) port	N/A

## Back end module LEDs and connectors

The back end module LEDs display the operating status of the module.

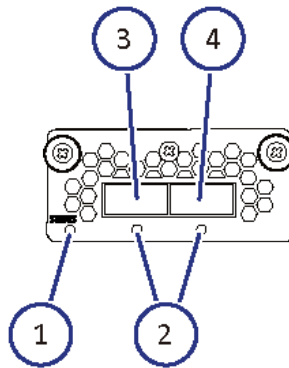

Number	Item	Description
1	STATUS LED	Green: Back end module is in the power-on state. Red: Back end module can be removed safely.
2	Port LED	Blue: Link status is normal.
3	PATH 0 connector	Connect to a drive tray.
4	PATH 1 connector	Connects to a drive tray.





## Storage system drive trays

The drive trays contain drives, power supplies, fans, and status LEDs. Each drive tray provides interfaces for connecting to controllers and other drive trays. The all-flash storage arrays have various fixed storage capacity configurations with FMD DC2 flash storage devices. To deliver consistent low latency host response times and highest IOP performance across all host connection ports, conventional HDDs are not included or configurable with all-flash arrays.

- [Small form-factor \(SFF\) drive tray](#)
- [Large form-factor \(LFF\) drive tray](#)
- [Flash module drive \(FMD\) tray](#)
- [Dense intermix drive tray](#)
- [SFF and LFF AC power supply unit LEDs and connectors](#)

## Small form-factor (SFF) drive tray

### SFF with front panel bezel

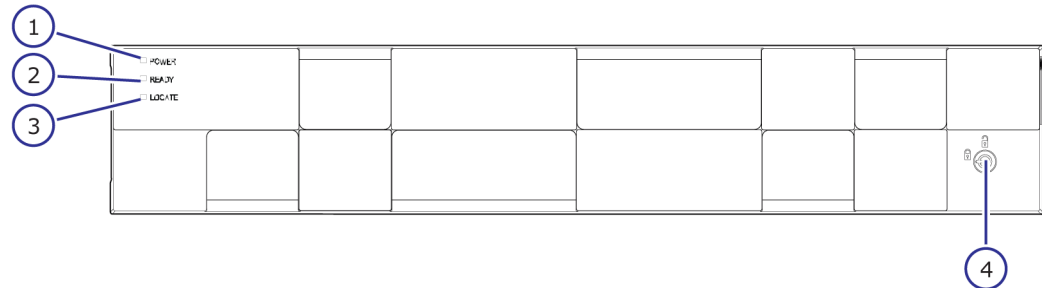

Number	Item	Description
1	POWER LED	Green: Drive tray is powered on.
2	READY LED	Green: Drive tray is operational.
3	LOCATE LED	Amber: <ul style="list-style-type: none"><li>Indicates the location of the chassis.</li><li>Can be turned on or turned off by the maintenance utility.</li></ul>
4	Lock	Locks and unlocks the front panel bezel by using the supplied key.

### SFF front panel without bezel

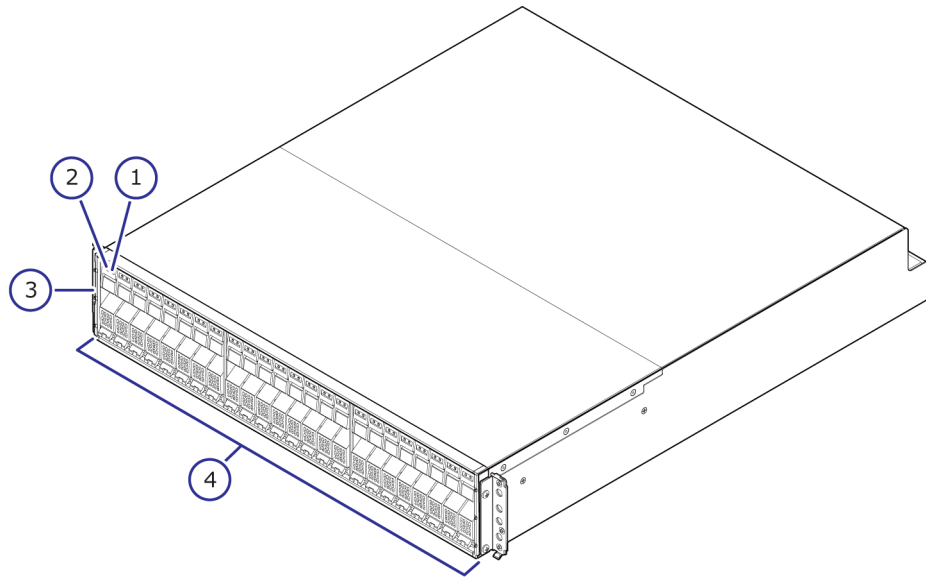

Number	Item	Description
1	ACT LED	Green: Normal operation. Blink green: Drive is being accessed.
2	ALM LED	Red: Drive stopped due to a failure and can be replaced.
3	POWER, READY, and LOCATE LEDs	Green: Drive tray is powered on. Green: Drive tray is operational. Amber: <ul style="list-style-type: none"> <li>Indicates the location of the chassis.</li> <li>Can be turned on or turned off by the maintenance utility.</li> </ul>
4	Small form factor drives	The twenty-four 2.5-inch small form factor drives are positioned vertically. The slots are organized from 0 to 23.

## SFF rear panel

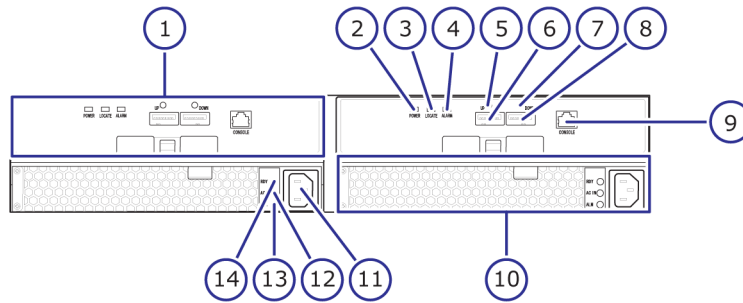

Number	Item	Description
1	ENC	N/A
2	POWER LED	Green: ENC is in the power-on state.
3	LOCATE LED	Amber: <ul style="list-style-type: none"> <li>Indicates the location of the chassis.</li> <li>Can be turned on or turned off by the maintenance utility.</li> </ul>
4	ALARM LED	Red: ENC can be replaced.
5	PATH (IN) LED	Blue: IN side port is linked up.
6	PATH (IN) connector	Connects to a controller or drive tray.
7	PATH (OUT) LED	Blue: OUT side port is linked up.
8	PATH (OUT) connector	Connects to a drive tray.
9	Console	This port is reserved.
10	Power supply unit	N/A
11	Receptacle	Connects to the power cable provided with the storage system.
12	AC IN LED	Green: Normal operation.
13	ALM LED	Red: Power supply unit can be replaced.
14	RDY LED	Green: Normal operation.

## Large form-factor (LFF) drive tray

### LFF with front panel bezel

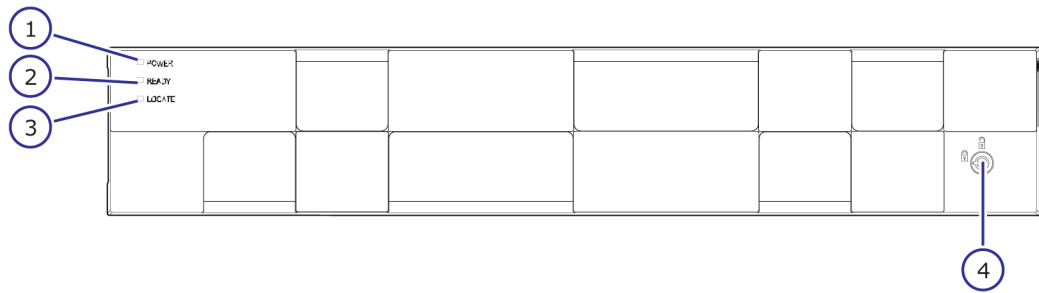

Number	Item	Description
1	POWER LED	Green: Drive tray is powered on.
2	READY LED	Green: Drive tray is operational.
3	LOCATE LED	Amber: <ul style="list-style-type: none"> <li>Indicates the location of the chassis.</li> <li>Can be turned on or turned off by the maintenance utility.</li> </ul>
4	Lock	Locks and unlocks the front panel bezel by using the supplied key.

## LFF front panel without bezel

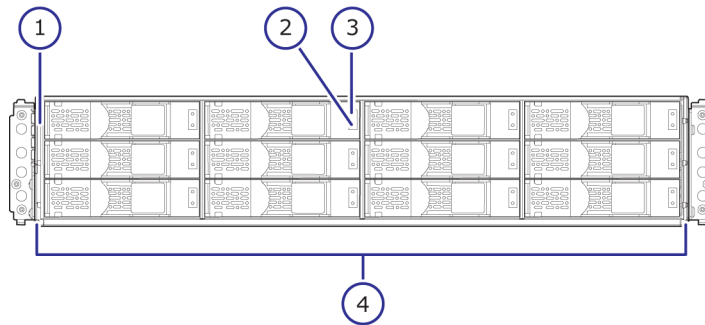

Number	Item	Description
1	POWER, READY, and LOCATE LEDs	Green: Drive tray is powered on. Green: Drive tray is operational. Amber:

Number	Item	Description
		<ul style="list-style-type: none"> <li>Indicates the location of the chassis.</li> <li>Can be turned on or turned off by the maintenance utility.</li> </ul>
2	ACT LED	<p>Green: Normal operation.</p> <p>Blink green: Drive is being accessed.</p>
3	ALM LED	Red: Drive stopped due to a failure and can be replaced.
4	Large form factor drives	<p>The twelve 3.5-inch large form factor drives are positioned horizontally. The slots are organized in the following order:</p> <pre> 8 9 10 11 4 5 6 7 0 1 2 3 </pre>

## LFF rear panel

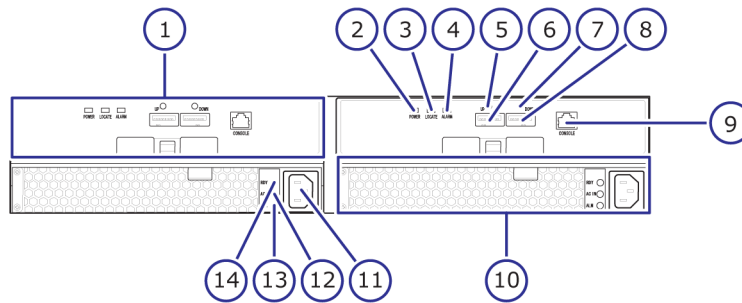

Number	Item	Description
1	ENC	N/A
2	POWER LED	Green: ENC is in the power-on state.
3	LOCATE LED	<p>Amber:</p> <ul style="list-style-type: none"> <li>Indicates the location of the chassis.</li> <li>Can be turned on or turned off by the maintenance utility.</li> </ul>
4	ALARM LED	Red: ENC can be replaced.
5	PATH (IN) LED	Blue: IN side port is linked up.

Number	Item	Description
6	PATH (IN) connector	Connects to a controller or drive tray.
7	PATH (OUT) LED	Blue: OUT side port is linked up.
8	PATH (OUT) connector	Connects to a drive tray.
9	Console	This port is reserved.
10	Power supply unit	N/A
11	Receptacle	Connects to the power cable provided with the storage system.
12	AC IN LED	Green: Normal operation.
13	ALM LED	Red: Power supply unit can be replaced.
14	RDY LED	Green: Normal operation.

## Flash module drive (FMD) tray

### FMD with front panel bezel

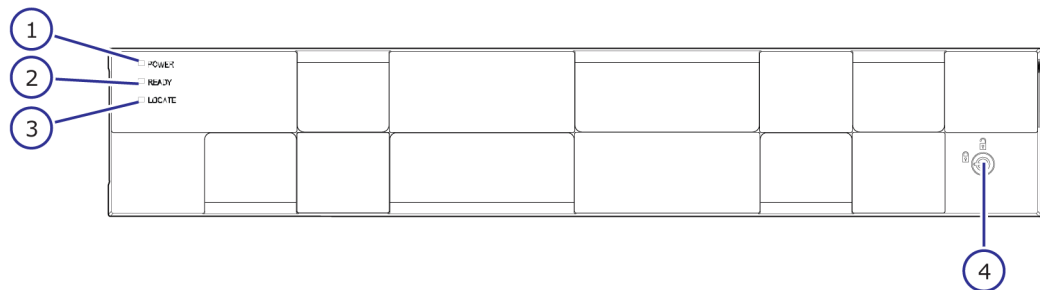

Number	Item	Description
1	POWER LED	Green: Drive tray is powered on.
2	READY LED	Green: Drive tray is operational.
3	LOCATE LED	Amber: <ul style="list-style-type: none"> <li>Indicates the location of the chassis.</li> <li>Can be turned on or turned off by the maintenance utility.</li> </ul>

Number	Item	Description
4	Lock	Locks and unlocks the front panel bezel by using the supplied key.

## FMD front panel without bezel

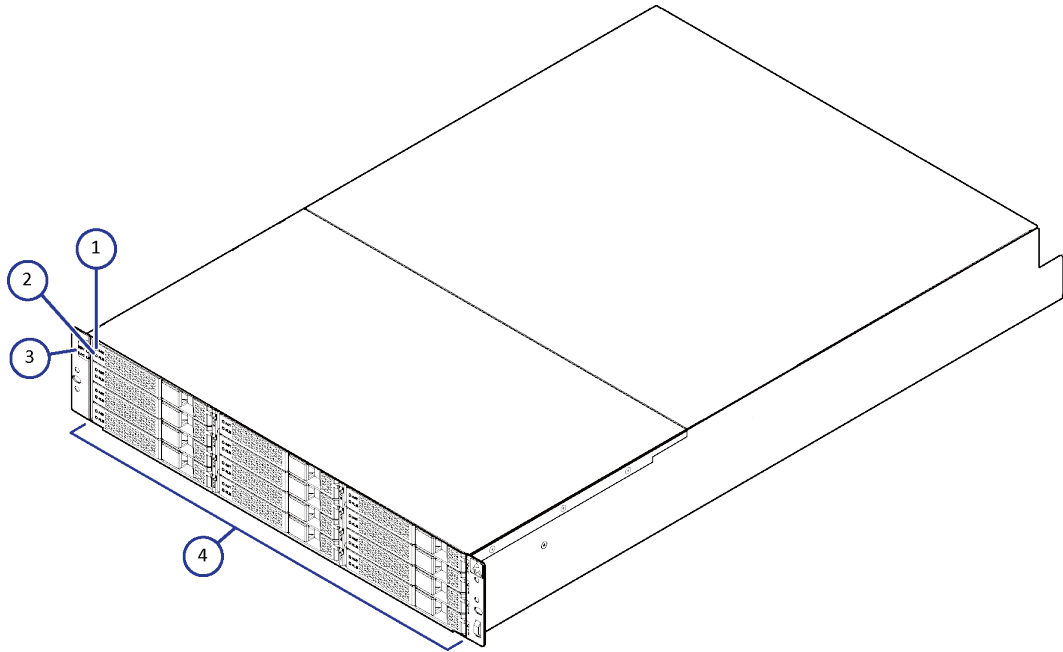

Number	Item	Description
1, 2	ACT LED	<p>Green: Normal operation.</p> <p>Blink: Drive is being accessed.</p> <p>Slow blink:</p> <ul style="list-style-type: none"> <li>DKC-F710I-1R6FM/3R2FM: Insufficient battery capacity in the flash module drive.</li> <li>DKC-F810I-1R6FN/3R2FN/6R4FN: Flash module drive built-in capacitor is charged. If the storage system is turned on, the LED stops blinking when the capacitor is finished charging (approximately two minutes).</li> </ul> <p><b>Note:</b> ACT indicator is only printed on some types of FMDs.</p>



Number	Item	Description
	ALM LED	Red: Drive stopped due to a failure and can be replaced. <b>Note:</b> ACT indicator is only printed on some types of FMDs.
3	POWER, READY, and LOCATE LEDs	Green: Drive tray is powered on. Green: Drive tray is operational. Amber: <ul style="list-style-type: none"> <li>Indicates the location of the chassis.</li> <li>Can be turned on or turned off by the maintenance utility.</li> </ul>
4	Flash module drives	Twelve flash module drives. Slots are organized the following way: 9, 10, 11 6, 7, 8 3, 4, 5 0, 1, 2

## FMD rear panel

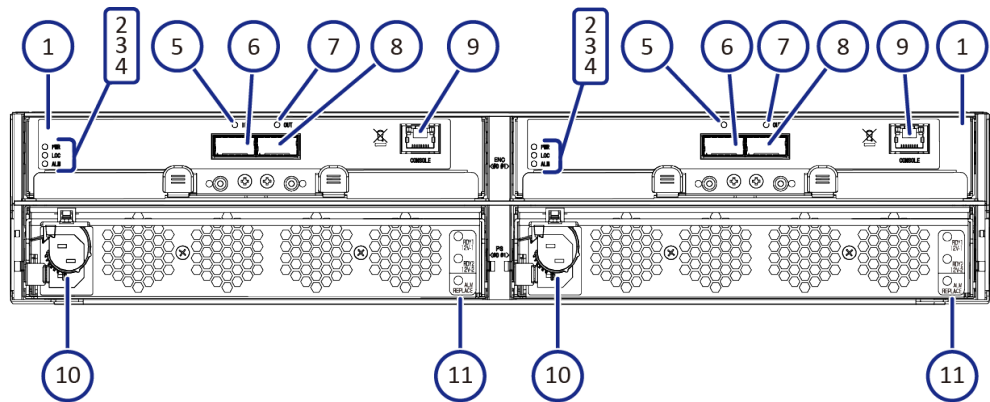

Number	Item	Description
1	ENC	N/A
2	POWER LED	Green: ENC is in the power-on state.
3	LOCATE LED	Amber:

Number	Item	Description
		<ul style="list-style-type: none"> <li>Indicates the location of the chassis.</li> <li>Can be turned on or turned off by the maintenance utility.</li> </ul>
4	ALARM LED	Red: ENC can be replaced.
5	PATH (IN) LED	Blue: IN side port is linked up.
6	PATH (IN) connector	Connects to a controller or drive tray.
7	PATH (OUT) LED	Blue: OUT side port is linked up.
8	PATH (OUT) connector	Connect to a drive tray.
9	Console	This port is reserved.
10	Receptacle	Connects to the power cable provided with the storage system.
11	Three LEDS, top to bottom: RDY LED	Green: Power supply unit is operating normally.
	AC IN LED	Green: Power supply unit is operating normally.
	ALM REPLACE LED	Red: Power supply unit can be replaced.

## Dense intermix drive tray

## Dense intermix drive tray with front panel bezel

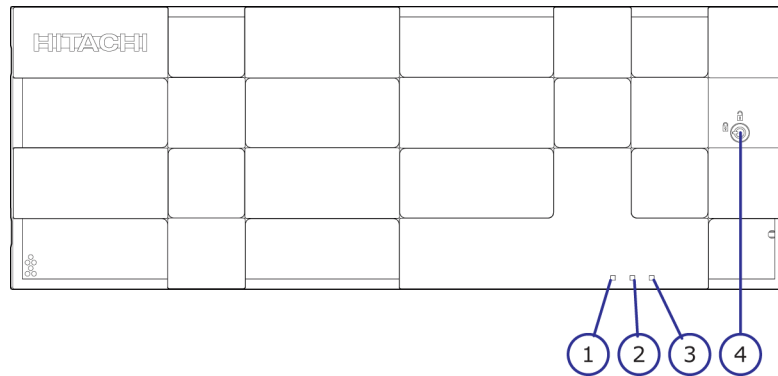

Number	Item	Description
1	POWER LED	Green: Drive tray is powered on.
2	READY LED	Green: Drive tray is operational.
3	LOCATE LED	Amber: <ul style="list-style-type: none"> <li>Indicates the location of the chassis.</li> <li>Can be turned on or turned off by the maintenance utility.</li> </ul>
4	Lock	Locks and unlocks the front panel bezel by using the supplied key.

## Dense intermix drive tray display LEDs

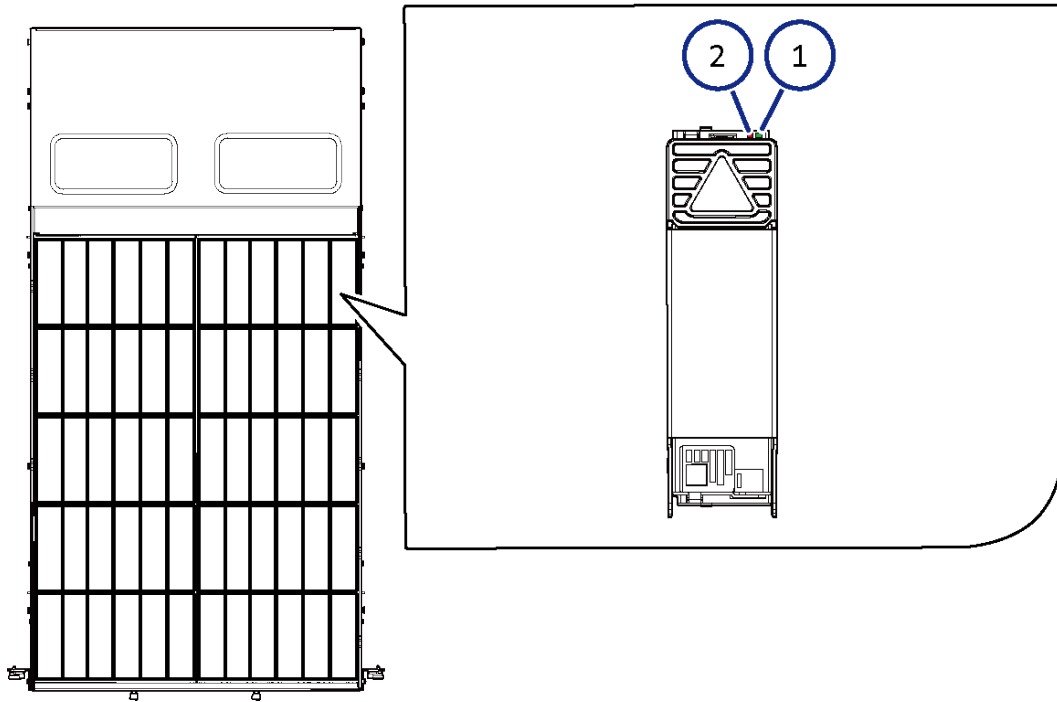

Number	Item	Description
1	ACT	Green: Normal operation. Blink green: Drive is being accessed.
2	ALM LED	Red: Drive stopped due to a failure and can be replaced.

**Note:** At the rear of the drive tray, the drives are organized from left to right. On the left side of the preceding figure, the rear of the drive tray is at the top.

- Rear of drive tray: 48-59
- 36-47
- 24-35
- 12-23
- Front of drive tray: 00-11

## Dense intermix drive tray rear panel

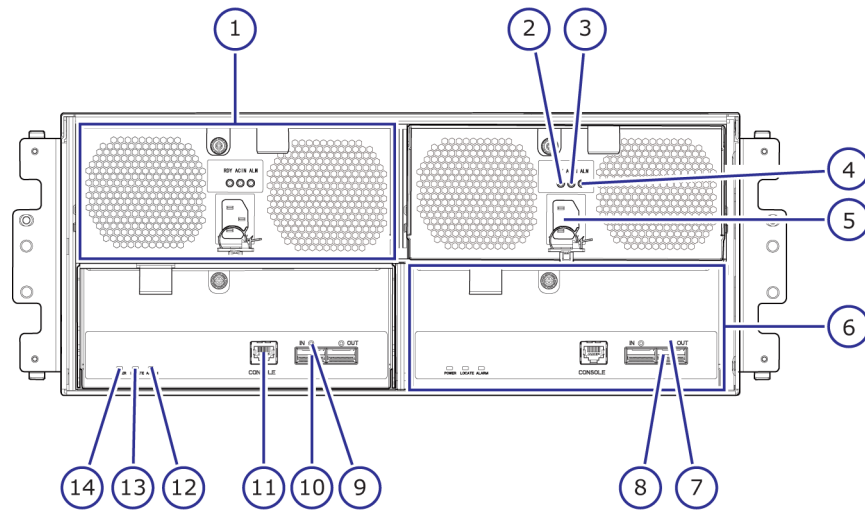

Number	Item	Description
1	Power supply unit	N/A
2	RDY LED	Green: Normal operation.
3	AC IN LED	Green: Normal operation.
4	ALM LED	Red: Power supply unit can be replaced.
5	Receptacle	Connects to the power cable provided with the storage system.
6	ENC	N/A
7	PATH (OUT) LED	Blue: OUT side port is linked up.
8	PATH (OUT) connector	Connect to a drive tray.
9	PATH (IN) LED	Blue: IN side port is linked up.
10	PATH (IN) connector	Connects to a controller or drive tray.

Number	Item	Description
11	Console	This port is reserved.
12	ALARM LED	Red: ENC can be replaced.
13	LOCATE LED	Amber: <ul style="list-style-type: none"> <li>Indicates the location of the chassis.</li> <li>Can be turned on or turned off by the maintenance utility.</li> </ul>
14	POWER LED	Green: ENC is in the power-on state.

## SFF and LFF AC power supply unit LEDs and connectors

Both SFF and LFF drive trays are equipped with AC power supply units. The AC power supply units include LEDs to display its operating status.

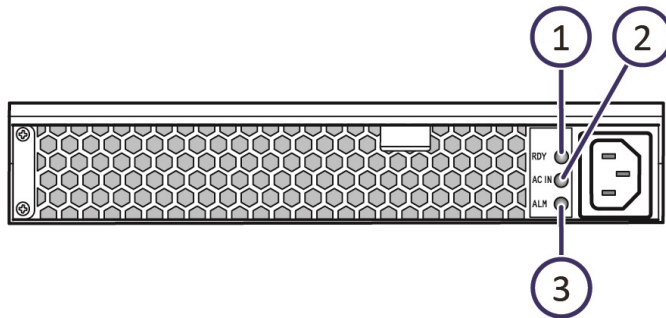

Number	Item	Description
1	RDY LED	Green: Normal operation.
2	AC IN LED	Green: AC input is operating normally.
3	ALM LED	Red: Power supply unit can be replaced.



## Host port expansion chassis

The host port expansion chassis contains various interconnect adapters that connect a host system to storage and other network devices. The interconnect adapters include PCIe boards, iSCSI and FC cards. For more information, contact customer support.

- [Host port expansion chassis front panel bezel LEDs](#)
- [PCIe switchboard](#)
- [Host port expansion chassis fan](#)
- [PCIe cable connector](#)
- [Host port expansion chassis power supply](#)

## Host port expansion chassis front panel bezel LEDs

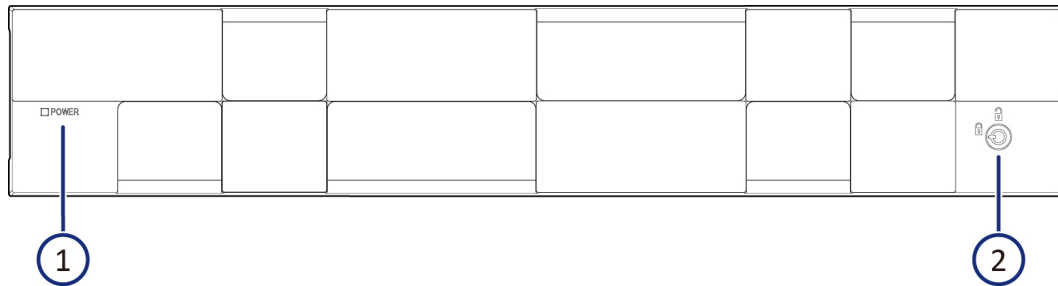

Number	Item	Description
1	POWER LED	Green: Host port expansion is turned on. Amber: PCIe module is turned on. Off: PCIe module is turned off.
2	Safety lock	Lock or unlock the front bezel.

## PCIe switchboard

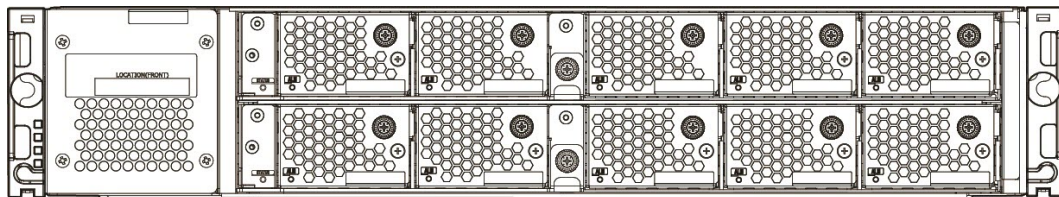

Front view of Expansion Chassis

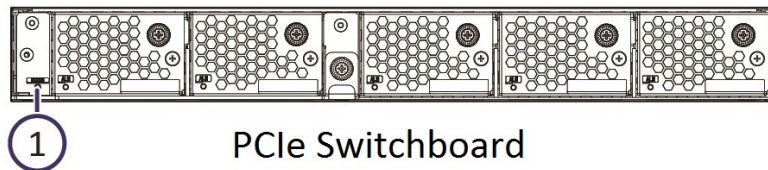

PCIe Switchboard



Number	Item	Description
1	STATUS LED	Green: PCIe switchboard is powered on. Red: PCIe switchboard can be replaced safely.  Off: PCIe switchboard is powered off.

## Host port expansion chassis fan

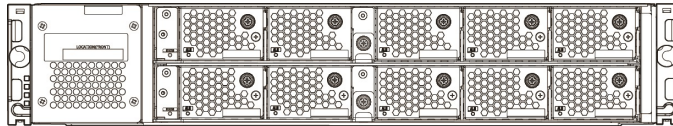

Front View of Expansion Chassis

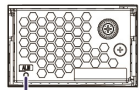

1 Expansion Chassis Fan

Number	Item	Description
1	ALM LED	Red: Fan failure has occurred. Off: Normal operation.

## PCIe cable connector

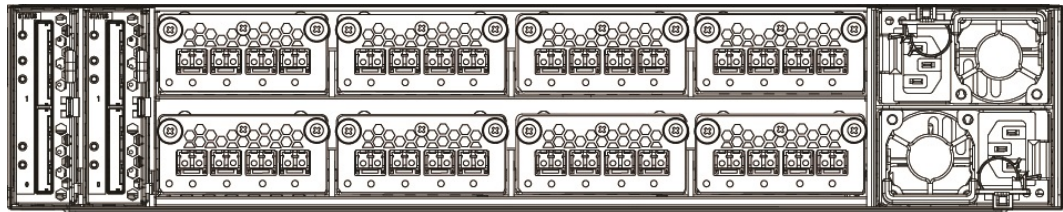

Rear View of Expansion Chassis

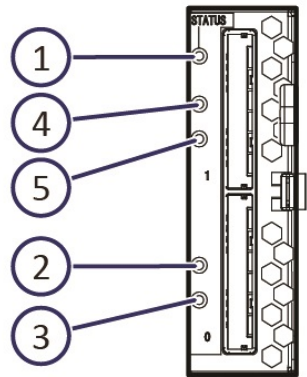

PCIe Cable Connector

Number	Item	Description
1	STATUS LED	Green: PCIe cable connector is powered on. Red: PCIe cable connector can be replaced safely. Off: PCIe cable connector is powered off.
2	Link Basic LED	Green: Basic PCIe Gen-3.0 (8-Gbps) is linked up normally. Off: Basic PCIe is not linked up (PCIe cable might not be connected). If a cable is connected, it can be removed safely.
3	InAct Basic LED	Amber: Basic PCIe status changed from link up to link down and cables. Cables can be removed safely. Off: Basic PCIe is normal or not set.
4	Link Option LED	Green: Option PCIe Gen-3.0 (8-Gbps) is linked up normally. Off: Option PCIe is not linked up (PCIe cable might not be

Number	Item	Description
		connected). If a cable is connected, it can be removed safely.
5	InAct Option LED	Amber: Option PCIe status changed from link up to link down and cables. Cables can be removed safely.  Off: Option PCIe is normal or not set.

## Host port expansion chassis power supply

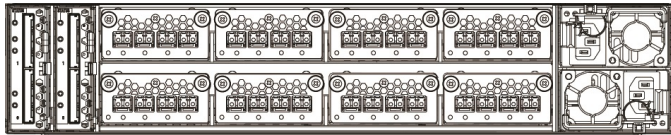

Rear View of the Expansion Chassis

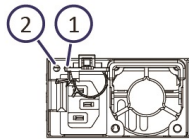

Expansion Chassis Power Supply 2

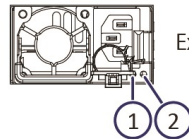

Expansion Chassis Power Supply 1

Number	Item	Description
1	ALM/RDY LED	Red: Host port expansion chassis power supply can be replaced safely.  Green: Normal operation.
2	AC IN LED	Blue: AC input is normal.



## NAS module

The NAS module provides communication ports to support file system protocols in a block- or file-system configuration.



**Note:** The NAS module is not supported on the VSP G200 storage system.

---

- [NAS Module Ports and LEDs](#)

## NAS Module Ports and LEDs

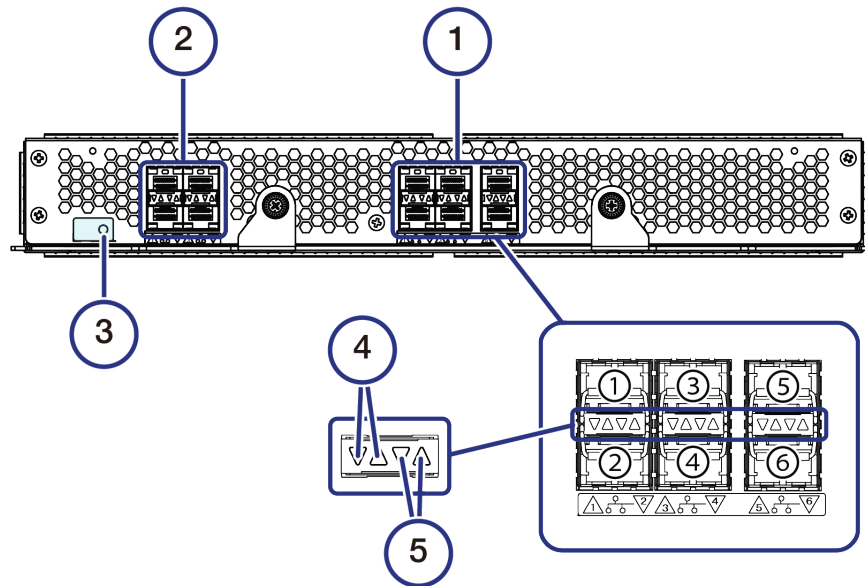

Legend	Name	Color	Description
1	User LAN port	-	This is used with the file level access.  <b>1.</b> Target group 1 <b>2.</b> Target group 2 <b>3.</b> Target group 3 <b>4.</b> Target group 4 <b>5.</b> Target group 5 <b>6.</b> Target group 6
2	Cluster port	-	Reserved for future use
3	Status LED	Green	NAS modules are functioning normally.
		Red	NAS modules can be removed.
4	Link LED	Blue	Displays link status.
5	Fail LED	Red	A failure has occurred.

## VSP service processor server

The VSP Gx00 models include a separate, dedicated 1U service processor (SVP) to host an element manager (Storage Navigator). The SVP (model number 3919435.P) operates independently from the CPU of the storage system and operating system, and provides out-of-band configuration and management of the storage system. The SVP also monitors and collects performance data for key components of the storage system to enable diagnostic testing and analysis for customer support.

The SVP is available as:

- A physical 1U management server provided by Hitachi Data Systems that runs Windows Embedded Standard 7.
- A software application that runs Windows 7 Professional x64 Service Pack 1 (64-bit) on a customer-supplied server hardware, a VMware ESXi host, or Linux KVM host.
- A software application that runs Microsoft Hyper-V Windows Server 2012 R2 on a customer-supplied server hardware running one of the following 64-bit operating systems:
  - Windows 10 Professional
  - Windows 10 Enterprise
  - Windows Server 2012
  - Windows Server 2012 R2

- [Service processor description](#)
- [SVP front panel](#)
- [SVP rear panel](#)
- [Service processor hardware specifications](#)

## Service processor description

The SVP provides four RJ-45 ports:

- Two ports connect to the storage system controllers (one port for each controller).
- One port connects to the IP network of the user.
- One port connects to a user-supplied management console PC.



**Note:** This product is also designed for IT power distribution systems with phase-to-phase voltage.

Three of the four RJ-45 ports (which connect to the controllers and the IP network) are configured as a bridge. The SVP can be addressed using the default IP address 192.168.0.15.

In the unlikely event you cannot connect to the SVP using the default IP address, use the following emergency login: `http://<default SVP IP address>/dev/storage/<model number><system serial number>/emergency.do`. For example:

Storage system model number	Storage system serial number	URL
8320004	456789	<code>http://192.168.0.15/dev/storage/8320004456789/emergency.do</code>
8340004	456789	<code>http://192.168.0.15/dev/storage/8340004456789/emergency.do</code>
8360004	456789	<code>http://192.168.0.15/dev/storage/8360004456789/emergency.do</code>

Users are responsible for adopting the appropriate security procedures with the SVP, including:

- Applying Windows security patches.
- Turning on automatic Windows updates or using the manual Windows update method.
- Installing antivirus software that has been tested and approved by Hitachi.

## SVP front panel

The front panel of the physical SVP is equipped with LEDs, a reset button, and a power button.



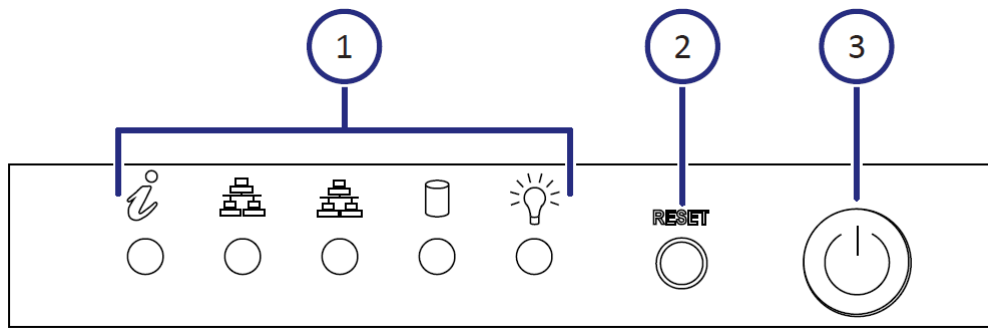

Number	Description
1	LEDs. From left to right, the LEDs are: <ul style="list-style-type: none"> <li>BMC Heartbeat</li> <li>LAN card 2</li> <li>LAN card 1</li> <li>Hard drive</li> <li>System standby power</li> </ul>
2	Reset button.
3	Power button. Applies power to or removes power from the SVP.

## SVP rear panel

The only ports used on the rear panel of the physical SVP are the power socket and the four LAN ports.

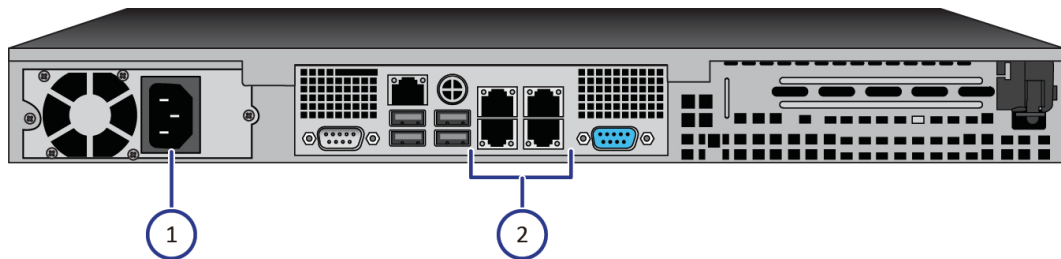

Number	Description
1	Power socket. Attach the power cable supplied with the SVP.
2	Four LAN ports arranged as follows: LAN3 LAN4 LAN1 LAN2

Number	Description
	These ports connect to your IP network, the management console PC, and the user LAN port on each storage system controller.



**Note:** After the Initial Startup Wizard is run, the SVP can be used in non-bridge mode. In this mode, the cables can be removed from SVP ports LAN3 and LAN4 and attached to switches. For more information, contact customer support.

## Service processor hardware specifications

The following table lists the hardware specifications for the service processor (SVP) provided by Hitachi Data Systems.



**Caution:** The SVP is not supported in high-temperature environments. Do not operate it in locations with temperatures of 40°C or higher.

Item	Specification
Dimensions	Height: 1.7 inches (43 mm) Width: 17.2 inches (437 mm) Depth: 14.5 inches (369 mm) Weight: 14 lbs (6.4 kg)
Processor	Celeron G1820 2.7-GHz 2M, 2C, 2T <ul style="list-style-type: none"> <li>• Cores: 2</li> <li>• Instruction set: 64-bit</li> <li>• SmartCache: 2 MB</li> <li>• Maximum memory size: 32 GB</li> <li>• Memory types: DDR3-1333, DDR3L-1333 @ 1.5V</li> </ul>
Memory	8-GB RAM DDR3
Hard drive	2 TB
Network interface card	x4 ports (on-board NIC) + x1 IPMI (BMC) port
Fans	2 x 4-cm 4-pin PWM fans
Operating system	Windows Embedded Standard 7

## Maintaining the storage system

Ongoing proper maintenance of the storage system maintains the reliability of the storage system and its constant availability to all hosts connected to it.

For more complex maintenance activities, contact customer support.

- [Storing the storage system](#)
- [Powering off the storage system](#)
- [Removing cables](#)

## Storing the storage system

If the storage system does not receive power for more than six months, the battery can become discharged and possibly damaged. To avoid this situation, charge the battery for more than three hours at least once every six months.



**Note:** Do not store the equipment in an environment with temperatures of 104°F (40°C) or higher because battery life will be shortened.

---

## Powering off the storage system

### Procedure

1. Press the main switch for three seconds until the `POWER` LED blinks.
2. Verify the `POWER` LED on the front of the storage system changes from green to amber.

Wait 25 minutes to 4 hours for the `POWER` LED to turn amber, depending on the system configuration (check after 33 minutes).

3. To stop the power supply, remove the power cables from the power supply units on the controller chassis and drive box.

If the storage system is connected to a PDU, you can stop the power supply by turning off the PDU breaker.



**Note:** If the storage system does not receive power for more than six months, the battery can become discharged and possibly damaged. To avoid this situation, charge the battery for more than three hours at least once every six months.

---

## Removing cables

Observe the following instructions when removing cables from the storage system.

To remove a SAS cable, pull the tab of the SAS cable (1) to release the latch and remove the SAS cable (2).

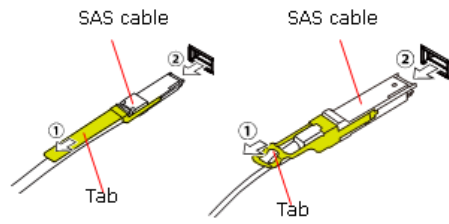

To remove an optical cable, push the top of the connector of the optical cable (1) to release the latch and remove the SAS cable (2).

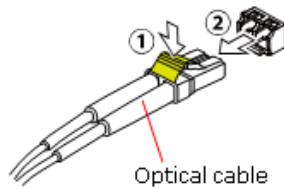

To remove a LAN cable, push the top of the LAN cable connector (1) to release the latch and remove the LAN cable (2).

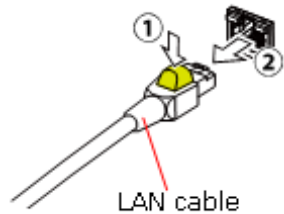



# Mechanical specifications for VSP G400, G600

The storage system mechanical specifications are described for VSP G400, G600 .

- [VSP G400 and VSP G600 mechanical specifications](#)

# VSP G400 and VSP G600 mechanical specifications

## Controller

Quantity	Component	Description
1	CBLM	A 4U controller chassis consisting of controllers, channel boards, disk boards, NAS module (optional), AC or DC power supplies, and batteries with cooling fans.

## Drive trays

Quantity	Component	Description
1	SFF drive tray	A drive tray that supports 2.5-inch disk drives and 2.5-inch flash drives. The drive tray consists of an ENC, cooling fans, and AC-DC power supplies or DC-DC power supplies.
1	LFF drive tray	A drive tray that supports 3.5-inch disk drives and 3.5-inch flash drives. The drive tray consists of an ENC, cooling fans, and AC-DC power supplies or DC-DC power supplies.
1	FMD tray	A drive tray that supports flash module drives and consists of an ENC and AC-DC power supplies equipped with built-in cooling fans.
1	Dense intermix drive tray	A drive chassis that supports a variety of drive types such as 2.5-inch drives, 3.5-inch drives, and flash drives. The chassis consists of an ENC and AC-DC power supplies equipped with built-in cooling fans.

## NAS module

Component	Description
NAS module	Optional component for block and file storage configuration



### Drive size

Component	Specification
2.5-inch drive (SFF)	3.21 x 8.10 x 0.74 inches (81.6 x 205.7 x 18.7 mm)
3.5-inch drive (LFF and dense intermix drive tray)	4 x 5.78 x 1.02 inches (101.6 x 147.0 x 26.1 mm)
Flash Module Drive (flash module drive tray)	5.74 x 14.44 x 0.78 inches (146 x 366.8 x 19.8 mm)

### Data capacity (GB)

Component	Specification
2.5-inch drive (SFF)	196.92, 288.20, 393.85, 472.61, 576.39, 945.23, 1152.79, 1729.29, 1890.46, 3780.92 GB
3.5-inch drive (LFF and dense intermix drive tray)	393.85, 1152.79, 1729.29, 3916.14, 5874.22, 9790.36 GB
Flash Module Drive (flash module drive tray)	1759.21, 3518.43 , 7036.87, 14073.74 GB

### Rotational speed (min<sup>-1</sup>)

Component	Specification
2.5-inch drive (SFF)	288.20 GB: 15,000 RPM 576.39 GB: 10,000 or 15,000 RPM 1152.79 GB: 10,000 RPM 1729.29 GB: 10,000 RPM
3.5-inch drive (LFF and dense intermix drive tray)	3916.14 GB: 7,200 RPM 5874.22 GB: 7,200 RPM 9790.36 GB: 7,200 RPM

### Maximum mountable quantity

Mixing SFF, LFF, FMD, and dense intermix drive trays might affect the maximum number of drives that can be mounted.

Component	Specification
SFF	24
LFF	12

Component	Specification
Flash module drive (flash module drive tray)	12
Dense intermix drive tray	60

### Battery specifications

Storage system intake temperature	CBLM
Up to 75.2° F (24° C)	5 years
Up to 86° F (30° C)	5 years
Up to 93.2° (34° C)	4 years
Up to 104° (40° C)	3 years

### Host interface

Item	Component	Specification
Interface type	Fibre Channel optical	8-Gbps, 16-Gbps, 32-Gbps
	iSCSI optical	10-Gbps
	iSCSI copper	10-Gbps
	NAS module	10-Gbps (Fibre Channel optical)
Data transfer speed (maximum speed for transfer to host)	Fibre Channel optical	800-Mbps (Fibre Channel)
		1600-Mbps (Fibre Channel)
		3200-Mbps (Fibre Channel)
	iSCSI optical	10-Gbps (iSCSI optical)
	iSCSI copper	10-Gbps (iSCSI copper)
	NAS module (Fibre Channel)	1000 Mbps
Number of ports	8-Gbps Fibre Channel optical	64
	16-Gbps Fibre Channel optical (2-port)	32
	16-Gbps Fibre Channel optical (4-port)	64
	32-Gbps Fibre Channel optical (4-port)	64
	10-Gbps optical iSCSI	32
	10-Gbps copper iSCSI	32
Number of ports (NAS Module not installed)	8-Gbps Fibre Channel optical	64
	16-Gbps Fibre Channel optical (2-port)	32
	16-Gbps Fibre Channel optical (4-port)	64

Item	Component	Specification
	32-Gbps Fibre Channel optical (4-port)	64
	10-Gbps optical iSCSI	32
	10-Gbps copper iSCSI	32
Number of ports (NAS Module installed)	8-Gbps Fibre Channel optical	24
	16-Gbps Fibre Channel optical (2-port)	12
	16-Gbps Fibre Channel optical (4-port)	24
	32-Gbps Fibre Channel optical (4-port)	24
	10-Gbps optical iSCSI	12
	10-Gbps copper iSCSI	12
	10-Gbps Fibre Channel optical	12
Transferred block size		512 bytes
Maximum number of hosts using a Fibre Channel switch		255
Maximum number of hosts using a network switch		255

## RAID specifications

D: Data drive, P: Parity drive.

Although the storage system with a configuration of RAID 1, RAID 5, or RAID 6 provides data reliability enhanced by redundancy, there is a chance that user data could be lost due to an unexpected host, storage system hardware, or software failure. Therefore, users are requested to back up all data.

RAID Level	SAS, SAS 7.2k, flash drives mounted
RAID 1	2D+2D, 4D+4D
RAID 5	3D+1P, 4D+1P, 6D+1P, 7D+1P
RAID 6	6D+2P, 12D+2P, 14D+2P

Item	Specification
Maximum number of RAID groups	VSP G400:160 VSP G600:240
Maximum volume size	3 TB (or 4 TB when using the LDEVs of other storage systems)
Maximum volumes/host groups and iSCSI targets	2048
Maximum number of volumes per RAID group	2048

## Shared memory and data assurance

Item	Specification
Flash memory	32 MB
L3 Cache memory	4 MB
SDRAM	1 GB
Data bus	Parity
Cache memory	ECC (1 bit for correction, 2 bits for detection)
Drive	Data assurance code

## Start-up time

Item
<p>Standard: 5-to-8 minutes.</p> <p>The start-up time may be longer in proportion to the number of drive trays connected. With a maximum configuration 1 controller tray and 19 drive trays, start-up time is approximately 8 minutes.</p>

## Chassis size

Component	Specification (WxDxH)
CBLM	19.01 x 35.10 x 6.86 inches (483 x 891.7 x 174.3 mm)
SFF/LFF	18.97 x 22.24 x 3.47 inches (482 x 565 x 88.2 mm)
DBF	19.01 x 30 x 3.42 inches (483 x 762 x 87 mm)
Dense intermix drive tray	18.97 x 40.51 x 6.92 inches (482 x 1,029 x 176 mm) (includes the depth of the cable-management arms)

## Mass

The table lists the values of a maximum configuration when all controllers and drives are mounted.

Component	Specification
CBLM	187.39 pounds (85 kg)
SFF	Approx 50.70 inches (23 kg)
LFF	Approx 59.52 inches (27 kg)
DBF	Approx. 83.77 pounds (38 kg)

Component	Specification
Dense intermix drive tray	Approx. 198.41 pounds (90 kg)

### Required height

Component	Specification
CBLM	4 U
SFF	2 U
LFF	2 U
DBF	2 U
Dense intermix drive tray	4 U If a drive is inserted into a slot of a dense intermix drive tray when the installed number of drives exceeds 240 slots per path, the drive is blocked.

### Cache specifications

Item	Specification
Capacity (GB)	VSP G400: 128 VSP G600: 256
NAS module Cache Capacity	DDR3 DIMM 8GB x 12 [Slot] Note: <ul style="list-style-type: none"> <li>All 12 slots must be fully installed with DIMMs.</li> <li>Each DIMM is replaceable when they fail.</li> <li>The DIMM is not common and cannot be used with DKC DIMM.</li> </ul>
Control method	Read LRU, Write after
Battery backup	Provided
Backup duration	Unrestricted (saving to a nonvolatile memory)

Data in the cache memory is preserved against power failures. If a power outage occurs, data in cache memory is written to drives.

When the storage system enters Cache Backup mode, the amber **WARNING** LED goes on to when the system starts. This warning indicates that the battery charge has dropped significantly and the remaining battery capacity is not sufficient; the storage system will continue operating with the Write Cache function disabled.

When the battery is charged, the warning indication disappears, and the storage system continues the operation in the Write Cache function.

The warning indication disappears within six hours. Even when the warning is shown, normal operation is assured in Write-Through. Read and write performance is lowered because the Write Cache function is disabled.

If the storage system is not charged for more than six months, the battery can become overcharged and sustain unrecoverable damage. To avoid this situation, charge the battery more than 3 hours every six months.

### **Insulation performance**

<b>Item</b>	<b>Specification</b>
Insulation withstand voltage	AC 1,500 V (100 mA, 1 min)
Insulation resistance	DC 500 V, 10 M $\Omega$ or more

# Electrical specifications for VSP G400, G600

The electrical specifications are described for the storage systems.

- [Electrical specifications](#)

## Electrical specifications

Item	Controller	Drive tray
Input voltage (operable voltage range) (V)	AC 200-240 +6%/-11%	SFF, LFF, FMD, and dense intermix drive tray: AC 200-240 +6%/-11%
Frequency (Hz)	50/60 ±1	
Number of phases, cabling	Single-phase with protective grounding	
Steady-state current 100V/200V <sup>1, 2</sup>	CBLM: 4.0x2	SFF drive tray: 2.4x2/1.2x2 LFF drive tray: 1.9x2/1.0x2 FMD drive tray: 2.6x2/1.3x2 Dense intermix drive tray: -/3.0x2
Current rating of breaker/fuse (A)	16.0 (each electrical)	
Heat value (normal) (kJ/h)	CBLM: 2160 or less	SFF drive tray: 1120 or less LFF drive tray: 940 or less FMD drive tray: 1520 or less Dense intermix drive tray: 3460 or less
Steady-state power (VA/W) <sup>3</sup>	CBLM: 1600/1560 or less	SFF drive tray: 480/460 or less LFF drive tray: 380/350 or less FMD drive tray: 520/490 or less Dense intermix drive tray: 1200/1160 or less
Power consumption (VA/W)	CBLM: 640/600 or less	SFF drive tray: 320/310 or less LFF drive tray: 280/260 or less FMD drive tray: 440/420 or less Dense intermix drive tray: 1000/960 or less
<p><b>Notes:</b></p> <ol style="list-style-type: none"> <li>1. The power current of Nx2 described in this table is required for a single power unit.</li> <li>2. If one power unit fails, another power unit requires electric current for the two power units. Therefore, plan the power supply facility so that the current-carrying capacity for one power unit can provide the total capacity for two power units.</li> <li>3. This table shows the power requirement (100 V or 200 V) for the maximum configuration . The actual required power might exceed the value shown in the table when the tolerance is included.</li> </ol>		





# Environmental specifications for VSP G400, G600

The environmental specifications are described for the storage systems.

- [Environmental specifications](#)

# Environmental specifications

## Temperature



**Caution:** The following VSP Gx00/Fx00 storage system components are not supported in high-temperature environments. Do not operate the following components at temperatures of 40°C or higher:

- DB60 dense drive tray
- HDS provided service processor (SVP) server
- First-generation FMDs (non-DC2 FMDs)

State	Controller	SFF, LFF drive trays	Dense intermix drive tray
Operating	50°F to 104°F (10°C to 40°C)	50°F to 104°F (10°C to 40°C)	50°F to 95°F (10°C to 35°C)
Non-operating	14°F to 122°F (-10°C to 50°C)	14°F to 122°F (-10°C to 50°C)	14°F to 122°F (-10°C to 50°C)
Transport, storage	-22°F to 140°F (-30°C to 60°C)	-22°F to 140°F (-30°C to 60°C)	-22°F to 140°F (-30°C to 60°C)
Temperature change rate (°C/h)	10 or less		

State	Controller	FMD drive trays
Operating	50°F to 104°F (10°C to 40°C)	DKC-F710I-1R6FM or DKC-F710I-3R2FM drive is installed: 50°F to 95°F (10°C to 35°C)
Operating	50°F to 104°F (10°C to 40°C)	DKC-F810I-1R6FN/3R2FN/6R4FN/7R0FP/14RFP drive is installed: 50°F to 104°F (10°C to 40°C)
Non-operating	14°F to 122°F (-10°C to 50°C)	14°F to 95°F (-10°C to 35°C)
Transport, storage	-22°F to 140°F (-30°C to 60°C)	-22°F to 122°F (-30°C to 50°C)
Temperature change rate (°C/h)	10 or less	

## Humidity

State	Percentage
Operating	8 to 80

State	Percentage
Non-operating	8 to 90
Transport, storage (%)	5 to 95
Maximum wet bulb temperature (°C)	29 (non-condensing)

## Vibration

State	m/s <sup>2</sup>
Operating	2.5 or less Within 5 seconds (resonance point: 10 Hz or less)
Non-operating	5.0 or less at 5 Hz to 300 Hz (no damage to product) 9.8 (1.0 G) Within 5 seconds (resonance point: 10 Hz or less)
Transport (packed)	5.0 or less

## Impact

State	m/s <sup>2</sup>
Operating	20 or less (10 ms, half sine wave)
Non-operating	50 or less (10 ms, half sine wave)
Transport (packed)	80 or less

## Altitude

State	Controller	FMD drive
Operating (m)	3,000 (Environmental temperature: 10°C to 32°C)  900 (Environmental temperature: 10°C to 40°C)	3,000 (Environmental temperature 10°C to 32°C)  OR  900 (Environmental temperature: 10°C to 35°C) when DKC-F710I-1R6FM or DKC-F710I-3R2FM drive is installed.
Operating (m)	3,000 (Environmental temperature: 10°C to 32°C)	3,000 (Environmental temperature: 10°C to 32°C)  OR

State	Controller	FMD drive
	900 (Environmental temperature: 10°C to 40°C)	900 (Environmental temperature: 10°C to 40°C) when DKC-F810I-1R6FN/3R2FN/6R4FN/7R0FP/14RFP drive is installed.
Non-operating (m)	-60 to 12,000	N/A

State	Controller	SFF and LFF drives	Dense intermix drive tray
Operating (m)	3,000 (Environmental temperature: 10°C to 32°C)	3,000 (Environmental temperature: 10°C to 32°C)	3,000 (Environmental temperature: 10°C to 28°C)
	900 (Environmental temperature: 10°C to 40°C)	900 (Environmental temperature: 10°C to 40°C)	1,000 (Environmental temperature: 10°C to 35°C)
Non-operating (m)		N/A	

## Atmosphere

Avoid areas exposed to corrosive gas and salty air.

## Acoustic Noise

State	Controller	SFF, LFF	Dense intermix drive tray
Operating	60 dB (Environmental temperature 32°C or less) <sup>1</sup>	60 dB (Environmental temperature 32°C or less) <sup>1</sup>	71 dB (Environmental temperature 32°C or less) <sup>1, 2, 3, 4</sup>
Non-operating	55 dB	55 dB	71 dB (Environmental temperature 32°C or less) <sup>1, 2, 3, 4</sup>
<b>Notes:</b> <ol style="list-style-type: none"> <li>The system's internal temperature controls the rotating speed of the fan module. Therefore, this standard value might be exceeded if the maximum load continues under high-temperature environment or if a failure occurs in the system.</li> <li>Sound pressure level (LA) changes from 66 dB or 75 dB, according to the ambient temperature, drive configuration, and operating status. Maximum volume can reach 79 dB during maintenance procedure for a failed ENC or power supply.</li> <li>Acoustic power level (LWA) measured by the ISO 7779 standard is 7.2 B. This value changes from 7.2 B to 8.1 B, according to the ambient temperature, drive configuration, and operating status.</li> <li>When accessing the dense intermix drive tray, do not work for long times at the rear of the rack.</li> </ol>			

State	Controller	FMD	
Operating	60 dB (Environmental temperature 32°C or less) <sup>1</sup>	60 dB (Environmental temperature 32°C or less) <sup>1, 2, 3</sup>  (When accessing the dense intermix drive tray, do not work for long times at the rear of the rack.)	
Non-operating	55 dB (Environmental temperature 32°C or less) <sup>1, 2, 3, 4</sup> 55 dB		
<p><b>Notes:</b></p> <ol style="list-style-type: none"> <li>1. The system's internal temperature controls the rotating speed of the fan module. Therefore, this standard value might be exceeded if the maximum load continues under high-temperature environment or if a failure occurs in the system.</li> <li>2. Sound pressure level (LA) changes from 66 dB or 75 dB, according to the ambient temperature, drive configuration, and operating status. Maximum volume can reach 79 dB during maintenance procedure for a failed ENC or power supply.</li> <li>3. Acoustic power level (LwA) measured by the ISO 7779 standard is 7.2 B. This value changes from 7.2 B to 8.1 B, according to the ambient temperature, drive configuration, and operating status.</li> </ol>			





## iSCSI standards and specifications

The following tables describe the standards and specifications for using iSCSI in a hosting environment.

- [iSCSI standards](#)
- [iSCSI specifications](#)

## iSCSI standards

The following standards apply to the management, maintenance, and iSCSI data ports. To configure this system, use switches that comply with the following standards:

- IEEE 802.1D STP
- IEEE 802.1w RSTP
- IEEE 802.3 CSMA/CD
- IEEE 802.3u Fast Ethernet
- IEEE 802.3z 1000 BASE-X
- IEEE 802.1Q Virtual LANs
- IEEE 802.3ae 10 Gigabit Ethernet
- RFC 768 UDP
- RFC 783 TFTP
- RFC 791 IP
- RFC 793 TCP
- RFC 1157 SNMP v1
- RFC 1231 MIB II
- RFC 1757 RMON
- RFC 1901 SNMPv2

## iSCSI specifications

Item	Specification	Comments
iSCSI target function	Supported	N/A
iSCSI target function	Supported	TrueCopy® only
iSCSI ports	2 per interface board	VSP Gx00 models: Maximum 32 per iSCSI system
Connection methods	Direct and switch connections	
Host connections	255 (maximum per iSCSI port)	With Linux software initiator, the maximum number decreases.
Path failover	HDLM <sup>1</sup>	Supports Microsoft MPIO (Multi Path I/O)
Link	10 Gbps SFP+	N/A
Transfer speed	10 Gbps	N/A
Connector type	LC	N/A
Cable	Optical OM3, OM2 MMF cable	N/A
Network switch	L2 or L3 switch	Should comply with IEEE802.3ae



Item	Specification	Comments
Switch cascading	Maximum: 5 switches or fewer	Minimum number of cascading switches is recommended.
MAC address	Per port (fixed value)	Factory setting: World Wide Unique value. Cannot be changed.
Maximum transfer unit (MTU)	1,500, 4,500, 9,000 bytes (Ethernet frame)	Jumbo frame, MTU size greater than 1500
Link aggregation	Not supported	N/A
Tagged VLAN	Supported	N/A
IPv4	Supported	N/A
IPv6	Supported	Note the following precautions: <ul style="list-style-type: none"> <li>When iSCSI Port IPv6 is set to Enabled, if the IPv6 global address is set to automatic, the address is determined by acquiring a prefix from an IPv6 router.</li> <li>If the IPv6 router does not exist in the network, the address cannot be determined. As a result, an iSCSI connection might be delayed. When an iSCSI Port IPv6 is set to Enabled, verify the IPv6 router is connected to the same network, and then set IPv6 global address automatically.</li> </ul>
Subnet mask	Supported	N/A
Gateway address	Supported	N/A
DHCP	N/A	N/A
DNS	N/A	N/A
Ping (ICMP ECHO) Transmit, Receive	Supported	N/A
IPsec <sup>2</sup>	N/A	N/A
TCP port number	3260	Changeable among 1 to 65,535. Observe the following if changing values: <ul style="list-style-type: none"> <li>The setting of the corresponding host should also be changed to log in the new port number.</li> <li>The new port number might conflict with other network communication or be</li> </ul>

Item	Specification	Comments
		filtered on some network equipment, preventing the storage system from communicating through the new port number.
iSCSI name	Both iqn <sup>3</sup> and eui <sup>4</sup> types are supported	The unique iqn value is automatically set when a target is made. iSCSI name is configurable.
Error recovery level	0 (zero)	Error recovery by retrying from host. Does not support Level 1 and Level 2.
Header digest	Supported	Detects header error or data error with iSCSI communication. The storage system follows the host's digest setting. If digest is enabled, the performance degrades. The amount of the degradation depends on factors such as host performance of host and transaction pattern.
Data digest	Supported	
Maximum iSCSI connections at one time	255 per iSCSI port	N/A
CHAP	Supported	Authentication: login request is sent properly from host to storage. CHAP is not supported during discovery session.
Mutual (2-way) CHAP	Supported (not available if connected to Linux software initiator)	Authentication: login request is sent properly from host to storage.
CHAP user registration	Max 512 users per iSCSI port	N/A
iSNS	Supported	With iSNS (name service), a host can discover a target without knowing the target's IP address.
<p><b>Note:</b></p> <ol style="list-style-type: none"> <li>1. JP1, HiCommand Dynamic Link Manager. Pass switching is achieved. Not supported on Windows Vista and Windows 7 operating systems.</li> <li>2. IP Security. Authentication and encryption of IP packets. The storage system does not support IPsec.</li> <li>3. iqn: iSCSI Qualified Name. The iqn consists of a type identifier, "iqn," a date of domain acquisition, a domain name, and a character string given by the individual who acquired the domain. Example: <a href="#">iqn.1994-04.jp.co.hitachi:rsd.d7m.t.10020.1b000.tar</a></li> <li>4. eui: 64-bit Extended Unique Identifier. The eui consists of a type identifier, "eui," and an ASCII-coded, hexadecimal, EUI-64 identifier. Example: <a href="#">eui.0123456789abcdef</a></li> </ol>		



## Replacement parts

Part replacement is essential for maintaining the high performance of the system. Replacing system components is covered by the maintenance service contract.

- [Battery unit](#)

## Battery unit

### Replacement period

Three years.

### Treatment

Use the storage system in a place where the ambient temperature is 86°F (30°C) or less on average.

Periodic parts replacement is required. For customers with maintenance service contracts, parts are replaced periodically in keeping with the terms of the contract.



**Note:** The battery protects the data in the cache memory in an emergency, such as a sudden power failure. In these cases, follow the normal power down procedure. If not, the battery might reach its lifespan earlier than expected and become unusable within three years. When replacing the battery, follow the given procedure for disposing a used battery.

---



## Data and power cables

The storage system supports a variety of data and power cables for specific hosting environments.

- [Fibre Channel cables](#)
- [iSCSI cables](#)
- [Managing data cables](#)
- [AC power cables](#)

## Fibre Channel cables

When constructing a system with the direct connection or Fibre Channel switch connection, consider the following:

- If you connect a storage system to a FC host adapter through a switch, set Fabric = ON and set to Point-to-Point.
- If you connect a storage system directly to FC host adapter with the following fabric topology:
  - For 2, 4 or 8 Gbps, set the storage port to Fabric = OFF and Connection Type FC-AL (Fibre Channel Arbitrated Loop).
  - For 16 or 32 Gbps, set the storage port to Fabric = OFF and Connection Type P-to-P (Point-to-Point).

For the 8-Gbps Fibre Channel ports, the combinations between data-transfer speeds and connection types are as follows:

Connection type	Data transfer speeds for 8-Gbps ports			
	2 Gbps	4 Gbps	8 Gbps	Auto
FC-AL	Available	Available	Available	Available (default)
P-to-P	Available	Available	Available	Available
Fabric	Available	Available	Available	Available

For the 16-Gbps Fibre Channel ports and for 16-Gbps SFP added to the 4-port FC 32-Gbps package, the combinations between data-transfer speeds and connection types are as follows:

Connection type	Data transfer speeds for 16-Gbps ports/SFPs					
	2 Gbps	4 Gbps	8 Gbps	16 Gbps	32 Gbps	Auto
FC-AL	No available	Available	Available	Not available	Not available	Available <sup>1</sup>
P-to-P	No available	Available	Available	Available	Not available	Available (default <sup>2</sup> )
Fabric	Available	Available	Available	Available	Not available	Available
<b>Notes:</b>						
1. If this combination is specified, the maximum transfer speed automatically specified is 8 Gbps.						
2. If this default value is set, Fabric is set to ON automatically.						



**Note:** To connect to the server by the 16-Gbps direct connection, the Fabric Emulation function of the Hitachi host adapter is required.

For the direct connection using the Fabric Emulation function, set the Fabric setting of the Fibre Channel port of the Storage System to ON.

For the 32-Gbps SFP added to the 4-port FC 32-Gbps package, the combinations between data-transfer speeds and connection types are as follows:

Connection type	Data transfer speeds for 32-Gbps ports					
	2 Gbps	4 Gbps	8 Gbps	16 Gbps	32 Gbps	Auto
FC-AL	No available	No available	Available	Not available	Not available	Available <sup>1</sup>
P-to-P	No available	No available	Available	Available	Available	Available (default <sup>2</sup> )
Fabric	Available	Available	Available	Available	Available	Available

**Notes:**

1. If this combination is specified, the maximum transfer speed automatically specified is 8 Gbps.
2. If this default value is set, Fabric is set to ON automatically.



**Note:** The five Hitachi FC HBAs also have an alternate option of Fabric Emulation. When the HBA is configured to use this mode, treat it as an attached switch and set the storage port to Fabric = On and Connection Type = P-to-P.

- Due to high-speed serial data transfer is performed via Fibre Channel, use high-quality Fibre Channel cables that comply with the Fibre Channel-PH standard.

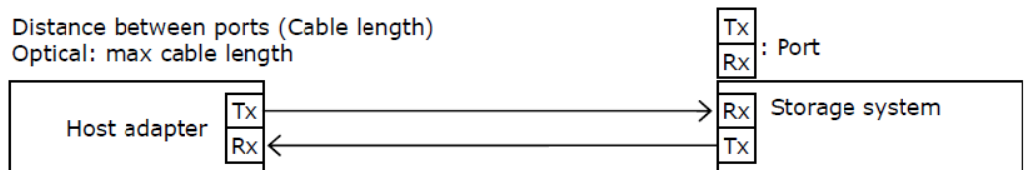

(a) Direct Connection

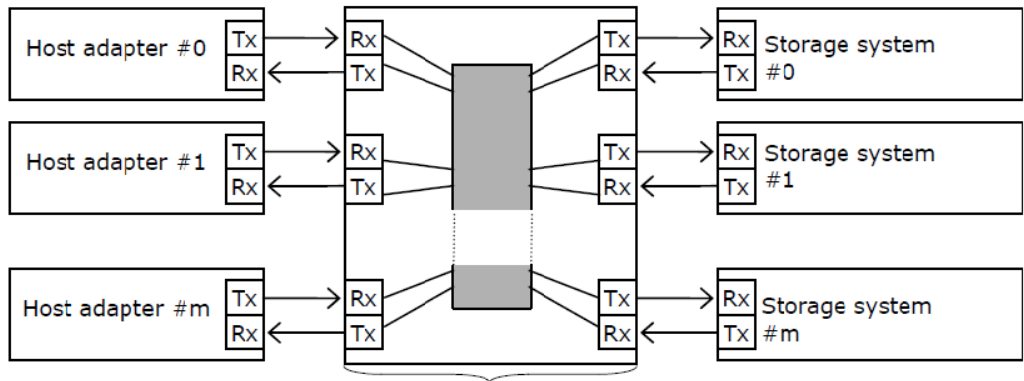

(b) Fibre Channel Switch Connection

Data transfer rate	Maximum length of cable			
	Multimode cable			Single mode cable
	OM2	OM3	OM4	
2 Gbps	984.25 ft (300 m)	1640.4 ft (500 m)	—	3280.8 ft (10 km)
4 Gbps	493 ft (150 m)	1246.72 ft (380 m)	1312.3 ft (400 m)	
8 Gbps	164.04 ft (50 m)	493 ft (150 m)	623.36 ft (190 m)	
16 Gbps	114.8 ft (35 m)	328.08 ft (100 m)	410.1 ft (125 m)	—
32 Gbps	65.62 ft (20 m)	229.7 ft (70 m)	328.08 ft (100 m)	—

The following table lists specifications of the Fibre Channel interface cable.

Cable type	Interface	Cable mode name	Nominal		
			Cable	Connector	
				One side	Other side
LC-LC cable (shortwave)	Optical	Equivalent to DXLC-2P-PC-xxM-GC50, 125-2SR (OMx)	50, 125 μm, 62.5, 125 μm Multimode Wavelength: 850 nm	LC connector	LC connector



Cable type	Interface	Cable mode name	Nominal		
			Cable	Connector	
				One side	Other side
LC-LC cable (longwave)		DXLC-2PS-SPC-xxM-SMC 10/125-2SR	9/125 $\mu$ m Singlemode Wavelength: 1300 nm		

The following figure shows the connector used for optical interfaces.

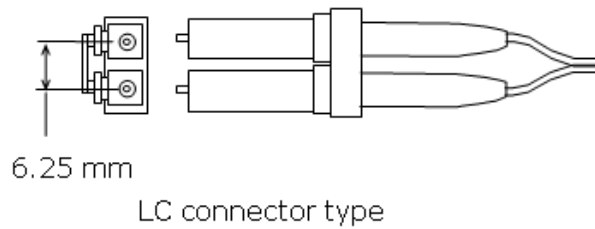

The following figure shows the type of optical connector that connects the storage system Fibre Channel ports.

- LC connector type
- **Connector type:** LC duplex receptacle connector
- **Interval:** 6.25 mm flat type, two rows

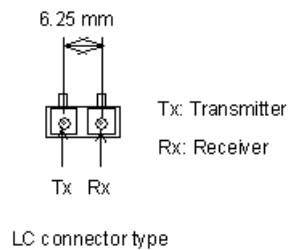

## iSCSI cables

When constructing an iSCSI system with a direct connection or switch connection, consider the following:

Data transfer rate	Maximum length of cable			
	Multimode cable			Single mode cable
	OM2	OM3	OM4	
10 Gbps (FCoE)	269.02 ft (82 m)	984.25 ft (300 m)	1804.46 ft (550 m)	—

### Cable specifications for iSCSI optical interface

Cable type	Interface	Cable mode name	Cable	Nominal	
				Connector	
				One side	Other side
LC-LC cable	Optical	Equivalent to DXLC-2P-PC-xxM-GC50, 125-2SR (OMx)	50, 125 mm Multimode Wavelength: 850 nm	LC connector	LC connector

The following figure shows the connector used for optical interfaces.

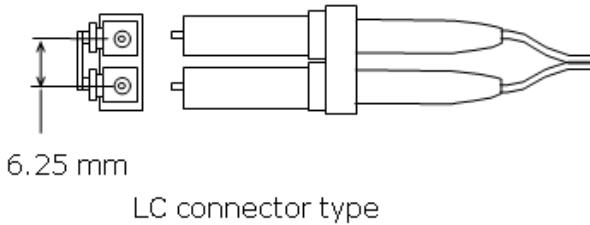

The following figure shows the type of optical connector that connects the storage system optical iSCSI ports.

- LC connector type
- **Connector type:** LC duplex receptacle connector
- **Interval:** 6.25 mm flat type, two rows

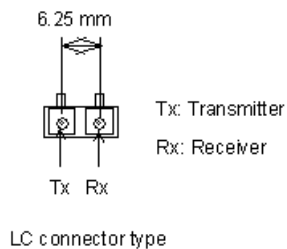

## Cable specifications for 10 Gbps iSCSI copper interface

Cable type	Maximum cable connection length	Data transfer	Transmission band	Cable	Connector
Category 5e or 6a LAN cable	100 m	1 Gbps	1000BASE-T	STP ( use an STP cable that suppresses radio noise)	RJ-45
Category 6a LAN cable	50 m	10 Gbps	10GBASE-T	STP ( use an STP cable that suppresses radio noise)	RJ-45

The following figure shows a 10 Gbps iSCSI cable.

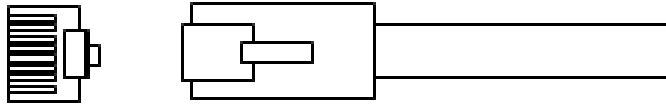

## Managing data cables

Organize data cables to protect the integrity of your connections and allow proper airflow around your storage system.

### Observing bend radius values

Never bend cables beyond their recommended bend radius. The following table provides general guidelines for minimum bend radius values, but you should consult the recommendation of your cable manufacturer.

Cable type	Minimum bend radius values
Fibre Channel	1.73 inch (40 mm)
iSCSI optical	1.73 inch (40 mm)
Category 5 Ethernet	Four times the outside diameter of the cable
SAS	1.73 inch (40 mm)

### Protecting cables

Damage to your Fibre Channel and Ethernet cables can affect the performance of your storage system. Observe the following guidelines to protect cables

- Keep cables away from sharp edges or metal corners.
- When bundling cables, do not pinch or constrict the cables.
- Do not use zip ties to bundle cables. Instead, use Velcro hook-and-loop ties that do not have hard edges and which you can remove without cutting.
- Never bundle network cables with power cables. If network and power cables are not bundled separately, electromagnetic interference (EMI) can affect your data stream.
- If you run cables from overhead supports or from below a raised floor, include vertical distances when calculating necessary cable lengths.
- If you use overhead cable supports:
  - Verify that your supports are anchored adequately to withstand the weight of bundled cables.
  - Gravity can stretch and damage cables over time. Therefore, do not allow cables to sag through gaps in your supports.
  - Place drop points in your supports that permit cables to reach racks without bending or pulling.

### Cabling full-width modules

When cabling full-width modules, such as NAS modules as shown in the following figure, route the cables horizontally, so that they do not interfere when replacing a module.

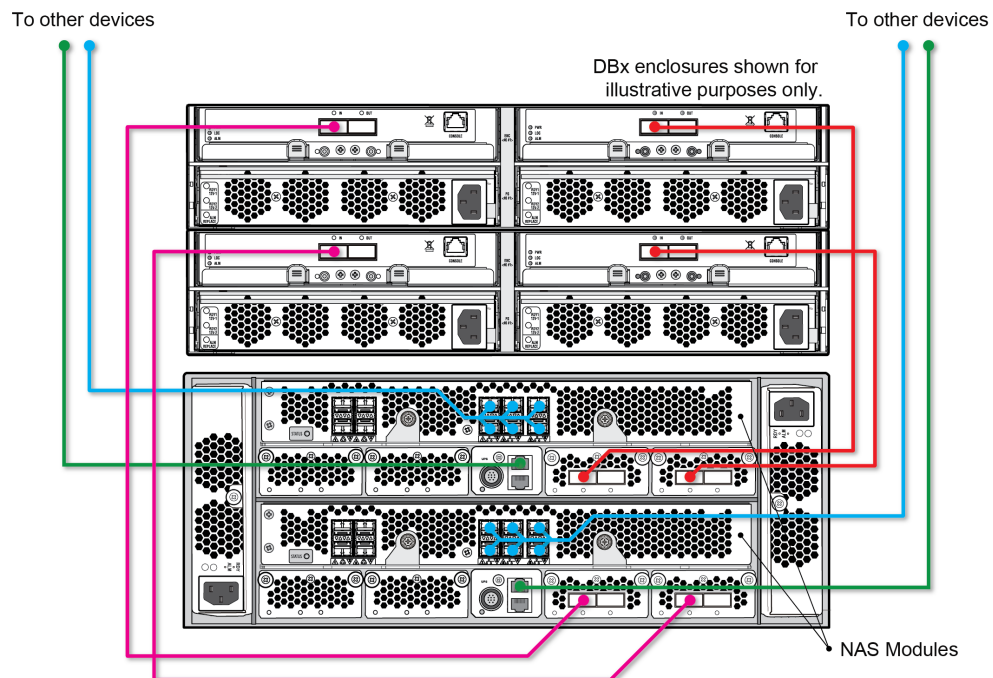

## Ensuring adequate airflow

Bundled cables can obstruct the movement of conditioned air around your storage system.

- Secure cables away from fans.
- Keep cables away from the intake holes at the front of the storage system.
- Use flooring seals or grommets to keep conditioned air from escaping through cable holes.

## Preparing for future maintenance

Design your cable infrastructure to accommodate future work on the storage system. Give thought to future tasks that will be performed on the storage system, such as locating specific pathways or connections, isolating a fault, or adding or removing components.

- Purchase colored cables or apply colored tags.
- Label both ends of every cable to denote the port to which it connects.

## AC power cables

Utility AC power standards for connector types and voltage levels vary by country. Hitachi provides a variety of power cables that facilitate using storage systems around the world. Hitachi power cables meet the safety standards for the country for which they are intended.

## Power cable assemblies

For information about racks and power distribution units (PDUs), refer to the *Hitachi Universal V2 Rack Reference Guide*.

Hitachi power cables consist of three parts:

- **Plug:** Male connector for insertion into the AC outlet providing power. The physical design and layout of the plug's contact meet a specific standard.
- **Cord:** Main section of insulated wires of varying length, whose thickness is determined by its current rating.
- **Receptacle:** Female connector to which the equipment attaches. The physical design and layout of the receptacle's contacts meet a specific standard. Common standards are the IEC C13 receptacle for loads up to 10 amperes (A) and the IEC C19 receptacle for loads up to 15 A.

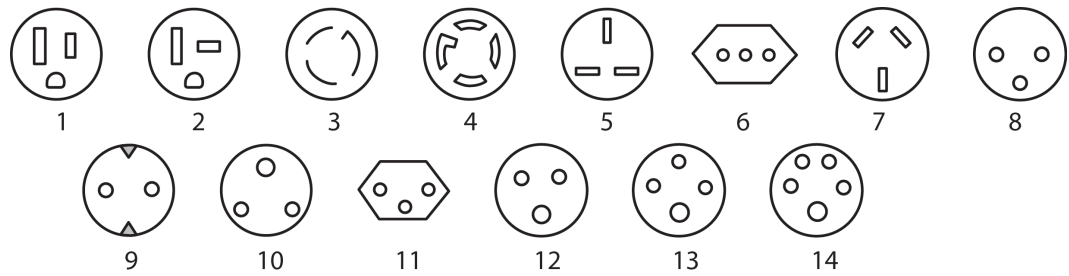

Number	Country or region	Voltage rating (VAC)	Current rating (amperes)	Plug type
1 <sup>1</sup>	North America	100-127	15	NEMA 5-15P
	Brazil	200-240	10, 20	NEMA 5-15P
	Japan	100-127	12	JIS C8303
	Taiwan	100-127	12, 16	CNS 690
2	North America	100-127	20	NEMA 5-20P
3	North America	200-240	20	NEMA L6-20P
3	North America	200-240	30	NEMA L6-30P
4 <sup>2</sup>	North America	200-240	30	NEMA L15-30P
5 <sup>3</sup>	Hong Kong	200-240	13	BS-1363
	Singapore	200-240	13	BS-1363
6	Chile	200-240	10, 16	CEI 23-50
	Italy	200-240	10, 16	CEI 23-50
7	Argentina	200-240	10, 15	IRAM 2073
	Australia	200-240	10, 15	AS-3112
	China	200-240	10, 16	GB-1002
	New Zealand	200-240	10, 15	AS-3112
8	Denmark	200-240	10	DK 2-5
	Israel	200-240	10, 16	SI-32
9 <sup>4</sup>	Europe	200-240	CEE 7, 7	
10 <sup>5</sup>	India	200-240	6, 16	IS-1293
	South Africa	200-240	10, 16	SABS-164
11	Switzerland	200-240	10	SEV 1011
12 <sup>6</sup>	International	200-240	20	IEC 309
13 <sup>7</sup>	United Kingdom	200-240	13	BS-1363
	International	200-240	20	IEC 309
14 <sup>8</sup>	International	200-240	30	IEC 309
<b>Notes:</b>				
1. Also used for 200-240 VAC applications in Korea and Philippines.				
2. Three-phase AC.				
3. Also Malaysia and Ireland.				
4. Also known as "Schuko" connector and used in Austria, Belgium, Finland, France, Germany, Greece, Hungary, Indonesia, Netherlands, Norway, Poland, Portugal, Russia, Spain, and Sweden.				

Number	Country or region	Voltage rating (VAC)	Current rating (amperes)	Plug type
5.				Supersedes type BS 546.
6.				3-wire (two-phase and earth). Physical variations (connector size and color) indicate amperage rating. Used in Switzerland for a true 16 A application.
7.				4-wire (three-phase and earth). Physical variations (connector size and color) indicate amperage rating.
8.				5-wire (three-phase, earth and neutral). Physical variations (connector size and color) indicate amperage rating.

## AC connections

The following table shows and describes the types of AC connections on your storage system.

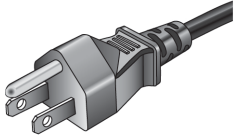
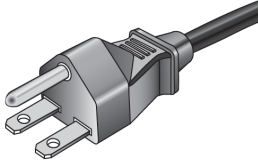
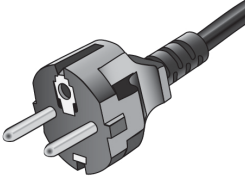
Description	Receptacle (male end)	Input rating	Reference standards
NEMA 5-15P		100V-120V (standard attachment)	1 ANSI C73.11 2 NEMA 5-15P 3 IEC 83
NEMA L6-20P		200V-240V	1 ANSI C73.11 2 NEMA 6-15P 3 IEC 83
CEE 7/7		200V-240V	4 CEE (7) II, IV, VII 3 IEC 83
BS-1363		200V-240V	5 BS 1365 3 IEC 83

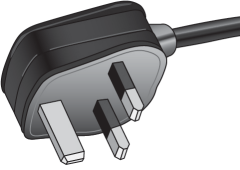
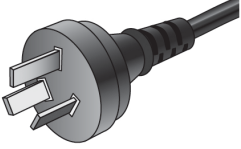
Description	Receptacle (male end)	Input rating	Reference standards
			
AS-3112		200V-240V	6 AS C112

## Power cable usage guidelines

Hitachi storage systems are intended for rack installation and ship with power cords. Installation and service requirements may require additional cords and cables to be ordered. The type of power cable required by a given installation is determined primarily by the:

- Type of AC line feed provided by the facility.
- Type of AC source (wall outlet or modular and monitored PDU) to be used.
- Serviceability of components to be connected.

Storage systems require a country-specific power cable for direct connection to a facility AC feed.

Storage systems are designed to allow replacement of hot-pluggable components without removing the chassis from the rack. As a result, power cables can be short because cable movement is of minimal consideration.

## Three-phase power considerations for racks

Increasing power requirements for racks are making the use of three-phase power at the rack level compelling.

- With single-phase power, at any given time the voltage across the hot and neutral conductors can be anywhere between its peak (maximum) and zero. Electrical conductors must be large to meet high amperage requirements.
- Three-phase power uses three cycles that are 120 degrees out of phase, which never allows the voltage to drop to zero. The more consistent voltage derived from the three hot conductors results in smoother current flow and allows small-gauge conductors to be used to distribute the same amount of AC power. As a result, the load balancing and increased power



handling capabilities of three-phase distribution can result in more efficient and less costly installations that require fewer AC cables and PDUs.



## Cable management

Rack installations should be planned for operational efficiency, ease of maintenance, and safety. Hitachi offers the Backend Configuration Utility (BECK), a graphical, cable-management application that can relieve the typical cable congestion created when populating a rack with storage systems and their accessories.

## Cable retention

Unintentional unplugging or unseating of a power cable can have a serious impact on the operation of an enterprise storage system. Unlike data cables, power connectors do not have built-in retention mechanisms to prevent this from happening.

To prevent accidental unplugging or unseating of power cables, the storage system includes a rubber cable-retention strap near the AC receptacle on each controller. These straps, shown in the following image, loop around the neck of a power cable connector, and the notched tail is slipped over the hook of the restraining bar fixed to the storage system.

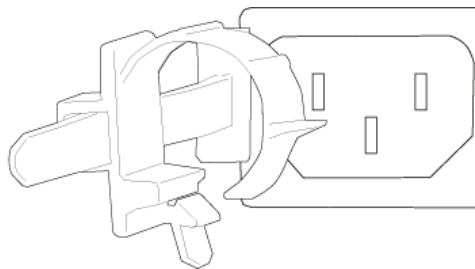





# Port address mapping

- [Port address mapping](#)

## Port address mapping

Each fibre channel port has a default port address (AL\_PA) of EF. You do not have to change this value because the storage system port can connect to the host bus adapter (HBA) with the current setting.

If you want to change the AL\_PA value, however, select a value from the following table.

If you use a value that is not in the following table or is already used by the HBA, the host might not be able to recognize the VOL. If this problem or other problems occur, revert to the default value of EF.

EF*	CD	B2	98	72	55	3A	25
E8	CC	B1	67	7	64	39	23
E4	CB	AE	90	6E	53	36	1F
E2	CA	AD	8F	6D	52	35	1E
E1	C9	AC	88	6C	51	34	1D
E0	C7	AB	84	6B	4E	33	1B
DC	C6	AA	82	6A	4D	32	18
DA	C5	A9	81	69	4C	31	17
D9	C3	A7	80	67	4B	2E	10
D6	BC	A6	7C	66	4A	2D	0F
D5	BA	A5	7A	65	49	2C	08
D4	B9	A3	79	63	47	2B	04
D3	B6	9F	76	5C	46	2A	02
D2	B5	9E	75	5A	45	29	01
D1	B4	9D	74	59	43	27	N/A
CE	B3	9B	73	56	3C	26	N/A
* A value set as the default value.							



## Third-party racks

All VSP G series storage systems can be installed into third-party racks.

The following describes the requirements and guidelines for installing the storage system into a third-party rack.

- [Third-party rack support for VSP Gx00 models](#)
- [Hitachi Universal V2 Rack rail kits](#)
- [Hitachi Universal V2 Rack accessories](#)
- [Third-party rack support for DB60 dense intermix drive trays](#)

## Third-party rack support for VSP Gx00 models

The VSP Gx00 models support third-party racks that meet Hitachi Data Systems specifications.

Observe the following mounting guidelines for third-party racks:

- The VSP Gx00 models support any 4-post, EIA-310-D compliant rack that has adequate airflow and weight capacity.
- PDUs must be mounted properly, with no serviceability issues. The PDU receptacles must face toward the back (not toward each other). The area behind the storage system and between the vertical 19-inch mounting posts must be free of PDUs and cable loops.

## Hitachi Universal V2 Rack rail kits

Use rail kits to mount the Hitachi Virtual Storage Platform family storage system in a Hitachi Universal V2 Rack.

The following tables list the rail kit information for the specified storage systems.

**Table 3 Rail kits for VSP Gx00 models**

Rail kit	Hitachi Universal V2 Rack	Third-party rack
Controller	UNI <sup>1</sup>	UNI <sup>1</sup>
DBS, DBL, and DBF drive trays	CGR <sup>2</sup>	UNI <sup>1</sup>
DB60 dense intermix drive tray	Use the rail kit supplied with the DB60 dense intermix drive tray.	
SVP server	Use the rail kit supplied with the SVP server.	
<b>Notes:</b>		
1. UNI: Universal rail kit A34V-600-850-UNI.		
2. CGR: Corner guide rail kit A3BF-HK-GL-740-1.		

## Hitachi Universal V2 Rack accessories

The following table provides rack accessory information for VSP G series storage systems.

**Table 4 Accessories for the Hitachi Universal V2 Rack**

Storage system	Front door	Rear door	Side panels
VSP Gx00 models	Optional, must be ordered separately (A3BF-DR).	Included with rack	Not included with rack, must be ordered separately. A quantity of two must be ordered per rack (A3BF-Z-PAN-1200).

## Third-party rack support for DB60 dense intermix drive trays

Due to the size and weight of the DB60 dense intermix drive trays used with VSP Gx00 models, pay close special attention when mounted in third-party racks.

When mounting DB60 dense intermix drive trays in third-party racks, observe the following guidelines and see the following figure.

- Use anti-tilt floor plates or ceiling-mounted fixing brackets to stabilize the rack.
- Use a rack that is at least 40.94 in. (1040 mm) deep to accommodate the DB60 dense intermix drive tray and cable-management arms.
- Dense tray rail kits require square mounting holed racks.
- Use a ladder to service the DB60 dense intermix drive tray if the drive tray is mounted above shelf height RU32.

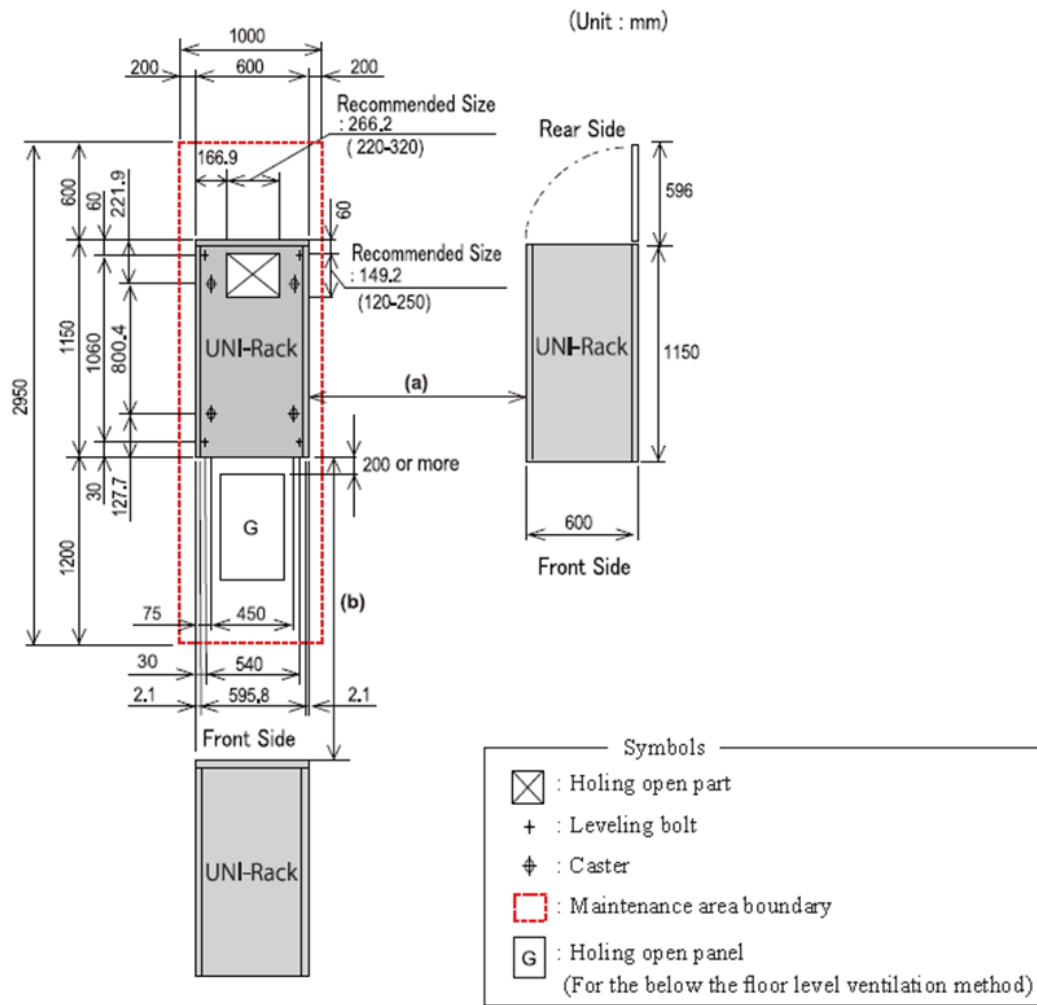





# Hitachi Universal V2 Rack power distribution units

The Hitachi Universal V2 Rack is equipped with specific power distribution units (PDU) for Americas, APAC, and EMEA regions. The PDUs can provide electrical power to the storage system in a single-phase or three-phase configuration.



---

**Caution:**

- Before installing third-party devices into the rack, check the electrical current draw of each device. Verify the electrical specifications and allowable current load on each PDU before plugging the device into the PDU.
  - Balance the electrical current load between available PDUs.
- 

- [Americas single-phase PDU 1P30A-8C13-3C19UL.P](#)
- [Americas single-phase PDU 1P30A-15C13-3C19UL.P](#)
- [Americas three-phase PDU 3P30A-8C13-3C19UL.P](#)
- [Americas three-phase PDU 3P30A-15C13-3C19UL.P](#)
- [Americas three-phase PDU 3P30A-24C13-6C19UL.P](#)
- [APAC and EMEA single-phase PDU 1P32A-9C13-3C19CE.P](#)
- [APAC and EMEA single-phase PDU 1P32A-18C13-3C19CE.P](#)
- [APAC and EMEA three-phase PDU 3P16A-9C13-3C19CE.P](#)
- [APAC and EMEA three-phase PDU 3P16A-15C13-3C19CE.P](#)
- [APAC and EMEA three-phase PDU 3P32A-24C13-6C19CE.P](#)

## Americas single-phase PDU 1P30A-8C13-3C19UL.P

The following figure and table describes the specifications of the PDU.

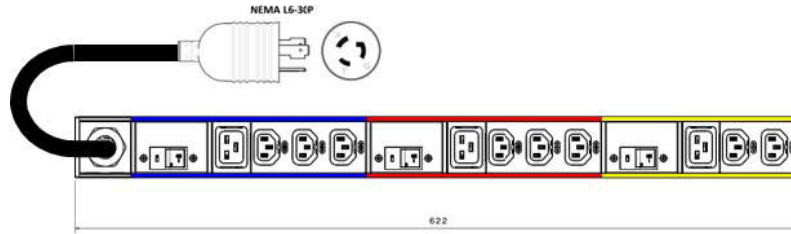
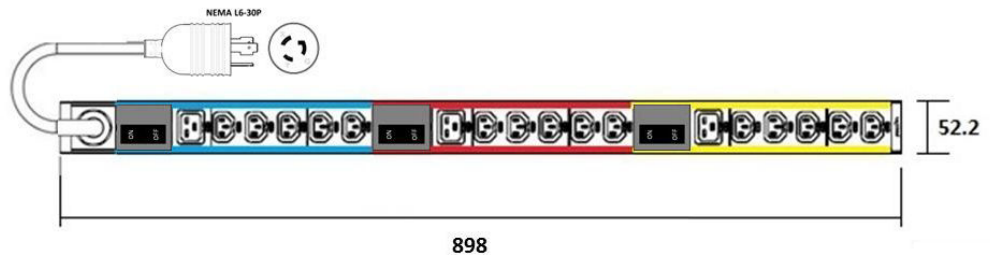

**Figure 1 Americas PDU for the Hitachi Universal V2 Rack (Single-phase PDU 1P30A-8C13-3C19UL.P)**

Part Number	Region	Phase	Description
1P30A-8C13-3C19UL.P	Americas	Single	<ul style="list-style-type: none"> <li>• 208V, 30A (24A rated) 60Hz</li> <li>• 8 IEC C13 + 3 IEC C19 sockets</li> <li>• NEMA L6-30P input power plug</li> <li>• 4.5 m (14.76 feet) cable</li> </ul>

## Americas single-phase PDU 1P30A-15C13-3C19UL.P

The following figure and table describes the specifications of the PDU.



**Figure 2 Americas PDU for the Hitachi Universal V2 Rack (Single-phase PDU 1P30A-15C13-3C19UL.P)**

Part Number	Region	Phase	Description
1P30A-15C13-3C19UL.P	Americas	Single	<ul style="list-style-type: none"> <li>• 208V, 30A (24A rated) 60Hz</li> </ul>

Part Number	Region	Phase	Description
			<ul style="list-style-type: none"> <li>• 15 IEC C13 + 3 IEC C19 sockets</li> <li>• NEMA L6-30P input power plug</li> <li>• 4.5 m (14.76 feet) cable</li> </ul>

## Americas three-phase PDU 3P30A-8C13-3C19UL.P

The following figure and table describes the specifications of the PDU.

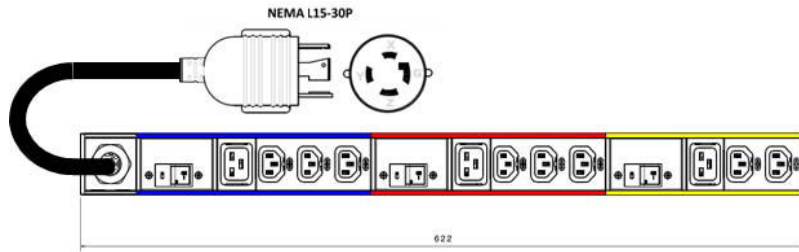
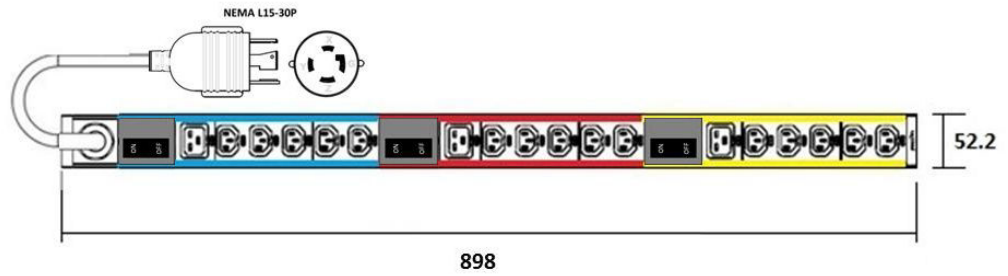

**Figure 3 Americas PDU for the Hitachi Universal V2 Rack (Three-phase PDU 3P30A-8C13-3C19UL.P)**

Part Number	Region	Phase	Description
3P30A-8C13-3C19UL.P	Americas	Three	<ul style="list-style-type: none"> <li>• 208V 3P, 30A (24A rated) 60Hz</li> <li>• 8 IEC C13 + 3 IEC C19 sockets</li> <li>• NEMA L15-30P input power plug</li> <li>• 4.5 m (14.76 feet) cable</li> </ul>

## Americas three-phase PDU 3P30A-15C13-3C19UL.P

The following figure and table describes the specifications of the PDU.

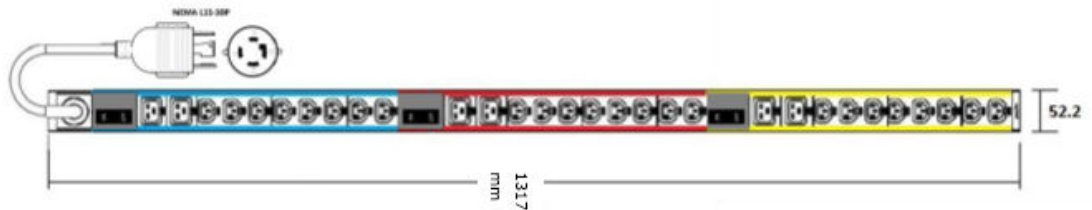

**Figure 4 Americas PDU for the Hitachi Universal V2 Rack (Three-phase PDU 3P30A-15C13-3C19UL.P)**

Part Number	Region	Phase	Description
3P30A-15C13-3C19UL.P	Americas	Three	<ul style="list-style-type: none"> <li>• 208V 3P, 30A (24A rated) 60Hz</li> <li>• 15 IEC C13 + 3 IEC C19 sockets</li> <li>• NEMA L15-30P input power plug</li> <li>• 4.5 m (14.76 feet) cable</li> </ul>

## Americas three-phase PDU 3P30A-24C13-6C19UL.P

The following figure and table describes the specifications of the PDU.

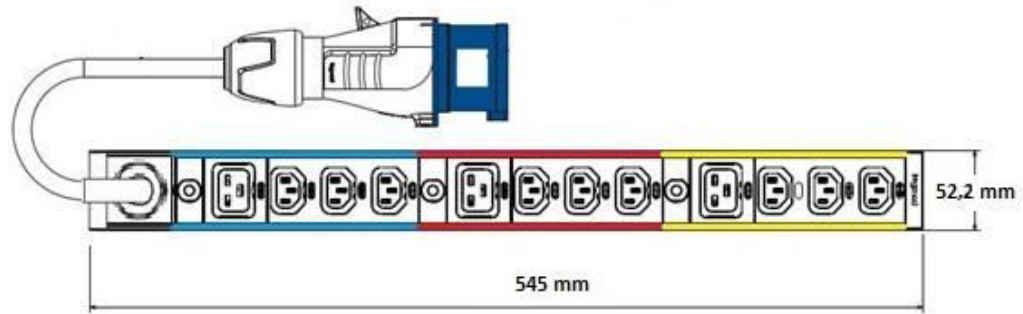

**Figure 5 Americas PDU for the Hitachi Universal V2 Rack (Three-phase PDU 3P30A-24C13-6C19UL.P)**

Part Number	Region	Phase	Description
3P30A-24C13-6C19UL.P	Americas	Three	<ul style="list-style-type: none"> <li>• 208V 3P, 30A (24A rated) 60Hz</li> <li>• 24 IEC C13 + 6 IEC C19 sockets</li> <li>• NEMA L15-30P input power plug</li> <li>• 4.5 m (14.76 feet) cable</li> </ul>

## APAC and EMEA single-phase PDU 1P32A-9C13-3C19CE.P

The following figure and table describes the specifications of the PDU.

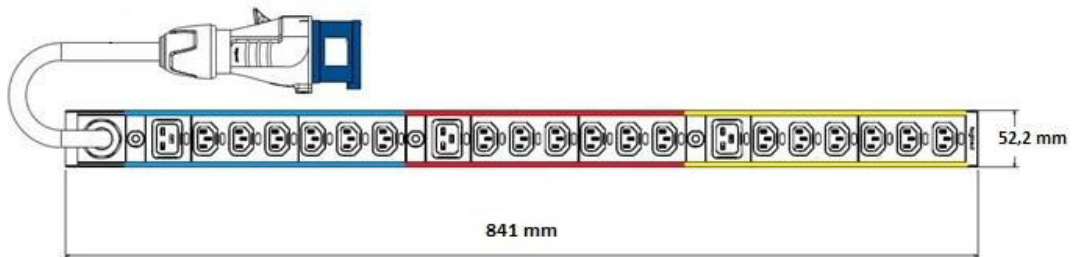

**Figure 6 APAC and EMEA PDU for the Hitachi Universal V2 Rack (Single-phase 1P32A-9C13-3C19CE.P)**

Part Number	Region	Phase	Description
1P32A-9C13-3C19CE.P	APAC and EMEA	Single	<ul style="list-style-type: none"> <li>• 230V max. 32A 50Hz / 60Hz</li> <li>• 9 IEC C13 + 3 IEC C19 sockets</li> <li>• IEC309 Blue 2P + E input power plug</li> <li>• 4.5 m (14.76 feet) cable</li> </ul>

## APAC and EMEA single-phase PDU 1P32A-18C13-3C19CE.P

The following figure and table describes the specifications of the PDU.

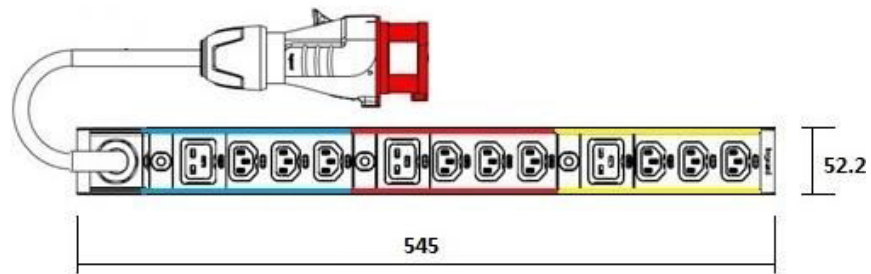

**Figure 7 APAC and EMEA PDU for the Hitachi Universal V2 Rack (Single-phase 1P32A-18C13-3C19CE.P)**

Part Number	Region	Phase	Description
1P32A-18C13-3C19CE.P	APAC and EMEA	Single	<ul style="list-style-type: none"> <li>• 230V max. 32A 50Hz / 60Hz</li> <li>• 18 IEC C13 + 3 IEC C19 sockets</li> <li>• IEC309 Blue 2P + E input power plug</li> <li>• 4.5 m (14.76 feet) cable</li> </ul>

## APAC and EMEA three-phase PDU 3P16A-9C13-3C19CE.P

The following figure and table describes the specifications of the PDU.

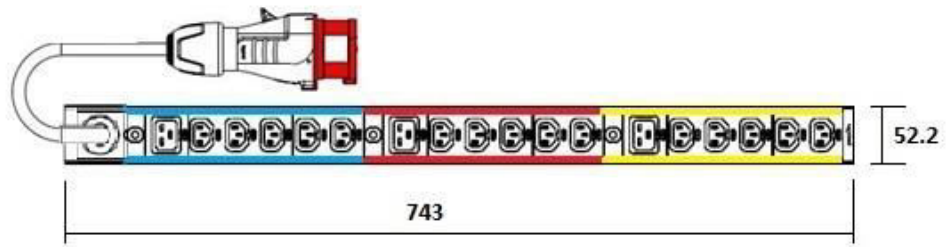

**Figure 8 APAC and EMEA PDU for the Hitachi Universal V2 Rack (Three-phase 3P16A-9C13-3C19CE.P)**

Part Number	Region	Phase	Description
3P16A-9C13-3C19CE.P	APAC and EMEA	Three	<ul style="list-style-type: none"> <li>• 400V max. 3x 16A 50Hz / 60Hz</li> <li>• 9 IEC C13 + 3 IEC C19 sockets</li> <li>• IEC309 Red 3P + N + E input power plug</li> <li>• 4.5 m (14.76 feet) cable</li> </ul>

## APAC and EMEA three-phase PDU 3P16A-15C13-3C19CE.P

The following figure and table describes the specifications of the PDU.

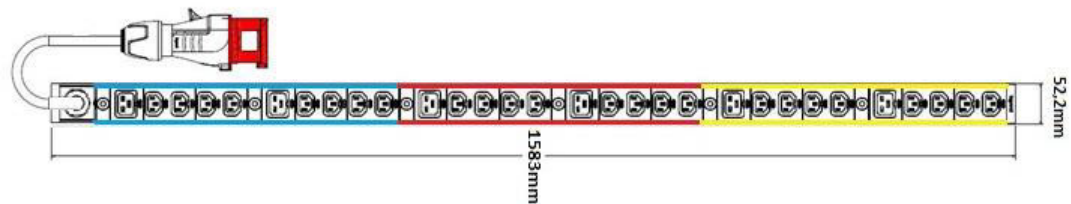

**Figure 9 APAC and EMEA PDU for the Hitachi Universal V2 Rack (Three-phase 3P16A-15C13-3C19CE.P)**

Part Number	Region	Phase	Description
3P16A-15C13-3C19CE.P	APAC and EMEA	Three	<ul style="list-style-type: none"> <li>400V max. 3x 16A 50Hz / 60Hz</li> <li>15 IEC C13 + 3 IEC C19 sockets</li> <li>IEC309 Red 3P + N + E input power plug</li> <li>4.5 m (14.76 feet) cable</li> </ul>

## APAC and EMEA three-phase PDU 3P32A-24C13-6C19CE.P

The following figure and table describes the specifications of the PDU.



**Figure 10 APAC and EMEA PDU for the Hitachi Universal V2 Rack (Three-phase 3P32A-24C13-6C19CE.P)**

Part Number	Region	Phase	Description
3P32A-24C13-6C19CE.P	APAC and EMEA	Three	<ul style="list-style-type: none"> <li>400V max. 3x 32A 50Hz / 60Hz</li> <li>24 IEC C13 + 6 IEC C19 sockets</li> <li>IEC309 Red 3P + N + E input power plug</li> <li>4.5 m (14.76 feet) cable</li> </ul>







## Regulatory compliance

This equipment has been tested and certified for compliance with the following standards.

**Table 5 Country Specifications and Certifications**

Standard	Specification	Product marking or logo	Country regulation
Electronic emission controls	FCC part 15 Subpart B: 2013	FCC	USA and Canada
	ICES-003 Issue 5:2012	ICES-003	USA and Canada
	AS/NZS CISPR 22:2009+A1	RCM	Australia and New Zealand
	TP TC 020/2011	EAC	Russia, Belarus, and Kazakhstan
	CNS 13438	BSMI	Taiwan
	KN22	KC	Korea
	KN24	KC	Korea
Electronic emission certifications	EN5522: 2010	CE	EU
	EN5524: 2010	CE	EU
	EN61000-3.2:2006+A1+A2	CE	EU
	EN61000-3.3:2008	CE	EU
Safety certifications	UL and CSA 60950-1:2007	cTUVus	USA and Canada
	EN60950-1:2006+A1	TUV	Germany
	IEC60950-1:2005+A1	N/A	All CB countries
	IEC60950-1:2005+A1	S-Mark	Argentina
	TP TC 004/2011	EAC	Russia
	CNS 14336-1	BSMI	Taiwan

Standard	Specification	Product marking or logo	Country regulation
	EN60950-1:2006+A1	CE	EU
Radio interference voluntary control	VCCI V-3/2013.04	VCCI	Japan

# Index

## Numerics

- 10-Gbps iSCSI board (copper) 29
- 10-Gbps iSCSI board (optical) 29
- 16-Gbps Fibre Channel board 30, 32
- 32-Gbps Fibre Channel board 30
- 8-Gbps Fibre Channel board 30

## A

- AC
  - connections 99
- AC power cables 97
- AC power supply units
  - large form factor drive tray 49
  - small form factor drive tray 49
- audience 8

## B

- back end module
  - LEDs and connectors 34
- battery
  - unit 88
- bezels
  - CBLM controller 24
  - dense intermix drive tray 46
  - flash module drive tray 43
  - large form factor drive tray 40
  - small form factor drive tray 38
- block 15

## C

- cables
  - AC power 97
  - Fibre Channel 90
  - iSCSI 93
  - managing 95
  - removing 64
  - retention 101
- CBLH controller 25
  - rear panel 26
- CBLM controller 24, 25
  - rear panel 26

- with front panel bezel 24
- chassis 51
- compliance 117
- configuration 15
- configurations 19
- connections
  - AC 99
- controller 23
- controllers
  - CBLM 24

## D

- data cables 89
- dense intermix drive tray 46
  - display LEDs 47
    - rear panel 48
    - with front panel bezel 46
- display LEDs on dense intermix drive tray 47
- drive trays
  - dense intermix 46
  - flash module 43
  - large form-factor 40
  - maximum number 20
  - small form-factor 38

## E

- electrical 75
- electrical specifications 76
- environmental 77
- environmental specifications 78

## F

- fan
  - host port expansion chassis 53
- Fibre Channel
  - cable removal 64
  - cables 90
- flash module drive tray 43
  - rear panel 45
    - with front panel bezel 43
    - without front panel bezel 44

- front door 106
- front end modules
  - 10-Gbps iSCSI board (copper) 29
  - 10-Gbps iSCSI board (optical) 29
  - 16-Gbps Fibre Channel board 30, 32
  - 32-Gbps Fibre Channel board 30
  - 8-Gbps Fibre Channel board 30
- front panel bezels
  - CBLM controller 24
  - dense intermix drive tray 46
  - flash module drive tray 43
  - host port expansion chassis 52
  - large form factor drive tray 40
  - small form factor drive tray 38

## H

- hardware 13
  - specifications 62
- Hitachi Virtual Storage Platform G400VSP G400 15
- Hitachi Virtual Storage Platform G600VSP G600 17
- host 28
- host port expansion 51
- host port expansion chassis
  - fan 53
  - front panel bezel LEDs 52
  - power supply 55

## I

- iSCSI 83
  - cable removal 64
  - cables 93
  - specifications 84
  - standards 84

## L

- LAN blade LEDs and connectors 33
- large form factor drive tray
  - AC power supply unit 49
  - with front panel bezel 40
- large form-factor drive tray 40
  - rear panel 42
  - without bezel 41

## M

- maintaining the storage system 63
- managing cables 95
- maximum
  - number of mounted drives 20
- mechanical 67
- mechanical specifications 68
- module 57, 58
- mounted drive trays 20

## N

- NAS 57, 58
- network 28
- number of mounted drive trays 20

## O

- overview 13

## P

- parts, replacement 87
- PCIe cable connector
  - LEDs 53
- PCIe switchboard
  - LED 52
- physical SVP
  - rear panel 61
- ports 28
- power cable assemblies 97
- power cables 89
  - AC 97
- power distribution unit
  - overview 109
  - specifications 109
    - Americas
      - single-phase 110
      - three-phase 111, 112
    - APAC and EMEA
      - single-phase 113
      - three-phase 114, 115
- power supply unit 28
- power supply units
  - host port expansion chassis 55
- powering off the storage system 64
- product version 9

## R

- rack accessories 106
- rail kits 106
- rear door 106
- rear panel of physical SVP 61
- rear panels
  - CBLH controller 26
  - CBLM controller 26
  - dense intermix drive tray 48
  - flash module drive tray 45
  - large form-factor drive tray 42
  - small form factor drive tray 39
- regulatory compliance 117
- removing cables 64
- replacement parts 87
  - battery unit 88
- retention, cables 101

## **S**

- SAS cables
  - removing 64
- scalability 19
- service processor 59, 60
- side panels 106
- small form factor drive tray
  - AC power supply unit 49
  - rear panel 39
  - with front panel bezel 38
  - without bezel 38
- small form-factor drive tray 38
- specifications 67, 75, 77, 83
  - electrical 76
  - environmental 78
  - hardware 62
  - iSCSI 84
  - mechanical 68
- standards 83
- standards for iSCSI 84
- storage 67
- storage system
  - maintenance 63
  - power off 64
  - regulatory compliance 117
  - storing 64
- storage system controllers
  - CBLM 24
- storing the storage system 64
- supported configurations 19
- SVP 59
  - hardware specifications 62

## **T**

- third-party rack
  - DB60 dense intermix drive tray 107
- third-party racks 105
- third-party racksmounting guidelines 106

## **U**

- Unified 15

## **V**

- Virtual Storage Platform G400, G600 23

## **W**

- without front panel bezel 25





## **Hitachi Data Systems**

### **Corporate Headquarters**

2845 Lafayette Street  
Santa Clara, California 95050-2639  
U.S.A.

[www.hds.com](http://www.hds.com)

### **Regional Contact Information**

#### **Americas**

+1 408 970 1000

[info@hds.com](mailto:info@hds.com)

#### **Europe, Middle East, and Africa**

+44 (0) 1753 618000

[info.emea@hds.com](mailto:info.emea@hds.com)

#### **Asia Pacific**

+852 3189 7900

[hds.marketing.apac@hds.com](mailto:hds.marketing.apac@hds.com)

#### **Contact Us**

[www.hds.com/en-us/contact.html](http://www.hds.com/en-us/contact.html)



**MK-94HM8022-09**

**September 2017**