

# Hitachi Virtual Storage Platform F900

88-06-0x

---

## Hardware Reference Guide

This document provides information about the system hardware components and the mechanical and environmental specifications for the Hitachi Virtual Storage Platform F900 all-flash array.

© 2015, 2020 Hitachi, Ltd. All rights reserved.

No part of this publication may be reproduced or transmitted in any form or by any means, electronic or mechanical, including copying and recording, or stored in a database or retrieval system for commercial purposes without the express written permission of Hitachi, Ltd., or Hitachi Vantara LLC (collectively "Hitachi"). Licensee may make copies of the Materials provided that any such copy is: (i) created as an essential step in utilization of the Software as licensed and is used in no other manner; or (ii) used for archival purposes. Licensee may not make any other copies of the Materials. "Materials" mean text, data, photographs, graphics, audio, video and documents.

Hitachi reserves the right to make changes to this Material at any time without notice and assumes no responsibility for its use. The Materials contain the most current information available at the time of publication.

Some of the features described in the Materials might not be currently available. Refer to the most recent product announcement for information about feature and product availability, or contact Hitachi Vantara LLC at <https://support.hitachivantara.com/en-us/contact-us.html>.

**Notice:** Hitachi products and services can be ordered only under the terms and conditions of the applicable Hitachi agreements. The use of Hitachi products is governed by the terms of your agreements with Hitachi Vantara LLC.

By using this software, you agree that you are responsible for:

1. Acquiring the relevant consents as may be required under local privacy laws or otherwise from authorized employees and other individuals; and
2. Verifying that your data continues to be held, retrieved, deleted, or otherwise processed in accordance with relevant laws.

**Notice on Export Controls.** The technical data and technology inherent in this Document may be subject to U.S. export control laws, including the U.S. Export Administration Act and its associated regulations, and may be subject to export or import regulations in other countries. Reader agrees to comply strictly with all such regulations and acknowledges that Reader has the responsibility to obtain licenses to export, re-export, or import the Document and any Compliant Products.

Hitachi and Lumada are trademarks or registered trademarks of Hitachi, Ltd., in the United States and other countries.

AIX, AS/400e, DB2, Domino, DS6000, DS8000, Enterprise Storage Server, eServer, FICON, FlashCopy, GDPS, HyperSwap, IBM, Lotus, MVS, OS/390, PowerHA, PowerPC, RS/6000, S/390, System z9, System z10, Tivoli, z/OS, z9, z10, z13, z14, z/VM, and z/VSE are registered trademarks or trademarks of International Business Machines Corporation.

Active Directory, ActiveX, Bing, Excel, Hyper-V, Internet Explorer, the Internet Explorer logo, Microsoft, the Microsoft Corporate Logo, MS-DOS, Outlook, PowerPoint, SharePoint, Silverlight, SmartScreen, SQL Server, Visual Basic, Visual C++, Visual Studio, Windows, the Windows logo, Windows Azure, Windows PowerShell, Windows Server, the Windows start button, and Windows Vista are registered trademarks or trademarks of Microsoft Corporation. Microsoft product screen shots are reprinted with permission from Microsoft Corporation.

All other trademarks, service marks, and company names in this document or website are properties of their respective owners.

Copyright and license information for third-party and open source software used in Hitachi Vantara products can be found at <https://www.hitachivantara.com/en-us/company/legal.html>.

---

# Contents

<b>Preface</b> .....	<b>7</b>
Intended audience.....	7
UEFI Development Kit 2010.....	7
Product version.....	8
Release notes.....	8
Changes in this revision.....	8
Document conventions.....	8
Conventions for storage capacity values.....	10
Accessing product documentation.....	11
Getting help.....	11
Comments.....	11
<b>Chapter 1: Overview</b> .....	<b>12</b>
Block configuration.....	12
Features.....	12
<b>Chapter 2: System controller</b> .....	<b>14</b>
CBL controller chassis.....	14
CBL controller front panel bezel LEDs.....	14
CBL controller front panel LEDs (without bezel).....	16
CBL controller rear panel LEDs.....	18
CBL controller power supply unit LEDs and connectors.....	18
Host, Network, and Drive Tray Ports and LEDs.....	19
Front-end modules.....	19
10-Gbps iSCSI board LEDs and connectors (optical).....	20
10-Gbps iSCSI board LEDs and connectors (copper).....	20
8-Gbps, 16-Gbps, or 32-Gbps Fibre Channel (4-port) board LEDs and connectors.....	22
16-Gbps Fibre Channel (2-port) board LEDs and connectors.....	24
PCIe module.....	25
LAN blade LEDs and connectors.....	26
Back-end modules.....	27
<b>Chapter 3: Drive trays</b> .....	<b>28</b>
Small form-factor drive tray (DBS/DBSE).....	28

SFF with front panel bezel.....	28
SFF front panel without bezel.....	29
SFF rear panel.....	30
AC power supply unit LEDs and connectors.....	31
Flash module drive tray (DBF).....	32
FMD with front panel bezel.....	32
FMD front panel without bezel.....	33
FMD rear panel.....	34
<b>Chapter 4: Host port expansion chassis.....</b>	<b>36</b>
Host port expansion chassis front panel bezel LEDs.....	36
PCIe switchboard.....	36
Host port expansion chassis fan.....	37
PCIe cable connector.....	38
Host port expansion chassis power supply.....	39
<b>Chapter 5: Service processor.....</b>	<b>41</b>
Service Processor (Windows 10 Enterprise) hardware specifications.....	41
Service processor description.....	42
SVP (Windows 10 Enterprise) front panel.....	43
SVP (Windows 10 Enterprise) rear panel.....	43
<b>Chapter 6: Maintaining the storage system.....</b>	<b>45</b>
Storing the storage system.....	45
Powering off the storage system.....	45
Battery unit.....	46
<b>Appendix A: Storage system parts list.....</b>	<b>47</b>
VSP F900 parts list.....	47
Drive tray and drive configuration.....	51
Data and power cable model list.....	52
<b>Appendix B: System specifications .....</b>	<b>56</b>
VSP F900 mechanical specifications.....	56
Electrical specifications .....	61
Environmental specifications .....	62
Shared memory.....	68
<b>Appendix C: Network access.....</b>	<b>71</b>
TCP/IP port assignments.....	71
Controller connections.....	74
Physical service processor connections.....	74

## **Appendix D: Data and power cables..... 76**

Required cables.....	76
Fibre Channel cables.....	78
iSCSI cables.....	81
iSCSI standards.....	84
iSCSI specifications.....	84
Managing cables.....	87
AC power cables.....	90
Power cable assemblies.....	90
AC connections.....	92
Power cable usage guidelines.....	94
Three-phase power considerations for racks.....	94
Cable management.....	94

## **Appendix E: Power distribution units for Hitachi Universal V2B Rack ..... 95**

Americas single-phase PDU 1P30A-8C13-3C19UL.P.....	95
Americas single-phase PDU 1P30A-15C13-3C19UL.P.....	96
Americas three-phase PDU 3P30A-8C13-3C19UL.P.....	97
Americas three-phase PDU 3P30A-15C13-3C19UL.P.....	97
Americas three-phase PDU 3P30A-24C13-6C19UL.P.....	98
APAC and EMEA single-phase PDU 1P32A-9C13-3C19CE.P.....	99
APAC and EMEA single-phase PDU 1P32A-18C13-3C19CE.P.....	100
APAC and EMEA three-phase PDU 3P16A-9C13-3C19CE.P.....	101
APAC and EMEA three-phase PDU 3P16A-15C13-3C19CE.P.....	102
APAC and EMEA three-phase PDU 3P32A-24C13-6C19CE.P.....	103
Americas, APAC, and EMEA three-phase PDU 3P30A-243-69CE-UL.P.....	104

## **Appendix F: Non-Hitachi racks..... 106**

Non-Hitachi rack support .....	106
Hitachi Universal V2 Rack rail kits.....	106
Hitachi Universal V2 Rack accessories.....	107

## **Appendix G: Warning labels on the storage system..... 108**

CBL controller.....	109
Small form factor drive tray.....	110
Flash module drive tray.....	111
CBL controller.....	112
Battery.....	112
Host port expansion chassis.....	112
PCIe switch board.....	113

<b>Appendix H: Environmental notices.....</b>	<b>115</b>
<b>Appendix I: Regulatory compliance.....</b>	<b>116</b>

---

## Preface

This guide describes the hardware features and specifications of the Hitachi Virtual Storage Platform F900.

### Intended audience

This document is intended for Hitachi Vantara representatives, system administrators, authorized service providers, or customers who install, configure, and operate the VSP Fx00 models .

Readers of this document should be familiar with the following:

- Data processing and RAID storage systems and their basic functions
- RAID storage system hardware components and operational specifications

### UEFI Development Kit 2010

This product includes UEFI Development Kit 2010 written by the UEFI Open Source Community. For more information, see the UEFI Development Kit website:

<http://sourceforge.net/apps/mediawiki/tianocore/index.php?title=UDK2010>

© 2004, Intel Corporation.

All rights reserved.

Redistribution and use in source and binary forms, with or without modification, are permitted provided that the following conditions are met:

Redistributions of source code must retain the above copyright notice, this list of conditions and the following disclaimer.

Redistributions in binary form must reproduce the above copyright notice, this list of conditions and the following disclaimer in the documentation and/or other materials provided with the distribution.

Neither the name of the Intel Corporation nor the names of its contributors might be used to endorse or promote products derived from this software without specific prior written permission.

THIS SOFTWARE IS PROVIDED BY THE COPYRIGHT HOLDERS AND CONTRIBUTORS "AS IS" AND ANY EXPRESS OR IMPLIED WARRANTIES, INCLUDING, BUT NOT LIMITED TO, THE IMPLIED WARRANTIES OF MERCHANTABILITY AND FITNESS FOR A PARTICULAR PURPOSE ARE DISCLAIMED. IN NO EVENT SHALL THE COPYRIGHT OWNER OR CONTRIBUTORS BE LIABLE FOR ANY DIRECT, INDIRECT, INCIDENTAL, SPECIAL, EXEMPLARY, OR CONSEQUENTIAL DAMAGES (INCLUDING, BUT NOT LIMITED TO, PROCUREMENT OF SUBSTITUTE GOODS OR SERVICES; LOSS OF USE, DATA, OR PROFITS; OR BUSINESS INTERRUPTION) HOWEVER CAUSED AND ON ANY THEORY OF LIABILITY, WHETHER IN CONTRACT, STRICT LIABILITY, OR TORT (INCLUDING NEGLIGENCE OR OTHERWISE) ARISING IN ANY WAY OUT OF THE USE OF THIS SOFTWARE, EVEN IF ADVISED OF THE POSSIBILITY OF SUCH DAMAGE.

## Product version

This document revision applies to VSP F900 firmware 88-06-0x or later.

## Release notes

Read the release notes before installing and using this product. They may contain requirements or restrictions that are not fully described in this document or updates or corrections to this document. Release notes are available on Hitachi Vantara Support Connect: <https://knowledge.hitachivantara.com/Documents>.

## Changes in this revision

- Improved language about controllers.

## Document conventions

This document uses the following storage system terminology conventions:

Convention	Description
------------	-------------



This document uses the following typographic conventions:



Convention	Description
<b>Bold</b>	<ul style="list-style-type: none"> <li>Indicates text in a window, including window titles, menus, menu options, buttons, fields, and labels. Example: Click <b>OK</b>.</li> <li>Indicates emphasized words in list items.</li> </ul>
<i>Italic</i>	<ul style="list-style-type: none"> <li>Indicates a document title or emphasized words in text.</li> <li>Indicates a variable, which is a placeholder for actual text provided by the user or for output by the system. Example: <code>pairdisplay -g group</code></li> </ul> <p>(For exceptions to this convention for variables, see the entry for angle brackets.)</p>
Monospace	Indicates text that is displayed on screen or entered by the user. Example: <code>pairdisplay -g oradb</code>
< > angle brackets	Indicates variables in the following scenarios: <ul style="list-style-type: none"> <li>Variables are not clearly separated from the surrounding text or from other variables. Example: <code>Status-&lt;report-name&gt;&lt;file-version&gt;.csv</code></li> <li>Variables in headings.</li> </ul>
[ ] square brackets	Indicates optional values. Example: [ a   b ] indicates that you can choose a, b, or nothing.
{ } braces	Indicates required or expected values. Example: { a   b } indicates that you must choose either a or b.
vertical bar	Indicates that you have a choice between two or more options or arguments. Examples: [ a   b ] indicates that you can choose a, b, or nothing. { a   b } indicates that you must choose either a or b.

This document uses the following icons to draw attention to information:

Icon	Label	Description
	Note	Calls attention to important or additional information.

Icon	Label	Description
	Tip	Provides helpful information, guidelines, or suggestions for performing tasks more effectively.
	Caution	Warns the user of adverse conditions and/or consequences (for example, disruptive operations, data loss, or a system crash).
	WARNING	Warns the user of a hazardous situation which, if not avoided, could result in death or serious injury.

## Conventions for storage capacity values

Physical storage capacity values (for example, disk drive capacity) are calculated based on the following values:

Physical capacity unit	Value
1 kilobyte (KB)	1,000 ( $10^3$ ) bytes
1 megabyte (MB)	1,000 KB or $1,000^2$ bytes
1 gigabyte (GB)	1,000 MB or $1,000^3$ bytes
1 terabyte (TB)	1,000 GB or $1,000^4$ bytes
1 petabyte (PB)	1,000 TB or $1,000^5$ bytes
1 exabyte (EB)	1,000 PB or $1,000^6$ bytes

Logical capacity values (for example, logical device capacity, cache memory capacity) are calculated based on the following values:

Logical capacity unit	Value
1 block	512 bytes
1 cylinder	Mainframe: 870 KB Open-systems: <ul style="list-style-type: none"> <li>▪ OPEN-V: 960 KB</li> <li>▪ Others: 720 KB</li> </ul>
1 KB	$1,024 (2^{10})$ bytes

Logical capacity unit	Value
1 MB	1,024 KB or 1,024 <sup>2</sup> bytes
1 GB	1,024 MB or 1,024 <sup>3</sup> bytes
1 TB	1,024 GB or 1,024 <sup>4</sup> bytes
1 PB	1,024 TB or 1,024 <sup>5</sup> bytes
1 EB	1,024 PB or 1,024 <sup>6</sup> bytes

## Accessing product documentation

Product user documentation is available on Hitachi Vantara Support Connect: <https://knowledge.hitachivantara.com/Documents>. Check this site for the most current documentation, including important updates that may have been made after the release of the product.

## Getting help

[Hitachi Vantara Support Connect](#) is the destination for technical support of products and solutions sold by Hitachi Vantara. To contact technical support, log on to Hitachi Vantara Support Connect for contact information: [https://support.hitachivantara.com/en\\_us/contact-us.html](https://support.hitachivantara.com/en_us/contact-us.html).

[Hitachi Vantara Community](#) is a global online community for Hitachi Vantara customers, partners, independent software vendors, employees, and prospects. It is the destination to get answers, discover insights, and make connections. **Join the conversation today!** Go to [community.hitachivantara.com](https://community.hitachivantara.com), register, and complete your profile.

## Comments

Please send us your comments on this document to [doc.comments@hitachivantara.com](mailto:doc.comments@hitachivantara.com). Include the document title and number, including the revision level (for example, -07), and refer to specific sections and paragraphs whenever possible. All comments become the property of Hitachi Vantara LLC.

**Thank you!**

---

## Chapter 1: Overview

The Hitachi Virtual Storage Platform F900 is a versatile modular, rack-mountable all-flash array storage system equipped with drive boxes, supporting flash module drives, scaled for various storage capacity configurations. To deliver consistent low latency host response times and highest IOP performance across all host connection ports, conventional hard-disk drives are not supported in an all-flash configuration.

The storage systems provide high performance operations by using multiple controllers with high-speed processors, dual in-line cache memory modules (DIMMs), cache flash memory (CFM), battery, fans and ports to connect iSCSI and Fibre Channel I/O modules. Each controller has an Ethernet connection for out-of-band management. If the data path through one controller fails, all data drives remain available to hosts using a redundant data path through the other controller.

For reliability, essential hardware components are implemented with a redundant configuration so that the storage system can remain operational if a component fails. Adding and replacing components, along with firmware upgrades, can be conducted while the storage system is active and without interruption of data availability to the hosts. A hot spare drive can be configured to replace a failed data drive automatically, securing the fault-tolerant integrity of the logical drives. Self-contained, hardware-based RAID logical drives provide maximum performance in compact external enclosures.

### Block configuration

A storage system configured for block-level storage provides the ability to access and provision raw storage volumes using protocols such as Fibre Channel and iSCSI.

A block configuration consists of the following:

- Multiple controllers
- One or more drive trays
- Optional service processor (SVP)

### Features

All storage systems are highly reliable, versatile, and able to scale its performance by adding more drive chassis and data drives. Depending on the system configuration, the drive chassis offerings support SAS-interface solid-state and flash module drives.

**High performance**

- Multiple controller configuration distributes processing to each controller
- Equipped with high capacity cache to provide a total of 1,024 GB of high-speed processing
- Flash drive configuration increases I/O processing speeds
- Equipped with 32/16-Gbps Fibre Channel or 10-Gbps iSCSI interface facilitates high-speed data transfer

**High reliability**

- Main system components are configured with redundancy to maintain continued service
- RAID 1, RAID 5, and RAID 6 support (RAID 6 including 14D+2P)
- Provides data security by transferring data to cache flash memory at the time of a power outage

**Scalability and versatility**

- Supports flash drive tray (DBF) requiring 2U of rack space and up to 12 flash module drives (FMD) can be installed
- Supports system environments with mixed operating systems such as UNIX, Linux, Windows, and VMware

---

## Chapter 2: System controller

The storage systems are equipped with multiple controllers for communicating with a data host.

Each controller includes the following internal components such as a processor, dual in-line cache memory modules (DIMMs), cache flash memory (CFM), battery, and fans. The controller has an Ethernet connection for out-of-band management using Hitachi Device Manager - Storage Navigator. If the data path through one controller fails, all drives remain available to data hosts using a redundant data path through the other controller. The controller is equipped with LED indicators for monitoring its operating conditions and notifying possible component replacement.

### CBL controller chassis

The controller chassis houses controllers, backup fan modules, and power supplies. The chassis also includes specific functional LEDs located on the front and rear of controller to provide its operating status.

The following table lists the controller board specifications.

Component	VSP F900
Chassis (4U)	DW850-CBL
Controller board	DW-F850-CTLH
Number of DIMM slot	8
Cache memory capacity	128 GiB to 512 GiB
Data encryption	N/A

### CBL controller front panel bezel LEDs

The following table describes the definitions of the CBL controller front panel bezel LEDs.

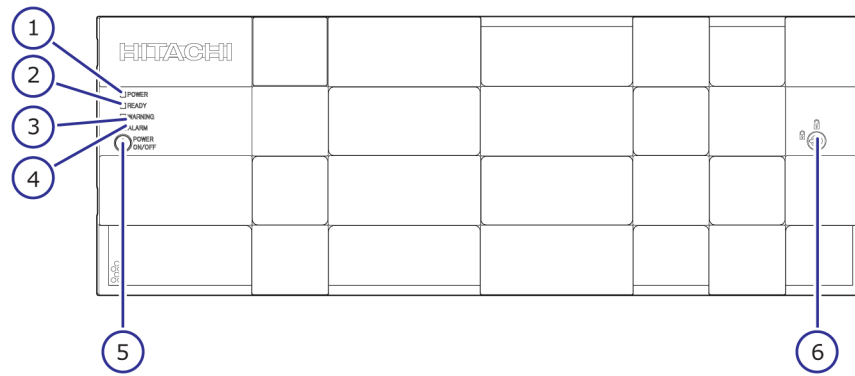

Number	Item	Description
1	POWER LED	Green: Storage system is powered on. Amber: Storage system is receiving power.
2	READY LED	Green: Normal operation.
3	WARNING LED	Off: Normal operation. Amber: Component requires maintenance. Blink: Failure requires maintenance. <b>Note:</b> When System Option Mode 1097 is set to ON, the WARNING LED does not blink, even if the following failure service information messages (SIM) are issued: 452xxx, 462xxx, 3077xx, 4100xx, and 410100. LED might turn off during user maintenance.
4	ALARM LED	Off: Normal operation. Red: Processor failure (system might be down). For assistance, contact customer support: <a href="https://support.hitachivantara.com/en_us/contact-us.html">https://support.hitachivantara.com/en_us/contact-us.html</a> .
5	POWER ON/OFF (main switch)	Powers the storage system.

Number	Item	Description
6	Lock	Locks and unlocks the front panel bezel by using the supplied key.



**Note:** Removing a controller can cause the POWER, READY, WARNING, and ALARM LEDs on the front panel to turn off. These LEDs return to the on status after the storage system recovers from the controller replacement.

## CBL controller front panel LEDs (without bezel)

The following table describes the definitions of the CBL controller front panel LEDs.

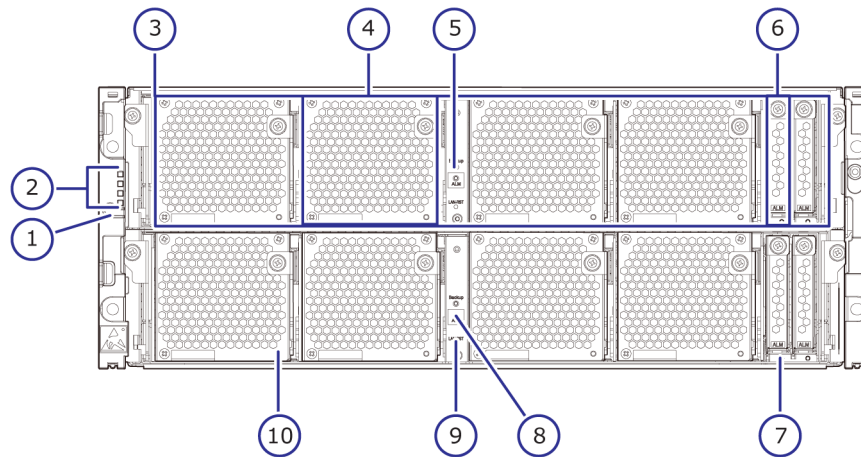

Number	Item	Description
1	POWER ON/OFF (main switch)	Powers the storage system.
2	POWER, READY, WARNING, and ALARM LEDs	<b>Note:</b> When System Option Mode 1097 is set to ON, the WARNING LED does not blink, even if the following failure service information messages (SIM) are issued: 452xxx, 462xxx, 3077xx, 4100xx, and 410100.
3	Controllers	Controller 1 (bottom) and Controller 2 (top).
4	Backup module	N/A



Number	Item	Description
5	BACKUP LED	<p>Green: Power restoration in progress following power outage.</p> <p>Fast blink green: Restoring.</p> <p>Slow blink green: Restoring, or sequential shutdown in progress.</p>
6	Cache flash memory	N/A
7	ALM LED (for cache flash memory)	Red: Cache flash memory can be removed.
8	CTL ALM LED	<p>Red: Controller can be removed.</p> <p>Blink red: Failure with the power supply unit of the controller.</p> <p>Amber: LAN reset switch was pressed.</p>
9	LAN-RST switch	Use only when instructed by customer support.
10	STATUS LED (for BKMF)	<p>Green: Charging of the battery in the backup module is complete.</p> <p>Red: Backup module can be removed.</p> <p>Blink red one time: Main battery failure.</p> <p>Blink red two times: Backup battery failure.</p> <p>Blink red three times: Both batteries failed or preventive maintenance replacement of batteries can run.</p>

Number	Item	Description
		Off: Battery is not mounted, battery-mounting failure occurred, or firmware is being upgraded. Off is normal status for configurations without batteries (for example, BKMF-10 and BKMF-20).

## CBL controller rear panel LEDs

The following table describes the definitions of the CBL controller rear panel LEDs.

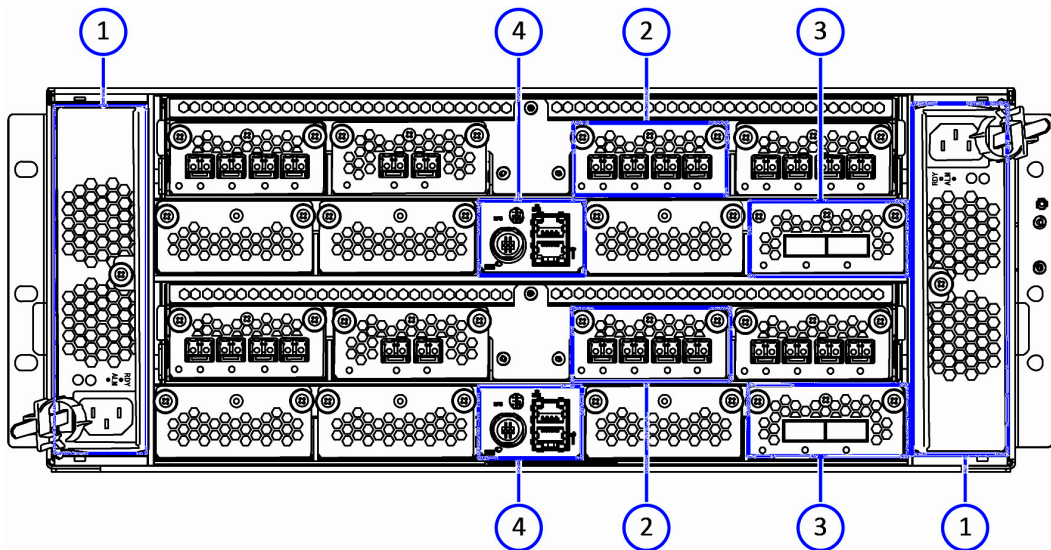

Number	Item
1	Power supply unit
2	Front end module
3	Back end module
4	LAN blade

## CBL controller power supply unit LEDs and connectors

The following table lists the definitions of the CBL controller power supply unit LEDs and connectors.

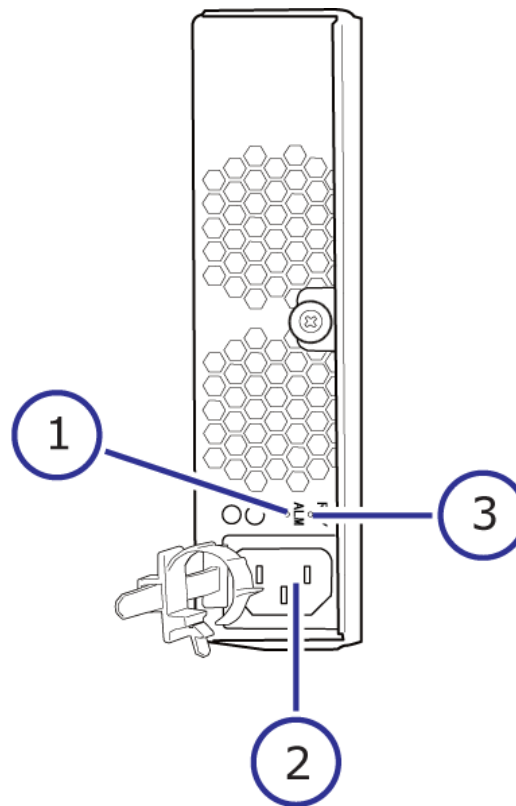

Number	Item	Description
1	ALM / RDY LED	Red: Power supply unit can be replaced.
2	Receptacle	Connects to the power cable provided with the storage system.
3	RDY LED	Green: Normal operation.

## Host, Network, and Drive Tray Ports and LEDs

The controllers are equipped with specific interfaces for connecting, powering, configuring, and managing the storage system. The component LEDs display the operating status of the storage system.

### Front-end modules

The front-end modules (FEMs), also called channel boards (CHBs), control the transfer of data between the host and cache memory. VSP G130, G/F350, G/F370, G/F700, G/F900 storage systems support Fibre Channel (FC) and iSCSI FEMs for attachment to host servers. The front-end module LEDs indicate the operating status of the module.

## 10-Gbps iSCSI board LEDs and connectors (optical)

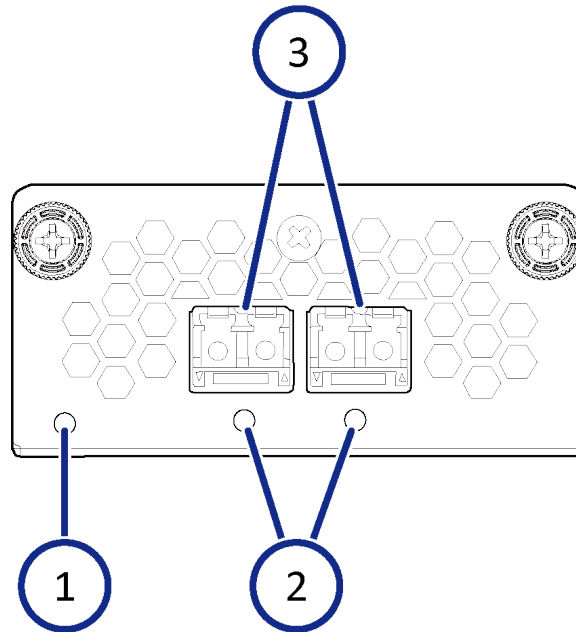

Number	Item	Description
1	STATUS LED	Green: Front-end module is in the power-on state. Red: Front-end module can be removed safely.
2	PORT LED	Red: Small form-factor (SFF) pluggable can be removed. Blue: Normal link status. Blink blue: Front-end module is in communication status.
3	iSCSI connectors	Connect to Ethernet cables.

## 10-Gbps iSCSI board LEDs and connectors (copper)

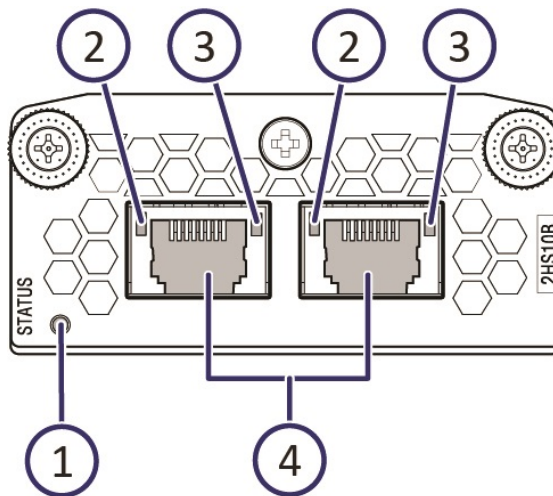

Number	Item	Description
1	STATUS LED	Green: Front-end module is in the power-on state. Red: Front-end module can be removed safely.
2	PORT (Link/Speed) LED	Yellow: 1-Gbps link. Green: 10-Gbps link. Off: No link connection.
3	PORT LED	Green: Link connection is established. Blinking: Communication is in progress. Off: No link connection or not ready to communicate.
4	iSCSI connectors	Connect to Ethernet cables.

**8-Gbps, 16-Gbps, or 32-Gbps Fibre Channel (4-port) board LEDs and connectors**

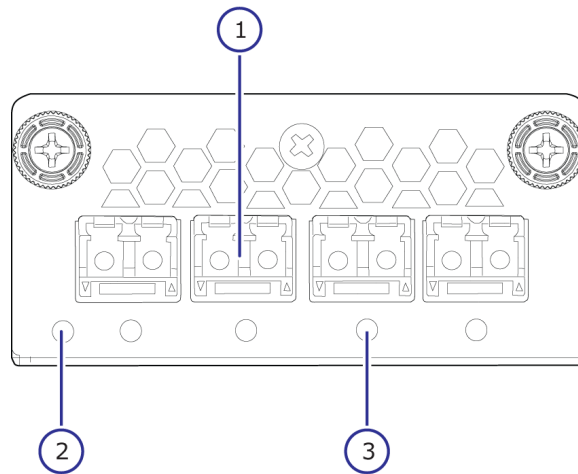

**Table 1 8-Gbps Fibre Channel**

Number	Item	Description
1	Fibre Channel connectors	Connect to Fibre Channel cables.
2	STATUS LED	Green: Front-end module is in power-on state. Red: Front-end module can be removed safely.
3	PORT LED	Red: Small form-factor pluggable can be removed. Blue: Normal link status at 8-Gbps. Green: Normal link status at 2-Gbps or 4-Gbps.

**Table 2 32-Gbps, 16-Gbps Fibre Channel**

Number	Item	Description
1	Fibre Channel connectors	Connect to Fibre Channel cables.
2	STATUS LED	Green: Front-end module is in power-on state. Red: Front-end module can be removed safely.
3	PORT LED	Red: Small form-factor (SFF) pluggable can be removed.

Number	Item	Description
		<p>Blue: Normal link status at 16-Gbps (16-Gbps).</p> <p>Blue: Normal link status at 32-Gbps (32-Gbps).</p> <p>Green: Normal link status at 4-Gbps or 8-Gbps (16-Gbps).</p> <p>Green: Normal link status at 8-Gbps or 16-Gbps (32-Gbps).</p>

### Port assignments

CHB number	8-Gbps, 16-Gbps, or 32-Gbps Fibre Channel ports (left to right)			
	Port 1	Port 2	Port 3	Port 4
CHB-1A	1A	3A	5A	7A
CHB-1B	1B	3B	5B	7B
CHB-1C	1C	3C	5C	7C
CHB-1D	1D	3D	5D	7D
CHB-1E	1E	3E	5E	7E
CHB-1F	1F	3F	5F	7F
CHB-1G	1G	3G	5G	7G
CHB-1H	1H	3H	5H	7H
CHB-2A	2A	4A	6A	8A
CHB-2B	2B	4B	6B	8B
CHB-2C	2C	4C	6C	8C
CHB-2D	2D	4D	6D	8D
CHB-2E	2E	4E	6E	8E
CHB-2F	2F	4F	6F	8F
CHB-2G	2G	4G	6G	8G
CHB-2H	2H	4H	6H	8H

## 16-Gbps Fibre Channel (2-port) board LEDs and connectors

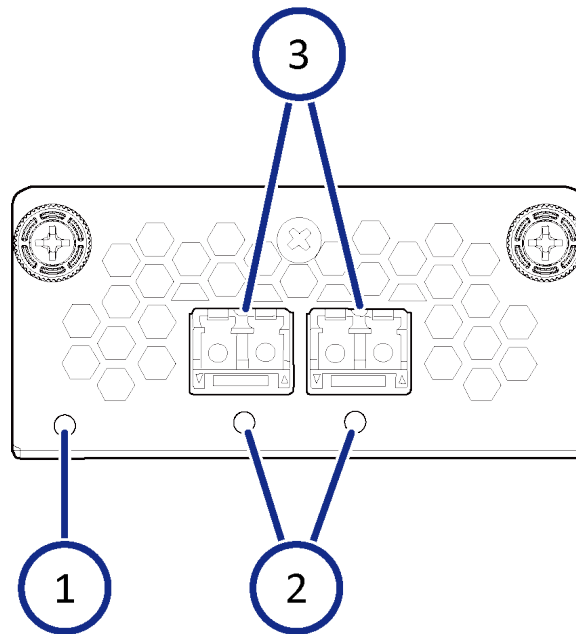

Number	Item	Description
1	STATUS LED	Green: Front end module is in the power-on state. Red: Front end module can be removed safely.
2	PORT LED	Red: Small form-factor pluggable can be removed. Blue: Normal link status at 16-Gbps. Green: Normal link status at 4-Gbps or 8-Gbps.
3	Fibre Channel connectors	Connect to Fibre Channel cables.

### Port assignments

CHB number	16-Gbps Fibre Channel ports (left to right)	
	Port 1	Port 2
CHB-1A	1A	3A
CHB-1B	1B	3B



CHB number	16-Gbps Fibre Channel ports (left to right)	
	Port 1	Port 2
CHB-1C	1C	3C
CHB-1D	1D	3D
CHB-1E	1E	3E
CHB-1F	1F	3F
CHB-1G	1G	3G
CHB-1H	1H	3H
CHB-2A	2A	4A
CHB-2B	2B	4B
CHB-2C	2C	4C
CHB-2D	2D	4D
CHB-2E	2E	4E
CHB-2F	2F	4F
CHB-2G	2G	4G
CHB-2H	2H	4H

PCIe module

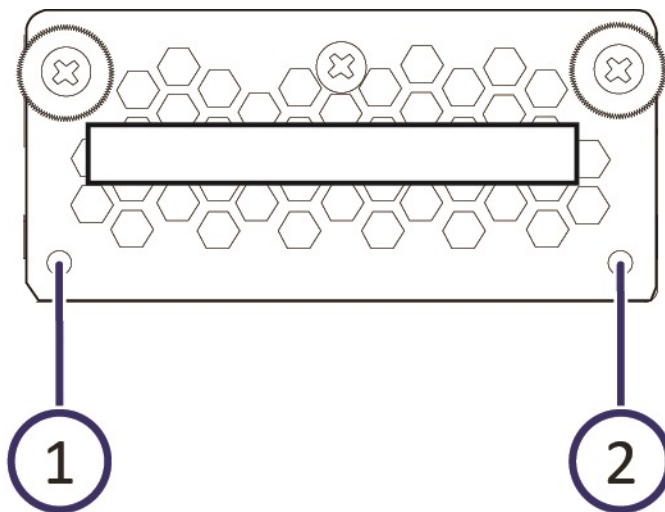

Number	Item	Description
1	STATUS LED	Green: PCIe module is in the power-ON status. Red: PCIe module failure occurred. Off: PCIe module can be removed safely.
2	Link	Green: PCIe is Gen-3 (8-Gbps) and is linked up normally. Off: PCIe is not linked up (PCIe cable might not be connected). If a PCIe cable is connected, it can be removed safely.

## LAN blade LEDs and connectors

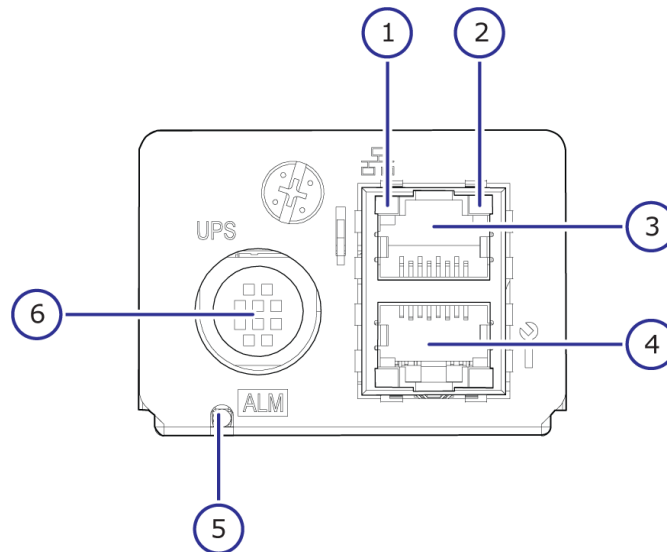

Number	Item	Description
1	LINK LED	Green: Link status is normal.
2	ACT LED	Orange: Data is being transferred.
3	LAN 2	LAN port used by the user.
4	LAN 1	Maintenance LAN port used by service personnel.
5	LAN ALARM LED	Red: LAN blade can be removed.
6	Uninterruptible power supply (UPS) port	N/A

## Back-end modules

The back-end modules (BEMs), also called disk boards (DKBs), control the transfer of data between the drives and cache memory. The back-end module LEDs indicate the operating status of the module.

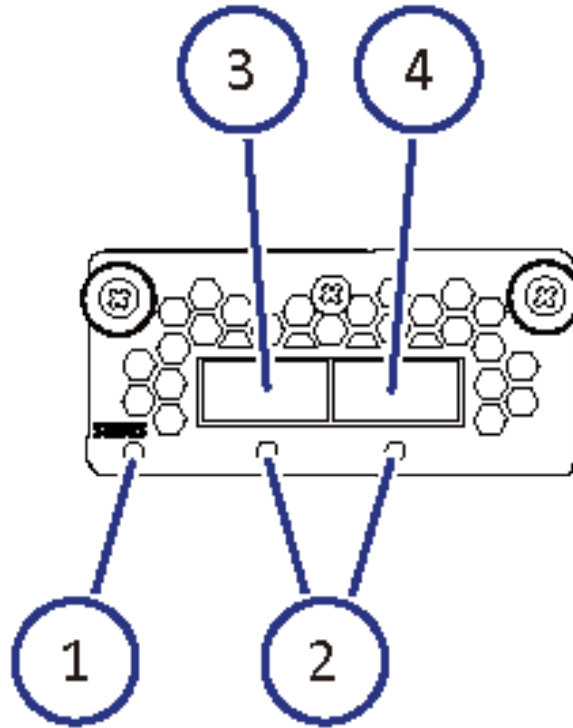

Number	Item	Description
1	STATUS LED	Green: Back-end module is in the power-on state. Red: Back-end module can be removed safely.
2	PORT LED	Blue: Link status is normal.
3	PATH 0 connector	Connect to a drive tray.
4	PATH 1 connector	Connects to a drive tray.

## Chapter 3: Drive trays

The drive tray contains data drives, power supplies, fans, and status LEDs. Each drive tray provides interfaces for connecting to controllers and other drive trays. The all-flash storage arrays have various fixed storage capacity configurations with flash storage devices. To deliver consistent low latency host response times and highest IOP performance across all host connection ports, conventional hard disk drives (HDD) are not included or configurable with all-flash arrays.

### Small form-factor drive tray (DBS/DBSE)

The following describes the physical specifications of the small form-factor drive tray.

Name	Model name	Height	Number of drive slots	Drive type
DBS	DW-F800-DBSC	2U (88.2 mm)	24	2.5 inch (SFF)
DBSE	DW-F800-DBSE	2U (88.2 mm)	24	2.5 inch (SFF)

### SFF with front panel bezel

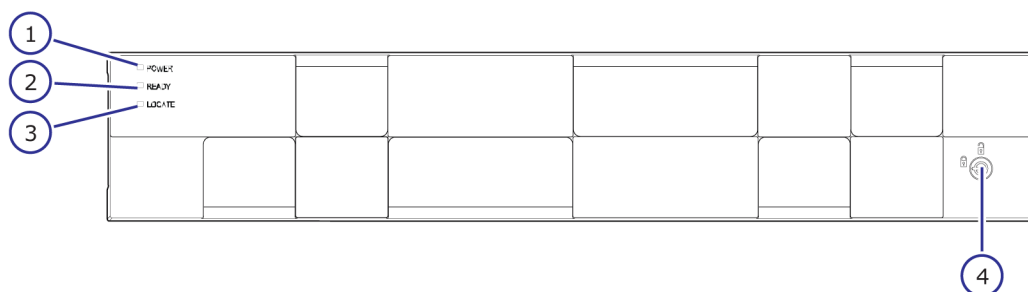

Number	Item	Description
1	POWER LED	Green: Drive tray is powered on.
2	READY LED	Green: Drive tray is operational.

Number	Item	Description
3	Locate LED	Amber: <ul style="list-style-type: none"> <li>Indicates the location of the chassis.</li> <li>Can be turned on or turned off by the maintenance utility.</li> </ul>
4	Lock	Locks and unlocks the front panel bezel by using the supplied key.

### SFF front panel without bezel

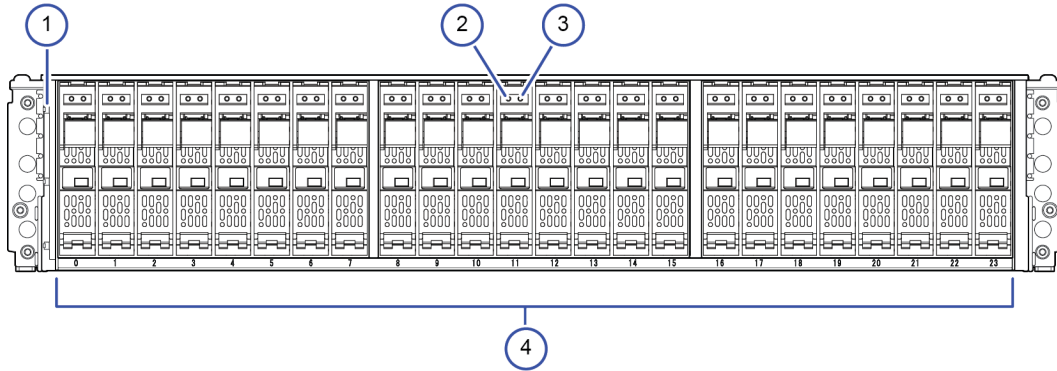

Number	Item	Description
1	POWER, READY, and LOCATE LEDs	Green: Drive tray is powered on.
		Green: Drive tray is operational.
		Amber: <ul style="list-style-type: none"> <li>Indicates the location of the chassis.</li> <li>Can be turned on or turned off by the maintenance utility.</li> </ul>
2	ALM LED	Red: Drive stopped due to a failure and can be replaced.
3	ACT LED	Green: Normal operation.

Number	Item	Description
		Blink green: Drive is being accessed.
4	Small form-factor drives	The twenty-four 2.5-inch small form factor drives are positioned vertically. The slots are organized from 0 to 23.

### SFF rear panel

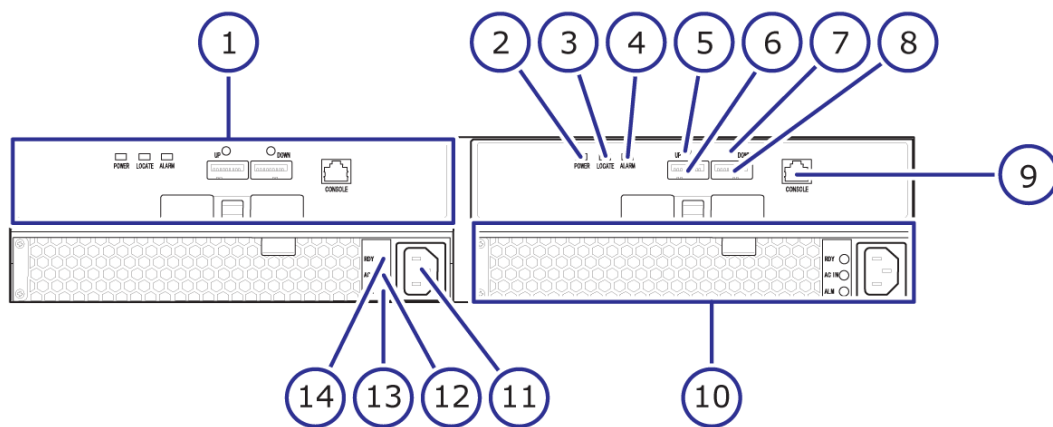

Number	Item	Description
1	ENC	N/A
2	POWER LED	Green: ENC is in the power-on state.
3	Locate LED	Amber: <ul style="list-style-type: none"> <li>Indicates the location of the chassis.</li> <li>Can be turned on or turned off by the maintenance utility.</li> </ul>
4	ALARM LED	Red: ENC can be replaced.
5	PATH (IN) LED	Blue: IN side port is linked up.
6	PATH (IN) connector	Connects to a controller or drive tray.

Number	Item	Description
7	PATH (OUT) LED	Blue: OUT side port is linked up.
8	PATH (OUT) connector	Connects to a drive tray.
9	Console	This port is reserved.
10	Power supply unit	N/A
11	Receptacle	Connects to the power cable provided with the storage system.
12	AC IN LED	Green: Normal operation.
13	ALM LED	Red: Power supply unit can be replaced.
14	RDY LED	Green: Normal operation.

## AC power supply unit LEDs and connectors

Both SFF and LFF drive trays are equipped with AC power supply units. The AC power supply units include LEDs to display its operating status.



### Note:

The DBS and DBL power supply has a Silver efficiency rating.

The DBSE and DBLE power supply has a Platinum efficiency rating.

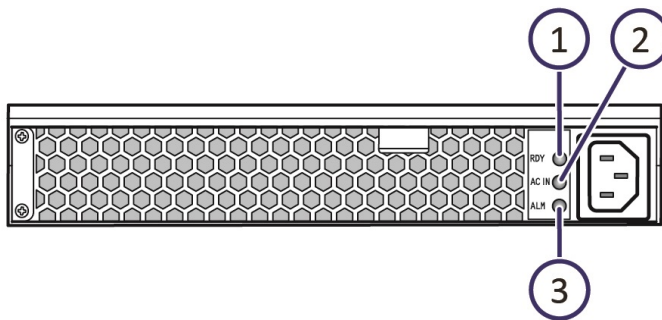

Number	Item	Description
1	RDY LED	Green: Normal operation.
2	ACI IN LED	Green: AC input is operating normally.

Number	Item	Description
3	ALM LED	Red: Power supply unit can be replaced.

## Flash module drive tray (DBF)

The following describes the physical specifications of the flash module drive tray.

Name	Model name	Height	Number of drive slots	Drive type
DBF	DW-F800-DBF	2U (87 mm)	12	Flash module drive (FMD)

## FMD with front panel bezel

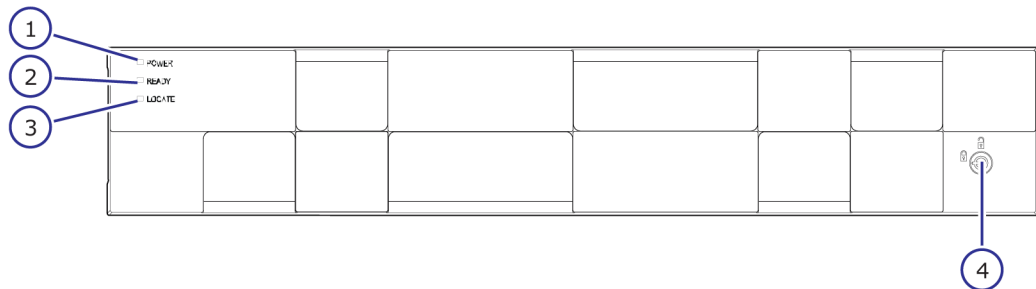

Number	Item	Description
1	POWER LED	Green: Drive tray is powered on.
2	READY LED	Green: Drive tray is operational.
3	Locate LED	Amber: <ul style="list-style-type: none"> <li>Indicates the location of the chassis.</li> <li>Can be turned on or turned off by the maintenance utility.</li> </ul>
4	Lock	Locks and unlocks the front panel bezel by using the supplied key.



### FMD front panel without bezel

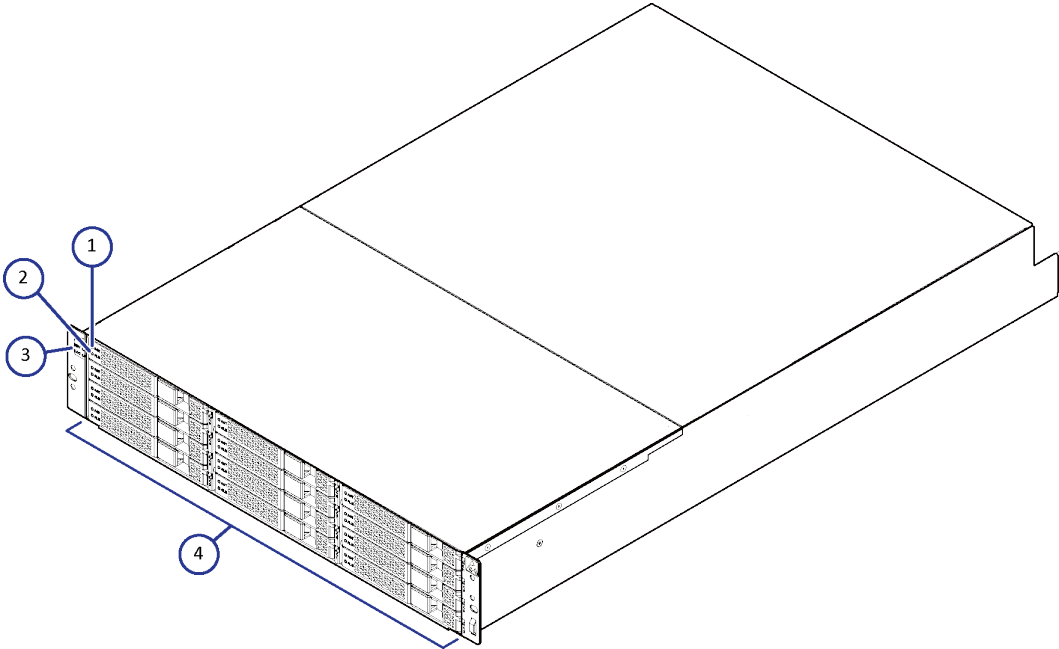

Number	Item	Description
1, 2	ACT LED	Green: Normal operation. Blink: Drive is being accessed. Slow blink indicates the FMD is in the process of startup. When powered, the LED blinks for about two to five minutes until the startup processing is complete.
	ALM LED	Red: Drive stopped due to a failure and can be replaced. <b>Note:</b> ACT indicator is only printed on some types of FMDs.
3	POWER, READY, and LOCATE LEDs	Green: Drive tray is powered on.
		Green: Drive tray is operational.

Number	Item	Description
		Amber: <ul style="list-style-type: none"> <li>Indicates the location of the chassis.</li> <li>Can be turned on or turned off by the maintenance utility.</li> </ul>
4	Flash module drives	Twelve flash module drives. Slots are organized the following way: 9, 10, 11 6, 7, 8 3, 4, 5 0, 1, 2

### FMD rear panel

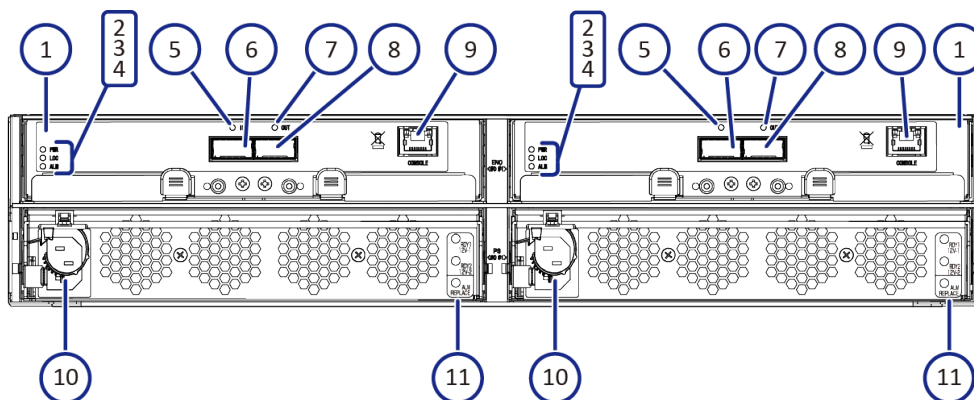

Number	Item	Description
1	ENC	N/A
2	POWER LED	Green: ENC is in the power-on state.
3	Locate LED	Amber: <ul style="list-style-type: none"> <li>Indicates the location of the chassis.</li> <li>Can be turned on or turned off by the maintenance utility.</li> </ul>

Number	Item	Description
4	ALARM LED	Red: ENC can be replaced.
5	PATH (IN) LED	Blue: IN side port is linked up.
6	PATH (IN) connector	Connects to a controller or drive tray.
7	PATH (OUT) LED	Blue: OUT side port is linked up.
8	PATH (OUT) connector	Connects to a drive tray.
9	Console	This port is reserved.
10	Receptacle	Connects to the power cable provided with the storage system.
11	Three LEDs, top to bottom: RDY LED AC IN LED ALM REPLACE LED	Green: Power supply unit is operating normally.
		Green: Power supply unit is operating normally.
		Red: Power supply unit can be replaced.

## Chapter 4: Host port expansion chassis

The host port expansion chassis contains various interconnect adapters that connect a host system to storage and other network devices. The interconnect adapters include PCIe boards and iSCSI and FC cards. For more information, contact customer support.

### Host port expansion chassis front panel bezel LEDs

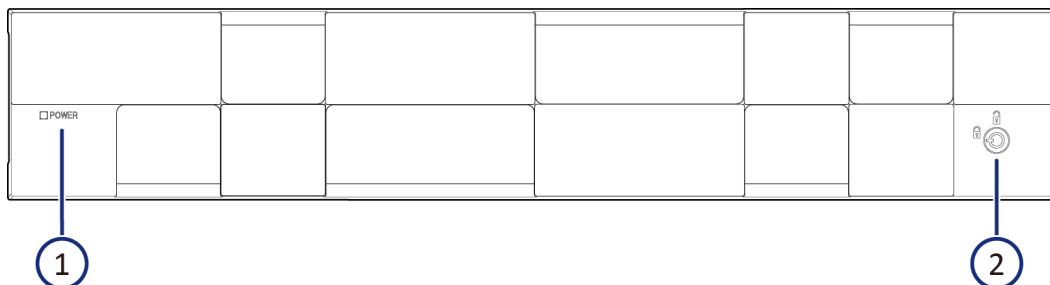

Number	Item	Description
1	POWER LED	Green: Host port expansion is turned on. Amber: PCIe module is turned on. Off: PCIe module is turned off.
2	Safety lock	Lock or unlock the front bezel.

### PCIe switchboard

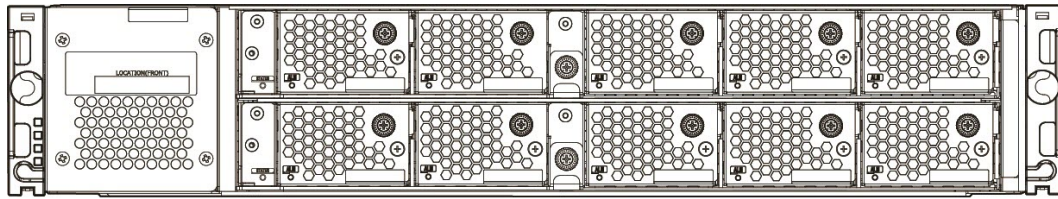

Front view of Expansion Chassis

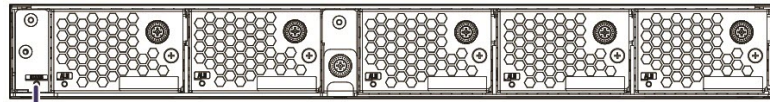

1

PCIe Switchboard

Number	Item	Description
1	STATUS LED	Green: PCIe switchboard is powered on. Red: PCIe switchboard can be replaced safely. Off: PCIe switchboard is powered off.

## Host port expansion chassis fan

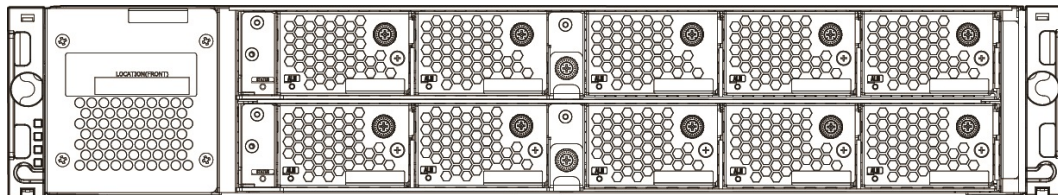

Front View of Expansion Chassis

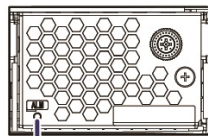

1

Expansion Chassis Fan

Number	Item	Description
1	ALM LED	Red: Fan failure has occurred. Off: Normal operation.

## PCIe cable connector

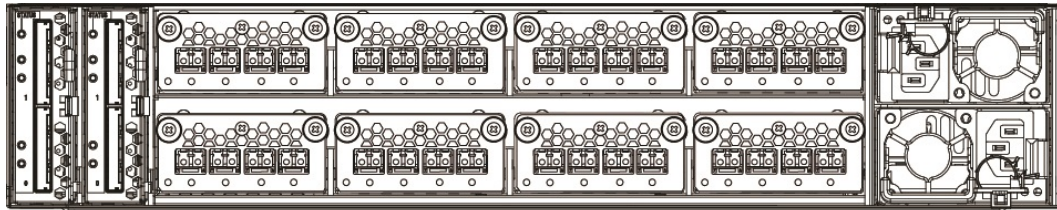

Rear View of Expansion Chassis

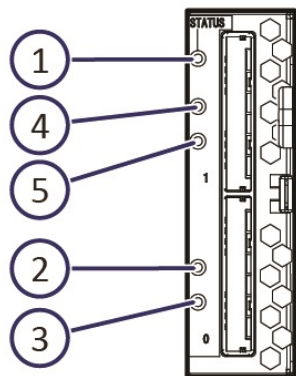

PCIe Cable Connector

Number	Item	Description
1	STATUS LED	Green: PCIe cable connector is powered on. Red: PCIe cable connector can be replaced safely. Off: PCIe cable connector is powered off.
2	Link Basic LED	Green: Basic PCIe Gen-3.0 (8-Gbps) is linked up normally. Off: Basic PCIe is not linked up (PCIe cable might not be connected). If a cable is connected, it can be removed safely.
3	InAct Basic LED	Amber: Basic PCIe status changed from link up to link down and cables. Cables can be removed safely. Off: Basic PCIe is normal or not set.

Number	Item	Description
4	Link Option LED	Green: Option PCIe Gen-3.0 (8-Gbps) is linked up normally. Off: Option PCIe is not linked up (PCIe cable might not be connected). If a cable is connected, it can be removed safely.
5	InAct Option LED	Amber: Option PCIe status changed from link up to link down and cables. Cables can be removed safely. Off: Option PCIe is normal or not set.

## Host port expansion chassis power supply

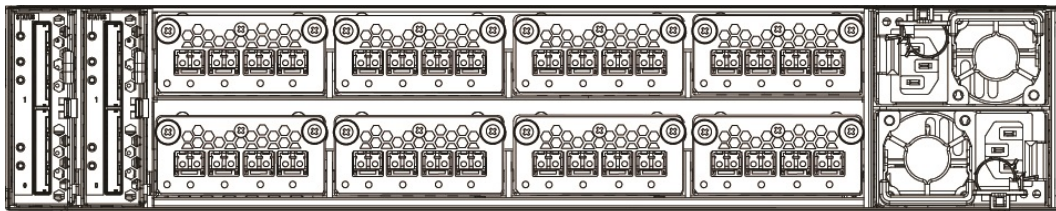

Rear View of the Expansion Chassis

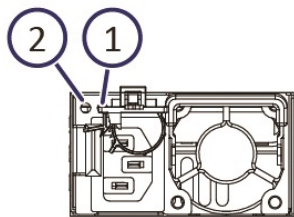

Expansion Chassis Power Supply 2

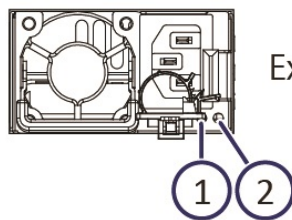

Expansion Chassis Power Supply 1

Number	Item	Description
1	ALM / RDY LED	Red: Host port expansion chassis power supply can be replaced safely. Green: Normal operation.

Number	Item	Description
2	AC IN LED	Blue: AC input is normal.



---

## Chapter 5: Service processor

The VSP Fx00 models include an optional, separate 1U service processor (SVP) dedicated to host an element manager (Storage Navigator). The SVP operates independently from the CPU of the storage system and operating system, and provides out-of-band configuration and management of the storage system. The SVP also monitors and collects performance data for key components of the storage system to enable diagnostic testing and analysis for customer support.

The SVP is also available as a 64-bit software application provided by Hitachi Vantara. For the latest interoperability updates and details, see the *SVP (Service Processor) OS and Hypervisor support* report at [https://support.hitachivantara.com/en\\_us/interoperability.html](https://support.hitachivantara.com/en_us/interoperability.html).

### Service Processor (Windows 10 Enterprise) hardware specifications

The following table lists the hardware specifications for the service processor (Windows 10 Enterprise) provided by Hitachi Vantara.

Item	Specification
Dimensions	Height: 1.7 inches (43 mm) Width: 17.2 inches (437 mm) Depth: 9.8 inches (249 mm) Weight: 10 lbs (4.5 kg)
Processor	Intel N3710 Pentium processor, 4C/4 threads, 1.6 GHz 2M cache, 6W
Memory	2 x 4 GB DDR3 1600MHz
Storage media	1 TB 5400 RPM SATA HDD
Network interface card	1-GbE x 4 ports (on-board NIC) x1 IPMI (BMC) port
Fans	2 x 4028 mm 13KPRM 4-pin PWM fans
Operating system	Windows 10 Enterprise
Maximum temperature	Up to 40° C (104° Fahrenheit)

Item	Specification
	The SVP is supported in high-temperature environments. Do not operate in any location with temperatures above 40°C (104° Fahrenheit).

## Service processor description

The SVP provides four RJ-45 ports:

- Two ports connect to the storage system controllers (one port for each controller).
- One port connects to the IP network of the user.
- One port connects to a user-supplied management console PC.



**Note:** This product is also designed for IT power distribution systems with phase-to-phase voltage.

Three of the four RJ-45 ports (which connect to the controllers and the IP network) are configured as a bridge. The SVP can be addressed using the default IP address 192.168.0.15.

In the unlikely event you cannot connect to the SVP using the default IP address, use the following emergency login: `http://<default SVP IP address>/dev/storage/<model number><system serial number>/emergency.do`. For example:

Storage system model number	Storage system serial number	URL
8320004	456789	<code>http://192.168.0.15/dev/storage/8320004456789/emergency.do</code>
8340004	456789	<code>http://192.168.0.15/dev/storage/8340004456789/emergency.do</code>
8360004	456789	<code>http://192.168.0.15/dev/storage/8360004456789/emergency.do</code>

Users are responsible for adopting the appropriate security procedures with the SVP, including:

- Applying Windows security patches.
- Turning on automatic Windows updates or using the manual Windows update method.
- Installing antivirus software that has been tested and approved by Hitachi.

## SVP (Windows 10 Enterprise) front panel

The front panel of the physical SVP with Windows 10 Enterprise operating system is equipped with LEDs, a reset button, and a power button.

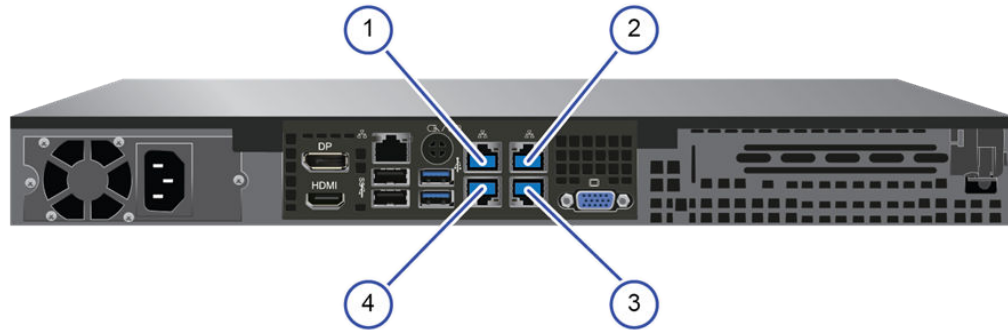

**Table 3 SVP (Windows 10 Enterprise) front panel**

Item	Description
1	LED (left to right): <ul style="list-style-type: none"> <li>▪ N/A</li> <li>▪ LAN card 2</li> <li>▪ LAN card 1</li> <li>▪ Hard drive</li> <li>▪ System standby power</li> </ul>
2	Reset button
3	Power button

## SVP (Windows 10 Enterprise) rear panel

The only ports used at the rear panel of the physical SVP are the power socket and the four LAN ports. The following ports connect to your IP network, the management console PC, and the user LAN port on each storage system controller.



**Table 4 SVP (Windows 10 Enterprise) rear panel**

Item	Description
1	Management (DKC CTL1) - LAN3 port
2	Management (DKC CTL2) - LAN4 port
3	Maintenance - LAN2 port
4	Management (User) - LAN1 port

The SVP running Windows 10 operating system does not provide an option to disable Spanning Tree Protocol (STP). If your network has BPDU enabled to prevent loops, connect the user LAN port on controllers 1 and 2 to an Ethernet switch that is also connected to the LAN1 port on the SVP.



**Note:** The SVP's default MTU size is 1500.

After the Initial Startup Wizard is complete, the SVP can be used in non-bridge mode. In this mode, the cables can be removed from SVP ports LAN3 and LAN4 and attached to switches. For more information, contact customer support.

---

## Chapter 6: Maintaining the storage system

Ongoing proper maintenance of the storage system maintains the reliability of the storage system and its constant availability to all hosts connected to it.

For more complex maintenance activities, contact customer support.

### Storing the storage system

If the storage system does not receive power for more than six months, the battery can become discharged and possibly damaged. To avoid this situation, charge the battery for more than three hours at least once every six months.



**Note:** Do not store the equipment in an environment with temperatures of 104°F (40°C) or higher because battery life will be shortened.

### Powering off the storage system

Use the following procedure to power off the VSP E990 storage system. The main switch on the controller chassis is used to power off the storage system.

#### Before you begin

- Ensure that all software-specific shutdown procedures have been completed. Refer to the applicable user manuals for details.
- Ensure that all I/O activity to the storage system has stopped. You can vary paths offline and shut down the attached hosts.

#### Procedure

1. Press the main switch on the controller chassis for approximately three seconds until the `POWER` LED on the front of the chassis changes from solid green to a blinking status.
2. Release the main switch and the `POWER` LED returns to solid green after blinking for approximately three seconds.  
The power-off process begins. The process takes approximately 18 minutes or longer depending on the amount of data that needs to be written. The `POWER` LED is solid green during the powering off process. The `POWER` LED changes from green to amber when the process is completed.
3. Verify the `POWER` LED on the front of the storage system changes from green to amber.

4. To stop the power supply, remove the power cables from the power supply units on the controller chassis and drive box.

If the storage system is connected to a PDU, you can stop the power supply by turning off the PDU breaker.



**Note:** If the storage system does not receive power for more than six months, the battery can become discharged and possibly damaged. To avoid this situation, charge the battery for more than three hours at least once every six months.

## Battery unit

### Battery lifetime

The battery life time is affected by the battery temperature. The battery temperature changes depending on the intake temperature and height of the storage system, the configuration, operation of the controller boards and drives, charge-discharge count and others. The battery lifetime will be three to five years.

### Treatment

Use the storage system in a place where the ambient temperature is 86°F (30°C) or less on average.

Periodic parts replacement is required. If you have a maintenance service contract, parts are replaced periodically according to the terms of the contract.



**Note:** The battery protects the data in the cache memory in an emergency, such as a sudden power failure. In these cases, follow the normal power down procedure. If not, the battery might reach its lifespan earlier than expected and become unusable within three years. When replacing the battery, follow the given procedure for disposing a used battery.

### Replacement period

The battery lifetime (intake temperature is 30 degrees C or less.) in the standard environment is as shown below.

Storage System Intake Temperature	CBL
Up to 24 degrees Celsius	5 years
Up to 30 degrees Celsius	5 years
Up to 34 degrees Celsius	4 years
Up to 40 degrees Celsius	3 years

---

## Appendix A: Storage system parts list

The following parts list describes the standard and optional hardware components for the storage systems.

For more information about the storage system, contact an Hitachi Vantara sales representative.

### VSP F900 parts list

The VSP F900 includes the following standard and optional components.

**Table 5 CBL controller components**

Model number	Part description	Quantity
DW850-CBL	4U chassis	1
	Power supply unit	2
	LAN board (LAN/UPS)	2
	Backup module (BKM)	8
	Front bezel (4U)	1
	Binder	1
	SAS cable label	2
DW-F800-RRCB	Rail kit	1
DW-F800-BAT	Battery	6

**Table 6 CBL optional controller components**

Model number	Part description	Quantity
DW-F850-CTLH	Controller board	2
DW-F850-CM32G <sup>1</sup>	Cache memory (32 GB)	8-16
DW-F850-CM64G <sup>1</sup>	Cache memory (64 GB)	8-16
DW-F850-BM35	Cache flash memory (CFM)	2-4
DW-F850-BM45	Cache flash memory (CFM)	2-4
DW-F800-2HS10S	Front-end module (also know as a channel board) (10-Gbps SFP optic-iSCSI)	2-16
DW-F800-2HS10B	Front-end (10-Gbps copper-iSCSI)	2-16
DW-F800-4HF32R	Front-end (32/16-Gbps 4port-FC)	2-16
DW-F800-1HP8	PCIe switchboard (also known as a channel board)	2
DW-F800-PC1F	PCIe cable (1.5m)	2
DW-F800-BS12G	Back-end module (also known as disk board)	0-8
DW-F800-BS12GE	Back-end module with encryption	0-8
DW-F800-1PS16	SFP for 16 Gbps Shortwave	0-64
DW-F800-1PL16	SFP for 16 Gbps Longwave	0-64
DW-F800-1PL32	SFP for 32 Gbps Longwave	0-64
DW-F800-BAT	Battery	0-6
<p><b>Note:</b></p> <p>1. A DIMM of a particular capacity cannot be mixed with different capacities in a storage system configuration.</p>		



**Table 7 DBF drive tray components**

Model number	Part description	Quantity
DW-F800-DBF	2U chassis	1
	ENC	2
	Power supply unit	2
	Front bezel (2U)	1
DW-F800-RRDBF	Rail kit	1

**Table 8 DBF optional drive tray components**

Model number	Part description	Quantity
DKC-F810I-3R2FN	3.5 TB, MLC 12 Gbps, flash module drive	0-12
DKC-F810I-7R0FP	7 TB, MLC/TLC 12 Gbps, flash module drive	0-12
DKC-F810I-14RFP	14 TB, MLC/TLC 12 Gbps, flash module drive	0-12

**Table 9 DBS drive tray components**

Model number	Part description	Quantity
DW-F800-DBSC	2U chassis	1
	ENC	2
	AC Power supply unit	2
	Front bezel (2U)	1
DW-F800-RRDB	Rail kit	1

**Table 10 DBS optional drive tray components**

Model number	Part description	Quantity
DKC-F810I-960MGM	960 GB, MLC, 12 Gbps, SFF, flash drive	0-24
DKC-F810I-1R9MGM	1.9 TB, MLC/TLC, 12 Gbps, SFF, flash drive	0-24
DKC-F810I-1T9MGM	1.9 TB, TLC, 12 Gbps, SFF, flash drive	0-24
DKC-F810I-3R8MGM	3.8 TB, MLC/TLC, 12 Gbps, SFF, flash drive	0-24
DKC-F810I-7R6MGM	7.6 TB, TLC, 12 Gbps, SFF, flash drive	0-24
DKC-F810I-15RMGM	15 TB, TLC, 12 Gbps, SFF, flash drive	0-24
DKC-F810I-30RMGM	30 TB, TLC, 12 Gbps, SFF, flash drive	0-24

**Table 11 DBSE drive tray components**

Model number	Part description	Quantity
DW-F800-DBSE	2U chassis	1
	ENC	2
	AC Power supply unit	2
	Front bezel (2U)	1
DW-F800-RRDB	Rail kit	1

**Table 12 DBSE optional drive tray components**

Model number	Part description	Quantity
DKC-F810I-960MGM	960 GB, MLC, 12 Gbps, SFF, flash drive	0-24
DKC-F810I-1R9MGM	1.9 TB, MLC/TLC, 12 Gbps, SFF, flash drive	0-24
DKC-F810I-1T9MGM	1.9 TB, TLC, 12 Gbps, SFF, flash drive	0-24

Model number	Part description	Quantity
DKC-F810I-3R8MGM	3.8 TB, MLC/TLC, 12 Gbps, SFF, flash drive	0-24
DKC-F810I-7R6MGM	7.6 TB, TLC, 12 Gbps, SFF, flash drive	0-24
DKC-F810I-15RMGM	15 TB, TLC, 12 Gbps, SFF, flash drive	0-24
DKC-F810I-30RMGM	30 TB, TLC, 12 Gbps, SFF, flash drive	0-24

Table 13 Host port expansion chassis components

Model number	Part description	Quantity
DW-F800-CHBB	PCP module	2
	Host port expansion chassis (also known as an I/O expansion box - CHBB chassis)	1
	Power supply unit	2
	PCIe switchboard (fan x 5)	2
	PCIe module	2
	PCIe cable (1.5m)	2
	Front bezel	1
	Accessories kit	1

Table 14 Optional service processor

Model number	Part description	Quantity
HDW-F850-SVP.P	Service processor (Windows 10 Enterprise)	1

## Drive tray and drive configuration

The following table lists the supported maximum installable drive trays and data drives for the VSP F900 storage system.

Controller chassis	Number of mountable drive trays		Maximum number of mountable drives	
	Drive trays	Maximum	Solid-state drive	Flash module drive (FMD)
CBL	DBS/DBSE	48	1,152	N/A
	DBF	48	N/A	576

## Data and power cable model list

The following tables list the data and power cables available to the storage system.

**Table 15 Power cables**

Model number	Specification
DW-F800-J1K	2.5 m, 2-pole power cable with grounding terminal (AC 125 V, 13 A or 15 A)
DW-F800-J2H	2.5 m, 2-pole power cable with grounding terminal (AC 250 V, 13 A or 15 A)
DW-F800-J2H5	5.0 m, 2-pole power cable with grounding terminal (AC 250 V, 13 A or 15 A)
DW-F800-J2H10	10.0 m, 2-pole power cable with grounding terminal (AC 250 V, 13 A or 15 A)
A-F6516-P620	Power cable for PDU (1)
A-F6516-P630	Power cable for PDU (1)

**Table 16 SAS cables**

Model number	Specification
DW-F800-SCQ1	1 m SAS cable, including omega clip (2)
DW-F800-SCQ1F	1.5 m SAS cable, including omega clips (2)
DW-F800-SCQ3	3 m SAS cable, including omega clips (2)
DW-F800-SCQ5	5 m SAS cable, including omega clips (2)
DW-F800-SCQ10A	10 m SAS optical cable
DW-F800-SCQ30A	30 m SAS optical cable
DW-F800-SCQ1HA	100 m SAS optical cable

**Table 17 Optical cables**

<b>Model number</b>	<b>Specification</b>
A-6515-GM5L	5 m LC-LC optical cable for optical
A-6515-GM10L	10 m LC-LC optical cable for optical
A-6515-GM20L	20 m LC-LC optical cable for optical
A-6515-GM30L	30 m LC-LC optical cable for optical
A-6515-GM40L	40 m LC-LC optical cable for optical
A-6515-GM50L	50 m LC-LC optical cable for optical
A-6515-GM1JL	100 m LC-LC optical cable for optical
A-6515-GS10L	10 m LC-LC optical cable for optical
A-6515-GS20L	20 m LC-LC optical cable for optical
A-6515-GS30L	30 m LC-LC optical cable for optical
A-6515-GS50L	50 m LC-LC optical cable for optical
A-6515-GS1JL	100 m LC-LC optical cable for optical
A-6515-HM5L	5 m LC-LC optical cable for optical
A-6515-HM10L	10 m LC-LC optical cable for optical
A-6515-HM20L	20 m LC-LC optical cable for optical
A-6515-HM30L	30 m LC-LC optical cable for optical
A-6515-HM50L	50 m LC-LC optical cable for optical
A-6515-HM100L	100 m LC-LC optical cable for optical
A-6515-HM200L	200 m LC-LC optical cable for optical
A-6515-HM300L	300 m LC-LC optical cable for optical
A-6515-JM5L	5 m LC-LC optical cable for optical
A-6515-JM10L	10 m LC-LC optical cable for optical
A-6515-JM20L	20 m LC-LC optical cable for optical
A-6515-JM30L	30 m LC-LC optical cable for optical
A-6515-JM50L	50 m LC-LC optical cable for optical
A-6515-JM100L	100 m LC-LC optical cable for optical
A-6515-JM200L	200 m LC-LC optical cable for optical

Model number	Specification
A-6515-JM300L	300 m LC-LC optical cable for optical

---

## Appendix B: System specifications

The mechanical, electrical, and environmental specifications of the storage system are listed.

### VSP F900 mechanical specifications

The following tables list the system specifications for VSP F900.

#### CBL controller chassis

Item	Specification
Physical dimension (W x D x H) (mm)	483 × 808.1 × 174.3 mm
Weight/Mass (kg) (Approximate)	29.8 kg
Start-up time (min)	5 to 10 (min) <sup>1</sup>
Required height (EIA unit) <sup>2</sup>	4U
Heat output (W)	338 W
Power consumption (VA)	363 VA
Air flow (m <sup>3</sup> /min) <sup>3</sup>	6.0 (m <sup>3</sup> /min)
<b>Notes:</b> <ol style="list-style-type: none"><li>1. The start-up time might be longer in proportion to the number of drive trays connected. With a maximum configuration 1 controller chassis and 19 drive trays, start-up time is approximately 8 minutes.</li><li>2. Can be mounted on the RKU rack. For the mounting, special rails for the rack and decoration panels are required separately depending on the number of the mounted storage systems.</li><li>3. The value is at maximum level.</li></ol>	



**Drive chassis**

Item	Component	Specification
Physical dimension (W x D x H) (mm)	DBF	483 × 762 × 87 mm
	DBS/DBSE	482 × 565 × 88.2 mm
Weight/Mass (kg) (Approximate)	DBF	19.3 kg
	DBS/DBSE	17 kg
Start-up time (min)	DBF	5 to 10 (min) <sup>1</sup>
	DBS/DBSE	5 to 8 (min) <sup>1</sup>
Required height (EIA unit) <sup>2</sup>	DBF	2U
	DBS/DBSE	
Heat output (W)	DBF	120 W
	DBS/DBSE	116 W
Power consumption (VA)	DBF	130 VA
	DBS/DBSE	126 VA
Air flow (m <sup>3</sup> /min) <sup>3</sup>	DBF	1.6
	DBS/DBSE	2.2 (m <sup>3</sup> /min)
<p><b>Notes:</b></p> <ol style="list-style-type: none"> <li>1. The start-up time might be longer in proportion to the number of drive trays connected. With a maximum configuration 1 controller chassis and 19 drive trays, start-up time is approximately 8 minutes.</li> <li>2. Can be mounted on the RKU rack. For the mounting, special rails for the rack and decoration panels are required separately depending on the number of the mounted storage systems.</li> <li>3. The value is at maximum level.</li> </ol>		

**Drive type**

Item	Specification	
Supported data capacity	945.23, 1890.46, 3780.92, 7561.85, 15048.49, 30095.00 GB (SSD)	
	3518.43, 7682.17, 15364.35 GB (FMD)	
Maximum storage system capacity (physical capacity)	15,766 TiB (using 15 TB SSD)	
	7,372 TiB (using 14 TB FMD)	
	31,531 TiB (using 30 TB SSD)	
Maximum mountable quantity (unit)	12 (total per chassis)	576 <sup>1</sup> (maximum per system)
Maximum number of spare drives	64 <sup>2</sup>	
<b>Note:</b> <ol style="list-style-type: none"> <li>When mounting storage system and DBF drive trays, the maximum mountable quantity (unit) may vary.</li> <li>Available as spare or data disks.</li> </ol>		

**Host interface**

Item	Specification
Interface type	16/32 Gbps FC (Optical) 10 Gbps iSCSI (Optical) 10 Gbps iSCSI (Copper)
Data transfer speed (Max. speed for transfer to host)	400 Mbps (FC) 800 Mbps (FC) 1600 Mbps (FC) 3200 Mbps (FC) 1000 Mbps (iSCSI - Optical) 1000 Mbps (iSCSI - Copper)
Number of ports	16/32 Gbps FC (Optical): 64 10 Gbps iSCSI (Optical): 32 10 Gbps iSCSI (Copper): 32
Number of ports	16/32 Gbps FC (Optical): 80

Item	Specification
(With CHBB installed)	10 Gbps iSCSI (Optical): 40 10 Gbps iSCSI (Copper): 40
Transferred block size (bytes)	512
Maximum number of hosts via FC switch	255
Maximum number of hosts via network switch	255

### Battery life

Storage system intake temperature	CBL
Up to 75.2° F (24° C)	5 years
Up to 86° F (30° C)	5 years
Up to 93.2° (34° C)	4 years
Up to 104° (40° C)	3 years

### RAID specifications

Item	
RAID level <sup>1</sup>	Flash drive mounted: 1/5/6
RAID configuration	RAID1: 2D+2D, 4D+4D RAID5: 3D+1P, 4D+1P, 6D+1P, 7D+1P

Item	
	RAID6: 6D+2P, 12D+2P, 14D+2P
Maximum number of parity groups	384
Maximum volume size	3 TB (when using the LDEVs of other Storage Systems: 4TB)
Maximum volumes/host groups and iSCSI targets	2048
Maximum volumes/parity groups	2048
<b>Note:</b>	
<ol style="list-style-type: none"> <li>1. A storage system configured with RAID6, RAID 5, or RAID 1 provides redundancy and enhances data reliability. However, there is still a possibility of losing data caused by unforeseeable hardware or software failure. Users should always follow recommended best practices and back up all data.</li> </ol>	

#### Internal logic specifications (CBL)

Item	Specification
Control memory	Flash memory: 32 MB L3 cache memory: 4 MB SDRAM: 1 GB
Data assurance method	Data bus: Parity Cache memory: ECC (1 bit correction, 2 bit detection) Drive: Data assurance code

### Cache specifications

Item	Specification
Capacity (per controller)	512 GB
Control method	Read LRU/Write after
Battery backup	Provided
Backup duration <sup>1</sup>	Unrestricted (Saving to a nonvolatile memory)
<b>Note:</b> 1. Non-volatile data in the cache memory is protected against sudden power failure. The backup operation writes data into a cache, even if a power interruption occurs, and transferred to the cache flash memory.	

### Insulation performance

Item	Specification
Insulation withstand voltage	AC 1,500 V (100mA, 1min)
Insulation resistance	DC 500 V, 10 MΩ or more

## Electrical specifications

The electrical input power specifications for the storage systems are described in the following table.

Item	Controller	Drive tray
Input voltage (operable voltage range) (V)	AC 200-240 +6%/-11%	FMD tray: AC 200-240 +6%/-11%
Frequency (Hz)	50/60 ±1	
Number of phases, cabling	Single-phase with protective grounding	
Steady-state current 100V/200V <sup>1, 2</sup>	CBL: 4.0x2	FMD tray: 2.6x2/1.3x2
Current rating of breaker/fuse (A)	16.0 (each electrical)	
Heat value (normal) (kJ/h)	CBL: 2810 or less	FMD tray: 1520 or less

Item	Controller	Drive tray
Steady-state power (VA/W) <sup>3</sup>	CBL: 1600/1560 or less	FMD tray: 520/490 or less
Power consumption (VA/W)	CBL: 840/780 or less	FMD tray: 440/420 or less
<b>Notes:</b> <ol style="list-style-type: none"> <li>1. The power current of Nx2 described in this table is required for a single power unit.</li> <li>2. If one power unit fails, another power unit requires electric current for the two power units. Therefore, plan the power supply facility so that the current-carrying capacity for one power unit can provide the total capacity for two power units.</li> <li>3. This table shows the power requirement (100 V or 200 V) for the maximum configuration . The actual required power might exceed the value shown in the table when the tolerance is included.</li> </ol>		

## Environmental specifications

The environmental specifications for the storage systems are described in the following table.

### Temperature



**Caution:** The following storage system components are not supported in high-temperature environments. Do not operate the following components at temperatures of 40°C or higher:

- Hitachi Vantara-provided service processor (SVP) server
- First-generation FMDs (non-DC2 FMDs)

State	Controller	FMD tray
Operating	50°F to 104°F (10°C to 40°C)	DKC-F810I-1R6FN/3R2FN/6R4FN/7R0FP/14RFP drive is installed: 50°F to 104°F (10°C to 40°C)
Non-operating	14°F to 122°F (-10°C to 50°C)	14°F to 95°F (-10°C to 35°C)
Transport, storage	-22°F to 140°F (-30°C to 60°C)	-22°F to 122°F (-30°C to 50°C)
Temperature change rate (°C/h)	10°C or less	

**Humidity**

State	FMD tray
Operating (%)	8 to 80
Non-operating (%)	8 to 90
Transport, storage (%)	5 to 95
Maximum wet bulb temperature (°C)	29°C (non-condensing)

**Vibration**

State	FMD tray
Operating (m/s <sup>2</sup> )	2.5 or less (5 to 300Hz) Within 5 seconds (resonance point: 10 Hz or less)
Non-operating (m/s <sup>2</sup> )	5.0 or less at (5 Hz to 300 Hz: no damage to product) 9.8 (1.0 G): Ensure own safety with fall prevention. Within 5 seconds (resonance point: 10 Hz or less)
Transport (packed) (m/s <sup>2</sup> )	5.0 m/s or less

**Impact**

State	CBL controller	FMD tray
Operating (m/s <sup>2</sup> )	20 or less (10 ms, half sine wave)	
Non-operating (m/s <sup>2</sup> )	50 or less (10 ms, half sine wave)	
Transport (packed) (m/s <sup>2</sup> )	80 or less	
Tipping angle (°) (Storage system tips over)	15° or less (To be measured when installed on leveling bolts.)	

**Altitude**

State	Controller	FMD tray
Operating (m)	3,050 (Environmental temperature: 10°C to 28°C)	3,050 (Environmental temperature: 10°C to 28°C) <sup>1</sup>
	950 (Environmental temperature: 10°C to 40°C)	950 (Environmental temperature: 10°C to 40°C)
Non-operating (m)	-60 to 12,000	
<p><b>Note:</b></p> <p><b>1.</b> Meets the highest allowable temperature conditions and complies with ASHRAE (American Society of Heating, Refrigerating and Air-Conditioning Engineers) 2011 Thermal Guidelines Class A3. The maximum value of the ambient temperature and the altitude is from 40°C at an altitude of 950m (3000 feet) to 28°C at an altitude of 3050m (1000 feet).</p> <p>The allowable ambient temperature is decreased by 1°C for every 175m increase in altitude above 950m.</p>		

**Gaseous contaminant**

Avoid areas exposed to corrosive gas and salty air.

State	Controller	FMD tray
Operating	Gaseous contamination should be within ANSI/ISA S71.04-2013 G1 classification levels. <sup>1</sup>	
Non-operating		
<p><sup>1</sup> Recommends the data centers maintain a clean operating environment by monitoring and controlling gaseous contamination.</p>		



## Acoustic Noise

The acoustic level is measured under the following conditions in accordance with ISO7779 and the value is declared based on ISO9296. In a normal installation area (data center / general office), the storage system is surrounded by different elements from the following measuring conditions according to ISO, such as noise sources other than the storage system (other devices), the walls and ceilings that reflect the sound. Therefore, the values described in the table do not guarantee the acoustic level in the actual installation area.

- Measurement environment: In a semi-anechoic room whose ambient temperature is  $23^{\circ}\text{C}\pm 2^{\circ}\text{C}$ .
- Device installation position: The Controller Chassis is at the bottom of the rack and the Drive Box is at a height of 1.5m in the rack.
- Measurement position: 1m away from the front, rear, left or right side of the storage system and 1.5m high (at four points).
- Measurement value: Energy average value of the four points (front, rear, left and right).

The recommendation is to install the storage system in a computer room in a data center. It is possible to install the storage system in a general office, however, take measures against noise as required. When you replace an existing storage system with another system in a general office, especially note the following: The cooling fans in the storage system are downsized to enhance the high density of the storage system. As a result, the rotation number of the fan is increased than before to maintain the cooling performance. Therefore, the rate of the noise occupied by high-frequency content is high.

State	Controller	DBS/DBSE drive tray
Operating	60 dB (Environmental temperature 32°C or less) <sup>1</sup>	60 dB (Environmental temperature 32°C or less) <sup>1, 2, 3</sup>
Non-operating	55 dB	55 dB

**Notes:**

1. The internal temperature of the system controls the rotating speed of the fan module. Therefore, this standard value might be exceeded if the maximum load continues under high-temperature environment or if a failure occurs in the system.
2. Sound pressure level (LA) changes from 66 dB or 75 dB, according to the ambient temperature, drive configuration, and operating status. Maximum volume can reach 79 dB during maintenance procedure for a failed ENC or power supply.
3. Acoustic power level (LwA) measured by the ISO 7779 standard is 7.2 B. This value changes from 7.2 B to 8.1 B, according to the ambient temperature, drive configuration, and operating status.

State	Controller	FMD tray
Operating	60 dB (Environmental temperature 32°C or less) <sup>1</sup>	60 dB (Environmental temperature 32°C or less) <sup>1, 2, 3</sup>
Non-operating	55 dB (Environmental temperature 32°C or less) <sup>1, 2, 3</sup> 55 dB	

**Notes:**

1. The internal temperature of the system controls the rotating speed of the fan module. Therefore, this standard value might be exceeded if the maximum load continues under high-temperature environment or if a failure occurs in the system.
2. Sound pressure level (LA) changes from 66 dB or 75 dB, according to the ambient temperature, drive configuration, and operating status. Maximum volume can reach 79 dB during maintenance procedure for a failed ENC or power supply.
3. Acoustic power level (LwA) measured by the ISO 7779 standard is 7.2 B. This value changes from 7.2 B to 8.1 B, according to the ambient temperature, drive configuration, and operating status.

**Noise Level**

State	Condition
Operating (Recommended)	90 dB or less*
<p><b>Note:</b></p> <p>*Fire suppression systems and acoustic noise:</p> <p>Some data center inert gas fire suppression systems when activated release gas from pressurized cylinders that moves through the pipes at very high velocity. The gas exits through multiple nozzles in the data center. The release through the nozzles could generate high-level acoustic noise. Similarly, pneumatic sirens could also generate high-level acoustic noise. These acoustic noises may cause vibrations to the hard disk drives in the storage systems resulting in I/O errors, performance degradation in and to some extent damage to the hard disk drives. Hard disk drives (HDD) noise level tolerance may vary among different models, designs, capacities and manufactures. The acoustic noise level of 90 dB or less in the operating environment table represents the current operating environment guidelines in which Hitachi storage systems are designed and manufactured for reliable operation when placed 2 meters from the source of the noise.</p> <p>Hitachi does not test storage systems and data drives (includes HDDs, SSDs, and FMDs) for compatibility with fire suppression systems and pneumatic sirens. Hitachi also does not provide recommendations or claim compatibility with any fire suppression systems and pneumatic sirens. The customer is responsible to follow their local or national regulations.</p> <p>To prevent unnecessary I/O error or damages to the hard disk drives in the storage systems, Hitachi recommends the following options:</p> <ol style="list-style-type: none"> <li>1. Install noise-reducing baffles to mitigate the noise to the hard disk drives in the storage systems.</li> <li>2. Consult the fire suppression system manufacturers on noise reduction nozzles to reduce the acoustic noise to protect the hard disk drives in the storage systems.</li> <li>3. Locate the storage system as far as possible from noise sources such as emergency sirens.</li> <li>4. If it can be safely done without risk of personal injury, shut down the storage systems to avoid data loss and damages to the hard disk drives in the storage systems.</li> </ol> <p>Damage to the hard disk drives from fire suppression systems or pneumatic sirens will void the hard disk drive warranty.</p>	

**Mechanical environmental conditions**

Item	Operating	Non-operating
Guaranteed value to vibration <sup>1</sup>	0.98m/s <sup>2</sup> (0.1G) or less [frequency component 5 to 100Hz] <sup>2</sup>	Same as left column
Guaranteed value to impact	No impact	78.4m/s <sup>2</sup> (8.0G), 15ms
Guaranteed value to seismic wave	2.5 m/s <sup>2</sup> (0.25G) or less (250gal approx.) <sup>3</sup>	3.9m/s <sup>2</sup> (0.4G) (400gal) or less : No critical damage for product function. (Normal operating with part replacement)  9.8m/s <sup>2</sup> (1.0G) (1,000gal) or less: Ensure own safety with fall prevention
<b>Notes:</b> <sup>1</sup> Vibration that is constantly applied to the storage system due to construction works and so on. <sup>2</sup> Compliant with NEBS (Network Equipment-Building System) Office Vibration standards (GR-63-CORE zone4). <sup>3</sup> Compliant with IEC (International Electrotechnical Commission) standards, IEC 61584-5/Ed1 and IEC60297-Part5 (scenic test at the maximum acceleration rate of 9.8m/s <sup>2</sup> (1.0G) equivalent to NEBS (Network Equipment-Building System) Level3).		

**Shared memory**

Using Hitachi software products, the number of pairs, migration plans, and pool capacities and virtual volumes depend on the amount of capacity of shared memory installed on the controller.

The shared memory capacity allocated by shared memory function and the cache memory capacity required for adding shard memory function vary depending on storage system models.

Software	Items affected by shared memory capacity
ShadowImage TrueCopy Universal Replicator	The number of pairs that can be created.  For more information, refer to the specific software user guide.

Software	Items affected by shared memory capacity
global-active device	
Volume Migration Volume Migration V2	The number of migration plans that can be executed concurrently.  For more information, refer to the specific software user guide.
Dynamic Provisioning Dynamic Tiering active flash Thin Image Dedupe and compression	Pool capacity and virtual volume capacity that can be created.  For more information, refer to the following table related to usable capacity of pools and virtual volumes.

**Table 18 Usable capacity of pools/virtual volumes**

Shared memory function	VSP F900
Base	4.4 PiB
Extension1	8.05 PiB
Extension2	12.5 PiB
Extension3	16.6 PiB
<b>Note:</b> When decreasing shared memory function, delete all DP, DT, active flash, TI, and dedupe and compression pools.	

The following table lists the corresponding amount of shared memory function to shared memory capacity:

**Table 19 Shared memory function and shared memory capacity**

Shared Memory Function	VSP F900
Base	108.5 GiB
Extension1	124.5 GiB
Extension2	140.5 GiB
Extension3	156.5 GiB

**Table 20 Minimum cache memory capacity required for shared memory function**

<b>Shared Memory Function</b>	<b>VSP F900</b>
Base	256 GiB
Extension1	256 GiB
Extension2	256 GiB
Extension3	256 GiB

---

## Appendix C: Network access

External Fibre Channel, iSCSI, or Ethernet cable connections are completed at the time of installation.

These connections are required to:

- Establish connections from the controllers to the host computers.
- Connect the storage system to the network, enabling storage system management through Hitachi Command Suite or Hitachi Ops Center Administrator.
- Allow communication to the storage system from the SVP.

### TCP/IP port assignments

When you install your storage system, default ports must be opened to allow for incoming and outgoing requests.

Review the following ports before you install the storage system to avoid conflicts between the TCP/IP port assignments used by the storage system and those used by other devices and applications.

Port number	Usage description
80	Used by the SVP, Hitachi Storage Advisor, and Device Manager - Storage Navigator to communicate through the HTTP protocol.
161	UDP (SNMP uses this port to send traps from the storage system) .
427	Used by SMI-S.
1099	Used by Hitachi Command Suite products JAVA RMI Registry server.
2000	TCP (Device Manager - Storage Navigator: Nonsecure) Cisco Skinny Client Control Protocol (SCCP) uses port 2000 for TCP. If you use Device Manager - Storage Navigator in a network with SCCP, change the TCP port that Device Manager - Storage Navigator uses (refer to the Device Manager - Storage Navigator online help).
5989	Used by SMI-S.
10995	TCP Device Manager - Storage Navigator and Hitachi suite components)
23015	Used for Web browser communications.
23016	Used for Web browser communications via SSL.
28355	TCP (Device Manager - Storage Navigator: Secure)
31001	Used for communication by Hitachi Command Control Interface (CCI) data collection procedures.
34001	Used by RAID Manager.
51099	Used by Device Manager - Storage Navigator for communication.
51100	Used by Device Manager - Storage Navigator for communication.



The following table shows the port number key name for outbound communication between the client PC and SVP.



**Note:** Refer to the following table for port number assignments if the storage system is using a physical service processor.

Port number key name (Windows Firewall Inbound name)	Protocol	Initial value of port number	Can the port be closed?	SVP software version
MAPPWebServer	HTTP	80	Yes	88-02-0x -xx/00 or later
MAPPWebServerHttps	HTTPS	443	No	
RMIClassLoader	RMI	51099	No	
RMIClassLoaderHttps	RMI (SSL)	5443	No	
RMIIFRegist	RMI	1099	No	
PreRMIServer	RMI	51100-51355 <sup>1</sup>	No	
		Automatic allocation		
DKCManPrivate	RMI	11099	N/A	88-02-0x -xx/00 or later
SMI-S (SLP)	SLP	427	Yes, only if SMI-S is not used.	88-02-0x -xx/00 or later
SMIS_CIMOM	SMI-S	5989-6244 <sup>1</sup>	Yes, only if SMI-S is not used.	
		Automatic allocation		88-02-0x -xx/00 or later
CommonJettyStart	HTTP	8080	N/A	88-02-0x -xx/00 or later
CommonJettyStop	HTTP	8210	N/A	
RestAPIServerStop	HTTP	9210	N/A	
DeviceJettyStart	HTTP	8081	N/A	

Port number key name (Windows Firewall Inbound name)	Protocol	Initial value of port number	Can the port be closed?	SVP software version
		Automatic allocation		88-02-0x -xx/00 or later
DeviceJettyStop	HTTP	8211	N/A	88-02-0x -xx/00 or later
		Automatic allocation		88-02-0x -xx/00 or later
Hi-Track	HTTPS, FTP (SSL)	4431	Yes, only if Hi-Track is not used.	88-02-0x -xx/00 or later



**Note:** Hitachi Command Suite has additional port considerations. For more information, refer to the *Hitachi Command Suite Administrator Guide*.

## Controller connections

The controllers provide the ports that are required to connect to an optional SVP, external drive trays, systems, and other devices.

A controller contains Fibre Channel ports, iSCSI ports, or both. The number and type of ports available for host connections vary based on the controller model.

- Fibre Channel SFP adapters are used to connect to your Fibre Channel switch and hosts.
- iSCSI ports come in optical and copper (RJ-45) interfaces, and are used to connect to your Ethernet switch and hosts.

Each controller also has:

- A SAS port for connection to an external drive tray.
- An RJ-45 10/100/1000 bps user LAN port for performing management activities.
- An RJ-45 10/100/1000 bps maintenance LAN port for diagnostics.

## Physical service processor connections

The SVP is available as an optional, physical device provided by Hitachi Vantara or as a virtual guest host running on customer-provided ESX servers and VM/OS licenses and media. The SVP provides error detection and reporting and supports diagnostic and maintenance activities involving the storage system.

In a VSP Fx00 configuration, both the storage system and the SVP reside on the same private network segment of your local-area network (LAN). The management console PC used to administer the system must also reside on the same private network segment.

Physical SVP connectivity requires all of the following:

- A static IP address for the SVP that is on the same network segment as the storage system.
- One Ethernet connection from each controller to separate LAN ports on the SVP.
- One Ethernet connection to your network switch.
- At least one management console PC on the same network segment as the SVP and storage system.



**Note:** The SVP running Windows 10 operating system does not provide a way to disable Spanning Tree Protocol (STP). If your network has BPDU enabled to prevent loops, connect the user LAN port on controllers 1 and 2 to an Ethernet switch instead of connecting them to SVP LAN 3 and LAN 4 ports.

Virtual SVP connectivity requires all of the following:

#### **ESX Server**

- VMware ESXi server 6.x
- 2 quad core processors, Intel Xeon 2.29 GHz
- 1-port NIC
- SVP guest OS (2 DKCs)
- 32 GB RAM

#### **SVP Guest OS (1 DKC)**

- Windows 10 IoT Enterprise
- 2 x vCPU
- 1 virtual network adapter
- 4 GB RAM
- 120 GB disk space

---

## Appendix D: Data and power cables

The storage system supports a variety of data and power cables for specific hosting environments.

### Required cables

The quantities and lengths of the cables required for storage system installation vary according to the specific storage system and network configuration. Fibre Channel and iSCSI cables are used to connect the controllers to a switch or host. Serial-attached SCSI (SAS) cables are used to connect drive trays to controllers and other drive trays.

The following table describes the cables required to perform storage system connections at the time of installation.

Interface type	Connector type	Cable requirements
Fibre Channel	LC-LC	Use a Fibre Channel cable to connect the Fibre Channel ports on each controller to a host computer (direct connection), or to or several host computers via a Fibre Channel switch. See the note and table below.
iSCSI (optical)	LC-LC	Use an optical Ethernet cable to connect the iSCSI 10 Gb SFP ports on each controller to a host computer (direct connection), or to several host computers via an Ethernet switch.
iSCSI (copper)	RJ-45	Use a shielded Category 5e or 6a Ethernet cable to connect the iSCSI 10 Gb RJ-45 ports on each controller to a host computer (direct connection), or to several host computers via an Ethernet switch.
SAS	SAS optical	Connects the controller to a drive tray or a drive tray to another drive tray. Two SAS cables are provided with each drive tray.
Ethernet	RJ-45	Four shielded Category 5e or 6a Ethernet cables are required for connecting the SVP to the controllers, management console PC, and network switch.



**Note:** The maximum distances in a typical Fibre Channel SAN depend on the kind of optical fiber used and its diameter. The following table lists the maximum supported Fibre Channel cable length based on cable size and port speed.

Cable size	Speed	Maximum cable length
9 micron	1 Gbps	1 km (3281 ft)
	2 Gbps	2 km

Cable size	Speed	Maximum cable length
		(6562 ft)
50 micron	2 Gbps	300 m (984.2 ft)
	4 Gbps	150 m (492.1 ft)
	8 Gbps	50 m (164 ft)
	16 Gbps	35 m (115 ft)
62.5 micron	2 Gbps	100 m (328.1 ft)
	4 Gbps	70 m (230 ft)
	8 Gbps	21 m (69 ft)

## Fibre Channel cables

The storage system supports Fiber Channel connections to hosts. For details about configuring FC host connections, see the *Provisioning Guide*.



**Note:** Due to high-speed serial data transfer via Fibre Channel, use high-quality FC cables that comply with the Fibre Channel-PH standard.

The following figure shows FC direct connection and FC connection through a switch.

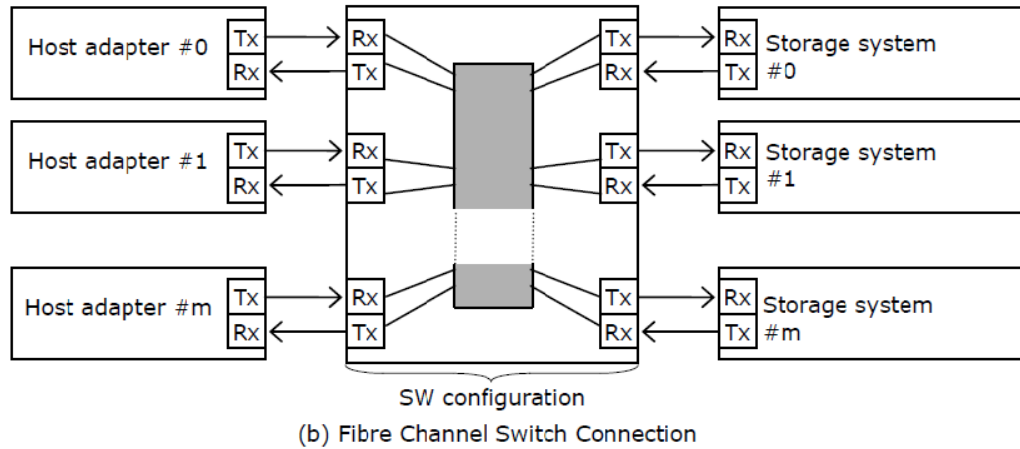
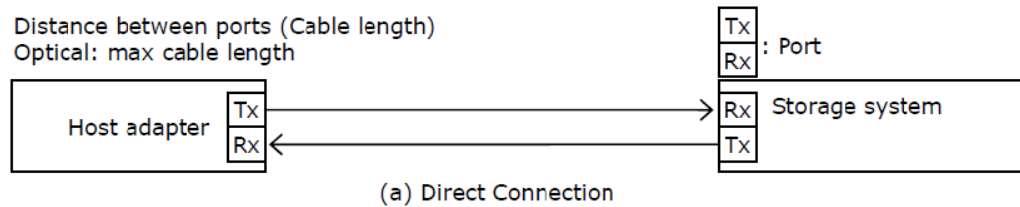

The following table lists the data transfer rates and provides the maximum cable lengths.

Data transfer rate	Maximum length of cable			
	Multimode cable			Single mode cable
	OM2	OM3	OM4	
2 Gbps	984.25 ft (300 m)	1640.4 ft (500 m)	—	3280.8 ft (10 km)
4 Gbps	493 ft (150 m)	1246.72 ft (380 m)	1312.3 ft (400 m)	
8 Gbps	164.04 ft (50 m)	493 ft (150 m)	623.36 ft (190 m)	
16 Gbps	114.8 ft (35 m)	328.08 ft (100 m)	410.1 ft (125 m)	—
32 Gbps	65.62 ft (20 m)	229.7 ft (70 m)	328.08 ft (100 m)	—

The following table lists specifications of the Fibre Channel interface cable.

Cable type	Interface	Cable mode name	Nominal		
			Cable	Connector	
				One side	Other side
LC-LC cable (shortwave)	Optical	Equivalent to DXLC-2P-PC-xxM-GC50, 125-2SR (OMx)	50, 125 $\mu$ m, 62.5, 125 $\mu$ m Multimode Wavelength: 850 nm	LC connector	LC connector
LC-LC cable (longwave)		DXLC-2PS-SPC-xxM-SMC 10/125-2SR	9/125 $\mu$ m Singlemode Wavelength: 1300 nm		

The following figure shows the connector used for optical interfaces.

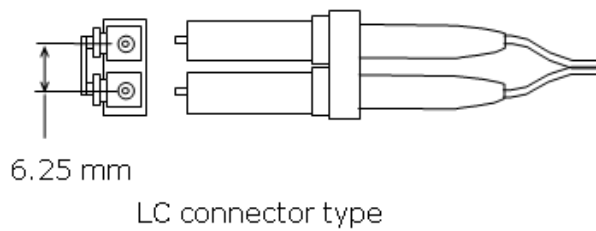



The following figure shows the type of optical connector that connects the storage system Fibre Channel ports.

- LC connector type
- **Connector type:** LC duplex receptacle connector
- **Interval:** 6.25 mm flat type, two rows

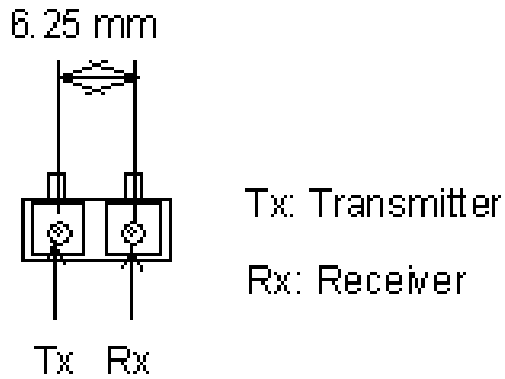

LC connector type

## iSCSI cables

The storage system supports iSCSI connections to hosts. For details about configuring iSCSI host connections, see the Provisioning Guide.

### Cable specifications for iSCSI optical interface

Cable type	Interface	Cable mode name	Nominal		
			Cable	Connector	
				One side	Other side
LC-LC cable	Optical	Equivalent to DXLC-2P-PC-xxM-GC50, 125-2SR (OMx)	50, 125 mm Multimode Wavelength: 850 nm	LC connector	LC connector

The following figure shows the connector used for optical interfaces.

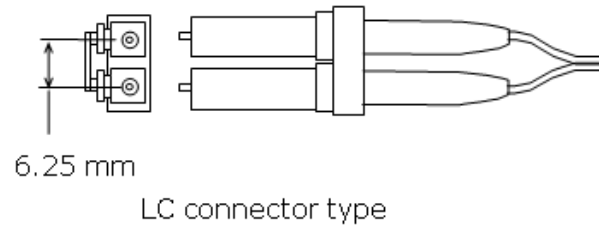

The following figure shows the type of optical connector that connects the storage system optical iSCSI ports.

- LC connector type
- **Connector type:** LC duplex receptacle connector
- **Interval:** 6.25 mm flat type, two rows

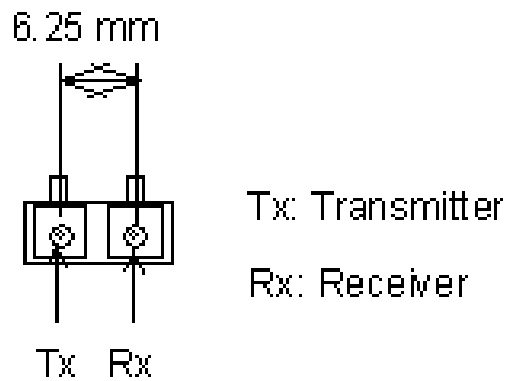

LC connector type

#### Cable specifications for 10 Gbps iSCSI copper interface

Cable type	Maximum cable connection length	Data transfer	Transmission band	Cable	Connector
Category 5e or 6a LAN cable	100 m	1 Gbps	1000BASE-T	STP ( use an STP cable that suppresses radio noise)	RJ-45
Category 6a LAN cable	50 m	10 Gbps	10GBASE-T	STP ( use an STP cable that suppresses radio noise)	RJ-45

The following figure shows a 10 Gbps iSCSI cable.

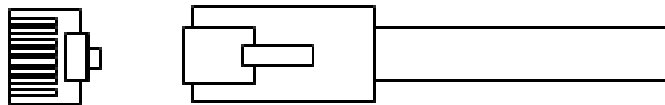

## iSCSI standards

The following standards apply to the management, maintenance, and iSCSI data ports. To configure this system, use switches that comply with the following standards:

- IEEE 802.1D STP
- IEEE 802.1w RSTP
- IEEE 802.3 CSMA/CD
- IEEE 802.3u Fast Ethernet
- IEEE 802.3z 1000 BASE-X
- IEEE 802.1Q Virtual LANs
- IEEE 802.3ae 10 Gigabit Ethernet
- RFC 768 UDP
- RFC 783 TFTP
- RFC 791 IP
- RFC 793 TCP
- RFC 1157 SNMP v1
- RFC 1231 MIB II
- RFC 1757 RMON
- RFC 1901 SNMPv2

## iSCSI specifications

Item	Specification	Comments
iSCSI target function	Supported	N/A
iSCSI target function	Supported	TrueCopy® only
iSCSI ports	2 per interface board	VSP Fx00 models: Maximum 24 per iSCSI system
Connection methods	Direct and switch connections	
Host connections	255 (maximum per iSCSI port)	With Linux software initiator, the maximum number decreases.
Path failover	HDLM <sup>1</sup>	Supports Microsoft MPIO (Multi Path I/O)
Link	10 Gbps SFP+	N/A

Item	Specification	Comments
Transfer speed	10 Gbps	N/A
Connector type	LC	N/A
Cable	Optical OM3, OM2 MMF cable	N/A
Network switch	L2 or L3 switch	Should comply with IEEE802.3ae
Switch cascading	Maximum: 5 switches or fewer	Minimum number of cascading switches is recommended.
MAC address	Per port (fixed value)	Factory setting: World Wide Unique value. Cannot be changed.
Maximum transfer unit (MTU)	1,500, 4,500, 9,000 bytes (Ethernet frame)	Jumbo frame, MTU size greater than 1500
Link aggregation	Not supported	N/A
Tagged VLAN	Supported	N/A
IPv4	Supported	N/A
IPv6	Supported	<p>Note the following precautions:</p> <ul style="list-style-type: none"> <li>▪ When iSCSI Port IPv6 is set to Enabled, if the IPv6 global address is set to automatic, the address is determined by acquiring a prefix from an IPv6 router.</li> <li>▪ If the IPv6 router does not exist in the network, the address cannot be determined. As a result, an iSCSI connection might be delayed. When an iSCSI Port IPv6 is set to Enabled, verify the IPv6 router is connected to the same network, and then set IPv6 global address automatically.</li> </ul>

Item	Specification	Comments
Subnet mask	Supported	N/A
Gateway address	Supported	N/A
DHCP	N/A	N/A
DNS	N/A	N/A
Ping (ICMP ECHO) Transmit, Receive	Supported	N/A
IPsec <sup>2</sup>	N/A	N/A
TCP port number	3260	<p>Changeable among 1 to 65,535. Observe the following if changing values:</p> <ul style="list-style-type: none"> <li>▪ The setting of the corresponding host should also be changed to log in the new port number.</li> <li>▪ The new port number might conflict with other network communication or be filtered on some network equipment, preventing the storage system from communicating through the new port number.</li> </ul>
iSCSI name	Both iqn <sup>3</sup> and eui <sup>4</sup> types are supported	The unique iqn value is automatically set when a target is made. iSCSI name is configurable.
Error recovery level	0 (zero)	Error recovery by retrying from host. Does not support Level 1 and Level 2.
Header digest	Supported	Detects header error or data error with iSCSI communication. The storage system follows the host's digest setting. If digest is enabled, the performance degrades.

Item	Specification	Comments
Data digest	Supported	The amount of the degradation depends on factors such as host performance of host and transaction pattern.
Maximum iSCSI connections at one time	255 per iSCSI port	N/A
CHAP	Supported	Authentication: login request is sent properly from host to storage. CHAP is not supported during discovery session.
Mutual (2-way) CHAP	Supported (not available if connected to Linux software initiator)	Authentication: login request is sent properly from host to storage.
CHAP user registration	Max 512 users per iSCSI port	N/A
iSNS	Supported	With iSNS (name service), a host can discover a target without knowing the target's IP address.
<p><b>Note:</b></p> <ol style="list-style-type: none"> <li>1. JP1, HiCommand Dynamic Link Manager. Pass switching is achieved. Not supported on Windows Vista and Windows 7 operating systems.</li> <li>2. IP Security. Authentication and encryption of IP packets. The storage system does not support IPsec.</li> <li>3. iqn: iSCSI Qualified Name. The iqn consists of a type identifier, "iqn," a date of domain acquisition, a domain name, and a character string given by the individual who acquired the domain. Example: <u>iqn.1994-04.jp.co.hitachi:rsd.d7m.t.10020.1b000.tar</u></li> <li>4. eui: 64-bit Extended Unique Identifier. The eui consists of a type identifier, "eui," and an ASCII-coded, hexadecimal, EUI-64 identifier. Example: <u>eui.0123456789abcdef</u></li> </ol>		

## Managing cables

Organize cables to protect the integrity of your connections and allow proper airflow around your storage system.

### Cable lengths

The following table specifies the maximum length of SAS cables can be used to connect controllers and drive trays.

System	Maximum length
VSP F900	124 meters or less (406.8 ft or less)

### Observing bend radius values

Never bend cables beyond their recommended bend radius. The following table provides general guidelines for minimum bend radius values, but you should consult the recommendation of your cable manufacturer.

Cable type	Minimum bend radius values
Fibre Channel	40 mm (1.73 inch)
iSCSI optical	40 mm (1.73 inch)
Category 5 Ethernet	Four times the outside diameter of the cable
SAS	40 mm (1.73 inch)



## Protecting cables

Damage to the cables can affect the performance of your storage system. Observe the following guidelines to protect the cables:

- Keep cables away from sharp edges or metal corners.
- When bundling cables, do not pinch or constrict the cables.
- Do not use zip ties to bundle cables. Instead, use Velcro hook-and-loop ties that do not have hard edges and which you can remove without cutting.
- Never bundle network cables with power cables. If network and power cables are not bundled separately, electromagnetic interference (EMI) can affect your data stream.
- If you run cables from overhead supports or from below a raised floor, include vertical distances when calculating necessary cable lengths.
- If you use overhead cable supports:
  - Verify that your supports are anchored adequately to withstand the weight of bundled cables.
  - Gravity can stretch and damage cables over time. Therefore, do not allow cables to sag through gaps in your supports.
  - Place drop points in your supports that permit cables to reach racks without bending or pulling.
- Unintentional unplugging or unseating of a power cable can have a serious impact on the operation of an enterprise storage system. Unlike data cables, power connectors do not have built-in retention mechanisms to prevent this from happening.

To prevent accidental unplugging or unseating of power cables, the storage system includes a rubber cable-retention strap near the AC receptacle on each controller. These straps, shown in the following image, loop around the neck of a power cable connector, and the notched tail is slipped over the hook of the restraining bar fixed to the storage system.

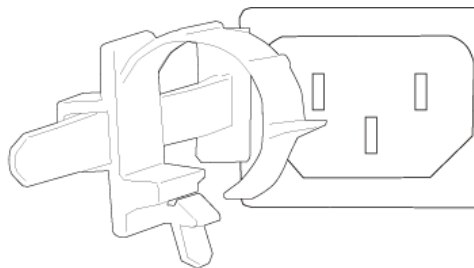

## Cabling full-width modules

When cabling full-width modules, route the cables horizontally, so that they do not interfere when replacing a module.

## Ensuring adequate airflow

Bundled cables can obstruct the movement of conditioned air around your storage system.

- Secure cables away from fans.
- Keep cables away from the intake holes at the front of the storage system.
- Use flooring seals or grommets to keep conditioned air from escaping through cable holes.

### Preparing for future maintenance

Design your cable infrastructure to accommodate future work on the storage system. Give thought to future tasks that will be performed on the storage system, such as locating specific pathways or connections, isolating a fault, or adding or removing components.

- Purchase colored cables or apply colored tags.
- Label both ends of every cable to denote the port to which it connects.

## AC power cables

Utility AC power standards for connector types and voltage levels vary by country. Hitachi provides a variety of power cables that facilitate using storage systems around the world. Hitachi power cables meet the safety standards for the country for which they are intended.

### Power cable assemblies

For information about racks and power distribution units (PDUs), refer to the *Hitachi Universal V2 Rack Reference Guide*.

Hitachi power cables consist of three parts:

- **Plug:** Male connector for insertion into the AC outlet providing power. The physical design and layout of the plug's contact meet a specific standard.
- **Cord:** Main section of insulated wires of varying length, whose thickness is determined by its current rating.
- **Receptacle:** Female connector to which the equipment attaches. The physical design and layout of the receptacle's contacts meet a specific standard. Common standards are the IEC C13 receptacle for loads up to 10 amperes (A) and the IEC C19 receptacle for loads up to 15 A.

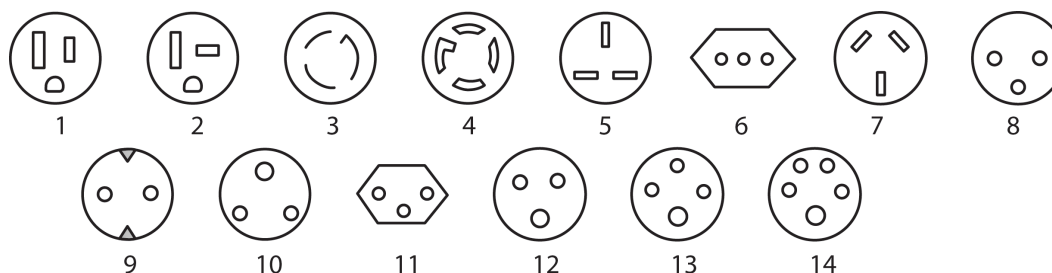

Number	Country or region	Voltage rating (VAC)	Current rating (amperes)	Plug type
1 <sup>1</sup>	North America	100-127	15	NEMA 5-15P
	Brazil	200-240	10, 20	NEMA 5-15P
	Japan	100-127	12	JIS C8303
	Taiwan	100-127	12, 16	CNS 690
2	North America	100-127	20	NEMA 5-20P
3	North America	200-240	20	NEMA L6-20P
3	North America	200-240	30	NEMA L6-30P
4 <sup>2</sup>	North America	200-240	30	NEMA L15-30P
5 <sup>3</sup>	Hong Kong	200-240	13	BS-1363
	Singapore	200-240	13	BS-1363
6	Chile	200-240	10, 16	CEI 23-50
	Italy	200-240	10, 16	CEI 23-50
7	Argentina	200-240	10, 15	IRAM 2073
	Australia	200-240	10, 15	AS-3112
	China	200-240	10, 16	GB-1002
	New Zealand	200-240	10, 15	AS-3112
8	Denmark	200-240	10	DK 2-5
	Israel	200-240	10, 16	SI-32
9 <sup>4</sup>	Europe	200-240	CEE 7, 7	
10 <sup>5</sup>	India	200-240	6, 16	IS-1293
	South Africa	200-240	10, 16	SABS-164
11	Switzerland	200-240	10	SEV 1011
12 <sup>6</sup>	International	200-240	20	IEC 309
13 <sup>7</sup>	United Kingdom	200-240	13	BS-1363
	International	200-240	20	IEC 309
14 <sup>8</sup>	International	200-240	30	IEC 309

Number	Country or region	Voltage rating (VAC)	Current rating (amperes)	Plug type
<b>Notes:</b>				
<ol style="list-style-type: none"> <li>1. Also used for 200-240 VAC applications in Korea and Philippines.</li> <li>2. Three-phase AC.</li> <li>3. Also Malaysia and Ireland.</li> <li>4. Also known as "Schuko" connector and used in Austria, Belgium, Finland, France, Germany, Greece, Hungary, Indonesia, Netherlands, Norway, Poland, Portugal, Russia, Spain, and Sweden.</li> <li>5. Supersedes type BS 546.</li> <li>6. 3-wire (two-phase and earth). Physical variations (connector size and color) indicate amperage rating. Used in Switzerland for a true 16 A application.</li> <li>7. 4-wire (three-phase and earth). Physical variations (connector size and color) indicate amperage rating.</li> <li>8. 5-wire (three-phase, earth and neutral). Physical variations (connector size and color) indicate amperage rating.</li> </ol>				

## AC connections

The following table shows and describes the types of AC connections on your storage system.

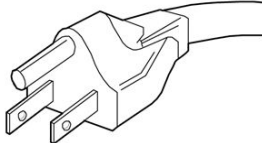
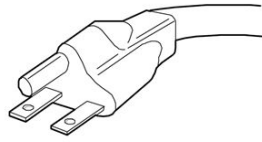
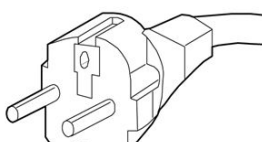
Description	Receptacle	Input rating	Reference standards
NEMA 5-15P		100V-120V (standard attachment)	1 ANSI C73.11 2 NEMA 5-15P 3 IEC 83
NEMA L6-20P		200V-240V	1 ANSI C73.11 2 NEMA 6-15P 3 IEC 83
CEE 7/7		200V-240V	4 CEE (7) II, IV, VII 3 IEC 83

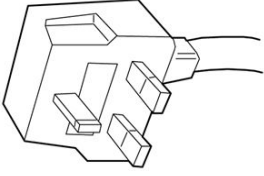
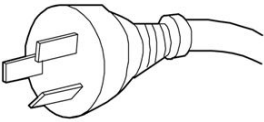
Description	Receptacle	Input rating	Reference standards
BS-1363		200V-240V	5 BS 1365 3 IEC 83
AS-3112		200V-240V	6 AS C112

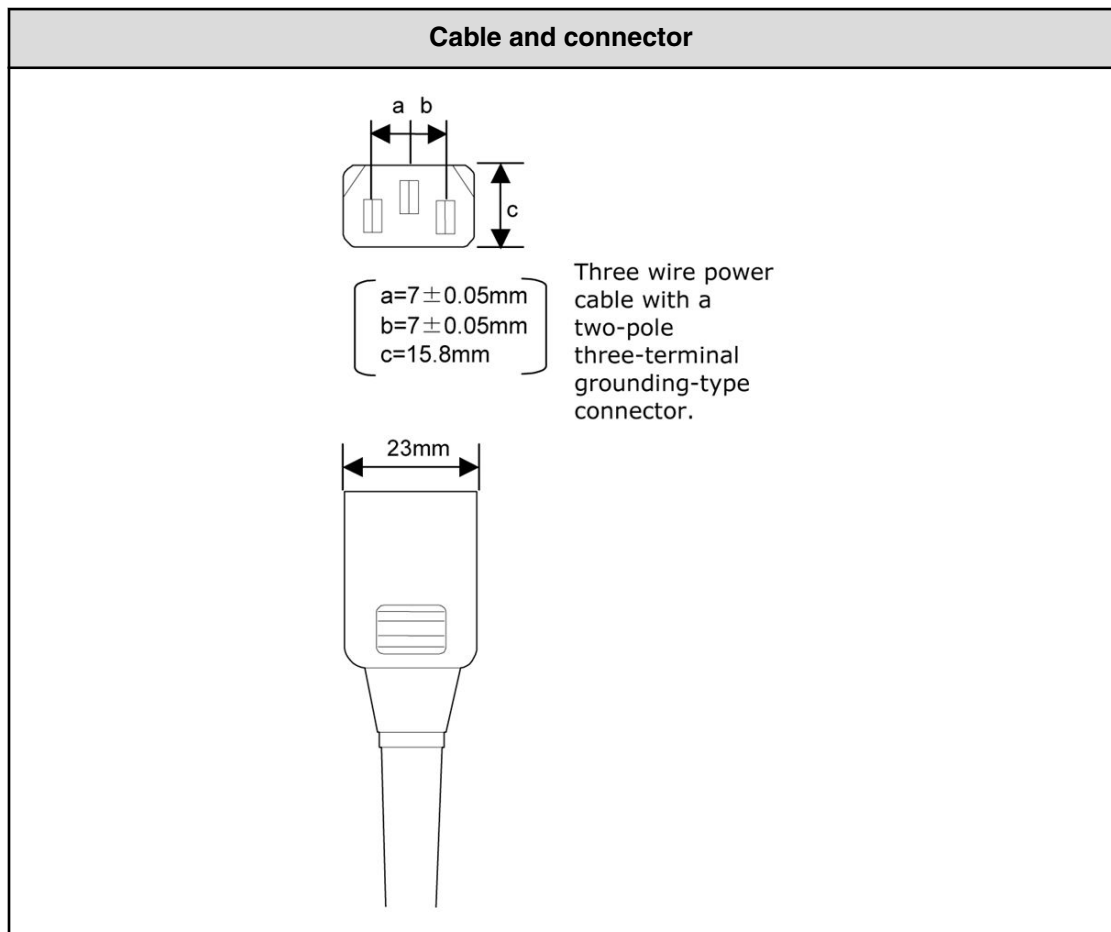

## Power cable usage guidelines

Hitachi storage systems are intended for rack installation and ship with power cords. Installation and service requirements may require additional cords and cables to be ordered. The type of power cable required by a given installation is determined primarily by the:

- Type of AC line feed provided by the facility.
- Type of AC source (wall outlet or modular and monitored PDU) to be used.
- Serviceability of components to be connected.

Storage systems require a country-specific power cable for direct connection to a facility AC feed.

Storage systems are designed to allow replacement of hot-pluggable components without removing the chassis from the rack. As a result, power cables can be short because cable movement is of minimal consideration.

## Three-phase power considerations for racks

Increasing power requirements for racks are making the use of three-phase power at the rack level compelling.

- With single-phase power, at any given time the voltage across the hot and neutral conductors can be anywhere between its peak (maximum) and zero. Electrical conductors must be large to meet high amperage requirements.
- Three-phase power uses three cycles that are 120 degrees out of phase, which never allows the voltage to drop to zero. The more consistent voltage derived from the three hot conductors results in smoother current flow and allows small-gauge conductors to be used to distribute the same amount of AC power. As a result, the load balancing and increased power handling capabilities of three-phase distribution can result in more efficient and less costly installations that require fewer AC cables and PDUs.



## Cable management

Rack installations should be planned for operational efficiency, ease of maintenance, and safety. Hitachi offers the Backend Configuration Utility (BECK), a graphical, cable-management application that can relieve the typical cable congestion created when populating a rack with storage systems and their accessories.

## Appendix E: Power distribution units for Hitachi Universal V2B Rack

The Universal V2B Rack is equipped with specific power distribution units (PDU) for Americas, APAC, and EMEA regions. The PDUs can provide electrical power to the racked system in a single-phase or three-phase configuration.



### Caution:

- Before installing third-party devices into the rack, check the electrical current draw of each device. Verify the electrical specifications and allowable current load on each PDU before plugging the device into the PDU.
- Balance the electrical current load between available PDUs.

### Americas single-phase PDU 1P30A-8C13-3C19UL.P

The following figure and table describe the specifications of the PDU.

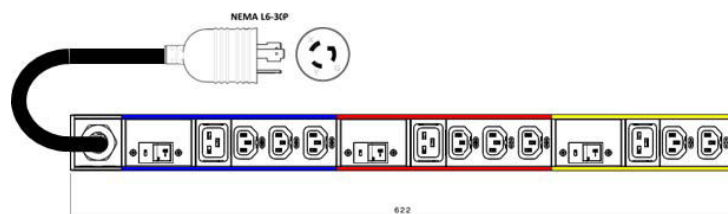

**Figure 1 Americas PDU for the Hitachi Universal V2B Rack (Single-phase PDU 1P30A-8C13-3C19UL.P)**

Part Number	Region	Quantity	Power input per PDU	Power output per PDU	Total rack amperage available
1P30A-8C13-3C19UL.P	Americas	6/rack 3/side	Single phase 208V, 30A (24A rated) 60Hz Delta/wYe: N/A	8 IEC C13 + 3 IEC C19 sockets Max allowable current: 24A 5kVA	72A (15kVA)

Part Number	Region	Quantity	Power input per PDU	Power output per PDU	Total rack amperage available
			NEMA L6-30P input power plug 4.5 m (14.76 feet) cable		

## Americas single-phase PDU 1P30A-15C13-3C19UL.P

The following figure and table describe the specifications of the PDU.

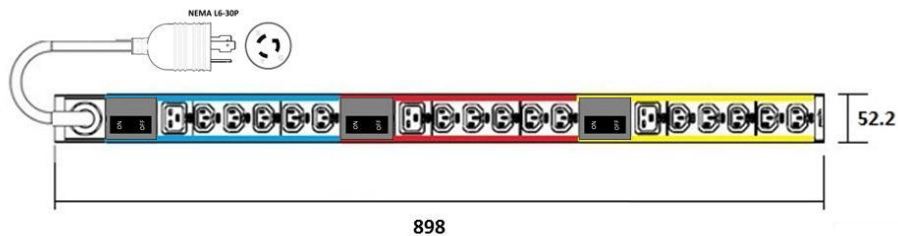

**Figure 2 Americas PDU for the Hitachi Universal V2B Rack (Single-phase PDU 1P30A-15C13-3C19UL.P)**

Part number	Region	Quantity	Power input per PDU	Power output per PDU	Total rack amperage available
1P30A-15C13-3C19UL.P	Americas	4/rack 2/side	Single phase 208V, 30A (24A rated) 60Hz Delta/wYe: N/A NEMA L6-30P input power plug 4.5 m (14.76 feet) cable	15 IEC C13 + 3 IEC C19 sockets Max allowable current: 24A 5kVA	48A (10kVA)



## Americas three-phase PDU 3P30A-8C13-3C19UL.P

The following figure and table describe the specifications of the PDU.

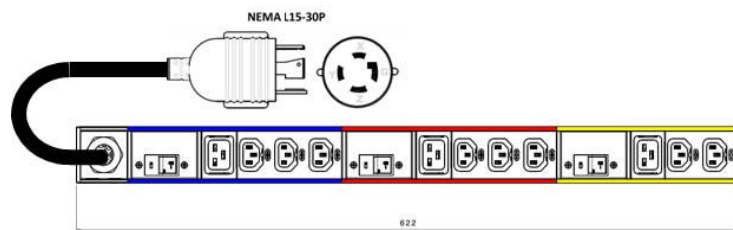
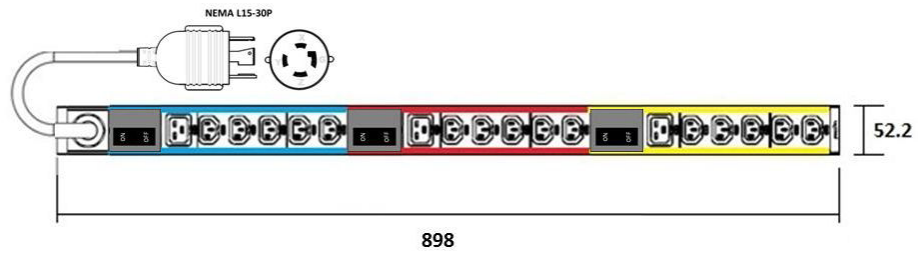

**Figure 3 Americas PDU for the Hitachi Universal V2B Rack (Three-phase PDU 3P30A-8C13-3C19UL.P)**

Part number	Region	Quantity	Power input per PDU	Power output per PDU	Total rack amperage available
3P30A-8C13-3C19UL.P	Americas	6/rack 3/side	Three phase 208V 3P, 30A (24A rated) 60Hz Delta/wYe: Delta NEMA L15-30P input power plug 4.5 m (14.76 feet) cable	8 IEC C13 + 3 IEC C19 sockets Max allowable current: 38.4A 8kVA	115A (24kVA)

## Americas three-phase PDU 3P30A-15C13-3C19UL.P

The following figure and table describe the specifications of the PDU.

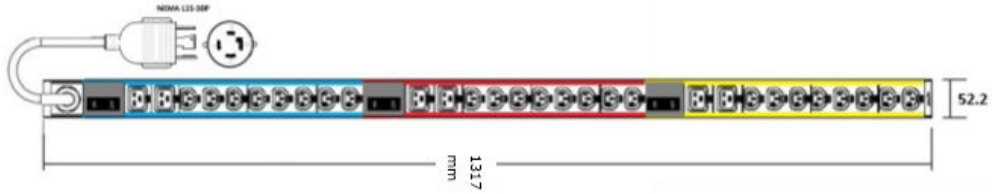

**Figure 4 Americas PDU for the Hitachi Universal V2B Rack (Three-phase PDU 3P30A-15C13-3C19UL.P)**

Part number	Region	Quantity	Power input per PDU	Power output per PDU	Total rack amperage available
3P30A-15C13-3C19UL.P	Americas	4/rack 2/side	Three phase 208V 3P, 30A (24A rated) 60Hz Delta/wYe: Delta NEMA L15-30P input power plug 4.5 m (14.76 feet) cable	15 IEC C13 + 3 IEC C19 sockets Max allowable current: 38.4A 8kVA	77A (16kVA)

## Americas three-phase PDU 3P30A-24C13-6C19UL.P

The following figure and table describe the specifications of the PDU.

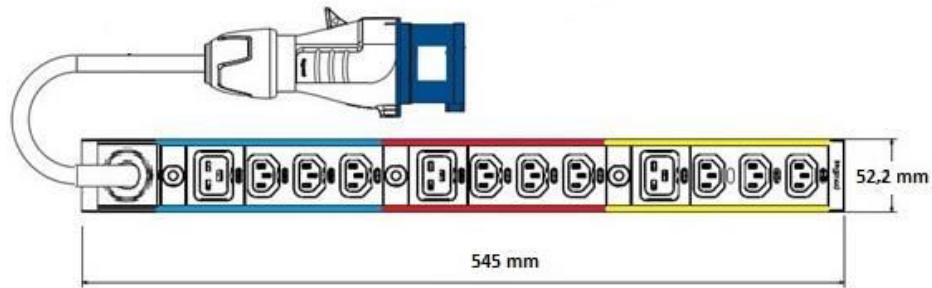

**Figure 5 Americas PDU for the Hitachi Universal V2B Rack (Three-phase PDU 3P30A-24C13-6C19UL.P)**

Part number	Region	Quantity	Power input per PDU	Power output per PDU	Total rack amperage available
3P30A-24C13-6C19UL.P	Americas	2/rack 1/side	Three phase 208V 3P, 30A (24A rated) 60Hz Delta/wYe: Delta NEMA L15-30P input power plug 4.5 m (14.76 feet) cable	24 IEC C13 + 6 IEC C19 sockets Max allowable current: 38.4A 8kVA	38.4A (8kVA)

## APAC and EMEA single-phase PDU 1P32A-9C13-3C19CE.P

The following figure and table describe the specifications of the PDU.

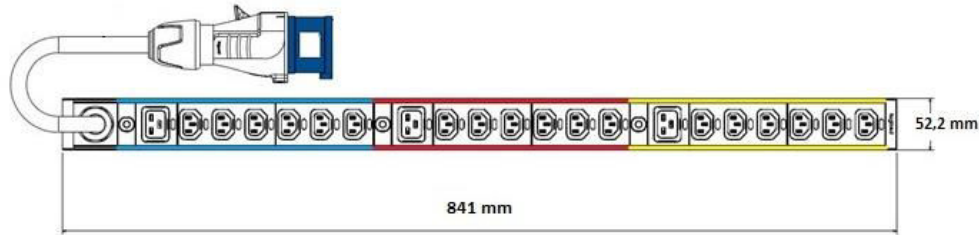

**Figure 6 APAC and EMEA PDU for the Hitachi Universal V2B Rack (Single-phase 1P32A-9C13-3C19CE.P)**

Part number	Region	Quantity	Power input per PDU	Power output per PDU	Total rack amperage available
1P32A-9C13-3C19CE.P	APAC and EMEA	6/rack 3/side	Single phase 230V max. 32A (25.6A rated) 50Hz / 60Hz Delta/wYe: N/A IEC309 P + N + E input power plug 4.5 m (14.76 feet) cable	9 IEC C13 + 3 IEC C19 sockets Max allowable current: 25.6A 5.9kVA	77A (17.6kVA)

## APAC and EMEA single-phase PDU 1P32A-18C13-3C19CE.P

The following figure and table describe the specifications of the PDU.

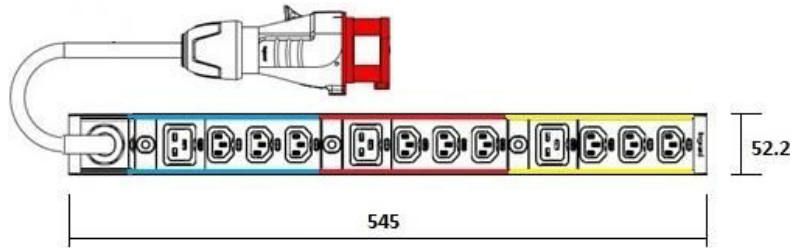

**Figure 7 APAC and EMEA PDU for the Hitachi Universal V2B Rack (Single-phase 1P32A-18C13-3C19CE.P)**

Part number	Region	Quantity	Power input per PDU	Power output per PDU	Total rack amperage available
1P32A-18C13-3C19CE.P	APAC and EMEA	4/rack 2/side	Single phase 230V max. 32A (25.6A rated) 50Hz / 60Hz Delta/wYe: N/A IEC309 P + N + E input power plug 4.5 m (14.76 feet) cable	18 IEC C13 + 3 IEC C19 sockets Max allowable current: 38.4A 8.8kVA	77A (17.6kVA)

## APAC and EMEA three-phase PDU 3P16A-9C13-3C19CE.P

The following figure and table describe the specifications of the PDU.

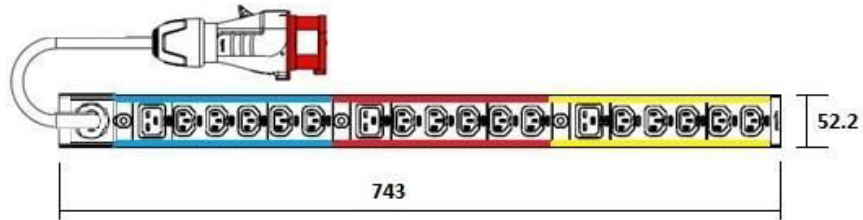

**Figure 8 APAC and EMEA PDU for the Hitachi Universal V2B Rack (Three-phase 3P16A-9C13-3C19CE.P)**

Part number	Region	Quantity	Power input per PDU	Power output per PDU	Total rack amperage available
3P16A-9C13-3C19CE.P	APAC and EMEA	6/rack 3/side	Three phase 400V max. 16A (12.8A rated) 50Hz / 60Hz Delta/wYe: wYe IEC309 3P + N + E input power plug 4.5 m (14.76 feet) cable	9 IEC C13 + 3 IEC C19 sockets Max allowable current: 38.4A 8.8kVA	115A (26.4kVA)

## APAC and EMEA three-phase PDU 3P16A-15C13-3C19CE.P

The following figure and table describe the specifications of the PDU.

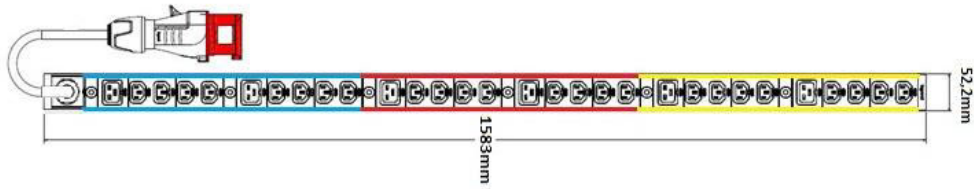

**Figure 9 APAC and EMEA PDU for the Hitachi Universal V2B Rack (Three-phase 3P16A-15C13-3C19CE.P)**

Part number	Region	Quantity	Power input per PDU	Power output per PDU	Total rack amperage available
3P16A-15C13-3C19CE.P	APAC and EMEA	4/rack 2/side	Three phase 400V max. 16A (12.8A rated) 50Hz / 60Hz Delta/wYe: wYe IEC309 3P + N + E input power plug 4.5 m (14.76 feet) cable	15 IEC C13 + 3 IEC C19 sockets Max allowable current: 38.4A 8.8kVA	77A (17.6kVA)

## APAC and EMEA three-phase PDU 3P32A-24C13-6C19CE.P

The following figure and table describe the specifications of the PDU.



**Figure 10 APAC and EMEA PDU for the Hitachi Universal V2B Rack (Three-phase 3P32A-24C13-6C19CE.P)**

Part number	Region	Quantity	Power input per PDU	Power output per PDU	Total rack amperage available
3P32A-24C13-6C19CE.P	APAC and EMEA	2/rack 1/side	Three phase 400V max. 32A (25.6A rated) 50Hz / 60Hz Delta/wYe: wYe IEC309 3P + N + E input power plug 4.5 m (14.76 feet) cable	24 IEC C13 + 6 IEC C19 sockets Max allowable current: 77A 17.6kVA	77A (17.6kVA)

## Americas, APAC, and EMEA three-phase PDU 3P30A-243-69CE-UL.P

The following figure and table describe the specifications of the PDU.



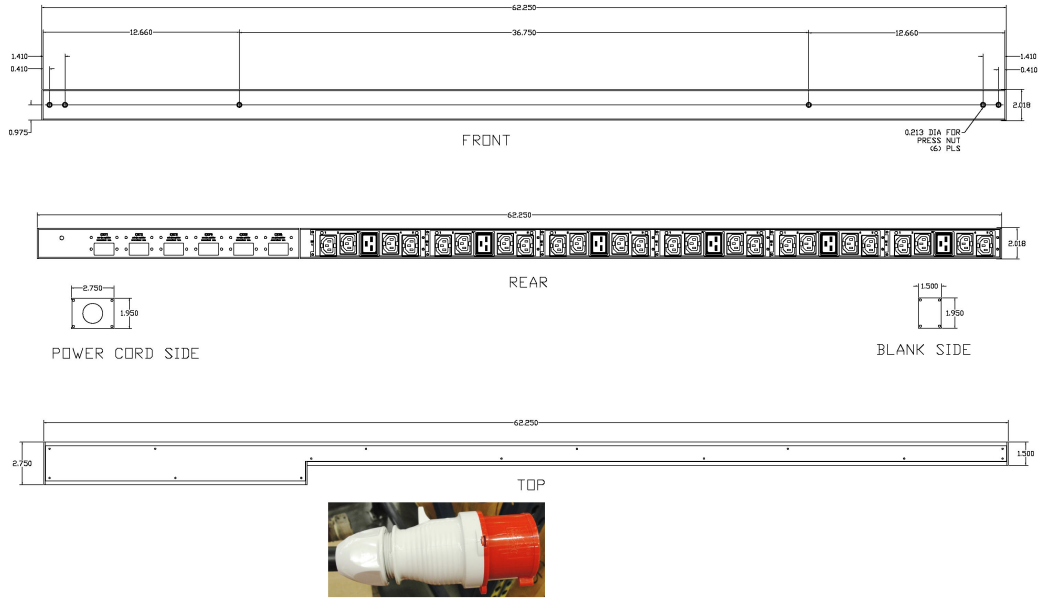

**Figure 11 APAC and EMEA PDU for the Hitachi Universal V2B Rack (Three-phase 3P30A-243-69CE-UL.P)**

Part number	Region	Quantity	Power input per PDU	Power output per PDU	Total rack amperage available
3P30A-243-69CE-UL.P	Americas, APAC, and EMEA	2/rack 1/side	Three phase 400/415V max. 30/32A (24A rated) 50Hz / 60Hz Delta/wYe: wYe IEC309 3P + N + E input power plug 4.5 m (14.76 feet) cable	24 IEC C13 + 6 IEC C19 sockets Max allowable current: 77A 17.6kVA	77A (17.6kVA)

---

## Appendix F: Non-Hitachi racks

All storage systems can be installed into non-Hitachi racks.

The following describes the requirements and guidelines for installing the storage system into a non-Hitachi rack.

### Non-Hitachi rack support

The storage system supports non-Hitachi racks that meet Hitachi specifications.

Observe the following mounting guidelines for non-Hitachi racks:

- The VSP Fx00 models support any 4-post, EIA-310-D compliant rack that has adequate airflow and weight capacity.
- PDUs must be mounted properly to avoid any issues while servicing the storage system. The PDU receptacles must face toward the back (not toward each other). The area behind the storage system and between the vertical 19-inch mounting posts must be free of PDUs and cable loops.

### Hitachi Universal V2 Rack rail kits

Use rail kits to mount the Hitachi Virtual Storage Platform family storage system in a Hitachi Universal V2 Rack.

The following tables list the rail kit information for the specified storage systems.

**Table 21 Rail kits for VSP Fx00 models**

Rail kit	Hitachi Universal V2 Rack	Third-party rack
Controller	UNI <sup>1</sup>	UNI <sup>1</sup>
DBS/DBSE and DBF drive trays	CGR <sup>2</sup>	UNI <sup>1</sup>
SVP server	Use the rail kit supplied with the SVP server.	
<b>Notes:</b>		
1. UNI: Universal rail kit A34V-600-850-UNI.		
2. CGR: Corner guide rail kit A3BF-HK-GL-740-1.		

## Hitachi Universal V2 Rack accessories

The following table provides rack accessory information for VSP F series storage systems.









**Table 22 Accessories for the Hitachi Universal V2 Rack**

Storage system	Front door	Rear door	Side panels
VSP Fx00 models	Optional, must be ordered separately (A3BF-DR).	Included with rack	Not included with rack, must be ordered separately. A quantity of two must be ordered per rack (A3BF-Z-PAN-1200).

## Appendix G: Warning labels on the storage system

To avoid injuries and damage to the equipment, the storage system have warning labels on the exterior of the hardware components. Always identify, read, and obey the advisory warning labels situated on the exterior before handling the equipment.

The following symbols are described and contained in the warning labels.

Symbol mark	Explanation
	Do not disassemble the equipment.
	Be careful when handling heavy equipment.
	Use caution when handling electrostatic-sensitive equipment and microcircuitry.
	Avoid placing any non-essential objects or equipment onto the storage system.
	Use caution when handling the equipment.
	Use caution when handling equipment with movable parts.
	Use caution when handling equipment with hot surfaces.
	Use caution when handling equipment prone to tipping over.

# CBL controller

<p><b>⚠ CAUTION</b></p> <p>Take care not to drop</p> <p>Dropping the array may cause injury. Keep hands securely on array. Be aware of the red line marked on the array top – when sliding the array out of the rail terminal past this mark, keep a firm hold on the array.</p>	<p><b>⚠ 注意</b></p> <p>落下注意</p> <p>装置が落下して怪我をする危険があります。装置上面の赤い線を越えて引き出す場合、装置を両手でしっかりと持ってください。</p>	<p><b>⚠ VORSICHT</b></p> <p>Nicht fallen lassen</p> <p>Beim Herunterfallen des Arrays können Personen verletzt werden. Halten Sie das Array stets sicher mit Ihren Händen fest. Beachten Sie die rote Linie, die oben des Arrays angebracht ist.</p>	<p><b>⚠ PRECAUCIÓN</b></p> <p>Tenga cuidado para evitar caídas</p> <p>Dejar caer la cabina puede causar lesiones. Mantenga las manos de forma segura en la cabina. Respete la línea roja marcada en la parte superior de la cabina.</p>	<p><b>⚠ ATTENTION</b></p> <p>Prenez garde de ne pas aisser tomber</p> <p>Le fait de laisser tomber le cadre peut occasionner des blessures. Tenez les mains fermement sur le cadre. Tenez compte de la ligne marquée en rouge sur le haut du cadre.</p>
<p><b>⚠ CAUTION</b></p> <p>Heavy</p> <p>Lifting the heavy array may cause injury in your arms or low back. Use lifting equipment or handle the array with two or more personnel. This array weighs approximately 85kg.</p>	<p><b>⚠ 注意</b></p> <p>重量物注意</p> <p>重量物を持ち上げると、腕や腰を傷めます。リフターを使用したり、2人以上で扱ったりしてください。装置質量は約85kgです。</p>	<p><b>⚠ VORSICHT</b></p> <p>Hohes Gewicht</p> <p>Beim Anheben des schweren Arrays könnten Ihre Arme oder Ihr unterer Rücken verletzt werden. Verwenden Sie eine Hebevorrichtung oder transportieren Sie das Array mit mindestens zwei Personen. Dieses Array wiegt etwa 85kg.</p>	<p><b>⚠ PRECAUCIÓN</b></p> <p>Peso elevado</p> <p>Levantar una cabina pesada puede causar lesiones en los brazos o la región lumbar. Utilice un dispositivo de elevación o levante la cabina con la ayuda de dos o más personas. Esta cabina posee un peso aproximado de 85kg.</p>	<p><b>⚠ ATTENTION</b></p> <p>Poids</p> <p>Le fait de soulever le cadre qui est lourd peut entraîner des lésions aux bras ou au bas du dos. Utilisez un équipement de levage ou manipulez le cadre à deux personnes ou plus. Ce cadre pèse environ 85kg.</p>
<p><b>NOTICE</b></p> <p>Avoid damage – do not carry the array by its front side. Lift or carry the array by its left, right, or rear sides. Avoid damage to the bezel – do not place the array directly on the floor or table while the bezel is attached. Remove the bezel as needed to prevent weight from being applied to the bezel. Avoid damage to the chassis – do not place anything on top of the array.</p>	<p><b>通知</b></p> <p>運搬時は、装置前面を持たないでください。定形する恐れがあります。前面および後面を持って、持ち上げたり運んでください。装置にベゼルが付いた状態で、平置きしないでください。ベゼルが破損する恐れがありますので、ベゼルの取外しは、ベゼルの外力が掛からないように行ってください。シャーシが変形する恐れがあります。装置の上面にも何も置かないでください。</p>	<p><b>HINWEIS</b></p> <p>Vermeiden Sie Beschädigungen – tragen Sie das Array nicht an seiner vorderen Seite/oben oder tragen Sie das Array an seiner linken, rechten oder hinteren Seite. Beschädigen – legen Sie das Array nicht direkt auf den Boden oder eine Tischplatte da die Bilde angebracht ist. Entfernen Sie die Bilde bei Bedarf, damit sie keinem Gewicht ausgesetzt wird. Beschädigen Sie nicht das Gehäuse – stellen Sie keine Gegenstände oben auf des Array.</p>	<p><b>AVISO</b></p> <p>Evite daños: no transporte la cabina desde su lado frontal. Levante o transporte la cabina desde el lado izquierdo, derecho o trasero. Evite causar daños en el marco: no coloque la cabina directamente sobre el piso o mesa cuando el marco se encuentra colocado. Extraiga el marco según sea necesario para evitar que el peso quede apoyado sobre el marco. Evite causar daños al chasis: no coloque ningún objeto sobre la parte superior de la cabina.</p>	<p><b>AVIS</b></p> <p>Pour éviter les dégâts – ne portez pas le cadre par sa face avant. Soulevez ou transportez le cadre par ses côtés gauche, droit, ou arrière. Pour éviter d'endommager le pourtour – ne posez pas le cadre directement au sol ou sur une table lorsque lepourtour est attaché. Retirez le pourtour de sorte à éviter que le poids ne s'exerce sur le pourtour. Pour éviter d'endommager le châssis – ne posez rien sur le dessus du cadre.</p>

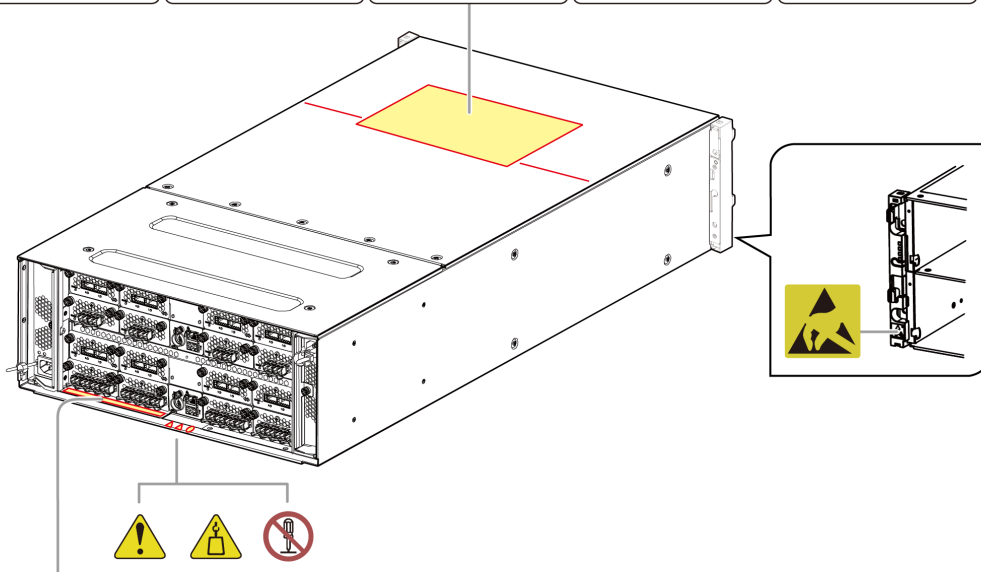

<p><b>⚠ 注意</b></p> <p>この装置は、二系列の電源構成になっており、装置から電力を取り除くには電源端子から2本の電源ケーブルを切り離してください。</p>	<p><b>⚠ CAUTION</b></p> <p>This array has a dual power supply configuration. To remove electricity from the array, unplug the two power cables from the power source.</p>	<p><b>⚠ VORSICHT</b></p> <p>Dieses Array hat mit einer doppelten Energieversorgungskonfiguration ausgestattet. Um die Energiezufuhr zum Array zu unterbrechen, ziehen Sie beide Kabel aus der Stromquelle.</p>	<p><b>⚠ PRECAUCIÓN</b></p> <p>Este cabina tiene una configuración dual de la fuente de alimentación. Al eliminar la electricidad del cabina, desconecte los cables de la fuente de alimentación.</p>	<p><b>⚠ ATTENTION</b></p> <p>Ce cadre est équipé d'un système de courant électrique dual. Afin de couper le courant du cadre, déconnectez les deux câbles de la source d'énergie.</p>	<p><b>⚠ 注意</b></p> <p>本装置は二電源構成になっており、装置から電力を取り除くには電源端子から2本の電源ケーブルを切り離してください。</p> <p>質量 約 85kg HWS-Approx.</p>
--	---	--	--	---	--

# Small form factor array drive tray

<p><b>⚠ CAUTION</b> <b>Take care not to drop</b></p> <p>Dropping the array may cause injury. Keep hands securely on array. Be aware of the red line marked on the array top and sides - When sliding the array out of the rail terminal past this mark, keep a firm hold on the array.</p>	<p><b>⚠ 注意</b> <b>落下注意</b></p> <p>装置が落下してけがをすることがあります。装置上面および側面の赤い線を越えて引き出す場合、装置を両手でしっかりと持ってください。</p>	<p><b>⚠ VORSICHT</b> <b>Nicht fallen lassen</b></p> <p>Beim Herunterfallen des Arrays können Personen verletzt werden. Halten Sie das Array stets sicher mit Ihren Händen fest. Beachten Sie die rote Linie, die oben und an den Seiten des Arrays angebracht ist.</p>	<p><b>⚠ PRECAUCIÓN</b> <b>Tenga cuidado para evitar caídas</b></p> <p>Dejar caer la cabina puede causar lesiones. Mantenga las manos de forma segura en la cabina. Respete la línea roja marcada en la parte superior y lateral de la cabina.</p>	<p><b>⚠ ATTENTION</b> <b>Prenez garde de ne pas laisser tomber</b></p> <p>Le fait de laisser tomber le cadre peut occasionner des blessures. Tenez fermement sur le cadre. Tenez compte de la ligne marquée en rouge sur le haut et sur les côtés du cadre.</p>
<p><b>⚠ CAUTION</b> <b>Heavy</b></p> <p>Lifting the heavy array may cause injury in your arms or low back. Use lifting equipment or handle the array with two or more personnel. This array weighs approximately 23kg.</p>	<p><b>⚠ 注意</b> <b>重量物注意</b></p> <p>重量物を持ち上げると、腕や腰を痛めます。リフターを使用したり、2人以上で扱ったりしてください。装置重量は約 23 kgです。</p>	<p><b>⚠ VORSICHT</b> <b>Hohes Gewicht</b></p> <p>Beim Anheben des schweren Arrays könnten Ihre Arme oder Ihr unterer Rücken verletzt werden. Verwenden Sie eine Hebevorrichtung oder transportieren Sie das Array mit mindestens zwei Personen. Dieses Array wiegt etwa 23kg.</p>	<p><b>⚠ PRECAUCIÓN</b> <b>Peso elevado</b></p> <p>Levantar una cabina pesada puede causar lesiones en los brazos o la región lumbar. Utilice un dispositivo de elevación o levante la cabina con la ayuda de dos o más personas. Esta cabina posee un peso aproximado de 23kg.</p>	<p><b>⚠ ATTENTION</b> <b>Poids</b></p> <p>Le fait de soulever le cadre qui est lourd peut entraîner des lésions aux bras ou au bas du dos. Utilisez un équipement de levage ou manipulez le cadre à deux personnes ou plus. Ce cadre pèse environ 23kg.</p>
<p><b>NOTICE</b></p> <p>Avoid damage - do not carry the array by its front side. Lift or carry the array by its left, right, or rear sides. Avoid damage to the bezel - do not place the array directly on the floor or table while the bezel is attached. Remove the bezel as needed to prevent weight from being applied to the bezel. Avoid damage to the chassis - do not place anything on top of the array.</p>	<p><b>通知</b></p> <p>運搬時は、装置前面を持たないでください。裏面および側面を持って、持ち上げたり運んだりしてください。装置にベゼルが付いた状態で、平置きしないでください。ベゼルが破損する恐れがありますので、ベゼルを脱着するか、ベゼルに外力が掛からないように置いてください。シャーシが変形する恐れがあります。装置の上面にも重くないでください。</p>	<p><b>HINWEIS</b></p> <p>Vermeiden Sie Beschädigungen - tragen Sie das Array nicht an seiner vorderen Seite. Heben oder tragen Sie das Array an seiner linken, rechten oder hinteren Seite. Beschädigen Sie das Array nicht direkt auf den Boden oder einen Tisch, wenn die Blende angebracht ist. Entfernen Sie die Blende bei Bedarf, damit sie keinen Gewicht ausgesetzt wird. Beschädigen Sie nicht das Gehäuse - stellen Sie keine Gegenstände oben auf das Array.</p>	<p><b>AVISO</b></p> <p>Evite daños: no transporte la cabina desde su lado frontal. Levante o transporte la cabina desde el lado izquierdo, derecho o trasero. Evite causar daños en el marco: no coloque la cabina directamente sobre el piso o mesa cuando el marco se encuentre colocado. Extraiga el marco según sea necesario para evitar que el peso quede apoyado sobre el marco. Evite causar daños al chasis: no coloque ningún objeto sobre la parte superior de la cabina.</p>	<p><b>AVIS</b></p> <p>Pour éviter les dégâts - ne portez pas le cadre par sa face avant. Soulevez ou transportez le cadre par ses côtés gauche, droit, ou arrière. Pour éviter d'endommager le pourtour - ne posez pas le cadre directement au sol ou sur une table lorsque le pourtour est attaché. Retirez le pourtour de sorte à éviter que le poids ne s'exerce sur le pourtour. Pour éviter d'endommager le châssis - ne posez rien sur le dessus du cadre.</p>

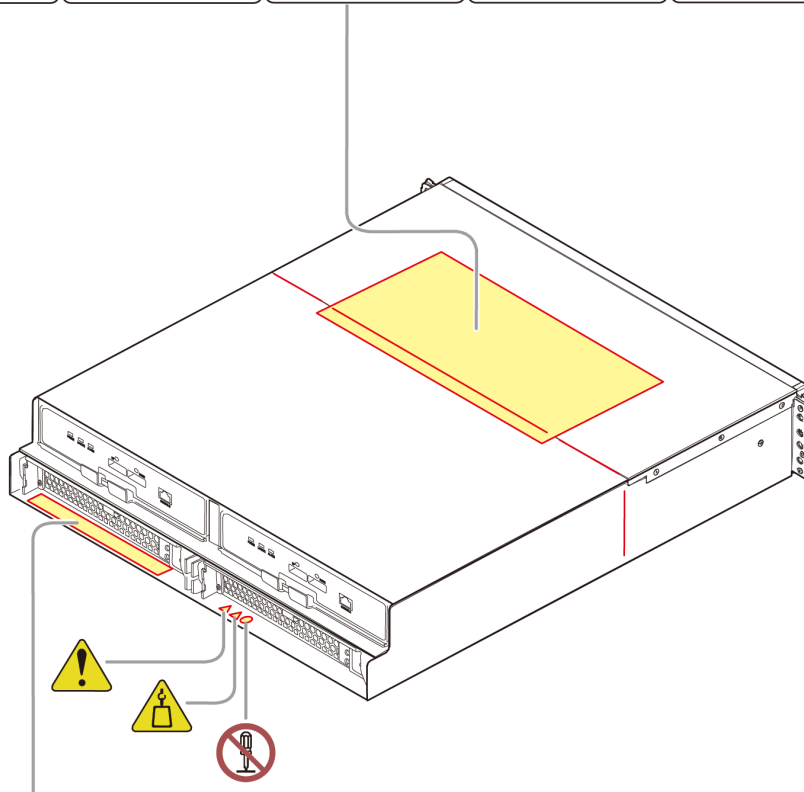

<p><b>⚠ 注意</b></p> <p>この装置は、電源の異常状態によって、電源供給が停止する場合があります。電源供給が停止する場合は、電源ケーブルから電源を切断してください。</p>	<p><b>⚠ CAUTION</b></p> <p>This array has a dual power supply configuration. In some instances, power may be supplied from the array, unplug the hot power cables from the power source.</p>	<p><b>⚠ VORSICHT</b></p> <p>Dieses Array hat eine doppelte Stromversorgung. In bestimmten Konfigurationen kann Strom aus dem Array gespeist werden. Entfernen Sie die Stromkabel vom Stromversorger.</p>	<p><b>⚠ PRECAUCIÓN</b></p> <p>Este cabinet tiene una configuración dual de la fuente de alimentación. Al seleccionar la electricidad del cabinet, desconecte los cables de la fuente de alimentación.</p>	<p><b>⚠ ATTENTION</b></p> <p>Ce cabinet dispose d'un système de courant double. Afin de couper le courant du cabinet, déconnectez les deux câbles de la source d'alimentation.</p>	<p><b>⚠ 注意</b></p> <p>本装置は電源供給が停止する場合があります。電源供給が停止する場合は、電源ケーブルから電源を切断してください。</p>
--	--	--	---	--	--

# Flash module drive tray

<p><b>⚠ CAUTION</b> <b>Take care not to drop</b></p> <p>Dropping the array may cause injury, keep hands securely on array. Be aware of the red line marked on the array top and sides.</p>	<p><b>⚠ 注意</b> <b>落下注意</b></p> <p>装置が落下してけがをする危険があります。装置上面および側面の赤い線を越えて引き出す場合、装置を両手でしっかりと持ってください。</p>	<p><b>⚠ VORSICHT</b> <b>Nicht fallen lassen</b></p> <p>Beim Herunterfallen des Arrays können Personen verletzt werden. Halten Sie das Array stets sicher mit Ihren Händen fest. Beachten Sie die rote Linie, die oben und an den Seiten des Arrays angebracht ist.</p>	<p><b>⚠ PRECAUCIÓN</b> <b>Tenga cuidado para evitar caídas</b></p> <p>Dejar caer la cabina puede causar lesiones. Mantenga las manos de forma segura en la cabina. Respete la línea roja marcada en la parte superior y lateral de la cabina.</p>	<p><b>⚠ ATTENTION</b> <b>Prenez garde de ne pas laisser tomber</b></p> <p>Le fait de laisser tomber le cadre peut occasionner des blessures. Tenez les mains fermement sur le cadre. Tenez compte de la ligne marquée en rouge sur le haut et sur les côtés du cadre.</p>
<p><b>⚠ CAUTION</b> <b>Heavy</b></p> <p>Lifting the heavy array may cause injury in your arms or low back. Use lifting equipment or handle the array with two or more personnel. This array weighs approximately 38kg.</p>	<p><b>⚠ 注意</b> <b>重量物注意</b></p> <p>重量物を持ち上げると、腕や腰を傷めます。リフターを使用したり、2人以上で扱ったりしてください。装置重量は約 38kgです。</p>	<p><b>⚠ VORSICHT</b> <b>Hohes Gewicht</b></p> <p>Beim Anheben des schweren Arrays könnten Ihre Arme oder Ihr unterer Rücken verletzt werden. Verwenden Sie eine Hebevorrichtung oder transportieren Sie das Array mit mindestens zwei Personen. Dieses Array wiegt etwa 38kg.</p>	<p><b>⚠ PRECAUCIÓN</b> <b>Peso elevado</b></p> <p>Levantar una cabina pesada puede causar lesiones en los brazos o la región lumbar. Utilice un dispositivo de elevación o levante la cabina con la ayuda de dos o más personas. Esta cabina posee un peso aproximado de 38kg.</p>	<p><b>⚠ ATTENTION</b> <b>Poids</b></p> <p>Le fait de soulever le cadre qui est lourd peut entraîner des lésions aux bras ou au bas dos. Utilisez un équipement de levage ou manipulez le cadre à deux personnes ou plus. Ce cadre pèse environ 38kg.</p>
<p><b>NOTICE</b></p> <p>Avoid damage - do not carry the array by its front side. Lift or carry the array by its left, right, or rear sides. Avoid damage to the bezel - do not place the array directly on the floor or table while the bezel is attached. Remove the bezel as needed to prevent weight from being applied to the bezel. Avoid damage to the chassis - do not place anything on top of the array.</p>	<p><b>通知</b></p> <p>運搬時は、装置前面を持たないでください。裏面する恐れがあります。前面および後面を持って、持ち上げたり運んだりしてください。装置にべゼルが付いた状態で、平置きしないでください。べゼを外すか、べゼに外力が掛からないようにしてください。フューズが変形する恐れがあります。装置の上面に何も置かないでください。</p>	<p><b>HINWEIS</b></p> <p>Vermeiden Sie Beschädigungen - tragen Sie das Array nicht an seiner vorderen Seite. Heben oder tragen Sie das Array an seiner linken, rechten oder hinteren Seite. Beschädigen - legen Sie das Array nicht direkt auf den Boden oder einen Tisch, wenn die Blende angebracht ist. Entfernen Sie die Blende bei Bedarf, damit sie keinen Gewicht ausgesetzt wird. Beschädigen Sie nicht das Gehäuse - stellen Sie keine Gegenstände oben auf das Array.</p>	<p><b>AVISO</b></p> <p>Evite daños: no transporte la cabina desde su lado frontal. Levante o transporte la cabina desde el lado izquierdo, derecho o trasero. Evite causar daños en el marco: no coloque la cabina directamente sobre el piso o mesa cuando el marco se encuentra colocado. Extraiga el marco según sea necesario para evitar que el peso quede apoyado sobre el marco. Evite causar daños al chasis: no coloque ningún objeto sobre la parte superior de la cabina.</p>	<p><b>AVIS</b></p> <p>Pour éviter les dégâts - ne portez pas le cadre par sa face avant. Soulevez ou transportez le cadre par ses côtés gauche, droit, ou arrière. Pour éviter d'endommager le pourtour - ne posez pas le cadre directement au sol ou sur une table lorsque le pourtour est attaché. Retirez le pourtour de sorte à éviter que le poids ne s'exerce sur le pourtour. Pour éviter d'endommager le châssis - ne posez rien sur le dessus du cadre.</p>

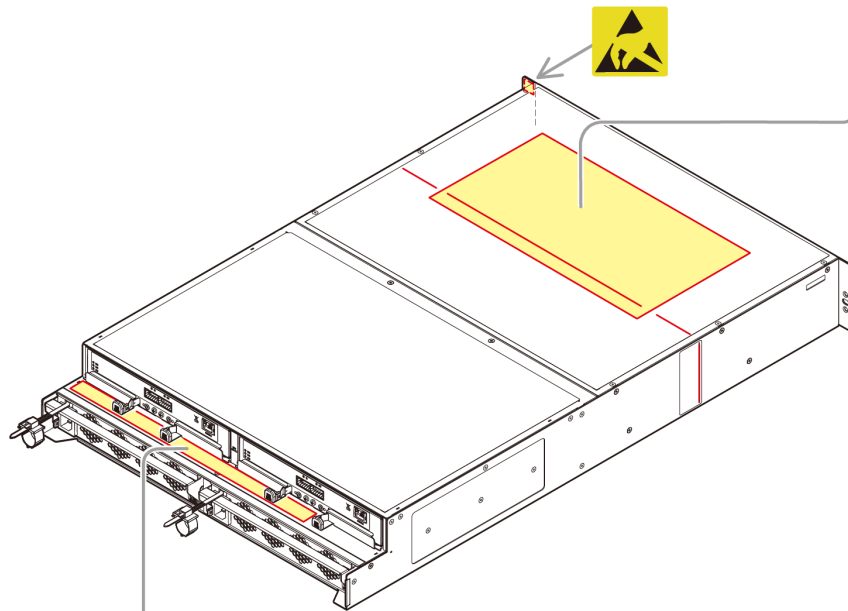

<p><b>⚠ 注意</b> この装置は、二重絶縁構造になっており、接地や漏れ電流による感電の恐れがあります。電源ケーブルのプラグを抜くときは必ず電源スイッチを切ってください。</p>	<p><b>⚠ CAUTION</b> This array has a dual power supply configuration. Do not touch the array when the power is on. The plug power cables have the power source.</p>	<p><b>⚠ VORSICHT</b> Dieses Array wird über doppelt gespeist. Berühren Sie das Array nicht, wenn es eingeschaltet ist. Achten Sie auch auf die Stromkabel, wenn Sie diese abstecken. Die Netzstecker haben die Stromquelle.</p>	<p><b>⚠ PRECAUCIÓN</b> Este módulo tiene una configuración de alimentación doble. No toque el módulo cuando esté encendido. Preste atención a los cables de alimentación, cuando los retire de la fuente de alimentación.</p>	<p><b>⚠ ATTENTION</b> Ce module est équipé d'un système de coupe-courant double. Ne touchez pas le module quand il est sous tension. Prenez garde des câbles de ligne d'alimentation.</p>	<p><b>⚠ 注意</b> 本装置は二重電源構成です。電源ケーブルのプラグを抜くときは必ず電源スイッチを切ってください。</p>	<p><b>European Regulatory Address:</b> Hitachi Computer Products (Europe) S.A.S Parc de Limeris, Zone Industrielle, 45160 Avoine, FRANCE</p>
--	---	---	---	---	---	--

## CBL controller

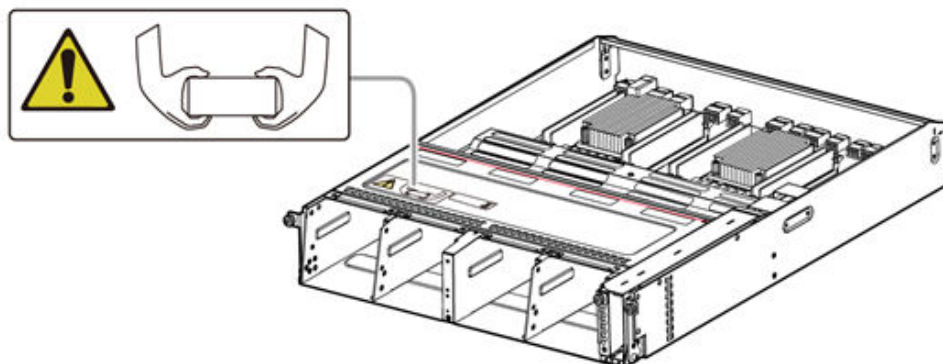

## Battery

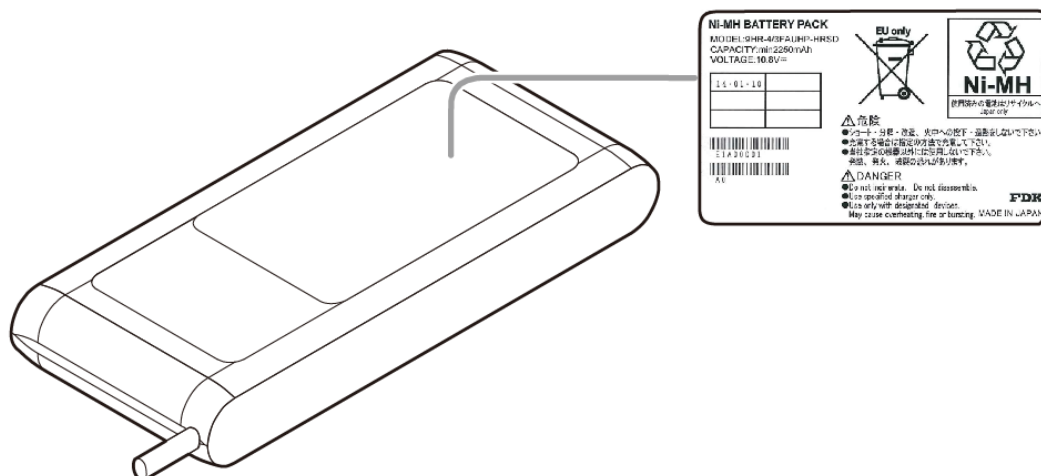

## Host port expansion chassis





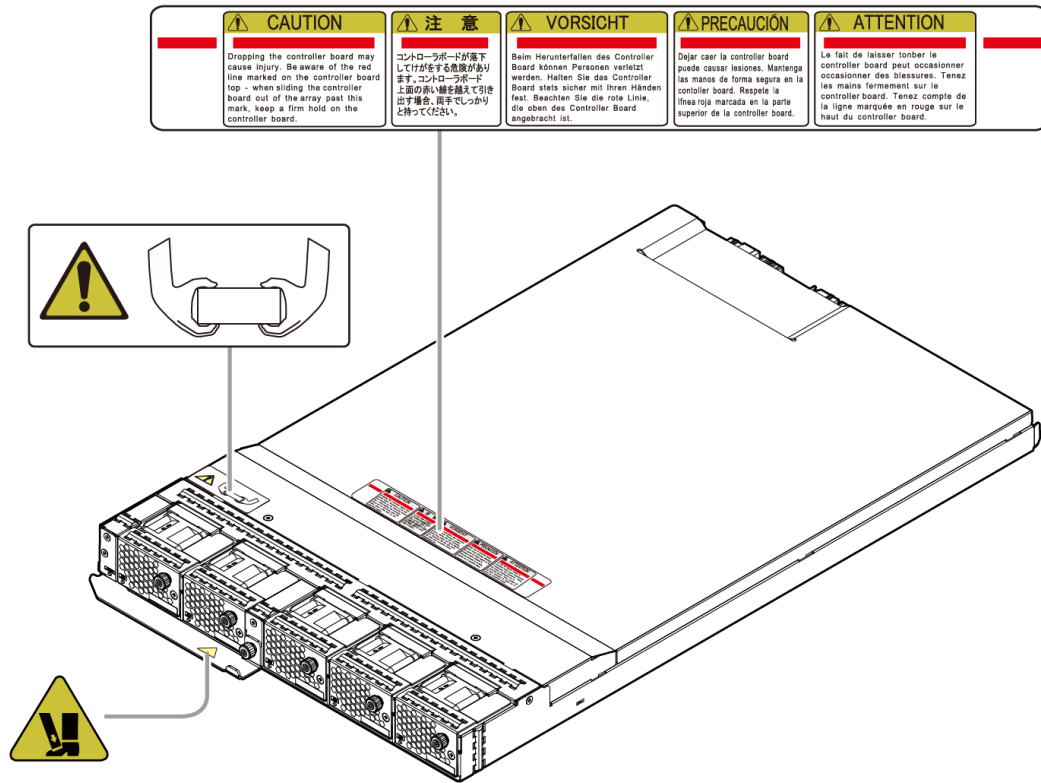

---

## Appendix H: Environmental notices

### Disposal



This symbol on the product or on its packaging means that your electrical and electronic equipment should be disposed at the end of life separately from your household wastes.

There are separate collection systems for recycling in the European Union. For more information, contact the local authority or the dealer where you purchased the product.

### Recycling

A nickel-metal hydride battery is used in the Cache Backup Battery.

A nickel-metal hydride battery is a resource that can be recycled. When you want to replace the Cache Backup Battery, call the service personnel. They will dispose of it for you. This nickel-metal hydride battery, which is designated as recycling product by a recycling promotion law, must be recycled.

The mark posted on the Cache Backup Battery is a three-arrow mark that indicates a recyclable part.



**Ni-MH**

---

## Appendix I: Regulatory compliance

This equipment has been tested and certified for compliance with the following standards.

## Country Specifications and Certifications

Standard	Specification	Product marking or logo	Country regulation
Electronic emission controls	FCC part 15 Sub B: 2016	FCC	USA and Canada
	ICES-003 Issue 6: 2016	ICES-003	USA and Canada
	AS/NZS CISPR 22: 2009+A1	RCM	Australia and New Zealand
	TP TC 020/2011	EAC	Russia, Belarus, and Kazakhstan
	CNS 13438	BSMI	Taiwan
	KN32	KC	Korea
	KN35		
Electronic emission certifications	EN55022: 2010	CE marking	EU
	EN55024: 2010		
	EN61000-3-2:2006+A1+A2		
	EN61000-3-3:2013		
Safety certifications	UL and CSA 60950-1:2007	cTuVus	United States of America and Canada
	EN60950-1:2006+A1 1+A1+A12+A2	TUV	Germany
	IEC60950-1:2005+A 1+A2	N/A	All CB countries
	IEC60950-1:2005+A 1+A2	S_Mark	Argentina
	TP TC 004/2011	EAC	Russia
	CNS 14336-1	BSMI	Taiwan
	EN60950-1:2006+A1 1+A1+A12+A2	CE marking	EU
	Radio interference voluntary control	VCCI V-3/2015.4	VCCI

**FDA radiation regulation**

The array complies with FDA radiation performance standard 21 CFR subchapter J.

**EMI regulation**

This equipment has been tested and found to comply with the limits for a Class A digital device, pursuant to Part 15 of the FCC Rules. These limits are designed to provide reasonable protection against harmful interference when the equipment is operated in a commercial environment. This equipment generates, uses, and can radiate radio frequency energy and, if not installed and used in accordance with the instruction manual, may cause harmful interference in which case the user will be required to correct the interference at his own expense. Testing was done with shielded cables. Therefore, in order to comply with the FCC regulations, you must use shielded cables with your installation.

If trouble occurs in another configuration, a user might be requested to take appropriate preventative measures:

- RKU + CBL + host port expansion chassis + flash module drive tray + 3 small form factor drive trays.

This product must not be used in residential areas.

This is a class A product. In a domestic environment this product can cause radio interference in which case the user can be required to take adequate measures.

**Hitachi Vantara**



Corporate Headquarters  
2535 Augustine Drive  
Santa Clara, CA 95054 USA  
[HitachiVantara.com](http://HitachiVantara.com) | [community.HitachiVantara.com](http://community.HitachiVantara.com)

Contact Information  
USA: 1-800-446-0744  
Global: 1-858-547-4526  
[HitachiVantara.com/contact](http://HitachiVantara.com/contact)