



Hitachi Universal Replicator

User Guide

Hitachi Virtual Storage Platform G1000 and G1500

Hitachi Virtual Storage Platform F1500

Hitachi Virtual Storage Platform G200, G400, G600, G800

Hitachi Virtual Storage Platform F400, F600, F800

© 2014, 2017 Hitachi, Ltd. All rights reserved.

No part of this publication may be reproduced or transmitted in any form or by any means, electronic or mechanical, including copying and recording, or stored in a database or retrieval system for commercial purposes without the express written permission of Hitachi, Ltd., or Hitachi Data Systems Corporation (collectively "Hitachi"). Licensee may make copies of the Materials provided that any such copy is: (i) created as an essential step in utilization of the Software as licensed and is used in no other manner; or (ii) used for archival purposes. Licensee may not make any other copies of the Materials. "Materials" mean text, data, photographs, graphics, audio, video and documents.

Hitachi reserves the right to make changes to this Material at any time without notice and assumes no responsibility for its use. The Materials contain the most current information available at the time of publication.

Some of the features described in the Materials might not be currently available. Refer to the most recent product announcement for information about feature and product availability, or contact Hitachi Data Systems Corporation at https://support.hds.com/en_us/contact-us.html.

Notice: Hitachi products and services can be ordered only under the terms and conditions of the applicable Hitachi agreements. The use of Hitachi products is governed by the terms of your agreements with Hitachi Data Systems Corporation.

By using this software, you agree that you are responsible for:

1. Acquiring the relevant consents as may be required under local privacy laws or otherwise from authorized employees and other individuals to access relevant data; and
2. Verifying that data continues to be held, retrieved, deleted, or otherwise processed in accordance with relevant laws.

Notice on Export Controls. The technical data and technology inherent in this Document may be subject to U.S. export control laws, including the U.S. Export Administration Act and its associated regulations, and may be subject to export or import regulations in other countries. Reader agrees to comply strictly with all such regulations and acknowledges that Reader has the responsibility to obtain licenses to export, re-export, or import the Document and any Compliant Products.

Hitachi is a registered trademark of Hitachi, Ltd., in the United States and other countries.

AIX, AS/400e, DB2, Domino, DS6000, DS8000, Enterprise Storage Server, eServer, FICON, FlashCopy, IBM, Lotus, MVS, OS/390, PowerPC, RS/6000, S/390, System z9, System z10, Tivoli, z/OS, z9, z10, z13, z/VM, and z/VSE are registered trademarks or trademarks of International Business Machines Corporation.

Active Directory, ActiveX, Bing, Excel, Hyper-V, Internet Explorer, the Internet Explorer logo, Microsoft, the Microsoft Corporate Logo, MS-DOS, Outlook, PowerPoint, SharePoint, Silverlight, SmartScreen, SQL Server, Visual Basic, Visual C++, Visual Studio, Windows, the Windows logo, Windows Azure, Windows PowerShell, Windows Server, the Windows start button, and Windows Vista are registered trademarks or trademarks of Microsoft Corporation. Microsoft product screen shots are reprinted with permission from Microsoft Corporation.

All other trademarks, service marks, and company names in this document or website are properties of their respective owners.



Contents

Preface.....	13
Intended audience.....	14
Product version.....	14
Release notes.....	14
Changes in this revision.....	14
Referenced documents.....	14
Document conventions.....	15
Conventions for storage capacity values.....	16
Accessing product documentation.....	17
Getting help.....	17
Comments.....	17
1 Universal Replicator overview.....	19
About Universal Replicator	20
Replication operations.....	20
Obtain journal.....	21
Journal copy.....	21
Restore journal.....	22
System components.....	22
Storage systems.....	23
Pair volumes.....	24
Journal volumes.....	24
Journals.....	24
Mirror.....	25
Split mirror operations.....	26
Resync mirror operations.....	27
Delete mirror operations.....	28
Data path.....	28
Consistency groups and journals.....	28
Device Manager - Storage Navigator.....	29
Command Control Interface (CCI).....	29
Copy operations.....	29
Initial copy operation	29
Update copy operation.....	30
Read and write I/O during remote copy.....	30

Differential data management.....	31
S-VOL write option.....	32
Pair status.....	33
Pair status definitions.....	33
Additional information on pair status.....	36
UR PSUS types and behaviors.....	37
UR PSUE types and behaviors.....	38
3DC configurations with three UR sites.....	40
3DC multi-target configuration with three UR sites.....	40
3DC cascade configuration with three UR sites.....	41
2 Requirements and specifications.....	43
System requirements.....	44
Interoperability requirements.....	49
Volume types that can be shared with Universal Replicator.....	49
Cache Residency Manager	52
Data Retention Utility	52
Dynamic Provisioning	53
Global-active device.....	54
Global storage virtualization.....	56
LUN Manager.....	56
Resource Partition Manager.....	56
Thin Image.....	56
UR basic configuration with TI.....	56
3DC cascade configuration with TI.....	57
3DC multi-target configuration with TI.....	57
Delta Resync configuration with TI.....	58
Universal Volume Manager.....	59
Virtual LUN	59
Volume Migration.....	60
3 Planning for Universal Replicator.....	61
Planning and design.....	63
Assessing business requirements for data recovery	64
Determining your RPO.....	64
Write-workload	64
Measuring write-workload.....	65
Data transfer speed considerations	65
RAID group configuration	65
Fibre Channel or iSCSI port configuration.....	65
Sizing journal volumes	66
Planning journals	67
Planning journal volumes	67
Planning journal volumes for delta resync.....	69
Planning pair volumes	69
Maximum number of pairs allowed.....	70
Calculating maximum number of pairs.....	71
Maximum initial copy operations and priorities.....	73
Disaster recovery considerations.....	74
Host failover software	74

Cache and additional shared memory.....	75
Adding and removing cache memory.....	75
Adding shared memory.....	75
Removing shared memory (TC/UR/GAD).....	76
Removing shared memory (64KLDEV Extension).....	76
Sharing volumes with other product volumes.....	77
Planning UR in multiple storage systems using a consistency group.....	77
Requirements and recommendations for multiple system CTGs.....	78
Planning for other storage systems.....	79
Registering multiple journals to a CCI consistency group	81
Preparing the storage systems for UR	83
System option modes	83
4 Planning the data path.....	97
Data path design	98
Sizing bandwidth	98
Five sizing strategies	99
Calculating bandwidth	100
Sizing bandwidth for peak write-workload.....	100
Sizing bandwidth for peak rolling average write-workload.....	101
Latency	103
Packet loss	104
Planning ports for data transfer.....	104
Port types (VSP G1000, G1500, and VSP F1500).....	105
Supported data path configurations	105
Fibre Channel data path requirements.....	107
Additional switches.....	108
iSCSI data path requirements.....	109
5 UR configuration operations.....	113
Configuration workflow	114
Workflow for 3DC multi-target configuration with three UR sites.....	115
Workflow for 3DC cascade configuration with three UR sites.....	115
Defining Fibre Channel or iSCSI port attributes (VSP G1000, G1500, and VSP F1500)	116
Configuring primary and secondary storage systems for UR	117
Configuring additional remote paths.....	119
Creating journals and adding journal volumes	120
Assigning an MP blade to a journal.....	123
Setting the remote replica options.....	124
Setting the maximum initial copy activities option.....	124
Setting the blocked-path monitoring and blocked-path SIM monitoring options....	125
6 UR pair operations.....	127
Pair operations	128
Creating a UR pair	128
Checking the pair status.....	133
Splitting a UR pair	134
Splitting a mirror	136

Creating point-in-time copies	137
Resynchronizing a UR pair	138
Resynchronizing a mirror	140
Deleting a UR pair	141
Deleting pairs in a mirror	144
Managing pairs in a GAD 3DC delta resync environment (VSP G1000, G1500, and VSP F1500).....	145
Executing delta resync.....	146
Notes on delta resync.....	147
In case of delta resync failure.....	148
Resynchronizing GAD pairs in a GAD 3DC delta resync environment.....	149
Deleting GAD pairs in a GAD 3DC delta resync environment.....	149
7 GAD 3DC delta resync (GAD+UR) operations	151
GAD 3DC delta resync system configuration.....	152
Sites.....	152
Storage systems.....	153
Servers.....	153
Networks.....	154
GAD+UR pairs.....	154
Primary storage system settings.....	155
GAD secondary storage system settings.....	156
UR secondary storage system settings.....	158
CCI server configuration.....	159
Workflow for creating a GAD 3DC delta resync environment.....	160
Initial state.....	160
Preparing the UR secondary site.....	161
Installing the software products.....	162
Creating the command devices.....	163
Creating the UR delta resync pairs.....	165
Creating the configuration definition file.....	165
Starting CCI.....	165
Connecting the GAD secondary system and the UR secondary system.....	166
Setting the port attributes	167
Adding the remote connections.....	168
Setting up the GAD secondary storage system.....	170
Setting up the UR secondary storage system.....	172
Updating the CCI configuration definition files.....	177
Creating the UR delta resync pairs.....	179
Creating the UR pairs in a GAD+UR configuration.....	181
Setting the port attributes	181
Adding the remote connections.....	182
Setting up the primary storage system.....	184
Updating the CCI configuration definition files.....	187
Creating the UR pairs.....	189
Starting GAD+UR operations.....	190
8 Monitoring the UR system	193
Monitoring pair activity, status, license capacity.....	194
Suspend conditions for Universal Replicator pairs.....	195

Monitoring UR pair synchronization rate.....	196
Monitoring UR operations history.....	197
Pair operations history.....	198
Saving pair information to a text file	199
Monitoring copy operations and I/O statistics.....	200
Monitoring I/O and hardware performance with Performance Monitor.....	201
Monitoring journal (mirror) status.....	202
Device Manager - Storage Navigator mirror status definitions.....	202
CCI mirror status definitions.....	203
Monitoring UR remote connections and path status.....	203
9 Maintaining the UR system.....	205
Maintenance activities.....	206
Pair maintenance	206
Changing the maximum initial copy activities option.....	206
Changing the pair options	207
Forcibly deleting pairs.....	208
Releasing the differential data managed in a pool.....	209
Restoring a pair by adding a reserve journal volume.....	210
Restoring a pair without adding a reserve journal volume.....	210
Journal and mirror maintenance.....	211
Changing options used by journals	211
Changing options used by mirrors	213
Adding an additional journal volume to an existing journal.....	215
Replacing a journal volume with a reserve journal volume.....	216
Replacing a journal volume with a reserve journal volume using CCI.....	217
Adding a reserve journal volume.....	218
Deleting journal volumes from a journal	218
Deleting journals	219
Remote path maintenance.....	220
Modifying the data-transfer time threshold	221
Deleting remote paths	221
Deleting the UR relationship	222
Managing power-off for systems and network devices	223
When power stops unexpectedly.....	224
When power is removed from primary or secondary storage system.....	224
When power is removed from network relay devices.....	224
Planned outage of storage systems and network devices.....	224
Powering-off the primary or secondary storage system.....	224
Powering-off primary and secondary storage systems at the same time.....	225
Powering-off network relay devices.....	226
Planned outage of storage systems in a GAD 3DC delta resync environment (VSP G1000, G1500, and VSP F1500).....	226
Powering off the GAD+UR primary storage system.....	226
Powering on the GAD+UR primary storage system.....	227
Powering off the GAD secondary storage system.....	228
Powering on the GAD secondary storage system.....	229
Powering off the UR secondary storage system.....	229
Powering on the UR secondary storage system.....	230
Powering off the external storage system, I/O at primary site (GAD+UR).....	231
Powering on the external storage system, I/O at primary site (GAD+UR).....	232

Powering off external storage system, I/O at secondary site (GAD+UR).....	233
Powering on external storage system, I/O at secondary site (GAD+UR).....	234

10 UR disaster recovery operations..... 237

Overview of disaster recovery operations.....	238
Workflow for disaster recovery.....	238
Preparing for disaster recovery	239
Preparing for file and database recovery	239
Switching host operations to the secondary site	239
Reversing copy direction from secondary to primary site	240
Resuming host operations at the primary site	240
Recovery for configurations with multiple primary systems and secondary systems...	241
Switching from the primary to secondary site (multiple storage systems).....	241
Transferring operations back to the primary site (multiple storage systems).....	242
Recovery for 3DC configurations with three UR sites.....	242
Recovery for 3 UR DC multi-target configuration (when the delta operation resync is performed).....	242
Moving business operations to the secondary site.....	242
Moving business operations back to the primary site.....	243
Requirements for performing delta resync in 3DC multi-target configuration with three UR sites.....	246
Recovering from failures in a 3 UR DC cascade configuration.....	248
Recovering when a failure occurs in the primary site.....	248
Recovering when a failure occurs in the intermediate site.....	250
Recovering when a failure occurs in the primary-intermediate path.....	252
Resynchronizing journals between the primary and secondary sites.....	253
Resynchronizing journals in the primary and intermediate sites.....	253
Recovering when a failure occurs in the secondary site.....	253
Recovery for 3DC cascade configuration with three UR sites.....	253
Recovering from a primary site failure.....	253
Recovering from an intermediate site failure for a 3DC cascade configuration with three UR sites.....	254
Requirements for performing delta resync in 3DC cascade configuration with three UR sites.....	254
Recovery for 3DC UR/TC.....	255
Recovery for 3DC UR/TC cascade configuration	256
Recovery for 3DC UR/TC multi-target configuration.....	256
Recovering from primary site failure.....	256
Recovering from primary and secondary site failure (3DC multi-target).....	258
Recovery in a delta resync configuration.....	259
Problems with pair status during delta resync recovery.....	260
Recovery for UR/SI configurations.....	261
Recovery from a failure at the primary site and TC secondary site.....	261
Switching from the primary to secondary site (TC secondary site).....	262
Transferring operations back to the primary site (TC secondary site).....	262
Recovery for UR/GAD configurations.....	264

11 Disaster recovery in a GAD 3DC delta resync environment 265

Status before failure.....	266
Recovering from primary site and P-VOL failures (GAD+UR).....	266

Recovering from a primary site failure (GAD+UR).....	267
Recovering from a P-VOL failure (LDEV blockade) at the primary site (GAD+UR).....	270
Reversing the GAD P-VOL and S-VOL (GAD+UR).....	272
Recovering from secondary site and S-VOL failures (GAD+UR).....	273
Recovering from a secondary site failure (GAD+UR).....	274
Recovering from a failure (LDEV blockade) on an S-VOL at the secondary site (GAD+UR).....	276
Recovering from a failure at the primary and secondary sites (GAD+UR).....	278
Recovering from a failure on the UR delta resync pair.....	281
Recovering from a quorum disk failure (GAD+UR).....	282
Recovering from a quorum disk failure when one GAD volume is accessible.....	283
Recovering from a quorum disk failure when neither GAD volume is accessible....	284

12 Troubleshooting..... 289

General troubleshooting.....	290
Remote path status problems.....	292
Troubleshooting by suspend type	294
Troubleshooting hardware problems affecting pairs.....	295
Troubleshooting with CCI	296
Service information messages (SIMs).....	314
SIM reference code tables.....	315
Completing SIMs.....	317
Notification of suspension due to an error (multiple primary and secondary systems)	318
Calling customer support.....	319

A Configurations with TrueCopy..... 321

Overview of UR/TC configurations.....	322
Sharing volumes with TrueCopy	322
3DC cascade configuration.....	323
Prerequisites for 3DC cascade.....	323
Setting up the 3DC cascade configuration.....	324
3DC multi-target configuration.....	325
Prerequisites for 3DC multi-target.....	326
Setting up 3DC multi-target configuration.....	326
Delta resync configuration	327
Additional task for the 3DC multi-target configuration using delta resync.....	328
Creating the delta resync pair.....	329
Setting up remote command devices for use with CCI.....	330
Mapping remote command devices for delta resync operations.....	332
Assigning mirrors to remote command devices for delta resync operations.....	334
Releasing a remote command device for delta resync operations assigned to a mirror.....	336
Relationship between deleted associated pairs and assigned remote command devices.....	337
Automatically deleted pairs that are automatically released.....	337
Performing the delta resync operation.....	338
Problems that can occur in the delta resync operation.....	340
Delta resync failure error prevention.....	340

B	Configurations with ShadowImage.....	341
	Overview of UR/SI configurations.....	342
	Configurations with SI primary volumes.....	342
	Configurations with SI secondary volumes	345
	Pair status and data currency.....	346
C	UR CLI reference.....	349
	Configuration operations.....	350
	Pair operations.....	351
	Monitoring operations.....	352
	Maintenance operations.....	353
	Consistency group operations.....	353
D	UR GUI reference.....	355
	Journals window.....	358
	Journal Volumes window.....	361
	Journal Properties window.....	366
	Create Journals wizard.....	369
	Create Journals window.....	369
	Select Journal Volumes dialog box.....	373
	Create Journals confirmation window.....	375
	Assign Journal Volumes wizard.....	377
	Assign Journal Volumes window.....	377
	Assign Journal Volumes confirmation window.....	379
	Delete Journals window.....	381
	Edit Journal Options wizard.....	382
	Edit Journal Options window.....	382
	Edit Journal Options confirmation window.....	383
	Assign MP Blade ID or MP Unit ID wizard.....	385
	Assign MP Blade ID or MP Unit ID window.....	385
	Assign MP Blade ID or MP Unit ID confirmation window.....	386
	Edit Mirror Options wizard.....	387
	Edit Mirror Options window.....	387
	Edit Mirror Options confirmation window.....	388
	Assign Remote Command Devices wizard.....	390
	Assign Remote Command Devices window.....	390
	Assign Remote Command Devices confirmation window.....	391
	Release Remote Command Devices window.....	392
	View Pair Synchronization Rate window.....	393
	Create UR Pairs wizard	395
	Create UR pairs window.....	395
	Change Settings window.....	400
	Create UR Pairs confirmation window.....	402
	View Pair Properties window.....	404
	Split Pairs wizard.....	407
	Split Pairs window.....	407
	Split Pairs confirmation window.....	409
	Split Mirrors wizard.....	410
	Split Mirrors window.....	410

Split Mirrors confirmation window.....	412
Resync Pairs wizard.....	414
Resync Pairs window.....	414
Resync Pairs confirmation window.....	416
Resync Mirrors wizard.....	417
Resync Mirrors window.....	417
Delete Pairs wizard.....	419
Delete Pairs window.....	419
Delete Pairs confirmation window.....	420
Force Delete Pairs window.....	422
Delete Mirrors wizard.....	423
Delete Mirrors window.....	423
Delete Mirrors confirmation window.....	424
Edit Pair Options wizard.....	426
Edit Pair Options window.....	426
Edit Pair Options confirmation window.....	427
Complete SIMs (UR) window (VSP G1000, G1500, and VSP F1500).....	428
Replication window.....	429
Remote Replication window.....	431
Remote Connections window.....	444
View Remote Connection Properties window.....	448
History window.....	451
Add Remote Connection window.....	453
Add Remote Connection confirmation window.....	456
Edit Remote Replica Options window.....	458
Edit Remote Replica Options confirmation window.....	461
Add Remote Paths window.....	463
Add Remote Paths confirmation window.....	466
Remove Remote Paths window.....	467
Remove Remote Paths confirmation window.....	470
Edit Remote Connection Options window.....	471
Edit Remote Connection Options confirmation window.....	472
Remove Remote Connections window.....	474
Edit Ports window.....	475
Edit Ports confirmation window.....	479
Glossary.....	483
Index.....	495



Preface

This document describes and provides instructions for using the Hitachi Universal Replicator (UR) feature.

Please read this document carefully to understand how to use this product, and maintain a copy for your reference.

- [Intended audience](#)
- [Product version](#)
- [Release notes](#)
- [Changes in this revision](#)
- [Referenced documents](#)
- [Document conventions](#)
- [Conventions for storage capacity values](#)
- [Accessing product documentation](#)
- [Getting help](#)
- [Comments](#)

Intended audience

This document is intended for system administrators, Hitachi Data Systems representatives, and authorized service providers.

Readers of this document should be familiar with the following:

- Data processing and RAID storage systems and their basic functions.
- The Hitachi Virtual Storage Platform storage system and the *Hardware Guide* for your storage system model.
- The Hitachi Device Manager - Storage Navigator software and *System Administrator Guide*.

Product version

This document revision applies to the following Microcode or firmware:

- VSP G1000, G1500, and VSP F1500: Microcode 80-05-4x or later
- VSP G200, G400, G600, G800, VSP F400, F600, F800: firmware 83-04-4x or later
- SVOS 7.2 or later

Release notes

Read the release notes before installing and using this product. They may contain requirements or restrictions that are not fully described in this document or updates or corrections to this document. Release notes are available on Hitachi Data Systems Support Connect: <https://knowledge.hds.com/Documents>.

Changes in this revision

- Added information *Configuration workflow* about versions that support 3DC configurations with three UR sites. See [Configuration workflow on page 114](#).

Referenced documents

The following documents are referenced in this guide:

- *Command Control Interface Installation and Configuration Guide*, MK-90RD7008
- *Command Control Interface User and Reference Guide*, MK-90RD7010
- *Global-Active Device User Guide*, MK-92RD8072
- *Hitachi TrueCopy® User Guide*, MK-92RD8019

- *Performance Guide*, MK-94HM8012
- *System Administrator Guide*, MK-94RD8016

Document conventions

This document uses the following storage system terminology conventions:





Convention	Description
VSP G series	Refers to the following storage systems: <ul style="list-style-type: none"> • Hitachi Virtual Storage Platform G1000 and G1500 • Hitachi Virtual Storage Platform G200 • Hitachi Virtual Storage Platform G400 • Hitachi Virtual Storage Platform G600 • Hitachi Virtual Storage Platform G800
VSP F series	Refers to the following storage systems: <ul style="list-style-type: none"> • Hitachi Virtual Storage Platform F1500 • Hitachi Virtual Storage Platform F400 • Hitachi Virtual Storage Platform F600 • Hitachi Virtual Storage Platform F800
VSP Gx00 models	Refers to all of the following models, unless otherwise noted. <ul style="list-style-type: none"> • Hitachi Virtual Storage Platform G200 • Hitachi Virtual Storage Platform G400 • Hitachi Virtual Storage Platform G600 • Hitachi Virtual Storage Platform G800
VSP Fx00 models	Refers to all of the following models, unless otherwise noted. <ul style="list-style-type: none"> • Hitachi Virtual Storage Platform F400 • Hitachi Virtual Storage Platform F600 • Hitachi Virtual Storage Platform F800

This document uses the following typographic conventions:

Convention	Description
Bold	<ul style="list-style-type: none"> • Indicates text in a window, including window titles, menus, menu options, buttons, fields, and labels. Example: Click OK. • Indicates emphasized words in list items.
<i>Italic</i>	<ul style="list-style-type: none"> • Indicates a document title or emphasized words in text. • Indicates a variable, which is a placeholder for actual text provided by the user or for output by the system. Example: <code>pairdisplay -g group</code> <p>(For exceptions to this convention for variables, see the entry for angle brackets.)</p>
Monospace	Indicates text that is displayed on screen or entered by the user. Example: <code>pairdisplay -g oradb</code>
< > angle brackets	Indicates variables in the following scenarios:

Convention	Description
	<ul style="list-style-type: none"> Variables are not clearly separated from the surrounding text or from other variables. Example: <pre>Status-<report-name><file-version>.csv</pre> Variables in headings.
[] square brackets	Indicates optional values. Example: [a b] indicates that you can choose a, b, or nothing.
{ } braces	Indicates required or expected values. Example: { a b } indicates that you must choose either a or b.
vertical bar	Indicates that you have a choice between two or more options or arguments. Examples: [a b] indicates that you can choose a, b, or nothing. { a b } indicates that you must choose either a or b.

This document uses the following icons to draw attention to information:

Icon	Label	Description
	Note	Calls attention to important or additional information.
	Tip	Provides helpful information, guidelines, or suggestions for performing tasks more effectively.
	Caution	Warns the user of adverse conditions and/or consequences (for example, disruptive operations, data loss, or a system crash).
	WARNING	Warns the user of a hazardous situation which, if not avoided, could result in death or serious injury.

Conventions for storage capacity values

Physical storage capacity values (for example, disk drive capacity) are calculated based on the following values:

Physical capacity unit	Value
1 kilobyte (KB)	1,000 (10 ³) bytes
1 megabyte (MB)	1,000 KB or 1,000 ² bytes
1 gigabyte (GB)	1,000 MB or 1,000 ³ bytes
1 terabyte (TB)	1,000 GB or 1,000 ⁴ bytes
1 petabyte (PB)	1,000 TB or 1,000 ⁵ bytes
1 exabyte (EB)	1,000 PB or 1,000 ⁶ bytes

Logical capacity values (for example, logical device capacity, cache memory capacity) are calculated based on the following values:

Logical capacity unit	Value
1 block	512 bytes
1 cylinder	Mainframe: 870 KB Open-systems: <ul style="list-style-type: none"> • OPEN-V: 960 KB • Others: 720 KB
1 KB	1,024 (2 ¹⁰) bytes
1 MB	1,024 KB or 1,024 ² bytes
1 GB	1,024 MB or 1,024 ³ bytes
1 TB	1,024 GB or 1,024 ⁴ bytes
1 PB	1,024 TB or 1,024 ⁵ bytes
1 EB	1,024 PB or 1,024 ⁶ bytes

Accessing product documentation

Product user documentation is available on Hitachi Data Systems Support Connect: <https://knowledge.hds.com/Documents>. Check this site for the most current documentation, including important updates that may have been made after the release of the product.

Getting help

[Hitachi Data Systems Support Connect](https://support.hds.com/en_us/contact-us.html) is the destination for technical support of products and solutions sold by Hitachi Data Systems. To contact technical support, log on to Hitachi Data Systems Support Connect for contact information: https://support.hds.com/en_us/contact-us.html.

[Hitachi Data Systems Community](https://community.hds.com) is a global online community for HDS customers, partners, independent software vendors, employees, and prospects. It is the destination to get answers, discover insights, and make connections. **Join the conversation today!** Go to community.hds.com, register, and complete your profile.

Comments

Please send us your comments on this document to doc.comments@hds.com. Include the document title and number, including the revision level (for example, -07), and refer to specific sections and paragraphs whenever possible. All comments become the property of Hitachi Data Systems Corporation.

Thank you!

Universal Replicator overview

This chapter provides an overview of Hitachi Universal Replicator (UR) operations.

- [About Universal Replicator](#)
- [Replication operations](#)
- [System components](#)
- [Copy operations](#)
- [Pair status](#)
- [3DC configurations with three UR sites](#)

About Universal Replicator

Hitachi Universal Replicator (UR) presents a solution to avoid cases when a data center is affected by a disaster that stops operations for a long period of time. In the Universal Replicator system, a secondary storage system is located at a remote site from the primary storage system at the main data center, and the data on the primary volumes (P-VOLs) at the primary site is copied to the secondary volumes (S-VOLs) at the remote site asynchronously from the host write operations to the P-VOLs. Journal data is created synchronously with the updates to the P-VOL to provide a copy of the data written to the P-VOL. The journal data is managed at the primary and secondary sites to ensure the consistency of the primary and secondary volumes.

The redundancy provided by the RAID configuration (for example, RAID1 or RAID5) enables recovery from a P-VOL read failure. The primary storage system never reads the Universal Replicator S-VOL for data recovery.

Replication operations

Remote replication for a UR pair is accomplished using the master journal volume on the primary storage system and the restore journal volume on the secondary storage system. As shown in the following figure, the P-VOL data and subsequent updates are transferred to the S-VOL by obtain journal, read journal, and restore journal operations involving the master and restore journal volumes.

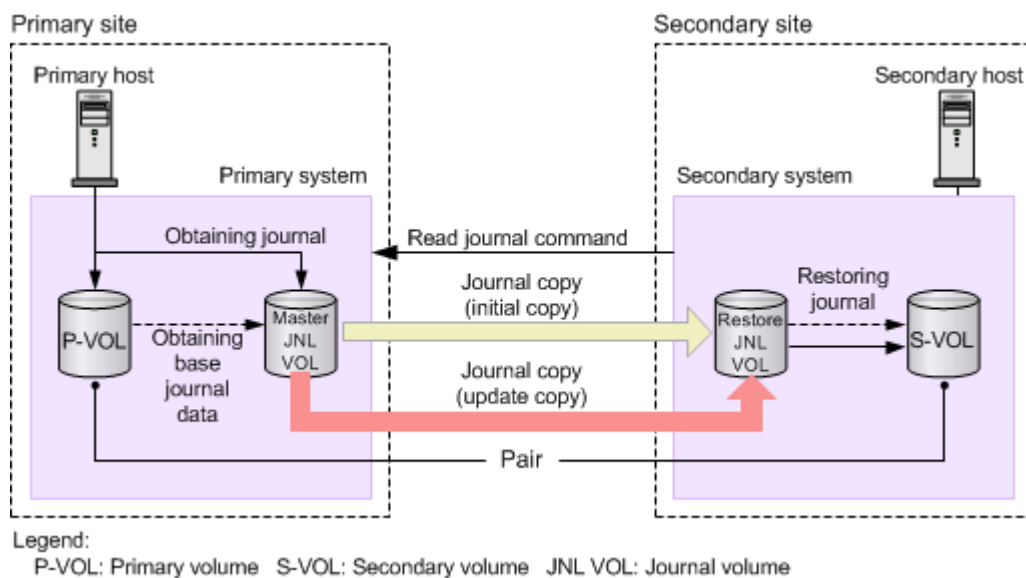

**Note:**

- Universal Replicator does not have a feature to copy the data from one P-VOL to multiple S-VOLs or to copy the data from multiple P-VOLs to one S-VOL.
 - If the primary system fails reading a P-VOL, the redundancy of RAID-1, RAID-5, or RAID-6 enables the recovery from the failure. The primary system never reads the S-VOL for data recovery.
-

Obtain journal

Obtain journal operations are performed when the primary storage system writes journal data to the master journal volume. The journal data consists of the P-VOL data to be copied to the S-VOL as well as update sequence information and other metadata. When a pair is created and the P-VOL data is copied for the first time, the journal data copied to the master journal volume is called the base journal data. When the host writes updated data to the P-VOL, normal journal data is copied to the master journal volume. If a P-VOL write operation fails, the primary storage system does not create the journal data.

- The primary storage system assigns write-sequence numbers to the P-VOL data copied to the master journal volume.
- The write-sequence numbers and other metadata attached to the journal data ensure the consistency of the data in the P-VOL and S-VOL.

Journal copy

Journal copy operations are performed when journal data is copied from the master journal volume to the restore journal volume on the secondary storage system.

- When the secondary storage system issues the read-journal command to the primary storage system, the primary storage system transfers the journal data stored in the master journal volume to the restore journal volume in the secondary storage system.
- Journal copy operations occur on a continual basis unless there is no journal data in the master journal volume. The request for data from the secondary storage system is repeated as soon as the previous read operation is completed.

The UR journal copy operations "pull" data from the primary storage system to the secondary storage system. Journal data is copied to the secondary site only when the secondary storage system issues a read-journal command, with the primary storage system operating as a resource controlled by the secondary storage system's transaction processor.

Restore journal

Restore journal operations are performed when the secondary storage system writes journal data in the restore journal volume to the S-VOL.

- Journal data in the restore journal volume is copied to the S-VOL according to the write-sequence numbers to ensure data consistency.
- When a restore journal operation to the S-VOL is completed, the journal data in the restore journal volume is discarded, and the journal data in the master journal volume is also discarded.

The primary storage system discards journal data in the master journal volume when it receives the sequence number from the restore journal, which is attached to the read journal command from the secondary storage system.

System components

The following figure shows the Universal Replicator system components.

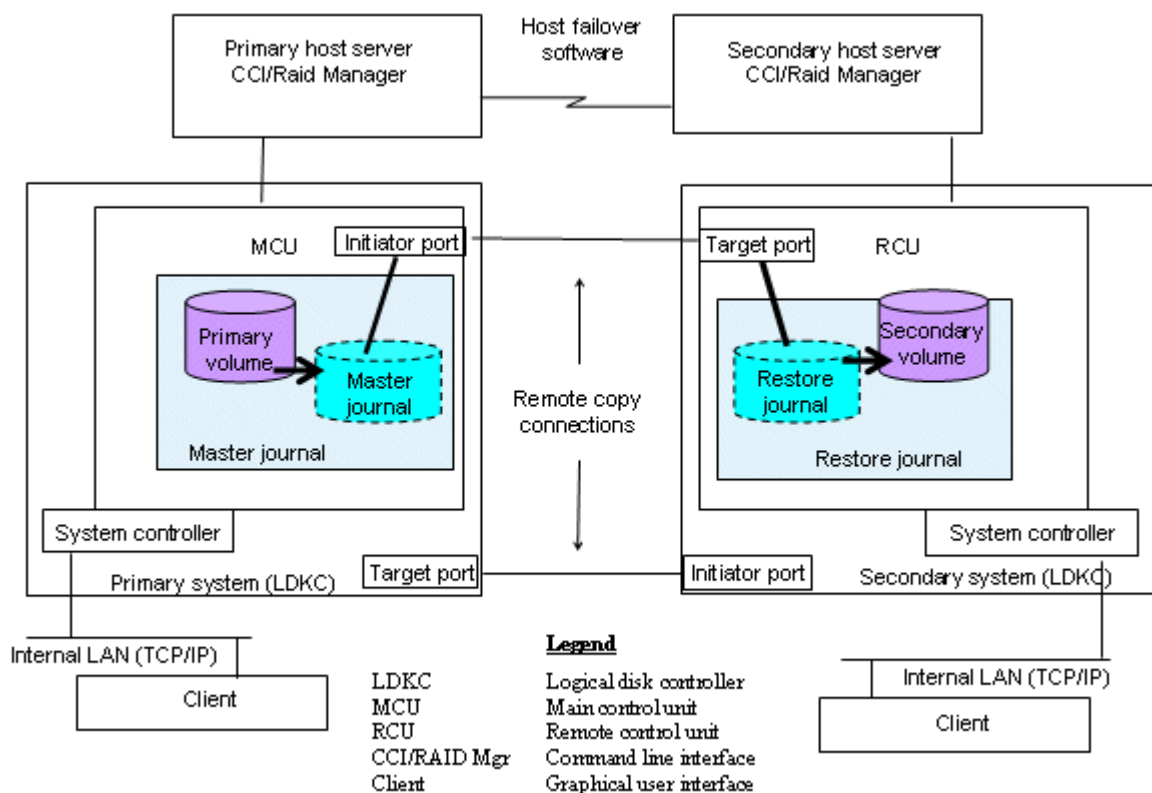

UR system components

- The storage systems at the primary and secondary sites. The primary storage system contains the P-VOLs and master journal volumes, and the secondary storage system contains the S-VOLs and restore journal volumes.
 - The master journal consists of the primary volumes and master journal volumes.
 - The restore journal consists of the secondary volumes and restore journal volumes.
- The data path connections between the systems. The primary and secondary storage systems are connected using dedicated Fibre Channel or iSCSI data paths. Data paths are routed from the ports on the primary storage system to the ports on the secondary storage system, and from the secondary storage system to the primary storage system.
- The UR software on both the primary storage system and the secondary storage system.
- The hosts connected to the primary and secondary storage systems. The hosts are connected to the storage systems using Fibre Channel, Fibre Channel-over-Ethernet (FCoE), or iSCSI target ports.
- The interface tools for configuring and performing UR operations:
 - Device Manager - Storage Navigator graphical user interface (GUI)
 - Command Control Interface (CCI)

Storage systems

Universal Replicator operations involve two storage systems. One of the systems is located at the primary site and one is located at the secondary site. The primary storage system consists of the main control unit and service processor (SVP). The secondary storage system consists of the remote control unit and its SVP.

- Each storage system can function simultaneously as a primary and secondary storage system.
- The primary storage system communicates with the secondary storage system over dedicated Fibre Channel remote copy connections.
- The primary storage system controls the P-VOL and the following operations:
 - Host I/Os to the P-VOL.
 - P-VOL data copy to the master journal.
- The secondary storage system controls the S-VOL and the following operations:
 - Initial copy and update copy between the P-VOL and the restore journal.
 - Journal commands to the primary storage system.
 - Journal data copy from the master journal to the restore journal.
 - Restore journal data copy to the S-VOL.
 - Pair status management and configuration (for example, rejecting write I/Os to the S-VOLs).

Pair volumes

The P-VOL contains the original data, and the S-VOL is the copy of the P-VOL. The two volumes can be paired, split, resynchronized, and released. When synchronized, the volumes are paired. When the pair volumes are split, updates to the P-VOL are not copied to the S-VOL. When the pair volumes are resynchronized, changed P-VOL data is copied to the S-VOL. If a disaster occurs, production operations can be transferred to the S-VOL. When the primary site is functional again, operations can be transferred and data can be copied back to the P-VOL.

The P-VOL remains available to the host for read and write I/O operations. The secondary storage system rejects write I/Os for the S-VOL by way of command rejection or intervention request, unless the S-VOL write option (Secondary Volume Write) is enabled. If the S-VOL write option is enabled, write I/O is allowed to the S-VOL while the pair is split, and the secondary storage system keeps track of differential data on the S-VOL for use when the pair is resynchronized.

Journal volumes

For Universal Replicator operations, journal volumes are required on the primary and secondary storage systems.

- Updates to the P-VOL are copied to the master journal volume in the primary storage system. See the illustration in [Journals on page 24](#).
- Master journal data is copied to the restore journal volume on the secondary storage system.
- Journal volumes can have different volume sizes and different RAID configurations.
- You can register two journal volumes in a journal in the primary storage system and in the secondary storage system, but the second journal volume becomes a reserve journal volume, which is not used for normal operations. Use one journal volume in each system.

The reserve journal volume is used for restoring a disk in a pool or pool volume to which the journal volume belongs. For details, see [Restoring a pair by adding a reserve journal volume on page 210](#).

For information on planning journal volumes, see [Sizing journal volumes on page 66](#).

Journals

Journals enable you to manage data consistency between multiple P-VOLs and S-VOLs. A journal is a group of one or more data volumes and the related journal volume. Like consistency groups, you can use journals to create multiple pairs and to split, resynchronize, and release multiple pairs. Journals are required on the primary and secondary storage systems.

Each data volume and its associated journal volume reside in the same journal.

- The master journal contains master journal volumes and is associated with the P-VOL.
- The restore journal contains restore journal volumes and is associated with the S-VOL

Each pair relationship between journals is called a mirror. A mirror ID identifies a pair relationship between journals. When the pair is created, it is assigned a mirror ID.

Mirror

The relationship of a master journal and a restore journal is called a mirror. A mirror is in Active status when it contains only pairs in COPY status (those not synchronized, with initial copy operation in progress) and pairs in PAIR status (those synchronized, with initial copy operation completed). Usually pairs are in PAIR status and thus mirrors are in Active status.

The mirror status changes when an operation is executed to a mirror. Be sure to check the mirror status to confirm that the operation is completed. The following are a few examples of the mirror statuses. For a complete list of mirror statuses, see [Device Manager - Storage Navigator mirror status definitions on page 202](#).

- **Initial:** Data volumes are not registered in the mirror, or deleting the mirror is completed.
- **Active:** The mirror has only pairs that are in COPY or PAIR status.
- **Stopped:** An operation for splitting or deleting the mirror is finished.



Tip: Universal Replicator assumes that pair operations are performed in units of mirrors. Be sure to perform pair split and resync operations for each mirror. Requests to perform a split or resync operation for each pair might be rejected.

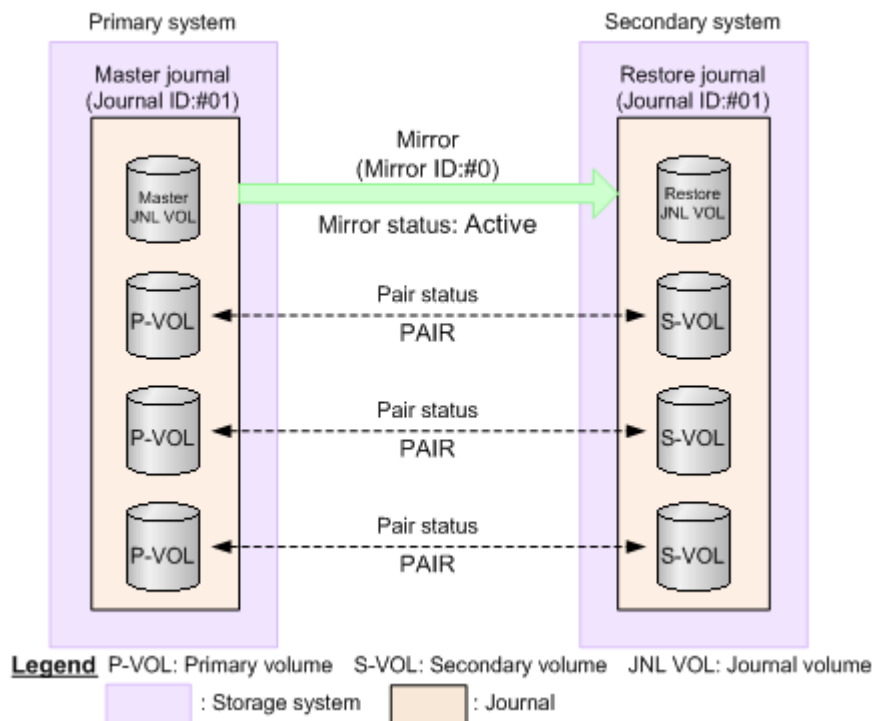

Split mirror operations

When you split a mirror, all the pairs in the mirror are split and copy operations of data from the master journal to the restore journal stops. To split a mirror, you must place the mirror in Active status. When mirror splitting is completed, the mirror status becomes Stopped.

Updated data is not reflected to the S-VOL while the pair is split, but only later when the pair is resynchronized. To resynchronize all the pairs in the mirror, resynchronize the mirror itself.

You can select whether or not to enable the S-VOL write option (Secondary Volume Write) when you split a mirror. If the Secondary Volume Write option is enabled, the host can write the data to the S-VOL while the pair is split.

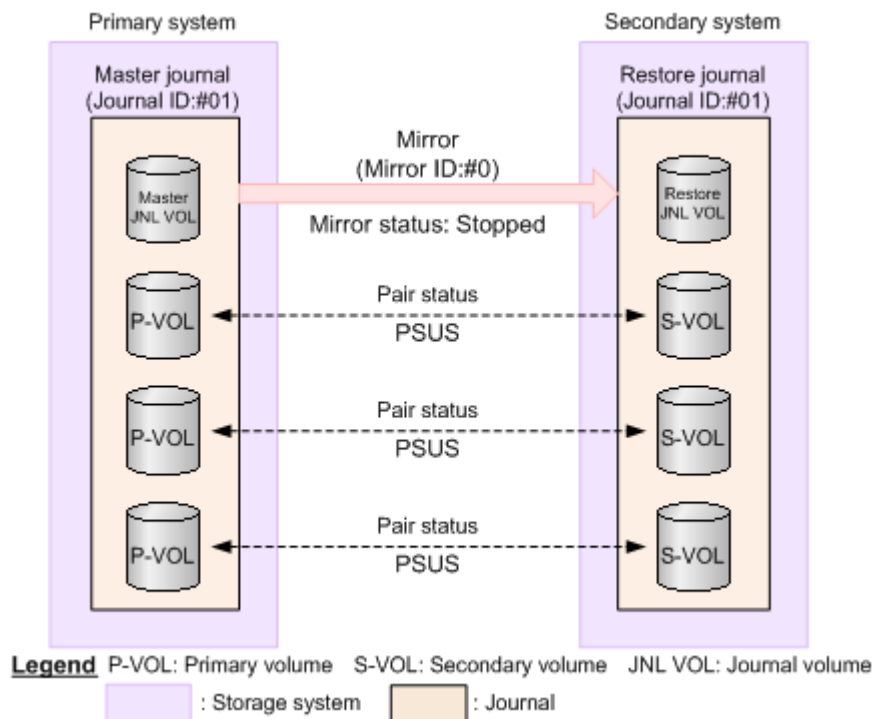

You can also split a mirror after synchronizing the P-VOL and S-VOL. In that case, select Flush in Split Mode. This allows you to reflect the updated data to the S-VOL when the pair is split. When the secondary storage system accepts the pair split, all the journal data that has been held for the pair is written to the S-VOL. If no journal data (update data) comes to the pair for a fixed period of time, the pair status changes to PSUS. When all pairs in the journal are placed in the PSUS status, volume copying is complete, and the mirror status becomes Stopped.



Tip: To create a complete copy of the data volumes in the mirror, you need to stop I/O operations from the host. Creating an instantaneous copy on demand and a copy created in such a way are called point-in-time copy.

Resync mirror operations

When you resynchronize a mirror, data copying from the P-VOL to S-VOL in all pairs in the mirror restarts. To resynchronize a mirror, make sure that the mirror status is Stopped.



Note: You should resynchronize mirrors while I/O load is low. This is especially important when different types of pairs are intermixed in the same consistency group. Performing a mirror resync operation on a consistency group with different pair types during high I/O load might result in a pair resync failure and pair suspension (PSUE status).

Delete mirror operations

When you delete a mirror, all the pairs in the mirror are deleted, and data copying from the master journal to the restore journal stops. Specify one of the following modes when deleting a mirror.

- Normal: The mirror is deleted only when the primary storage system can change the mirror status to Initial.
- Force: The mirror is forcibly deleted even when the primary storage system cannot communicate with the secondary storage system.

If the mirror status does not change to Initial after 5 or more minutes from when you start an operation to delete a mirror in Force mode, restart the delete operation in Force mode to ensure all pairs in the mirror are deleted.

After each delete operation in Force mode, wait at least five minutes before you create pairs in the same journal. Otherwise the paircreate operation might fail.

Data path

The physical transmission link between the primary and secondary storage systems is called the data path. Universal Replicator commands and data are transmitted through the Fibre Channel or iSCSI data path and switches. The data path is connected to the primary and secondary storage systems through two types of ports, Initiator ports and RCU Target ports. Universal Replicator requires paths in both directions. More specifically, it requires paths with Initiator ports in the primary storage system connected to RCU Target ports in the secondary storage system, and paths with Initiator Ports in the secondary storage system connected to RCU Target ports in the primary storage system.

One data path connection in each direction is required. It is recommended that you use two or more independent connections to provide hardware redundancy. A maximum of eight paths in each direction can be used.

For details, see [Planning the data path on page 97](#).

Consistency groups and journals

Journals are used in Universal Replicator to guarantee data consistency across multiple pairs. Consistency groups are used in other replication software for the same purpose. The journal group number is the consistency group ID used in BCM or CCI. The journal group number can be different in the primary and secondary storage systems.

For VSP Gx00 models and VSP Fx00 models, the number of consistency groups that can be created depends on the storage system model. Following is the maximum number of consistency groups that can be created for P-VOL's consistency group and S-VOL's consistency group combined:

- VSP G800, VSP F800: 128 (0-127)
- VSP G400, VSP F400, VSP G600, VSP F600: 64 (0-63)
- VSP G200: 16 (0-15)

Device Manager - Storage Navigator

Device Manager - Storage Navigator provides a GUI and command line interface for accessing and managing the storage system, including Universal Replicator.

Device Manager - Storage Navigator communicates with the SVP of each system over defined TCP/IP connections.



Note: About "Local Storage System" and "Remote Storage System" on the GUI:

The Device Manager - Storage Navigator GUI displays "Local Storage System" for the storage system that you have accessed on the HDvM - SN server and "Remote Storage System" for storage systems that are connected to the storage system you accessed. Therefore, when you access a secondary storage system (contains S-VOLs) at a secondary site, the information for this secondary storage system is displayed under "Local Storage System", and the information for the primary storage system connected to this secondary storage system is displayed under "Remote Storage System".

Command Control Interface (CCI)

CCI provides a command line interface for accessing and managing the storage system, including Universal Replicator. You can perform the same Universal Replicator operations with CCI as you can with Device Manager - Storage Navigator. In addition, you can automate pair operations using scripts.

Copy operations

The copy operations for Universal Replicator include initial copy, update copy, and the underlying operations that are executed, such as journal processing and differential data management.

Initial copy operation

When the initial copy operation is executed, all data in the P-VOL is copied in sequence directly to the S-VOL without use of the primary journal volumes. The copied data in the initial copy operation is referred to as base journal data, even though the primary journal volumes are not used.

- When you create or resynchronize two or more pairs within the same journal, the base journal data is copied to the respective S-VOLs, one at a

time. This extends the time required for all the operations to be completed.

- As an option, you can create a pair and specify that no data is copied during the initial copy operation. This option should be specified only when the data in the P-VOL and S-VOL is already identical, or when the P-VOL and S-VOL do not yet contain any data. Use of this option establishes the pair quickly without the delay of the initial copy operation. Once the pair is established (pair status is PAIR), update copy operations are performed to copy all P-VOL updates to the S-VOL.
- A Universal Replicator pair can also be created using a TrueCopy initial copy operation. This reduces the time to complete the initial copy operation. For details, see [Planning pair volumes on page 69](#).

Update copy operation

When a host performs a write I/O operation to a P-VOL of a volume pair, an update copy operation is performed. The updated data is copied to the master journal on the primary storage system along with metadata that includes sequence and other consistency information. The updated data and its metadata are called the journal data. When the secondary storage system issues the read-journal command, which occurs independently of host I/O activity, all journal data in the master journal is sent to the restore journal on the secondary storage system. When the P-VOL updates are successfully duplicated on the S-VOL, the journal data on the primary and secondary storage systems is discarded.

Journal data is transferred using special I/O operations called RIO (remote I/O) that are initiated by the secondary storage system. RIO provides the most efficient type of data transfer. The channel extenders must be capable of supporting RIO.

If an update copy operation fails, the secondary storage system suspends the affected pair or all pairs in the journal, depending on the type of failure. The suspended pair or journal returns to Paired status when the primary and secondary storage systems are resynchronized.



Note: If the primary storage system receives a request for writing to the P-VOL (update I/O) from a host during initial copy, the primary storage system suppresses initial copy to prioritize the update I/O. However, when a copy pace for mirror option is "Faster", the primary storage system does not suppress initial copy. When specifying "Faster" for a copy pace, be sure not to cause an update I/O during initial copy. If an update I/O occurs, data volume pairs might be split (suspended).

Read and write I/O during remote copy

The primary storage system reads from the P-VOL when it receives a read I/O command. If the read fails, the redundancy provided by RAID 1, RAID 5,

or RAID 6 technology recovers the failure. The primary storage system does not read the S-VOL for recovery.

When a primary storage system receives a write I/O command for a P-VOL in PAIR status, the system performs the write operation and performs the update copy operation. The write operation completes independently of the update copy operations on the S-VOL.

The secondary storage system updates the S-VOL according to the write sequence number in the journal data. This maintains data consistency between P-VOL and S-VOL.

If the P-VOL write operation fails, the primary storage system reports a unit check and does not create the journal data for this operation. As mentioned, if the update copy operation fails, the secondary storage system suspends either the affected pair or all Universal Replicator pairs in the journal, depending on the type of failure. When the suspended pair or journal is resynchronized, the primary and secondary storage systems negotiate the resynchronization of the pairs.

During normal operations, the secondary storage system does not allow S-VOLs to be online (mounted). Therefore, hosts cannot read or write to S-VOLs. However, if you enable the S-VOL write option (Secondary Volume Write) when you split a pair, write access to the S-VOL is allowed while the pair is split. The S-VOL write option can be enabled only when you split the pair from the primary storage system.

To reduce the overhead associated with remote copy activities and to maximize rate of data transfer, the storage system uses a special write command for initial and update copy operations. This command transfers the control parameters and the fixed-block architecture (FBA) format data for consecutive updated records in a track using a single write operation. It eliminates the overhead required for performing FBA-to-count-key-data (CKD) and CKD-to-FBA conversions.

Differential data management

Differential data is the data that is changed in the P-VOL and S-VOL (if permitted) while a pair is split or suspended. This changed data is stored in a track bitmap and has not been written to the S-VOL. When the pair is resynchronized, the primary storage system merges the P-VOL and S-VOL bitmaps and copies the differential data to the S-VOL.

The required number of bitmap areas is based on the number of volumes being replicated and the size of the volumes. This affects the maximum number of pairs that can be created in the system.

When you use a DP-VOL in a pair under one of the following conditions, the differential data is managed by the pool to which the UR pair volume is related:

- You create a UR pair by using a DP-VOL that is larger than 4,194,304 MB (8,589,934,592 blocks). In this case, additional pool capacity (up to 4 pages, depending on the software configuration) is required for each increase of user data size by 4 TB (4,123,168,604,160 bytes).
- You create a UR pair by using a DP-VOL of any size with system option mode (SOM) 1050 enabled on VSP G1000, VSP G1500, and VSP F1500 storage systems or with Advanced System Setting No. 5 or No. 6 enabled on VSP G200, G400, G600, G800 storage systems.
- You resynchronize a UR pair that contains a DP-VOL of any size with SOMs 1050 and 1058 enabled or with Advanced System Settings No. 5 and No. 6 enabled on VSP G200, G400, G600, G800 storage systems.

SOM 1050/Advanced System Setting No. 6: Manage differential bitmaps in DP pool at pair create for 4 TB or less TC/UR/GAD pairs.

SOM 1058/Advanced System Setting No. 5: When SOM 1050/Advanced System Setting No. 6 is enabled, manage differential bitmaps in DP pool at both pair create and pair resync for 4 TB or less TC/UR/GAD pairs.

When these SOMs are enabled, the differential data is managed by the pool to which the pair volume is related even if the volume is smaller than 4 TB. This enables the total capacity of the pair volumes to be increased over 1.8 PB. If you want the differential data to be managed by the shared memory again after you create pairs whose total capacity is larger than 1.8 PB, you must reduce the total capacity of the pairs that are smaller than 4 TB to 1.8 PB by deleting some pairs. When the differential data is managed by the shared memory, the maximum total capacity of all remote copy pairs (including TC/TCz, UR/URz, and GAD) is 1.8 PB. For example, if the total capacity of the UR pairs is already 1.8 PB, you cannot create any TC pairs.



Note: After you create a pair whose differential data is managed in a pool, data management might fail due to insufficient pool capacity. In this case, all of the P-VOL data is copied to the S-VOL in units of tracks when the pair is resynchronized.

S-VOL write option

When splitting a pair, you can set the S-VOL write option (Secondary Volume Write) to allow write I/O to the S-VOL. The S-VOL write option can be specified only when you are connected to the primary storage system, and it applies only to the specified pairs. When you resynchronize a split pair whose S-VOL is write-enabled, the secondary storage system sends the S-VOL track bitmap to the primary storage system, which merges the P-VOL and S-VOL bitmaps to determine the tracks that need to be updated. This ensures proper resynchronization of the pair based on the P-VOL data.

Pair status

The pair status of a volume indicates the synchronization status of the pair to which it belongs. When a pair operation is performed, the pair status of the volumes changes. The pair status of a volume determines the operations that can be performed on the pair. For example, you can only split a pair when the pair status of the volumes is COPY or PAIR.

During normal operations you need to monitor the pair status to ensure that you can perform the desired operations and to verify that operations completed successfully.





Related references





- [Pair status definitions](#) on page 33

Pair status definitions

Device Manager - Storage Navigator displays both the Device Manager - Storage Navigator pair status name and the CCI pair status name, except when the names are the same. When they are the same, the CCI status is not displayed.

The following table lists and describes the pair status names.

HDvM - SN status	CCI status	Description	P-VOL access	S-VOL access
(Unpaired-no HDvM - SN status)	SMPL	The volume is not assigned to a pair and is not in a journal.	Read/Write	Read/Write
 COPY	COPY	The initial copy operation is in progress.	Read/Write	Read Only
 PAIR	PAIR	The pair is synchronized. Updates to the P-VOL are duplicated on the S-VOL.	Read/Write	Read Only
HDvM - SN displays this status as  PAIR	PFUL	If data in the journal volume exceeds the threshold (80 %), pair status changes to PFUL. The pair is not suspended; the copy operation continues. If the journal option, Inflow Control, is set to Enable when status changes to PFUL, host I/O is delayed because update I/O to the journal volume is delayed.	Read/Write	Read Only
 PSUS	PSUS SSUS	The pair has been split by the user and the P-VOL and S-VOL are no longer synchronized. <ul style="list-style-type: none"> • The primary and secondary storage systems keep track of journal data discarded during the split operation. • When the operation is performed on the primary storage system, the status of both the P-VOL and S-VOL changes to PSUS. 	Read/Write	Read Only, but if you enable the Secondary Volume Write option then split the pair from the primary site, it

HDvM - SN status	CCI status	Description	P-VOL access	S-VOL access
		<ul style="list-style-type: none"> When the operation is performed on the secondary storage system, the status of the S-VOL changes to PSUS, and the primary storage system detects this and changes the P-VOL status to PSUS. <p>SSUS is the S-VOL's split status name.</p> <p>See also UR PSUS types and behaviors on page 37.</p>		is Read/Write (Default is Disable).
 PSUE	PSUE	<p>The pair is suspended by the system due to an error; it is not synchronized.</p> <ul style="list-style-type: none"> The primary and secondary storage systems keep track of journal data discarded during the suspension operation. The primary storage system keeps track of P-VOL tracks that are updated while the pair is suspended. When a UR suspension condition is detected, the primary storage system changes the P-VOL and S-VOL status to PSUE. If the secondary storage system detects the condition, it changes the S-VOL status to PSUE, and the primary storage system detects this and changes the P-VOL status to PSUE. <p>See also UR PSUS types and behaviors on page 37.</p>	HDvM - SN: Read/Write CCI: Read/Write if no error in P-VOL	Read Only
 Suspending	(No equivalent CCI status)	The pair is not synchronized and in transition from the PAIR or COPY status to PSUS or PSUE status.	Read/Write	Read Only
 Deleting	(No equivalent CCI status)	The pair relationship is being deleted. When the operation is complete, the status changes to unpaired.	Read/Write	Read Only
 HOLD	(No equivalent CCI status)	<ul style="list-style-type: none"> When used with TC, this status indicates that the creation of a delta resync pair is completed. Delta resync might not be executed depending on the internal process status even if the creation of the delta resync pair is completed. When used with GAD, this status indicates that delta resync can be executed. If the P-VOL status is HOLD, the updated data of the TC or GAD S-VOL is stored in the master journal volume. Operations allowed: <ul style="list-style-type: none"> Delta resync Pair-delete Change pair options 	Read/Write ¹	Read/Write ²
 HOLDING 3	(No equivalent CCI status)	<p>When used with TC, this status indicates that the pair status is changing to HOLD so that the delta resync pair can be created.</p> <p>Operations allowed on pairs in HOLDING status:</p> <ul style="list-style-type: none"> Delta resync operation 	Read/Write ¹	-

HDvM - SN status	CCI status	Description	P-VOL access	S-VOL access
		<ul style="list-style-type: none"> • Pair release • Change pair options <p>If the delta resync operation is run on a pair in HOLDING status, the operation could fail. If you specify Entire Copy for the Delta Resync Failure option (Change Journal Option dialog box), differential data is copied to an S-VOL.</p> <p>When used with GAD, preparing for delta resync. Delta resync execution will fail if the pair status is HOLDING. Specification of Entire Copy is invalid for the Delta Resync Failure option. Resync the UR pair in case of delta resync failure.</p>		
 HLDE	(No equivalent CCI status)	<ul style="list-style-type: none"> • An error occurred on a pair in HOLD status. • When P-VOL status is HLDE, incoming write data for the TC or GAD S-VOL is not stored in the master journal volume. • Operations allowed on pairs in HLDE status: <ul style="list-style-type: none"> - Recover pair status to standby (HOLD) - Pair delete - Change pair options 	Read/Write ¹	-
(No equivalent HDvM - SN status)	PFUS	<p>This status results when the journal volume becomes full and suspends. Pair status changes from COPY, PAIR or PFUL to PFUS. The UR pair is suspended and the copy operation stops. Make sure to review configuration of the remote path and journal volume.</p> <ul style="list-style-type: none"> • If a Dynamic Provisioning virtual volume (DP-VOL) is used as the UR S-VOL, and the capacity of a pool-VOL is nearly full, UR status becomes PFUS and the pair is suspended. • If the journal option Inflow Control is set to Yes when status changes to PFUS, the pair is not suspended for the time set in the Data Overflow Watch field, even when the journal volume becomes full. During the time it takes for the journal data area to clear, the response to host I/O is delayed. See Changing options used by journals on page 211 for details about Data Overflow Watch. 	Read /Write	Read Only, unless the write option is enabled.
(No equivalent HDvM - SN status)	SSWS	<p>After Takeover, SSWS is the status of the S-VOL. With this status, data can be written to the S-VOL.</p> <p>The copy flow between P-VOL and S-VOL is reversed by running the CCI horctakeover command or pairsplit -RS. Therefore, the S-VOL is ready for host write operations. During disaster recovery, the host can write data to the S-VOL in SSWS status at the intermediate site or secondary site. However, in a 3DC</p>	Read Only	Read/Write

HDvM - SN status	CCI status	Description	P-VOL access	S-VOL access
		configuration in which three UR sites are combined, the host cannot write data to the S-VOL if the volume is shared by the mirror that includes the UR delta resync pair.		
<p>Notes:</p> <ol style="list-style-type: none"> 1. Access to the P-VOL depends on the status of the TC or GAD pair that shares the volume. 2. The UR S-VOL in HOLD status uses two mirrors. In a 3DC configuration combined with TrueCopy, accessing the S-VOL depends on the status of the mirror that is not HOLD. In a 3DC configuration in which three UR sites are combined, the host cannot write data to the S-VOL regardless of the mirror status. 3. HOLDING indicates either that differential data used for a delta resync operation does not exist or that the system cannot judge whether the delta resync can be performed without the differential data. When differential data does not exist in the secondary TC or GAD site, even after the S-VOL is updated, the differential data might be discarded due to the one of the following reasons: <ul style="list-style-type: none"> • The cache or shared memory was added to or removed from the system during maintenance work. • The system was powered off during maintenance work. • The UR or TCUR, TC, or GAD pair was suspended and then resynchronized. <p>After the system is back to normal, differential data is stored again in the TC S-VOL if you update the data in the primary site.</p> <p>The delta resync operation can be executed without differential data if the primary site has not received a data update or if data in the TC or GAD S-VOL and the UR S-VOL is the same.</p> <p>Even if the delta resync operation without differential data is executable, the pair status changes to HOLD even when the differential data exists if the conditions for discarding the differential data are satisfied. To change the status of the pair to HOLD, update the data in the primary storage system after the recovery from the condition of the differential data discarding.</p> <p>If you cannot connect to the secondary site of TC or GAD due to failures or disasters, the transition from HOLDING to HOLD is not performed correctly. When used with GAD, keep updating I/O from the server to GAD P-VOL or S-VOL for about two minutes.</p> 				

Additional information on pair status

- When a pair is split by the user or suspended by the system, the primary storage system notifies the hosts by issuing a service information message (SIM). If SNMP is installed and operational, this SIM results in an SNMP trap indicating the reason for suspension.
- Transitional states occur when a request is accepted to change the pair status to PSUS, PSUE, or to delete the pair, but the operation is not yet complete. Transitional states are not reported to the host.
- The user or the primary or secondary storage system can initiate the PSUS/PSUE status change.
- Only the user can delete a pair.
- When you perform an operation, the system reports the final status at the end of the operation.
- If an error causes the status to change to PSUE, the status is reported at the beginning of the transition.
- A pair in Flush mode (remaining primary update data is flushing to the secondary storage system) remains in Suspending or Deleting status until the data in the master and restore journals is the same and the pair is completely split or released. To calculate the time during which the pair remains in the Suspending or Deleting status, use the following equation:

$C \times (u / 100) \times 1,024 / V$ (The unit is seconds)

where:

- C is the total capacity (GB) of the master journal volume.
- u is the usage rate of data (%) in the master journal volume.
- V is the data transfer speed (MB/sec) between the primary and the secondary storage systems.

UR PSUS types and behaviors

The PSUS status, which indicates that a pair is split or suspended, can be set by the user or by the system from the primary or secondary storage system. The following table lists and describes the PSUS status types.

PSUS type	Applies to	Description
S-VOL by Operator	P-VOL, S-VOL	<ul style="list-style-type: none"> • The user split the pair from the primary or secondary storage system using the S-VOL-write option. • CCI displays this PSUS type as SSWS.
By MCU	S-VOL	<ul style="list-style-type: none"> • The secondary storage system received a request from the primary storage system to split the pair. • The P-VOL PSUS type is S-VOL by Operator. • CCI displays this PSUS type as SSWS.
By RCU	P-VOL, S-VOL	<ul style="list-style-type: none"> • The primary storage system suspended the pair after detecting an error condition on the secondary storage system. • The S-VOL suspend type is S-VOL Failure. • CCI displays this suspend type as PSUE.
Pairsplit-S to RCU	P-VOL	<ul style="list-style-type: none"> • The primary storage system detected that the S-VOL is unpaired after the user released the pair from the secondary storage system. • The pair cannot be resynchronized.
JNL Cache Overflow	P-VOL, S-VOL	<ul style="list-style-type: none"> • The pair was suspended because the journal volume was near capacity. • CCI displays this PSUS type as SSWS.

- A pair can be split after the initial copy is complete.
- A pair must be split to perform maintenance on the P-VOL, or to enable write-access to the S-VOL.
- After the status changes to PSUS, the primary storage system performs the following tasks:
 - Stops journal-obtain operations
 - Continues to accept write I/Os from hosts to the P-VOL
 - Keeps track of the updated P-VOL tracks
- When the UR pair is split by the user, the primary storage system and secondary storage system will either execute suspended update copy, synchronize the pair then split or delete suspended update copy then split the pair based on the user specified Split Mode option (Flush or Purge). The journal data that is deleted during UR pair split is stored in the primary and secondary storage systems. When the pair status becomes

PSUS, the primary storage system will stop obtaining the journal for the pair and accept write I/O for split UR P-VOL and record the updated P-VOL track during pair split.

- If you enable the S-VOL write option (Secondary Volume Write) when splitting the pair, the secondary storage system keeps track of updated S-VOL tracks. When the pair is resynchronized, the secondary storage system sends the S-VOL track bitmap to the primary storage system, which then merges P-VOL and S-VOL bitmaps to synchronize the tracks.
- A split or suspended S-VOL has a separate consistency status, which indicates the S-VOL's update sequence consistency with respect to the other S-VOLs in the associated journal. The consistency status is displayed only on the secondary storage system. The following table lists and describes the S-VOL consistency statuses.

Table 1 S-VOL consistency statuses

Consistency status	Description
Volume	<ul style="list-style-type: none"> • Only the current pair was split or suspended. • Update sequence consistency between this S-VOL and other S-VOLs in the associated journal is not ensured. • This S-VOL cannot be used for disaster recovery at the secondary site. • This status is indicated when: <ul style="list-style-type: none"> ○ The pair is split by the user using the Split Pairs window (Suspend Range-Volume (LU) pairsplit option). ○ The pair is suspended due to a failure that did not affect the entire journal.
Mirror	<ul style="list-style-type: none"> • The pair was split or suspended along with the other pairs in the associated mirror. • Update sequence consistency between this S-VOL and other S-VOLs in this mirror is ensured. • This S-VOL can be used for disaster recovery on the secondary storage system. • This status is indicated when: <ul style="list-style-type: none"> ○ The mirror is split using the Split Mirrors window (or by specifying mirror of the CCI pairsplit -r option). ○ All pairs in the associated mirror are suspended due to a failure that affected the entire group, for example, path failure. ○ One pair in the mirror was suspended due to a failure that did not affect the entire group.

UR PSUE types and behaviors

The PSUE status, which indicates that a pair is suspended, can be set only by the primary or secondary storage system. The primary storage system suspends a pair and changes its status to PSUE when it detects any of the following conditions:

- The user has released the pair on the secondary storage system.
- An error condition related to the S-VOL or an update copy operation.
- The primary storage system is not able to communicate with the secondary storage system.
- A Universal Replicator suspension condition is detected by the system.

The following table lists and describes the PSUE status types.

PSUE Type	Applies to	Description
S-VOL Failure	P-VOL, S-VOL	The primary storage system detected an error during communication with the secondary storage system or during update copying. S-VOL PSUE type is usually PSUE-S-VOL Failure. CCI might display this status as SSWS.
MCU IMPL	P-VOL, S-VOL	The primary storage system could not find valid control information in its nonvolatile memory during IMPL (initial microprogram load). This condition occurs if the primary storage system is without power for more than 48 hours (power failure and fully discharged backup batteries).
Initial Copy Failed	P-VOL, S-VOL	The pair was suspended before the initial copy operation was complete. The data on the S-VOL is not identical to the data on the P-VOL. CCI might display this status as SSWS.
MCU P/S OFF	S-VOL	The primary storage system is powered off. CCI displays this as SSUS.

When a pair is suspended, the primary storage system stops performing journal-obtain operations for the pair. However, the primary storage system continues the following operations:

- Continues accepting write I/Os for the suspended P-VOL
- Keeps track of the P-VOL cylinders/tracks that are updated
- Keeps track of journal data discarded during the pair suspension. (Both primary and secondary storage systems do this.)

A split or suspended S-VOL has a separate consistency status that indicates its update sequence consistency with respect to the other S-VOLs in the associated journal. Consistency status displays on the secondary storage system only. [Table 1 S-VOL consistency statuses on page 38](#) describes S-VOL consistency statuses.

When the pair is resynchronized, the primary and secondary storage systems perform the following operations:

- The secondary storage system sends the S-VOL bitmap to the primary storage system
- The primary storage system merges the P-VOL and S-VOL bitmaps to synchronize the tracks

These actions ensure that all cylinders/tracks containing journal data discarded on the secondary storage system are resynchronized.

3DC configurations with three UR sites

You create a 3DC multi-target or 3DC cascade configuration by combining three Universal Replicator sites. A 3DC multi-target configuration involves one primary site and two secondary sites. A 3DC cascade configuration involves a primary site, an intermediate site, and a secondary site.

3DC multi-target configuration with three UR sites

With Universal Replicator, you can set up two secondary sites for one primary site. It is advisable that you create a UR pair that connects the two secondary sites so that the remote copy system created with the host operation site and backup site can be created immediately in the event of a failure or disaster at the primary site. A UR pair that is created to make a triangle-shaped remote copy connection among the three sites is called a UR delta resync pair. By creating a UR delta resync pair in advance, you can transfer the copying operations from between the secondary sites back to from the primary to the secondary site in a short time when the failure is corrected and the primary site is brought back online.

The following illustration shows the 3DC multi-target configuration with three UR sites:

- UR primary site
- UR secondary site (copies data with a mirror whose ID is an arbitrary number (M in the illustration) from the primary site). Data can be copied with a mirror whose ID is an arbitrary number (P in the illustration) from another secondary site.
- UR secondary site (copies data with a mirror whose ID is an arbitrary number (N in the illustration) from the primary site). Data can be copied with a mirror whose ID is an arbitrary number (P in the illustration) from another secondary site.

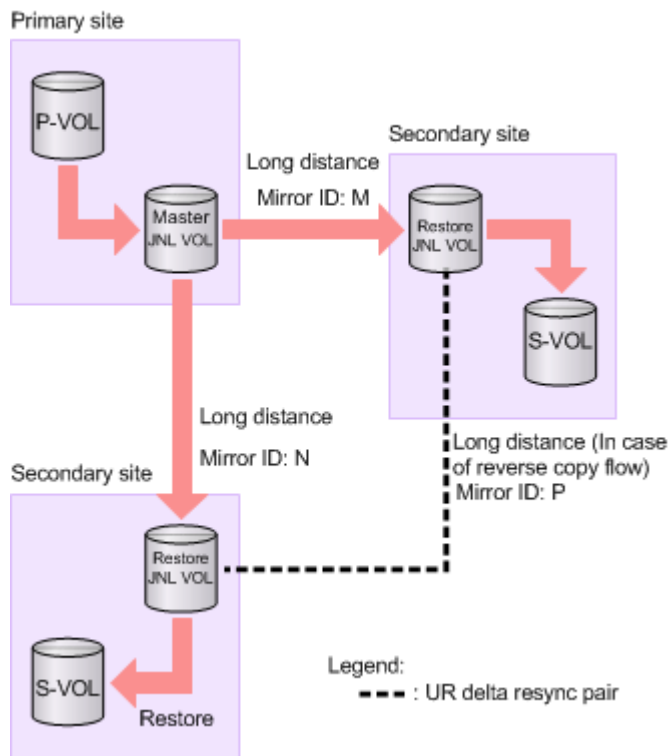

Note: In a 3DC multi-target configuration using delta resync with three UR sites, both the P-VOL and S-VOL of a delta-resync pair are displayed as secondary volumes in the Remote Replication window (Pair Position column).

3DC cascade configuration with three UR sites

With Universal Replicator, you can set up one intermediate site and one secondary site for one primary site. It is advisable that you create a UR pair that connects the primary and secondary sites so that the remote copying system that is created with the host operation site and backup site is configured immediately in the event of a failure or disaster at the intermediate site. A UR pair that is created to make a triangle-shaped remote copy connection among the three sites is called UR delta resync pair. By creating a UR delta resync pair in advance, you can transfer the copying operations from between the primary and secondary sites back to between the intermediate and secondary sites in a short time when the intermediate site failure is corrected and the intermediate site is brought back online.

The following illustration shows the 3DC cascade configuration with three UR sites:

- UR primary site (copies data with a mirror whose ID is an arbitrary number (M in the illustration) to the intermediate site). Data can be copied with a mirror whose ID is an arbitrary number (P in the illustration) to the secondary site.

- UR intermediate site (copies data with a mirror whose ID is an arbitrary number (M in the illustration) from the primary site and copies data with a mirror whose ID is an arbitrary number (N in the illustration) to the secondary site). Data can be copied with a mirror whose ID is an arbitrary number (P in the illustration) from the primary site.
- UR secondary site (copies data with a mirror whose ID is an arbitrary number (N in the illustration) from the intermediate site). Data can be copied with a mirror whose ID is an arbitrary number (P in the illustration) from the primary site.

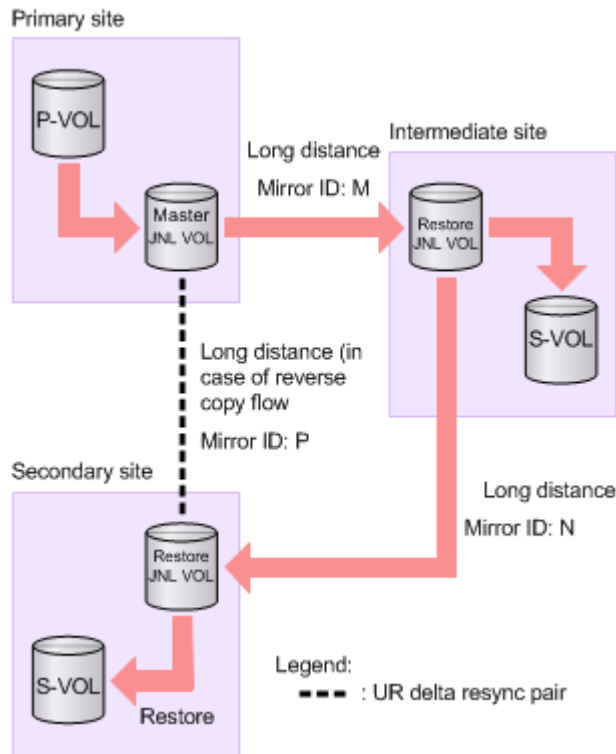

Requirements and specifications

This chapter provides system requirements for Hitachi Universal Replicator.

- [System requirements](#)
- [Interoperability requirements](#)

System requirements

The following table lists the system requirements for UR operations.

Item	Requirement
Supported storage systems (VSP G1000, G1500, and VSP F1500)	<p>VSP G1000, VSP G1500, and VSP F1500 can be paired with the following:</p> <ul style="list-style-type: none"> • VSP G1000 (80-01-01-00/00 or later) • VSP G1500, and VSP F1500 (80-05-0x-00/00 or later) • VSP (70-06-16-00/00 or later) • USP V/VM (60-08-47-00/00 or later) • VSP G200: 83-01-21-20/xx or later • VSP G400, G600, VSP F400, F600: 83-01-21-40/xx or later • VSP G800, VSP F800: 83-01-21-60/xx or later • HUS VM (73-03-07-00/00 or later) <p>If you are using a Dynamic Provisioning virtual volume (DP-VOL) with the Data Direct Mapping attribute, you can only connect to VSP G1000, VSP G1500, and VSP F1500 with microcode 80-03-30-00/00 or later.</p>
Supported storage systems (VSP Gx00 models and VSP Fx00 models)	<p>Microcode requirements for connecting VSP Gx00 models or VSP Fx00 models to VSP Gx00 models or VSP Fx00 models:</p> <ul style="list-style-type: none"> • VSP G200: 83-01-01-20/00 or later • VSP G400, G600: 83-01-01-40/00 or later • VSP G800: 83-01-21-60/00 or later • VSP F400, F600, F800: 83-02-0x or later <p>Microcode requirements for connecting VSP Gx00 models or VSP Fx00 models to Hitachi Unified Storage VM (>):</p> <ul style="list-style-type: none"> • VSP G200: 83-01-21-20/00 or later • VSP G400, G600: 83-01-21-40/00 or later • VSP G800: 83-01-21-60/00 or later • VSP F400, F600, F800: 83-02-0x or later • HUS VM: 73-03-39-x0/00 or later, x = 0 or 1 <p>If you are using a Dynamic Provisioning virtual volume (DP-VOL) with the data direct mapping attribute, you can only connect to VSP Gx00 models or VSP Fx00 models with microcode 83-02-0x or later.</p> <p>Microcode requirements for connecting VSP Gx00 models or VSP Fx00 models to VSP G1000, G1500, and VSP F1500:</p> <ul style="list-style-type: none"> • VSP G200: 83-01-21-20/00 or later • VSP G400, G600: 83-01-21-40/00 or later • VSP G800: 83-01-21-60/00 or later • VSP F400, F600, F800: 83-02-0x or later • VSP G1000: 80-04-xx or later • VSP G1500 and VSP F1500: 80-05-0x-00/00 or later <p>For more information, contact customer support.</p>
Number of storage systems (VSP G1000, G1500, and VSP F1500)	<p>A maximum of 64 units can be connected to one unit storage system. For example, you can make a configuration of one unit storage system for the primary site and 64 units storage system for the secondary site.</p>

Item	Requirement
Number of storage systems (VSP Gx00 models and VSP Fx00 models)	<p>The maximum number of storage systems that can be connected to one unit storage system depends on the models</p> <ul style="list-style-type: none"> • VSP G200: A maximum of 16 units can be connected. For example, you can configure one unit storage system for the primary site and 16 units storage system for the secondary site. • VSP G400, G600, G800 or VSP F400, F600, F800: A maximum of 64 units can be connected to one unit storage system. For example, you can make a configuration of one unit storage system for the primary site and 64 units storage system for the secondary site.
Universal Replicator	<ul style="list-style-type: none"> • Must be installed on the primary and secondary storage systems. • License keys required. • UR and URz can coexist in the same storage system. • For licensing capacity requirements when UR volumes are shared with other software products, see Dynamic Provisioning on page 53 • For information on expired licenses or exceeding licensed capacity, see the <i>System Administrator Guide</i>.
Other licenses required	<ul style="list-style-type: none"> • TrueCopy is required, whether or not TC volumes are shared with UR. • Disaster Recovery Extended. Used for 3DC configurations and UR operations in multiple primary and secondary storage systems. • (VSP Gx00 models and VSP Fx00 models) Remote Replication Extended is required for 3DC configurations. • Dynamic Provisioning. DP-VOLs are required for journal volumes.
Interfaces	<ul style="list-style-type: none"> • Device Manager - Storage Navigator: <ul style="list-style-type: none"> ○ Must be LAN-attached to the primary storage system. ○ Not required on the secondary storage system, but recommended in order to change UR parameters and access the S-VOL for disaster recovery and maintenance. ○ The following roles are required: <ul style="list-style-type: none"> Storage Administrator (Remote Backup Management), to perform pair operations Storage Administrator (System Resource Management), to configure settings • CCI: <ul style="list-style-type: none"> ○ Optional ○ Command device required ○ (VSP G1000, G1500, and VSP F1500) When using virtual storage machine volumes, specify the LDEV ID, serial number, and virtual information in the configuration definition file.
Supported host platforms	<ul style="list-style-type: none"> • AIX • HP-UX • OpenVMS • Red Hat Enterprise Linux • Solaris • SuSE Linux • VMWare ESX • Windows Server <p>For the supported version, refer to the Hitachi Data Systems interoperability matrix at http://support.hds.com/en_us/interoperability.</p>

Item	Requirement
Data path	<p>The following interfaces with direct, switch, or channel extenders are available:</p> <ul style="list-style-type: none"> • Fibre channel • iSCSI <p>For details, see Supported data path configurations on page 105.</p> <p>When both systems are the same model, you can use multiple path groups. This is done by registering path groups with multiple path group IDs in the same storage system. But note that only one path group can be specified for a mirror. Up to eight paths can be registered in one path group.</p>
Path group	<p>Groups of remote paths, which allows you to configure or change the configuration of multiple paths at the same time.</p> <ul style="list-style-type: none"> • A maximum of eight remote paths can be registered in a path group. • A maximum of 64 path groups can be set in a storage system. • The range of values for the path group ID is 0-255. • Two path group IDs can be set in a port. • All remote paths in a path group must be the same protocol, either Fibre Channel or iSCSI. Remote paths for Fibre Channel and iSCSI cannot coexist within the same path group. • If iSCSI is used in a remote path, the Blocked Path Monitoring remote replica option must be set to at least 40 seconds (default). If Blocked Path Monitoring is less than 40 seconds, the path might be blocked due to a delay in the network such as many switches in a spanning tree protocol (STP) network or a long distance connection. • For a mirror, the path group ID that is used to connect the primary storage system to the secondary storage system must also be used to connect the systems in the reverse direction. • The path group is specified during the create pair operation. It cannot be changed by resynchronization or the swap operation. • Path groups can be created and specified using CCI. See configuration setting commands in <i>Command Control Interface User and Reference Guide</i> and sample configuration definition files in <i>Command Control Interface Installation and Configuration Guide</i>. • Specify different paths and path groups for TC and UR secondary storage systems when using CU Free.
Pair volumes	<ul style="list-style-type: none"> • A P-VOL can be copied to only one S-VOL. • The P-VOL and S-VOL must be equal in size. • The P-VOL and S-VOL must be the same emulation type. • Supported emulation type: OPEN-V • The maximum size of the P-VOL and S-VOL is: <ul style="list-style-type: none"> ○ Internal volume: 3,145,663 MB (6,442,317,824 blocks) ○ External volume: 4,194,304 MB (8,589,934,592 blocks) ○ DP-VOL: Same as the maximum size of the DP-VOL. For details, see the <i>Provisioning Guide</i> for your storage system. • The minimum volume size of the P-VOL and S-VOL is 46.875 MB (96,000 blocks). • When TC is cascaded with UR, a data volume can be copied to multiple data centers.

Item	Requirement
	<ul style="list-style-type: none"> The same value must be set for the T10 PI attribute of the P-VOL and the S-VOL. A volume (LDEV) from a parity group with accelerated compression enabled cannot be used directly as a pair volume. Such volumes must be used as pool volumes for an HDP or HDT pool. You need to set the same value for T10 PI attribute for both P-VOL and S-VOL. You cannot use the NAS Platform system LU as a pair volume.
Journals and journal volumes (VSP G1000, G1500, and VSP F1500)	<ul style="list-style-type: none"> Maximum number of journals supported per storage system: 256 (0 to 255) Maximum number of journal volumes: 2. Note: The second journal volume becomes the reserve journal volume and is not used for normal operations. Maximum number of data volumes: 16,384 for each journal, and 8,192 for each mirror. However, for the 3DC multi-target or 3DC cascade configuration with three UR sites, use the same data volume in two mirrors. Maximum journal volume size: 60 TB Minimum journal volume size: 1.5 GB Maximum number of data volumes per journal: 8,192 Emulation types for journal volumes: OPEN-V. Journal volumes must be DP-VOLs. The following volumes cannot be registered to a journal: <ul style="list-style-type: none"> A DP-VOL with the Data Direct Mapping attribute. A DP-VOL with the capacity saving enabled. A deduplication system data volume. The relationship between a master journal and a restore journal is called a mirror. Mirror IDs are 0 to 3. <p>For details, see Planning journal volumes on page 67.</p>
Journals and journal volumes (VSP Gx00 models and VSP Fx00 models)	<ul style="list-style-type: none"> Maximum number of journals: <ul style="list-style-type: none"> VSP G800, VSP F800: 128 (journal ID: 0-255) if shared memory "Extension2" is implemented. If shared memory "Extension2" is not implemented, you can only set up to 32 journals. If shared memory "Extension3" is not implemented, you can only set up to 64 journals. Even though 256 IDs are available, you can only use 128 of them. VSP G400, VSP F400, VSP G600, VSP F600: 64 (journal ID: 0-255) if shared memory "Extension2" is implemented. If shared memory "Extension2" is not implemented, you can only set up to 32 journals. Even though 256 IDs are available, you can only use 64 of them. VSP G200: 16 (journal ID: 0-255) Even though 256 IDs are available, you can only use 16 of them. Preferred number of journals: up to 4 Maximum number of data volumes in a journal: <ul style="list-style-type: none"> VSP G800, VSP F800: 8,192 per journal VSP G400, VSP F400, VSP G600, VSP F600: 4,096 per journal VSP G200: 2,048 per journal Maximum number of journal volumes in a journal: 2 per journal. When there are two, one is the reserve (spare) journal volume.

Item	Requirement
	<ul style="list-style-type: none"> • Volumes to which a path (LU path) is set from a host cannot be registered as journal volumes. • Only Dynamic Provisioning virtual volumes (DP-VOLs) can be used as journal volumes. The following volumes cannot be registered to a journal: <ul style="list-style-type: none"> ○ A DP-VOL with the Data Direct Mapping attribute. ○ A DP-VOL with the capacity saving enabled. ○ A deduplication system data volume. • Virtual storage machine volumes cannot be used as journal volumes. • Data volumes belonging to different virtual storage machines cannot be registered to the same journal. • Minimum journal volume size: 1.5 GB • Recommended journal volume size: 6 GB or more • Journal volume capacity is not included in Universal Replicator capacity cost. • Journal IDs cannot be duplicated among the virtual storage machines of VSP G200, VSP G400, VSP G600, and VSP F400, F600.
Supported volume types	<p>Virtual LUN:</p> <ul style="list-style-type: none"> • Can be used for data and journal volumes. • S-VOL capacity must equal P-VOL capacity. <p>Cache Residency Manager:</p> <ul style="list-style-type: none"> • Data volume: yes • Journal volume: no
Maximum number of pairs	Limited per storage system. See Maximum number of pairs allowed on page 70 .
Supported RAID groups	<ul style="list-style-type: none"> • RAID1, RAID5, and RAID6 are supported for both data and journal volumes. • RAID1, RAID5, and RAID6 can co-exist in the same journal.
Cache and nonvolatile storage (NVS)	<p>Must be operable for primary and secondary storage systems to ensure pair creation success. The secondary storage system cache must be configured to adequately support UR remote-copy workloads, as well as local workload activity. To determine the appropriate cache capacity to be increased, perform the following calculations A and B and use the smaller result:</p> <p>A. 1 GB × number of journals</p> <p>B. 25% of the necessary cache to support the storage capacity</p> <p>Note: When pair status is COPY, neither cache nor shared memory can be added to or removed from the system. When either of these tasks is to be performed, first split any pairs in COPY status, and then resynchronize when the cache or shared memory operation is completed.</p>
Host failover software	Required for disaster recovery.
CCI consistency groups with multiple primary and secondary storage systems	<ul style="list-style-type: none"> • In the CCI CTG with multiple storage systems, a maximum of four units storage system can be connected. For example, you can configure the CCI CTG storage system of four units each for the primary site and secondary site. Likewise, you can configure the CCI CTG multiple systems of two units

Item	Requirement
	<p>storage system for the primary site and one unit storage system for the secondary site.</p> <ul style="list-style-type: none"> VSP G1000, G1500, and VSP F1500: Up to 8,192 pairs. You can register the total number of pairs in the journals within one CCI consistency group. It is recommended that you register only up to 4,096 pairs. VSP G800, VSP F800: Up to 8,192 pairs. It is recommended that you register only up to 4,096 pairs. VSP G400, G600, VSP F400, F600: Up to 4,096 pairs. It is recommended that you register only up to 2,048 pairs. VSP G200: Up to 2,048 pairs. It is recommended that you register only up to 1,024 pairs.

Related concepts

- [Planning UR in multiple storage systems using a consistency group](#) on page 77

Related references

- [Registering multiple journals to a CCI consistency group](#) on page 81

Interoperability requirements

This topic provides the interoperability requirements for Universal Replicator.

Universal Replicator can be used extensively with TrueCopy and ShadowImage to provide additional data redundancy and enhanced disaster recovery solutions. For information about these configurations, see the following appendixes:

- [Configurations with TrueCopy on page 321](#)
- [Configurations with ShadowImage on page 341](#)

Volume types that can be shared with Universal Replicator

The following table shows whether volumes used by other software products can also be used as UR P-VOLs, S-VOLs, and journal volumes.

Volumes types and functions	Used as UR P-VOL?	Used as UR S-VOL?	Used as UR journal volume?
Cache Residency Manager (VSP G1000, G1500, and VSP F1500)			
Volume set for CRM	Yes	Yes	No
Cross-OS File Exchange (VSP G1000, G1500, and VSP F1500)			
Volume usable by both mainframe and open systems	No	No	No
Data Retention Utility			
Volume with Read/Write attribute	Yes	Yes	Yes

Volumes types and functions	Used as UR P-VOL?	Used as UR S-VOL?	Used as UR journal volume?
Volume with Protect attribute	Yes	Yes	No
Volume with Read Only attribute	Yes	Yes	No
Volume that is disabled for use as an S-VOL	Yes	Only when resyncing a UR pair.	No
Dynamic Provisioning			
Virtual volume	No	No	Yes
Virtual volume with Data Direct Mapping attribute	No	No	No
Pool-VOL	No	No	No
V-VOL with capacity saving enabled	Yes	Yes	No
Deduplication system data volume	No	No	No
Dynamic Tiering / Active flash			
Virtual volume	Yes	Yes	No
Pool-VOL	No	No	No
Global-active device ^{12, 15}			
P-VOL	Yes	No	No
S-VOL	Yes ⁹	No	No
Quorum disk	No	No	No
Volume with reserve attribute for S-VOL	No	No	No
Global storage virtualization			
Volumes in a virtual storage machine	Yes ⁵	Yes ⁵	No
LUN Manager			
Volume to which a path is defined	Yes	Yes	No
Volume to which no path is defined	No	No	Yes
Volume to which LUN security is applied	Yes	Yes	No
Resource Partition Manager			
Resource Partition Manager volume	Yes	Yes	Yes
ShadowImage ⁷			
P-VOL in PSUS status	Yes	Yes ^{13, 14}	No
P-VOL in PSUE status	Yes	Yes ^{13, 14}	No
P-VOL in COPY(RS-R)/RCPY status	No	No	No
P-VOL that is also used as a TC P-VOL or S-VOL	Yes	Yes ^{13, 14}	No
P-VOL (None of the above)	Yes	Yes ^{6, 13, 14}	No
S-VOL in PSUS status	Yes	No	No
S-VOL in PSUE status	Yes	No	No
S-VOL (None of the above)	No	No	No
Thin Image ^{10, 13, 16}			
P-VOL in all statuses except RCPY	Yes ¹	Yes ^{2, 11}	No

Volumes types and functions	Used as UR P-VOL?	Used as UR S-VOL?	Used as UR journal volume?
P-VOL in RCPY status	No	No	No
V-VOL	No	No	No
pool-VOL	No	No	No
TrueCopy ^{8, 10, 12}			
P-VOL in COPY status	No	No	No
P-VOL in PAIR status	Yes	No	No
P-VOL in PSUS status	Yes	No ³	No
P-VOL in PSUE status	Yes	No ³	No ³
S-VOL in COPY status	No	No	No
S-VOL in PAIR status	Yes	No	No
S-VOL in PSUS status	Yes	No	No
S-VOL in SSWS status	Yes	No ³	No
S-VOL in PSUE status	Yes	No	No
Universal Volume Manager			
Universal Volume Manager volume	Yes	Yes	No
Virtual LUN			
Virtual LUN volume	Yes	Yes	No
Volume Migration ^{10, 3}			
Source volume (when volume migration is in progress)	Yes ⁴	Yes	No
Source volume (after volume migration is finished)	Yes	Yes	No
Notes:			
<ol style="list-style-type: none"> 1. The volume can be used as a UR pair volume for delta resync. 2. The UR pair must be created first, otherwise No. 3. The volume can be used as an S-VOL only when you resync a UR pair or perform the hor takeover operation, though even in these cases, it cannot be used in a pair for a delta resync operation. For Volume Migration, this applies to VSP Gx00 models and VSP Fx00 models. 4. UR pair status must be other than COPY or PAIR to use the P-VOL as a source volume and perform volume migration. The migration operation stops if UR pair status changes to COPY or PAIR. 5. A volume whose virtual LDEV ID is deleted cannot be used as a UR pair volume. 6. When a DP-VOL is used as a pair volume shared by ShadowImage and UR, the UR create pair operation can fail. For information about how to ensure against failure, see the bullet on DP-VOL s and ShadowImage in Dynamic Provisioning on page 53. 7. For complete information, see Configurations with ShadowImage on page 341. 8. For complete information, see Configurations with TrueCopy on page 321. 9. The volume must be used as the P-VOL of a UR delta resync pair. 10. In a 3DC multi-target or 3DC cascade configuration in which three UR sites are combined, the volume shared with the two UR pairs cannot be used by this software. Also, the volume used in this software cannot be used as the volume shared with the two UR pairs. 11. You cannot specify a volume used as a Thin Image P-VOL as an S-VOL when creating a UR pair. 			

Volumes types and functions	Used as UR P-VOL?	Used as UR S-VOL?	Used as UR journal volume?
12. (HUS VM, VSP G800, VSP F800, VSP G1000, G1500, and VSP F1500 (3DC multi-target only)) A UR volume can only be shared with a TC volume or a GAD volume on a system that supports 3DC configurations .			
13. For 3DC configurations with three UR sites, do not assign the P-VOL of an SI pair that uses DP-VOLs of Dynamic Provisioning as the S-VOL of a UR pair for delta resync.			
14. When both the P-VOL and S-VOL of Universal Replicator are DP-VOLs of Dynamic Provisioning, the S-VOL of a UR pair cannot be used as the P-VOL of an SI pair. For details, see Dynamic Provisioning on page 53 .			
15. For more information on using Universal Replicator with global-active device, see the <i>Global-Active Device User Guide</i> .			
16. For the node volume or the leaf volume of Thin Image, see the description of the V-VOL, not the P-VOL.			

Cache Residency Manager

CRM volumes can be used as Universal Replicator P-VOLs and S-VOLs.

- You can perform CRM operations on a Universal Replicator pair's P-VOL and S-VOL.
- CRM volumes cannot be used as journal volumes.

Data Retention Utility

You can create a Universal Replicator pair using volumes that have been assigned the access attribute by the Data Retention Utility. However, you cannot specify a volume with the "S-VOL Disable" attribute as a Universal Replicator S-VOL.

The following table shows whether the access attribute can be changed or referenced.

Table 2 UR pair status and DRU operations

UR volume	UR pair status	DRU access attribute changed?	DRU access attribute referenced?
P-VOL	Unpaired	Yes	Yes
	COPY	See next table.	Yes
	PAIR	See next table.	Yes
	PSUS	Yes	Yes
	PSUE	Yes	Yes
S-VOL	Unpaired	Yes	Yes
	COPY	No	Yes
	PAIR	No	Yes
	PSUS	No	Yes
	PSUE	No	Yes

The following table shows when changes can be made to the access attribute when the Universal Replicator P-VOL status is PAIR or COPY.

Table 3 Whether access attribute can be changed when UR P-VOL status is PAIR or COPY

Change access attribute from	Change access attribute to			
	Read/Write	Read Only	Protect	S-VOL Disable
Read/Write	-	No	No	Yes
Read Only	Yes	-	Yes	Yes
Protect	Yes	Yes	-	Yes
S-VOL Disable.	Yes	No	No	-

Dynamic Provisioning

You can create a Universal Replicator pair by specifying a DP-VOL (Dynamic Provisioning virtual volume).

- DP-VOLs can be used for either the UR P-VOL or S-VOL, or both P-VOL and S-VOL.

A DP-VOL with the capacity saving enabled can be used as a P-VOL or S-VOL of a UR pair. The deduplication system data volume cannot be used as a P-VOL or S-VOL of a UR pair, or as a journal volume.

When the UR pair using a DP-VOL with capacity saving disabled is in COPY status, the P-VOL capacity saving can be enabled. Capacity savings of a UR pair P-VOL does not begin until after the pair status changes to something other than COPY.

- DP-VOLs cannot be used as journal volumes.
- When a DP-VOL is used for a UR P-VOL or S-VOL, the UR of the allocated pages for the DP-VOL is included in the UR licensed capacity. If the actual licensed capacity exceeds the available licensed capacity, you may use UR for 30 days. After 30 days, UR pairs may only be split or released. The UR licensed capacity for a volume with capacity saving enabled is the capacity before savings.
- When you specify a DP-VOL that has allocated pages to a UR S-VOL, the used pool capacity will become temporarily larger than the actual capacity, because pages must be reallocated in the DP-VOL. Therefore, before creating the pair:
 - Make sure that DP-VOL pool capacity is sufficient.
 - Make sure that the pool-VOLs, which are added to a pool, are not blocked. If the pool-VOLs are blocked, restore the volume status and then create the pair.
- If you want to use DP-VOLs that are also used by ShadowImage or that are in a Volume Migration migration plan, proceed as follows:
 1. Delete the ShadowImage pair or disable the Volume Migration setting.
 2. Create the UR pair.

3. Re-create the ShadowImage pair or the Volume Migration migration plan.
- When a DP-VOL is used as the UR S-VOL, you might not be able to update the UR S-VOL because the capacity of the pool-VOL is full. In this instance:
 - The pair is suspended.
 - With CCI, the UR pair status changes to PFUS.
 - In Device Manager - Storage Navigator, the UR pair status changes to PSUS.
 - When both of the following conditions exist, pages that do not exist in the P-VOL might be assigned to the S-VOL when splitting and then resynchronizing the pair:
 - The copy pace is Faster.
 - The pair is created and the pair status is COPY.

To delete S-VOL pages that do not exist in the P-VOL, use the Reclaim Zero Pages function for the DP-VOL.

- Data compressed or deduplicated by the capacity saving function is copied to a volume after compression and deduplication are released. The capacity saving function is not performed immediately for copied data. Before creating or resynchronizing a UR pair, make sure that the available capacity in the copy destination volume is greater than the used capacity in the copy origination volume before capacity saving. For details, see the *Provisioning Guide for Open Systems*.
- If you create a UR pair using a volume for which the capacity saving function is used, compressed or deduplicated data is copied. Copy or I/O performance might be degraded because of this.
- When installing Universal Replicator, if you enable the capacity saving function of the S-VOL to create a UR pair, specify Slower or Medium for Copy Pace. If you specify Faster, and perform an initial copy, the processing for the capacity saving function conflicts with restoration. As a result, the copy pace becomes slower than Faster. If you want to specify Faster, disable the capacity saving function first, and then enable it again after the copy processing completes.
- When the capacity saving function is used, management information is stored in a pool. As a result, there might be differences between a P-VOL and an S-VOL in the number of used pages or licensed capacity.

Global-active device

In a GAD system, the server accesses the primary site and GAD secondary site simultaneously and shares the same data between the two sites (at campus distance). If a failure occurs at one of the sites, you can continue operations at the other site. However, if a failure occurs at both sites, for example due to a large-scale disaster, you will not be able to continue operations with the data redundancy provided only by GAD.

To manage this situation, you can implement a three-data-center (3DC) configuration by combining GAD and Universal Replicator. This configuration is called a GAD+UR configuration. If there is a failure at both the primary site and the GAD secondary site, the GAD+UR configuration enables you to continue operations using the UR secondary site (at metro distance).

The following figure shows a GAD+UR configuration. Always use this configuration for GAD+UR operations.

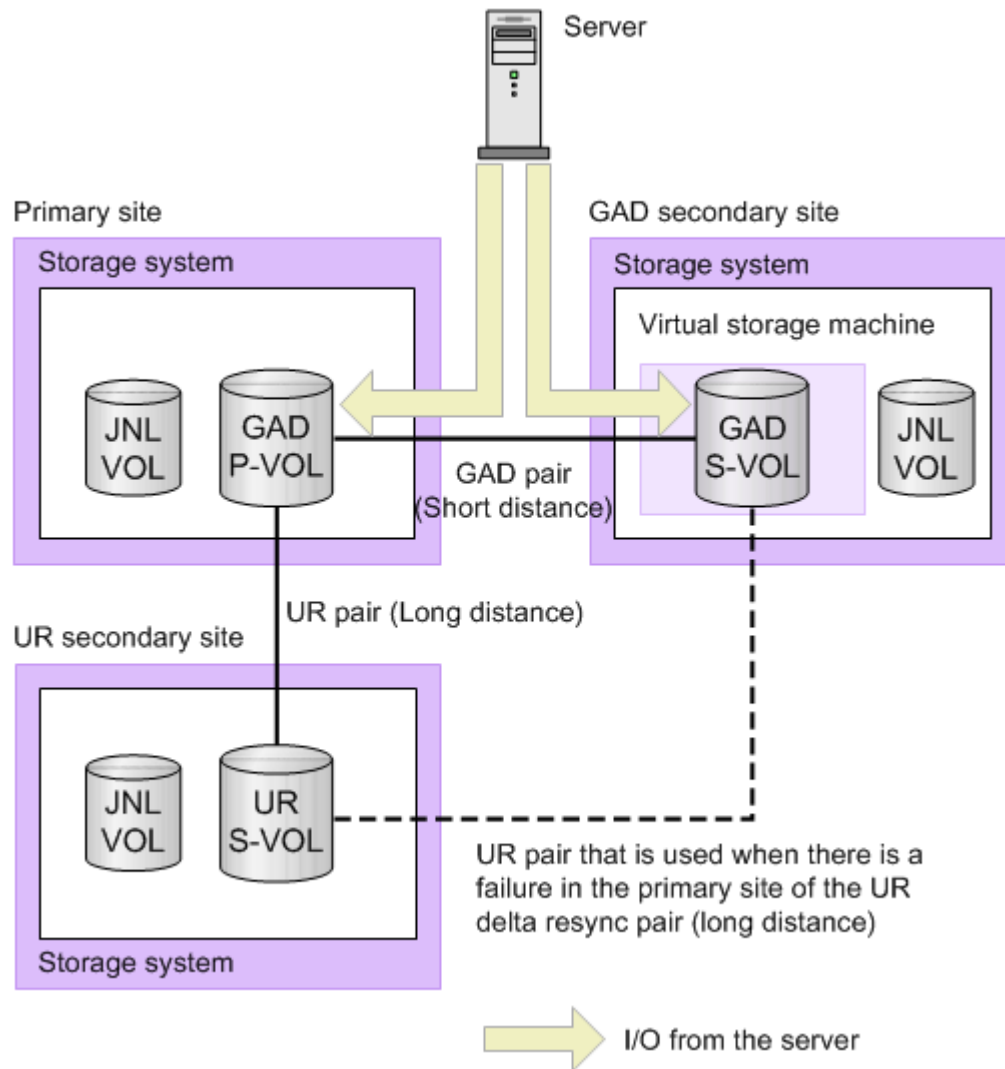

In a GAD+UR configuration:

- The P-VOL of the GAD pair functions as the P-VOL of the UR pair.
- The S-VOL of the GAD pair functions as the P-VOL of the UR delta resync pair.
- The UR delta resync pair consists of the GAD S-VOL at the GAD secondary site and the UR S-VOL at the UR secondary site. This UR delta resync pair

allows you to synchronize the UR pair S-VOL by using the journal data at the GAD secondary site in the event of a failure at the primary site.

For details about the GAD+UR configuration, see the *Global-Active Device User Guide*.

Global storage virtualization

Pairs can be created using volumes in a virtual storage machine. Note the following:

- Though Device Manager - Storage Navigator displays the virtual LDEV ID of a volume belonging to a virtual storage machine, make sure when running pair operations in Device Manager - Storage Navigator that you specify the physical LDEV ID.
- A volume's virtual ID used with Universal Replicator cannot be deleted.

LUN Manager

- LUN Manager operations do not affect Universal Replicator operations. Volumes that are under secure ports and/or are assigned to host groups or iSCSI targets can also be assigned to Universal Replicator pairs. Volumes that are assigned to Universal Replicator pairs can be protected by LUN Manager.
- Universal Replicator S-VOLs cannot be accessed by any UNIX® or PC server host except when the pair is split.

Resource Partition Manager

You can specify Resource Partition Manager volumes as UR P-VOL and S-VOL as long as they belong to the same resource group. For journal volumes, use a Resource Partition Manager OPEN-V virtual volume.

For details, see the *Provisioning Guide* for your storage system.

Thin Image

Universal Replicator pair volumes can be shared with Thin Image (TI) P-VOLs, with limitations on how they can be used together.

- A UR P-VOL or S-VOL can be used as a TI P-VOL.
- A UR P-VOL or S-VOL that is part of a delta resync configuration with TrueCopy can also be used as a TI P-VOL.
- A TI P-VOL cannot be specified as an S-VOL when creating a UR pair. However, you can specify a TI P-VOL as an S-VOL when creating a UR delta resync pair in a 3DC multi-target or 3DC cascade configuration with three UR sites.

UR basic configuration with TI

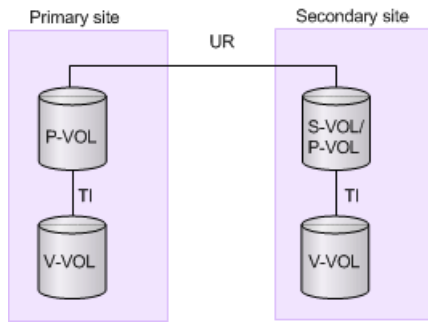

- The UR pair must be created before the secondary site TI pair.

3DC cascade configuration with TI

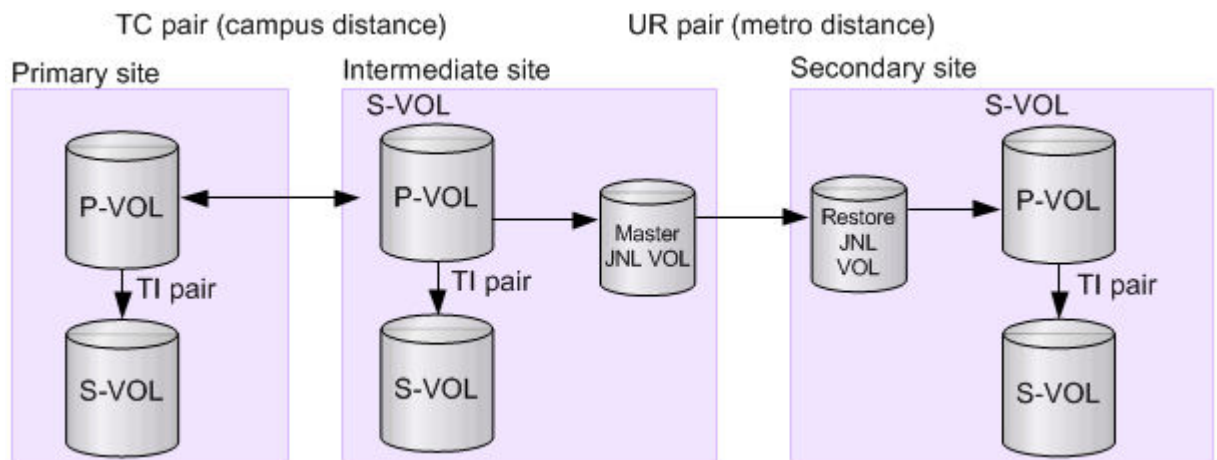

- The TC pair must be created before the intermediate TI pair.
- The UR pair must be created before the secondary site TI pair.

3DC multi-target configuration with TI

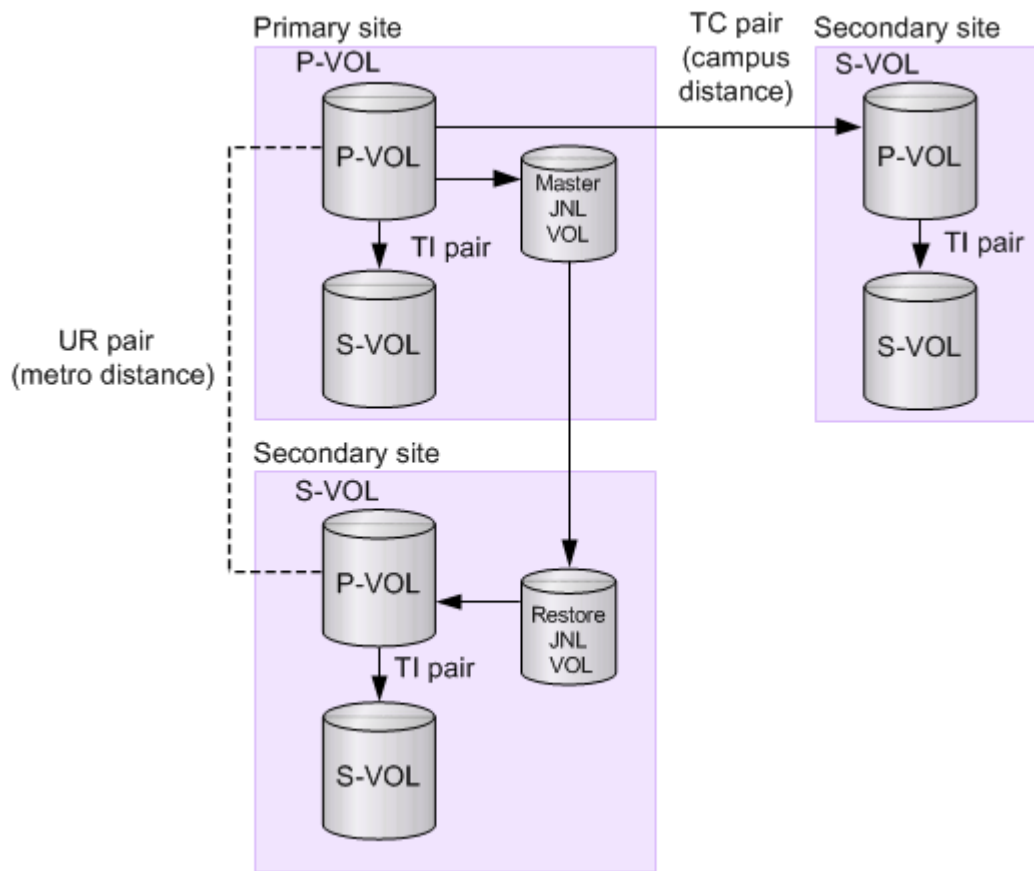

- You can create either the TC pair or the primary site TI pair first.
- The TC pair must be created before the secondary site TI pair (campus distance).
- The UR pair must be created before the secondary site TI pair (metro distance).

Delta Resync configuration with TI

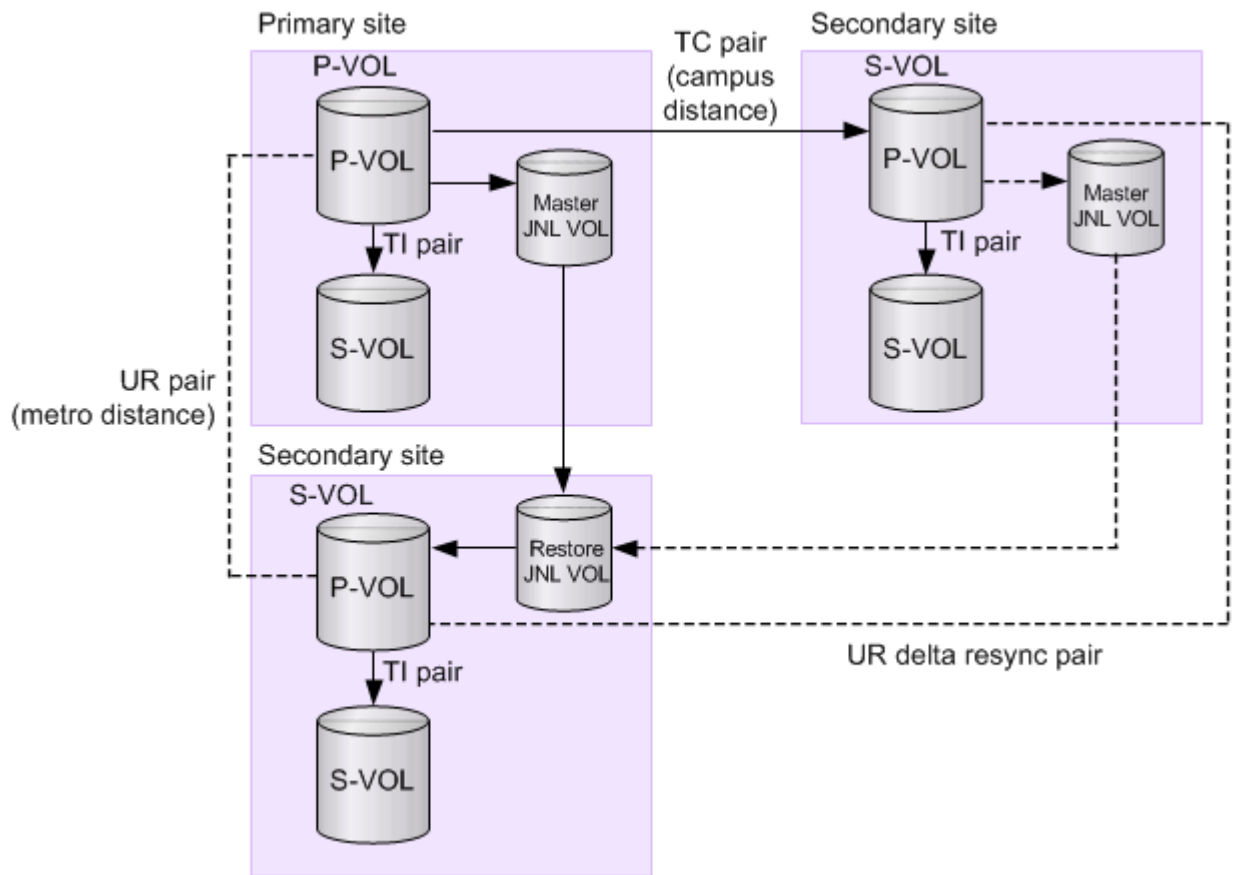

- The TC, UR, and UR delta resync pairs must be created before the secondary site TI pairs.
- You can create a primary site TI pair before or after the delta resync pairs.
- For the 3DC multi-target delta resync configuration and the 3DC cascade delta resync configuration with three UR sites, first you need to create the 3DC multi-target configuration or the 3DC cascade configuration. (You need to create the UR pairs before the TI pair in a "URxUR" 3DC delta configuration. You do not need to create the UR delta resync pair before the TI pairs at the secondary site.)

Universal Volume Manager

You can create UR pairs using Universal Volume Manager-configured volumes.

For details, see the *Hitachi Universal Volume Manager User Guide*.

Virtual LUN

Universal Replicator supports the Virtual LUN feature, which allows you to configure custom-size LU that are smaller than standard-size LUs. When

custom-size LUs are assigned to a Universal Replicator pair, the S-VOL must have the same capacity as the P-VOL.

To perform Virtual LUN operations on a pair's P-VOL and S-VOL, the pair must be deleted and the volumes' status returned to SMPL.

Volume Migration

You can specify the Universal Replicator P-VOL or S-VOL as Volume Migration source volumes. However, when UR pair status is COPY or PAIR, do not perform the volume migration operation; otherwise, the operation is stopped.

UR pair volumes and journal volumes cannot be used as Volume Migration target volumes.

Planning for Universal Replicator

This chapter provides planning information for Universal Replicator operations.

- [Planning and design](#)
- [Assessing business requirements for data recovery](#)
- [Write-workload](#)
- [Data transfer speed considerations](#)
- [Sizing journal volumes](#)
- [Planning journals](#)
- [Planning journal volumes](#)
- [Planning journal volumes for delta resync](#)
- [Planning pair volumes](#)
- [Disaster recovery considerations](#)
- [Cache and additional shared memory](#)
- [Sharing volumes with other product volumes](#)
- [Planning UR in multiple storage systems using a consistency group](#)
- [Planning for other storage systems](#)
- [Registering multiple journals to a CCI consistency group](#)

- [Preparing the storage systems for UR](#)

Planning and design

Planning the Universal Replicator system is tied to your business requirements and production system workload. You must define your business requirements for disaster downtime and measure the amount of changed data your storage system produces over time. Using this information, you can calculate the size of journal volumes and the amount of bandwidth required to handle the transfer of data over the data path network.

Use the information in this chapter and work with your HDS account team to determine your UR implementation plan.

Plan and design activities

- Assess your organization's business requirements to determine the recovery requirements.
- Measure the write workload (MB/sec and IOPS) of your host applications to begin matching actual data loads with the planned UR system.
- Use the collected data along with your organization's recovery point objective (RPO) to size UR journal volumes. Journal volumes must have enough capacity to hold accumulating data over extended periods. The sizing of journal volumes is influenced by the amount of bandwidth. These factors are interrelated. You can adjust journal volume size in conjunction with bandwidth to fit your organization's needs.
- Use IOPS to determine data transfer speed into and out of the journal volumes. Data transfer speed is determined by the number of Fibre Channel or iSCSI ports you assign to UR, and by RAID group configuration. You need to know port transfer capacity and the number of ports that your workload data will require.
- Use collected workload data to size bandwidth for the Fibre Channel data path. As mentioned, bandwidth and journal volume sizing, along with data transfer speed, are interrelated. Bandwidth can be adjusted with the journal volume capacity and data transfer speed you plan to implement.
- Design the data path network configuration, based on supported configurations, Fibre Channel switches, and the number of ports required for data transfer.
- Plan data volumes (primary and secondary volumes) based on the sizing of P-VOLs and S-VOLs, RAID group configurations, and other considerations.
- Review host OS requirements for data and journal volumes.
- Adjust cache memory capacity for UR.

Assessing business requirements for data recovery

In a UR system, the journals remain fairly empty when the data path is able to transfer the updated data to the secondary site. However, if a path failure occurs, or if the amount of write-data exceeds bandwidth for an extended period of time, data flow can stop. Updated data that cannot be transferred to the secondary storage system accumulates in the master journal.

Use the following information to size the journals so they can hold the amount of data that can accumulate:

- The amount of changed data that your application generates. Measure the write-workload to gather this information.
- The maximum amount of time that journals can accumulate updated data. This information depends on your operation's recovery point objective (RPO).

Determining your RPO

Your operation's RPO is the maximum time that can pass after a failure or disaster occurs before data loss is greater than the operation can tolerate.

For example, if a disaster occurs at 10:00 AM and the operation can tolerate a loss of up to one hour of data, then the system must be corrected by 11:00 AM.

For proper journal sizing, the journal must have the capacity to hold the maximum amount of data that can accumulate in one hour. If the RPO is 4 hours, then the journal must be sized to hold 4 hours of update data.

To assess RPO, you must know the host application's write-workload.

By measuring write workload and IOPS, you can analyze the number of transactions the write workload represents, determine the number of transactions the operation could lose and still remain viable, determine the amount of time required to recover lost data from log files or re-enter lost data, and so on. The result is your RPO.

Write-workload

Write-workload is the amount of data that changes in your production system in MB per second. As you will see, write-workload varies according to the time of day, week, month, quarter. That is why workload is measured over an extended period.

With the measurement data, you can calculate workload averages, locate peak workload, and calculate peak rolling averages, which show an elevated average. Use this data to calculate the amount of data that accumulates over

your RPO time, for example, 2 hours. This is a base capacity for your journal volumes or represents a base amount of bandwidth that your system requires.

Whether you select average, rolling average, or peak, workload is based on the amount of bandwidth you provide the data path (which is also determined by write-workload). Bandwidth and journal volume capacity work together and depend on your strategy for protecting data.

Measuring write-workload

Workload data is collected using Hitachi Performance Monitor or your operating system's performance-monitoring feature. You will use IOPS to set up a proper data transfer speed, which you ensure through RAID group configuration and by establishing the number of Fibre Channel or iSCSI ports your UR system requires. Each RAID group has a maximum transaction throughput; the ports and their microprocessors have an IOPS threshold.

Workload and IOPS collection is best performed during the busiest time of month, quarter, and year. This helps you to collect data that shows your system's actual workloads during high peaks and spikes, when more data is changing, and when the demands on the system are greatest. Collecting data over these periods ensures that the UR design you develop will support your system in all workload levels.

Data transfer speed considerations

The ability of your UR system to transfer data in a timely manner depends on the following two factors:

- RAID group configuration
- Fibre Channel or iSCSI port configuration

You must plan both of these elements to handle the amount of data and number of transactions your system will generate under extreme conditions.

RAID group configuration

A RAID group can consist of physical volumes with a different number of revolutions, physical volumes of different capacities, and physical volumes of different RAID configurations (for example, RAID-1 and RAID-5). The data transfer speed of RAID groups is affected by physical volumes and RAID configurations.

Fibre Channel or iSCSI port configuration

Your Fibre Channel or iSCSI ports have an IOPS threshold of which you should be aware so that you can configure an appropriate number of Fibre Channel or iSCSI ports.

You can use the performance monitoring information for the number of IOPS your production system generates to calculate the number of Fibre Channel or iSCSI ports the UR system requires.

Related concepts

- [Planning ports for data transfer](#) on page 104

Sizing journal volumes

Journals volumes should be sized to meet all possible data scenarios, based on your business requirements. If the amount of data exceeds capacity, performance problems and suspensions result.

Hitachi recommends a capacity of 6 GB or more. Journal volumes cannot be registered if capacity is lower than 1.5 GB.

Procedure

1. Follow the instructions for [Measuring write-workload on page 65](#).
2. Use your system's peak write-workload and your organization's RPO to calculate journal size. For example:

RPO = 2 hours

Write-workload = 30 MB/second

Calculate write-workload for the RPO. In the example, write-workload over a two-hour period is calculated as follows:

$30 \text{ MB/second} \times 60 \text{ seconds} = 1,800 \text{ MB/minute}$

$1,800 \text{ MB/minute} \times 60 \text{ minutes} = 108,000 \text{ MB/hour}$

$108,000 \text{ MB/hour} \times 2 \text{ hours} = 216,000 \text{ MB}$

Basic journal volume size = 216,000 MB (216 GB)

Result

Journal volume capacity and bandwidth size work together. Also, your strategy for protecting your data might allow you to adjust bandwidth or the size of your journal volumes. For details about sizing strategies, see [Five sizing strategies on page 99](#).

Next steps



Note: Journal data stored in the master journal volume is not deleted until the data is restored to the secondary volume. Therefore, if the restore journal volume is larger than the master journal volume, the master journal volume first becomes full. If you are planning for disaster recovery, the secondary storage system must be large enough to handle the production workload, and therefore, must be the same size as master journals.

Planning journals

UR manages pair operations for data consistency through the use of journals. UR journals enable update sequence consistency to be maintained across a group of volumes.

Understanding the consistency requirements for an application (or group of applications) and their volumes will indicate how to structure journals.

For example, databases are typically implemented in two sections. The bulk of the data is resident in a central data store, while incoming transactions are written to logs that are subsequently applied to the data store.

If the log volume "gets ahead" of the data store, it is possible that transactions could be lost at recovery time. Therefore, to ensure a valid recovery image on a replication volume, it is important that both the data store and logs are I/O consistent by placing them in the same journal.

Use the following information about journal volumes and journals to plan your journals:

- A journal consists of one or more journal volumes and associated data volumes.
- A journal can have only P-VOLs/master journals, or S-VOLs/restore journals.
- A journal cannot belong to more than one storage system (primary or secondary).
- All the P-VOLs, or S-VOLs, in a journal must belong to the same storage system.
- Data volumes in different virtual storage machines cannot be registered in the same journal.
- Master and restore journal IDs that are paired can be different. If using a consistency group ID, the consistency group ID of the P-VOL and S-VOL must be the same.
- Each pair relationship in a journal is called a mirror. Each pair is assigned a mirror ID. The maximum number of mirror IDs is 4 (0 to 3) per system.
- When UR and URz are used in the same system, individual journals must be dedicated either to one or the other, not both.
- Master and restore journals are managed according to the journal ID.
- Review journal specifications in [System requirements on page 44](#).
- A journal can contain a maximum of 2 journal volumes.

Planning journal volumes

In addition to sizing journal volumes, you must also consider the following requirements and restrictions:

- Only DP-VOLs whose emulation type is OPEN-V can be used for journal volumes.
Exceptions are the DP-VOL with Data Direct Mapping attribute enabled or capacity saving enabled, and the deduplication system data volume. They cannot be used as journal volumes.
- Volumes in a virtual storage machine cannot be used as journal volume.
- A journal ID can be used in one virtual storage machine only.
- Volumes to which a path is set from a host cannot be registered as journal volumes.
- Journal volumes must be registered in a journal before the initial copy operation is performed.
- Journal volumes must be registered on both the primary and secondary storage systems.
- You can register two journal volumes in a journal in the primary storage system and in the secondary storage system, but we recommend using one journal volume in each system. The second journal volume becomes the reserve journal volume and is not used for normal operations.
- Journal volumes should be sized according to RPO and write-workload. For details, see [Sizing journal volumes on page 66](#).
- Journal volume capacity:
 - Journal volumes in a journal can have different capacities.
 - A master journal volume and the corresponding restore journal volume can have different capacities.
 - The displayed journal volume capacity is the master journal capacity and restore journal capacity. The reserve journal volume is not included in the displayed journal volume capacity.
 - Journal volume capacity is not included in accounting capacity.
 - In the GUI documents the journal volume capacity is called the journal capacity.
 - In the CCI documents the journal volume capacity is called the "capacity for the journal data on the journal volume" and "capacity of the data block size of the journal volume".
- The number of journal volumes in the master journal does not have to be equal to the number of volumes in the restore journal.
- A data volume and its associated journal volume can belong to only one journal.
- Data volumes and journal volumes in the same journal must belong to the same controller.
- Do not register a volume to a journal during quick formatting. Doing so stalls the operation.
- Journal volumes consist of two areas: One area stores journal data, and the other area stores metadata for remote copy.
- If you extend the journal volume when the journal volume size exceeds 36 GB, you need to restore the journal that is used for the extension to the S-VOL to use the extended capacity. However, it might take some time until the extended capacity becomes ready for use.

Related references

- [Planning journals](#) on page 67
- [System requirements](#) on page 44

Planning journal volumes for delta resync

For the 3DC multi-target configuration using delta resync, use the following formula to determine the journal volume capacity in the Universal Replicator primary site (TrueCopy secondary site).

Perform the following calculations A and B, and use the larger result:

$$A. \text{journal-volume-capacity} > (VH-L - VL-R) \times t$$

where:

- *VH-L*: data transfer speed between the host and the primary system
- *VL-R*: data transfer speed between the primary system and the secondary system

t: the time length of the data transfer peak work load duration

$$B. \text{journal-volume-capacity} > (VH-L \times t) \times 1.5$$

where:

- *VH-L*: data transfer speed between the host and the primary system
- *t*: the time it takes until the delta resync operation is performed

In formula B, 1.5 is used because, when updating the UR delta resync P-VOL, delta resync fails if the data capacity of the journal volume at the UR delta resync primary site (TC secondary site) exceeds 70%.

Planning pair volumes

The following information can help you prepare volumes for configuration. For more information, see system requirements and specifications in [Requirements and specifications on page 43](#).

- Each P-VOL requires one S-VOL only, and each S-VOL requires one P-VOL only.
- The emulation and capacity for the S-VOL must be the same as for the P-VOL
- When the S-VOL is connected to the same host as the P-VOL, the S-VOL must be defined to remain offline.
- When creating multiple pairs in the same operation using Device Manager - Storage Navigator, make sure that you set up S-VOL LUNs in a way that allows the system to correctly match them to selected P-VOLs.
Even though you select multiple volumes as P-VOLs in the Device Manager - Storage Navigator Create UR Pairs procedure, you are able to specify

only one S-VOL. The system automatically assigns LUs on the secondary storage system as S-VOLs for the other selected P-VOLs according to LUN. You will have two options for specifying how the system matches S-VOLs to P-VOLs.

- Interval: The interval you specify will be skipped between LDEV numbers in the secondary storage system.

For example, suppose you specify LU 01 as the initial (base) S-VOL, and specify 3 for Interval. This results in secondary storage system LDEV 04 being assigned to the next P-VOL, 07 assigned to the subsequent P-VOL, and so on. To use Interval, you set up secondary storage system LDEV numbers according to the interval between them.

- Relative Primary Volume. The difference is calculated between the LDEV numbers of two successive P-VOLs. S-VOLs are assigned according to the closest LUN number.

For example, if the LUN numbers of three P-VOLs are 1, 5, and 6; and you set LUN numbers for the initial S-VOL (Base Secondary Volume) at 2, the LUN numbers of the three S-VOLs will be set at 2, 6, and 7, respectively.

- You can create a UR pair using a TrueCopy initial copy, which takes less time. To do this, system option 474 must be set on the primary and secondary storage systems. Also, a script is required to perform this operation. For more on system option 474 and how to do this operation, see [System option modes on page 83](#).
- UR supports the Virtual LUN feature, which allows you to configure custom LUs that are smaller than standard LUs. When custom LUs are assigned to a UR pair, the S-VOL must have the same capacity as the P-VOL. For details about Virtual LUN feature, see the *Provisioning Guide* for your storage system.
- Identify the volumes that will become the P-VOLs and S-VOLs. Note the port, host group ID, iSCSI target ID, and LUN ID of each volume. This information is used during the initial copy operation.
- You can create multiple pairs at the same time. Review the prerequisites and steps in [Creating a UR pair on page 128](#).
- When you create a UR pair, you will have the option to create only the relationship, without copying data from P-VOL to S-VOL. You can use this option only when data in the two volumes is identical.

Maximum number of pairs allowed

The maximum number of pairs depends on the storage system.

The following table lists the maximum number of pairs allowed for each storage system.

VSP G1000, G1500, and VSP F1500	65,280 pairs (maximum)
VSP G800, VSP F800	8,192 pairs (maximum), 4,096 pairs or fewer, recommended

VSP G400, VSP F400, VSP G600, VSP F600	4,096 pairs (maximum), 2,048 pairs or fewer, recommended
VSP G200	2,048 pairs (maximum), 1,024 pairs or fewer, recommended

The maximum number for your storage system is limited by:

- The number of cylinders in the volumes, which must be calculated.
- The number of bitmap areas required for Universal Replicator data and journal volumes. This is calculated using the number of cylinders. If the volume size is larger than 4,194,304 MB (8,589,934,592 blocks), the bitmap area is not used. Therefore, it is not necessary to calculate the maximum number of pairs when creating UR pairs with DP-VOL whose size is larger than 4,194,304 MB (8,589,934,592 blocks).



Note: When SOM 1050 or Advanced System Setting No. 5 is enabled, the bitmaps for all pairs created with DP-VOLs smaller than 262,668 cylinders (4 TB), are managed in hierarchical memory and not in shared memory. In this case, the bitmap area in shared memory is not used, so you do not need to calculate the maximum number of pairs when SOM 1050/Advanced System Setting No. 5 is enabled.



Caution: The bitmap areas that are used for UR are also used for URz, TC, TCz, and GAD. If you use UR with any of these products, use the total number of each pair's bitmap areas to calculate the maximum number of pairs. In addition, if UR and TC share the same volume, use the total number of both pairs regardless of whether the shared volume is primary or secondary.

Calculating maximum number of pairs

The calculations in this topic use the following conventions:

- `ceil (<value>)` indicates that the value enclosed in parentheses must be rounded up to the next integer, for example: `ceil (2.2) = 3`
- `Number of logical blocks` indicates volume capacity measured in blocks.

`Number of logical blocks - Volume capacity (in bytes) / 512`

Calculating the number of cylinders

Use the following formula:

`Number of cylinders = (ceil ((ceil (number of logical blocks / 512)) / 15))`

Calculating the number of required bitmap areas

Use the following formula:

$$\text{ceil}(\text{number of cylinders} \times 15) / 122,752)$$

where:

- $\text{number of cylinders} \times 15$ indicates the number of slots
 - 122,752 is the number of slots that a bitmap area can manage
- Doing this calculation for multiple volumes can result in inaccuracies. Perform the calculation for each volume separately, and then total the bitmap areas. The following examples show correct and incorrect calculations. Two volumes are used: one of 10,017 cylinders and another of 32,760 cylinders.

Correct calculation

$$\text{ceil}((10,017 \times 15) / 122,752) = 2$$

$$\text{ceil}((32,760 \times 15) / 122,752) = 5$$

Total: 7

Incorrect calculation

$$10,017 + 32,760 = 42,777 \text{ cylinders}$$

$$\text{ceil}((42,777 \times 15) / 122,752) = 6$$

Total: 6

Calculating the maximum number of pairs

The maximum number of pairs is determined by the following:

- The number of bitmap areas required for Universal Replicator (previously calculated).
- The total number of bitmap areas as shown in the following table:

Extension status of shared memory for UR	Number of bitmap areas in storage systems
No extension	<ul style="list-style-type: none"> • VSP G200: 3,712 • VSP G400, G600, G800, VSP F400, F600, F800: 0
With extension	<ul style="list-style-type: none"> • VSP G200: 36,000 • VSP G400, G600, G800, VSP G1000, G1500, and VSP F1500: 65,536

Bitmap areas reside in an additional shared memory, which is required for Universal Replicator.

- Bitmap areas are used by TrueCopy, Universal Replicator, TrueCopy for Mainframe, Universal Replicator for Mainframe, and global-active device. Therefore, the number of bitmap areas used by these other program products (if any) must be subtracted from the total number of bitmap

areas (65,536 for example), with the difference used to calculate the maximum number of pairs available for Universal Replicator.

- If TrueCopy and Universal Replicator share the same volume, you must use the total number of bitmap areas for both pairs regardless of whether the shared volume is primary or secondary.
- If you are using a CCI command device, the maximum number of pairs supported is one less than the maximum supported by the storage system.

Calculate the maximum number of pairs using the following formula.

```
Maximum number of pairs = floor( Number of bitmap areas /  
required number of bitmap areas )
```

If the calculated maximum number of pairs exceeds the total number of LDEVs, and the total LDEVs are less than 32,768, then the total LDEV number is the maximum number of pairs that can be created.

Maximum initial copy operations and priorities

During configuration, you specify the maximum number of initial copies that can be run at one time. The system allows up to 128 initial copies to run concurrently for UR. You do this for performance reasons (the more initial copies running concurrently, the slower the performance).

You will also specify the priority for each initial copy during the create pair operation. Priority is used when you are creating multiple initial copies during an operation. Creating multiple initial copies in one operation is possible because you can specify multiple P-VOLs and S-VOLs in the Paircreate dialog box. The pair with priority 1 runs first, and so on.

When you create more pairs than the maximum initial copy setting, the pairs with priorities within the maximum number specified run concurrently, while the pairs with priorities higher than the maximum number wait. When one pair completes, a waiting pair begins, and so on.

If you perform a pair operation for multiple pairs (for a specific kind of data, for example), and then perform another operation for multiple pairs (for another kind of data, for example), the pairs in the first operation are completed in the order of their assigned priorities. The system begins processing pairs in the second set when the number of pairs left in the first set drops below the maximum number of initial copy setting. The following figure illustrates how the maximum number of initial copy setting works to control the impact of concurrent operations.

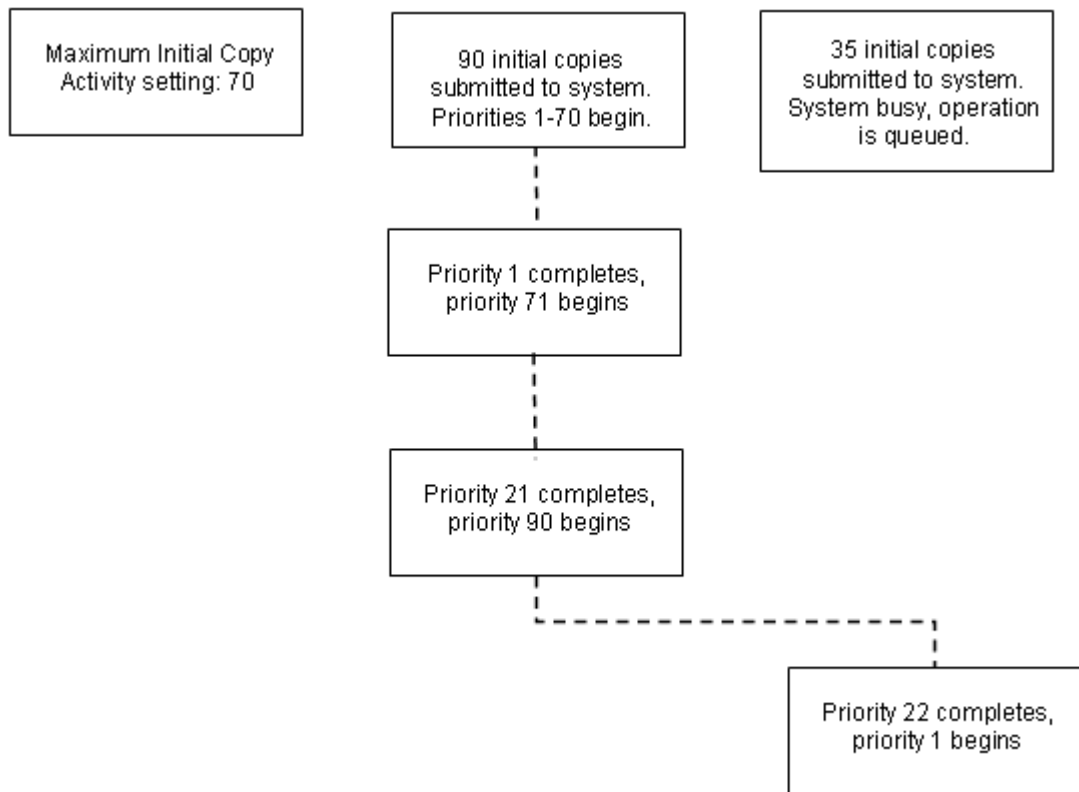

See the step for Priority in the procedure in [Creating a UR pair on page 128](#).

Disaster recovery considerations

You begin a disaster recovery solution when planning the UR system. The following are the main tasks for preparing for disaster recovery:

- Identify the data volumes that you want to back up for disaster recovery.
- Pair the identified volumes using UR.
- Establish file and database recovery procedures.
- Install and configure host failover software error reporting communications (ERC) between the primary and secondary sites.

For more information about host failover error reporting, see the following topic. Also, review [UR disaster recovery operations on page 237](#) to become familiar with disaster recovery processes.

Host failover software

Host failover software is a critical component of any disaster recovery effort. When a primary storage system fails to maintain synchronization of a UR pair, the primary storage system generates sense information. This information

must be transferred to the secondary site using the host failover software for effective disaster recovery. CCI provides failover commands that interface with industry-standard failover products.

Cache and additional shared memory

Cache must be operable for the pair's primary and secondary system, otherwise pairs cannot be created. The secondary system cache must be configured to adequately support Universal Replicator remote copy workloads and any local workload activity.

Additional shared memory is a prerequisite for UR in both the primary and secondary system.

Perform the following calculations and use the smaller result to add the cache memory capacity for Universal Replicator:

- 1 GB × *number-of-journals*
- 25% of the cache memory mounted on the storage system

You can remove the cache memory/shared memory that is no longer necessary. The following workflows describe how to add and remove the cache memory/shared memory when it is used with UR pairs.

Adding and removing cache memory

Use the following workflow to add or remove cache memory in a storage system in which UR pairs already exist:

Procedure

1. Identify the status of the UR volumes in the storage system.
2. If a UR volume is in the COPY status, wait until the status changes to PAIR, or split the UR pair.
Do not add or remove cache memory when any volumes are in the COPY status.
3. When the status of all volumes has been confirmed, cache memory can be added to or removed from the storage system by your service representative. Contact customer support for adding or removing cache memory.
4. After the addition or removal of cache memory is complete, resynchronize the pairs that you split in step 2.

Adding shared memory

Use the following workflow to add shared memory to a storage system in which UR pairs already exist:

Procedure

1. Identify the status of the UR volumes in the storage system.
2. If a UR volume is in the COPY status, wait until the status changes to PAIR, or split the UR pair.
Do not add shared memory when any volumes are in the COPY status.
3. When the status of all volumes has been confirmed, shared memory can be added to the storage system by your service representative. Contact customer support for adding shared memory.
4. After the addition of shared memory is complete, resynchronize the pairs that you split in step 2.

Removing shared memory (TC/UR/GAD)

Use the following workflow to remove shared memory from a storage system in which TC/UR/GAD pairs already exist:

Procedure

1. Identify the status of all volumes.
2. If a volume is used by a TC/UR/GAD pair, delete the pair.
Do not remove shared memory when any volume is used by a TC/UR/GAD pair.
3. When the status of all volumes has been confirmed, shared memory can be removed from the storage system by your service representative. Contact customer support for removing shared memory.

Removing shared memory (64KLDEV Extension)

Use the following workflow to remove shared memory used in 64KLDEV Extension:

Procedure

1. Identify the status of all volumes with an LDEV ID of 0x4000 or higher.
2. If a volume with an LDEV ID of 0x4000 or higher is used by a UR pair, delete the UR pair.
Do not remove shared memory used in 64KLDEV Extension when any volume with an LDEV ID of 0x4000 or higher is used by a UR pair.
3. When the status of all volumes with an LDEV ID of 0x4000 or higher has been confirmed, shared memory can be removed from the storage system by your service representative. Contact customer support for removing shared memory.

Sharing volumes with other product volumes

Universal Replicator volumes can be shared with other product volumes. Sharing pair volumes enhances replication solutions, for example, when Universal Replicator and TrueCopy or ShadowImage volumes are shared.

Related concepts

- [Interoperability requirements](#) on page 49
- [Sharing volumes with TrueCopy](#) on page 322
- [Overview of UR/SI configurations](#) on page 342

Planning UR in multiple storage systems using a consistency group

You can perform copy operations simultaneously on multiple UR pairs residing in multiple primary and multiple secondary storage systems by placing journals in the primary storage systems in a CCI consistency group. Data update order in copy processing is guaranteed to the secondary storage systems.

With multiple systems, the journals in the paired secondary storage systems are automatically placed in the consistency group.

With multiple systems, you can also place the journals from both OPEN and mainframe systems in the same CCI consistency group.

In addition, Universal Replicator volumes in multiple systems can be shared with other UR pairs and with TrueCopy pairs. For details, see [Configurations with TrueCopy on page 321](#).

The UR system can configure a maximum of four units primary storage system and a maximum of four units secondary storage system. Any combination of primary and secondary storage system can be used in the range of one to four. For example, you can include journals from four primary storage systems and four secondary storage systems, two primary storage systems and one secondary storage system, and so on.

The following figure shows a sample configuration.

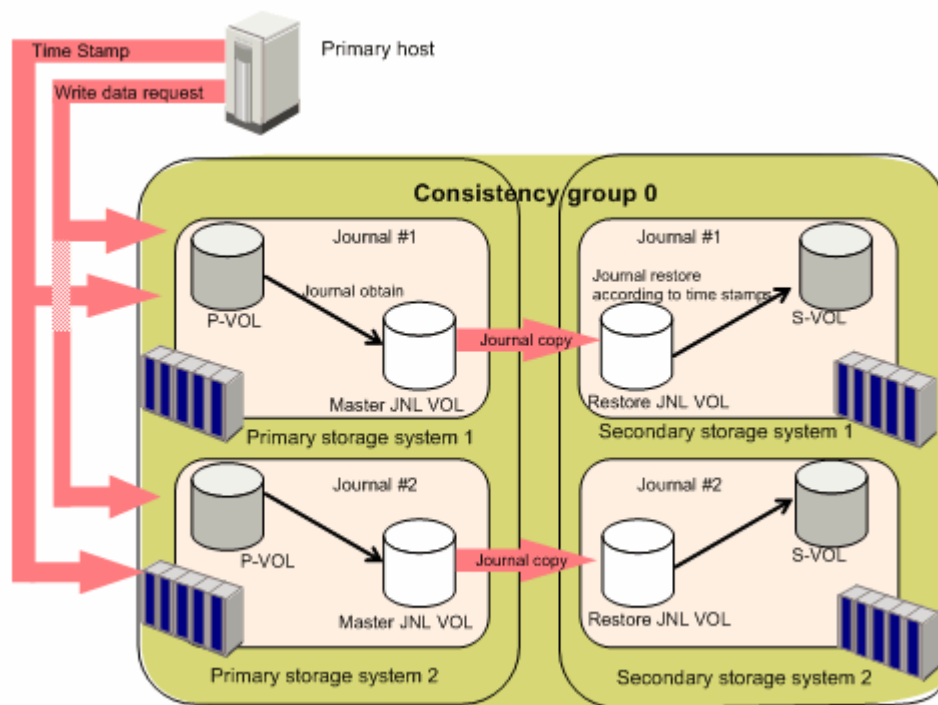

When data is sent to the secondary storage systems, the systems check the time stamps, which are added when data is written by the hosts to the P-VOLs. The secondary storage systems then restore the data to the S-VOLs in chronological order to ensure that the update sequence is maintained.

Requirements and recommendations for multiple system CTGs

Note the following when planning for multiple-system consistency groups:

- Device Manager - Storage Navigator is required at the primary and secondary sites.
- CCI is recommended on the host at the primary and secondary sites.
- Journal data is updated in the secondary storage system based on the time stamp and the sequence number issued by the host with write requests to the primary storage system. Time and sequence information remain with the data as it moves to the master and restore journals and then to the secondary volume.
- With CCI consistency groups, when a pair is split from the S-VOL side (P-VOL status = PAIR), each storage system copies the latest data from the P-VOLs to the S-VOLs. P-VOL time stamps might differ by storage system, depending on when they were updated.
- Disaster recovery can be performed with multiple storage systems, including those with UR and URz journals, using CCI. See [Switching host operations to the secondary site on page 239](#) for information.
- An error in one journal can cause suspension of all journals. For details, see [General troubleshooting on page 290](#).

- The time stamps issued by the mainframe host are not used when the URz journal is included in a CCI consistency group.
- If you created a URz pair in the configuration which multiple primary storage system and the secondary storage system are combined, the URz pair volume cannot be shared with a Compatible FlashCopy® volume.
- Restoring data to the secondary storage system is performed when the time stamp of the copied journal is updated. The recommended interval between time stamps is one second.

Consider the following before setting the interval:

- I/O response time slows when time stamps are updating among multiple storage systems. If you shorten the interval, more time stamps are issued, resulting in an I/O response time that is even slower.
- If the interval is lengthened, the amount of time that journal data can accumulate increases, which results in an increased amount of data to be copied.
- None of the above is true during the initial copy or resynchronization. During these operations, lengthening the interval between time stamps does not result in more accumulated journal data, because data restoring takes place regardless of time stamp.
- The recommended method for executing CCI commands is the in-band (host-based) method. This prevents I/O response from deteriorating, which can occur with the out-of-band (LAN-based) method.
- In a configuration in which multiple storage systems in primary and secondary sites are combined, configure the remote copy environment of each storage system as equally as possible. If the following conditions exist, the restoration performance of each journal is degraded, and journal data is accumulated:
 - The copy performance between the primary and secondary sites of some pairs is lower than other storage systems.
 - A problem occurs in a line between pairs.
- It is not possible to register a journal to multiple CCI consistency groups.

Planning for other storage systems

You can pair volumes in your storage system with volumes in VSP and USP V/VM storage systems.

- You can pair volumes in your storage system with volumes in VSP, USP V/VM, VSP Gx00 models, VSP Fx00 models, and HUS VM VSP and USP V/VM storage systems.
- A remote path must be connected between the current storage system and the other storage systems. For configuration instructions, see [Configuring primary and secondary storage systems for UR on page 117](#).
- When connecting to another storage system, set up the volumes in your storage system by using the following CU:LDEV numbers.

Current storage system model	Number of usable volumes	Range of CU:LDEV numbers
VSP G200	2,048	00:00 to 07:FF
VSP G400, VSP F400	4,096	00:00 to 0F:FF
VSP G600, VSP F600	4,096	00:00 to 0F:FF
VSP G800, VSP F800	16,384	00:00 to 3F:FF
VSP G1000, VSP G1500, and VSP F1500	65,280	00:00 to FE:FF
HUS VM	65,280	00:00 to FE:FF

- When connecting to VSP, or USP V/VM, VSP Gx00 models, VSP Fx00 models, or HUS VM, contact your HDS representative for information regarding supported microcode versions.
- When using the previous model storage system at the secondary site, make sure the primary and secondary storage systems have unique serial numbers.



Note: When you specify the VSP G1000, VSP G1500, or VSP F1500 serial number in CCI commands, add a "3" at the beginning of the serial number. For example, for serial number 12345, enter 312345.

- Any combination of VSP G1000, VSP G1500, VSP F1500, VSP G800, VSP F800, VSP, and USP V/VM can be used in 3-data-center (3DC) cascade or multi-target configurations. These configurations are used when combining TrueCopy and Universal Replicator systems. See [Configurations with TrueCopy on page 321](#) to review these configurations.

There are no restrictions for combining primary and secondary sites between VSP G1000, VSP G1500, VSP F1500, VSP, and USP V/VM in 2DC and 3DC configurations. Other than specification differences (for example, maximum number of pairs, supported capacity) there are no restrictions connecting HUS VM to VSP G1000, VSP G1500, VSP F1500, or VSP in 2DC configurations. However, HUS VM is not supported in any 3DC configurations with VSP G1000, VSP G1500, VSP F1500, or USP V/VM.



Note: The 2DC cascade configuration (also called UR pass-through) is not supported by HUS VM. For details about UR operations on the HUS VM, see the *Hitachi Unified Storage VM Hitachi Universal Replicator User Guide*.

- If you connect with VSP Gx00 models or VSP Fx00 models, the CTG ID for the P-VOL and S-VOL in a pair must match:
 - Connecting with VSP G200: Set CTG ID between 0 and 15.
 - Connecting with VSP G400, G600, VSP F400, F600: Set CTG ID between 0 and 63.

- Connecting with VSP G800 or VSP F800: Set CTG ID between 0 and 127.

Note: To avoid operational error, we recommend setting the CTG ID and the journal ID as the same ID.

Registering multiple journals to a CCI consistency group

Basically, only one journal should be registered to a CCI consistency group (CTG). However, in the configurations shown in the following figures, a maximum of four storage systems are registered to a CCI CTG. When the program products used in the primary site and secondary site storage system are the same, you can register either journal of the UR system.

For example, you can configure the CCI CTG storage system of four units each for the primary site and secondary site. Or you can configure the CCI CTG multiple systems of two units storage system for the primary site and one unit storage system for the secondary site, too.

In the following figures, multiple journals are registered to a consistency group.

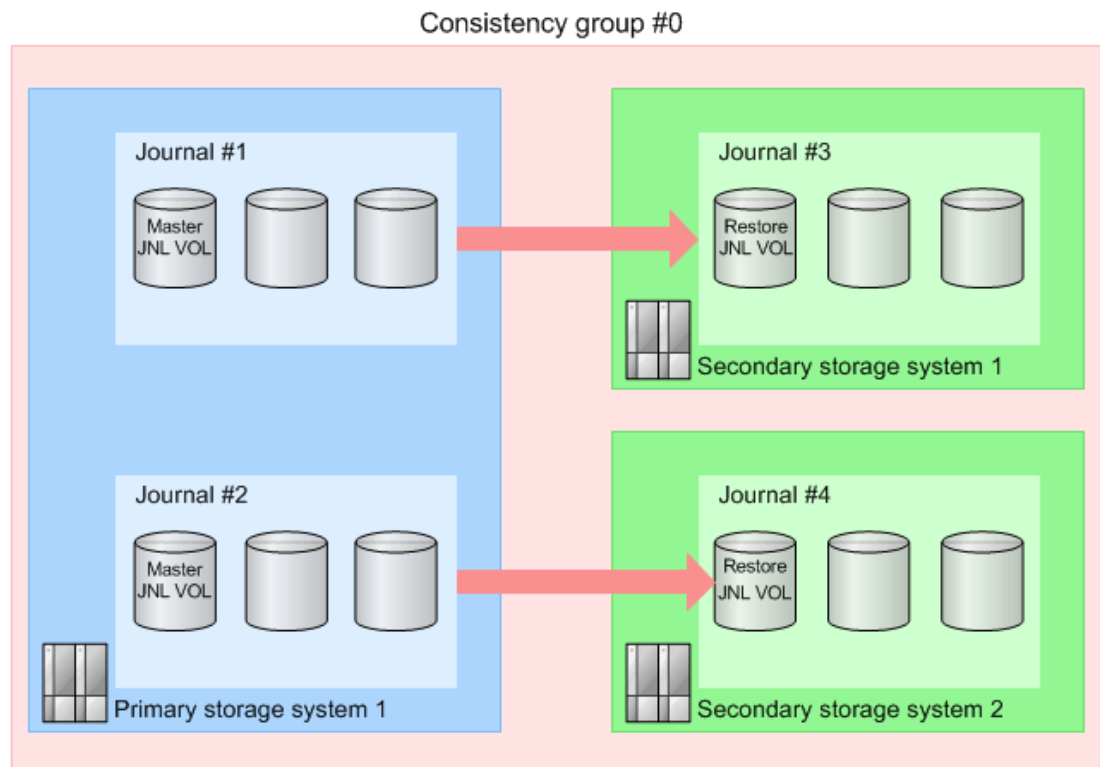

Figure 1 Configuration of a consistency group with multiple journals (1)

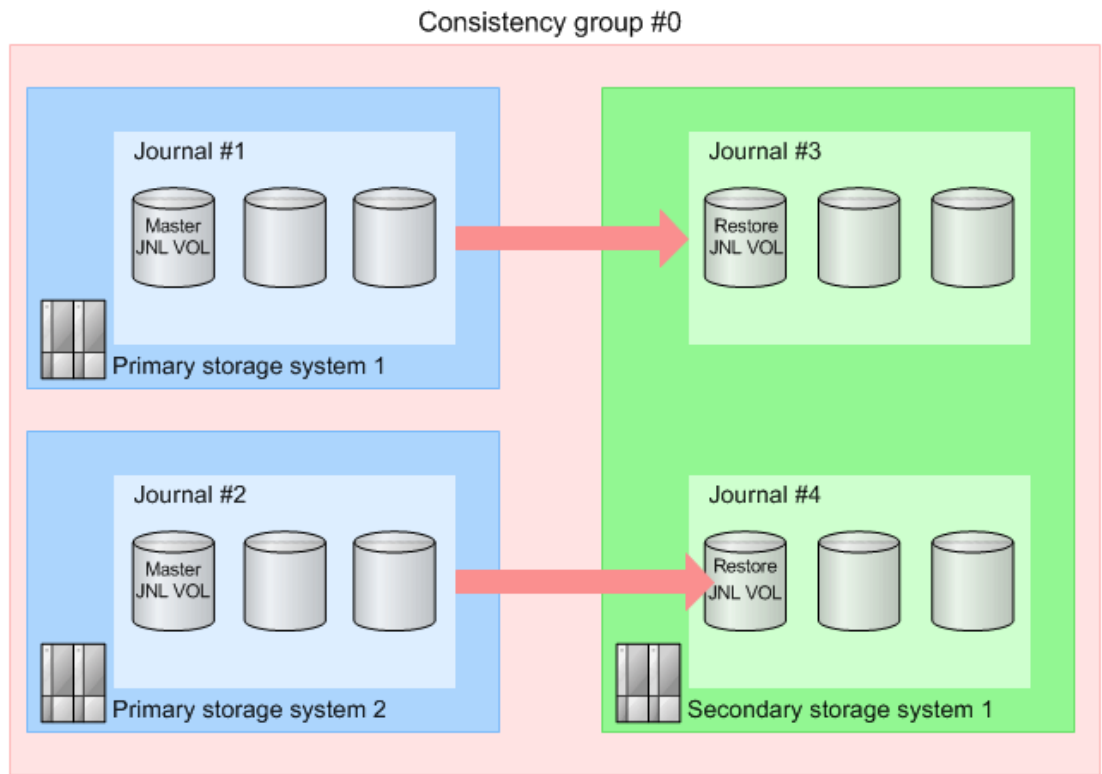

Figure 2 Configuration of a consistency group with multiple journals (2)

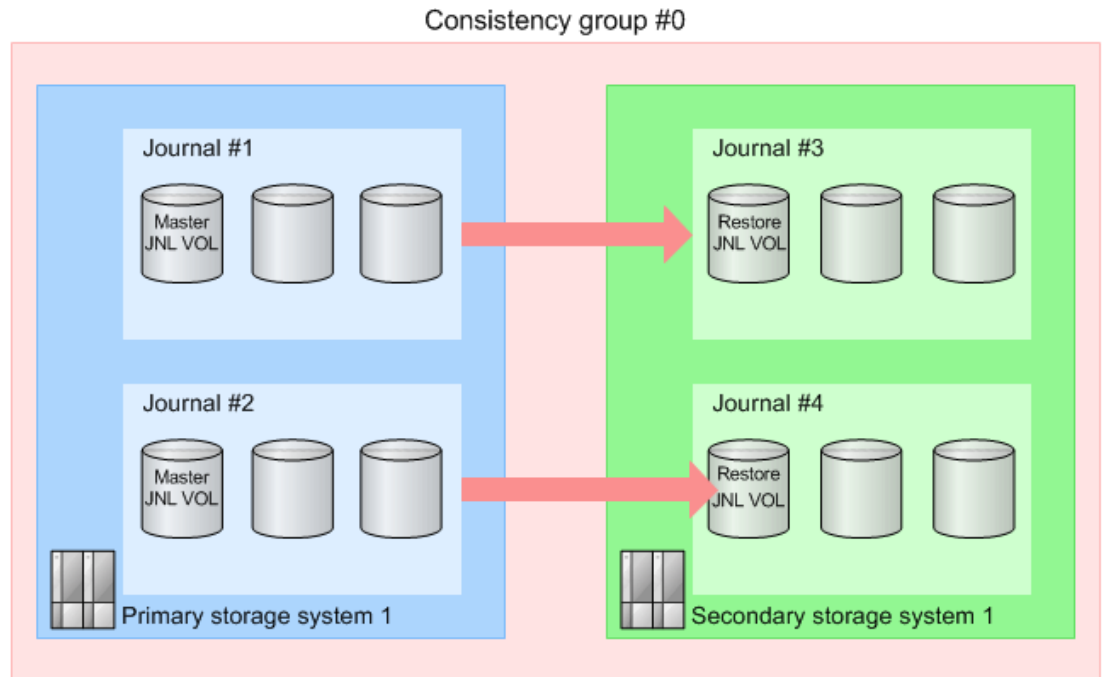

Figure 3 Configuration of a consistency group with multiple journals (3)

Preparing the storage systems for UR

Use the following guidelines to ensure that your storage systems are ready for UR:

- Identify the locations where your UR primary and secondary data volumes will be located, and then install and configure the storage systems.
- Make sure that the primary and secondary storage systems are configured for Device Manager - Storage Navigator operations.
For details, see the System Administrator Guide for your storage system.
- Make sure that primary and secondary storage systems are properly configured for UR operations, for example, cache memory considerations. See the entry for Cache and Nonvolatile Storage in the requirements table, [System requirements on page 44](#). Also consider the amount of Cache Residency Manager data to be stored in cache when determining the required amount of cache.
- Make sure that the required system option modes for your UR configuration have been set on the primary and secondary storage systems. For details, see [System option modes on page 83](#).
- Make sure that primary storage systems are configured to report sense information to the host. Secondary storage systems should also be attached to a host server to enable reporting of sense information in the event of a problem with an S-VOL or secondary storage system. If the secondary storage system is not attached to a host, it should be attached to a primary site host server so that monitoring can be performed.
- If power sequence control cables are used, set the power select switch for the cluster to LOCAL to prevent the primary storage system from being powered off by the host. Make sure the secondary storage system is not powered off during UR operations.
- Install the UR remote copy connections (Fibre Channel or iSCSI cables, switches, and so on) between the primary and secondary storage systems.
- When setting up data paths, distribute them between different storage clusters and switches to provide maximum flexibility and availability. The remote paths between the primary and secondary storage systems must be separate from the remote paths between the host and secondary storage system.

System option modes

To provide greater flexibility, the storage systems have additional operational parameters called system option modes (SOMs) that allow you to tailor the storage system to your unique operating requirements. The SOMs are set on the service processor (SVP) by your service representative. Review the SOMs for your storage system, and work with your service representative to ensure that the appropriate SOMs for your operational environment are configured on your storage system.

The following table lists and describes the SOMs that apply to Universal Replicator and Universal Replicator for Mainframe. For a complete list of SOMs, see the *System Administrator Guide* for your storage system.



Note: The SOM information might have changed since this document was published. Contact customer support for the latest SOM information.

Mode	Category	Description	Default	MCU/RCU
448	Universal Replicator Universal Replicator for Mainframe	When the SVP detects a blocked path: Mode 448 = ON: An error is assumed and the mirror is immediately suspended. Mode 448 = OFF (default): If the path does not recover within a specified period of time, an error is assumed and the mirror is suspended. Note: Mode 448 setting is available only when mode 449 is set to OFF.	OFF	-
449	Universal Replicator Universal Replicator for Mainframe	This mode is used to enable and disable detection of communication failures between the MCU and RCU. Mode 449 = ON (default): On the MCU side, checking read journal disruption from RCU is disabled, and monitoring read journal failures is disabled on the RCU side. Mode 449 = OFF: Detecting communication failures between the MCU and RCU is enabled. Notes: 1. This mode applies when disabling the detection of communication failures between the MCU and RCU in UR/URz configuration is required. 2. When this mode is set to ON, SOM 448 does not work. 3. This mode setting is not changed by microcode upgrade. 4. This mode is not effective for remote paths between an Initiator port on the MCU and a Target port on the RCU. 5. While a path from the RCU to MCU is disconnected, if the UR/URz pair remains in Suspending or Deleting status, recover it in accordance with the procedure in Recovery from UR/URz Failure in TROUBLE SHOOTING section of Maintenance Manual.	ON	MCU
466	Universal Replicator Universal Replicator for Mainframe	It is strongly recommended that the path between the primary and secondary storage systems have a minimum data transfer speed of 100 Mbps. If the data transfer speed falls to 10 Mbps or lower, UR operations cannot be properly processed. As a result, many retries occur and UR pairs might be suspended. This SOM is provided to ensure proper	OFF	-

Mode	Category	Description	Default	MCU/RCU
		<p>system operation for data transfer speeds of at least 10 Mbps.</p> <p>Mode 466 = ON: Data transfer speeds of 10 Mbps and higher are supported. The JNL read is performed with 4-multiplexed read size of 256 KB.</p> <p>Mode 466 = OFF (default): For conventional operations. Data transfer speeds of 100 Mbps and higher are supported. The JNL read is performed with 32-multiplexed read size of 1 MB by default.</p> <p>Note: The data transfer speed can be changed using the Change JNL Group options.</p>		
474	Universal Replicator Universal Replicator for Mainframe	<p>UR initial copy performance can be improved by issuing a command from CCI/Business Continuity Manager (BCM) to execute a dedicated script consisting of UR initial copy (Nocopy), UR suspend, TC Sync initial copy, TC Sync delete, and UR resync.</p> <p>Mode 474 = ON: For a suspended UR pair, a TC (Sync) pair can be created with the same P-VOL/S-VOL so that UR initial copy time can be reduced by using the dedicated script.</p> <p>Mode 474 = OFF (default): For a suspended UR pair, a TC (Sync) pair cannot be created with the same P-VOL/S-VOL. For this, the dedicated script cannot be used.</p> <p>If the P-VOL and S-VOL are both DP-VOLs, initial copy performance might not improve with SOM 474 set to ON. This is because with DP-VOLs, not all areas in a volume are allocated for UR; therefore not all areas in the P-VOL are copied to the S-VOL. With less than the full amount of data in the P-VOL being copied, the initial copy completes in a shorter time, which might not be improved with SOM 474.</p> <p>Notes:</p> <ol style="list-style-type: none"> Set this mode for both primary and secondary storage systems. When this mode is set to ON: <ul style="list-style-type: none"> Execute all pair operations from CCI/BCM. Use a dedicated script. Initial copy operation is prioritized over update I/O. Therefore, the processing speed of the update I/O slows down. If this mode is set to ON, the processing speed of update I/O slows down by about 15 μs per command, version downgrade is disabled, and Take Over is not available. If this mode is not set to ON for both sides, the behavior is as follows: <ul style="list-style-type: none"> OFF in primary and secondary storage systems: Normal UR initial copy performance. 	OFF	Both

Mode	Category	Description	Default	MCU/RCU
		<ul style="list-style-type: none"> ON in the primary storage system/OFF in the secondary storage system: TC Sync pair creation fails. OFF in the primary storage system/ON in the secondary storage system: The update data is copied to the S-VOL synchronously. <ol style="list-style-type: none"> While this mode is set to ON, make sure not to perform microcode downgrade to an unsupported version. While this mode is set to ON, make sure not to perform the Take Over function. This mode cannot be applied to a UR pair that is the second mirror in a URxUR multi-target configuration, URxUR cascade configuration, or 3DC multi-target or cascading configuration of three UR sites. If applied, TC pair creation is rejected with SSB=CBED output. Before setting SOM 474 to ON, make sure that SOM 1091 is set to OFF. If SOM 1091 is set to ON, set it to OFF first, and then set SOM 474 to ON. 		
506	Universal Replicator Universal Replicator for Mainframe	<p>This mode is used to enable Delta Resync with no host update I/O by copying only differential JNL instead of copying all data.</p> <p>The UR Delta Resync configuration is required.</p> <p>Mode 506 = ON:</p> <ul style="list-style-type: none"> Without update I/O: Delta Resync is enabled. With update I/O: Delta Resync is enabled. <p>Mode 506 = OFF (default):</p> <ul style="list-style-type: none"> Without update I/O: Total data copy of Delta Resync is performed. With update I/O: Delta Resync is enabled. <p>Note: Even when mode 506 is set to ON, the Delta Resync may fail and only the total data copy of the Delta Resync function is allowed if the necessary journal data does not exist on the primary storage system used for the Delta Resync operation.</p>	OFF	Both
690	Universal Replicator Universal Replicator for Mainframe	<p>This mode is used to prevent Read JNL or JNL Restore when the Write Pending rate on RCU exceeds 60% as follows:</p> <ul style="list-style-type: none"> When CLPR of JNL-Volume exceeds 60%, Read JNL is prevented. When CLPR of Data (secondary)-Volume exceeds 60%, JNL Restore is prevented. <p>Mode 690 = ON: Read JNL or JNL Restore is prevented when the Write Pending rate on RCU exceeds 60%.</p> <p>Mode 690 = OFF (default): Read JNL or JNL Restore is not prevented when the Write Pending rate on RCU exceeds 60% (the same as before).</p>	OFF	RCU

Mode	Category	Description	Default	MCU/RCU
		<p>Notes:</p> <ol style="list-style-type: none"> 1. This mode can be set online. 2. This mode should be set per customer's requests. 3. If the Write Pending status long keeps 60% or more on RCU, it takes extra time for the initial copy to be completed by making up for the prevented copy operation. 4. If the Write Pending status long keeps 60% or more on RCU, the pair status may become Suspend due to the JNL-Vol being full. 5. When USP/NSC is used on P-VOL side, the mode cannot be used. If the mode is set to ON, SSB=8E08 on P-VOL side and SSB=C8D1 on S-VOL side may frequently be output. 		
769	<p>TrueCopy</p> <p>TrueCopy for Mainframe</p> <p>Universal Replicator</p> <p>Universal Replicator for Mainframe</p>	<p>This mode applies only to VSP G1x00 and VSP F1500.</p> <p>Controls whether the retry operation is executed or not when a path creation operation is executed. (The function applies to both of CU FREE path and CU single path for Open and Mainframe).</p> <p>Mode 769 = ON: The retry operation is disabled when the path creation operation is executed (retry operation is not executed).</p> <p>Mode 769 = OFF (default): The retry operation is enabled when the path creation operation is executed (retry operation is executed).</p> <p>Notes:</p> <ol style="list-style-type: none"> 1. Apply this mode when the following three conditions are met: <ul style="list-style-type: none"> • SOM 114 is set to OFF (operation of automatically switching the port is disabled). • HMO 49 and HMO 50 are set to OFF (60-07-51-00/00 and later, 70-02-31-00/00 and later). • TPC-R or CSM is used (it is not applied in normal operation). 2. When SOM 769 is set to ON, SOM 114, HMO 49 and HMO 50 must not be set to ON. 3. In either of the following cases, the path creation operation might fail after automatic port switching is executed. <ul style="list-style-type: none"> • SOM 114 is set to ON. • HMO 49 and HMO 50 are set to ON. 	OFF	Both
908	<p>Universal Replicator</p> <p>Universal Replicator for Mainframe</p>	<p>This mode can change CM capacity allocated to MPBs with different workloads.</p> <p>Mode 908 = ON: The difference in CM allocation capacity among MPBs with different workload is large.</p>	OFF	Both

Mode	Category	Description	Default	MCU/RCU
		<p>Mode 908 = OFF (default): The difference in CM allocation capacity among MPBs with different workload is small (existing operation) .</p> <p>Notes:</p> <ol style="list-style-type: none"> 1. If a CLPR is used by only some MPBs among all the installed MPBs, set the mode to ON for the CLPR to increase CM capacity allocated to the MPBs that use the CLPR. Example: (a) A CLPR only for UR JNLG. (b) A configuration where MPBs and CLPRs are separately used for Open and Mainframe systems. 2. Since CM capacity allocated to MPBs with low load is small, the performance is affected by a sudden increase in load. 3. SOM 908 cannot be used with SOM 933. When SOM 933 is set to ON, the function of SOM 908 is canceled even though SOM 908 is ON. 4. This mode is effective for a CLPR. Therefore, when setting the mode to ON/OFF, select target "LPRXX (XX=00 to 31)". For example, even when CLPR0 is defined (any of CLPR1 to 31 are not defined), select "LPR00" first and then set the mode to ON/OFF. 		
1015	Universal Replicator Universal Replicator for Mainframe	<p>When a delta resync is performed in a 3DC multi-target configuration with TC and UR, this mode is used to change the pair status to PAIR/Duplex directly and then complete the delta resync. If the delta resync fails and all differential data items are copied, the pair status changes to COPY/Pending regardless of the SOM 1015 setting, and then it changes to PAIR/Duplex.</p> <p>When the existing delta resync function is required (pair status changes to COPY/Pending and then to PAIR/Duplex), set this mode to ON before performing delta resync. If SOM 1015 is set (ON or OFF) while delta resync is being performed, the setting is not applied.</p> <p>Mode 1015 = ON: The pair status changes to COPY/Pending and then to PAIR/Duplex when a delta resync is performed in a 3DC multi-target configuration.</p> <p>Mode 1015 = OFF (default): The pair status changes directly to PAIR/Duplex when a delta resync is performed in a 3DC multi-target configuration.</p> <p>Notes:</p> <ol style="list-style-type: none"> 1. The pair status changes directly to PAIR/Duplex when this mode is OFF (default). Set this mode to ON only when the status change 	OFF	MCU

Mode	Category	Description	Default	MCU/RCU
		<p>to COPY/Pending and then PAIR/Duplex is required.</p> <ol style="list-style-type: none"> 2. Set this mode on the site of TC S-VOL in TC-UR 3DC configuration. If site switch by delta resync might occur, set this mode on both TC primary and secondary sites. 3. For microcode versions and storage system models that do not support this mode, even if this mode is set to OFF on L site of TC-UR delta configuration, the behavior does not change but the status changes to COPY/Pending and then the delta resync is completed. 4. Regardless of the remote command device setting, the copy status does not change to COPY/Pending and then the delta resync is completed. 5. If a delta resync fails, all-data copy works. In this case, the pair status changes to COPY/Pending and then the delta resync is completed even when this mode is set to OFF. 6. When this mode setting is default (OFF), a delta resync operation is completed without pair status change to COPY/Pending. Therefore, if an operation depends on the pair status changing to COPY/Pending, such as running the CCI pairevtwait command, set this mode to ON. 7. When this mode setting is default (OFF) (pair status changes directly to PAIR/Duplex), SIMs and SSBs that are reported due to a pair status change to COPY/Pending are not reported. 8. If this mode is set to ON or OFF during delta resync, the setting is not applied. Change this mode setting before delta resync. 9. During delta resync, downgrading the microcode to a version that does not support this mode is disabled in TC-UR delta configuration. If microcode downgrade is disabled (FunctionID:0701) when delta resync is not in process, suspend the UR pair and then retry the microcode replacement. 		
1043	Universal Replicator Universal Replicator for Mainframe	<p>This mode disables journal copy.</p> <p>Mode 1043 = ON: When one of the following conditions is met at the UR secondary site, the journal copy is disabled.</p> <p>(a) Write Pending rate of MP blade for which journal ownership is defined is 25% or higher.</p> <p>(b) Initiator operating rate of MP blade for which journal ownership is defined is 40% or higher.</p> <p>Mode 1043 = OFF (default): The journal copy is not disabled.</p>	OFF	Both

Mode	Category	Description	Default	MCU/RCU
		<p>Notes:</p> <ol style="list-style-type: none"> This mode applies when (a) and (b), or (a) and (c) are met. (a) Usage of journal volume in the UR secondary site is high. (b) The configuration contains multiple primary and secondary sites. (c) A consistency group configuration contains both open and mainframe hosts. If SOM 690 is set to ON and the Write Pending rate is 60% or higher, the journal copy is disabled regardless of the setting of this mode. When the host write speed is faster than the JNL copy speed, the usage rate of the master journal increases. This mode is effective within the range of each CLPR. Therefore, an operation target LPRxx (xx= 00 to 31) needs to be selected before setting this mode to ON/OFF. For example, when setting this mode only to CLPR0 (even though the mode is not set to CLPR 1 to 31), select "LPR00" and then set this mode to ON/OFF. If "System" is selected and then this mode is set to ON, this mode is not effective for any of the CLPRs. 		
1050	Global-active device TrueCopy TrueCopy for Mainframe Universal Replicator Universal Replicator for Mainframe	<p>This mode applies only to VSP G1x00 and VSP F1500.</p> <p>This mode enables creation of pairs using user capacity in excess of 1.8 PB per system by managing differential BMP in hierarchical memory for pair volumes whose capacity is 4 TB (open) or 262,668 cyl (mainframe) or less.</p> <p>Mode 1050 = ON: For pair volumes of 4 TB (open)/262,668 cyl (mainframe) or less, differential BMP is managed in hierarchical memory that performs caching to CM/PM using HDD as a master and enables creation of pairs using user capacity in excess of 1.8 PB per system.</p> <p>For microcode 80-02-4x and later, you should use hierarchical memory for all remote copy pairs. Using SOMs 1050 and 1058 enables the use of hierarchical memory for volumes of 4 TB or less, which increases the total amount of replicated capacity above 1.8 PB.</p> <p>WARNING: If you allocate more than 1.8 PB of replicated capacity for volumes of 4 TB or less and then later want to return to using shared memory, you will have to delete some pairs to reduce the total replicated capacity for volumes of 4 TB or less to below 1.8 PB.</p>	OFF	Both

Mode	Category	Description	Default	MCU/RCU
		<p>Mode 1050= OFF (default): For pair volumes of 4 TB (open)/262,668 cyl (mainframe) or less, differential BMP is managed in SM as usual so that the user capacity to create pairs is limited to 1.8 PB per system. Also, differential MPB management can be switched from the hierarchical memory to SM by performing a resync operation for pairs whose volume capacity is 4 TB (open)/ 262,668 cyl (mainframe) or less.</p> <p>Notes:</p> <ol style="list-style-type: none"> 1. This mode is related to SOM 1058. 2. The hierarchical memory is used for volumes over 4 TB (open)/262,668 cyl (mainframe) even when the mode is set to OFF. 3. When the mode is turned OFF after operating with the mode set to ON, if resynchronizing pairs whose volume capacity is 4 TB (open)/ 262,668 cyl (mainframe) or less managed in the hierarchical memory, the pair resync operation might fail due to lack of the SM capacity. 4. If a pair resync operation fails, the pairs exceeding 1.8 PB of user capacity need to be deleted. 5. Open non-DP-VOLs do not support hierarchical memory differential management so that the mode cannot be applied. 6. To downgrade the microcode, the procedure described in Maintenance Manual (Function ID 01:03 described in 03 MICRO-FC) is required. Refer to the manual before applying the mode. 7. Apply this mode when you want to create pairs using user capacity exceeding 1.8 PB per system. 8. Depending on the I/O pattern, I/O response might be affected. 9. Depending on the condition, initial copy time might be affected. 10. The differential BMP managed in hierarchical memory does not use the shared memory, but the differential data is managed in a pool with which the volumes are associated. For the pool capacity necessary for the differential data management, refer to the "Differential data" section in the user guide. 11. Before using this SOM to increase pair volumes on the storage system, check the resources on the storage system to make sure all performance requirements are met. 		
1058	Global-active device	This mode applies only to VSP G1x00 and VSP F1500.	OFF	Both
	TrueCopy	This mode can change differential BMP management from SM to hierarchical memory so		

Mode	Category	Description	Default	MCU/RCU
	TrueCopy for Mainframe Universal Replicator Universal Replicator for Mainframe	<p>that the number of pairs to be created on a system and user capacity used for pairs increase.</p> <ul style="list-style-type: none"> For mainframe systems, all pairs can be managed in hierarchical memory so that pairs can be created by all LDEVs. For open systems, pairs that can only be managed in SM use SM so that the number of pairs that can be created using non-DP-VOLs increases. <p>Mode 1058 = ON:</p> <p>When SOM 1050 is ON:</p> <ul style="list-style-type: none"> By resynchronizing mainframe VOLs of 262,668 cyl or less, the differential BMP management is switched from SM to hierarchical memory. Hierarchical memory management remains as is. By resynchronizing open VOLs (DP-VOLs only) of 4 TB or less, the differential BMP management is switched from SM to hierarchical memory. Hierarchical memory management remains as is. <p>When SOM 1050 is OFF:</p> <ul style="list-style-type: none"> By resynchronizing mainframe VOLs of 262,668 cyl or less, the differential BMP management is switched from hierarchical memory to SM. SM management remains as is. By resynchronizing open VOLs (DP-VOLs only) of 4 TB or less, the differential BMP management is switched from hierarchical memory to SM. SM management remains as is. <p>Mode 1058 = OFF (default):</p> <p>When SOM 1050 is ON: The differential BMP management does not change by resynchronizing pairs.</p> <p>When SOM 1050 is OFF:</p> <ul style="list-style-type: none"> By resynchronizing mainframe VOLs of 262,668 cyl or less, the differential BMP management is switched from hierarchical memory to SM. SM management remains as is. By resynchronizing open VOLs (DP-VOLs only) of 4 TB or less, the differential BMP management is switched from hierarchical memory to SM. SM management remains as is. <p>For microcode 80-02-4x and later, you should use hierarchical memory for all remote copy pairs. Using SOMs 1050 and 1058 enables the use of hierarchical memory for volumes of 4 TB or less, which increases the total amount of replicated capacity above 1.8 PB.</p>		

Mode	Category	Description	Default	MCU/RCU
		<p>WARNING: If you allocate more than 1.8 PB of replicated capacity for volumes of 4 TB or less and then later want to return to using shared memory, you will have to delete some pairs to reduce the total replicated capacity for volumes of 4 TB or less to below 1.8 PB.</p> <p>Notes:</p> <ol style="list-style-type: none"> 1. Depending on the I/O pattern, I/O response might be affected. 2. Depending on the condition, initial copy time might be affected. 3. The mode is related to SOM1050. 4. Open non-DP-VOLs do not support hierarchical memory differential management so that the mode cannot be applied. 5. To downgrade the microcode, the procedure described in Maintenance Manual Function ID 01:03 described in 03 MICRO-FC. is required. Refer to the manual before applying the mode. 6. This mode is applied when increasing the number of pairs that can be created on a system or the user capacity for pairs is desired. 7. The differential BMP managed in hierarchical memory does not use the shared memory, but the differential data is managed in a pool with which the volumes are associated. For the pool capacity necessary for the differential data management, refer to "Differential data" in the manuals for TC, UR, and GAD. Before using this SOM to increase pair volumes on the storage system, reexamine the resource on the storage system to make sure all performance requirements are met. 8. Before using this SOM to increase pair volumes on the storage system, re-examine the resource on the storage system to make sure all performance requirements are met. 		
1067	Universal Replicator Universal Replicator for Mainframe	<p>This mode is used to enable microcode downgrade to a version that does not support URxUR (including delta).</p> <p>Mode 1067 = ON: Even when a UR pair has been registered, downgrading the microcode to a version that does not support URxUR (including delta) is allowed.</p> <p>Mode 1067 = OFF (default): If any UR pair has been registered, downgrading the microcode to a version that does not support URxUR (including delta) is not allowed.</p> <p>Notes:</p> <ol style="list-style-type: none"> 1. This mode is applied to enable microcode downgrade to a version that does not support 	OFF	Both

Mode	Category	Description	Default	MCU/RCU
		<p>URxUR (including delta) if the configuration where any UR pair has been registered is not URxUR (including delta).</p> <ol style="list-style-type: none"> Setting the mode to ON allows microcode downgrade at sites where only 1 mirror is used in URxUR multi-target configuration without delta resync and cascade configuration (L or R site in multi-target, and P or R site in cascade), but the following phenomena occur after microcode downgrade. Make sure that the target storage system does not contain pairs of URxUR configuration. Phenomena: <ol style="list-style-type: none"> When the microcode is downgraded at S site (local or remote) in multi-target configuration, the pair between P site and the target S site cannot be resynchronized. When the pair between I site and R site in cascade configuration is resynchronized, the pair status cannot change from COPY to PAIR. When the microcode is downgraded at R site in cascade configuration, the pair between I site and R site cannot be resynchronized. 		
1096	<p>Universal Replicator</p> <p>Universal Replicator for Mainframe</p>	<p>This mode applies only to VSP G1x00 and VSP F1500.</p> <p>This mode disables read-journal frequency reduction.</p> <p>Mode 1096 = ON: The read-journal frequency reduction does not work.</p> <p>Mode 1096 = OFF (default): The read-journal frequency reduction works.</p> <p>Notes:</p> <ol style="list-style-type: none"> This mode is applied when a significant delay, which is about 200 msec or longer, occurs in the line between MCU and RCU. When the mode is set to ON while round-trip delay time is small (about less than 20 msec), the usage rate of RCU Initiator increases by 10% x the number of journals. Even though the mode is supposed to be applied to UR RCU, apply it to both MCU and RCU on the premise of DR operation. The mode is effective for each CLPR, so that select the operation target LPRxx (xx=00 to 31), and then set the mode to ON/OFF. For example, when only CLPR0 is defined (CLPR1 to 31 are not defined), select LPR00 and then set the mode to ON/OFF. The mode is not 	OFF	Both

Mode	Category	Description	Default	MCU/RCU
		effective for any CLPRs if "System" is selected even when the mode is set to ON.		

Planning the data path

This chapter provides instructions for calculating bandwidth and designing the data path network.

- [Data path design](#)
- [Sizing bandwidth](#)
- [Planning ports for data transfer](#)
- [Supported data path configurations](#)

Data path design

The data path network must be designed to manage your organization's throughput to the secondary site. You must determine the bandwidth, number of ports, and Fibre Channel or iSCSI data path configuration that will ensure the update data arrives at the secondary site in a time consistent with your organization's RPO.

To set up a data path, you must establish the following:

- The amount of bandwidth required to move the data generated by your host applications under all I/O conditions. See [Sizing bandwidth on page 98](#).
- The number of ports that can send and receive data. See [Planning ports for data transfer on page 104](#).
- The types of cables and number of switches required for your network. See [Fibre Channel data path requirements on page 107](#).
- The data path configuration that works best for your sites. See [Supported data path configurations on page 105](#).



Note:

- Before replacing a data path (Fibre Channel or iSCSI), first delete the pairs and delete the remote paths that use the data path to be replaced, and then replace the data path. Do not replace a data path that is being used for remote copy operations.
 - Use the same protocol for data paths between a host and a storage system and between primary and secondary storage systems. When different protocols are used in the data paths (for example, Fibre Channel data paths between the host and storage system and iSCSI data paths between the storage systems), make sure the timeout period for commands between the host and the storage system is equal to or greater than the timeout period for commands between the storage systems.
-

Sizing bandwidth

Bandwidth is determined based on the amount of data to be transferred from the primary storage system to the secondary storage system within a certain amount of time.

If the data path network cannot handle the flow of update data, the data is saved in the journal until additional bandwidth capacity becomes available. If the journal also cannot handle the amount of update data, the integrity of the pair is lost, and a differential resync copy operation must be performed.

While it can be costly to increase bandwidth, increasing the capacity of a journal volume is relatively inexpensive. However, the difference between the primary and secondary volumes increases as more update data accumulates

in the journal. Therefore, sizing bandwidth often involves a trade-off between expense and keeping the data currency of the secondary volumes within your RPO goals.

Five sizing strategies

Refer to the following typical sizing strategies as you determine an approach to sizing bandwidth. This is not a complete list of sizing strategies, and your approach might combine several strategies.

- **Size bandwidth to peak workload:** This approach results in the smallest difference between the data in the P-VOL and S-VOL. Identify peak workload on the production volumes, and then add extra capacity to accommodate packet loss and protocol overhead. RPO is at or near zero when bandwidth is sized to peak workload.
- **Size bandwidth to peak workload rolling average:** The rolling average is less than peak but more than average. This guarantees that at some point data will accumulate in the journal, but most of the time it will not. Your system can afford to journal for the planned amount of time and still maintain RPO.
- **Size bandwidth to typical workload:** When bandwidth is sized to typical write-workload and an extended peak workload is experienced, excess write-data is written to journal. This excess data is delayed for subsequent transmission to the secondary site until network capacity becomes available. The amount of differential data is proportional to the amplitude and duration of the workload surge.
- **Size bandwidth to average or mean workload:** If you cannot determine a typical workload, sizing should be to the average or mean workload with a small compensation for network overhead. In this scenario, excess data in the journals will be completely emptied to the S-VOL only occasionally. If bandwidth is sized below average write-workload, the journals never fully drain and eventually overflow.
- **Alternate pair status between suspend and resync:** You can size bandwidth and journal size for cases such as data migration in which data consistency is not required. In this strategy, you can alternate the pair status between suspend and resync in order to process point-in-time copies in batches. When pairs are suspended, journals are not used to queue write operations. Instead, a bitmap is used to track the changed cylinders on the disks. For access patterns that favor multiple writes to a relatively small region of disk, this technique can provide especially efficient transfer of data: multiple writes to one region are not sent each and every time, and only the last update before resync is sent. The disadvantage of this strategy is that it does not guarantee I/O consistency on the secondary storage system until the resync is complete.

Calculating bandwidth

To determine bandwidth for Universal Replicator, write-workload must be measured. Production system workload data is collected using performance monitoring software. See [Measuring write-workload on page 65](#).

When you have collected write-workload data, size your bandwidth according to your sizing strategy. In the following procedures, bandwidth is sized for peak and peak rolling average write-workload.

Sizing bandwidth for peak write-workload

Procedure

1. Make sure that write-workload data is imported into a spreadsheet tool. Column C in the following figure shows an example of collected raw data over 10-minute segments.

	A	B	C	D	E	F	G	H
	Sample #	Time - 10 min. segments	Raw Data - MB/sec collected per 10 min. segment	30 Min Rolling Ave	60 Min Rolling Ave	24 Hour Rolling Avg		Raw Data Project Growth
1								
2								15.00%
3	1	0:00	0.863					0.992
4	2	0:10	2.81					3.232
5	3	0:20	0.858		1.24	2.17		0.987
6	4	0:30	0.45		1.56	2.17		0.518
7	5	0:40	0.813		1.36	2.17		0.935
8	6	0:50	1.63		1.56	2.17		1.875
9	7	1:00	2.81		2.24	2.17		3.232
10	8	1:10	1.58		2.30	2.18		1.817
11	9	1:20	2.05		2.36	2.18		2.358
12	10	1:30	4.57		2.48	2.17		5.256
13	11	1:40	1.13		2.66	2.17		1.300
14	12	1:50	2		2.72	2.16		2.300
15	13	2:00	3.56		2.30	2.16		4.094
16	14	2:10	2.64		2.26	2.19		3.036
17	15	2:20	2.39		2.34	2.19		2.749
18	16	2:30	2.06		2.17	2.18		2.369

2. Locate the highest peak. Based on your write-workload measurements, this is the greatest amount of data transferred during the collection period. It indicates the base amount of data that your bandwidth must be able to handle for near 0 RPO.

Though the highest peak is used for determining bandwidth, you should take notice of extremely high peaks. In some cases a batch job,

defragmentation, or other process could be driving workload to abnormally high levels. It is sometimes worthwhile to review the processes that are running. After careful analysis, it might be possible to lower or even eliminate some spikes by optimizing or streamlining high-workload processes. Changing the timing of a process can lower workload.

3. With a base bandwidth value established, make adjustments for growth and a safety factor.
 - Projected growth rate accounts for the increase expected in write-workload over a 1, 2, or 3 year period.
 - A safety factor adds extra bandwidth for unusually high spikes that did not occur during write-workload measurement but could.

Sizing bandwidth for peak rolling average write-workload

Procedure

1. Using write-workload data imported into a spreadsheet and your RPO, calculate write rolling-averages.

For example, if RPO time is 1 hour, then 60-minute rolling averages are calculated. Do this by arranging the values in six 10-minute intervals, as follows:

- a. In cell E4 type, `=average(b2:b7)`, and press Enter. (Most spreadsheet tools have an average function.)

This instructs the tool to calculate the average value in cells B2 through B7 (six 10-minute intervals) and populate cell E4 with that data. (The calculations used here are for example purposes only. Base your calculations on your RPO.)

- b. Copy the value that displays in E4.
- c. Highlight cells E5 to the last E cell of workload data in the spreadsheet.
- d. Right-click the highlighted cells and select the Paste option.

Excel maintains the logic and increments the formula values initially entered in E4. It then calculates all of the 60-minute averages for every 10-minute increment, and populates the E cells, as shown in the following example. For comparison, 24-hour rolling averages are also shown.

	A	B	C	D	E	F	G	H
	Sample #	Time - 10 min. segments	Raw Data - MB/sec collected per 10 min. segment	30 Min Rolling Ave	60 Min Rolling Ave	24 Hour Rolling Avg		Raw Data Project Growth
1								
2								15.00%
3	1	0:00	0.863					0.992
4	2	0:10	2.81					3.232
5	3	0:20	0.858		1.24	2.17		0.987
6	4	0:30	0.45		1.56	2.17		0.518
7	5	0:40	0.813		1.36	2.17		0.935
8	6	0:50	1.63		1.56	2.17		1.875
9	7	1:00	2.81		2.24	2.17		3.232
10	8	1:10	1.58		2.30	2.18		1.817
11	9	1:20	2.05		2.36	2.18		2.358
12	10	1:30	4.57		2.48	2.17		5.256
13	11	1:40	1.13		2.66	2.17		1.300
14	12	1:50	2		2.72	2.16		2.300
15	13	2:00	3.56		2.30	2.16		4.094
16	14	2:10	2.64		2.26	2.19		3.036
17	15	2:20	2.39		2.34	2.19		2.749
18	16	2:30	2.06		2.17	2.18		2.369

For another perspective, you can use 60-minute rolling averages graphed over raw data, as shown in the following figure.

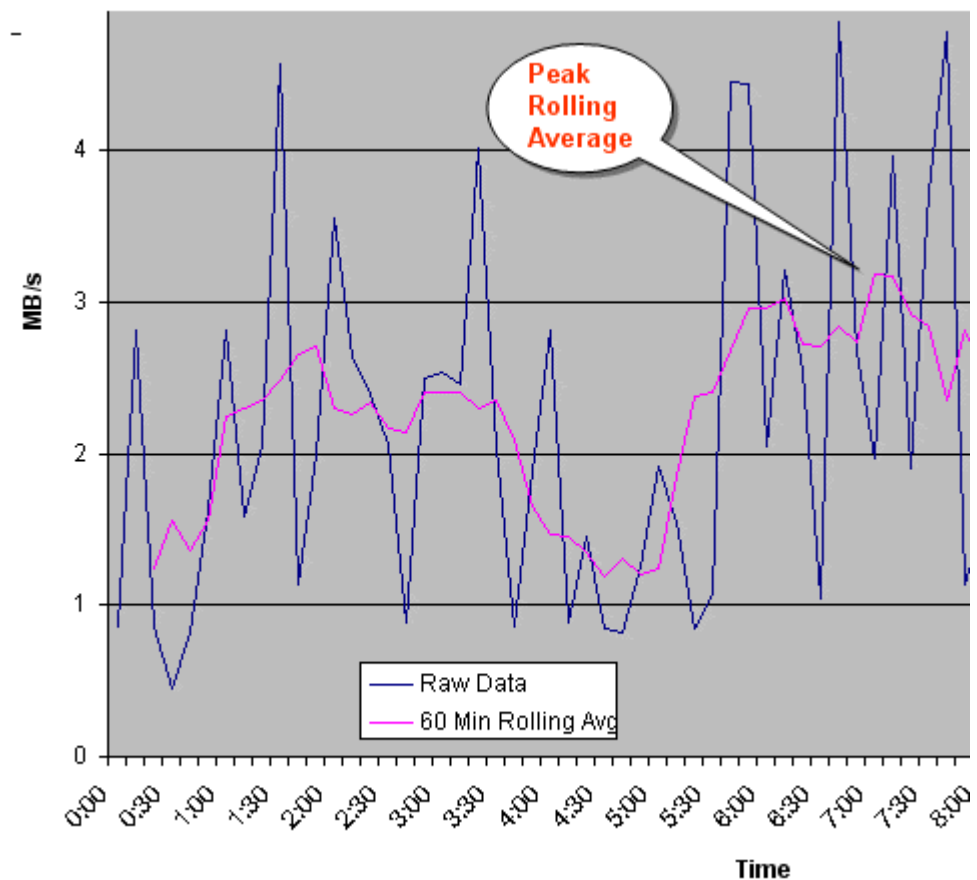

2. From the spreadsheet or graph, locate the largest or highest rolling average value. This is the peak rolling average, which indicates the base amount of data that your bandwidth must be able to handle.
3. With a base bandwidth value established, make adjustments for growth and a safety factor.
 - Projected growth rate accounts for the increase expected in write-workload over a 1, 2, or 3 year period.
 - A safety factor adds extra bandwidth for unusually high spikes that did not occur during write-workload measurement but could.

Other factors that must be taken into consideration because of their effect on bandwidth are latency and packet loss, as described in the following topics.

Latency

Network latency affects replication. It is the amount of data that can be present in the data path. In the event of network failure, a certain number of transmitted records will not yet be resident in the secondary storage system's journal, because they are still in-route within the data path. During periods of low workload, there might be no records in the path, but during periods of heavy workload, the network might be fully used. This amount represents the

minimum difference between data in the primary and secondary storage systems.

Packet loss

Packet losses have the effect of reducing overall bandwidth because lost packets must be re-transmitted, which consumes network capacity that would otherwise be occupied by new data traffic. Also, a network can elongate consistency time, since journals are not applied until a contiguous sequence of records has arrived at the secondary site.

Planning ports for data transfer

When new data exists in the P-VOL, the data is transferred through initiator ports and RCU target ports at the primary and secondary systems.

The operation commands (that is, for pair creation, and resynchronization) are sent from primary site initiator ports to secondary site RCU target ports.

For initial or update copy, the secondary site initiator port sends the `read-journal` command to the primary site RCU target port. The data is then sent through these ports, that is, from primary site RCU target ports to secondary site RCU initiator ports.

Note the following:

- An initiator port in one system must be connected to an RCU target port in the other system.
- Two or more initiator ports must be configured before you can create the UR relationship with the secondary storage system and create pairs. (VSP G1000, G1500, and VSP F1500)
- The amount of data that each port can transmit is limited. Therefore, it is critical to know the amount of data that will be transferred during peak periods. This knowledge will ensure that you can set up a sufficient number of ports as initiator and RCU target ports in order to handle all workloads.
- If your UR system supports a disaster recovery failover/failback environment, the same number of initiator and RCU target ports should be configured on primary and secondary storage systems to enable replication from the secondary site to primary site in a failover scenario.
- Up to eight paths can be established in both directions. It is recommended that you establish at least two independent data paths to provide hardware redundancy.

Example configuration

- Two initiator ports on the primary storage system, with two matching RCU target ports on the secondary storage system.
- Four initiator ports on the secondary storage system, with four matching RCU target ports on the primary storage system.

Port types (VSP G1000, G1500, and VSP F1500)

The primary and secondary storage systems require both initiator and RCU target ports. Both systems send and receive traffic during active replication.

- The initiator port on the primary side is connected to the RCU target port on the secondary side.
- The initiator port on the secondary side is connected to the RCU target port on the primary side.

Ports are designated as target ports by default. When you determine the number of initiator ports and RCU target ports your UR system requires, you change port attributes from target to initiator and RCU target.

The Fibre Channel and iSCSI ports can have the following attributes:

- Initiator port: Sends UR commands (that is, **operation** command or **read-journal** command) to the paired storage systems. For the secondary site, the port receives journal data from the primary site. Initiator ports must be configured on both primary and secondary storage systems for pair operations.
- RCU Target port: RCU Target ports on the primary site receive the **read-journal** command from the secondary site and send UR journal data to the secondary site. RCU target ports must be configured on both primary and secondary storage systems for pair operations.
- Target port: Connects the storage system and an open-systems host. When the host issues a write request, the request is sent through a target port to a volume on the system. Target ports must be configured on primary storage systems for UR operations.
- External port: Required for Universal Volume Manager copy operations. This port is not used for UR copy operations. This port can be changed to a target, initiator, or RCU target port.

Supported data path configurations

The data path can be configured using one of the following connection types. For a switch connection, you must set the port to Fabric on, Point-to-Point (F-port).



Note: Create at least two independent data paths (one per cluster) between the primary storage system and the secondary storage system for hardware redundancy for this critical element.

Direct connection

A direct connection (loop only) is a direct link between the primary and secondary arrays. NL-port (Node Loop) connections are supported for the data path and host-to-system path.

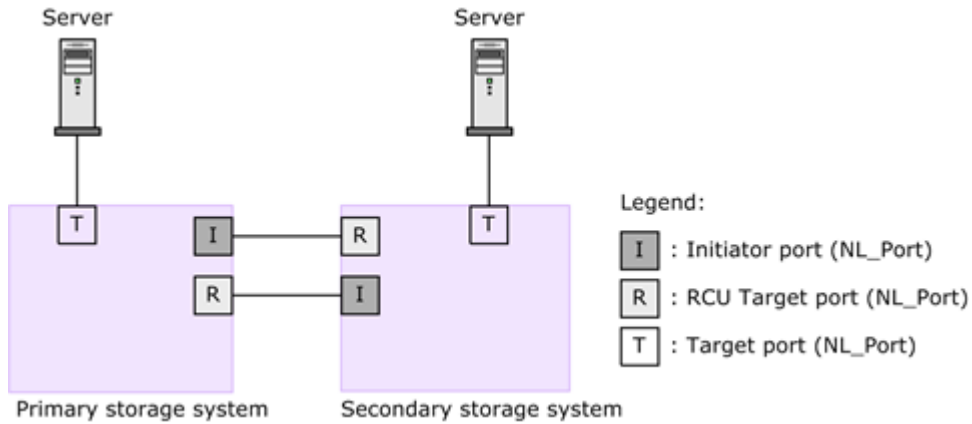

- Set the Fabric to OFF for the initiator port and the RCU target port.
- Set the topology to FC-AL.

Switch connection

Switch connections push data from the local switch through a Fibre Channel link across a WAN to the remote switch and Fibre Channel of the secondary storage system. F-port (point-to-point) and FL-port (loop) switch connections are supported.

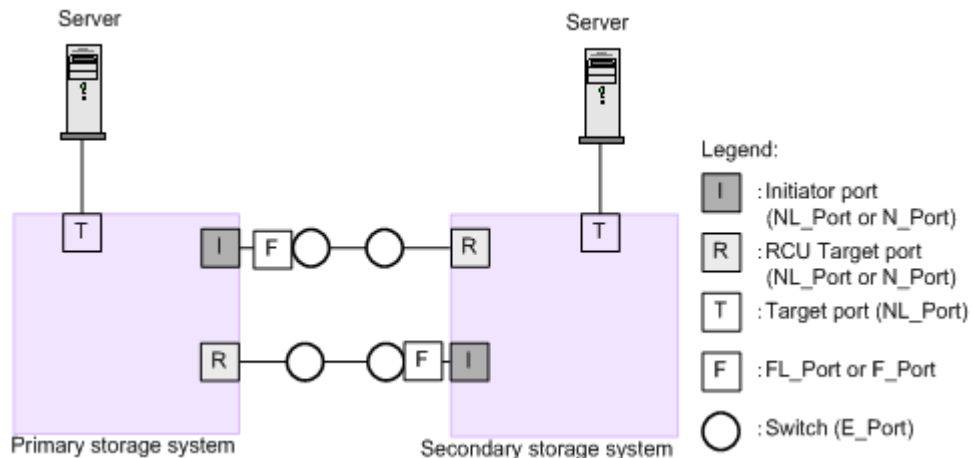

- Set the Fabric to ON for the initiator port and the RCU target port.
- Set the topology to Point-to-Point.

Switches from some vendors, McData ED5000 for example, require an F-port.

Extender connection

Make sure that the extender supports remote I/O. Contact customer support for details.

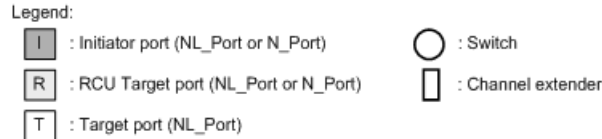
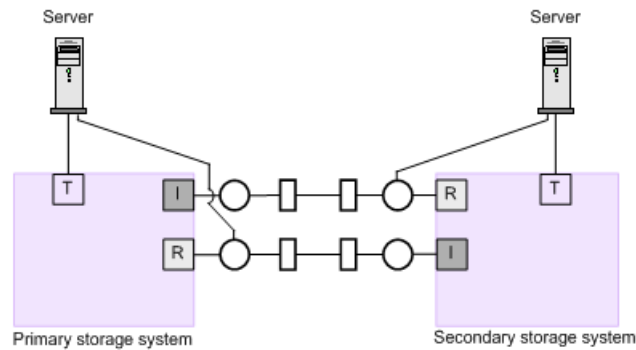

- Set the Fabric to ON for the initiator port and the RCU target port.
- Set the topology to Point-to-Point.

Note: When the primary and secondary storage systems are connected using switches with a channel extender, and multiple data paths are configured, the capacity of data to be transmitted might concentrate on particular switches, depending on the configuration and the settings of switch routing. For more information contact customer support.

Fibre Channel data path requirements

Multimode or single-mode optical fiber cables are required on primary and secondary storage systems. The type of cable and number of switches depends on the distance between primary and secondary sites, as specified in the following table.

Distance	Cable type	Data path relay
0 km to 1.5 km (4,920 feet)	Multimode shortwave Fibre Channel interface cables.	Switch is required between 0.5 km to 1.5 km.
1.5 km to 10 km (6.2 miles)	Single-mode longwave optical fibre cables.*	Not required.
10 km to 30 km (18.6 miles)	Single-mode longwave optical fibre cables.*	Switch is required.
Greater than 30 km (18.6 miles)	Communications lines are required.	Approved third-party channel extender products.
* Longwave cannot be used for FCoE.		

Link speed determines the maximum distance you can transfer data and still achieve good performance. The following table shows maximum distances at which performance is maintained per link speed over single-mode longwave Fibre Channel.

Link speed	Distance maximum performance maintained
1 Gbps	10 km
2 Gbps	6 km
4 Gbps	3 km
8 Gbps	2 km
16 Gbps	1 km
32 Gbps (VSP Gx00 models and VSP Fx00 models)	0.6 km

This information is illustrated in the graphic in [Additional switches on page 108](#). Note that the type of cable determines the type of SFP used for the port. Longwave cables must be connected to longwave SFPs in the storage system and switch. Shortwave cables must be connected to shortwave SFPs in the storage system and switch. The default fiber channel SFP type is shortwave.

Additional switches

When the initiator port on the primary storage system sends data to the secondary storage system, the Fibre Channel protocol accommodates a certain number of un-acknowledged frames before the sender must stop sending. These are known as buffer credits. As Fibre Channel frames are sent out, available buffer credits are exhausted. As acknowledgments come back, the supply of buffer credits is replenished. Because it takes longer for acknowledgments to return as distance increases, exhausting the supply of buffer credits becomes increasingly likely as distance increases.

Adding Fibre Channel switches on either end of the replication network provides the additional credits necessary to overcome buffer shortages due to the network latency.

The following figure shows data path types, switches, and distances.

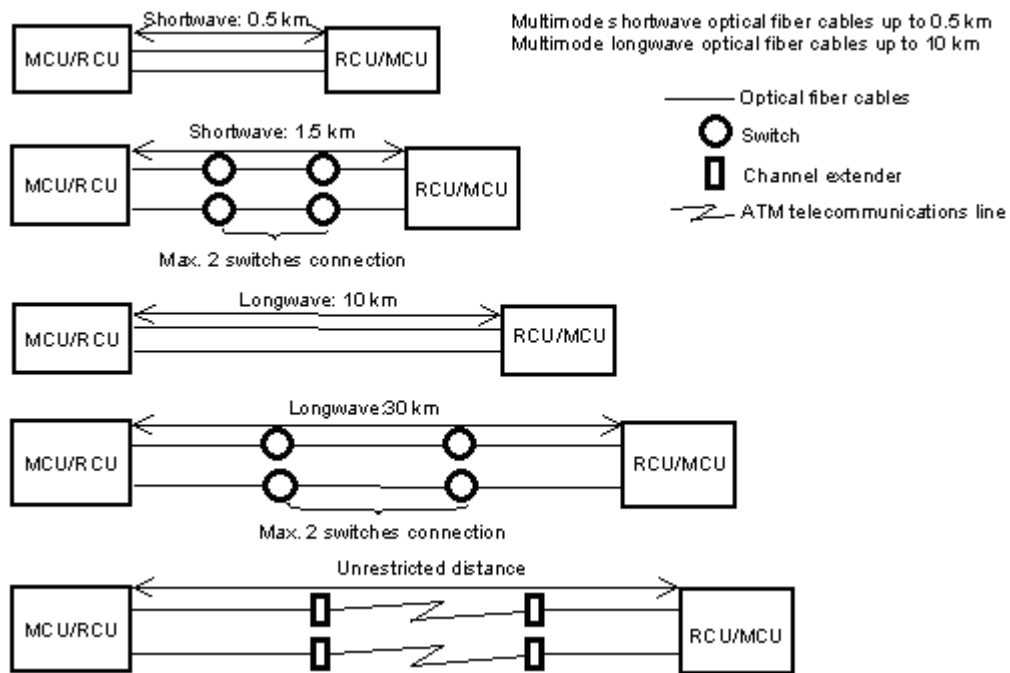

iSCSI data path requirements

For the iSCSI interface, direct, switch, and channel extender connections are supported. The following table lists the requirements and cautions for systems using iSCSI data paths. For details about the iSCSI interface, see the *Provisioning Guide*.

Item	Requirement
Remote paths	<p>Add only remote paths of the same protocol to a single path group. Make sure that Fibre Channel and iSCSI remote paths are not mixed in a path group.</p> <p>If iSCSI is used in a remote path, Blocked Path Monitoring must be at least 40 seconds (default). If Blocked Path Monitoring is less than 40 seconds, the path could become blocked because of a delaying factor on the network, such as the spanning tree of a switch.</p>
Physical paths	<ul style="list-style-type: none"> Before replacing Fibre Channel or iSCSI physical paths, remove the UR pair and the remote path that are using the physical path to be replaced. Using the same protocol in the physical path between the host and a storage system, or between storage systems is recommended. <p>As in the example below, if protocols are mixed, set the same or a greater command timeout value between the host and a storage system than between storage systems.</p> <p>Example:</p> <ul style="list-style-type: none"> Physical path between the host and a storage system: Fibre Channel Physical path between storage systems: iSCSI
Ports	<ul style="list-style-type: none"> When the parameter settings of an iSCSI port are changed, the iSCSI connection is temporarily disconnected and then reconnected. To

Item	Requirement
	<p>minimize the impact on the system, change the parameter settings when the I/O load is low.</p> <ul style="list-style-type: none"> • If you change the settings of an iSCSI port connected to the host, a log might be output on the host, but this does not indicate a problem. In a system that monitors system logs, an alert might be output. If an alert is output, change the iSCSI port settings, and then check if the host is reconnected. • When you use an iSCSI interface between storage systems, disable Delayed ACK in the Edit Ports window. By default, Delayed ACK is enabled. If Delayed ACK is enabled, it might take time for the host to recognize the volume used by a UR pair. For example, when the number of volumes is 2,048, it takes up to 8 minutes. • Do not change the default setting (enabled) of Selective ACK for ports. • In an environment in which a delay occurs in a line between storage systems, such as long-distance connections, you must set an optimal window size of iSCSI ports in storage systems at the primary and secondary sites after verifying various sizes. The maximum value you can set is 1,024 KB. The default window size is 64 KB, so you must change this setting. • iSCSI ports do not support fragment processing (dividing a packet). When the maximum transmission unit (MTU) of a switch is smaller than that of an iSCSI port, packets might be lost, and data cannot be transferred correctly. Set the same MTU value (or greater) for the switch as the value used for the iSCSI port. For more information about the MTU setting and value, see the switch manual. Note, however, that you cannot set an MTU value of 1500 or smaller for iSCSI ports. In a WAN environment in which the MTU value is less than 1500, fragmented data cannot be transferred. In this case, lower the maximum segment size (MSS) of the WAN router according to the WAN environment, and then connect to an iSCSI port. Alternatively, use a WAN environment in which the MTU value is at least 1500. • When using a remote path on the iSCSI port for which virtual port mode is enabled, use the information about the iSCSI port that has virtual port ID (0). You cannot use virtual port IDs other than 0 as a virtual port. • (VSP Gx00 models and VSP Fx00 models) A port can be used for connections to the host (target attribute) and to a storage system (initiator attribute). However, to minimize the impact on the system if a failure occurs either on the host or in a storage system, you should connect the port for the host and for the storage system to separate CHBs.
Network setting	<ul style="list-style-type: none"> • Disable the spanning tree setting for a port on a switch connected to an iSCSI port. If the spanning tree function is enabled on a switch, packets do not loop through a network when the link is up or down. When this happens, packets might be blocked for about 30 seconds. If you need to enable the spanning tree setting, enable the Port Fast function of the switch. • In a network path between storage systems, if you use a line that has a slower transfer speed than the iSCSI port, packets are lost, and the line quality is degraded. Configure the system so that the transfer speed for the iSCSI ports and the lines is the same. • Delays in lines between storage systems vary depending on system environments. Validate the system to check the optimal window size of the iSCSI ports in advance. If the impact of the line delay is major, consider using devices for optimizing or accelerating the WAN.

Item	Requirement
	<ul style="list-style-type: none">• When iSCSI is used, packets are sent or received using TCP/IP. Because of this, the amount of packets might exceed the capacity of a communication line, or packets might be resent. As a result, performance might be greatly affected. Use Fibre Channel data paths for critical systems that require high performance.

UR configuration operations

This chapter provides instructions for configuring Universal Replicator.

For details about GAD 3DC delta resync (GAD+UR) configuration operations, see [GAD 3DC delta resync \(GAD+UR\) operations on page 151](#).

- [Configuration workflow](#)
- [Defining Fibre Channel or iSCSI port attributes \(VSP G1000, G1500, and VSP F1500\)](#)
- [Configuring primary and secondary storage systems for UR](#)
- [Configuring additional remote paths](#)
- [Creating journals and adding journal volumes](#)
- [Assigning an MP blade to a journal](#)
- [Setting the remote replica options](#)

Configuration workflow

You must have Storage Administrator (Remote Backup Management) role to perform Universal Replicator operations. Be sure to check the prerequisites for each procedure (in "Before you begin"). Some tasks are performed from both primary and secondary storage systems. Other tasks are performed from one or the other.

Perform the following tasks to configure your systems for Universal Replicator operations:

1. Define the Fibre Channel or iSCSI port attributes. See [Defining Fibre Channel or iSCSI port attributes \(VSP G1000, G1500, and VSP F1500\) on page 116](#).
2. Set up remote paths between the primary and secondary storage systems. See [Configuring primary and secondary storage systems for UR on page 117](#).
3. Register journal volumes in a journal. See [Creating journals and adding journal volumes on page 120](#).
4. Assign an MP Blade to a journal. See [Assigning an MP blade to a journal on page 123](#).

When you create a 3DC multi-target configuration in which three UR sites are combined, perform this step, and then perform the procedure described in [Workflow for 3DC multi-target configuration with three UR sites on page 115](#).

When you create a 3DC cascade configuration in which three UR sites are combined, perform this step, and then perform the procedure described in [Workflow for 3DC cascade configuration with three UR sites on page 115](#).

A 3DC multi-target configuration with three UR sites and a 3DC cascade configuration with three UR sites are supported in version 80-03-01 or later (VSP G1000, VSP G1500, and VSP F1500), or 83-03-01 or later (VSP Gx00 models and VSP Fx00 models). When you use journals created using earlier versions in a 3DC multi-target configuration with three UR sites or in a 3DC cascade configuration with three UR sites, split or resynchronize the journals for each mirror, or add pairs to the journals.

Before the initial copy operations, you might also want to add more remote paths. See [Configuring additional remote paths on page 119](#).

You can also specify the number of volumes to copy at one time. For information, see [Changing the maximum initial copy activities option on page 206](#).

Workflow for 3DC multi-target configuration with three UR sites

When you create a 3DC multi-target configuration with three UR sites, you must perform the following procedure after step 4 in [Configuration workflow on page 114](#).

1. Create a UR pair for the first mirror in the primary site. Specify from 0 to 3 for the mirror ID when you create a UR pair.
2. Wait until the UR pair status has changed to PAIR.
3. Create a UR pair for the second mirror in the primary site. Specify the same master journal volume and P-VOL used for the first mirror. Specify from 0 to 3 for the mirror ID. Assign a mirror ID not used in step 1.
4. Wait until the UR pair status has changed to PAIR. To create a 3DC multi-target configuration using the delta resync, perform the following procedure from steps 5 to 7.
5. Create a UR delta resync pair with the S-VOLs in the two secondary sites by doing the following:
 - Specify the S-VOL of the first mirror in the secondary site as the P-VOL.
 - Specify the S-VOL of the second mirror in the secondary site as the S-VOL.
 - Specify from 0 to 3 for the mirror ID. Assign a mirror ID not used in steps 1 and 3.



Note: Specify the P-VOL and S-VOL for the delta resync pair for convenience. When you actually perform a delta resync operation, the failover destination site is used as the P-VOL.

6. Allocate remote command devices for each two mirror IDs in the primary site.
7. Allocate remote command devices for a mirror ID of the UR delta resync pair in each secondary site.



Note:

- When you delete a UR pair of the first mirror created in step 1 or delete a UR pair of the second mirror created in the step 3, the delta resync mirror's UR pair created in step 5 will also be deleted.
 - Perform the pair operations by using CCI for the 3DC multi-target configuration with three UR sites.
-

Workflow for 3DC cascade configuration with three UR sites

When you create a 3DC cascade configuration with three UR sites, you must perform the following procedure after step 4 in [Configuration workflow on page 114](#).

1. Create a UR pair for the first mirror in the primary site. Specify from 0 to 3 for the mirror ID when you create a UR pair.
2. Wait until the UR pair status has changed to PAIR.
3. Create a UR pair for the second mirror in the intermediate site. Specify the restore journal volume and S-VOL for the master journal volume and P-VOL used in the first mirror. Specify from 0 to 3 for the mirror ID. Assign a mirror ID not used in step 1.
4. Wait until the UR pair status is changed to PAIR. When you set up the delta resync configuration, use the steps from 5 to 7.
5. Create a UR delta resync pair with the primary and secondary site volumes by doing the following:
 - Specify P-VOL for P-VOL in the primary site of the first mirror.
 - Specify S-VOL for S-VOL in the secondary site of the second mirror.
 - Specify from 0 to 3 for a mirror ID. Assign a mirror ID not used in the step 1 and 3.
6. Allocate remote command devices for each two mirror IDs in the primary site.
Allocate remote command devices also for the UR delta resync pair's mirror ID.
7. Allocate remote command devices for the mirror ID in the intermediate site.
8. Allocate remote command devices for the mirror ID in the secondary site.



Note: When you delete a UR pair of the first mirror created in step 1 or delete a UR pair of the second mirror created in step 3, the delta resync mirror's UR pair created in step 5 will also be deleted.

Defining Fibre Channel or iSCSI port attributes (VSP G1000, G1500, and VSP F1500)

Initiator and RCU target ports must be set up on the primary and secondary storage systems for Universal Replicator command and data transfer.

Before you begin

- Before a Fiber Channel or iSCSI target port can be changed to an initiator port, the following must be performed:
 - Disconnect the port from the host.
 - Release all affected pairs.
 - Delete all remote paths from the initiator port to the secondary storage system.
 - Remove all cables to the port.
- Before a Fiber Channel or iSCSI initiator port can be changed to target or RCU target, the following must be performed:

- Release all affected pairs.
- Delete all remote paths from the initiator port to the secondary storage system.
- After remote paths are deleted, remove the cables connecting the primary storage system to the secondary storage system.
- To prevent disconnection, limit the number of hosts connected to the target port to 128 or less.

Procedure

1. In the **Explorer** pane, expand the **Storage Systems** tree.
2. Expand the target storage system tree, and click **Ports/Host Groups/iSCSI Targets**
3. In the **Ports** tab, click the port whose attribute you want to change then click **Edit Ports**
4. In the **Edit Ports** window, select the **Port Attribute: Initiator** or **RCU Target**. If you need to specify other settings, see the *Provisioning Guide*.
5. Click **Finish**.
6. In the **Confirm** window, review the settings, enter a task name, and then click **Apply**.

Related concepts

- [Planning ports for data transfer](#) on page 104

Configuring primary and secondary storage systems for UR

You associate the primary and secondary storage systems in the Universal Replicator relationship and define the remote paths between them in one procedure.

Before you begin

- This procedure must be performed on both primary and secondary storage systems
- The primary and secondary storage systems must already be configured for Universal Replicator operations. For details, see [System requirements on page 44](#).
- The data path must be set up. For details, see [Planning the data path on page 97](#).
- The port attributes on the primary and secondary storage systems must be configured for UR. For details, see [Defining Fibre Channel or iSCSI port attributes \(VSP G1000, G1500, and VSP F1500\) on page 116](#).
- The system's serial number and model will be required during this procedure.
- A path group ID will be required. This is a group of a maximum of remote paths. For details, see Path Group item in [System requirements on page 44](#).

Procedure

1. In the **Explorer** pane, expand the **Storage Systems** tree.
2. Expand the target storage system tree, expand **Replication**, and click **Remote Connections**.
3. In the **Connections (To)** tab, click **Add Remote Connection**.
4. In the **Add Remote Connection** window, for **Connection Type**, select **System**.

The screenshot shows the 'Add Remote Connection' wizard. The 'Connection Type' is set to 'System'. The 'Local Storage System' is configured with Model: VSP G1000, Serial Number: 2650, and Local CU: (empty). The 'Remote Storage System' is configured with Model: VSP G1000 (7) (5-255), Serial Number: (1-99999), Remote CU: (-), and SSID: (-). The 'Remote Paths' section shows Path Group ID: 00 and Minimum Number of Paths: 1 (Fixed 1 on UR/URMF.). The 'Options' section shows RIO MIH Time: 15 Second(s), Round Trip Time: 1 Millisecond(s), and FREEZE Option: Enable.

5. In the **Remote Storage System** area, for **Model**, select the secondary storage system model and number.
 - For VSP G1000, VSP G1500, and VSP F1500, select 7
 - For VSP, select 6
 - For USP V/VM, select 5
 - For HUS VM, select 19 (available only if **Connection Type** is **System**)
 - For VSP Gx00 models and VSP Fx00 models, select 18 (available only if **Connection Type** is **System**)
6. For **Serial Number**, enter the secondary storage system serial numbers (five or six digits).



Note: When using virtual storage machine volumes, make sure to specify the serial number of the physical storage system. The serial number of a virtual storage machine cannot be specified.

7. For **Path Group ID**, select the ID (00-FF) for the path group you want to use. You can register 1 to 64 path group IDs for each storage system.
8. For **Minimum Number of Paths**, select the lowest number of paths between the local storage system and remote storage system (range = 1 to 8). For UR, select 1. If the number drops below this setting, the primary storage system will split the pair.
9. For **Select Type**, select the port type.
10. Select the port used by the local storage system and the remote storage system. If you selected iSCSI for the port type, enter the IP address and the TCP port number of the port on the remote storage system. To add a path, click **Add Path**. You can add a maximum of eight paths.
You can add and remove paths later as needed using the **Add Remote Paths** window. For instructions, see [Configuring additional remote paths on page 119](#).
11. Click **Options** to enter **RIO MIH Time** (remote I/O missing interrupt handler), which is the time interval in seconds that, if exceeded, causes the data transfer operation to be reported as failed by the system. Valid values range from 10 seconds to 100 seconds, and the default is 15 seconds.



Note: The recommended RIO MIH setting for a 3DC cascade configuration is 20 seconds.

12. Click **Finish**.
13. In the **Confirm** window, review the settings, enter a task name, and then click **Apply**.

Configuring additional remote paths

You can configure additional remote paths as needed. A maximum of eight remote paths can be configured between storage systems.

Before you begin

- Review the path-related prerequisites [Configuring primary and secondary storage systems for UR on page 117](#) (in "Before you begin").

Procedure

1. In the **Explorer** pane, expand the **Storage Systems** tree.
2. Expand the target storage system tree, expand **Replication**, and click **Remote Connections**.
3. In the **Connections (To)** tab, select the remote connection where you want to add remote paths.
4. Click **More Actions > Add Remote Paths**.
5. For **Select Type**, select the port type.

6. Select the port used by the storage system at the primary site and the port used by the storage system at the secondary site. If you selected iSCSI for the port type, enter the IP address and the TCP port number of the port used by the storage system at the secondary site. To add two or more paths, click **Add Path**.
7. Click **Finish**.
8. In the **Confirm** window, review the settings, enter a task name, and then click **Apply**.

Creating journals and adding journal volumes

You create journals and add and configure journal volumes in the same procedure. For adding journal volumes to an existing journal, see [Adding an additional journal volume to an existing journal on page 215](#).

Before you begin

- Review the following:
 - [System requirements on page 44](#)
 - [Planning journals on page 67](#)
 - [Planning journal volumes on page 67](#)
- The journal's mirror status must be Initial, Active, Stopped, Hold, Holding, or Hold(Failure).
- The journal cannot be in use.
- Pair operations involving the journal cannot be in progress.
- Cache Residency Manager settings cannot be defined for the volumes.

Procedure

1. In the **Explorer** pane, expand the **Storage Systems** tree.
2. Expand the target storage system tree, expand **Replication**, and click **Journals**.
3. In the **Journals** tab, click **Create Journals**.
4. In the **Create Journals** window, for **System Type**, select **Open**.

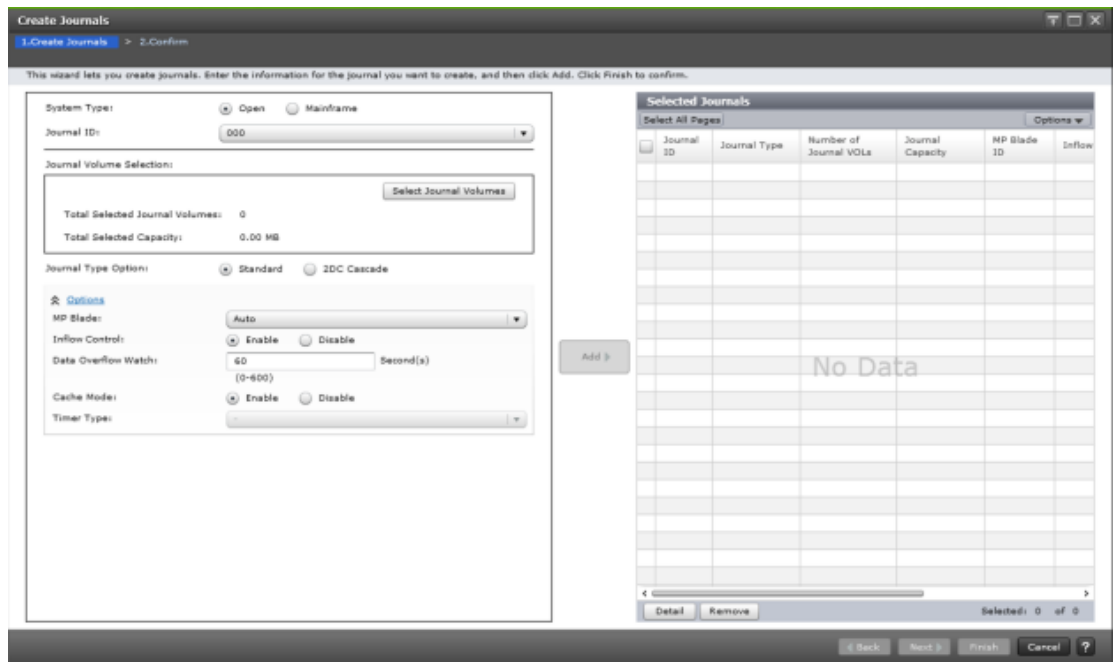

5. For **Journal ID**, select a journal ID from the list.
6. In the **Journal Volume Selection** box, click the **Select Journal Volumes** button.
7. In the **Select Journal Volumes** dialog box, from the **Available LDEVs** table, select the journal volumes (one or two) to be registered to the journal, and click the **Add** button. The volumes are now listed in the **Selected Journal Volumes** table.

To remove a volume from the **Selected Journal Volumes** table, select it and then click **Remove**.

Click **OK** when finished. If you register two journal volumes at the same time, the volume with the smaller LDEV number is registered as the journal volume, and the other volume is registered as the reserve journal volume.

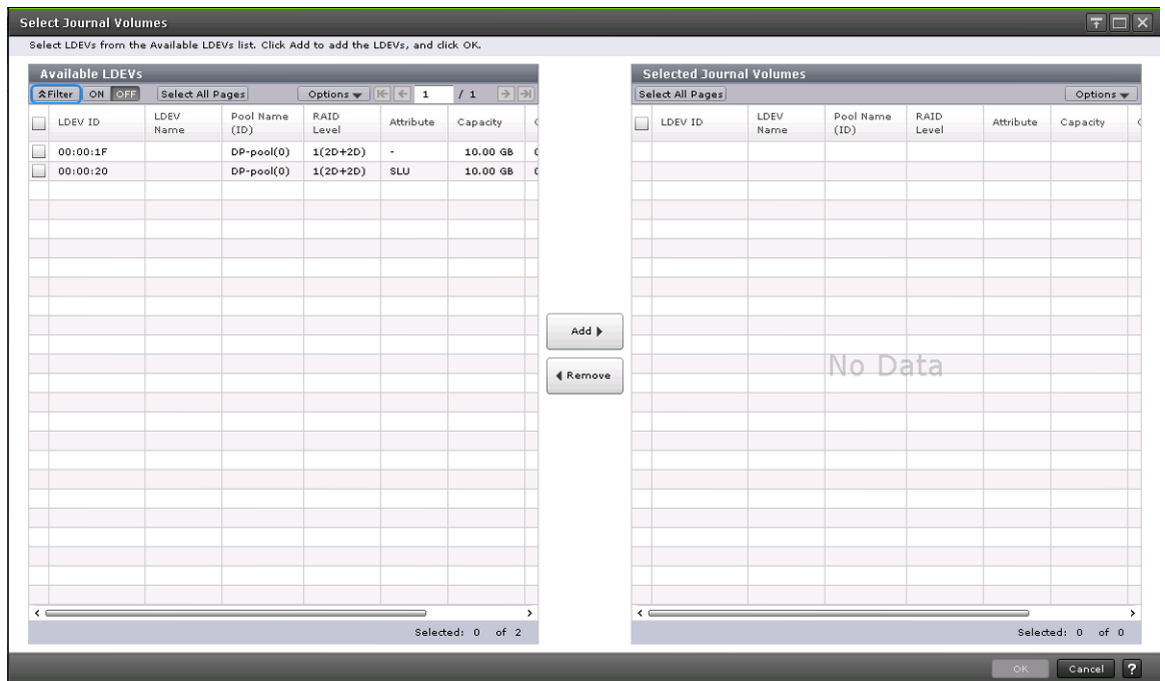

8. In the **Create Journals** window, select a **Journal Type Option**.
 - Select **Standard** for journals in UR standalone pairs and pairs in a 3DC configuration.
9. Optional. For **MP Blade**, you can specify an MP blade from **MPB0** to **MPB7**. **Auto** is available when one or more blades can be assigned automatically. When **Auto** cannot be selected, the default is the blade with the lowest number.
10. Optional. For **Inflow Control**, you can specify whether to restrict the flow of update I/O to the journal volume. Enabling this setting delays the response to hosts. Also, by restricting the inflow of data to one journal, you can allow other journals with higher-priority data unrestricted inflow.
 - **Enable** restricts inflow.
 - **Disable** leaves inflow unrestricted. With Disable selected, if metadata or journal data is full, update I/Os might stop.
11. Optional. For **Data Overflow Watch**, you can specify the number of seconds for the system to monitor metadata and journal data when the journal volume is full (100%). Range is 0-600 seconds. The default is 60.
12. Optional. For **Cache Mode**, you can specify whether to store journal data in the cache memory on the secondary side (restore journal).
 - **Enable**: Journal data will be stored in the cache. When there is insufficient space in the cache, journal data will also be stored into the journal volume. Enable is available only for journal volumes of RAID-5 or RAID-6.
 - **Disable**: Journal data will not be stored in cache but in the journal volume. Disable is the only setting possible for non-RAID-5 or RAID-6 journal volumes and external volumes.



Note: This setting does not affect master journals unless the CCI hor takeover command is used to change a master journal into a restore journal.

13. Optional. For **Timer Type**, specify the type of clock used for consistency time. The specified value must be the same for the primary and secondary storage system.
 - **System:** Uses the mainframe host system clock. The host MVS IOS routine attaches time-stamp information from the time-of-day (TOD) clock to each write I/O operation. The time-stamp is transferred to the primary storage system at the beginning of each I/O operation.
 - **Local:** Uses time stamp information from the host I/O time stamping function. The mainframe system clock is not used.
 - **None:** Uses time stamp information from the host I/O time stamping function. None is available only when copy direction is reversed, that is, S-VOL-to-P-VOL.
14. Click **Finish**.
15. In the **Confirm** window, review the settings, enter a task name, and then click **Apply**.

Assigning an MP blade to a journal

Procedure

1. In the **Explorer** pane, expand the **Storage Systems** tree.
2. Expand the target storage system tree, expand **Replication**, and click **Journals**.
3. In the **Journals** tab, select the journal you will add the blade to.
4. Click **More Actions > Assign MP blade**.
5. In the **Assign MP Blade** window, for **MP Blade**, select a blade from **MPB0** to **MPB7**.

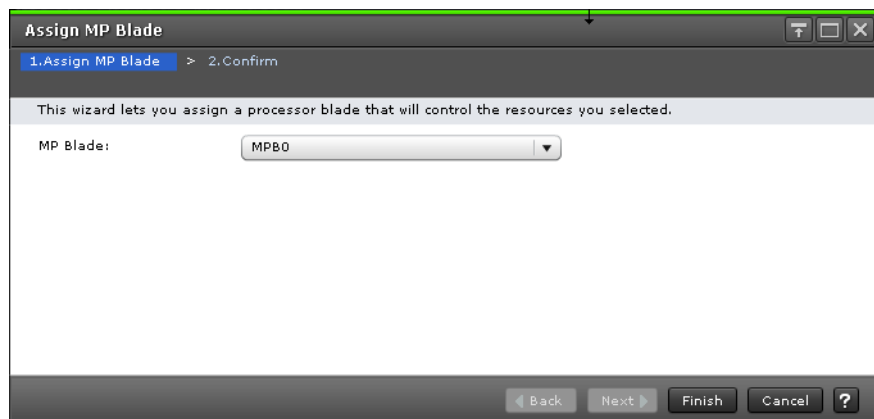

6. Click **Finish**.
7. In the **Confirm** window, review the settings, enter a task name, and then click **Apply**.

Setting the remote replica options

You can set the following options using the Edit Remote Replica Options window:

- The number of volumes that can be copied concurrently in a single initial copy operation.
- The amount of time to monitor a path blockade.
- The amount of time to monitor the SIMs reported by a path blockade.

Related tasks

- [Setting the maximum initial copy activities option](#) on page 124
- [Setting the blocked-path monitoring and blocked-path SIM monitoring options](#) on page 125

Setting the maximum initial copy activities option

You can set the number of volumes that can be copied concurrently during pair creation and pair resynchronization using the Edit Remote Replica Options window (range = 1 to 128, default = 64). You can also change this setting later as needed.

Before you begin

- Storage Administrator (Remote Copy) role is required.

Procedure

1. In the **Storage Systems** tree, select **Replication**.
2. Click **Edit Options > Remote Replication**.
3. In **Copy Type**, select **UR/URMF**.
4. In **Maximum Initial Copy Activities**, enter a value from 1 to 128 as the number of volumes that can be copied concurrently during an initial copy operation. For example, if you specify 64 for **Maximum Initial Copy Activities** and then register 65 pairs concurrently, the local system starts the initial copy operations for the first 64 pairs. The initial copy operation for the 65th pair is started when one of the first 64 pairs becomes synchronized, so that no more than 64 initial copy operations are performed at the same time.



Note:

- The number of initial copy activities setting might affect the performance of the local storage system depending on the

amount of I/O activity and the number of pairs that are registered concurrently.

- If you specify a large value, the number of pending activities in a remote storage system increases, and the response time of the remote I/Os for the update I/O operations might be affected.
-

5. Click **Finish**.
6. In the **Confirm** window, check the settings you made, and then enter the task name in **Task Name**.
If you want to open the **Tasks** window automatically after closing this window, select **Go to tasks window for status**.
7. Click **Apply**.
The task is registered, and the **Tasks** window appears if **Go to tasks window for status** was selected.
8. You can check the progress of the task on the **Tasks & Alerts** tab. Click the task name to view details of the task.

Setting the blocked-path monitoring and blocked-path SIM monitoring options

You can set the period of time to monitor a blocked path and the time to monitor SIMs that are reported by a blocked path using the Edit Remote Replica Options window. You can also change these settings later as needed.

- Blocked Path Monitoring: range = 2 to 45 seconds
- Blocked Path SIM Monitoring: range = 2 to 100 seconds

Before you begin

- Storage Administrator (Remote Copy) role is required.

Procedure

1. In the **Storage Systems** tree, select **Replication**.
2. Click **Edit Options > Remote Replication**.
3. In **Copy Type**, select **TC/TCMF**.
These values are necessary for setting **Blocked Path Monitoring**, and are used for TC, TCz, UR, URz, and GAD operations.
4. In **Blocked Path Monitoring**, enter a value from 2 to 45 (sec.) as the time to monitor a path blockade.
5. In **Blocked Path SIM Monitoring**, enter a value from 2 to 100 (sec.) as the time to monitor SIMs that are reported by a path blockade.
6. Click **Finish**.
7. In the **Confirm** window, check the settings you made, and then enter the task name in **Task Name**.
8. Click **Apply**.

The task is registered, and the **Tasks** window appears if the **Go to tasks window for status** check box is selected.

9. You can check the progress of the task on the **Tasks & Alerts** tab. Click the task name to view details of the task.

UR pair operations

This chapter provides instructions for performing Universal Replicator pair operations.

- [Pair operations](#)
- [Creating a UR pair](#)
- [Checking the pair status](#)
- [Splitting a UR pair](#)
- [Splitting a mirror](#)
- [Creating point-in-time copies](#)
- [Resynchronizing a UR pair](#)
- [Resynchronizing a mirror](#)
- [Deleting a UR pair](#)
- [Deleting pairs in a mirror](#)
- [Managing pairs in a GAD 3DC delta resync environment \(VSP G1000, G1500, and VSP F1500\)](#)

Pair operations

You must have Storage Administrator (Remote Backup Management) role to perform Universal Replicator pair operations. The pair operations are:

- [Checking the pair status on page 133](#)
- [Creating a UR pair on page 128](#)
- [Splitting a UR pair on page 134](#)
- [Splitting a mirror on page 136](#)
- [Creating point-in-time copies on page 137](#)
- [Resynchronizing a UR pair on page 138](#)
- [Resynchronizing a mirror on page 140](#)
- [Deleting a UR pair on page 141](#)
- [Managing pairs in a GAD 3DC delta resync environment \(VSP G1000, G1500, and VSP F1500\) on page 145](#)



Caution: When you perform pair operations between the primary and secondary sites or between the intermediate and secondary sites in a 3DC cascade configuration in which three UR sites are combined, make sure that the pair operations are not performed in other sites. If the pair operations are duplicated, either one of the pair operations might fail. When performing pair operations between other sites, make sure the pair status transition to the required status is completed before performing pair operations in another site.

Creating a UR pair

When you create a pair, the pair relationship between the volumes is established, and the initial copy operation is performed. The P-VOL remains available to the host for I/O operations during the initial copy operation.

Before you begin

- You can create a pair only from the primary storage system.
- The S-VOL must be offline to all hosts.
- The primary and secondary storage systems must already be configured, and the remote paths must already be defined. For details, see [Configuring primary and secondary storage systems for UR on page 117](#).
- The P-VOL capacity and S-VOL capacity must be the same (same number of blocks). To view the capacity in blocks, click Options > Capacity Unit > block in the Logical Devices window. If the capacity is displayed in GB or TB, a slight difference in P-VOL and S-VOL capacity might not be displayed.

- Journal volumes must be registered to the journals that are associated with pairs. For details, see [Creating journals and adding journal volumes on page 120](#).
- Review the information on S-VOL volume numbers in the bullet on creating multiple pairs in [Planning pair volumes on page 69](#).
- If you are creating a UR delta resync pair, see [Delta resync configuration on page 327](#).
- Make sure that Performance Monitor is stopped.

The following additional information may be useful to you before beginning the procedure:

- You will select the volumes to be paired by port, host group ID or iSCSI target ID, and LUN ID. Make sure to have this information available.
- You will assign master and restore journals to the P-VOL and S-VOL during the operation.
- You will assign a mirror ID to the pair. This identifies the pair within the journal. A mirror refers to the pair within the journal.
- If the mirror ID you will assign to the new pair contains an existing pair or pairs, the new pair's volumes must belong to the same primary and secondary storage systems defined in the mirror.
- In a 3DC multi-target configuration in which three UR sites are combined, you cannot create a UR pair with the second mirror if the first UR P-VOL is in the COPY status.
- In a 3DC cascade configuration in which three UR sites are combined, you cannot create a UR pair between the intermediate and secondary sites if the UR S-VOL between the primary and intermediate sites is in the COPY status.

Procedure

1. In the **Explorer** pane, expand the **Storage Systems** tree.
2. Expand the target storage system tree, expand **Replication**, and click **Remote Replication**.
3. In the **UR Pairs** tab, click **Create UR Pairs**.
4. In the **Create UR Pairs** window, for **Copy Type**, select **Universal Replicator**.

Create UR Pairs

1.Create UR Pairs > 2.Confirm

This wizard lets you create pairs. Enter the information for the pair you want to create, and then click Add. C

Copy Type:

Remote Storage System: Model / Serial Number Path Group ID

Primary Volume Selection:

Use Existing Volumes of UR Pairs: Yes No

LU Selection: Port ID Host Group Name

Available Primary Volumes					
Filter	ON	OFF	Select All Pages	Options	1 / 1
<input type="checkbox"/>	Port ID	Host Group Name / iSCSI Target Alias	iSCSI Target Name	LUN ID	LDEV ID
<input type="checkbox"/>	CL1-A	1A-G00 (00)	-	2	00:00:12
<input type="checkbox"/>	CL1-A	1A-G00 (00)	-	3	00:00:0A
<input type="checkbox"/>	CL1-A	1A-G00 (00)	-	4	00:00:0B
<input type="checkbox"/>	CL1-A	1A-G00 (00)	-	5	00:00:13
<input type="checkbox"/>	CL1-A	1A-G00 (00)	-	6	00:00:14
<input type="checkbox"/>	CL1-A	1A-G00 (00)	-	7	00:00:15

Selected: 0 of 8

Secondary Volume Selection:

Base Secondary Volume: Port ID Host Group ID/ LUN ID
iSCSI Target ID

(00-FE) (0-2047,
Decimal input)

Selection Type: Interval
 Relative Primary Volume

Mirror Selection: Master Journal Mirror ID Restore Journal

(000-OFF)

Current Number of Master Journal Mirrors: 2

Total Number of Master Journal Mirrors: 2

5. For **Remote Storage System**, select the secondary storage system's **Model/Serial Number** and **Path Group ID**.
 - If the mirror contains an existing pair, the same **Model/Serial Number** as the existing pair's must be selected.
 - If the secondary storage system is USP V/VM, only 0 can be selected for Path Group ID.
6. In the **Primary Volume Selection** box, for **Use Existing Volumes of UR Pairs**, select whether to use the volume used by the UR pair. (VSP G1000, G1500, and VSP F1500) If you are creating 3DC multi-target pair by three UR sites or cascade configuration pair, select **Yes**. If you are not, select **No**.
7. In the **Primary Volume Selection** box, in **LU Selection**, select the **Port ID** and **Host Group Name** or **iSCSI Target Alias** to display the volumes from which you want to select the P-VOL.
8. In the **Available Primary Volumes** table, select the volume that will be the P-VOL.



Note: Limitations for **Available Primary Volumes**:

- When you are using a virtual storage machine with, **Available Primary Volumes** displays physical LDEV information, not virtual.
 - Nondisruptive migration volumes are not displayed in **Available Primary Volumes**.
-

9. In the **Secondary Volume Selection** box, for **Base Secondary Volume**, select the S-VOL's **Port ID**, **Host Group ID/iSCSI Target ID**, and **LUN ID**.



Caution: For USP V/VM and VSP, LUN IDs display in hexadecimal numbers. For VSP G1000, VSP G1500, and VSP F1500, LUN IDs display in decimal or hexadecimal numbers. If you have selected the decimal notation, when assigning an S-VOL in a USP V/VM or VSP storage system, make sure to convert the hexadecimal LUN ID number to decimal.

10. For **Selection Type**, select the method for assigning S-VOLs when multiple primary volumes are selected, **Interval** or **Relative Primary Volume**. See "Before you begin" for more information.
11. For **Mirror Selection**, specify the following:
 - a. For **Master Journal**, select a number from the list of registered journal IDs. The list excludes already-assigned master and restore journal IDs.



Note: If you selected **Yes** for **Use Existing Volumes of UR Pairs** in the **Primary Volume Selection** box, **Depends on Selected P-Vols** is selected for **Master Journal**.

- b. For **Mirror ID**, assign an identifier number for the mirror.
 - c. For **Restore Journal**, select a number from the list of registered journal IDs. All journal IDs display (000-OFF).
 - d. For **CTG ID**, select a consistency group from the list of those registered in the storage system. An asterisk indicates the CTG is assigned to a pair in the **Select Pairs** table.
- 12.** Click **Options** to define the following optional settings:
- a. For **Initial Copy Type**, you can specify whether to copy data from P-VOL to S-VOL during the operation.
 - **Entire** creates the pair and copies data to the S-VOL. (Default)
 - **None** creates the pair but data is not copied to the S-VOL. This requires that data in the P-VOL and S-VOL are already identical.
 - **Delta** creates the delta resync pair but data is not copied to the S-VOL.
 - b. For **Initial Copy Priority**, you can specify the scheduling order for this initial copy operation. Range is 1 to 256 (default = 32).

If a time out error occurs, the copy operation may not be executed in the order that you set with Initial Copy Priority. The time out error may be caused by the CU configuration or a remote copy path error. Review the error, release the pair with the error, and then retry the Paircreate operation.
 - c. In the **Error Level** list, you can select one of the following system responses if a failure occurs during this operation:
 - **Mirror**, to split all pairs in the failed pair's mirror. **Mirror** is the default.
 - **LU**, to split only the pair that failed.
- 13.** When ready, click **Add**. This moves the new pair to the **Selected Pairs** table. (To remove a pair from the table, select the pair and click **Remove**).
- 14.** Click **Finish**.
- 15.** In the **Confirm** window, review the settings, enter a task name, and then click **Apply**.

Result

Based on the initial copy option you selected, you can verify that the pair status is correct in the Remote Replication window. The following table specifies the pair status required to successfully complete the operation.

Initial Copy Option	Pair Status Requirement
Entire or None	COPY or PAIR
Delta	HOLD, HOLDING

You can also monitor the progress of the operation by clicking File > Refresh in the menu bar. This updates the information in the list.

Checking the pair status

Every UR operation requires that the pairs have a specific status. You should always check the pair status before performing any UR operation.

Before you begin

- The pair status requirements are listed in the prerequisite information for each procedure (in "Before you begin").
- To review the definitions of the pair statuses, see [Pair status definitions on page 33](#).

Procedure

1. In the **Explorer** pane, expand the **Storage Systems** tree.
2. Expand the target storage system tree, expand **Replication**, and click **Remote Replication**.
3. Select the **UR Pairs** tab, and then locate the desired pair in the list. The pair status is displayed in the **Status** column. Click **File > Refresh** as needed to display the most current pair status information in the **Remote Replication** window.
4. To view detailed pair properties, select the pair, and then click **More Actions > View Pair Properties**.

View Pair Properties

Pair Properties

Local Storage System

00:02:10()
 Number of Paths: 1
 DP
 OPEN-V , 99.99 GB
 Journal ID: 000
 VSP G1000 / 2654 , 0:CLPRO

Remote Storage System

00:02:11
 CL1-A / 00 / 1
 OPEN-V , 99.99 GB
 Journal ID: 001
 VSP G1000 / 12345

UR Copy
 :PAIR
 Path Group: 00
 Mirror ID: 0

Pair Detail

Status	PAIR	
CTG ID	000	
Sub Status	-	
Reverse Resync	-	
Error Level	Mirror	
Secondary Volume Write	Disabled	
Initial Copy Priority	32	
Paired Time	2008/04/12 09:19:12	
Last Update Time	2008/04/12 09:19:12	
Pair Copy Time	000:05:00	
Consistency Time	-	
Timer Type	-	
CFW	-	
Local Storage System	Virtual Storage Machine	VSP G1000 / 02654
	Virtual LDEV ID	00:02:10
	Virtual Device Name	
	Virtual SSID	
Remote Storage System	Virtual Storage Machine	VSP G1000 / 12345
	Virtual LDEV ID	00:02:11

1 / 1

Back Next Close ?

Splitting a UR pair

When you split a pair, write-data is no longer sent to the S-VOL and the pair is no longer synchronized. Splitting a pair or mirror gives you a point-in-time copy of the P-VOL.

Before you begin

- This operation can be performed from the primary or secondary storage system.
- Pair status must be COPY or PAIR.
- To split multiple pairs at the same time, the pairs must belong to the same mirror. This ensures sequence consistency among S-VOLs in the mirror.
- Pairs in a CCI consistency group consisting of multiple primary and secondary storage systems can only be split in the mirror.

The following additional information may be useful before beginning the procedure:

- Performing the pair split when I/O load is low reduces impact on performance. Operations on multiple pairs in the same consistency group

with different statuses may result in suspension during periods of heavy write I/O.

- If you split pairs in PAIR status and other than PAIR status in the same mirror, an unexpected suspension could occur during the operation under heavy I/O load conditions. You can estimate whether the I/O load is heavy or not from frequency of host I/Os. This operation should be performed under light I/O load conditions.
- During normal operations, the secondary storage system rejects write operations to an S-VOL. If desired, you can enable write operations to the S-VOL while the pair is split by enabling the S-VOL write option. When this option is enabled, the secondary storage system sends the S-VOL track bitmap to the primary storage system during pair resync to ensure proper resynchronization of the pair. The S-VOL write option (Secondary Volume Write) is described in the pair-split procedure.

Procedure

1. In the **Explorer** pane, expand the **Storage Systems** tree.
2. Expand the target storage system tree, expand **Replication**, and click **Remote Replication**.
3. In the **UR Pairs** tab, select the pairs to be split and click **Split Pairs**.
4. In the **Split Pairs** window, review the pairs to be split in the **Selected Pairs** table. To remove a pair from the table, select the pair and click **Cancel**.

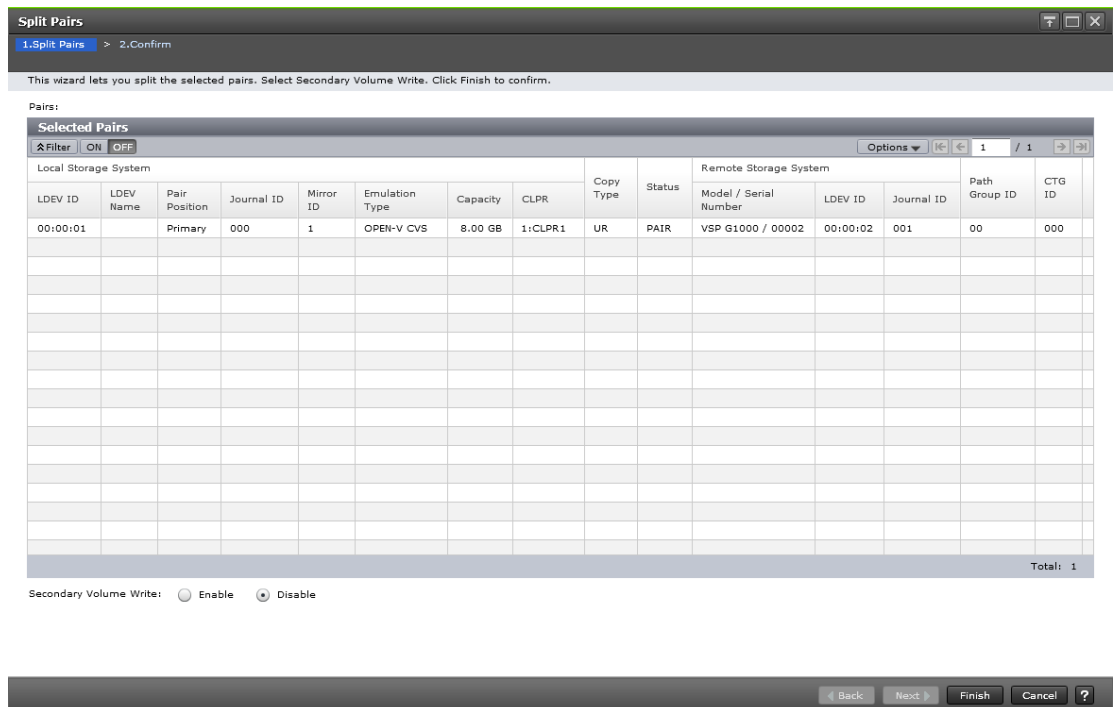

5. For **Secondary Volume Write**, specify whether data can be written to the S-VOL while it is split. Available only when performing the split operation from the pair's primary storage system.
 - **Enable:** The host can write data to the S-VOL.
 - **Disable:** The host cannot write data to the S-VOL.



Note: In a 3DC configuration in which three UR sites are combined, host I/O write requests to the split pair's S-VOL might be rejected when the delta resync pair shares the split S-VOL, even if you split a pair with the Secondary Volume Write option enabled.

6. Click **Finish**.
7. In the **Confirm** window, review the settings, enter a task name, and then click **Apply**.

Splitting a mirror

A mirror normally has multiple pairs with the same master and restore journals groups. When you split a mirror, you split all the pairs in the mirror. As with a normal pair split, data copying is suspended between primary and secondary journals.

Before you begin

- A mirror can be split from the primary or secondary storage system.
- Pair status must be Active.

Procedure

1. In the **Explorer** pane, expand the **Storage Systems** tree.
2. Expand the target storage system tree, expand **Replication**, and click **Remote Replication**.
3. On the **Mirrors** tab, select the mirrors to be split and click **Split Mirrors**.
4. In the **Split Mirrors** window, review the mirrors that you selected in the **Selected Mirrors** table. To remove a mirror, select it and click **Cancel**.

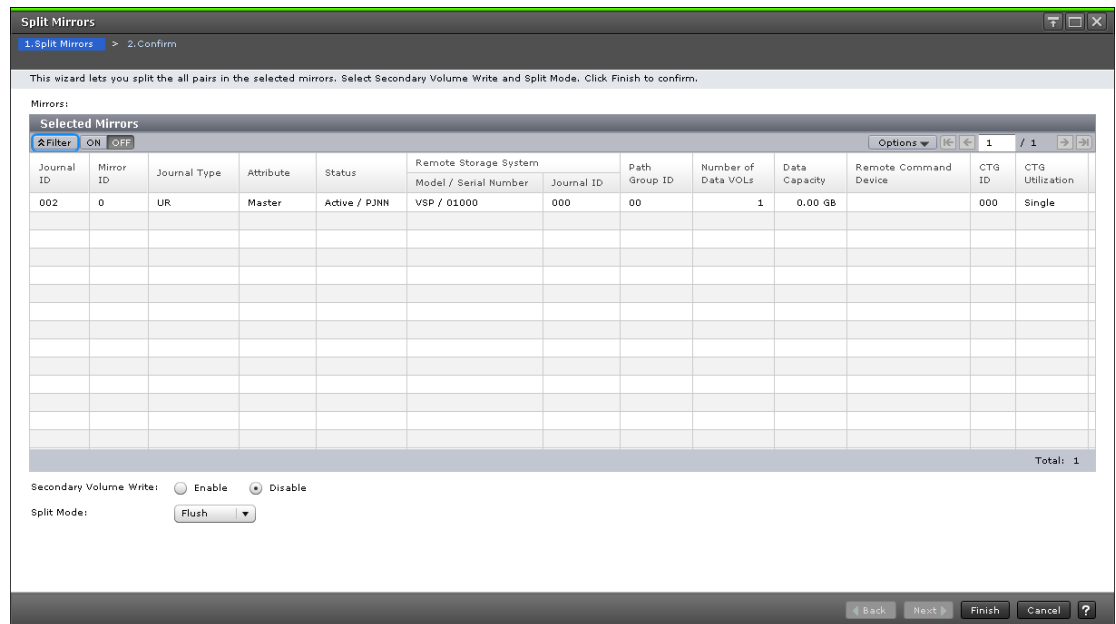

5. For **Secondary Volume Write**, specify whether data can be written to S-VOLs in the mirror while it is split.
 - **Enable**: The host can write data to S-VOLs in the mirror. Available only when the selected mirror's Attribute is Master. If Restore, Disable is used automatically.
 - **Disable**: The host cannot write data to S-VOLs in the mirror.
6. For **Split Mode**, specify whether data is written to S-VOLs in the mirror before the split operation runs.
 - **Flush**: Copies all update data from to S-VOLs in the mirror before the split.
 - **Purge**: Prevents update data from being copied to S-VOLs in the mirror before the split. Uncopied data is copied to the S-VOL when the pair is resynchronized.
7. Click **Finish**.
8. In the **Confirm** window, review the settings, enter a task name, and then click **Apply**.

Creating point-in-time copies

Universal Replicator allows you to make Point-in-Time (PiT) copies of volumes in the same journal. Point-in-Time describes a copy of data made when you it.

Before you begin

- Review the prerequisite information (in "Before you begin") in [Splitting a UR pair on page 134](#).

Procedure

1. Stop all write I/Os from hosts to P-VOLs in the journal.
2. Split the mirror. Make sure to specify **Flush** for **Split Mode**.
3. When the status of all pairs in the journal changes to PSUS, the operation is completed. Resume write I/O to the P-VOLs.

Resynchronizing a UR pair

Resynchronizing a pair updates the S-VOL with differential data that accumulated since the pair was split. After the pair is resynchronized, the S-VOL is again updated from the journals.

Before you begin

- This operation is performed from the primary storage system only.
- The pair status must be PSUS or PSUE.
If pair status is HOLD, HOLDING, or HLDE, use the resynchronizing mirrors operation (see [Resynchronizing a mirror on page 140](#)).
- In a 3DC multi-target configuration with three UR sites, you cannot resynchronize the other mirror's UR pair when one mirror's UR P-VOL is in the COPY status.
- In a 3DC cascade configuration with three UR sites, you cannot resynchronize the UR pair between the primary and intermediate sites when the UR pair between the intermediate and secondary sites is in the COPY status, as illustrated in the following figure.

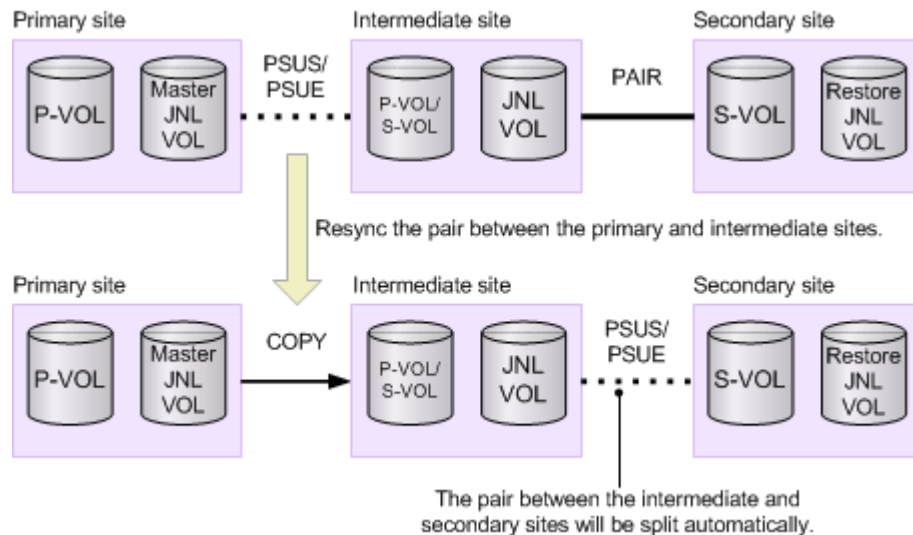

- In a 3DC cascade configuration with three UR sites, the pair between the intermediate and secondary sites will be split automatically when you

resync the UR pair between the primary and intermediate sites, if the UR pair between the intermediate and secondary sites is in the PAIR status.

- Pairs suspended by the system (PSUE status) can be resynchronized only after the error causing the suspension has been corrected.

The following additional information may be useful before beginning the procedure:

- Performing the operation on a pair in HLDE status changes the status to HOLD.
- The primary storage system does not resynchronize a pair that is suspended due to an error until the cause of error is resolved.
- If P-VOL status is Failure and S-VOL status is unpaired, the pair cannot be recovered by resynchronizing. It must be deleted and created again.
- Resynchronizing pairs when I/O load is low reduces impact on performance. Operations on multiple pairs in the same mirror with different statuses may result in suspension during periods of heavy write I/O.
- If you resynchronize pairs in PAIR status and other than PAIR status in the same mirror, an unexpected suspension could occur during the operation under heavy I/O load conditions. You can estimate whether the I/O load is heavy or not from frequency of host I/Os. This operation should be performed under light I/O load conditions.

Procedure

- 1.** In the **Explorer** pane, expand the **Storage Systems** tree.
- 2.** Expand the target storage system tree, expand **Replication**, and click **Remote Replication**.
- 3.** In the **UR Pairs** tab, select the pairs to be resynchronized and click **Resync Pairs**.
- 4.** In the **Resync Pairs** window, review the pairs in the **Selected Pairs** table. You can remove a pair from the table by selecting it and clicking **Cancel**.

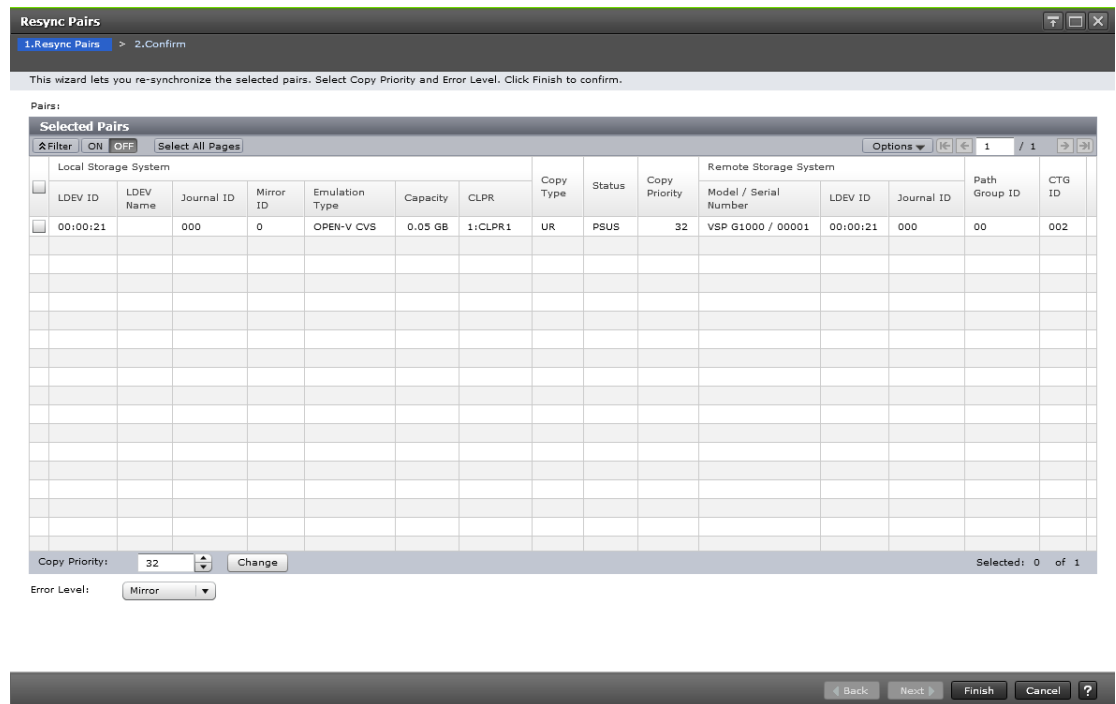

5. For **Copy Priority** list, specify the scheduling order for resynchronizing selected pairs, between 1 and 256.
6. For **Error Level**, specify the system response if a failure occurs during this operation.
 - **Mirror**: Splits all pairs in the failed pair's mirror.
 - **LU**: Splits only the specified pair or pairs that failed.
7. Click **Finish**.
8. In the **Confirm** window, review the settings, enter a task name, and then click **Apply**.

Resynchronizing a mirror

When you resynchronize a mirror, all the pairs with the mirror ID are resynchronized and update data copy to the S-VOL is resumed.

When you use UR with TC and a mirror to which the delta resync pair belongs is resynchronized, the delta resync operation is performed. When you use UR with GAD, resynchronizing the mirror is not necessary for performing delta resync.

Before you begin

- This operation is performed from the primary storage system only.
- Mirror status must be Stopped, Hold, Holding, or Hold(Failure).

- Device Manager - Storage Navigator does not support multiple primary and secondary storage systems in a UR system. In this case, use CCI to restore a mirror.
- Use CCI to restore a mirror that is in a CCI consistency group containing multiple journals.
- Resynchronizing a mirror when I/O load is low reduces impact on performance.
- If performing the delta resync operation, make sure to review [Performing the delta resync operation on page 338](#).

Procedure

1. In the **Explorer** pane, expand the **Storage Systems** tree.
2. Expand the target storage system tree, expand **Replication**, and click **Remote Replication**.
3. On the **Mirrors** tab, select the mirrors to be resynchronized, delta resynchronized, or changed from Hold(Failure) to Hold status, and then click **Resync Mirrors**.
4. In the **Resync Mirrors** window, review the mirrors in the **Selected Mirrors** table. You can remove a mirror from the table by selecting it and clicking **Cancel**.

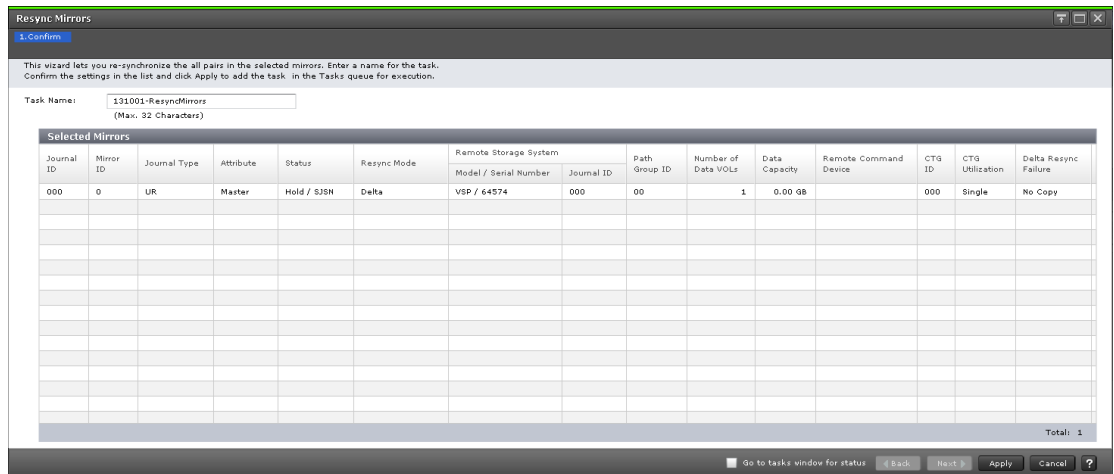

5. Click **Finish**.
6. In the **Confirm** window, review the settings, enter a task name, and then click **Apply**.

Deleting a UR pair

When you delete a pair, the UR relationship between the P-VOL and S-VOL is released. Only the relationship is affected, the data volumes and their data remain.

Before you begin

- You must have the Storage Administrator (Remote Backup Management) role.
- This operation can be performed from the primary or secondary storage system.
- When S-VOLs are physically attached to the same host as P-VOLs, take the S-VOLs offline before releasing the pair. Doing this avoids confusion and possible error when the host is restarted.
- Pairs must be in Suspend status when their journal is in a CCI consistency group consisting of multiple primary and secondary storage systems. If all pairs in the journal are not in Suspend status, you can delete the desired pairs individually, or select Mirror in the Range field, which deletes all pairs in the pair's mirror.

The following additional information might be useful to you before beginning the procedure:

- When a pair deletion is initiated, differential data is transferred from the S-VOL, the pair relationship is ended, and the volumes' status becomes unpaired.
- Pairs should be in PAIR status to ensure data consistency between volumes. However, a pair can be deleted in any status except Suspending or Deleting.
- If you delete a UR pair between the intermediate and secondary sites in a 3DC cascade configuration in which three UR sites are combined, change the status of the mirror between the primary and the intermediate sites to Stopped, or change the status of the pair you want to delete to Suspending.
- If the operation fails, the P-VOL nevertheless becomes unpaired, but transfer of differential data to the S-VOL is terminated.
- If you plan to delete all pairs in the journal and then create another pair, be sure to wait at least one minute after deleting the pairs before creating the new pair.
- Perform pair deletion when write I/O load is low to reduce impact on performance. Operations on pairs with different status in the same mirror may result in suspension during periods of heavy write I/O.
- If you delete pairs in PAIR status and other than PAIR status in the same mirror, an unexpected suspension could occur during the operation under heavy I/O load conditions. You can estimate whether the I/O load is heavy or not from frequency of host I/Os. This operation should be performed under light I/O load conditions.
- In a delta resync configuration with TC, if you release the TC pair, the UR delta resync pair is released as well. If you release the UR pair, the UR delta resync S-VOL is released.
- In a delta resync configuration with GAD, release the pairs in the order of UR pair first, UR delta resync pair second, and then finally the GAD pair.

Procedure

1. In the **Explorer** pane, expand the **Storage Systems** tree.
2. Expand the target storage system tree, expand **Replication**, and click **Remote Replication**.
3. In the **UR Pairs** tab, select the pairs to be deleted and click **More Actions > Delete Pairs**.
4. In the **Delete Pairs** dialog box, review the pairs in the **Selected Pairs** table. To remove a pair from the table, select the pair and click **Cancel**.

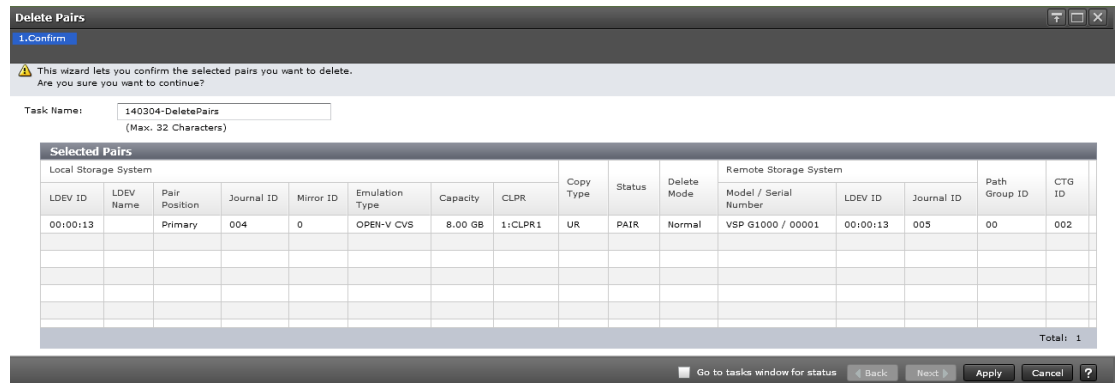

5. For **Delete Mode**, **Normal** is used for UR.



Caution: Note the following:

- Forced deletion in the primary storage system results in data that was not yet sent to the secondary storage system being deleted.
- Forced deletion in the secondary storage system results in data that was not yet restored being deleted.
- If pair status has not changed to SMPL five minutes after you forcibly delete the pair, delete it again.
- Make sure not to re-create the pair in the first five minutes after forcibly deleting it using the same journals (mirrors), even if pair status is SMPL and journal status is Initial: in this case pair creation could fail and the pair might suspend.
- A time-out error can occur at the time of a forced deletion if I/O is sent to another pair in the same journal and the pair's status is PAIR or COPY.

6. Click **Finish**.
7. In the **Confirm** window, review the settings, enter a task name, and then click **Apply**.

Deleting pairs in a mirror

When you delete the pairs in a mirror, data copying between master and restore journals ends.

Before you begin

- This operation can be performed from the primary or secondary storage system.
- When you delete a mirror between the intermediate and secondary sites in a 3DC cascade configuration in which three UR sites are combined, change the status of the mirror between the primary and the intermediate sites to Stopped, or change the status of the mirror between the intermediate and secondary sites to Suspend.
- If a journal includes two mirrors in a configuration which TrueCopy and Universal Replicator are shared:
 - If you specify a mirror in Hold, Holding, or Hold(Failure) status, only the UR pairs of the specified mirror are deleted.
 - If you specify a mirror that is not in Hold, Holding, or Hold(Failure) status, UR pairs of both mirrors (including the mirror that you did not specify) are deleted.

Procedure

1. In the **Explorer** pane, expand the **Storage Systems** tree.
2. Expand the target storage system tree, expand **Replication**, and click **Remote Replication**.
3. On the **Mirrors** tab, select the mirrors to be deleted, and then click **More Actions > Delete Mirrors**.
4. In the **Delete Mirrors** dialog box, review the mirrors in the **Selected Mirrors** table.

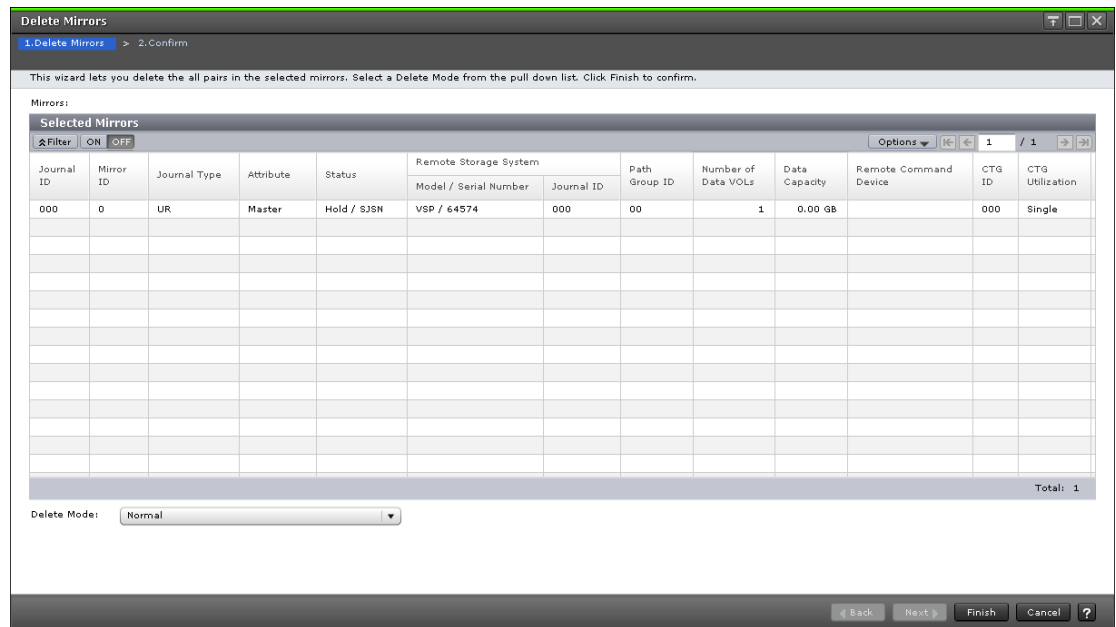

5. For **Delete Mode**, specify one of the following:
 - **Normal**: Mirrors are deleted only if the primary storage system can change the mirror status to Initial.
 - **Force**: Mirrors are forcibly deleted even when the primary storage system cannot communicate with the secondary storage system.
6. Click **Finish**.
7. In the **Confirm** window, review the settings, enter a task name, and then click **Apply**.

Next steps



Note: If the journal (mirror) status is not Initial, even though you deleted pairs forcibly and five minutes have passed, perform the operation again to delete all pairs registered to the mirror. Do not create pairs with the same journal for at least five minutes, even if the journal status was Initial; otherwise pair creation could fail and the pair would be suspended.

Managing pairs in a GAD 3DC delta resync environment (VSP G1000, G1500, and VSP F1500)

This topic describes GAD and UR pair operations in a GAD 3DC delta resync (GAD+UR) environment.

Executing delta resync

When you specify an S-VOL and suspend (swap suspend) a GAD pair, the GAD S-VOL pair status changes from PAIR to SSWS. After the pair status changes to SSWS, the UR delta resync pair changes to a UR pair, and the copying from the GAD S-VOL to the UR S-VOL starts. This change in the copy source of the UR pair is the delta resync operation.

For details about storage system support (models, microcode) for GAD+UR operations, see the *Global-Active Device User Guide*.

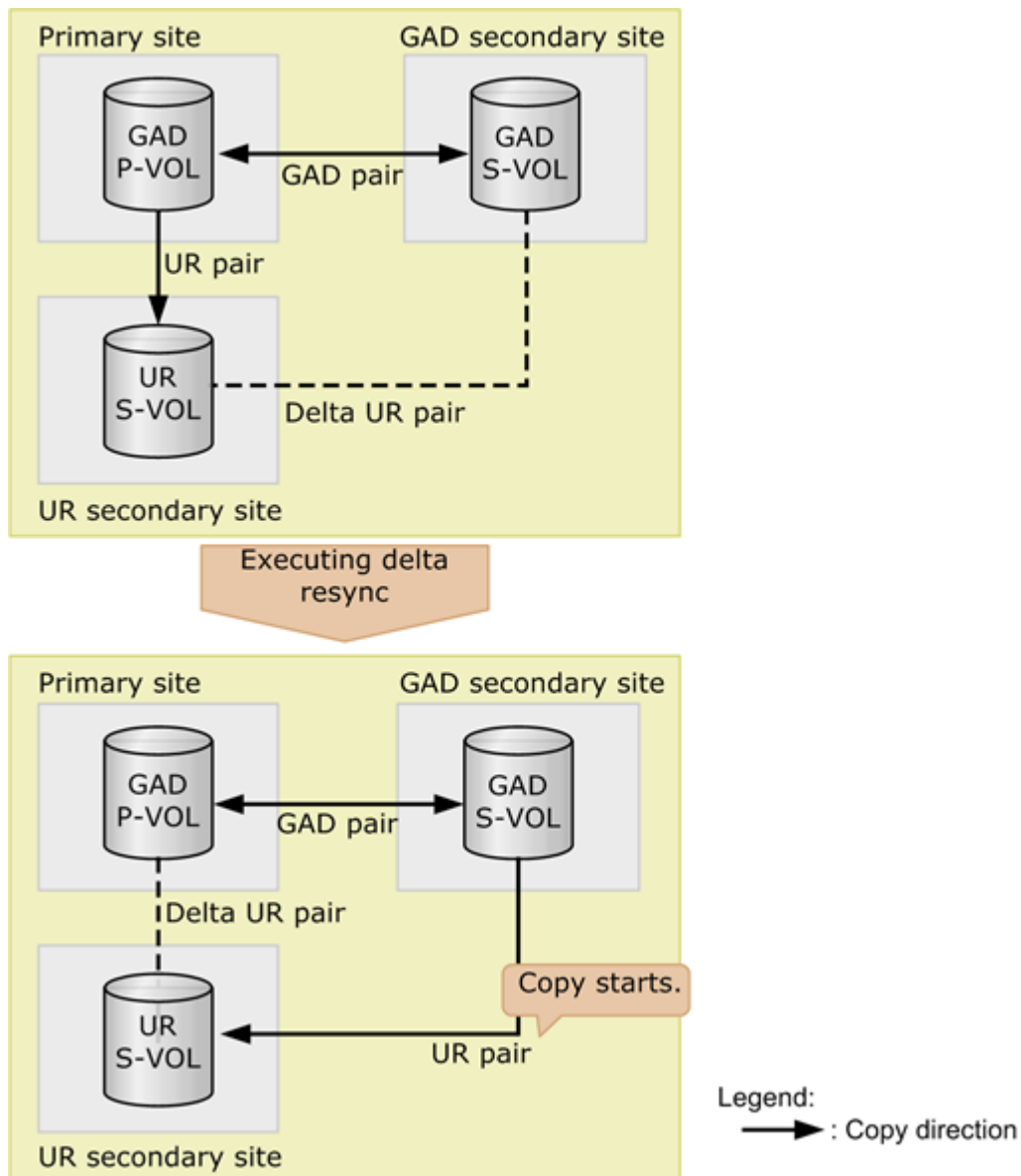

Before you begin

- Pair status and mirror status must be as follows:

Pair type	Pair status		Mirror status	
	P-VOL	S-VOL	Master journal	Restore journal
GAD pair	PAIR	PAIR	Not applicable	Not applicable
UR pair	PAIR	PAIR	PJNN	SJNN
UR delta resync pair	PSUS*	SSUS*	PJNS	SJNS

* If you use Device Manager - Storage Navigator to suspend (swap suspend) the pair, make sure the status of the UR delta resync pair is HOLD.

- All the differential data of the UR pairs is stored in the primary site's journal.
- Data must be able to be transferred between the UR P-VOL and S-VOL.
- The number of S-VOLs in the UR pairs is the same as that in the UR delta resync pairs.
- There is no failure in the remote path between the secondary site of GAD and the secondary site of UR.
- After creating the UR pair, you must keep updating I/O from the server to the GAD pair's P-VOL or S-VOL for about two minutes.

Command example

```
pairsplit -g oraHA -RS -IH1
```

Notes on delta resync

- When a UR pair has not been suspended and resynchronized for a long time, the data in the restore journal might exceed 70% of capacity. If this happens, old journal data is automatically deleted. In this case, the P-VOL and S-VOL are not synchronized completely by just copying the data, and delta resync will fail. In case of delta resync failure, resynchronize the UR pair.
- Journal data might be deleted in the following cases, even if the data in the restore journal does not exceed 70% of capacity:
 - When you update the P-VOL after resynchronizing the GAD pair.
 - When you update the P-VOL after resynchronizing the UR pair between the primary site and UR secondary site.
 - When retry-processing occurs because of a delay of the P-VOL update.
 - When the update of a GAD S-VOL is delayed.
- If the pair status of the UR delta resync pair does not change after the delta resync operation, the prerequisites for delta resync might not be satisfied. Review the prerequisites for the pair status of the GAD pair, UR pair, and UR delta resync pair.

In case of delta resync failure

If delta resync fails, the UR delta resync pair changes to a UR pair. The status of each pair changes as follows:

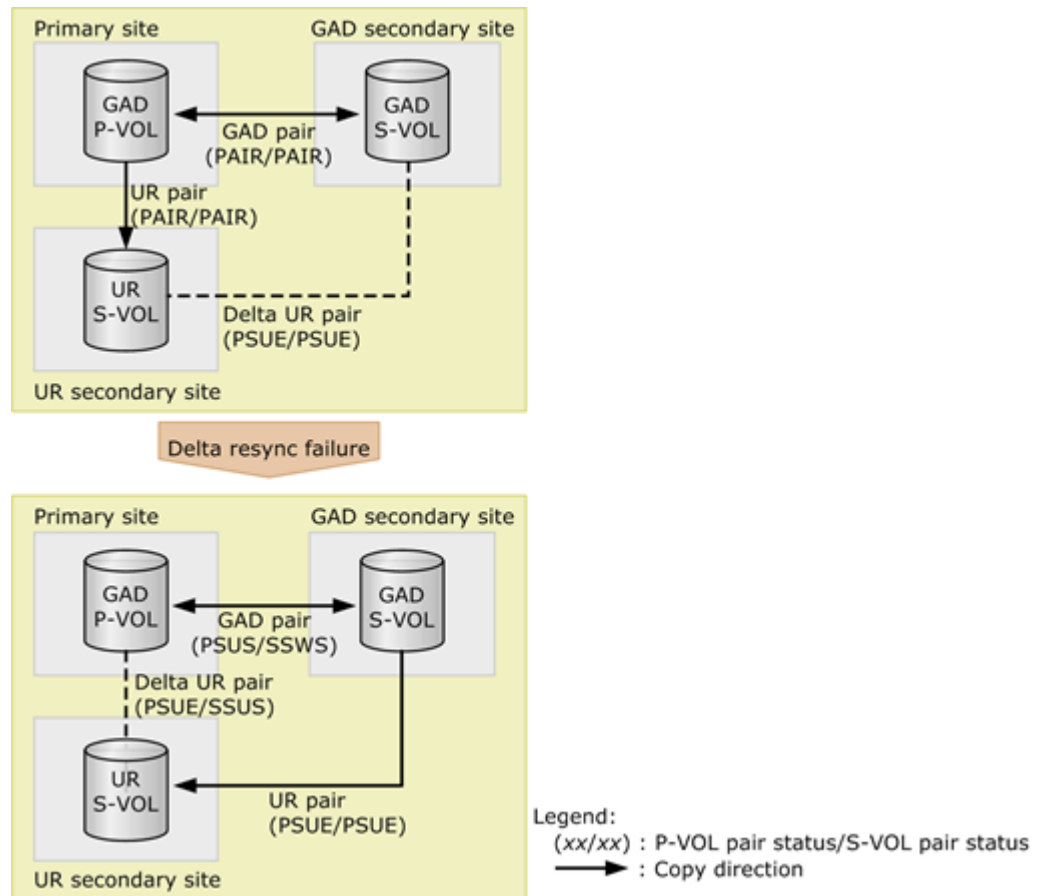

In case of delta resync failure, confirm the following two conditions:

- The system requirements for the GAD+UR configuration are met.
- The system has no failure causes.

If you resynchronize the UR pair after delta resync failure, the initial copy is performed for the GAD pair's S-VOL data to the UR pair's S-VOL.



Note: In a GAD+UR configuration, the data is not copied automatically even if you specify Entire Copy for Delta Resync Failure in the Edit Mirror Options window.

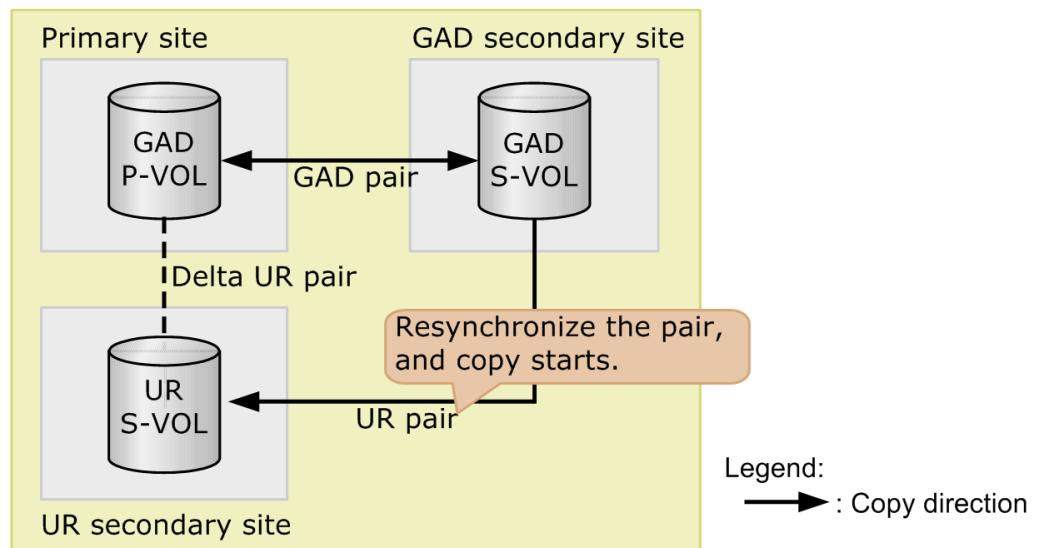

Resynchronizing GAD pairs in a GAD 3DC delta resync environment

To resynchronize a GAD pair by specifying the S-VOL (swap resync), the conditions specified below must be met.

For details about storage system support (models, microcode) for GAD operations, see the *Global-Active Device User Guide*.

Before you begin

- Pair status must be as follows:

Pair type	Pair status	
	P-VOL	S-VOL
GAD pair	PSUS	SSWS
UR pair	PSUE or PAIR	PSUE or PAIR
UR delta resync pair	No condition	No condition

- The UR pair whose volume shared by GAD S-VOL after swap resync must be a UR delta resync pair.

Command example

```
pairresync -g oraHA -swaps -IH1
```

Deleting GAD pairs in a GAD 3DC delta resync environment

For details about storage system support (models, microcode) for GAD+UR operations, see the *Global-Active Device User Guide*.

Before you begin

If you need to delete a GAD pair forcibly, first delete the UR pair and the UR delta resync pair, and then delete the GAD pair forcibly.

Procedure

1. Delete the UR pair.



Note: If you accidentally delete the UR delta resync pair in this step before deleting the UR pair, the UR pair might be suspended by failures.

2. Delete the UR delta resync pair.
3. Suspend the GAD pair.
4. Delete the GAD pair.

GAD 3DC delta resync (GAD+UR) operations

This chapter describes and provides instructions for using CCI commands to implement a GAD 3DC delta resync (GAD+UR) configuration.

For a quorum disk, a volume in an external storage system or a disk in a server is used. Descriptions are based on the assumption that a volume in an external storage system is used as the quorum disk.

- [GAD 3DC delta resync system configuration](#)
- [Workflow for creating a GAD 3DC delta resync environment](#)
- [Initial state](#)
- [Preparing the UR secondary site](#)
- [Installing the software products](#)
- [Creating the command devices](#)
- [Creating the UR delta resync pairs](#)
- [Creating the UR pairs in a GAD+UR configuration](#)
- [Starting GAD+UR operations](#)

GAD 3DC delta resync system configuration

The following figure shows a sample GAD 3DC delta resync (GAD+UR) configuration.

The examples and procedures in this chapter describe this sample GAD+UR configuration.

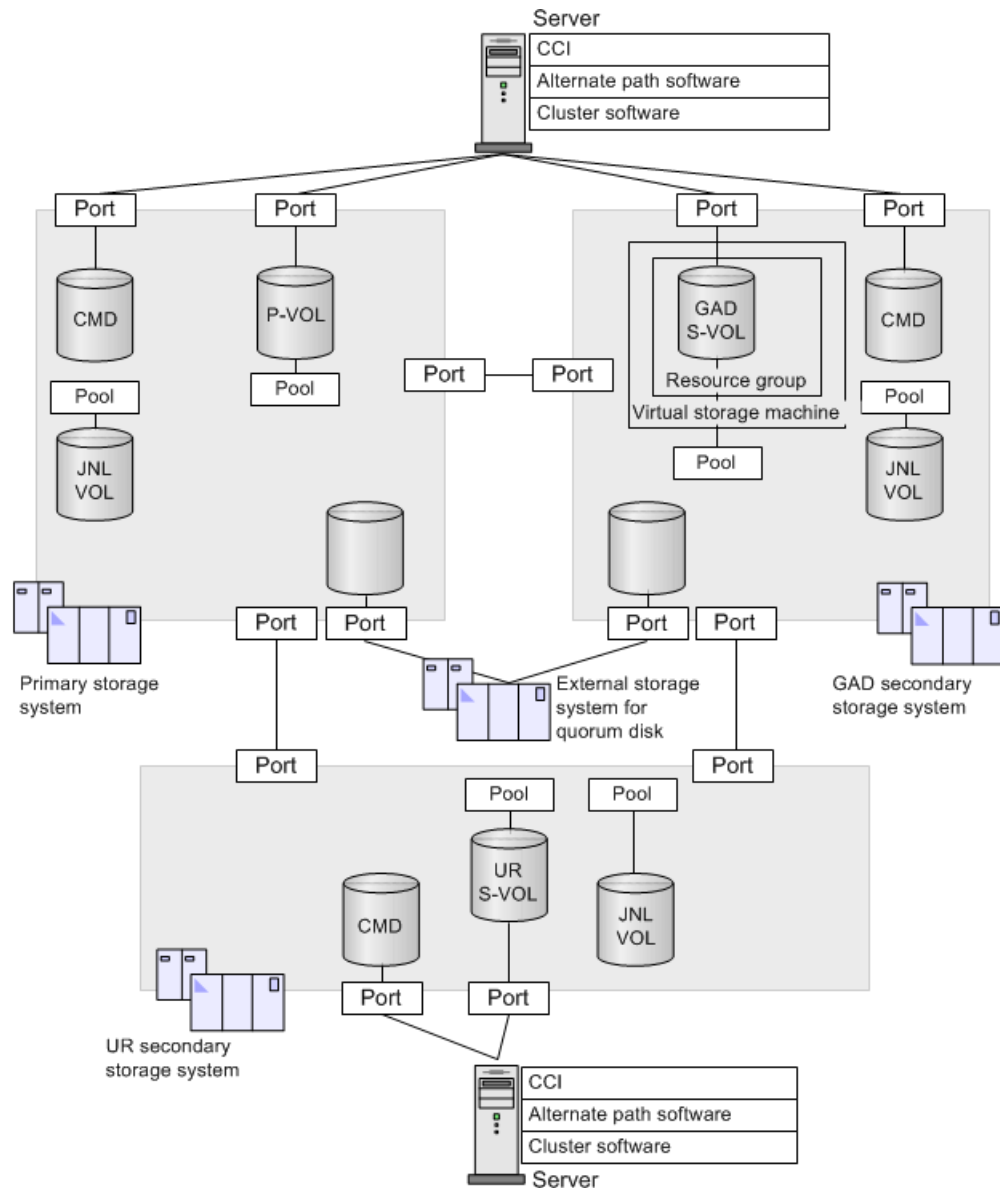

Sites

The GAD+UR configuration spans the following four sites:

- Primary site: Site at which the primary storage system operates.
- GAD secondary site: Site at which the GAD secondary storage system operates.
- UR secondary storage system site: Site at which the UR secondary storage system operates.
- Quorum site: Site at which the external storage system containing the GAD quorum disk operates.

Storage systems

The GAD+UR configuration includes the following storage systems:

- Primary storage system: Contains the P-VOL, UR journal volume (JNL VOL), command device (CMD), and external volume for the quorum disk. The P-VOL and the JNL VOL are virtual volumes of HDP and are assigned capacities from different HDP pools.
- GAD secondary storage system: Contains the GAD S-VOL, delta UR journal volume, command device, external volume for the quorum disk, and the virtual storage machine (VSM). The GAD S-VOL must have the same virtual LDEV ID as the P-VOL. Therefore it is registered to the VSM. The GAD secondary storage system must be the same model as the primary storage system.
- UR secondary storage system: Contains the UR S-VOL, UR/delta UR shared journal volume, command device, and external volume for the quorum disk. The UR secondary storage system can be VSP G1000, VSP G1500, VSP F1500, VSP G800, or VSP F800.
- External storage system: Contains the GAD quorum disk.



Note: In this example the quorum disk resides in a separate external storage system. If desired, the quorum disk can reside in the UR secondary storage system.

Servers

There are two servers in this sample GAD+UR configuration. One server is connected to the primary storage system and the GAD secondary storage system. The other server is connected to the UR secondary storage system. The servers have the following components:

- CCI: Manages the configuration of the GAD/UR/delta UR pairs.
- Configuration definition file: Text file that contains the configuration information for the command device and the GAD/UR/delta UR pairs. It is used by CCI to manage the GAD/UR/delta UR pair configuration.
- Multi-path software: Controls the alternate paths from the host to the P-VOL or S-VOL.
- Cluster software at the primary site and GAD secondary site*: Provides clustering of the active-active configuration between the primary host and the GAD secondary host. In addition, the cluster software on the UR

secondary host provides clustering of the active-passive configuration in which the primary/GAD secondary hosts are active between the primary/GAD secondary hosts and the UR secondary host.

* This item does not apply to the sample configuration described in this chapter. In the sample in this chapter the primary host and GAD secondary host are combined.

- Cluster software at the UR secondary site: Provides clustering of the active-passive configuration in which the remote host becomes the standby host between the primary/secondary host and the remote host.
- Application (Active) at the primary site and GAD secondary site: Active application. Both primary and secondary hosts are active.
- Application (Standby) at the UR secondary site: Standby application.

Networks

The GAD+UR configuration has the following network configurations:

- Network between servers: All servers are connected to the same LAN.
- Networks between storage systems: There are two types of networks, both of which are connected using FC, between the storage systems:
 - Remote connection (primary-to-GAD secondary storage system, primary-to-UR secondary storage system, GAD secondary storage system-to-UR secondary storage system): Establish a bi-directional connection between the Initiator port and the RCU Target port in the primary, GAD secondary, and UR secondary storage systems.
 - External storage connection (primary-to-external storage, GAD secondary storage system-to-external storage system): Establish a connection between the external port in the primary/GAD secondary storage system and the Target port in the external storage system.
- Networks between servers and storage: The servers and storage systems are connected using FC. There are two types of networks between the servers and the storage systems:
 - Connection between the server and the primary/GAD secondary storage system: The server is connected to the primary storage system and GAD secondary storage system.
 - Connection between the server and the UR secondary storage system: The server is connected only to the UR secondary storage system.

GAD+UR pairs

When you create a GAD+UR configuration, the GAD pairs must already be registered to a consistency group.

With GAD+UR, when the statuses of the GAD pair (P-VOL and GAD S-VOL) and the UR pair (P-VOL and UR S-VOL) are PAIR and the UR delta resync pair (GAD S-VOL and UR S-VOL) is in the standby status, the operation is performed normally. When the UR delta resync pair status is HOLD, the pair

status of the P-VOL is displayed as PSUS, and the journal mirror status is displayed as PJNS in CCI.

Primary storage system settings

The following tables list the settings for the sample primary storage system used in the examples and procedures in this chapter.

Primary storage system

Model	Serial number
VSP G1000, G1500, and VSP F1500	11111
VSP G800	411111

Primary volume

Actual LDEV ID	HDP pool ID	Capacity	Port attribute	Port name	LU number
22:22	0	1,024,000 blocks	Target	CL1-A	1

HDP pool volume

Actual LDEV ID	Parity group ID	Capacity
aa:aa	1-1	100 GB
99:99	2-1	100 GB

HDP pool

Pool ID	Pool name	Pool volume	Use
0	PDP_POOL	aa:aa	P-VOL
1	PJNL_POOL	99:99	Journal

Host group

Host group ID	Host group name	Use
CL1-A-1	PVOL_HG1	P-VOL

Journal volume

Actual LDEV ID	HDP pool ID	Capacity
88:88	1	30 GB

Ports for connection between storage systems

Port name	Port attribute	Target storage system	Use
CL3-A	Initiator	GAD secondary storage system	GAD
CL4-A	RCU target	GAD secondary storage system	GAD
CL6-A	Initiator	UR secondary storage system	UR
CL5-C	Target	External storage	Quorum disk

Pair

Pair type	Pair group name	Device name (LDEV ID)	Mirror ID	CTG ID
GAD	oraHA	dev1(22:22)	0	1
UR	oraREMOTE	dev2(22:22)	1	0

Quorum disk

Quorum disk ID
0

GAD secondary storage system settings

The following tables list the settings for the sample GAD secondary storage system used in the examples and procedures in this chapter.

Primary storage system

Model	Serial number
VSP G1000, G1500, and VSP F1500	22222
VSP G800	422222

HDP pool volume

Actual LDEV ID	Parity group ID	Capacity
77:77	13-4	100 GB
99:99	2-1	100 GB

HDP pool

Pool ID	Pool name	Pool volume	Use
0	HA_POOL	77:77	GAD S-VOL
1	LJNL_POOL	99:99	Journal

GAD S-VOL

Actual LDEV ID	HDP pool ID	Capacity	Port attribute	Port name	LU number
44:44	0	1,024,000 block	Target	CL1-C	0

Host group

Host group ID	Host group name	Use
CL1-C-1	1C-G00	GAD S-VOL
CL1-B-1	LVOL_HG2	GAD S-VOL

Journal volume

Actual LDEV ID	HDP pool ID	Capacity
88:88	1	30 GB

Ports for connection between storage systems

Port name	Port attribute	Target storage system	Use
CL3-C	RCU target	Primary storage system	GAD
CL4-C	Initiator	Primary storage system	GAD
CL6-C	Initiator	UR secondary storage system	UR delta resync
CL7-C (VSP G1000, G1500, and VSP F1500)	RCU target	UR secondary storage system	UR delta resync
CL5-C	External	External storage	Quorum disk

Pair

Pair type	Pair group name	Device name (LDEV ID)	Mirror ID	CTG ID
GAD	oraHA	dev1(44:44)	0	1
UR delta resync	oraDELTA	dev3(44:44)	2	0

Quorum disk

Quorum disk ID
0

Resource group

Resource group ID	Resource group name	Virtual storage machine (VSM)	
		Model	Serial number
1	HAGroup1	VSP G1000, G1500, and VSP F1500	11111
		VSP G800	411111

UR secondary storage system settings

The following tables list the settings for the sample UR secondary storage system used in the examples and procedures in this chapter.

Primary storage system

Model	Serial number
VSP G1000, G1500, and VSP F1500	44444
VSP G800	444444

HDP pool volume

Actual LDEV ID	Parity group ID	Capacity
77:77	13-4	100 GB
99:99	2-1	100 GB

HDP pool

Pool ID	Pool name	Pool volume	Use
0	VOL_POOL	77:77	UR S-VOL
1	RJNL_POOL	99:99	Journal

UR S-VOL

Actual LDEV ID	HDP pool ID	Capacity	Port attribute	Port name	LU number
66:66	0	1,024,000 blocks	Target	CL1-A	1

Host group

Host group ID	Host group name	Use
CL1-A-1	REMOTE	UR S-VOL

Journal volume

Actual LDEV ID	HDP pool ID	Capacity
88:88	1	30 GB

Ports for connection between storage systems

Port name	Port attribute	Target storage system	Use
CL6-A	RCU target	Primary storage system	UR
CL7-A VSP G1000, G1500, and VSP F1500	Initiator	Primary storage system	UR
CL6-C	RCU target	GAD secondary storage system	UR delta resync
CL7-C VSP G1000, G1500, and VSP F1500	Initiator	GAD secondary storage system	UR delta resync

Pair

Pair type	Pair group name	Device name (LDEV ID)	Mirror ID	CTG ID
UR	oraREMOTE	dev2(66:66)	1	1
UR delta resync	oraDELTA	dev3(66:66)	2	0

CCI server configuration

The following tables list the CCI configuration settings for the pair management server used in the examples and procedures in this chapter.

CCI settings for the pair management server for the primary and GAD secondary storage systems

Instance number	Configuration definition file	Use
0	horcm0.conf	GAD and UR
100	horcm100.conf	Operation in terms of VSM (serial number 11111) of primary storage system
1	horcm1.conf	GAD and UR delta resync
101	horcm101.conf	Operation in terms of VSM (serial number 11111) of GAD secondary storage system

CCI settings for the pair management server at the UR secondary site

Instance number	Configuration definition file	Use
2	horcm2.conf	UR and UR delta resync

Workflow for creating a GAD 3DC delta resync environment

Replication pairs are created in the following order when you set up a GAD 3DC delta resync (GAD+UR) environment:

1. GAD pair



Note: When you create a GAD+UR configuration, the GAD pairs must already be registered to a consistency group.

2. UR delta resync pair
3. UR pair

Workflow for creating a GAD+UR environment:

1. [Preparing the UR secondary site on page 161](#)
2. [Installing the software products on page 162](#)
3. [Creating the command devices on page 163](#)
4. [Creating the UR delta resync pairs on page 165](#)
5. [Starting GAD+UR operations on page 190](#)

Initial state

This chapter describes and provides instructions for using CCI to add a UR delta resync pair and a UR pair to a system that has a GAD pair. In the initial state before configuration, the necessary devices are installed at the primary site and GAD secondary site, the network required for the connections among

the devices is physically connected, and the GAD pairs have already been created.

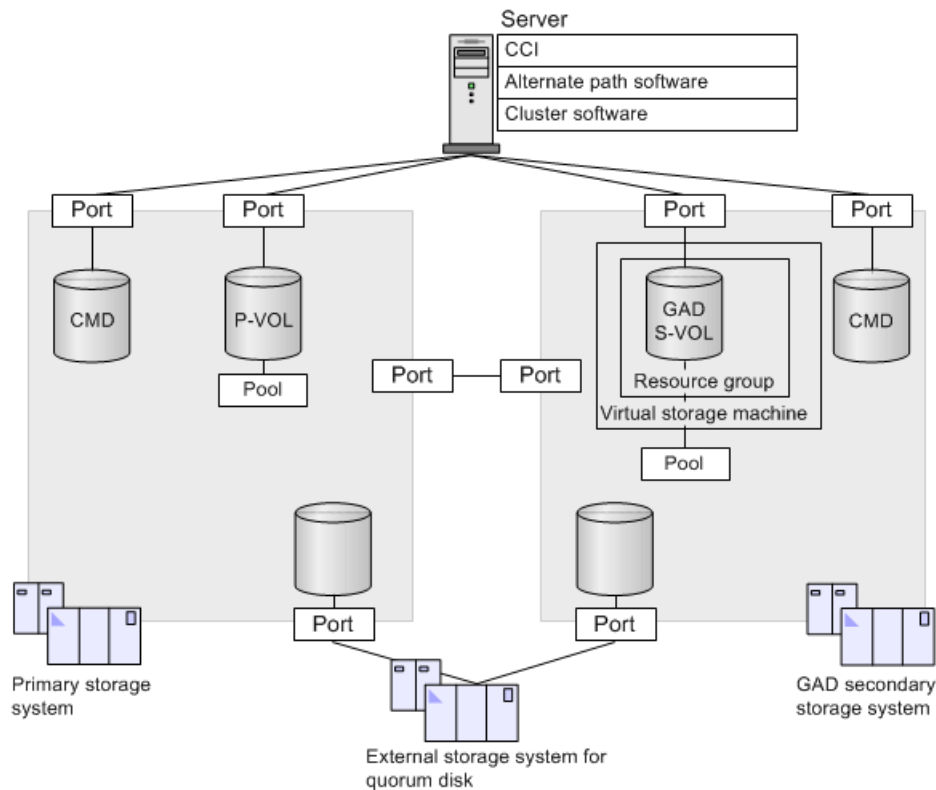

Preparing the UR secondary site

Workflow

1. Install the storage system and server at the UR secondary site.
2. Install the following software on the server:
 - CCI
 - Alternate path software
 - Cluster software
3. Connect the storage system to the server.
4. Connect the storage system to the GAD storage systems with physical paths.

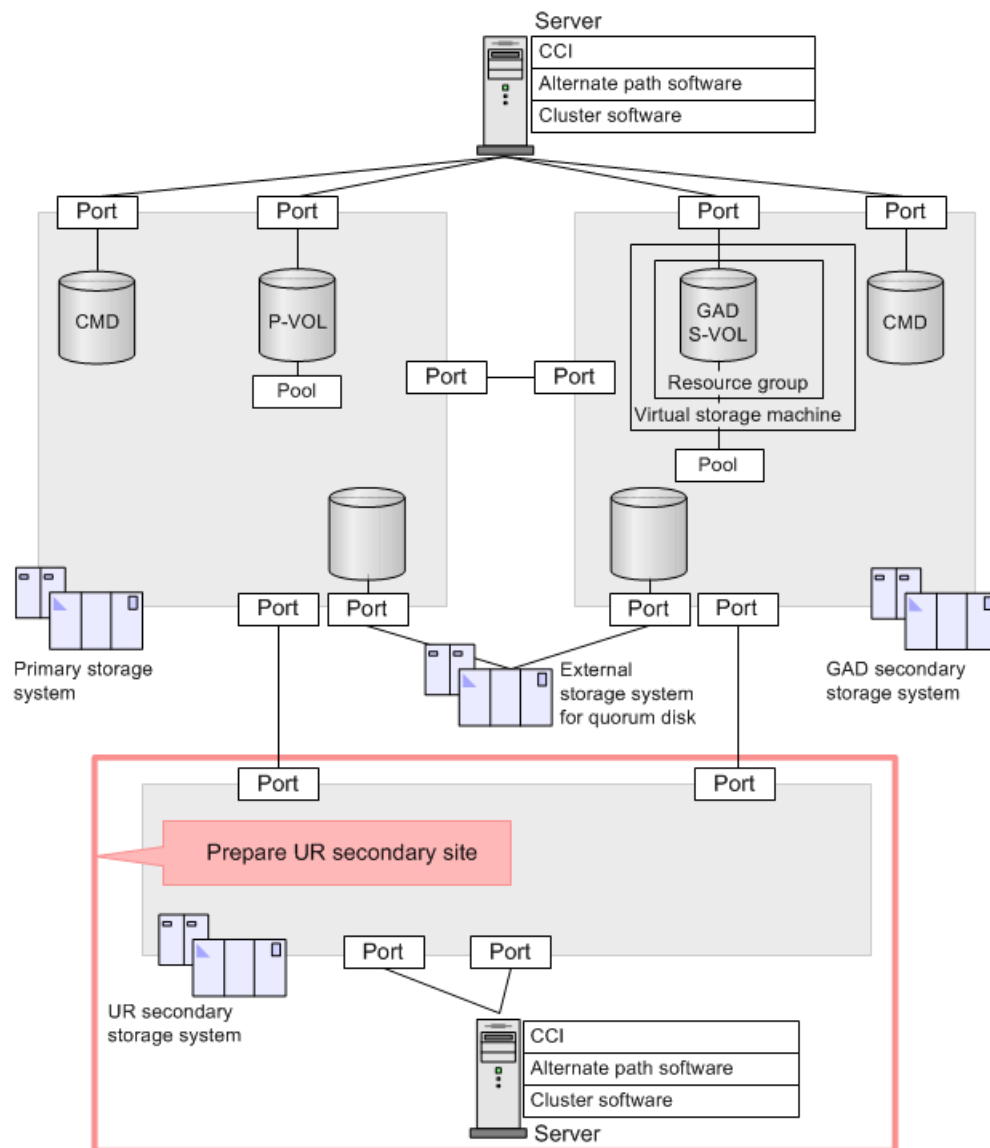

Installing the software products

Install the licenses for the following software products on the primary, GAD secondary, and UR secondary storage systems. For details, see the *System Administrator Guide*.

- Dynamic Provisioning
- TrueCopy
- For VSP G1000, G1500, and VSP F1500: Disaster Recovery Extended
For VSP Gx00 models, VSP Fx00 models: Remote Replication Extended
- Global-active device
- Universal Replicator

Creating the command devices

Create a CCI command device in Resource Group 0 in the UR secondary storage system, and make sure that the server recognizes it. Command devices should already exist in the primary and GAD secondary storage systems.

The following shows the flow of creating a command device. For details, see the *Command Control Interface Installation and Configuration Guide*.

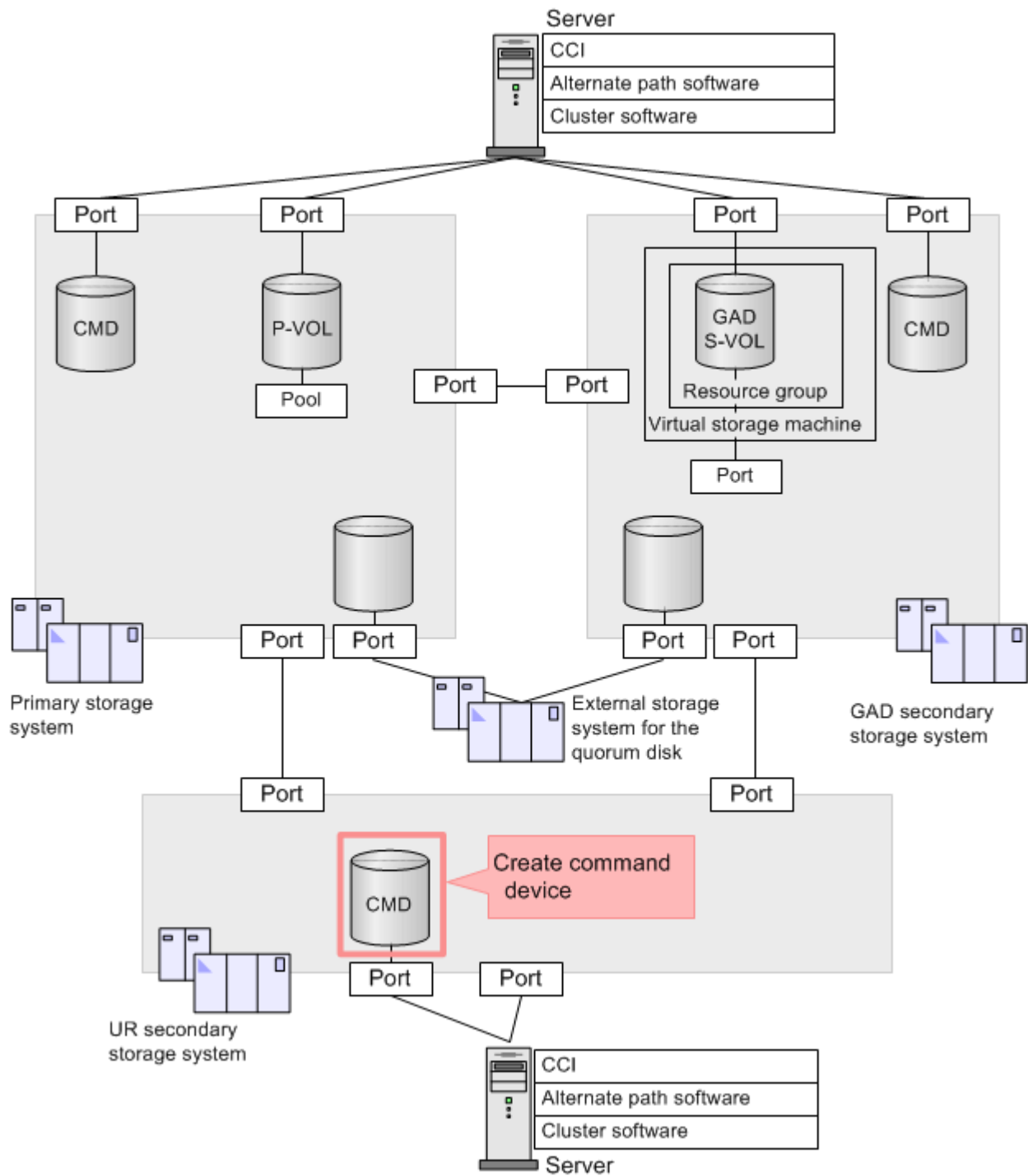

Note: This section describes the procedure for the in-band method using Device Manager - Storage Navigator. The environment can also be set up by using the out-of-band method.

1. Create the volume for the command device in the UR secondary storage system.
2. Format the created volume.
3. Define the created volume on the port connected to the server.
4. Enable the command device attribute of the created volume, and then enable user authentication of the new command device. For details about creating a command device, see the *Provisioning Guide* for the storage system.
5. If necessary, change the topology and fabric settings for the ports defined to the command devices.

Creating the UR delta resync pairs

This section describes the procedure for creating the UR delta resync pairs in your GAD 3DC delta resync (GAD+UR) configuration:

1. [Creating the configuration definition file on page 165](#)
2. [Starting CCI on page 165](#)
3. [Adding the remote connections on page 168](#)
4. [Setting up the GAD secondary storage system on page 170](#)
5. [Setting up the UR secondary storage system on page 172](#)
6. [Updating the CCI configuration definition files on page 177](#)
7. [Creating the UR delta resync pairs on page 179](#)
8. [Creating the UR pairs in a GAD+UR configuration on page 181](#)

Creating the configuration definition file

Create the CCI configuration definition file in the server at the UR secondary site. The following shows the description example of the configuration definition file.

horcm2.conf

```
HORCM_MON
#ip_address      service      poll (10ms)      timeout (10ms)
localhost        31002        -1                3000

HORCM_CMD
\\.\CMD-344444-52733
```

Starting CCI

Start the CCI instance in the server at the UR secondary site. The following shows the example of command execution for Windows.



Note: The configuration definition file created when the GAD pair was created is used for instance 1.

Procedure

1. Start CCI instances 1 and 2.

- Server connected to the GAD secondary storage system

```
horcmstart 1
starting HORCM inst 1
HORCM inst 1 starts successfully.
```

- Server connected to the UR secondary storage system

```
horcmstart 2
starting HORCM inst 2
HORCM inst 2 starts successfully.
```

2. Enter the user name and the password to authenticate the user.

- Server connected to the GAD secondary storage system

```
raidcom -login <username> <password> -IH1
```

- Server connected to the UR secondary storage system

```
raidcom -login <username> <password> -IH2
```

The `-IH` option in this example is used for each command to specify an instance. You can also perform the operation using a shell for each instance. To start the shell, specify an instance number to the environment variable `HORCMINST`, and then execute the command.

Connecting the GAD secondary system and the UR secondary system

To connect the GAD secondary storage system and the UR secondary storage system, set the port attributes and then add the remote connection between the two storage systems.

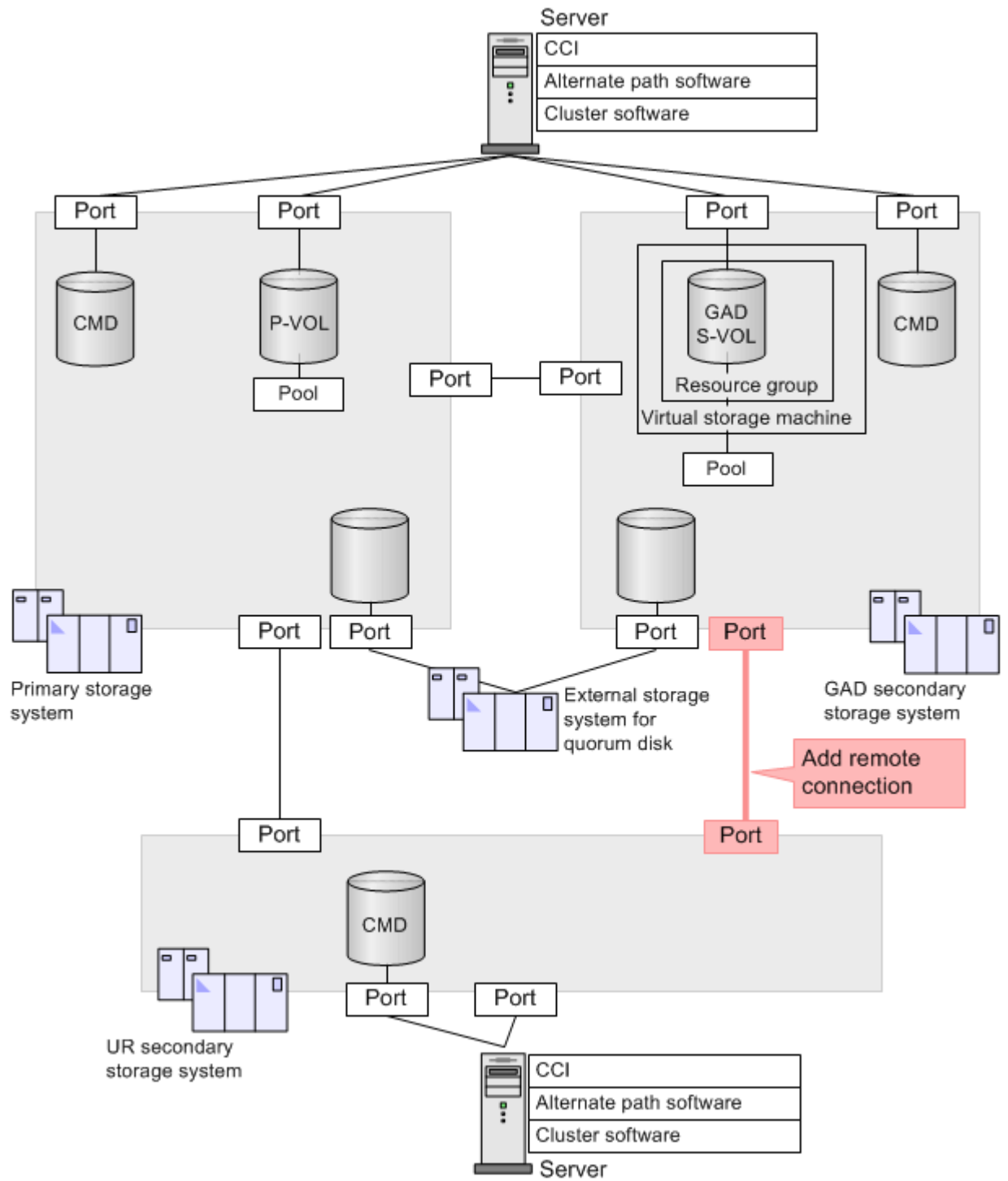

Setting the port attributes

To establish the bi-directional remote connections between the GAD secondary storage system and the UR secondary storage system, first set the

port attributes on each storage system. The following shows the example of command execution for Windows.

Procedure

1. Set the attributes of Initiator port and RCU Target port in the GAD secondary storage system and the UR secondary storage system.
 - Server connected to the GAD secondary storage system

```
raidcom modify port -port CL6-C -port_attribute MCU -IH1
raidcom modify port -port CL7-C -port_attribute RCU -IH1
```

- Server connected to the UR secondary storage system

```
raidcom modify port -port CL6-C -port_attribute RCU -IH2
raidcom modify port -port CL7-C -port_attribute MCU -IH2
```



Note: Use the same procedure to change the port attributes for the alternate paths.

2. Check the setting of the port attribute.
 - Server connected to the GAD secondary storage system

```
raidcom get port -IH1
PORT    TYPE    ATTR  SPD  LPID  FAB  CONN  SSW  SL  Serial#  WWN
PHY_PORT
(Omitted)
CL6-C   FIBRE   MCU   AUT  E8    N    FCAL  N    0   322222  50060e80072b6720 -
(Omitted)
CL7-C   FIBRE   RCU   AUT  97    N    FCAL  N    0   322222  50060e80072b6730 -
(Omitted)
```

- Server connected to the UR secondary storage system

```
raidcom get port -IH2
PORT    TYPE    ATTR  SPD  LPID  FAB  CONN  SSW  SL  Serial#  WWN
PHY_PORT
(Omitted)
CL6-C   FIBRE   RCU   AUT  E8    N    FCAL  N    0   344444  50060e80072b6720 -
(Omitted)
CL7-C   FIBRE   MCU   AUT  97    N    FCAL  N    0   344444  50060e80072b6730 -
(Omitted)
```

Adding the remote connections

After setting the port attributes, add the bidirectional remote connections between the GAD secondary storage system and UR secondary storage system. Use the same path group ID for the bidirectional remote connections. The following shows the example of command execution for Windows.

**Note:**

- When specifying the serial number for VSP G1000, G1500, and VSP F1500 using CCI, add a "3" at the beginning of the serial number. For example, for serial number 11111, enter 311111.
- To specify the VSP G1000, G1500, and VSP F1500, enter R800.
- The VSP G1000, G1500, and VSP F1500 is displayed as R8 in command output.

Procedure

1. Add a bi-directional remote connection between the GAD secondary storage system and UR secondary storage system. Add a remote connection whose path group ID is 1 from port CL6-C in the GAD secondary storage system to port CL6-C in the UR secondary storage system, and add a remote connection whose path group ID is 1 from port CL6-C in the UR secondary storage system to port CL6-C in the GAD secondary storage system. Specify the same path group ID to the bidirectional remote connections. After executing the command, confirm that the asynchronous command processing ended normally.

- Server connected to the GAD secondary storage system

```
raidcom add rcu -cu_free 344444 R800 1 -mcu_port CL6-C -rcu_port CL6-C -IH1
raidcom get command_status -IH1
HANDLE   SSB1   SSB2   ERR_CNT   Serial#   Description
00c3    -     -     0         322222    -
```

- Server connected to the UR secondary storage system

```
raidcom add rcu -cu_free 322222 R800 1 -mcu_port CL7-C -rcu_port CL7-C -IH2
raidcom get command_status -IH2
HANDLE   SSB1   SSB2   ERR_CNT   Serial#   Description
00c3    -     -     0         344444    -
```

After adding the initial connections between the storage systems using the `raidcom add rcu` command, add the alternate paths between the storage systems using the `raidcom add rcu_path` command.

2. Check the settings of the remote connection.

- Server connected to the GAD secondary storage system

```
raidcom get rcu -cu_free 344444 R800 1 -IH1
Serial# ID PID MCU RCU M/R T PNO MPORT RPORT STS_CD SSIDs
344444 R8 0 - - RCU F 1 CL6-C CL6-C NML_01 -
```

- Server connected to the UR secondary storage system

```
raidcom get rcu -cu_free 322222 R800 1 -IH2
Serial# ID PID MCU RCU M/R T PNO MPORT RPORT STS_CD SSIDs
322222 R8 0 - - RCU F 1 CL7-C CL7-C NML_01 -
```

Setting up the GAD secondary storage system

To set up the GAD secondary storage system, you must create a pool volume of HDP pool for journal, create an HDP pool for journal, create a journal volume, and create a journal. The following shows the example of command execution for Windows.

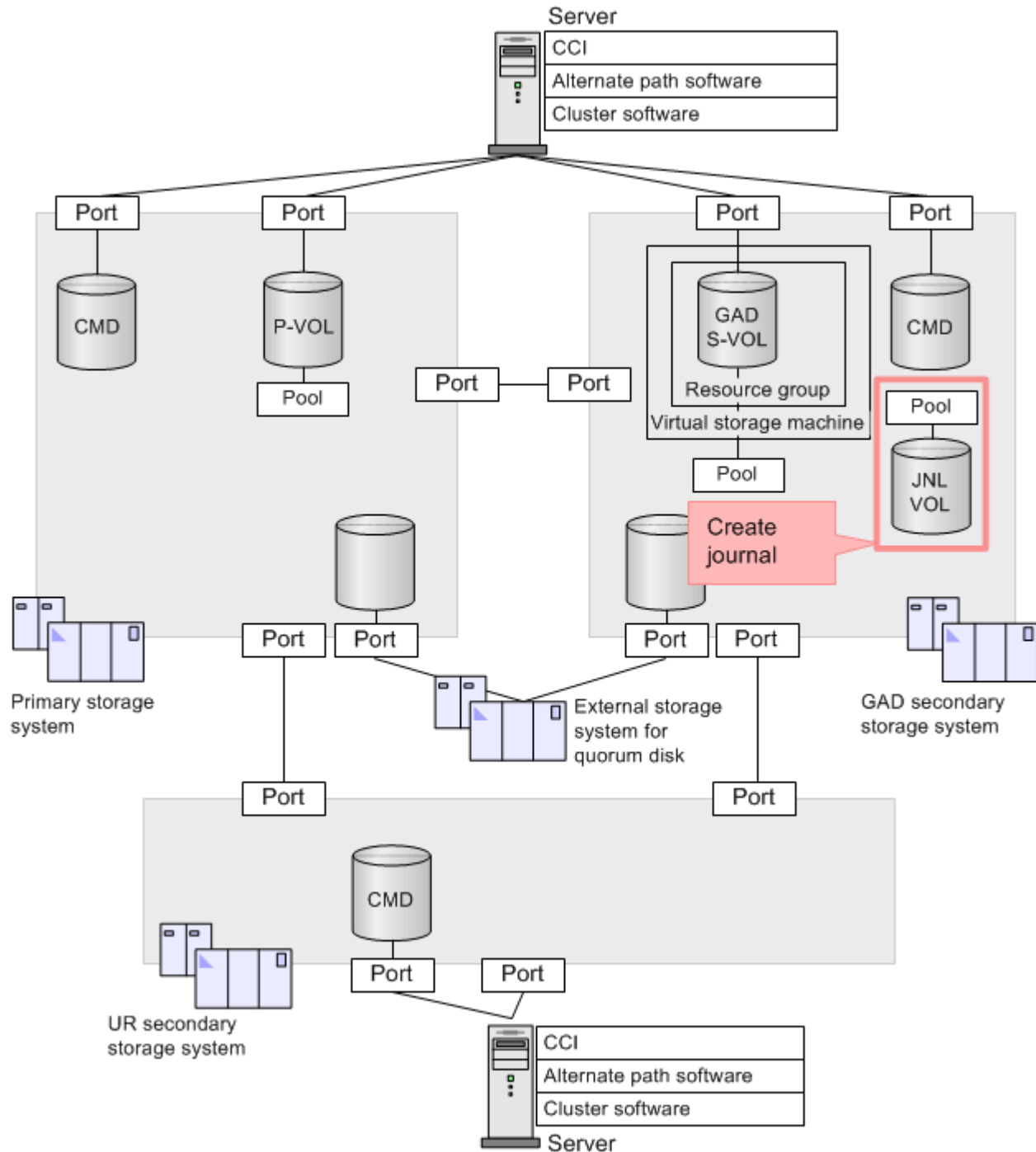

Procedure

1. Create a pool volume. Specify Parity group 2-1 and create volume 100 GB whose LDEV ID is 0x9999. After executing the command, confirm that the asynchronous command processing ended normally.

```
raidcom add ldev -ldev_id 0x9999 -parity_grp_id 2-1 -capacity 100G -IH1
raidcom get command_status -IH1
HANDLE  SSB1  SSB2  ERR_CNT  Serial#  Description
00c3    -    -    0    322222  -
```

2. Perform quick format of the created volume. After executing the command, confirm that the asynchronous command processing ended normally.

```
raidcom initialize ldev -operation qfmt -ldev_id 0x9999 -IH1
raidcom get command_status -IH1
HANDLE  SSB1  SSB2  ERR_CNT  Serial#  Description
00c3    -    -    0    322222  -
```

3. Create a pool. Specify the created volume 0x9999 in the pool volume and create an HDP pool whose pool ID is 1 and pool name is LJNL_POOL. After executing the command, confirm that the asynchronous command processing ended normally.

```
raidcom add dp_pool -pool_id 1 -pool_name LJNL_POOL -ldev_id 0x9999 -IH1
raidcom get command_status -IH1
HANDLE  SSB1  SSB2  ERR_CNT  Serial#  Description
00c3    -    -    0    322222  -
```

4. Confirm that the volume (LDEV ID: 0x9999) is set in the pool volume in the pool (Pool ID: 1).

```
raidcom get ldev -ldev_id 0x9999 -fx -IH1
Serial# : 322222
LDEV : 9999
(Omitted)
F_POOLID : 1
VOL_ATTR : CVS : POOL
(Omitted)
```

5. Check the pool capacity.

```
raidcom get dp_pool -IH1
PID  POLS  U(%)  AV_CAP(MB)  TP_CAP(MB)  W(%)  H(%)  Num  LDEV#  LCNT
TL_CAP(MB)
001  POLN  0  98196  98196  70
80    1    39321  0    0    0
```

6. Check the pool name.

```
raidcom get pool -key opt -IH1
PID  POLS  U(%)  POOL_NAME  Seq#  Num  LDEV#  H(%)
VCAP(%)  TYPE  PM
001  POLN  0  LJNL_POOL  322222  1  39321
80    -    OPEN  N
```

7. Create a journal volume. Create a virtual volume (DP-VOL) whose capacity is 30 GB and LDEV ID is 0x8888 in HDP pool ID 1. After

executing the command, confirm that the asynchronous command processing ended normally.

```
raidcom add ldev -pool 1 -ldev_id 0x8888 -capacity 30G -IH1
raidcom get command_status -IH1
HANDLE  SSB1  SSB2  ERR_CNT  Serial#  Description
00c3    -    -    0    322222    -
```

8. Check the created volume.

```
raidcom get ldev -ldev_id 0x8888 -fx -IH1
Serial# : 322222
LDEV : 8888
(omitted)
VOL_ATTR : CVS : HDP
(omitted)
```

9. Create a journal. Specify the volume whose LDEV ID is 0x8888 to create a journal whose journal ID is 0. After executing the command, confirm that the asynchronous command processing ended normally.

```
raidcom add journal -journal_id 0 -ldev_id 0x8888 -IH1
raidcom get command_status -IH1
HANDLE  SSB1  SSB2  ERR_CNT  Serial#  Description
00c3    -    -    0    322222    -
```

10. Confirm that the volume (LDEV ID: 0x8888) is registered to the journal (journal ID: 0) and check the journal capacity.

```
raidcom get journal -IH1
JID MU CTG JNLS AP U(%) Q-Marker Q-CNT D-SZ (BLK) Seq# Num LDEV#
000 0 1 PJNN 4 21 43216fde 30 62914560 322222 1 34952
```

Setting up the UR secondary storage system

To set up the UR secondary storage system, you must create a pool volume of HDP pool for journal, create an HDP pool for journal, create a journal volume, create a journal, create a pool volume of HDP pool for the UR S-VOL, create an HDP pool for the UR S-VOL, create a UR S-VOL, create a host group, and add an LU path. The following figure provides an overview of creating a journal and the UR secondary volume in the UR secondary storage system.

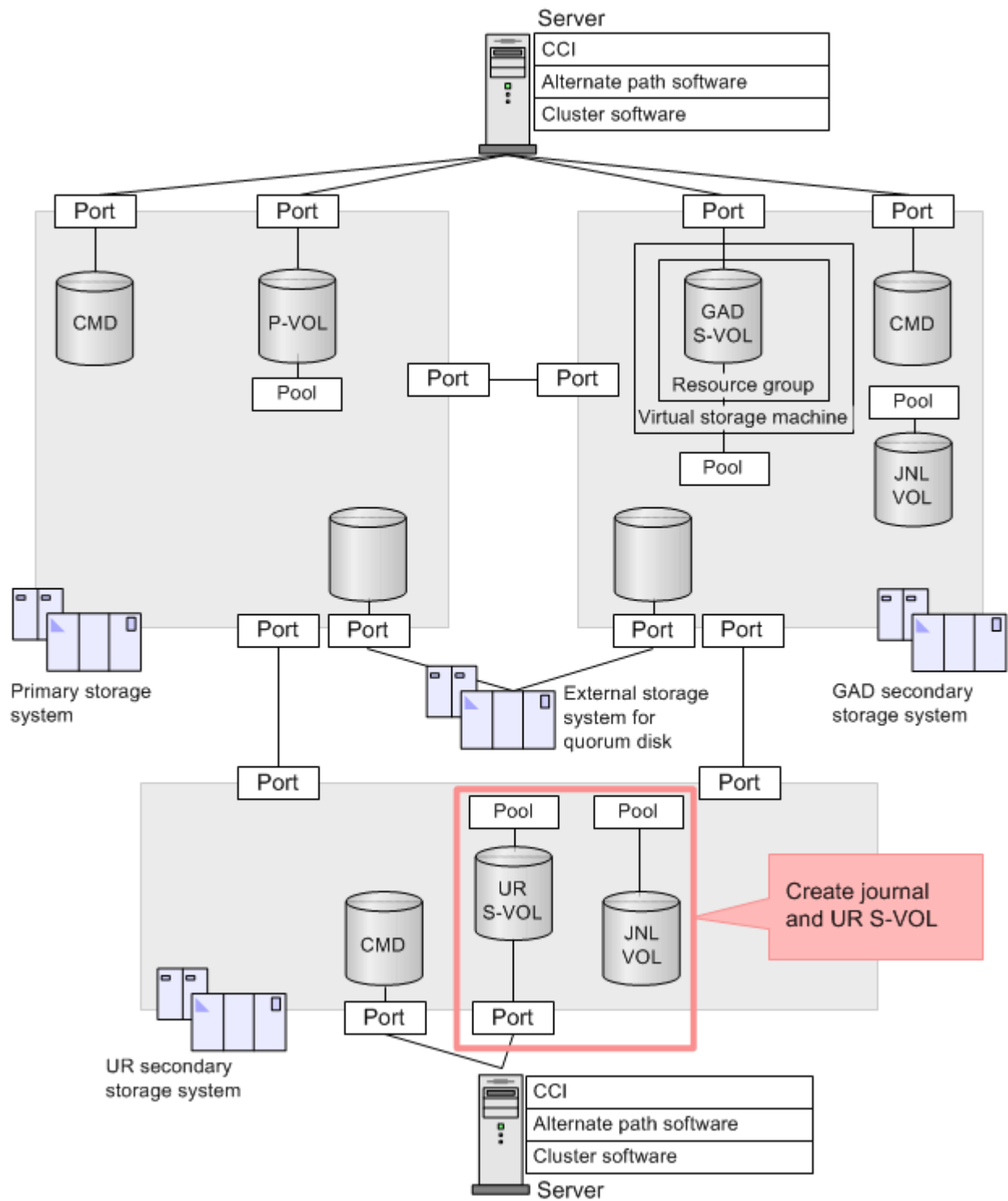

The following shows the example of command execution for Windows.



Note: This example uses a pool volume of HDP pool for the UR S-VOL. This is not a requirement.

Procedure

1. Use the following parameters and procedure to create pool volumes of HDP pool for journal, create HDP pool for journal, create journal volume, and create journal in the UR secondary storage system:

Parameters:

- RM instance ID: 2
- Parity group : 2-1
- Pool volume LDEV ID: 0x9999
- Pool volume LDEV capacity : 100 GB
- Pool ID: 1
- Pool name : RJNL_POOL
- Journal volume LDEV ID: 0x8888
- Journal volume LDEV capacity: 30 GB
- Journal ID: 0

- a. Create a pool volume. Specify Parity group 2-1 and create volume 100 GB whose LDEV ID is 0x9999. After executing the command, confirm that the asynchronous command processing ended normally.

```
raidcom add ldev -ldev_id 0x9999 -parity_grp_id 2-1 -capacity 100G -IH2
raidcom get command_status -IH2
HANDLE  SSB1  SSB2  ERR_CNT  Serial#  Description
00c3    -    -    0    344444  -
```

- b. Perform quick format of the created volume. After executing the command, confirm that the asynchronous command processing ended normally.

```
raidcom initialize ldev -operation qfmt -ldev_id 0x9999 -IH2
raidcom get command_status -IH2
HANDLE  SSB1  SSB2  ERR_CNT  Serial#  Description
00c3    -    -    0    344444  -
```

- c. Create a pool. Specify the created volume 0x9999 in the pool volume and create an HDP pool whose pool ID is 1 and pool name is RJNL_POOL. After executing the command, confirm that the asynchronous command processing ended normally.

```
raidcom add dp_pool -pool_id 1 -pool_name RJNL_POOL -ldev_id 0x9999 -IH2
raidcom get command_status -IH2
HANDLE  SSB1  SSB2  ERR_CNT  Serial#  Description
00c3    -    -    0    344444  -
```

- d. Confirm that the volume (LDEV ID: 0x9999) is set in the pool volume in the pool (Pool ID: 1).

```
raidcom get ldev -ldev_id 0x9999 -fx -IH2
Serial# : 344444
LDEV : 9999
(Omitted)
F_POOLID : 1
VOL_ATTR : CVS : POOL
(Omitted)
```

- e. Check the pool capacity.

```
raidcom get dp_pool -IH2
PID POLS U(%) AV_CAP(MB) TP_CAP(MB) W(%) H(%) Num LDEV# LCNT TL_CAP(MB)
```

```
001 POLN 0 98196 98196 70 80 1 39321
0 0
```

f. Check the pool name.

```
raidcom get pool -key opt -IH2
PID POLS U(%) POOL_NAME Seq# Num LDEV# H(%) VCAP(%) TYPE PM
001 POLN 0 RJNL_POOL 344444 1 39321 80 - OPEN N
```

g. Create a journal volume. Create a virtual volume (DP-VOL) whose capacity is 30 GB and LDEV ID is 0x8888 in HDP pool ID 1. After executing the command, confirm that the asynchronous command processing ended normally.

```
raidcom add ldev -pool 1 -ldev_id 0x8888 -capacity 30G -IH2
raidcom get command_status -IH2
HANDLE SSB1 SSB2 ERR_CNT Serial# Description
00c3 - - 0 344444 -
```

h. Check the created journal volume.

```
raidcom get ldev -ldev_id 0x8888 -fx -IH2
Serial# : 344444
LDEV : 8888
(omitted)
VOL_ATTR : CVS : HDP
(omitted)
```

i. Create a journal. Specify the volume whose LDEV ID is 0x8888 to create a journal whose journal ID is 0. After executing the command, confirm that the asynchronous command processing ended normally.

```
raidcom add journal -journal_id 0 -ldev_id 0x8888 -IH2
raidcom get command_status -IH2
HANDLE SSB1 SSB2 ERR_CNT Serial# Description
00c3 - - 0 344444 -
```

j. Confirm that the volume (LDEV ID: 0x9999) is registered to the journal (journal ID: 0) and check the journal capacity.

```
raidcom get journal -IH2
JID MU CTG JNLS AP U(%) Q-Marker Q-CNT D-SZ (BLK) Seq#
Num LDEV#
000 0 1 PJNN 4 21 43216fde 30 62914560 322222
1 34952
```

2. Use the following parameters and procedure to create pool volumes of HDP pool for the UR S-VOL and create an HDP pool for the UR S-VOL in the UR secondary storage system:

- RM instance ID: 2
- Parity group : 13-4
- Pool volume LDEV ID: 0x7777
- Pool volume LDEV capacity : 100 GB
- Pool ID: 0
- Pool name : VOL_POOL

- a. Create a pool volume. Specify Parity group 13-4 and create volume 100 GB whose LDEV ID is 0x7777. After executing the command, confirm that the asynchronous command processing ended normally.

```
raidcom add ldev -ldev_id 0x7777 -parity_grp_id 13-4 -capacity 100G -IH2
raidcom get command_status -IH2
HANDLE  SSB1  SSB2  ERR_CNT  Serial#  Description
00c3    -    -    0    344444  -
```

- b. Perform quick format of the created volume. After executing the command, confirm that the asynchronous command processing ended normally.

```
raidcom initialize ldev -operation qfmt -ldev_id 0x7777 -IH2
raidcom get command_status -IH2
HANDLE  SSB1  SSB2  ERR_CNT  Serial#  Description
00c3    -    -    0    344444  -
```

- c. Create a pool. Specify the created volume 0x7777 in the pool volume and create an HDP pool whose pool ID is 0 and pool name is VOL_POOL. After executing the command, confirm that the asynchronous command processing ended normally.

```
raidcom add dp_pool -pool_id 0 -pool_name VOL_POOL -ldev_id 0x7777 -IH2
raidcom get command_status -IH2
HANDLE  SSB1  SSB2  ERR_CNT  Serial#  Description
00c3    -    -    0    344444  -
```

- d. Confirm that the volume (LDEV ID: 0x7777) is set in the pool volume in the pool (Pool ID: 0).

```
raidcom get ldev -ldev_id 0x7777 -fx -IH2
Serial# : 344444
LDEV : 7777
(Omitted)
F_POOLID : 0
VOL_ATTR : CVS : POOL
(Omitted)
```

- e. Check the pool capacity.

```
raidcom get dp_pool -IH2
```

PID	POLS	U(%)	AV_CAP(MB)	TP_CAP(MB)	W(%)	H(%)	Num
LDEV#	LCNT	TL_CAP(MB)					
000	POLN	0	98196	98196		70	80
30583	0	0					0

- f. Check the pool name.

```
raidcom get pool -key opt -IH2
```

PID	POLS	U(%)	POOL_NAME	Seq#	Num	LDEV#	H(%)
VCAP(%)	TYPE	PM					
001	POLN	0	VOL_POOL	344444	0	30583	80
-	OPEN	N					

3. Create the UR S-VOL. Create a virtual volume (DP-VOLs) whose capacity is 1,024,000 blocks and LDEV ID is 0x6666 in HDP pool 0. After executing the command, confirm that the asynchronous command processing ended normally.

```
raidcom add ldev -pool 1 -ldev_id 0x6666 -capacity 1024000 -IH2
raidcom get command_status -IH2
HANDLE  SSB1  SSB2  ERR_CNT  Serial#  Description
00c3    -    -    0    344444  -
```

4. Check the information of the volumes (LDEV ID: 0x6666).

```
raidcom get ldev -ldev_id 0x6666 -fx -IH2
Serial# : 344444
LDEV : 6666 VIR_LDEV : 6666
(Omitted)
VOL_Capacity(BLK) : 41943040
(Omitted)
VOL_ATTR : CVS : HDP
B_POOLID : 0
(Omitted)
```

5. Create a host group. In port CL1-A, create a host group whose host group ID is 1 and host group name is REMOTE. Set the host mode for the host group as necessary.



Note: A host group with host group ID 0 exists by default. Perform this procedure only if you want to create a host group with host group ID 1 or greater.

```
raidcom add host_grp -port CL1-A-1 -host_grp_name REMOTE -IH2
raidcom modify host_grp -port CL1-A-1 -host_mode WIN -IH2
```

6. Check the information of the host group set in the port (CL1-A).

```
raidcom get host_grp -port CL1-A -IH2
PORT  GID  GROUP_NAME  Serial#  HMD  HMO_BITS
CL1-A  0    1C-G00      344444   WIN
CL1-A  1    REMOTE      344444   WIN
```

7. Add an LU path to the UR S-VOL. When adding an LU path to UR S-VOL 0x6666, specify host group CL1-A-1 and LU 1.

```
raidcom add lun -port CL1-A-1 -lun_id 1 -ldev_id 0x6666 -IH2
```

8. Check the LU path information defined in host group CL1-A-0.

```
raidcom get lun -port CL1-A-1 -fx -IH2
PORT  GID  HMD  LUN  NUM  LDEV  CM  Serial#  HMO_BITS
CL1-A  1    WIN  1    1    6666  -   344444
```

Updating the CCI configuration definition files

Update the CCI configuration definition file to create a UR delta resync pair. The following shows an example of command execution for Windows and the description example of the configuration definition file for Windows.

Procedure

1. Stop the CCI instances at the GAD secondary site and UR secondary site.
 - Server connected to the GAD secondary storage system

```
horcmshutdown 1
inst 1:
horcmshutdown inst 1 !!!
```

- Server connected to the UR secondary storage system

```
horcmshutdown 2
inst 2:
horcmshutdown inst 2 !!!
```

2. Edit the configuration definition files at the GAD secondary site and UR secondary site. Add the underlined parts below to the configuration definition files at the GAD secondary site and UR secondary site.



Note: Make sure to specify the actual LDEV IDs for the GAD pair volumes, not the virtual LDEV IDs.

When specifying the serial number for VSP G1000, G1500, and VSP F1500 using CCI, add a "3" at the beginning of the serial number. For example, for serial number 22222, enter 322222. For VSP Gx00 models, specify the six-digit serial number that begins with 4 as is (for example, 422222).

- Example of editing the configuration definition file at the GAD secondary site: horcm1.conf

```
HORCM_MON
#ip_address      service      poll(10ms)      timeout(10ms)
localhost        31001        -1               3000

HORCM_CMD
\\.\CMD-322222-52734

HORCM_LDEV
#GRP      DEV      SERIAL  LDEV#  MU#
oraHA     dev1    322222  44:44  h0
oraDELTA dev3    322222  44:44  h2

HORCM_INST
#GPR      IP ADR      PORT#
oraHA     localhost   31000

HORCM_INSTP
#dev_group ip_address  service    pathID
oraDELTA  localhost  31002     1
```

- Example of editing the configuration definition file at the UR secondary site: horcm2.conf

```
HORCM_MON
#ip_address      service      poll(10ms)      timeout(10ms)
localhost        31002        -1               3000

HORCM_CMD
\\.\CMD-344444-52733

HORCM_LDEV
#GRP      DEV      SERIAL  LDEV#  MU#
oraDELTA  dev3    344444  66:66  h2
```

```
HORCM_INSTP
#dev_group  ip_address  service  pathID
oraDELTA    localhost  31001    1
```

3. Start the CCI instances at the GAD secondary site and UR secondary site.
 - Server connected to the GAD secondary storage system

```
horcmstart 1
starting HORCM inst 1
HORCM inst 1 starts successfully.
```

- Server connected to the UR secondary storage system

```
horcmstart 2
starting HORCM inst 2
HORCM inst 2 starts successfully.
```

Creating the UR delta resync pairs

Create a UR delta resync pair. The following shows the example of command execution for Windows.

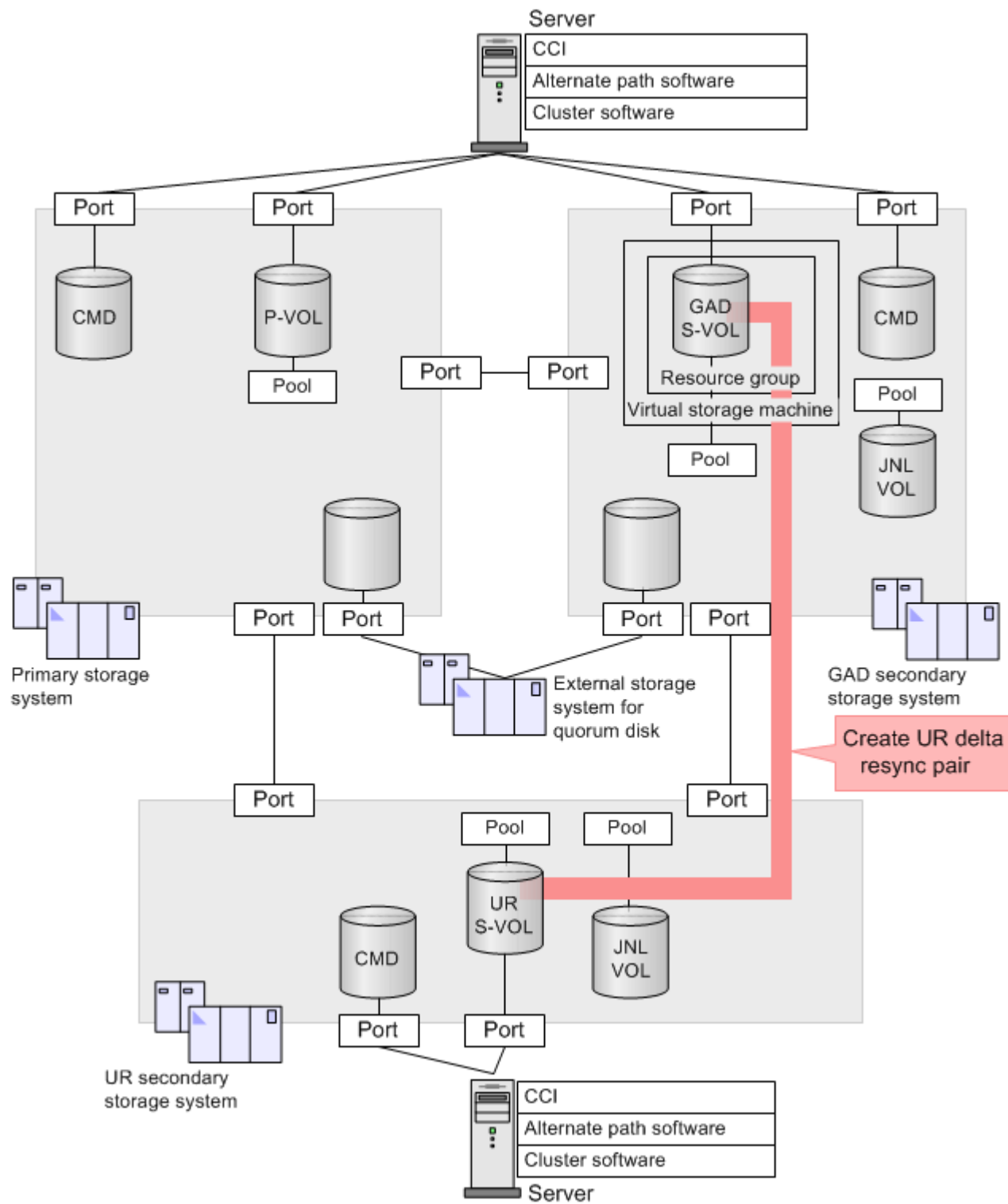

Note: Specify a different mirror ID for the GAD pair and the UR pair sharing a volume.

Procedure

1. Create a UR delta resync pair from the GAD secondary storage system. Specify the group name oraDELTA, journal ID 0 of the GAD secondary site (delta UR P-VOL), journal ID 0 of the UR secondary site (delta UR S-VOL), and the UR delta resync pair creation option (-nocsus).

```
paircreate -g oraDELTA -f async -vl -jp 0 -js 0 -nocsus -IH1
```

2. Confirm that the UR delta resync pair creation is completed. In CCI, the pair status of P-VOL is displayed as PSUE, and the mirror status of the journal is displayed as PJNS.

```
pairdisplay -g oraDELTA -fxce -IH1
Group          PairVol (L/R)      (Port#, TID, LU), Seq#,
LDEV#.P/S, Status, Fence, %, P-LDEV#  M   CTG   JID
AP    EM    E-Seq#    E-LDEV#    R/W
oraDELTA    dev3 (L)      (CL1-A-1, 0, 1)  322222
4444.P-VOL  PSUE      ASYNC , 0  6666   -   0   0
-          -          -          -          -/-
oraDELTA    dev3 (R)      (CL1-A-1, 0, 1)  344444
6666.S-VOL  SSUS        ASYNC , 0  4444   -   0   0
-          -          -          -          -/-
pairdisplay -g oraDELTA -v jnl -IH1
JID    MU    CTG    JNLS  AP    U(%)    Q-Marker    Q-
CNT     D-SZ (BLK)  Seq#    Num    LDEV#
000    1     1     PJNS  4     21     43216fde
30      512345    62500  1     39321
```

Creating the UR pairs in a GAD+UR configuration

This section describes the procedure for creating the UR pair in a GAD+UR configuration:

1. [Setting the port attributes on page 181](#)
2. [Adding the remote connections on page 182](#)
3. [Setting up the primary storage system on page 184](#)
4. [Updating the CCI configuration definition files on page 187](#)
5. [Creating the UR pairs on page 189](#)

Setting the port attributes

To establish the bi-directional remote connections between the primary storage system and UR secondary storage system, first set the port attributes on each storage system. The following shows the example of command execution for Windows.

Procedure

1. Set the attributes of Initiator port and RCU Target port in the primary storage system and UR secondary storage system.

- Server connected to the primary storage system

```
raidcom modify port -port CL6-A -port_attribute MCU -IH0
raidcom modify port -port CL7-A -port_attribute RCU -IH0
```

- Server connected to the UR secondary storage system

```
raidcom modify port -port CL6-A -port_attribute RCU -IH2
raidcom modify port -port CL7-A -port_attribute MCU -IH2
```

Use the same procedure to change the port attributes for the alternate paths.

2. Check the setting of the port attribute.

- Server connected to the primary storage system

```
raidcom get port -IH0
PORT TYPE ATTR SPD LPID FAB CONN SSW SL Serial# WWN PHY_PORT
(Omitted)
CL6-A FIBRE MCU AUT E8 N FCAL N 0 311111 50060e80072b6720 -
(Omitted)
CL7-A FIBRE RCU AUT 97 N FCAL N 0 311111 50060e80072b6730 -
(Omitted)
```

- Server connected to the UR secondary storage system

```
raidcom get port -IH2
PORT TYPE ATTR SPD LPID FAB CONN SSW SL Serial# WWN PHY_PORT
(Omitted)
CL6-A FIBRE RCU AUT E8 N FCAL N 0 344444 50060e80072b6720 -
(Omitted)
CL7-A FIBRE MCU AUT 97 N FCAL N 0 344444 50060e80072b6730 -
(Omitted)
```

Adding the remote connections

After setting the port attributes, add the remote connections between the primary storage system and UR secondary storage system. The following shows the example of command execution for Windows.



Note:

- When specifying the serial number for VSP G1000, G1500, and VSP F1500 using CCI, add a "3" at the beginning of the serial number. For example, for serial number 11111, enter 311111.
- To specify the VSP G1000, G1500, and VSP F1500, enter R800.
- The VSP G1000, G1500, and VSP F1500 is displayed as R8 in command output.

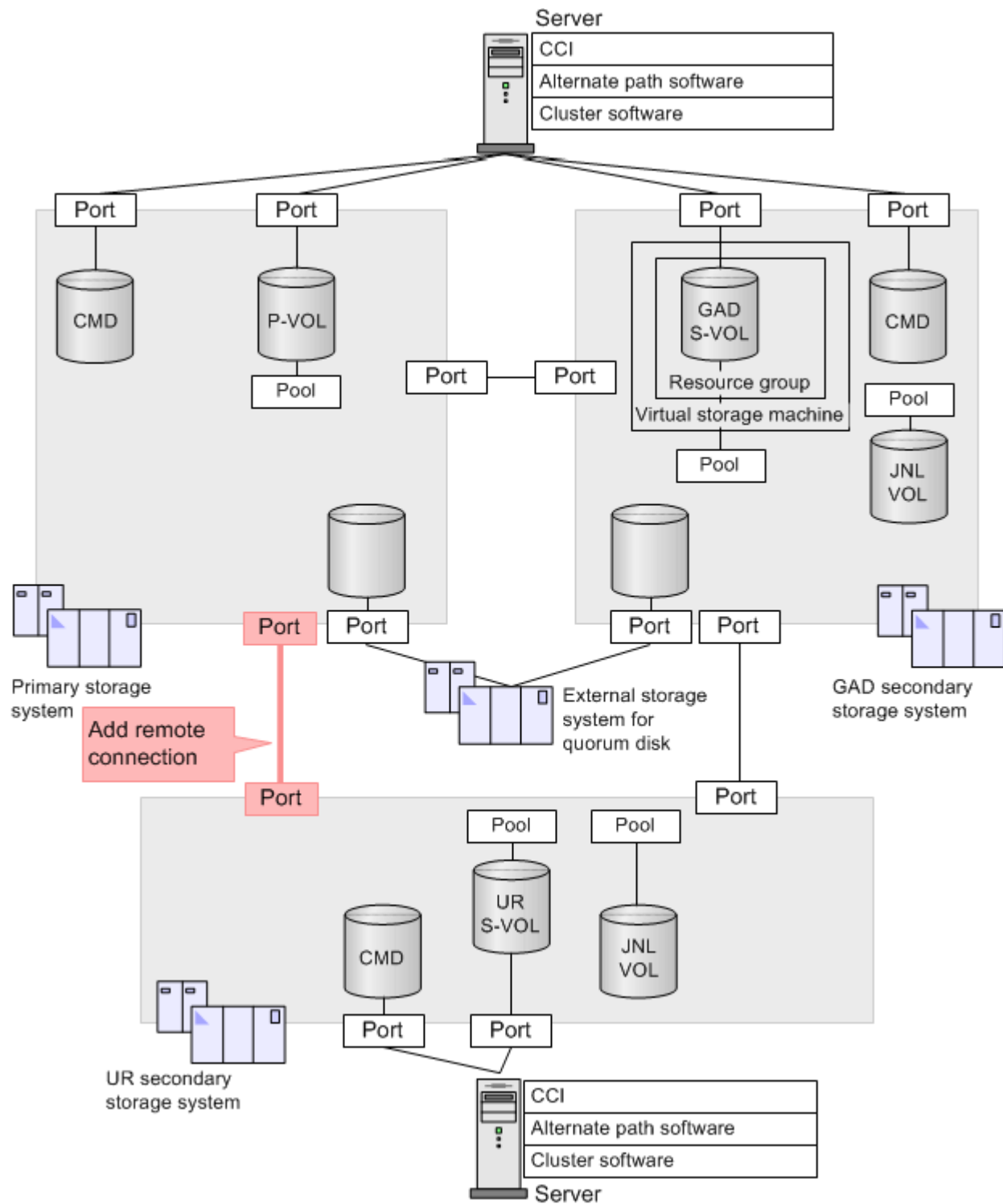

Procedure

1. Add a bi-directional remote connection between the GAD secondary storage system and UR secondary storage system. Add a remote

connection whose path group ID is 2 from port CL3-A in the primary storage system to port CL3-A in the UR secondary storage system, and add a remote connection whose path group ID is 2 from port CL3-B in the UR secondary storage system to port CL3-B in the primary storage system. After executing the command, confirm that the asynchronous command processing ended normally.

- Server connected to the primary storage system

```
raidcom add rcu -cu_free 344444 R800 2 -mcu_port CL6-A -rcu_port CL6-A -IH0
raidcom get command_status -IH0
HANDLE      SSB1      SSB2      ERR_CNT      Serial#      Description
00c3        -          -          0             311111       -
```

- Server connected to the UR secondary storage system

```
raidcom add rcu -cu_free 311111 R800 2 -mcu_port CL6-A -rcu_port CL6-A -IH2
raidcom get command_status -IH2
HANDLE      SSB1      SSB2      ERR_CNT      Serial#      Description
00c3        -          -          0             344444       -
```

Add the alternate paths between the storage systems using the `raidcom add rcu_path` command.

2. Check the settings of the remote connection.

- Server connected to the primary storage system

```
raidcom get rcu -cu_free 344444 R800 2 -IH0
Serial#      ID      PID      MCU      RCU      M/R      T      PNO      MPORT      RPORT
STS_CD      SSIDs
344444      R8      0      -      -      RCU      F      0      CL6-A      CL6-A
NML_01      -
```

- Server connected to the UR secondary storage system

```
raidcom get rcu -cu_free 311111 R800 2 -IH2
Serial#      ID      PID      MCU      RCU      M/R      T      PNO      MPORT      RPORT
STS_CD      SSIDs
311111      R8      0      -      -      RCU      F      0      CL6-A      CL6-A
NML_01      -
```

Setting up the primary storage system

On the primary storage system, create a pool volume of HDP pool for journal, create an HDP pool for journal, create a journal volume, and create a journal. The following shows the example of command execution for Windows.

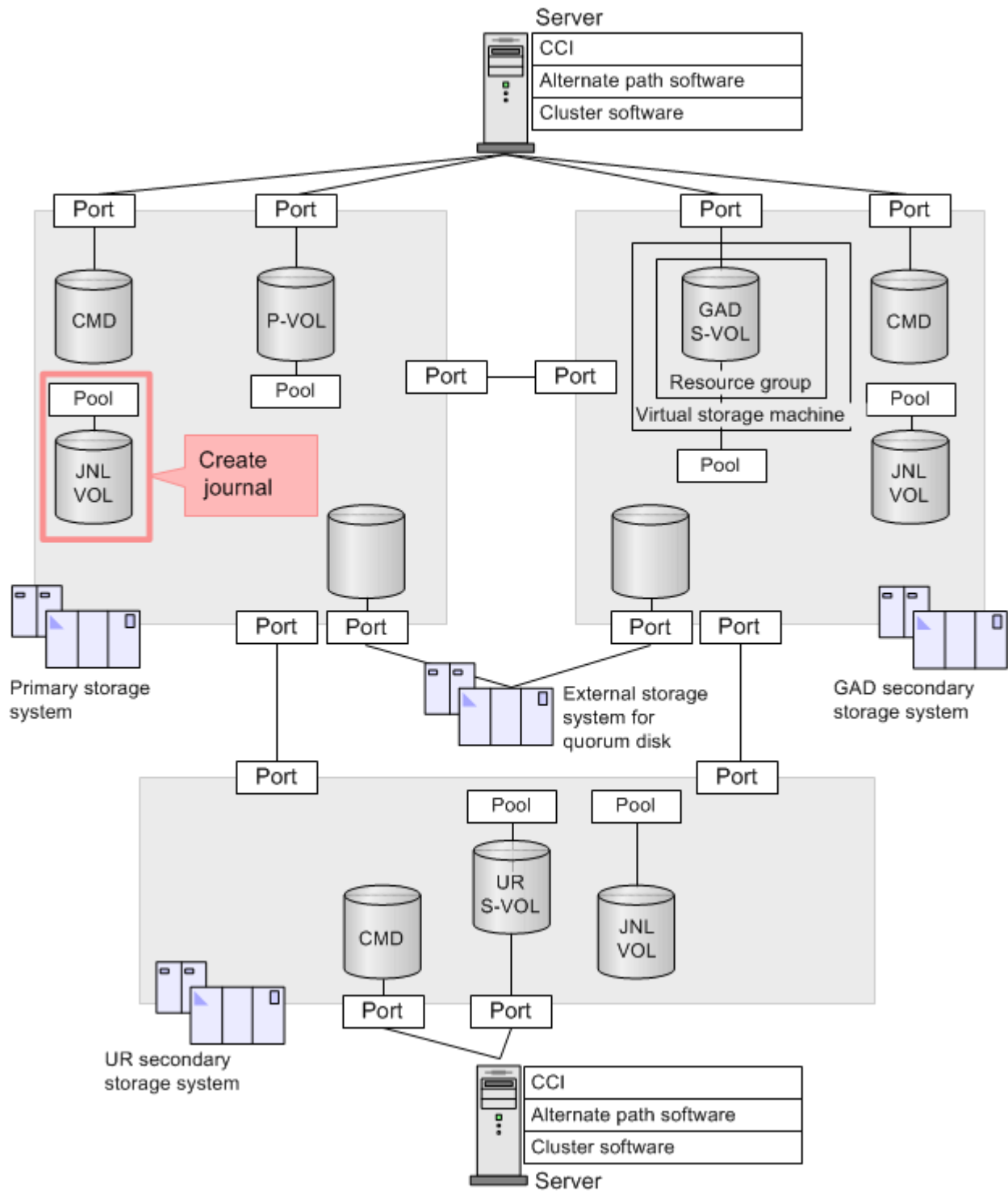

Procedure

1. Create a pool volume. Specify Parity group 2-1 and create a volume whose capacity is 100 GB and whose LDEV ID is 0x9999. After executing

the command, confirm that the asynchronous command processing ended normally.

```
raidcom add ldev -ldev_id 0x9999 -parity_grp_id 2-1 -capacity 100G -IH0
raidcom get command_status -IH0
HANDLE      SSB1      SSB2      ERR_CNT      Serial#      Description
00c3        -          -          0             311111       -
```

2. Perform a quick format of the created volume. After executing the command, confirm that the asynchronous command processing ended normally.

```
raidcom initialize ldev -operation qfmt -ldev_id 0x9999 -IH0
raidcom get command_status -IH0
HANDLE      SSB1      SSB2      ERR_CNT      Serial#      Description
00c3        -          -          0             311111       -
```

3. Create a pool. Specify the created volume 0x9999 in the pool volume and create an HDP pool whose pool ID is 1 and whose pool name is PJNL_POOL. After executing the command, confirm that the asynchronous command processing ended normally.

```
raidcom add dp_pool -pool_id 1 -pool_name PJNL_POOL -ldev_id 0x9999 -IH0
raidcom get command_status -IH0
HANDLE      SSB1      SSB2      ERR_CNT      Serial#      Description
00c3        -          -          0             311111       -
```

4. Confirm that the volume (LDEV ID: 0x9999) is set in the pool volume in the pool (Pool ID: 1).

```
raidcom get ldev -ldev_id 0x9999 -fx -IH0
Serial# : 311111
LDEV : 9999
(Omitted)
F_POOLID : 1
VOL_ATTR : CVS : POOL
(Omitted)
```

5. Check the pool capacity.

```
raidcom get dp_pool -IH0
PID    POLS    U(%)    AV_CAP(MB)    TP_CAP(MB)    W(%)    H(%)    Num
LDEV#   LCNT    TL_CAP(MB)
001   POLN    0        98196          98196          70      80      1
39321   0        0
```

6. Check the pool name.

```
raidcom get pool -key opt -IH0
PID    POLS    U(%)    POOL_NAME    Seq#    Num    LDEV#    H(%)
VCAP(%) TYPE    PM
001   POLN    0        PJNL_POOL    311111  1      39321    80
-          OPEN    N
```

7. Create a journal volume. Create a virtual volume (DP-VOL) whose capacity is 30 GB and whose LDEV ID is 0x8888 in HDP pool ID 1. After executing the command, confirm that the asynchronous command processing ended normally.

```
raidcom add ldev -pool 1 -ldev_id 0x8888 -capacity 30G -IH0
raidcom get command_status -IH0
HANDLE      SSB1      SSB2      ERR_CNT      Serial#      Description
00c3        -          -          0             311111       -
```

8. Check the created volume.

```
raidcom get ldev -ldev_id 0x8888 -fx -IH0
Serial# : 311111
LDEV : 8888
(omitted)
VOL_ATTR : CVS : HDP
(omitted)
```

9. Create a journal. Specify the volume whose LDEV ID is 0x8888 to create a journal whose journal ID is 0. After executing the command, confirm that the asynchronous command processing ended normally.

```
raidcom add journal -journal_id 0 -ldev_id 0x8888 -IH0
raidcom get command_status -IH0
HANDLE      SSB1      SSB2      ERR_CNT      Serial#      Description
00c3        -          -          0             311111        -
```

10. Confirm that the volume (LDEV ID: 0x8888) is registered to the journal (journal ID: 0) and check the journal capacity.

```
raidcom get journal -IH0
JID      MU      CTG      JNLS      AP      U(%)      Q-Marker      Q-CNT      D-SZ (BLK)
Seq#     Num      LDEV#
000      0        1        PJNN      4        21        43216fde      30        62914560
311111   1        34952
```

Updating the CCI configuration definition files

You can update the configuration definition file to create a UR pair.

The following shows the example of command execution for Windows and description example of the configuration definition file for Windows.

Procedure

1. Stop the CCI instances at the primary and UR secondary sites.

- Server connected to the primary storage system

```
horcmshutdown 0
inst 0:
horcmshutdown inst 0 !!!
```

- Server connected to the UR secondary storage system

```
horcmshutdown 2
inst 2:
horcmshutdown inst 2 !!!
```

2. Edit the configuration definition files at the primary and UR secondary sites.

Add the underlined parts below to the configuration definition files at the primary and UR secondary sites. The following information is important to know as you edit configuration definition files:

- Make sure to specify the actual LDEV IDs for the GAD pair volumes, not the virtual LDEV IDs.
- When specifying the serial number for VSP G1000, G1500, and VSP F1500 using CCI, add a "3" at the beginning of the serial number. For

example, for serial number 11111, enter 311111. For VSP Gx00 models, specify the six-digit serial number that begins with 4 as is (for example, 411111).

- If you use CCI to operate a GAD pair created by Device Manager - Storage Navigator, the MU# in the configuration definition file of CCI must be the same as the mirror ID you specified when creating the GAD pair by Device Manager - Storage Navigator. If the MU# does not match the mirror ID, you cannot operate the GAD pair using CCI.

Example of editing the configuration definition file at the primary site: horcm0.conf

```
HORCM_MON
#ip_address      service      poll(10ms)      timeout(10ms)
localhost        31000        -1               3000

HORCM_CMD
\\.\CMD-311111-52735

HORCM_LDEV
#GRP      DEV      SERIAL  LDEV#  MU#
oraHA     dev1    311111  22:22  h0
oraREMOTE dev2      311111  22:22  h1

HORCM_INST
#GPR      IP ADR      PORT#
oraHA     localhost 31001

HORCM_INSTP
#dev_group ip_address service pathID
oraDELTA  localhost 31002 2
```

Example of editing the configuration definition file at the UR secondary site: horcm2.conf

```
HORCM_MON
#ip_address      service      poll(10ms)      timeout(10ms)
localhost        31002        -1               3000

HORCM_CMD
\\.\CMD-344444-52733

HORCM_LDEV
#GRP      DEV      SERIAL  LDEV#  MU#
oraDELTA  dev3    344444  66:66  h2
oraREMOTE dev2      344444  66:66  h1

HORCM_INST
#GPR      IP ADR      PORT#
oraDELTA  localhost 31001

HORCM_INSTP
```

#dev_group	ip_address	service	pathID
oraDELTA	localhost	31000	2

3. Start the CCI instances at the GAD secondary site and UR secondary site.
 - Server connected to the primary storage system

```
horcmstart 0
starting HORCM inst 0
HORCM inst 0 starts successfully.
```

- Server connected to the UR secondary storage system

```
horcmstart 2
starting HORCM inst 2
HORCM inst 2 starts successfully.
```

Creating the UR pairs

Create a UR pair. The following shows the example of command execution for Windows.

Procedure

1. Create a UR pair. Specify the group name URGPR, journal ID 0 of the GAD secondary site (UR P-VOL), and journal ID 0 of the UR secondary site (UR S-VOL).

```
paircreate -g oraREMOTE -f async -vl -jp 0 -js 0 -IH0
```

2. Confirm that UR pair creation is completed.

```
pairdisplay -g oraREMOTE -fxce -IH0
Group          PairVol (L/R)      (Port#,TID, LU), Seq#, LDEV#.P/S, Status, Fence,
%, P-LDEV#     M   CTG   JID   AP   EM   E-Seq#   E-LDEV#   R/W
oraREMOTE     dev2 (L)           (CL1-A-1, 0, 1)  311111  2222.P-VOL PAIR
ASYNC, 0 6666   -    0    0   -    -        -        -    -/-
oraREMOTE     dev2 (R)           (CL1-A-1, 0, 1)  344444  6666.S-VOL PAIR
ASYNC, 0 2222   -    0    0   -    -        -        -    -/-
```

The following figure shows the configuration after UR pair creation is completed.

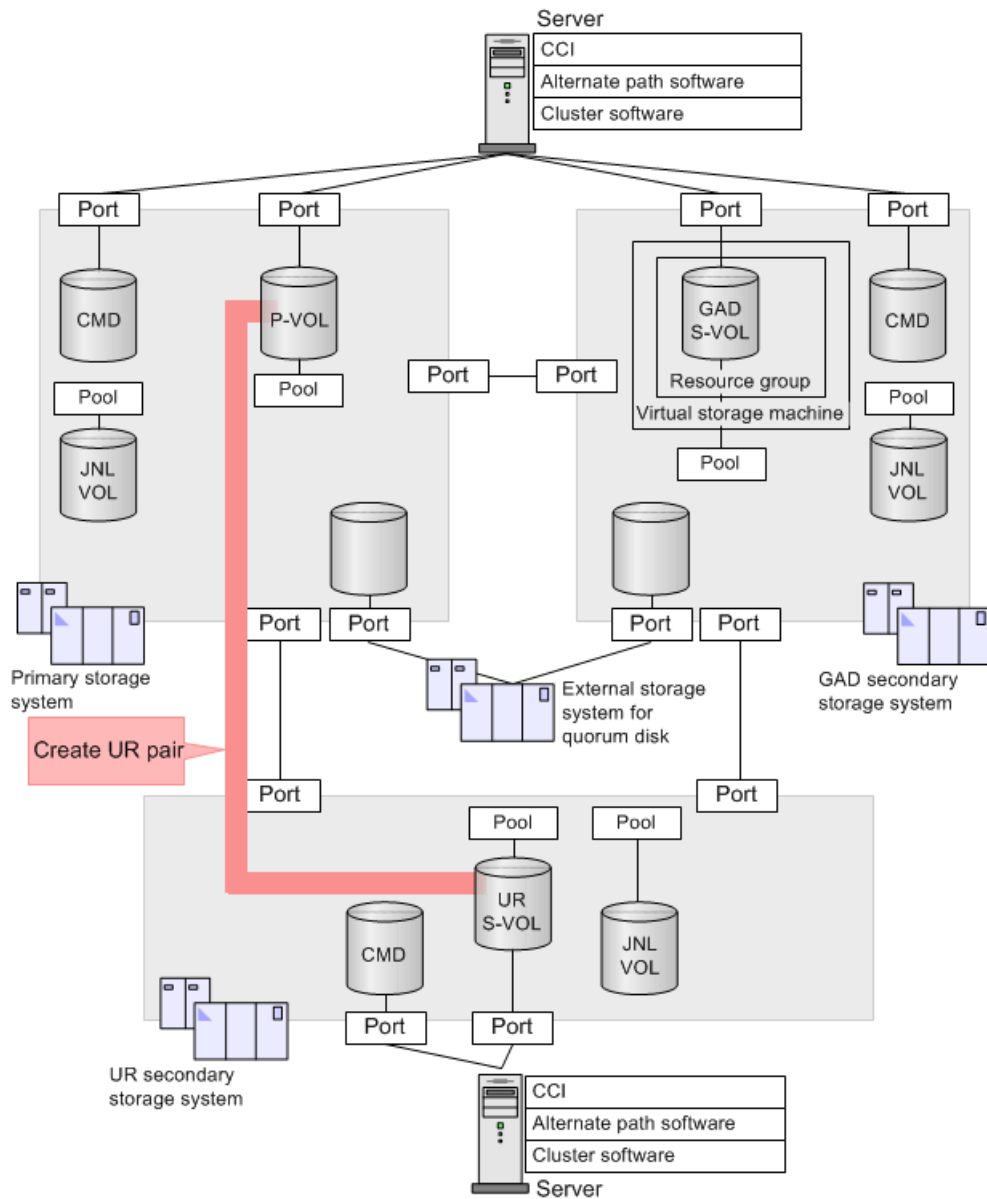

Starting GAD+UR operations

This section describes the procedure for starting operations to have the normal operation status of GAD+UR (UR delta resync pair status changes from PSUE to PSUS) after each pair of GAD+UR is created. After the following procedure, the GAD+UR configuration is ready for normal operation as shown in [GAD 3DC delta resync system configuration on page 152](#).

Procedure

1. Issuing update I/O to P-VOL/GAD S-VOL: To have the normal GAD+UR operation status, keep updating I/O to P-VOL or GAD S-VOL and wait for two minutes.

If update I/O is issued to P-VOL or GAD S-VOL, the status information of GAD+UR is reported among the primary, GAD secondary, and UR secondary storage systems. At the time, the UR delta resync pair status is changed from PSUE to PSUS.

2. Checking UR delta resync pair status and mirror status: Confirm in the GAD secondary storage system the UR delta resync pair status and the mirror status of the journal. Confirm that the UR delta resync pair status is HOLD. In CCI, the pair status of the P-VOL is displayed as PSUS, and the mirror status of the journal is displayed as PJNS.

```
pairdisplay -g oraDELTA -fxce -IH1
Group      PairVol(L/R) (Port#,TID, LU), Seq#, LDEV#.P/S, Status, Fence, %, P-
LDEV# M CTG JID AP EM E-Seq# E-LDEV# R/W
oraDELTA dev3(L) (CL1-A-1, 0, 1) 322222 4444.P-VOL PSUS ASYNC, 100
6666 - 0 0 - - - L/M
oraDELTA dev3(R) (CL1-A-1, 0, 1) 344444 6666.S-VOL SSUS ASYNC, 100
4444 - 0 0 - - - L/M
pairdisplay -g oraDELTA -v jnl -IH1
JID MU CTG JNLS AP U(%) Q-Marker Q-CNT D-SZ (BLK) Seq# Num LDEV#
000 1 1 PJNS 4 21 43216fde 30 512345 62500 1 39321
```



Note: When checking the pair status in Device Manager - Storage Navigator, make sure to refresh the screen (select **Refresh All** in the **File** menu) to update the information being displayed. The status of the UR delta resync pairs changes from HOLDING to HOLD.

3. Confirm that no failure SIMs are displayed.

Monitoring the UR system

This chapter provides information and instructions for monitoring a Universal Replicator system.

- [Monitoring pair activity, status, license capacity](#)
- [Suspend conditions for Universal Replicator pairs](#)
- [Monitoring UR pair synchronization rate](#)
- [Monitoring UR operations history](#)
- [Pair operations history](#)
- [Saving pair information to a text file](#)
- [Monitoring copy operations and I/O statistics](#)
- [Monitoring I/O and hardware performance with Performance Monitor](#)
- [Monitoring journal \(mirror\) status](#)
- [Monitoring UR remote connections and path status](#)

Monitoring pair activity, status, license capacity

Monitoring pairs, journals, data paths, I/O, licensed capacity, and hardware performance is essential for ensuring that Universal Replicator pairs continue to function correctly.

- Before performing a pair operation, check the pair status to verify that the desired operation can be performed. For details about the pair statuses, see [Pair status definitions on page 33](#).
- The pair status changes when an operation is performed. If the pair status is PAIR, data update is executed correctly from the P-VOL to the S-VOL. If the pair status is PSUS/PSUE, the pair is split or suspended, and therefore differential data is managed.

Frequent monitoring of the system is recommended but optional. You can set up automatic e-mail notification from Device Manager - Storage Navigator for problems found during monitoring.

Procedure

1. In the **Explorer** pane, expand the **Storage Systems** tree.
2. Expand the target storage system tree, expand **Replication**, and click **Remote Replication**.
3. In the **UR Pairs** tab, select the pair that you want to monitor.
4. Click **More Actions > View Pair Properties**.
5. In the **View Pair Properties** window, you can display only the columns you want to see by clicking **Filter**. Click **File/Refresh** as needed to display the most current information.

The screenshot shows the 'View Pair Properties' window. The top section, 'Pair Properties', displays a diagram of a UR Copy pair. On the left is the 'Local Storage System' with details: 00:02:10(), Number of Paths: 1, DP, OPEN-V, 99.99 GB, Journal ID: 000, and VSP G1000 / 2654, 0:CLPR0. On the right is the 'Remote Storage System' with details: 00:02:11, CL1-A / 00 / 1, OPEN-V, 99.99 GB, Journal ID: 001, and VSP G1000 / 12345. A blue arrow points from the local to the remote system, with labels: :PAIR, Path Group: 00, and Mirror ID: 0. The bottom section, 'Pair Detail', is a table with the following data:

Pair Detail		
Status		PAIR
CTG ID		000
Sub Status		-
Reverse Resync		-
Error Level		Mirror
Secondary Volume Write		Disabled
Initial Copy Priority		32
Paired Time		2008/04/12 09:19:12
Last Update Time		2008/04/12 09:19:12
Pair Copy Time		000:05:00
Consistency Time		-
Timer Type		-
CFW		-
Local Storage System	Virtual Storage Machine	VSP G1000 / 02654
	Virtual LDEV ID	00:02:10
	Virtual Device Name	
	Virtual SSID	
Remote Storage System	Virtual Storage Machine	VSP G1000 / 12345
	Virtual LDEV ID	00:02:11

At the bottom of the window, there are navigation buttons: Back, Next, Close, and a help icon (?). The page number '1 / 1' is also visible.

- To review license capacity, see the **Summary** area in the **Replication** window.

Suspend conditions for Universal Replicator pairs

The following table lists the suspend conditions for Universal Replicator pairs, the storage system that detects the condition, and the volume pairs that are suspended.

Suspend condition	Detecting storage system	Suspended pair
Logical error was detected in secondary system while selecting journal data that will be restored.	Secondary system	All S-VOLs in journal or affected S-VOL.
Journal data could not be restored in secondary system due to HW failure, track status, or logical error.	Secondary system	

Differential bitmap for each P-VOL is stored in shared memory in the primary system. The differential bitmap for each S-VOL is stored in shared memory in the secondary system. A UR pair that uses a DP-VOL V-VOL whose size is more than 4,194,304 MB (8,589,934,592 blocks) does not use shared memory. For tracks that include the following journal data, it will be marked within differential bitmap (since it needs to be copied during pair resync):

- Journal data that was created at the primary system and not yet sent to the secondary system. The primary system will mark these P-VOL tracks as "changed" and then delete the journal data.
- Journal data that was sent to the secondary system but not recognized yet. The primary system will mark these P-VOL tracks as "changed" and then delete the journal data. By this, it can be marked as confirmed for journal data that was lost while being sent to the secondary system.
- Journal data that was delivered to the secondary system but not yet restored. The primary system will mark these P-VOL tracks as "changed" and then delete the journal data. By this, it can be marked as confirmed for journal data that was lost while being sent to the secondary system. The primary system will not delete the target journal data from the master journal volume until receiving the restored journal's sequence number that is added to the read journal command from the secondary system.
- P-VOL that was updated by write I/O from the host after the pair was suspended.

Monitoring UR pair synchronization rate

You can check the percentage of synchronized data between the P-VOL and S-VOL. The synchronization rate is displayed as follows:

- When the volume on the local storage system is a P-VOL, the initial copy progress is displayed.
- When the volume on the local storage system is an S-VOL, the synchronization rate depends on whether the pair is split:
 - If the pair is not split, a hyphen (-) is displayed.
 - If the pair is split, the S-VOL synchronization rate between before and after the split is displayed. For example, if the S-VOL content before and after the split is the same, 100 is displayed.



Caution: If the pair is split due to initial copy failure, a hyphen (-) is displayed. If initial copy fails, the status Initial copy failed is displayed in the View Pair Properties window.

- For the following cases, a hyphen (-) is displayed:
 - When the volume in the local storage system is neither a P-VOL nor an S-VOL.
 - When the volume in the local storage system has one of the following pair statuses: HOLD, HOLDING, or HLDE.

Procedure

1. In the **Explorer** pane, expand the **Storage Systems** tree.
2. Expand the target storage system tree, expand **Replication**, and click **Remote Replication**.
3. In the **UR Pairs** tab, select the pair whose synchronization rate you want to monitor.
4. Click **More Actions > View Pair Synchronization Rate**.
Clicking **Refresh View** displays the latest synchronization rate.

LDEV ID	LDEV Name	Pair Position	Journal ID	Mirror ID	CLPR	Virtual Storage Machine	Virtual LDEV ID	Virtual Device Name	Virtual SSID	Copy Type
00:00:00		Primary	004	2	0:CLPR0	VSP G1000 / 00002	00:00:00			UR

Monitoring UR operations history

You can review the history of operations for each pair, including a description of each operation, the date and time the operation took place, primary and secondary storage system information, and other details.



Note:

- The LDEV ID displayed in the LDEV ID column is the physical LDEV ID in the storage system, not the virtual LDEV ID used in a virtual storage machine.
- The displayed operations include user-requested operations (for example, pair creation) and internal operations (for example, completion of pair creation, pair suspension due to failure).
- If you use 1,000 or more pairs concurrently, some operation history might not be recorded.

Procedure

1. In the **Explorer** pane, expand the **Storage Systems** tree.
2. Expand the target storage system tree, and click **Replication**.
3. Click **View History > Remote Replication**.
4. In the **History** window, select **UR** as the **Copy Type**.

Related references

- [Pair operations history](#) on page 198

Pair operations history

The following table describes the operations displayed in the History window.

Operation	Description
Pair definition	A pair was defined.
Paircreate Start	Creation of the pair was started. When you use UR with TC and if you specify Entire Copy for the Delta Resync Failure option (Edit Mirror Options window), Paircreate Start is displayed because all P-VOL data is copied to the S-VOL if delta resync is not executed. When you use UR with GAD, specifying Entire Copy for the Delta Resync Failure option is invalid.
Paircreate Complete	Creation of the pair was finished. When you use UR with TC and if you specify Entire Copy for the Delta Resync Failure option (Edit Mirror Options window), Paircreate Complete is displayed because all P-VOL data is copied to the S-VOL if delta resync is not executed. When you use UR with GAD, specifying Entire Copy for the Delta Resync Failure option is invalid.
Pairresync Start	Restoring of the pair was started.
Pairresync Complete	Restoring of the pair was finished.
Pairsplit-r Start	Splitting (Suspending) of the pair was started.
Pairsplit-r Complete	Splitting (Suspending) of the pair was finished.
Pairsplit-r(Failure)	The pair was split (suspended) because of a failure.
Pairsplit-S Start	Release of the pair was started.
Pairsplit-S Complete	Release of the pair was finished.
Status Change by MCU(SMPL to COPY)	The status of the pair was changed from SMPL to COPY because of an operation from the primary storage system.
Status Change by MCU(SMPL to PAIR)	The status of the pair was changed from SMPL to PAIR because of an operation from the primary storage system.
Status Change by MCU(COPY to PAIR)	The status of the pair was changed from COPY to PAIR because of an operation from the primary storage system.
Status Change by MCU(COPY to PSUS/PSUE)	The status of the pair was changed from COPY to PSUS or PSUE because of an operation from the primary storage system.
Status Change by MCU(PAIR to PSUS/PSUE)	The status of the pair was changed from PAIR to PSUS or PSUE because of an operation from the primary storage system.
Status Change by MCU(PAIR to SMPL)	The status of the pair was changed from PAIR to SMPL because of an operation from the primary storage system.
Status Change by MCU(COPY to SMPL)	The status of the pair was changed from COPY to SMPL because of an operation from the primary storage system.

Operation	Description
Status Change by MCU(PSUS/PSUE to SMPL)	The status of the pair was changed from PSUS or PSUE to SMPL because of an operation from the primary storage system.
Status Change by MCU(PSUS/PSUE to COPY)	The status of the pair was changed from PSUS or PSUE to COPY because of an operation from the primary storage system.
Status Change by RCU(Pairsplit-r Start)	The status of the pair was changed because an operation for splitting a pair started at the secondary storage system.
Status Change by RCU(Pairsplit-r Complete)	The status of the pair was changed because an operation for splitting a pair finished at the secondary storage system.
Status Change by RCU(PSUS/PSUE to SMPL; Pairsplit-S Start)	An operation for releasing a pair has been started at the secondary storage system. The status of the pair will change from PSUS or PSUE to unpaired (SMPL).
Status Change by RCU(COPY to SMPL; Pairsplit-S Start)	An operation for releasing a pair has been started at the secondary storage system. The status of the pair will change from COPY to unpaired (SMPL).
Status Change by RCU(PAIR to SMPL; Pairsplit-S Start)	An operation for releasing a pair has been started at the secondary storage system. The status of the pair will change from PAIR to unpaired (SMPL).
Status Change by RCU(Pairsplit-S Complete)	The status of the pair was changed because an operation for releasing a pair finished at the secondary storage system.
Ready for Delta resync	A pair became ready for delta resync.
Ready for Delta resync(Failure)	The failure occurred with the pair which was ready for delta resync.
Status Change for Delta resync	The status of the P-VOL was changed to HOLD because of a delta resync operation.
Status Change by MCU(SMPL to HOLD)	The status of the pair was changed from unpaired (SMPL) to HOLD because of an operation from the primary storage system.
Status Change by MCU(HOLD to PAIR)	The status of the pair was changed from HOLD to PAIR because of an operation from the primary storage system.
Status Change by MCU(HOLD to COPY)	The status of the pair was changed from HOLD to COPY because of an operation from the primary storage system.
Status Change by MCU(HOLD to SMPL)	The status of the pair was changed from HOLD to unpaired (SMPL) because of an operation from the primary storage system.
Status Change by RCU(HOLD to SMPL; Pairsplit-S Start)	An operation for releasing a pair has been started at the secondary storage system. The status of the pair will change from HOLD to unpaired (SMPL).
Status Change to HOLD	The status of the S-VOL was changed to HOLD because of a delta resync operation.

Saving pair information to a text file

You can save pair status and other information to a tab-delimited TSV file.

Procedure

1. In the **Explorer** pane, expand the **Storage Systems** tree.
2. Expand the target storage system tree, expand **Replication**, and click **Remote Replication**.
3. In the **UR Pairs** tab, select the pair that you want to monitor.
4. Click **More Actions > Export** and follow on-screen instructions.

Monitoring copy operations and I/O statistics

You can monitor copy operations and I/O statistics. For more information, see the *Performance Guide*.

For the primary site in a 3DC multi-target configuration combining three UR sites, two or more mirrors are set in the primary system. The following table describes the data displayed in Logical Device (UR/URMF) and Journal (UR/URMF) for Performance Monitor in the primary storage system.

Object of monitoring ¹	Monitoring data	Description
Logical Device (UR/URMF)	Initial copy cache hit (%)	Average of all mirror's cache hit rates in primary system.
	Initial copy data transfer (MB/s)	Total of all mirror's data transfer amount in primary system during initial copy.
Journal (UR/URMF)	Master journal throughput (IOPS)	Total throughput of all mirrors in the primary system.
	Master journal (count/sec)	Total of all mirror's journal responses in primary system.
	Master journal data transfer (MB/s)	Total of all mirror's data transfer amount in primary system.
	Master journal response time (ms)	Average of all mirror's response time in primary system.
Notes:		
1. The journal information per mirror is displayed in Journal (UR/URMF). Note that it is impossible to reference the initial copy information per mirror.		

If the journal group attribute is Master/Restore, only the restore journal information is displayed in Journal (UR/URMF), as shown in the following table.



Note: In a cascade configuration in which three UR sites are combined, a restore journal value might be greater than the corresponding master journal value.

Object of monitoring	Monitoring data	Description
Journal (UR/URMF)	Restore journal throughput (IOPS)	Restore journal throughput per second.
	Restore journal (count/sec)	Number of count for restore journal per second.
	Restore journal data transfer (MB/s)	Restore journal data transfer amount.
	Restore journal response time (ms)	Restore journal response time.
	Restore journal usage data (%)	Restore journal usage data.
	Restore journal metadata usage rate (%)	Restore journal metadata usage rate.

Monitoring I/O and hardware performance with Performance Monitor

The Performance Monitor software provides detailed information on I/O activity and hardware performance.

Storage system usage and performance data that is collected and displayed by Performance Monitor enables you to:

- Identify the optimum timing for performing Universal Replicator copy operations.
- Determine the best locations for the Universal Replicator S-VOLs (for example, parity groups with less frequently accessed volumes to avoid bottlenecks of back-end activity).
- Monitor system performance during Universal Replicator operations and during testing activities.

Use the following procedure to lessen the impact on Universal Replicator operations while Performance Monitor is collecting data for one or more storage systems on the same internal LAN:

1. If Performance Monitor is collecting high amounts of LDEV data, disabling this activity, if possible, for one or more systems.
2. If Performance Monitor is collecting data for more than three storage systems on the internal LAN, disconnect Performance Monitor, if possible, from one or more systems before using Universal Replicator.
3. After you have disabled LDEV data collection and/or disconnected Performance Monitor wherever possible, then connect to the system using Device Manager - Storage Navigator and launch Universal Replicator.
4. When Universal Replicator operations are completed, exit Universal Replicator and Device Manager - Storage Navigator.

5. Re-enable Performance Monitor data collection.

For further information on Performance Monitor, see the *Performance Guide* for your storage system.









Monitoring journal (mirror) status



The status of a mirror associated with a journal relates to the pair operations that have been performed on the journal. Monitoring these statuses can help to resolve problems and maintain the Universal Replicator system.

Procedure

1. In the **Explorer** pane, expand the **Storage Systems** tree.
2. Expand the target storage system tree, expand **Replication**, and click **Journals**.
3. In the **Journals** window, select the **Journal ID** for the journal you want to monitor. The **Mirror** tab is displayed.
4. In the **Mirror** tab, view the journal's status.

Device Manager - Storage Navigator mirror status definitions

Status	Description
 Initial	Data volumes are not registered in the mirror.
 Active	The mirror has only pairs that are not synchronized with the initial copy operation in progress, or pairs that are synchronized with the initial copy complete. If a mirror in Active status contains pairs that are split, Active (Warning) is displayed. The split pairs must be resynchronized to restore the mirror to the Active status.
 Active (Warning)	The mirror status is Active; some pairs in the mirror are split.
 HaltAccept	The status at the beginning of a mirror-split operation. The status changes immediately to Halting. HaltAccept indicates status of restore journals only.
 Halting	An operation for splitting or deleting the mirror is in progress. <ul style="list-style-type: none"> • Splitting a mirror changes the status in the following order: Halting, Halt, Stopping, and finally Stopped. • Deleting a mirror changes the status in the following order: Halting, Halt, Stopping, Stopped, and finally Initial.
 Halt	An operation for splitting or deleting the mirror is in progress.
 Stopping	An operation for splitting or deleting the mirror is in progress.
 Stopped	An operation for splitting or deleting the mirror is finished.
 Hold	When you use UR with TC, a delta resync pair has been created. It is ready for the delta resync operation. Delta resync might not be executed depending on the

Status	Description
	internal process even when the creation of the delta resync pair is completed. When you use UR with GAD, it is ready for the delta resync operation.
 Holding	When you use UR with TC, a delta resync pair is being created. When you use UR with GAD, it is preparing for the delta resync operation. Delta resync execution will fail if the status is HOLDING.
 Hold(Failure)	An error occurred with the UR pair during the delta resync operation.

CCI mirror status definitions

CCI mirror statuses appear beside Device Manager - Storage Navigator statuses in the HDvM - SN/CCI format. The following describe CCI statuses.

Status	Description
SMPL	The mirror is not used.
PJNN	The master journal is normal.
SJNN	The restore journal is normal.
PJSN	The master journal is in normal split status.
SJSN	The restore journal is in normal split status.
PJNS	The master journal is in normal split status (delta resync configuration).
SJNS	The restore journal is in normal split status (delta resync configuration).
PJNF	The master journal is full.
SJNF	The restore journal is full.
PJSF	The master journal is full and split.
SJSF	The restore journal is full and split.
PJSE	The master journal is split due to an error (including link errors).
SJSE	The restore journal is split due to an error (including link errors).
PJES	The master journal is in split status (delta resync configuration) due to an error.
SJES	The restore journal is in split status (delta resync configuration) due to an error.

Monitoring UR remote connections and path status

Use the following procedure to navigate to remote connection and remote path status. For remote path status definitions and troubleshooting, see [Remote path status problems on page 292](#).

Procedure

1. In the **Explorer** pane, expand the **Storage Systems** tree.
2. Expand the target storage system tree, expand **Replication**, and click **Remote Connections**.
3. Check the **Status** field.

4. To view more information, select a connection and click **View Remote Connection Properties**.

Maintaining the UR system

This chapter provides information and instructions for maintaining a Universal Replicator system.

- [Maintenance activities](#)
- [Pair maintenance](#)
- [Journal and mirror maintenance](#)
- [Remote path maintenance](#)
- [Managing power-off for systems and network devices](#)
- [Planned outage of storage systems in a GAD 3DC delta resync environment \(VSP G1000, G1500, and VSP F1500\)](#)

Maintenance activities

Some maintenance tasks are performed in response to conditions discovered during system monitoring, such as pool-full conditions that cause pairs to become suspended. You can also change certain settings as needed to meet changing operational requirements. This chapter covers the following maintenance activities:

- [Pair maintenance on page 206](#)
- [Journal and mirror maintenance on page 211](#)
- [Remote path maintenance on page 220](#)
- [Managing power-off for systems and network devices on page 223](#)
- [Planned outage of storage systems in a GAD 3DC delta resync environment \(VSP G1000, G1500, and VSP F1500\) on page 226](#)

Pair maintenance

You must have Storage Administrator (Remote Backup Management) role to perform Universal Replicator pair maintenance operations.

The topic describes and provides instructions for the following pair maintenance tasks:

- [Changing the maximum initial copy activities option on page 206](#)
- [Changing the pair options on page 207](#)
- [Forcibly deleting pairs on page 208](#)
- [Releasing the differential data managed in a pool on page 209](#)
- [Restoring a pair by adding a reserve journal volume on page 210](#)
- [Restoring a pair without adding a reserve journal volume on page 210](#)

Changing the maximum initial copy activities option

You can change the maximum number of volumes that can be copied concurrently by adjusting the Maximum Initial Copy Activities setting (range = 1 to 128, default = 64). For example, you can increase this setting when you need to create or resynchronize a large number of pairs concurrently, and you can decrease this setting when you need to limit the impact of initial copy operations on system performance.

For details and instructions, see [Setting the maximum initial copy activities option on page 124](#).



Note:

- Performance of the primary storage system depends on this setting and the amount of I/O activity. You can limit the impact of initial copy operations on system performance by using the default setting.

- When you change the maximum initial copy activities setting, the new setting applies to pairs created or resynchronized after the change, not existing pairs.
-

Changing the pair options

You can change the following pair options:

- Cache-fast-write (CFW)
- Error level

Before you begin

- You can change the pair options only for pairs in PAIR, PSUS, PSUE, HOLD, HOLDING, or HLDE status.

Procedure

1. In the **Explorer** pane, expand the **Storage Systems** tree.
2. Expand the target storage system tree, expand **Replication**, and click **Remote Replication**.
3. In the **UR Pairs** tab, select the pair whose options are to be changed.
4. Click **More Actions > Edit Pair Options**.



Note: When you select multiple pairs on the **UR Pairs** tab, **Edit Pair Options** values may be blank because the selected pairs have different values.

When you specify a value, it is set for all selected pairs.

5. In the **Edit Pair Options** window, for **Error Level**, specify the system response if a failure occurs in the pair.
 - **Mirror:** Splits all pairs in the failed pair's mirror. **Mirror** is the default.
 - **LU:** Splits only the pair that failed.

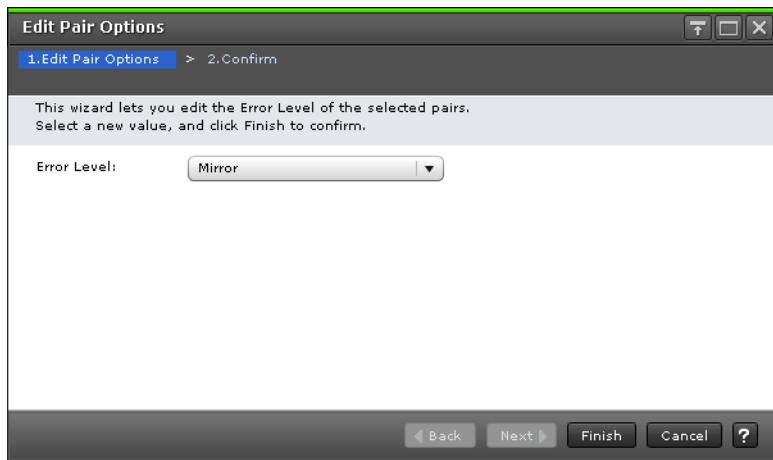

6. Click **Finish**.
7. In the **Confirm** window, review the settings, enter a task name, and click **Apply**.

Forcibly deleting pairs

You need to forcibly delete a pair for the following reasons:

- A currently unpaired volume that was previously in a pair is unusable because previous pair information is still in the volume.
- The pair cannot be connected to the secondary storage system due to a communication error. In this case, you need to delete the pair forcibly in both the primary storage system and the secondary storage system.



Caution: The following data is discarded:

- Data which is not sent to the secondary storage system when a pair in the primary storage system is deleted forcibly
- Data which is not restored when a pair is deleted forcibly in the secondary storage system

In addition, if a pair is deleted forcibly when a journal contains a pair in the PAIR/COPY status, host I/Os to the pair might time out.

Before you begin

- The volume must be unpaired.

Procedure

1. In the **Explorer** pane, expand the **Storage Systems** tree.
2. Expand the target storage system tree, and click **Logical Devices**.
3. In the **LDEVs** tab, select the LDEV belonging to the pair that you want to delete forcibly, and then click **More Actions > Force Delete Pairs (UR Pairs)**.

4. In the **Force Delete Pairs (UR Pairs)** window, ensure that the volume you want to forcibly delete is in the **Selected LDEV** table.

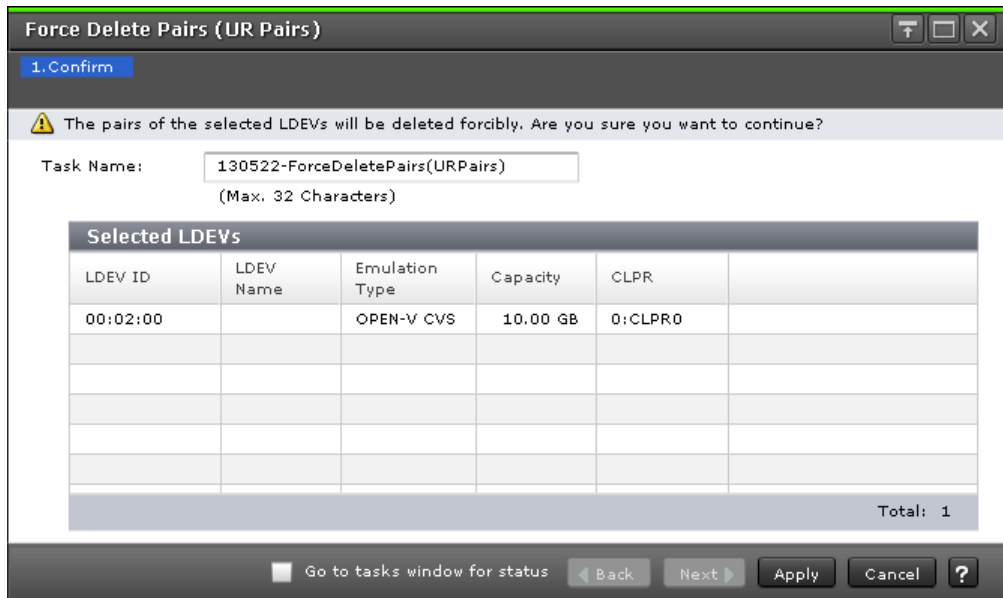

5. Enter a name in the **Task Name** box.
6. Click **Apply** to save your settings to the system.

Releasing the differential data managed in a pool

When a UR pair contains a DP-VOL that is larger than 4,194,304 MB (8,589,934,592 blocks), the differential data is managed by the pool to which the pair is related. If differential data management fails due to insufficient pool capacity, you need to release the differential data (pages) managed in the pool. You also need to release pages when you downgrade to a microcode version that does not support UR pairs with volumes larger than 4,194,304 MB.

Procedure

1. Delete all UR pairs that use the V-VOL for which you want to release the pages by using the `pairsplit -s` command.
2. Make sure that system option mode 755 is set to OFF. When system option mode 755 is set to ON, you cannot reclaim zero pages. For details about setting system option modes, contact your customer support representative.
3. Restore the blocked pool. For details, see the *Provisioning Guide* for your storage system.
4. Release the V-VOL pages by using the `raidcom modify ldev` command. Releasing pages might take some time. For details, see the *Provisioning Guide* for your storage system.

Restoring a pair by adding a reserve journal volume

Use the following procedure to restore a UR pair that was split due to disk failure of the pool and pool volume to which the journal volume belongs. When you use a reserve journal volume, you do not need to delete the UR pair.

Procedure

1. Add a reserve journal volume. For details, see [Adding a reserve journal volume on page 218](#).



Note: If an unallocated journal volume is not available to become the reserve journal volume, you must delete the journal, restore the blocked journal volume, register the journal volume to the journal again, and then create the UR pair. Allocate a DP-VOL to the journal volume. For details about the restoration procedure when the DP-VOL is blocked, see the *Provisioning Guide* for your storage system.

2. Verify that the volume you added is a reserve journal volume.
 - Device Manager - Storage Navigator:
Use the **Journal Volumes** window (**Type: Reserve Journal**).
 - CCI:
Use the `raidcom get journal` command.
3. Delete the first journal volume.
4. Resynchronize the pair, and then restore the UR pair.

Restoring a pair without adding a reserve journal volume

Use the following procedure to restore a UR pair that was split by disk failure of the pool and pool volume to which the journal volume belongs. If you do not recover the volume and do not use a reserve journal volume, the UR pair must be deleted.

Procedure

1. Resolve the problem with the volume, and then resynchronize the pair and restore the UR pair.

If the problem with the volume is not resolved, perform the following steps:

 - a. Delete the UR pair.
 - b. Delete the journal volume.
 - c. Re-create the journal using a volume that does not have any problems.
 - d. Re-create the UR pair.

Journal and mirror maintenance

This topic describes and provides instructions for the following journal and mirror maintenance tasks:

- [Changing options used by journals on page 211](#)
- [Changing options used by mirrors on page 213](#)
- [Adding an additional journal volume to an existing journal on page 215](#)
- [Replacing a journal volume with a reserve journal volume on page 216](#)
- [Adding a reserve journal volume on page 218](#)
- [Deleting journal volumes from a journal on page 218](#)
- [Deleting journals on page 219](#)

Changing options used by journals

Most Universal Replicator pair operations are performed on multiple pairs, which is done using journals. You can change the following options that affect the pairs in journals:

- **Inflow Control:** Allows you to restrict the inflow of data to allow other journals with higher priority data unrestricted inflow when the data transfer path accessing two journals is set.
- **Data Overflow Watch:** Establishes a timeout period.
In a 3DC multi-target configuration in which three UR sites are combined, if the status of the two mirrors in the primary site is both Active and the free space in the journal data area or metadata area is less than a certain amount, one of the mirrors in the journal will be suspended by error, regardless of the value in Data Overflow Watch.
- **Cache Mode:** Allows you to use journal data in the cache on the secondary storage system.

Before you begin

- Journal options must be changed on both storage systems, primary and secondary.
- To change journal options, one of the following conditions must be satisfied:
 - The attribute of the journal is Initial.
 - The status of the journal in the mirror is one of the following:
 - Initial
 - Stopped
 - Hold
 - Holding
 - Hold(Failure)

When one journal uses multiple mirrors, whether you can select Change Journal Option depends on the status of the journal whose mirror is not in

Hold, Holding or Hold(Failure) status. For example, if mirrors in the journal are in the Hold and Active status, you cannot change the journal option. If mirrors in the journal are in the Hold and Stopped status, you can change the journal option.

- When changing options for multiple journals, you can leave some options unchanged by entering or selecting no value. If you specify a value, it is applied to the selected journals.

Procedure

1. In the **Explorer** pane, expand the **Storage Systems** tree.
2. Expand the target storage system tree, expand **Replication**, and click **Journals**.
3. In the **Journals** tab, select the journal whose options you want to change.
4. Click **Edit Journal Options**.
5. In the **Edit Journal Options** dialog box, change the following options as needed.
 - Inflow Control
 - Data Overflow Watch
 - Cache Mode

For descriptions, see the procedure in [Creating journals and adding journal volumes on page 120](#).

Edit Journal Options

1.Edit Journal Options > 2.Confirm

This wizard lets you edit one or more properties.
Check the box in front of the property you want to edit, and then enter a new value.

Inflow Control: Enable Disable

Data Overflow Watch: Second(s)
(0-600)

Cache Mode: Enable Disable

< Back Next > Finish Cancel ?

6. Click **Finish**.
7. In the **Confirm** window, review the settings and enter a task name in the **Task Name** box.
8. Click **Apply** to save your settings to the system.

Changing options used by mirrors

Most pair operations are performed on multiple pairs. This is done using a journal or mirrors. You can change the following options that affect the pairs in a mirror:

- Path Watch Time: the interval from the time a path becomes blocked to the time when the mirror is suspended.
- Path Watch Time Transfer: forwards the master journal's Path Watch Time value to the restore journal.
- Copy Pace: the pace at which data is copied.
- Transfer Speed: the speed for data transfer.
- Delta Resync Failure: the processing that takes place in the event of a failure.

Before you begin

- Mirror options can be changed on both primary and secondary storage systems.
- To change mirror options, the status of the mirror must be one of the following:
 - Initial
 - Active
 - Stopped
 - Hold
 - Holding
 - Hold(Failure)
- The Transfer Speed option can be changed if the mirror's status is Active, Hold, or Holding. When the status is Holding, the option can only be changed from the primary storage system.
- When changing options for multiple mirrors, a changed value is applied to all the mirrors. On the other hand, leave the options unchanged that you do not want to change.

Procedure

1. In the **Explorer** pane, expand the **Storage Systems** tree.
2. Expand the target storage system tree, expand **Replication**, and click **Remote Replication**.
3. In the **Mirrors** tab, select the mirror whose options you want to change.
4. Click **More Actions > Edit Mirror Options**.
5. In the **Edit Mirror Options** window, for **Path Watch Time**, specify the interval from the time a path becomes blocked to the time when the mirror is suspended. Ranges are from 1 to 59 minutes, 1 to 23 hours, or 1 to 30 days. A numeric value is required.

The interval must be the same for master and restore journals in the same mirror, otherwise the journals suspend at different times. See next step to use this setting for both journals.

Important: If you want a mirror to split immediately after a path becomes blocked, ask customer support to set system option mode 448 to ON and set system option mode 449 to OFF.

The screenshot shows the 'Edit Mirror Options' wizard. The window title is 'Edit Mirror Options' and it shows a progress bar with '1.Edit Mirror Options' and '2.Confirm'. The main text says 'This wizard lets you edit one or more properties. Check the box in front of the property you want to edit, and then enter a new value.' There are five properties listed, each with a checkbox and a control: 'Path Watch Time' (radio buttons for Minute, Hour, Day; text input '5' with '(1-59)' below and 'mins' to the right), 'Path Watch Time Transfer' (radio buttons for Yes, No; 'No' is selected), 'Copy Pace' (dropdown menu showing 'Slower'), 'Transfer Speed' (dropdown menu showing '256' with 'Mbps' to the right), and 'Delta Resync Failure' (dropdown menu showing 'No Copy'). At the bottom are buttons for 'Back', 'Next', 'Finish', 'Cancel', and a help icon.

6. For **Path Watch Time Transfer**, specify whether to use the same Path Watch Time value you specified for the master journal for the restore journal. Specify this option in the primary site only.
 - **Yes:** The Path Watch Time value is also used for the restore journal. For a pair in a delta resync configuration, select **Yes** in the primary site.
 - **No** (default): The Path Watch Time value is not used for the restore journal.
7. For **Copy Pace**, specify the pace for initial copy activity per volume. Specify this option in the primary site only.
 - **Slower** is the default.
 - If specifying **Medium**, ensure that write I/O is 10 MB/s or less per parity group. If it exceeds 10 MB/s, pairs may be suspended.
 - If specifying **Faster**, ensure that I/O will not occur. If update I/O occurs, pairs may be suspended.
8. For **Transfer Speed**, specify data transfer line speed in Mbps (megabits per second). You can specify 256, 100, 10, or 3.
 - Use **3** when the transfer speed is 3 to 9 Mbps.
 - Use **10** when the transfer speed is 10 to 99 Mbps.
 - Use **100** when the transfer speed is 100 to 255 Mbps.
 - Use **256** when the transfer speed is 256 Mbps or higher.



Note: This setting does not affect master journals unless the CCI horctakeover command is used to change a master journal into a restore journal.

9. For **Delta Resync Failure**, specify the processing that takes place when the delta resync operation cannot be performed. Specify this option in the primary site only.
 - **Entire Copy** (default): the entire P-VOL is copied to the S-VOL. Use Entire if your journals are part of a multiple-journal configuration in a CCI consistency group.
 - **No Copy**: No processing occurs: the S-VOL is not updated.
10. Click **Finish**.
11. In the **Confirm** window, review the settings and enter a task name in the **Task Name** box.
12. Click **Apply** to save your settings to the system.

Adding an additional journal volume to an existing journal

You can add one additional journal volume to a journal. The additional volume is not used unless needed for maintenance or to replace the first journal volume. In the event of pair failure, the additional reserve journal volume allows you to reduce the time to recover a blocked journal volume.

Before you begin

- Review the following:
 - [System requirements on page 44](#)
 - [Planning journals on page 67](#)
 - [Planning journal volumes on page 67](#)
- The journal's mirror status must be Initial, Active, Stopped, Hold, Holding, or Hold(Failure).
- The journal cannot be in use.
- Pair operations involving the journal cannot be in progress.
- Cache Residency Manager settings cannot be defined for the volumes.
- Adding a reserve journal volume to a journal while remote copy is in progress causes only the journal data area to be used, but not the metadata area, because it is unavailable. To make the metadata area available in this case, split and resynchronize all pairs in the journal group.

Procedure

1. In the **Explorer** pane, expand the **Storage Systems** tree.
2. Expand the target storage system tree, expand **Replication**, and click **Remote Replication**.
3. In the **Mirrors** tab, select the **Journal ID** link for the journal you want to add journal volumes to.
4. In the **Journal Volumes** tab, click **Assign Journal Volumes**.
5. In the **Assign Journal Volumes** window, from the **Unassigned Journal Volumes** table, select the journal volume to be added to the journal, and then click **Add**. The selected journal volume moves to the **Assigned Journal Volumes** table.

To remove a volume from the table, select the volume and click **Remove**.

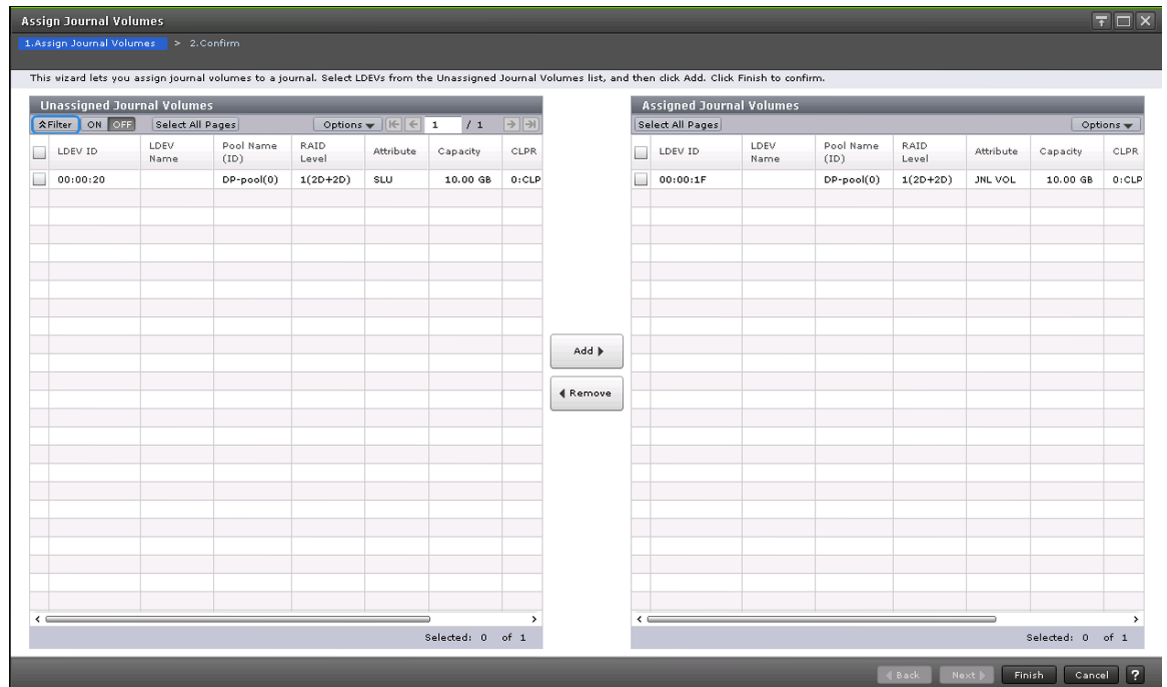

Note: Only OPEN-V volumes are displayed in the Unassigned Journal Volumes table.

6. Click **Finish**.
7. In the **Confirm** window, review the settings and enter a task name in the **Task Name** box.
8. Click **Apply** to save your settings to the system.

Replacing a journal volume with a reserve journal volume

When you register two journal volumes in a journal, the second journal volume becomes the reserve journal volume, which is not used for normal operations. For details about reserve journal volumes, see [Journal volumes on page 24](#). For instructions on using CCI to replace a journal volume with a reserve journal volume, see [Replacing a journal volume with a reserve journal volume using CCI on page 217](#).

Before you begin

- Required role: Storage Administrator (Remote Backup Management)
- An unallocated journal volume that will be the reserve journal volume must be available.



Note: If an unallocated journal volume is not available to become the reserve journal volume and the journal volume is blocked, you must delete the journal, restore the blocked journal volume, register the journal volume to the journal again, and then re-create the suspended UR pairs. Allocate a DP-VOL to the journal volume. For details about the restoration procedure when the DP-VOL is blocked, see the *Provisioning Guide* for your storage system.

Procedure

1. Add a reserve journal volume to the journal. For details, see [Adding a reserve journal volume on page 218](#).
2. Delete the journal volume that is in use. For details, see [Deleting journal volumes from a journal on page 218](#).
3. Resynchronize the journal.

Replacing a journal volume with a reserve journal volume using CCI

Before you begin

- Required role: Storage Administrator (Remote Backup Management)
- An unallocated journal volume that will be the reserve journal volume must be available.
- Specify the CCI instance number by using the `-I` parameter as needed.

Procedure

1. Add a reserve journal volume to the journal.

```
raidcom add journal -journal_id <journal ID#> -ldev_id <ldev#>
```

- `<journal ID#>`: Specify the journal ID to which the replacement target journal volume is registered.
- `<ldev#>`: Specify the LDEV number of the unallocated journal volume that will be the reserve journal volume.

2. Check the LDEV number of the journal volume that is currently being used.

```
raidcom get journal
```

- The LDEV number displayed in the **LDEV#** column of the command output is the LDEV number that is currently being used.

3. Delete the journal volume to be replaced.

```
raidcom delete journal -journal_id <journal ID#> -ldev_id <ldev#>
```

- `<journal ID#>`: Specify the journal ID to which the replacement target journal volume is registered.

- <ldev#>: Specify the journal volume LDEV number checked in step 2.
4. Resynchronize the journal.

```
pairresync -g <group>
```

- <group>: Specify the data volume group name that is using the journal. The group name to be specified here is the group name defined in the CCI configuration definition file.
- Specify the `-IH` parameter as needed.

Adding a reserve journal volume

Before you begin

An unallocated journal volume that will be the reserve journal volume must be available.

Procedure

1. In the **Explorer** pane, expand the **Storage Systems** tree.
2. Expand the target storage system tree, expand **Replication**, and click **Remote Replication**.
3. In the **Mirrors** tab, select the **Journal ID** link for the journal to which you want to add journal volumes.
4. In the **Journal Volumes** tab, click **Assign Journal Volumes**.
5. In the **Assign Journal Volumes** window, from the **Unassigned Journal Volumes** table, select the journal volume to be added to the journal, and then click **Add**. The selected journal volume moves to the **Assigned Journal Volumes** table.
To remove a volume from the table, select the volume and click **Remove**.
6. Click **Finish**.
7. In the **Confirm** window, review the settings and enter a task name in the **Task Name** box.
8. Click **Apply** to save your settings to the system.

Deleting journal volumes from a journal

Before you begin

- A journal volume can only be deleted when one or more of the following conditions exists:
 - If the pair belonging to the mirror in the journal is suspended and a reserve journal volume exists.
 - If the pair belonging to the mirror in the journal is deleted.
 - If the state of every mirror in the journal is Initial, Stopped, or Hold(Failure), and a reserve journal volume exists. If one journal uses

more than one mirror, you can delete a journal volume only under the conditions specified in the following table.

Table 4 Conditions for deleting a journal volume (when one journal uses two types of mirror IDs)

Status of journal		Other conditions
Mirror ID 1	Mirror ID 2	
Stopped	Stopped	-
Stopped	Hold(Failure)	When a 3DC configuration of UR and TC or GAD is used. When a 3DC configuration in which three UR sites are combined.

- If all journal volumes in a journal are deleted (the journal is empty), all journal option data is initialized. To reset the journal's options, see [Changing options used by journals on page 211](#).

Procedure

1. In the **Explorer** pane, expand the **Storage Systems** tree.
2. Expand the target storage system tree, expand **Replication**, and click **Remote Replication**.
3. In the **Mirrors** tab, select the **Journal ID** link for the journal you want to delete journal volumes from.
4. In the **Journal Volumes** tab, click **Assign Journal Volumes**.
5. From the **Assigned Journal Volumes** table, select the volumes to be deleted and click **Remove**.
6. Click **Finish**.
7. In the **Confirm** window, review the settings and enter a task name in the **Task Name** box.
8. Click **Apply** to save your settings to the system.

Deleting journals

Journals can be deleted from either system.

Before you begin

- Journals can be deleted from the primary or secondary storage system.
- All mirrors in the journal must be Initial status.
- Master and restore journals cannot be deleted.
- Removing a journal volume from a journal that is registered results in the journal volume's LDEVs becoming blockaded. You can release the blockade by formatting the LDEVs.

Procedure

1. In the **Explorer** pane, expand the **Storage Systems** tree.
2. Expand the target storage system tree, expand **Replication**, and click **Journals**.
3. In the **Journals** tab, select the **Journal ID** for the journal to be deleted.
4. Click **Delete Journals**.
5. In the **Delete Journals** window, make sure the journals you want to delete are listed in the **Selected Journals** table. To view more information about a journal, select the journal and click **Detail**. If you need to change the selections, click **Cancel**.

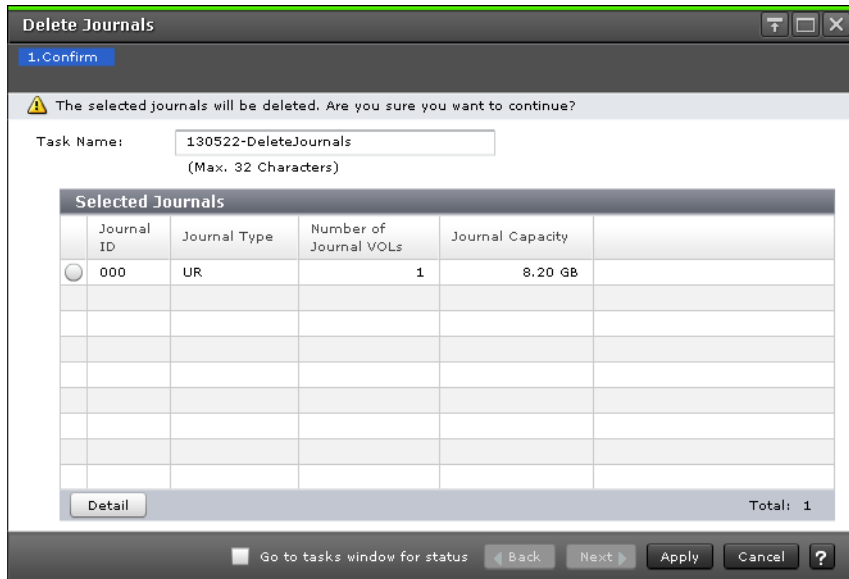

6. When satisfied, click **Finish**.
7. In the **Confirm** window, review the settings and enter a task name in the **Task Name** box.
8. Click **Apply** to save your settings to the system.

Remote path maintenance

This topic describes and provides instructions for the following remote path maintenance tasks:

- [Modifying the data-transfer time threshold on page 221](#)
- [Deleting remote paths on page 221](#)
- [Deleting the UR relationship on page 222](#)

Modifying the data-transfer time threshold

You can modify the threshold for data transfer to complete. If the threshold value is reached, the transfer is flagged as failing by the system.

Before you begin

- This operation can be performed from the primary or secondary storage system.
- The setting is made in the RIO MIH field on the DKC Options dialog box (RIO MIH--remote I/O missing interrupt handler).

Procedure

1. In the **Explorer** pane, expand the **Storage Systems** tree.
2. Expand the target storage system tree, expand **Replication**, and click **Remote Connections**.
3. In the **Connections (To)** tab, select the **Remote Storage System** with the data-transfer waiting-time to be changed.
4. Click **Edit Remote Connection Options**.
5. In the **Edit Remote Connection Options** window, note that **Minimum Paths** cannot be changed.
6. For **RIO MIH Time**, specify the amount of time the system waits before a data transfer operation is flagged as failed. The range is 10 to 100 seconds, and the default is 15 seconds.
7. Click **Finish**.
8. In the **Confirm** window, review the settings and enter a task name in the **Task Name** box.
9. Click **Apply** to save your settings to the system.

Deleting remote paths

You can delete remote paths from the primary or secondary storage systems.

Before you begin

- Before deleting remote paths, make sure that the remaining number of remote paths will be greater than the minimum number of paths setting. You can do this in the View Remote Connection Properties window. The delete path operation will fail if the number of remaining paths is equal to or less than the minimum number of paths.
- The primary storage system administrator can delete remote paths between the initiator port of the primary storage system and the RCU target port of the secondary storage system. The secondary System administrator can delete remote paths between the initiator port of the secondary storage system and the RCU target port of the primary storage system.

Procedure

1. In the **Explorer** pane, expand the **Storage Systems** tree.
2. Expand the target storage system tree, expand **Replication**, and click **Remote Connections**.
3. In the **Connections (To)** tab, select the **Remote Storage System** with the remote path you want to delete.
4. Click **More Actions > Remove Remote Paths**.
5. In the **Remove Remote Paths** window, in the **Remote Paths** box, check the **Remove** box or boxes for the remote paths to be deleted.

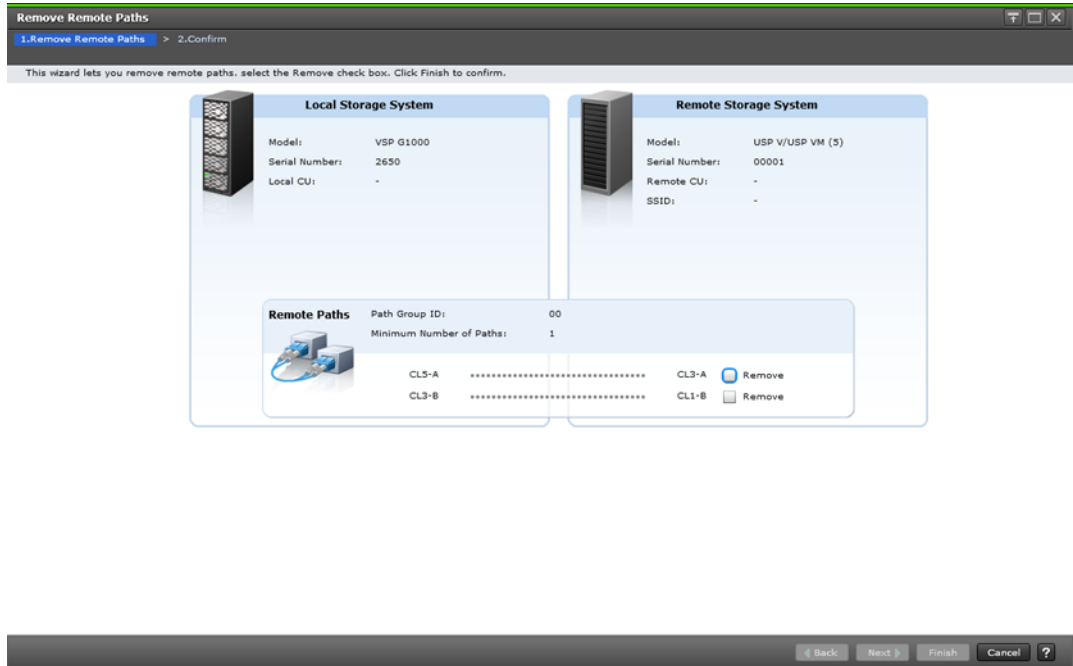

6. Click **Finish**.
7. In the **Confirm** window, review the settings and enter a task name in the **Task Name** box.
8. Click **Apply** to save your settings to the system.

Deleting the UR relationship

You can remove the Universal Replicator pair relationship between primary and secondary storage systems. You do this by removing the remote connection.

Before you begin

- Removing the relationship between the primary and the secondary storage systems also removes the remote paths between them.
- This operation must be performed on both the primary and secondary storage systems.

Procedure

1. In the **Explorer** pane, expand the **Storage Systems** tree.
2. Expand the target storage system tree, expand **Replication**, and click **Remote Connections**.
3. In the **Connections (To)** tab, select the **Remote Storage System** whose remote connection you want to delete.
4. Click **More Actions > Remove Remote Connections**.
5. In the **Remove Remote Connections** window, in the **Selected Remote Connections** box, check the **Remove** box for the remote connection to be deleted. To view more information about a remote path, select the path and click **Detail**. If you need to change the selections, click **Cancel**.

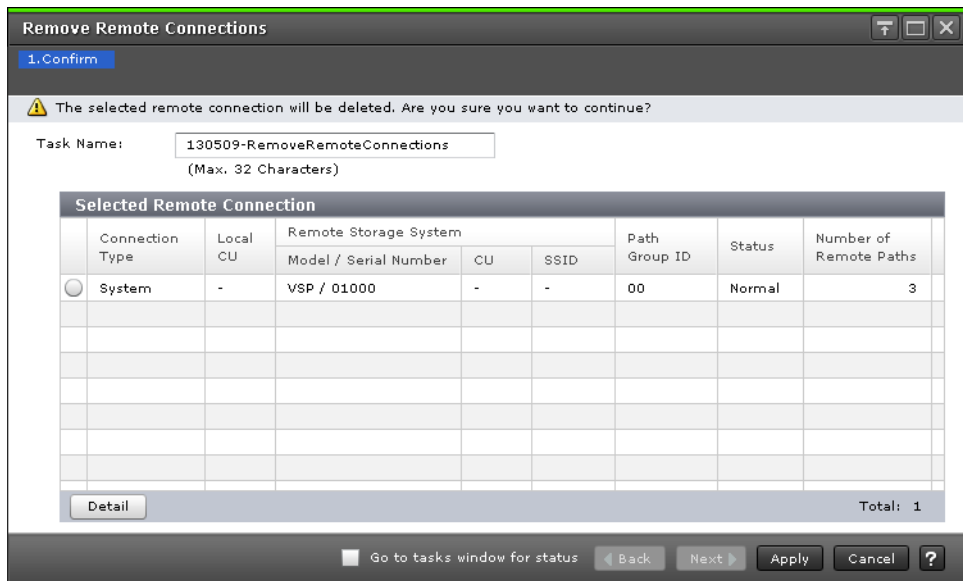

6. Click **Finish**.
7. In the **Confirm** window, review the settings and enter a task name in the **Task Name** box.
8. Click **Apply** to save your settings to the system.

Managing power-off for systems and network devices

This topic describes power management for systems and network relay devices during copy operations:

- How to proceed when power is removed from systems or network relay devices for some unexpected reason.
- How to perform a planned outage of systems or network relay devices. Network relay devices include hardware that connects the primary and secondary storage systems, such as channel extenders and switches.

When power stops unexpectedly

This topic describes what happens when power is removed from the storage systems or network relay devices for some unexpected reason.



Caution: When a system is powered on, you must wait five (5) minutes before performing Universal Replicator operations. If not, the pairs might be suspended with a failure.

When power is removed from primary or secondary storage system

- If power is removed from the primary storage system during remote copy operations, the primary storage system assumes that a failure has occurred and splits all pairs. When the primary storage system splits pairs, the secondary storage system also assumes that a failure occurs and splits all pairs.
- If power is removed from the secondary storage system during remote copy operations, the secondary storage system assumes that a failure has occurred and splits all pairs. When the secondary storage system splits pairs, the primary storage system also assumes that a failure occurs and splits all pairs.

When power is removed from network relay devices

If power is removed from a network relay device during remote copy operations, the primary and secondary storage systems assume that a failure has occurred and split all pairs.

Planned outage of storage systems and network devices

This topic provides instructions for performing a planned outage of storage systems and network relay devices.



Note: When you are planning to intentionally power off the primary or secondary storage system, contact your HDS account team and ask them to power off the system.

To power off primary and secondary storage systems at the same time, see [Powering-off primary and secondary storage systems at the same time on page 225](#).

Powering-off the primary or secondary storage system

Use the following procedure to power off the primary or secondary storage system.

Procedure

1. Ensure that all pairs or mirrors are split and that the status of all the pairs is PSUS. Otherwise the pairs could be suspended due to failure.

2. Turn power off.
3. When ready, power on the system.



Caution: Wait five (5) minutes after powering on a system before performing Universal Replicator operations; otherwise the pairs could be suspended with a failure.

4. When the system is ready to resume copy operations, on the primary site, resynchronize the pairs that have been split.
5. Confirm that the status of the pairs is COPY or PAIR.

Correcting errors made when powering-off

If a secondary storage system remains in Suspending status because you powered-off while the primary storage system was copying data, delete the pair forcibly in both primary and secondary storage system, and then re-create the pair.

Powering-off primary and secondary storage systems at the same time

The primary storage system must be powered off before the secondary storage system is powered off. When you are ready to power the systems on, the secondary storage system must be powered on before the primary storage system.

Use the following procedure to power off the primary and secondary storage systems at the same time.

Procedure

1. Split all pairs that will be affected. For example, if two primary storage systems and one secondary storage system are connected to each other and you want to power off one of the primary storage system and the secondary storage system, you must split the pairs on all three systems since they are all affected.
2. After the pairs are split, confirm that their status is PSUS at the primary storage system.
3. Power off the primary storage system.
4. Power off the secondary storage system.
5. Power on the secondary storage system.
6. When the secondary storage system is ready to resume copy operations, power on the primary storage system.



Caution: Wait five (5) minutes after powering on a system before performing Universal Replicator operations; otherwise the pairs could be suspended with a failure.

7. When the primary storage system is ready to resume copy operations, resynchronize the pairs that have been split at the primary storage system. Confirm that the status of the pairs is changed to COPY or PAIR.

Result

After turning power on or off for both the primary and secondary storage system at the same time, if pair status at primary storage system is PSUS and a status of a pair of secondary storage system is PAIR, use Device Manager - Storage Navigator to suspend the pair of the secondary storage system. After confirming that the statuses of the pair on both systems is PSUS, resynchronize the pair at the primary storage system.

Powering-off network relay devices

Use the following procedure to power off network relay devices.

Procedure

1. Ensure that all pairs or mirrors are split and that the status of all the pairs is PSUS.
2. Power off the device.
3. When ready power on the network relay device.
4. When the network relay device is ready for copy operations, from the primary site, resynchronize the pairs that have been split.
5. Confirm that pair status is COPY or PAIR.

Planned outage of storage systems in a GAD 3DC delta resync environment (VSP G1000, G1500, and VSP F1500)

This topic describes and provides instructions for performing planned outages of storage systems in a GAD 3DC delta resync (GAD+UR) environment. For details about I/O modes, see the *Global-Active Device User Guide*.

Powering off the GAD+UR primary storage system

Use the following procedure to power off the primary storage system in a GAD 3DC delta resync environment.

Procedure

1. Using the alternate path software, stop I/O from servers to the primary storage system.
Direct server I/O to the GAD secondary storage system.
2. On the GAD secondary storage system, suspend the GAD pairs by specifying the S-VOL (swap suspension).

Command example: `pairsplit -g oraHA -RS -IH1`

3. Confirm that the pair types and the pair statuses are changed as shown in the following table.

Before the GAD pair suspension			After the GAD pair suspension		
Pair type	Pair status		Pair type	Pair status	
	P-VOL	S-VOL		P-VOL	S-VOL
GAD pair	PAIR (Mirror(RL))	PAIR (Mirror(RL))	GAD pair	PSUS (Block)	SSWS (Local)
UR pair	PAIR	PAIR	UR delta resync pair	PSUE ¹	SSUS ²
UR delta resync pair	PSUS ²	SSUS ²	UR pair	PAIR	PAIR

Notes:

1. Device Manager - Storage Navigator displays HOLDING.
2. Device Manager - Storage Navigator displays HOLD.

4. Power off the primary storage system.

Powering on the GAD+UR primary storage system

Use the following procedure to power on the primary storage system in a GAD 3DC delta resync environment.

Procedure

1. Power on the primary storage system.
2. Confirm that the storage systems do not have any blocked parts.
If any parts are blocked, recover them.
3. Check for SIMs about path blockage, and delete the SIMs.
4. On the GAD secondary storage system, resynchronize the GAD pair by specifying the S-VOL (swap resync).

Command example: `pairresync -g oraHA -swaps -IH1`

A volume on the primary storage system changes to an S-VOL, and a volume on the secondary storage system changes to a P-VOL.

5. Confirm that the pair statuses are changed as shown in the following table.

Pair type	Before the GAD pair resync		After the GAD pair resync	
	P-VOL	S-VOL	P-VOL	S-VOL
GAD pair	PSUS (Block)	SSWS (Local)	PAIR (Mirror(RL))	PAIR (Mirror(RL))
UR delta resync pair	PSUE ¹	SSUS ²	PSUE ¹	SSUS ²
UR pair	PAIR	PAIR	PAIR	PAIR

Notes:

1. Device Manager - Storage Navigator displays HOLDING.

Pair type	Before the GAD pair resync		After the GAD pair resync	
	P-VOL	S-VOL	P-VOL	S-VOL
2. Device Manager - Storage Navigator displays HOLD.				

- Keep updating I/O to the P-VOL or GAD S-VOL for two minutes.
The information on the system configuration is reported among the primary, GAD secondary, and UR secondary storage systems. At the time, the UR delta resync pair status is changed from PSUE to PSUS. The mirror status of the journal is displayed as PJNS. Confirm that no failure SIMs are displayed.

Next steps

The GAD P-VOL and S-VOL are now reversed compared to the original configuration before the planned outage. To restore the original configuration, reverse the GAD P-VOL and S-VOL.

Related tasks

- [Reversing the GAD P-VOL and S-VOL \(GAD+UR\)](#) on page 272

Powering off the GAD secondary storage system

Use the following procedure to power off the GAD secondary storage system in a GAD 3DC delta resync environment.

Procedure

- Using the alternate path software, stop I/O from servers to the GAD secondary storage system.
Direct server I/O to the primary storage system.
- On the primary storage system, resynchronize the GAD pair by specifying the P-VOL.
Command example: `pairsplit -g oraHA -IH0`
- Confirm that the pair statuses are changed as shown in the following table.

Pair type	Before the GAD pair suspension		After the GAD pair suspension	
	P-VOL	S-VOL	P-VOL	S-VOL
GAD pair	PAIR (Mirror(RL))	PAIR (Mirror(RL))	PSUS (Local)	PSUS (Block)
UR pair	PAIR	PAIR	PAIR	PAIR
UR delta resync pair	PSUS ¹	SSUS ¹	PSUE ²	SSUS ¹
Notes:				
1. Device Manager - Storage Navigator displays HOLD.				
2. Device Manager - Storage Navigator displays HOLDING.				

- Power off the GAD secondary storage system.

Powering on the GAD secondary storage system

Use the following procedure to power on the GAD secondary storage system in a GAD 3DC delta resync environment.

Procedure

1. Power on the GAD secondary storage system.
2. Confirm that the primary and secondary storage systems and the external storage system for the quorum disk do not have any blocked parts.
If any parts are blocked, recover them.
3. Check for SIMs about path blockage, and delete the SIMs.
4. On the primary storage system, resynchronize the GAD pairs by specifying the P-VOL.
Command example: `pairresync -g oraHA -IH0`
5. Confirm that the pair statuses are changed as shown in the following table.

Pair type	Before the GAD pair resync		After the GAD pair resync	
	P-VOL	S-VOL	P-VOL	S-VOL
GAD pair	PSUS (Local)	PSUS (Block)	PAIR (Mirror(RL))	PAIR (Mirror(RL))
UR pair	PAIR	PAIR	PAIR	PAIR
UR delta resync pair	PSUE ¹	SSUS ²	PSUE ¹	SSUS ²
Notes:				
1. Device Manager - Storage Navigator displays HOLDING.				
2. Device Manager - Storage Navigator displays HOLD.				

6. Keep updating I/O to P-VOL or GAD S-VOL for two minutes.
The information on the system configuration is reported among the primary, GAD secondary, and UR secondary storage systems. At the time, the UR delta resync pair status is changed from PSUE to PSUS. The mirror status of the journal is displayed as PJNS. Confirm that no failure SIMs are displayed.

Powering off the UR secondary storage system

Use the following procedure to power off the UR secondary storage system in a GAD 3DC delta resync environment.

Procedure

1. On the primary storage system, suspend the UR pairs by specifying the P-VOL.
Command example: `pairsplit -g oraREMOTE -IH0`

- Confirm that the pair statuses are changed as shown in the following table.

Pair type	Before the GAD pair suspension		After the GAD pair suspension	
	P-VOL	S-VOL	P-VOL	S-VOL
GAD pair	PAIR (Mirror(RL))	PAIR (Mirror(RL))	PAIR (Mirror(RL))	PAIR (Mirror(RL))
UR pair	PAIR	PAIR	PSUS	PSUS
UR delta resync pair	PSUS ¹	SSUS ¹	PSUE ²	SSUS ¹
Notes:				
1. Device Manager - Storage Navigator displays HOLD.				
2. Device Manager - Storage Navigator displays HOLDING.				

- Power off the UR secondary storage system.

Powering on the UR secondary storage system

Use the following procedure to power on the UR secondary storage system in a GAD 3DC delta resync environment.

Procedure

- Power on the UR secondary storage system.
- Confirm that the primary and secondary storage systems and the external storage system for the quorum disk do not have any blocked parts.
If any parts are blocked, recover them.
- Check for SIMs about path blockage, and delete the SIMs.
- On the primary storage system, resynchronize the UR pairs by specifying the P-VOL.

Command example: `pairresync -g oraREMOTE -IH0`

- Confirm that the pair statuses are changed as shown in the following table.

Pair type	Before the GAD pair resync		After the GAD pair resync	
	P-VOL	S-VOL	P-VOL	S-VOL
GAD pair	PAIR (Mirror(RL))	PAIR (Mirror(RL))	PAIR (Mirror(RL))	PAIR (Mirror(RL))
UR pair	PSUS	PSUS	PAIR	PAIR
UR delta resync pair	PSUE ¹	SSUS ²	PSUE ¹	SSUS ²
Notes:				
1. Device Manager - Storage Navigator displays HOLDING.				
2. Device Manager - Storage Navigator displays HOLD.				

- Keep updating I/O to P-VOL or GAD S-VOL for two minutes.
The information on the system configuration is reported among the primary, GAD secondary, and UR secondary storage systems. At the

time, the UR delta resync pair status is changed from PSUE to PSUS. The mirror status of the journal is displayed as PJNS. Confirm that no failure SIMs are displayed.

Powering off the external storage system, I/O at primary site (GAD +UR)

Use the following procedure to power off the external storage system when server I/O continues to the primary storage system in a GAD 3DC delta resync environment.

Procedure

- Using the alternate path software, stop I/O from servers to the GAD secondary storage system.
Direct server I/O to the primary storage system.
- On the primary storage system, resynchronize the GAD pair by specifying the P-VOL.
Command example: `pairsplit -g oraHA -IH0`
- Confirm that the pair statuses are changed as shown in the following table.

Pair type	Before the GAD pair suspension		After the GAD pair suspension	
	P-VOL	S-VOL	P-VOL	S-VOL
GAD pair	PAIR (Mirror(RL))	PAIR (Mirror(RL))	PSUS (Local)	PSUS (Block)
UR pair	PAIR	PAIR	PAIR	PAIR
UR delta resync pair	PSUS ¹	SSUS ¹	PSUE ²	SSUS ¹
Notes:				
1. Device Manager - Storage Navigator displays HOLD.				
2. Device Manager - Storage Navigator displays HOLDING.				

- On the primary and GAD secondary storage systems, disconnect the quorum disks.

Command example: `raidcom disconnect external_grp -ldev_id 0x9999 -IH0`



Note: When you disconnect a quorum disk, SIM (def0zz) (quorum disk blockade) might be issued (zz: quorum disk ID). If this SIM is issued, delete the SIM after powering on the storage system and reconnecting the quorum disk.

- Power off the external storage system.

Powering on the external storage system, I/O at primary site (GAD +UR)

Use the following procedure to power on the external storage system when server I/O continues to the primary storage system in a GAD 3DC delta resync environment.

Procedure

1. Power on the external storage system.
2. Confirm that the primary and secondary storage systems and the external storage system for the quorum disk do not have any blocked parts.
If any parts are blocked, recover them.
3. Check for SIMs about path blockage, and delete the SIMs.
4. On the primary and GAD secondary storage systems, establish the connections to the quorum disks.
Command example: `raidcom check_ext_storage external_grp -ldev_id 0x9999 -IH0`
5. On the primary and GAD secondary storage systems, confirm that the connections to the quorum disks have been established.
Command example: `raidcom get external_grp -external_grp_id 1-1 -IH0`
6. Confirm that the external volumes of the primary and GAD secondary storage systems are recognized as quorum disks.
Command example: `raidcom get ldev -ldev_id 0x9999 -IH0`
7. On the primary and GAD secondary storage systems, check for SIMs about quorum disk blockade, and delete the SIMs.
8. Wait for more than 5 minutes after completing step 4, and then resynchronize the GAD pairs on the primary storage system by specifying the P-VOL.
Command example: `pairresync -g oraHA -IH0`
9. Confirm that the pair statuses are changed as shown in the following table.

Pair type	Before the GAD pair resync		After the GAD pair resync	
	P-VOL	S-VOL	P-VOL	S-VOL
GAD pair	PSUS (Local)	PSUS (Block)	PAIR (Mirror(RL))	PAIR (Mirror(RL))
UR pair	PAIR	PAIR	PAIR	PAIR
UR delta resync pair	PSUE ¹	SSUS ²	PSUE ¹	SSUS ²
Notes:				
1. Device Manager - Storage Navigator displays HOLDING.				
2. Device Manager - Storage Navigator displays HOLD.				

- Keep updating I/O to P-VOL or GAD S-VOL for two minutes.
The information on the system configuration is reported among the primary, GAD secondary, and UR secondary storage systems. At the time, the UR delta resync pair status is changed from PSUE to PSUS. The mirror status of the journal is displayed as PJNS. Confirm that no failure SIMs are displayed.

Related tasks

- [Reversing the GAD P-VOL and S-VOL \(GAD+UR\)](#) on page 272

Powering off external storage system, I/O at secondary site (GAD+UR)

Use the following procedure to power off the external storage system when server I/O continues to the GAD storage system in a GAD 3DC delta resync environment.

Procedure

- Using the alternate path software, stop I/O from servers to the primary storage system. Direct server I/O to the GAD secondary storage system.
- On the GAD secondary storage system, suspend the GAD pairs by specifying the S-VOL (swap suspension).
Command example: `pairsplit -g oraHA -RS -IH1`
- Confirm that the pair types and the pair statuses are changed as shown in the following table.

Before the GAD pair suspension			After the GAD pair suspension		
Pair type	Pair status		Pair type	Pair status	
	P-VOL	S-VOL		P-VOL	S-VOL
GAD pair	PAIR (Mirror(RL))	PAIR (Mirror(RL))	GAD pair	PSUS (Block)	SSWS (Local)
UR pair	PAIR	PAIR	UR delta resync pair	PSUE ¹	SSUS ²
UR delta resync pair	PSUS ²	SSUS ²	UR pair	PAIR	PAIR
Notes:					
1. Device Manager - Storage Navigator displays HOLDING.					
2. Device Manager - Storage Navigator displays HOLD.					

- On the primary and GAD secondary storage systems, disconnect the quorum disks.

Command example: `raidcom disconnect external_grp -ldev_id 0x8888 -IH1`



Note: When you disconnect a quorum disk, SIM (def0zz) (quorum disk blockade) might be issued (zz: quorum disk ID). If this SIM is issued, delete the SIM after powering on the storage system and reconnecting the quorum disk.

5. Power off the external storage system.

Powering on external storage system, I/O at secondary site (GAD +UR)

Use the following procedure to power on the external storage system when server I/O continues to the GAD storage system in a GAD 3DC delta resync environment.

Procedure

1. Power on the external storage system.
2. Confirm that the primary and secondary storage systems and the external storage system for the quorum disk do not have any blocked parts.
If any parts are blocked, recover them.
3. Check for SIMs about path blockage, and delete the SIMs.
4. On the primary and GAD secondary storage systems, establish the connections to the quorum disks.
Command example: `raidcom check_ext_storage external_grp -ldev_id 0x8888 -IH1`
5. On the primary and GAD secondary storage systems, confirm that the connections to the quorum disks have been established.
Command example: `raidcom get external_grp -external_grp_id 1-2 -IH1`
6. Confirm that the external volumes of the primary and GAD secondary storage systems are recognized as quorum disks.
Command example: `raidcom get ldev -ldev_id 0x8888 -IH1`
7. On the primary and GAD secondary storage systems, check for SIMs about quorum disk blockade, and delete the SIMs.
8. Wait for more than 5 minutes after completing step 4, and then resynchronize the GAD pairs on the GAD secondary storage system by specifying the S-VOL (swap resync).
Command example: `pairresync -g oraHA -swaps -IH1`
A volume on the primary storage system changes to an S-VOL, and a volume on the secondary storage system changes to a P-VOL.
9. Confirm that the pair statuses are changed as shown in the following table.

Pair type	Before the GAD pair resync		After the GAD pair resync	
	P-VOL	S-VOL	P-VOL	S-VOL
GAD pair	PSUS (Block)	SSWS (Local)	PAIR (Mirror(RL))	PAIR (Mirror(RL))
UR delta resync pair	PSUE ¹	SSUS ²	PSUE ¹	SSUS ²
UR pair	PAIR	PAIR	PAIR	PAIR
Notes:				
1. Device Manager - Storage Navigator displays HOLDING.				
2. Device Manager - Storage Navigator displays HOLD.				

- 10.** Keep updating I/O to P-VOL or GAD S-VOL for two minutes.

The information on the system configuration is reported among the primary, GAD secondary, and UR secondary storage systems. At the time, the UR delta resync pair status is changed from PSUE to PSUS. The mirror status of the journal is displayed as PJNS. Confirm that no failure SIMs are displayed.

Next steps

The GAD P-VOL and S-VOL are reversed compared to the original configuration (before the planned outage). To restore the original configuration, reverse the GAD P-VOL and S-VOL.

Related tasks

- [Reversing the GAD P-VOL and S-VOL \(GAD+UR\)](#) on page 272

UR disaster recovery operations

This chapter provides instructions for performing disaster recovery operations using Command Control Interface, including general recovery planning and procedures, recovery for 3DC configurations, and recovery for UR/ShadowImage shared configurations.

- [Overview of disaster recovery operations](#)
- [Workflow for disaster recovery](#)
- [Recovery for configurations with multiple primary systems and secondary systems](#)
- [Recovery for 3DC configurations with three UR sites](#)
- [Recovery for 3DC UR/TC](#)
- [Recovery for UR/SI configurations](#)
- [Recovery from a failure at the primary site and TC secondary site](#)
- [Recovery for UR/GAD configurations](#)

Overview of disaster recovery operations

The primary reason for using Universal Replicator and other remote replication software is disaster recovery. With copies of data at a secondary location, you can transfer operations to the secondary site, restore the lost or damaged information at the primary site, and then restore operations to the original configuration when recovery is complete.

Maintaining copies in multiple secondary locations increases the level of data security, but some recovery procedures can be complex.

Related concepts

- [Workflow for disaster recovery](#) on page 238

Related tasks

- [Recovery for 3 UR DC multi-target configuration \(when the delta operation resync is performed\)](#) on page 242
- [Recovery for 3DC UR/TC cascade configuration](#) on page 256
- [Recovery for UR/SI configurations](#) on page 261

Workflow for disaster recovery

Workflow for disaster recovery operations

1. Prepare your data centers for disaster recovery, including identifying the data to be backed up, establishing the copy pairs, and installing and configuring the host failover software.
See [Preparing for disaster recovery on page 239](#).
2. Establish file and database recovery procedures before disaster or failure occurs, as part of the UR planning process.
See [Preparing for file and database recovery on page 239](#).
3. When a disaster or failure occurs at the primary site, switch host operations to the secondary site.
See [Switching host operations to the secondary site on page 239](#).
4. While host operations continue at the secondary site, recover the primary site, and then reverse the copy direction of the volume pairs to copy the current host data from the secondary site back to the primary site.
See [Reversing copy direction from secondary to primary site on page 240](#).
5. When the copy pairs are again synchronized, resume host operations at the primary site, and re-establish the original copy direction of the volume pairs.
See [Resuming host operations at the primary site on page 240](#).

Preparing for disaster recovery

Perform the following tasks to prepare for disaster recovery:

- Identify the data volumes that you want to back up for disaster recovery.
- Pair the important volumes using Universal Replicator.
- Install and configure the required software for host failover between the primary and secondary sites.

Preparing for file and database recovery

File recovery procedures are necessary when the primary or secondary storage system suspends a pair due to a disaster or failure. When this occurs, the S-VOL might contain in-process data resulting from an open data set or transactions that could not complete. File recovery procedures in these circumstances are the same as when a data volume becomes inaccessible due to control unit failure.

You detect and re-create lost updates by checking database log files and other current information at the primary site.

Design your recovery plan so that detection and retrieval of lost updates is performed after the application is started at the secondary site. The detection and retrieval process can take some time.

Prepare for file and database recovery using files for file recovery (for example, database log files that have been verified as current).

Remote copy and disaster recovery procedures are inherently complex. Consult your HDS account team about recovery procedures.

Switching host operations to the secondary site

Use these instructions for pairs in one or more primary or secondary storage systems.

The first recovery task is to switch host operations to the secondary site using the CCI horctakeover command.

- The horctakeover command checks the pair status of S-VOLs and splits journals. Splitting the pairs in the journals ensures consistency and usability in the S-VOLs.
- The horctakeover command attempts to resynchronize pairs to reverse P-VOLs and S-VOLs.
- If the horctakeover command runs successfully, host operations are taken over by the secondary site using the S-VOLs. For detailed information about CCI and horctakeover, see *Command Control Interface User and Reference Guide*.

Reversing copy direction from secondary to primary site

When host operations have been switched to the secondary site, restore the primary site and re-establish the UR system from the secondary to the primary site.

Procedure

1. Restore the primary storage system and data paths.
2. Bring up the host servers at the primary site.
3. Make sure that all UR components are operational.
4. Do all of the following, as applicable:
 - a. At the primary site, locate P-VOLs whose status is COPY or PAIR. Locate corresponding S-VOLs at the secondary site whose status is SSWS, which indicates that data is being written to the S-VOLs. At the primary site, split these pairs.
 - b. At the primary site, locate P-VOLs whose status is other than unpaired. Locate corresponding S-VOLs at the secondary site whose status is unpaired. At the primary site, release the pairs.
 - c. At the primary site, locate pairs whose status is unpaired. At the secondary site, release the pairs.
5. On pairs that were split and in which S-VOL status is now SSWS, run the pairresync -swaps command. This reverses P-VOLs and S-VOLs and resynchronizes the pairs. The replication is from secondary site to original primary site.



Note: When you run the pairresync -swaps command, you can use the -d option to specify a data volume. However, the command is rejected if the restore journal where the data volume belongs is in Active, Halting, or Stopping status.

6. For S-VOLs whose status is unpaired, re-create the UR pairs specifying the S-VOLs as P-VOLs. This creates pairs in which P-VOLs and S-VOLs are reversed.
7. Verify that pair status of all new S-VOLs (which were originally P-VOLs) changes from COPY to PAIR. When the pair status is changed to PAIR, initial copy operations are finished and consistency is maintained.

Result

Data in the secondary site is now reflected on the primary site.

Resuming host operations at the primary site

When UR pairs are established in the reverse direction between the secondary and primary sites, you can return host operations to the original configuration. This means resuming host operations at the primary site and

reestablishing the original flow of data from primary to secondary storage systems. The following procedure explains how to resume normal operations at the primary site.

Procedure

1. At both sites, make sure that UR components are operational.
2. Make sure that pair status of all P-VOLs and S-VOLs in all UR pairs is PAIR.
3. Stop host applications at the secondary site.
4. Issue a request for splitting pairs to master journals (these were originally the restore journals on the secondary site); use the Flush option when splitting pairs. If an error occurs when splitting pairs, fix the error, resume host operations at the secondary site, and then go back to step 1.
5. If no errors occur, wait until suspension finishes. After suspension finishes, check for an S-VOL on the primary site whose status is not PSUS. If such a pair exists, fix the error and go back to step 1 after resuming your business task at the secondary site.
6. When all S-VOLs at the primary site are in PSUS status, data in P-VOLs and S-VOLs are the same. S-VOLs at the primary site are ready for host read/write activity. Resume applications at the primary site.
7. Run the `pairresync -swaps` command, which reverses P-VOLs and S-VOLs and resynchronizes the pairs. The replication is from the primary site to the secondary site (disaster recovery site).



Note: When you run the `pairresync -swaps` command, you can use the `-d` option to specify a data volume. However, the command is rejected if the restore journal where the data volume belongs is in Active, Halting or Stopping status.

Recovery for configurations with multiple primary systems and secondary systems

This topic provides recovery procedures for configurations with multiple primary systems and secondary systems.

Switching from the primary to secondary site (multiple storage systems)

If a disaster or a failure occurs in the primary site in a configuration with multiple primary and secondary systems, the operation continues at the secondary site, and data consistency within CCI CTG is maintained.

If a disaster or a failure occurs at the primary site, switch the operation from the primary site to the secondary site first.

Procedure

1. Switch the operation from the primary site to the secondary site.
2. From the secondary site, specify the swap option to split the pair (`pairsplit -RS`).
3. Check if the UR S-VOLs of all storage systems at the secondary site are in the SSWS status.
4. Resume the operation at the secondary site using the data volume in the SSWS status of storage systems at the secondary site.

Transferring operations back to the primary site (multiple storage systems)

After operations at the secondary site have resumed, if the other failures are corrected, operations at the primary site can be resumed.

Procedure

1. Make sure that the status of the UR secondary volumes of all secondary systems are SSWS.
2. In the secondary site, specify the swap option to resynchronize the pairs (`pairresync -swaps`).
3. Switch operation from the secondary site to the primary site.
4. In the primary site, execute the `horctakeover` command.

Recovery for 3DC configurations with three UR sites

This topic provides recovery procedures for 3DC configurations with three UR sites.

Recovery for 3 UR DC multi-target configuration (when the delta operation resync is performed)

In the event of a failure in the primary site, you can transfer production operations from the primary site to either one of the secondary sites. After the failure is corrected, you can transfer production operations back to the primary site.

Moving business operations to the secondary site

You keep business operations running in the event of a failure at the primary site by moving those operations to a secondary site.

Procedure

1. Run the `pairsplit -RS` command on the pair at the alternative secondary site.
2. Check the execution result of the `pairsplit -RS` command.

3. Perform the delta resync operation by running the `pairresync -swaps` command on the delta resync pair.
4. Check that the P-VOL of the pair for delta resync at the secondary site changes to the P-VOL of the pair at the primary site and that the status of the P-VOL for delta resync at the secondary site changes to PAIR. You can use the P-VOL at the alternative secondary site to resume business operations after confirming these changes.

Business operations are performed at the alternative secondary site, and remote copy is performed at the secondary site which is not the alternative site using the delta resync pair (with mirror ID P).

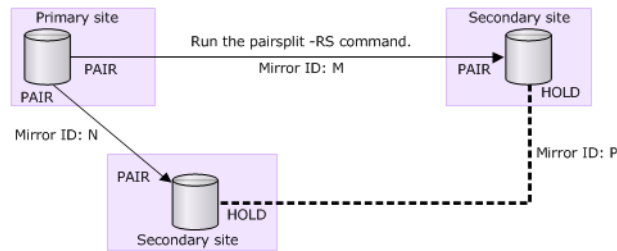

Run the `pairsplit -RS` command for the pair at the secondary site, and check the result.

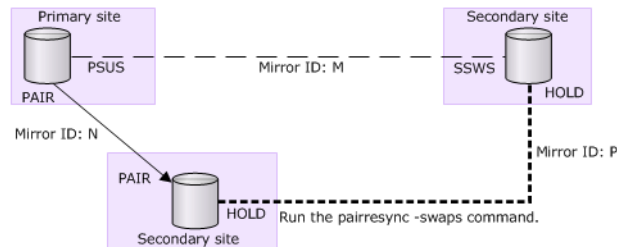

Run the `pairresync -swaps` command for the delta resync pair, and check the result.

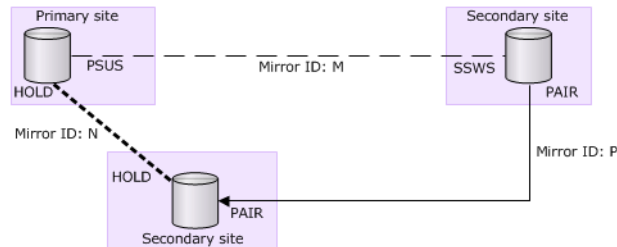

Check if the delta resync pair is a normal pair, and the pair status of each volume is PAIR.

Legend
 → : normal pair - - - : split pair - - - - : delta resync pair
 PAIR, PSUS, PSUE, HOLD, SSWS: pair status in each site (Status on CCI)

Moving business operations back to the primary site

You can return business operations from the secondary site back to the primary site after removing failures at the primary site and other sites.

Procedure

1. Stop business operations at the secondary site.

2. If the secondary site to be reversed and the primary site pair are suspended, resynchronize the pair (`pairresync -swaps`), and then reverse the pair's primary and secondary volumes.
3. Run the `pairsplit -RS` command for the pair between the secondary site to be reversed and the primary site.
4. Run the `pairresync -swaps` in the primary site, which reverses the primary and the secondary volumes to restore and resynchronize the pair.
5. Check the execution result of `pairresync -swaps` command.
6. Resume business operations at the primary site.

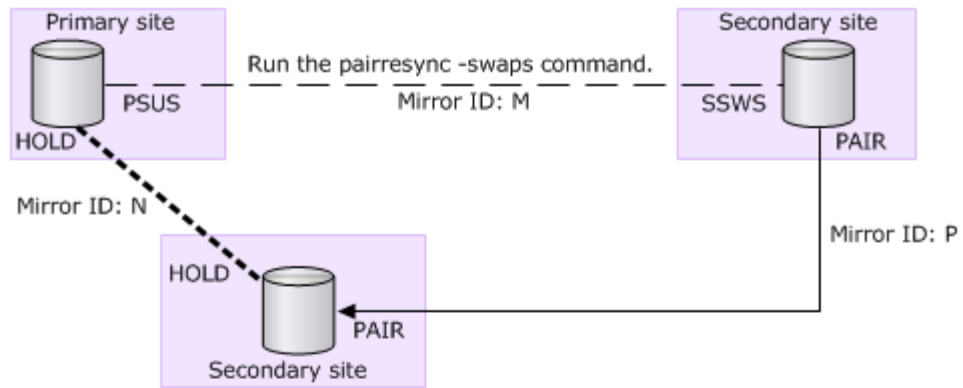

Run the pairresync -swaps command to replace the primary and secondary of the pair after stopping the operation at the alternative secondary site.

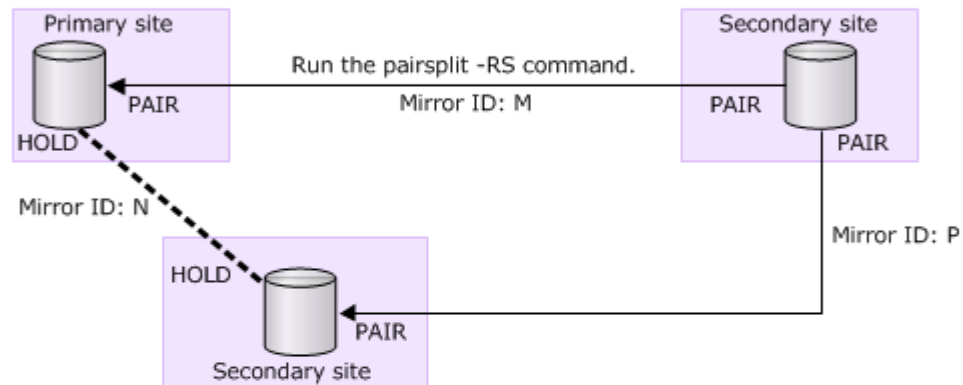

Run the pairsplit -RS command for the pair between the primary and alternative secondary sites.

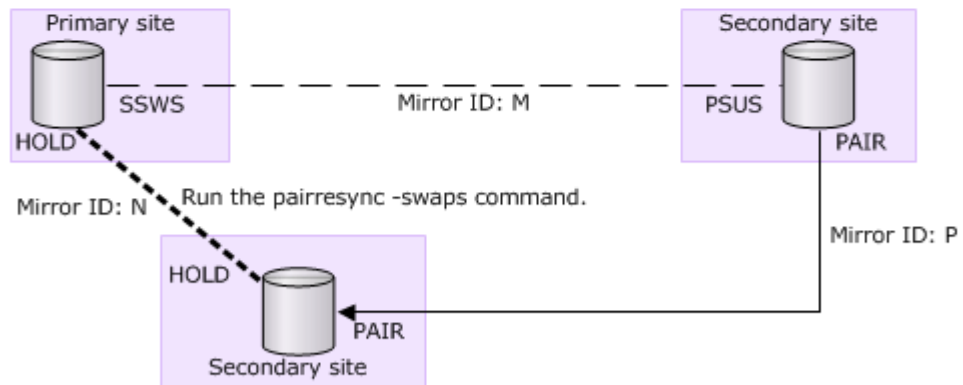

Run the pairresync -swaps command for the delta resync pair, and check the result.

Legend

→ : normal pair — — — : split pair - - - - - : delta resync pair

PAIR, PSUS, PSUE, HOLD, SSWS: pair status in each site (Status on CCI)

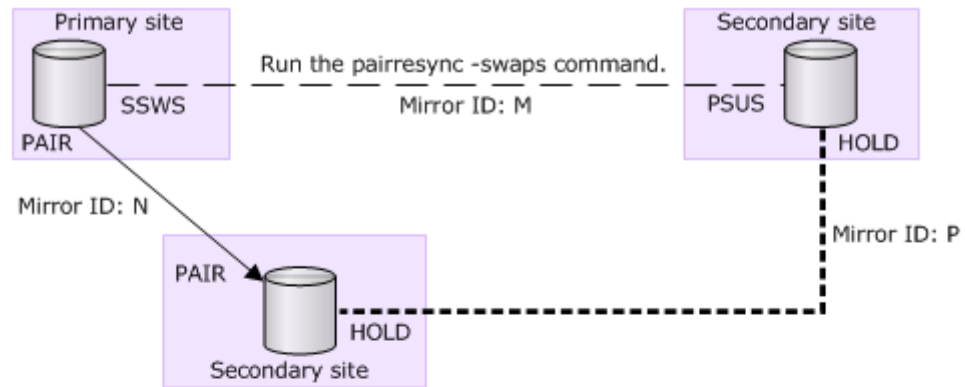

Run the pairresync -swaps command for the pair between the primary and secondary sites.

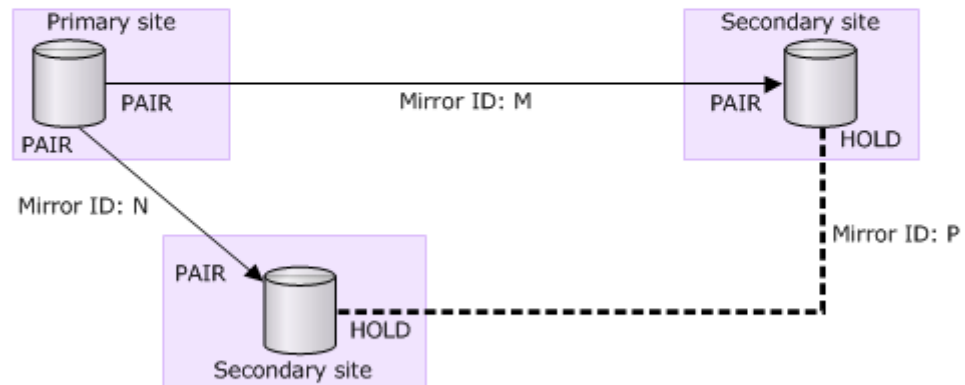

The system returns to the original multi-target configuration.

Legend
 → : normal pair - - - : split pair - - - - : delta resync pair
 PAIR, PSUS, PSUE, HOLD, SSWS: pair status in each site (Status on CCI)

Requirements for performing delta resync in 3DC multi-target configuration with three UR sites

Note: In a 3DC multi-target configuration with three UR sites, you can perform the delta resync operation only by using CCI. The delta resync operation cannot be performed by using Device Manager - Storage Navigator.

To perform the delta resync operation successfully, the following requirements must be met. If a regular UR pair that does not meet the requirements exists in the journal, even if the UR delta resync pair meets all the requirements, the delta resync pair will be suspended by error.

- There is a UR pair with a mirror ID that is different from the UR delta resync pair in the same journal in the secondary site specified for the delta resync operation (the pairs with mirror ID P and M in the figure in

[Recovery for 3 UR DC multi-target configuration \(when the delta operation resync is performed\) on page 242\).](#)

- There is a UR pair with mirror ID that is different from the UR delta resync pair in the same journal in the UR delta resync pair's secondary site (the pairs with mirror ID P and N in the figure in [Recovery for 3 UR DC multi-target configuration \(when the delta operation resync is performed\) on page 242\).](#)
- One of the two pairs is a UR delta resync pair (with the mirror ID P) in HOLD status, and the UR pair between the intermediate and secondary sites (with mirror ID N) is either PAIR, PSUS, or PSUE.
- All of the differential data of the P-VOL and S-VOL is stored in the master journal volume.
- The path for the UR delta resync pair between the primary and secondary sites is valid.
- In all three sites, remote command device is allocated to the two mirror IDs.

If even one of the above requirements is not met, an error or suspend by error occurs, and the delta resync operation will fail. If the delta resync fails, check the following status. Especially in the following case, delta resync will not be performed because the journal data necessary for the delta resync does not exist.

- After the UR pair between the primary site and the reversed intermediate site is split, the restore journal volume data of the UR delta resync pair in the unreversed secondary site exceeds 70% of the volume capacity as a result of updating the volume in the reversed secondary site.

If the specified UR delta resync pair status is not changed after performing the delta resync operation, the conditions for the delta resync operation described in this section might not be met. In this case, check the status of the UR pair and UR delta resync pair again, and verify whether all of the conditions for the delta resync operation are met. Then execute the delta resync again.



Note:

- When the UR delta resync pair is changed to HLDE, you cannot change it back to HOLD by pair resync. Delete the UR delta resync pair, and then create the UR pair again.
 - If a suspend by error occurred in the pair specified the delta resync right after performing the delta resync operation, check the pair status and perform the following operation:
 - For UR P-VOL, resync the UR pair that is in suspend by error.
 - For UR S-VOL, delete the UR pair that is in suspend by error, and then create the UR pair again.
-

Recovering from failures in a 3 UR DC cascade configuration

Disasters can occur at any point in a 3 UR DC cascade configuration that can affect business operations or production data backup. How you maintain business operations or data backup and recover from the failure, depends on where the disaster occurs.

Recovering when a failure occurs in the primary site

If a disaster occurs in the primary site, you can continue business operations by switching operations from the primary site to the secondary or intermediate site. Then, you can recover from the failure and return operations back to the primary site.

Procedure

1. Transfer host operations to the intermediate site.
 - a. Run the `horctakeover` command on the primary-intermediate site pair.
 - b. Check the execution result.
 - c. Start host operations to the volume when the S-VOL status changes to an SSWS status or changes to a P-VOL status.

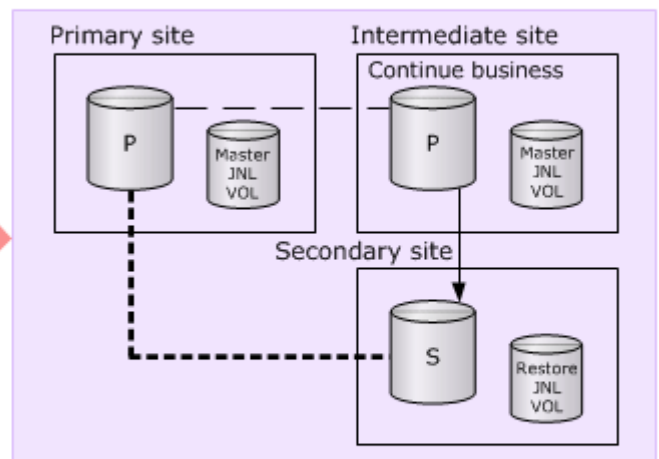
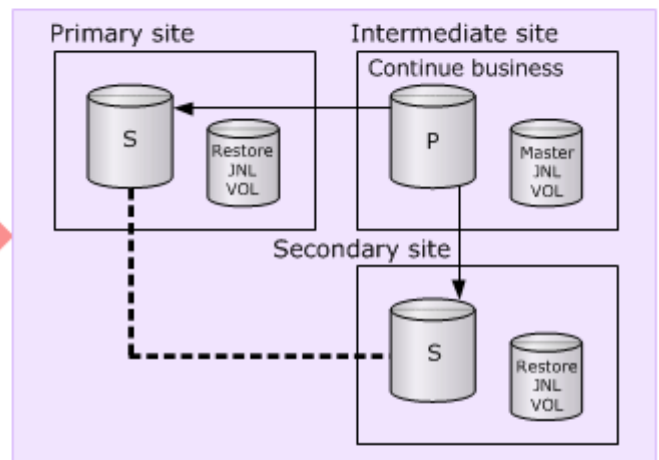
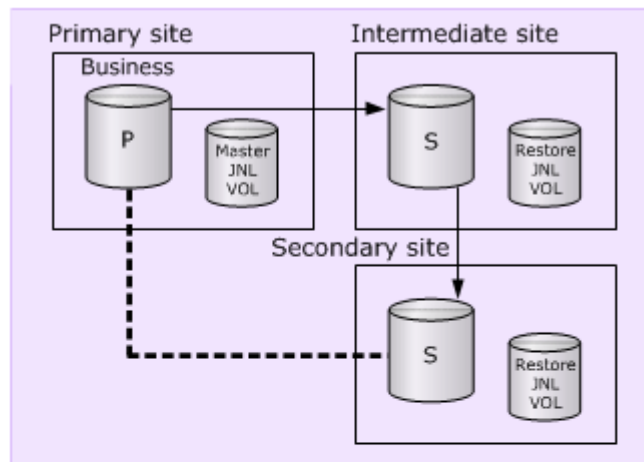

Legend
 → : PAIR copying direction - - - : SSWS - - - - : HOLD
 P: primary volume S: secondary volume
 JNL VOL: journal volume

2. Remove the failure or failures from the primary site.

3. Transfer business operations back to the primary site (when the delta resync operation is performed).
 - a. Stop business tasks at the intermediate site.
 - b. If the primary-intermediate site pair is suspended, run the `horctakeover` command on the primary-intermediate site pair. The intermediate-secondary site pair is automatically suspended.
 - c. Resume business operations using the primary volume in the primary site.
 - d. Resynchronize the intermediate-secondary site pair.

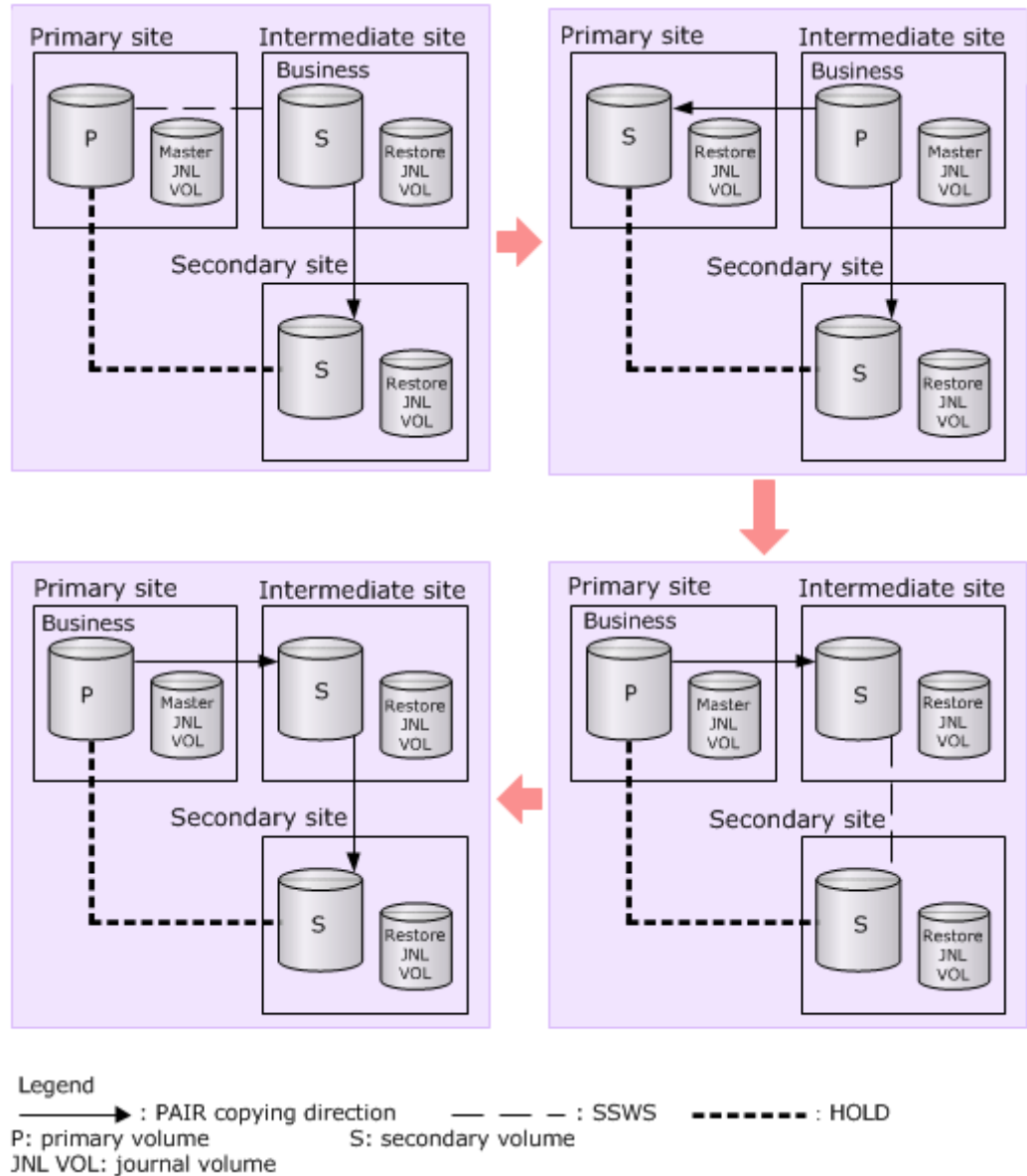

Recovering when a failure occurs in the intermediate site

If a disaster occurs in the intermediate site, you can redirect production data backup to the secondary site. Then, you can recover from the failure and re-create the cascade configuration.

Procedure

1. Perform the delta resync operation between the primary site P-VOL and the secondary site S-VOL to redirect the production data backup.

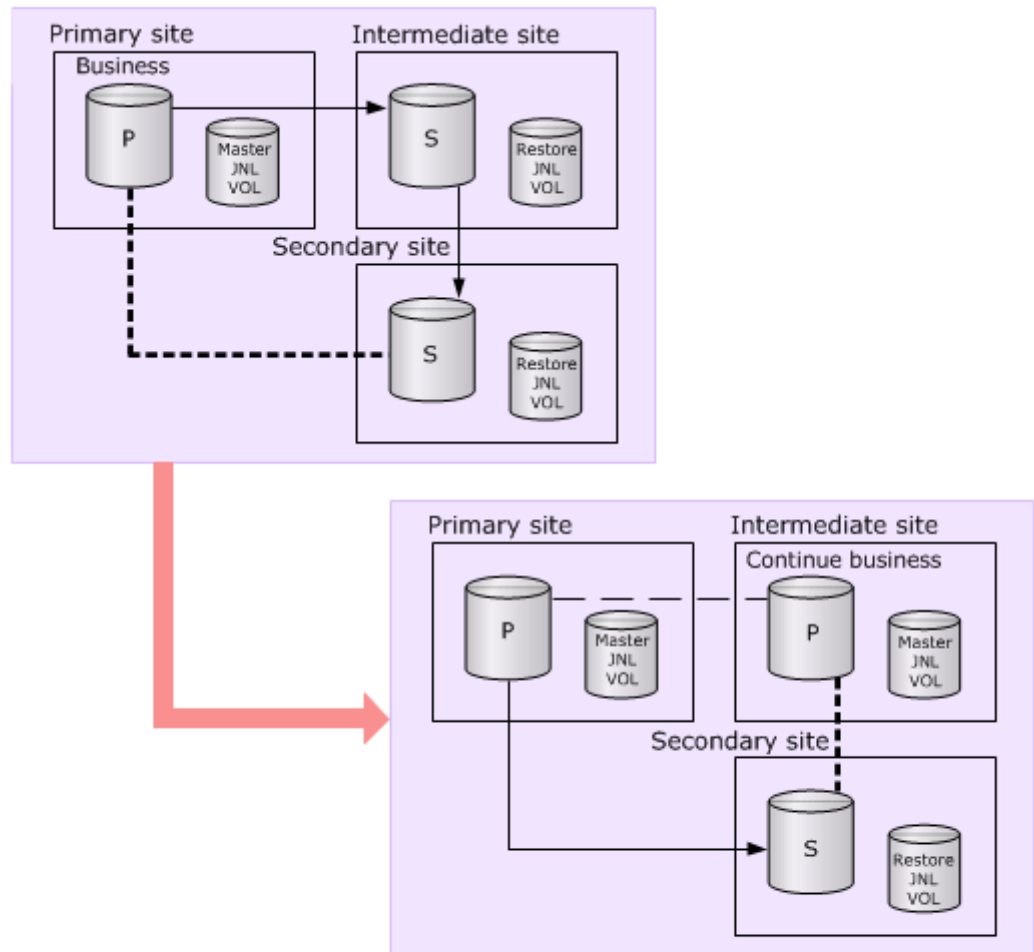

Legend
 → : PAIR copying direction — — — : SSWS - - - - : HOLD
 P: primary volume S: secondary volume
 JNL VOL: journal volume

2. Remove the failure or failures from the intermediate site.
3. Restore the intermediate site and cascade configuration (when the delta resync operation is performed).
 - a. If the primary-intermediate site pair is suspended, run the **horctakeover** command to resynchronize the pair.
 After the resynchronization, the primary volume and secondary volume of the pair are reversed. The intermediate-secondary site pair is suspended automatically.

- b. Delete the primary-secondary site delta resync pair.
As a result, the intermediate-secondary site pair is also deleted.
- c. Create a pair between the intermediate and secondary sites, specifying `Entire` for `Initial Copy`.
- d. Create a delta resync pair between the primary and secondary sites.

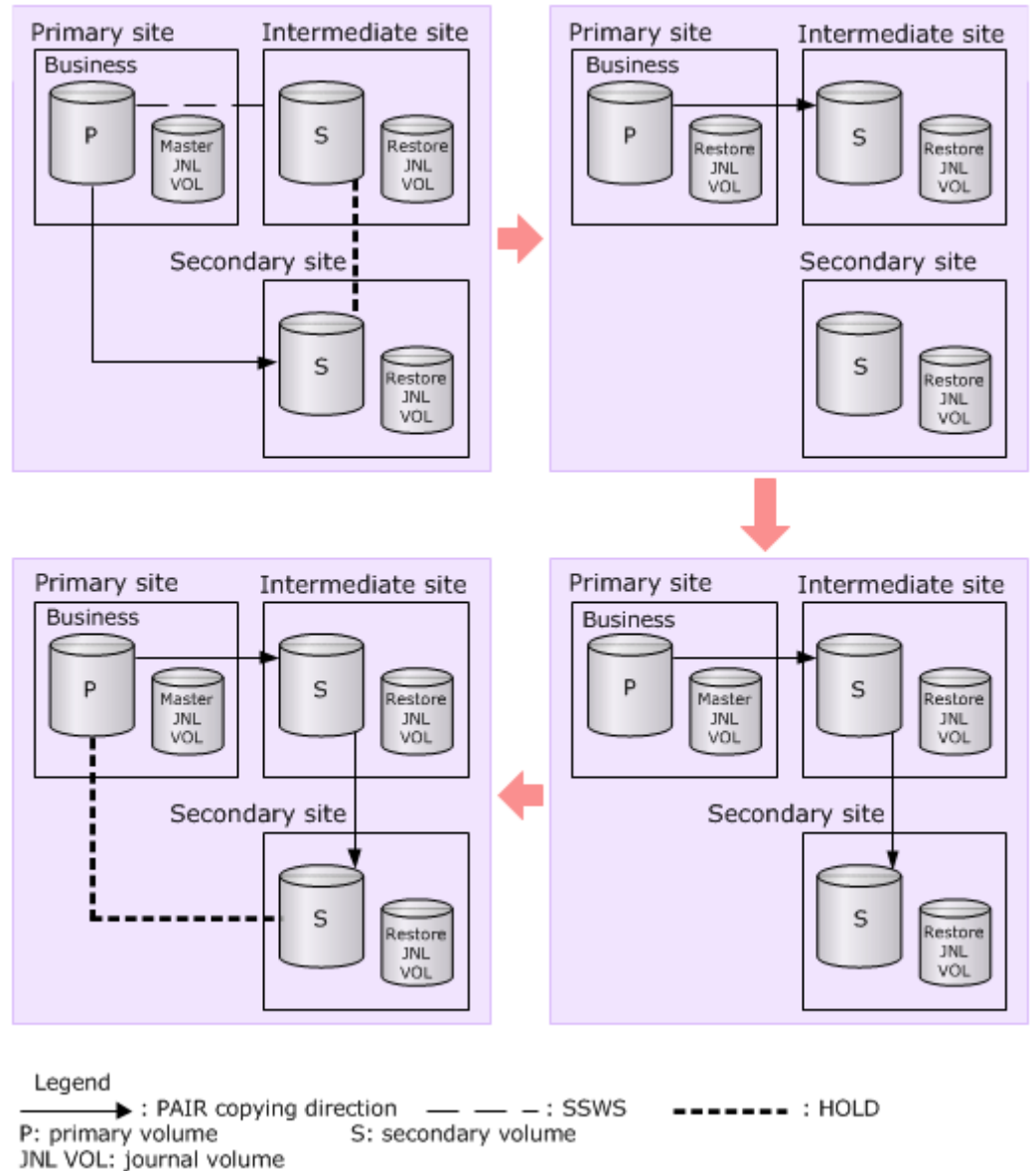

Recovering when a failure occurs in the primary-intermediate path

If the data path between the primary and intermediate sites fails, the status of journals in these sites might change to Stopping (with pair status changed to Suspending). You can recover by either resynchronizing the primary and

intermediate sites or by performing a delta resync between primary-secondary sites.

Resynchronizing journals between the primary and secondary sites

You can recover from a primary-intermediate path failure by resynchronizing journals between the primary and secondary sites.

Procedure

1. Run the delta resync operation on the delta resync pair set up between the primary and secondary sites.
This changes the journal status between the primary and intermediate sites.

Resynchronizing journals in the primary and intermediate sites

You can recover from a primary-intermediate path failure by resynchronizing journals in the primary and intermediate sites.

Procedure

1. Delete the delta resync pair between the primary and secondary sites.
2. Confirm that the status of the journal between the primary and intermediate sites is changed to Stop.
3. Correct the reason for the data path failure.
4. Resync the pair between the primary and intermediate sites.

Recovering when a failure occurs in the secondary site

If the secondary site fails, business operations are not affected because the primary and intermediate sites are still operating; therefore, recovering from a secondary site failure simply re-creates the cascade pairs.

Procedure

1. Remove the failure or failures from the secondary site.
2. Set up the cascade pairs again.

Related concepts

- [Workflow for 3DC cascade configuration with three UR sites](#) on page 115

Recovery for 3DC cascade configuration with three UR sites

Recovering from a primary site failure

When a failure or disaster occurs in the primary site, business tasks are transferred from the primary site to the intermediate site. After you correct the failure in the primary site, you can transfer the business tasks back to the primary site.

Procedure

1. Stop host operations at the intermediate site.

2. If the UR pair between the primary and intermediate sites are in suspend status, resync the pair by running the CCI `horctakeover` command. After the resync, UR the P-VOL and S-VOL are switched. The UR pair between the intermediate and secondary sites are suspended automatically.
3. Resume host operations by using the P-VOL in the primary site.
4. Resync the UR pair between the intermediate and secondary sites.

Recovering from an intermediate site failure for a 3DC cascade configuration with three UR sites

When a failure or disaster occurs in the intermediate site, data is duplicated by connecting the primary and secondary sites. After you correct the failure in the intermediate site, you can change back to the original cascade configuration.

Procedure

1. If the UR pair between the primary and intermediate sites is suspended, resync the pair.
2. Delete the pair between the primary and secondary sites. The UR delta resync pair between the intermediate and secondary sites will be deleted automatically.
3. Create a UR pair between the intermediate and secondary sites. Specify **Entire** when performing the initial copy operation.
4. To create the delta resync configuration, create a UR delta resync pair between the primary and the secondary sites.

Requirements for performing delta resync in 3DC cascade configuration with three UR sites

To perform delta resync operation successfully, the following requirements must be met. Note that the suspended by error will occur if a regular UR pair which does not meet the conditions exists in the journal, even if the UR delta resync pair meets all the requirements.

- There is a UR pair which has a different mirror ID than the UR delta resync pair in the same journal in the primary site (pairs with the mirror ID P and M shown in [3DC cascade configuration with three UR sites on page 41](#)).
- There is a UR pair which has a mirror ID different than the UR delta resync pair in the same journal in the UR delta resync pair's secondary site (pairs with the mirror ID P and N shown in [3DC cascade configuration with three UR sites on page 41](#)).
- Out of two pairs, one is UR delta resync pair (with the mirror ID P) and in HOLD status, and the other is the UR pair connecting the primary and intermediate sites and in PAIR or PSUE status.
- Out of two pairs, one is UR delta resync pair (with the mirror ID P) and in HOLD status, and the other is the UR pair connecting the intermediate and secondary sites (with the mirror ID P) and in PAIR, PSUS, or PSUE status.

- P-VOL and S-VOL's entire differential data is stored in the master journal volume.
- The path between the primary and secondary sites of the UR delta resync pair is valid.
- Remote command devices are allocated to the two mirror IDs in all the three sites.

If even one of the above requirements is not met, an error occurs and the delta resync operation will fail. Especially in the following cases, delta resync will not be performed because the journal data necessary for the delta resync does not exist.

- After the UR pair between the intermediate site and secondary site is split, the journal volume data of the UR pair between the primary and intermediate sites in the secondary site exceeds 70% of the volume capacity.
- After updating the UR delta resync P-VOL, the journal volume data of the UR delta resync pair in the primary site exceeds 70% of the volume capacity.

Setting options can prevent the error from occurring in the delta resync operations with the cascade configuration with three UR sites, by copying the entire P-VOL data to the S-VOL when entire differential data of the P-VOL and S-VOL is not stored in the master journal. For setting the UR delta resync operation options for the UR delta resync pairs, see [Changing options used by journals on page 211](#).

If the specified UR delta resync pair status is not changed after performing the delta resync operation, the conditions for the delta resync operation described in this section might not be met. In this case, check the status of the UR pair and UR delta resync pair again and verify whether all of the conditions for the delta resync operation are met. Then execute the delta resync again.



Note: When the S-VOL of the UR delta resync pair is changed to HLDE, you cannot change it back to HOLD by pair resync. Delete the UR delta resync pair, and then create the UR pair again.

Recovery for 3DC UR/TC

Recovery procedures when UR P-VOLs and S-VOLs are shared with TrueCopy can be more complex than general procedures. The following topics provide recovery procedures for resuming host operations at a backup site and then restoring the original system and configurations.

- [Recovery for 3DC UR/TC cascade configuration on page 256](#)
- [Recovery for 3DC UR/TC multi-target configuration on page 256](#)
- [Recovery in a delta resync configuration on page 259](#)

For open systems, perform all procedures using CCI.

Recovery for 3DC UR/TC cascade configuration

Host operations are transferred to the TC secondary volume (S-VOL) at the intermediate site when a disaster or failure occurs in the primary site of a 3DC cascade configuration. The primary site failure is corrected and brought back online, and then either the cascade configuration is restored or the multi-target configuration is created.

See [3DC cascade configuration on page 323](#) for information and illustrations on the configuration covered in this procedure.

Use the following procedure to recover a 3DC cascade configuration failure.

Procedure

1. Check consistency of the secondary volume at the intermediate site.
2. Run the horctakeover command on the secondary volume.
3. Wait until the secondary volume in the intermediate site is suspended (in SSWS status) or changes to a primary volume, and then use the volume to resume host operations.

Recovery for 3DC UR/TC multi-target configuration

The recovery procedure you perform in a 3DC multi-target configuration depends on the location of the failure:

- For failure in the primary site only, see [Recovering from primary site failure on page 256](#).
- For failure in the primary and TrueCopy secondary sites, see [Recovering from primary and secondary site failure \(3DC multi-target\) on page 258](#)

See [3DC multi-target configuration on page 325](#) for information and illustrations on the configuration covered in this procedure.

Recovering from primary site failure

Host operations are transferred to the secondary volume in the TC secondary site when disaster or failure occurs in the primary site in a 3DC multi-target configuration. The replication direction changes so that data flows from the TC secondary site to the primary site. Alternatively, a temporary UR system can be set up. Meanwhile, you correct the failure at the primary site and then transfer host operations back to it and return to a 3DC configuration.

Use the following procedure to recover a primary site failure.

Procedure

1. Release the UR pair.
2. Run the horctakeover command on the TC pair.

3. Start host operations to the TC secondary site S-VOL.

Result

Running the horctakeover results in one of the following conditions:

- The original copy flow of the TC pair reverses and flows from S-VOL to P-VOL.
- The original copy flow does not reverse because of failure in the primary site or data path.

Depending on the result, proceed as follows:

If the original TC data flow reverses

1. Re-create the UR pair from the TC primary site to the UR secondary site. This results in a 3DC cascade configuration, with the original TC S-VOL as the primary volume. See the lower right configuration in the following figure.
2. Begin recovery of the original configuration by restoring the primary site or data path, or both. This must be done before proceeding.
3. Stop host operations to the TC secondary site.
4. Run the horctakeover command on the TC pair.
5. Resume host operations to the TC P-VOL in the primary site.

If the original TC data flow did not reverse

1. To back up the data, create a new UR pair from the TC secondary site S-VOL to the UR secondary site S-VOL. See the upper-right configuration in the following figure.
2. Begin recovery of the original configuration by restoring the primary site or data path, or both. This must be done before proceeding.
3. Release the UR pair.
4. Resynchronize the TC pair to start the replication to the primary site.
5. Release the current UR pair, which extends between the TC secondary site and the UR secondary site.
6. Stop host operations at the TC secondary site.
7. Run the horctakeover command on the TC pair.
8. Resume host operations at the primary site TC volume.

- Re-create the UR pair from the primary site to the secondary site. The system is now changed back to the original 3DC multi-target configuration.

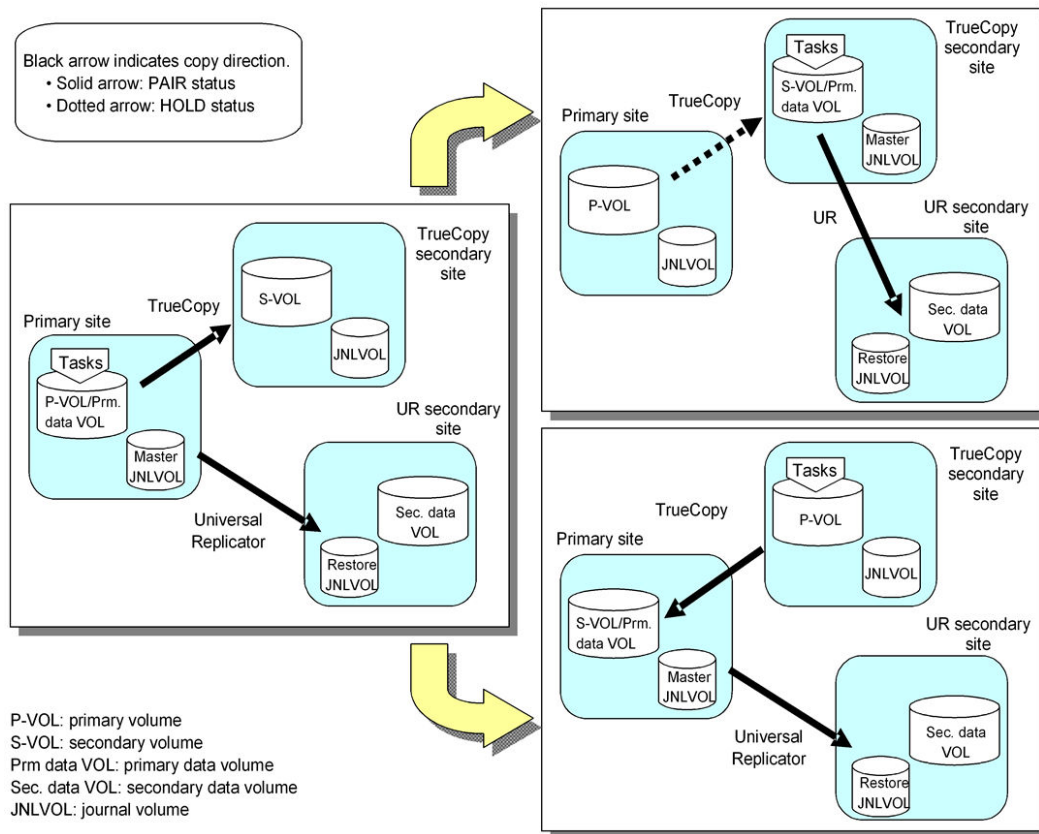

Recovering from primary and secondary site failure (3DC multi-target)

Host operations are transferred to the Universal Replicator secondary site S-VOL when a disaster or failure occurs in both the primary and TC secondary sites in a 3DC multi-target configuration. Failures are corrected at the two sites, and then host operations are transferred back to the primary site.

Use the following procedure to recover a primary and TC secondary site failure.

Procedure

- Run the horctakeover command on the UR pair.
- Resume host operations at the UR secondary site.
- Release the TC pair.
- Make sure the UR pair is resynchronized so that the copy flow is from S-VOL to P-VOL.

5. Stop host operations at the UR secondary site.
6. Run the horctakeover command on the UR pair.
7. Resume host operations at the primary site.
8. Make sure the copy flow of the UR pair is from P-VOL to S-VOL. If it is not, resynchronize the pair.
9. Re-create the TC pair.

Result

The system is now changed back to the original 3DC multi-target configuration.

Recovery in a delta resync configuration

Host operations are transferred to the TrueCopy secondary site S-VOL when a disaster or failure occurs in the primary site in a delta resync configuration. Then you run the delta resync operation. When the failure at the primary site is corrected, host operations are transferred back to the primary site and the delta resync configuration is reestablished.

Before you begin

- For information and illustrations on the configuration covered in this procedure, see [Delta resync configuration on page 327](#).
- You can specify options for recovery in the event that the delta resync operation fails. See the Delta Resync Failure step in [Changing options used by mirrors on page 213](#). This also provides important information if you share the delta resync S-VOL with ShadowImage, Thin Image, or a DP-VOL.

Procedure

1. Run the horctakeover command on the TC pair.
2. Start host operations to the TC secondary site S-VOL.
3. Perform the delta resync operation on the TC secondary site S-VOL. See [Performing the delta resync operation on page 338](#). Note that pair status must be HOLD before the operation. When the operation completes, pair status is PAIR or COPY.



Note: Pair status also changes for the original UR pair in the primary and UR secondary sites, from PAIR or COPY to HOLD.

However, the status of the original pair may not change to the required state after the delta resync operation. If this occurs, host operations cannot be resumed in the primary site. See [Problems with pair status during delta resync recovery on page 260](#) and make the necessary corrections.

4. Resolve the problem at the primary site. This must be done before proceeding.
5. If the TC pair is suspended, resynchronize the pair and reverse the copy flow.
6. Stop host operations to the TC secondary site.
7. Run the horctakeover command on the TC pair.
8. Resume host operations to the TC P-VOL in the primary site.
9. Perform the delta resync operation on the volume in the TC primary site. Pair status must be HOLD. When the operation completes, pair status is PAIR or COPY.

Also, pair status changes for the delta resync UR pair from the TC secondary to the UR secondary site, from PAIR, PSUS, or PSUE to HOLD.

Result

The system becomes a delta resync configuration again.

Problems with pair status during delta resync recovery

After performing the delta resync, it is necessary for the original UR pair from primary to UR secondary site to be in HOLD status, in order to resume operations at the primary site. However, the pair may not be in this status.

If pair status is not HOLD, match the pair's actual statuses in the following table, and then perform the corrective action.

Current status	Corrective action
Primary site: PAIR or COPY UR secondary site: HOLD	<ol style="list-style-type: none"> 1. Make sure that the status of the pair in the primary site is PSUE or PSUS. 2. Release the UR pair from the primary site. 3. Make sure that all the pairs belonging to the journal in the primary site are released. 4. Create a UR delta resync pair that extends from the primary site to the UR secondary site.
Primary site: PSUE or PSUS UR secondary site: HOLD	<ol style="list-style-type: none"> 1. Release the UR pair from the primary site. 2. Make sure that all the pairs belonging to the journal in the primary site are released. 3. Create a UR delta resync pair that extends from the primary site to the UR secondary site.
Primary site: HLDE UR secondary site: HOLD	Change the status of the HLDE pair back to HOLD using pairresync.
Primary site: SMPL UR secondary site: HOLD	<ol style="list-style-type: none"> 1. Release the pair in HOLD status from the UR secondary site. 2. Create a UR delta resync pair that extends from the primary site to the UR secondary site.

Recovery for UR/SI configurations

See [Configurations with SI secondary volumes on page 345](#) for information and illustrations on the configuration covered in this procedure.

You resume host operations to the Universal Replicator secondary volume if a disaster or failure occurs at the primary site where the UR P-VOL is shared with a ShadowImage (SI) secondary volume. Then you recover the primary site and then resume host operations.

Use the following procedure to recover a UR P-VOL/SI S-VOL configuration.

Procedure

1. Release the SI pair using the pairsplit -S command.
2. Reverse the copy direction and resync the UR pair using the horctakeover command.
3. Reverse the copy direction again on the UR pair using the horctakeover command.
4. Delete the UR pair using the pairsplit -S command.
5. Create an SI pair from the SI S-VOL to perform copying in the reverse direction. Use the paircreate command.
6. Release the SI pair using the pairsplit -S command.
7. Re-create the original SI pair from the original SI P-VOL to perform copying in the original direction. Use the paircreate command.
8. Split the SI pair using the pairsplit -r command.
9. Re-create the UR pair using the paircreate command.

Result

The system becomes the original configuration again.

Recovery from a failure at the primary site and TC secondary site

When a disaster or failure occurs both at the primary site and TC secondary site in the 3DC multi-target configuration, you can resume business by using the S-VOLs at the UR secondary site.

After transferring business tasks back to the UR secondary site, correct the failure at the primary site and TC secondary site so that business tasks can be transferred back to the primary site.

Switching from the primary to secondary site (TC secondary site)

If a disaster or failure occurs both at the primary site and TC secondary site in the 3DC multi-target configuration, resume business by using the S-VOLs at the UR secondary site.

Procedure

1. Run the CCI `horctakeover` command to the UR pairs.
2. Resume business operations by using the volumes at the UR secondary site.

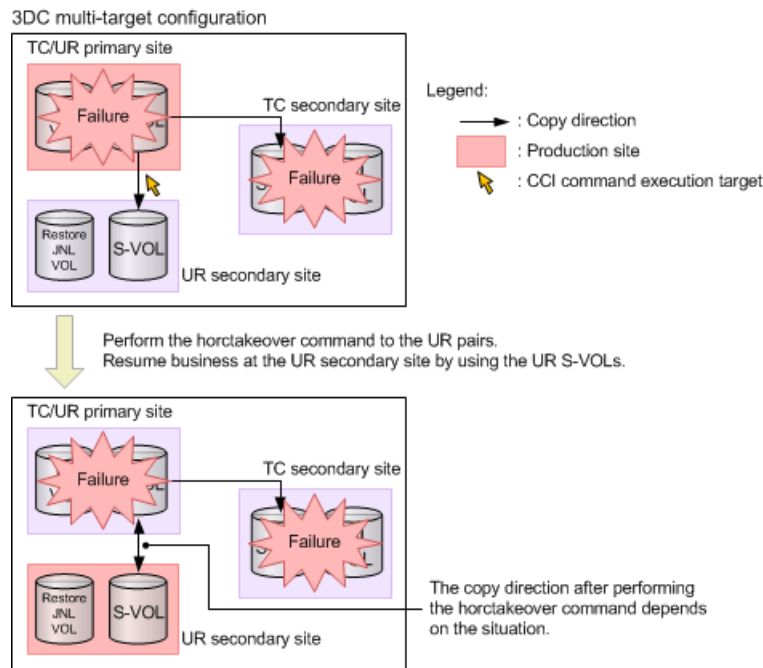

Transferring operations back to the primary site (TC secondary site)

After operations at the secondary site have resumed, if the other failures are corrected, operations at the primary site can be resumed.

Procedure

1. Split the TC pairs by using the CCI `pairsplit` command.
2. If the pair resync to switch the UR P-VOLs and the S-VOLs is not performed (UR pairs are split by failure), resync the pairs by using the CCI `pairresync` command and switch the P-VOLs and the S-VOLs.
The original S-VOLs at the UR secondary site become the P-VOLs, and the original P-VOLs at the primary site become the S-VOLs.
3. Stop the business process at the UR secondary site.
4. Run the CCI `horctakeover` command to the UR pairs.

The UR P-VOLs and the S-VOLs will be switched.

5. Resume business operations at the primary site by using the P-VOLs at the primary site.
 6. Resync the TC pairs by using the CCI `pairresync` command.
- The system configuration returns back to the 3DC multi-target.

Business is resumed at the UR secondary site by using the UR S-VOLs.

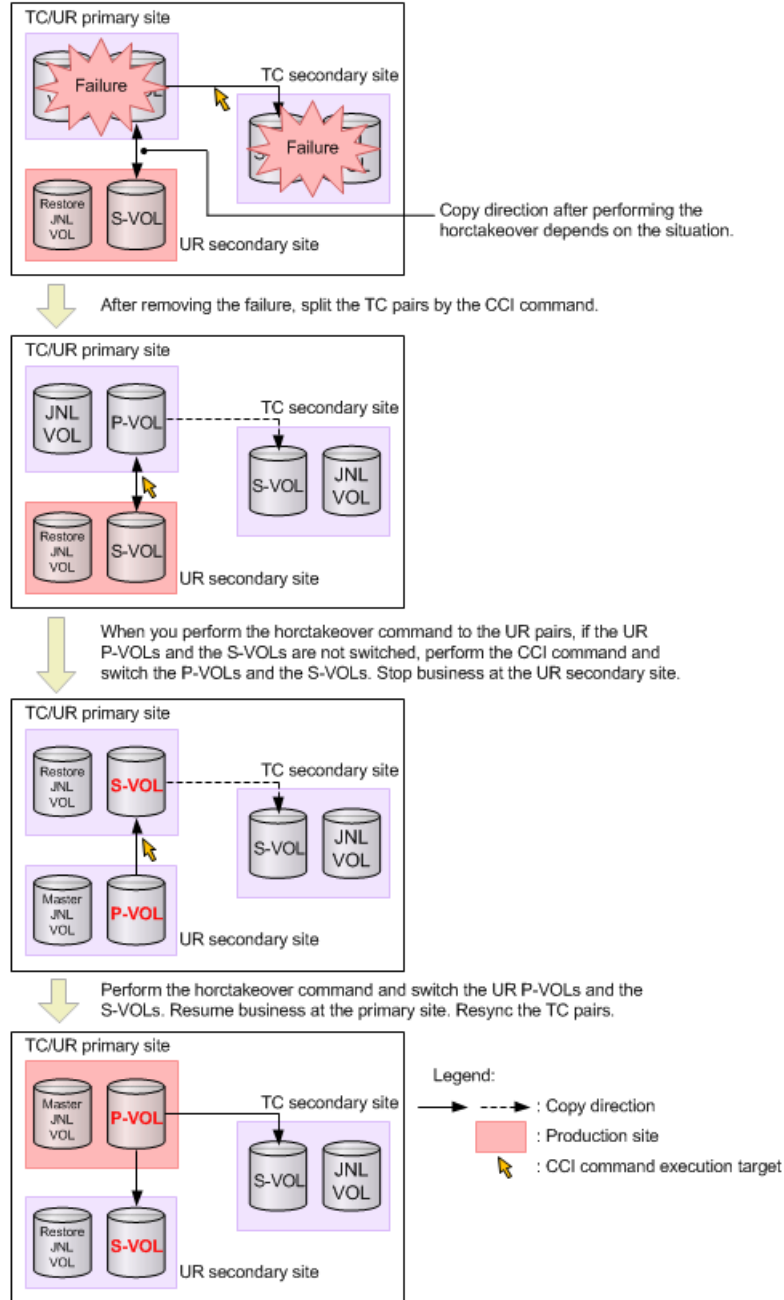

Recovery for UR/GAD configurations

If a failure occurs in a UR/GAD configuration, the recovery procedure varies depending on the location of the failure. For details, see the *Global-Active Device User Guide*.

Disaster recovery in a GAD 3DC delta resync environment

This chapter provides information and instructions specifically for disaster recovery operations in a GAD 3DC delta resync (GAD+UR) environment.

For details about storage system support (models, microcode) for GAD+UR operations, see the *Global-Active Device User Guide*.

- [Status before failure](#)
- [Recovering from primary site and P-VOL failures \(GAD+UR\)](#)
- [Recovering from secondary site and S-VOL failures \(GAD+UR\)](#)
- [Recovering from a failure at the primary and secondary sites \(GAD+UR\)](#)
- [Recovering from a failure on the UR delta resync pair](#)
- [Recovering from a quorum disk failure \(GAD+UR\)](#)

Status before failure

The following figure shows the status in a GAD 3DC delta resync (GAD+UR) environment before a failure occurs. The data is copied from the GAD P-VOL to the UR S-VOL.

Disaster recovery procedures for GAD+UR failure conditions:

- [Recovering from primary site and P-VOL failures \(GAD+UR\) on page 266](#)
- [Recovering from secondary site and S-VOL failures \(GAD+UR\) on page 273](#)
- [Recovering from a failure at the primary and secondary sites \(GAD+UR\) on page 278](#)
- [Recovering from a failure on the UR delta resync pair on page 281](#)
- [Recovering from a quorum disk failure \(GAD+UR\) on page 282](#)

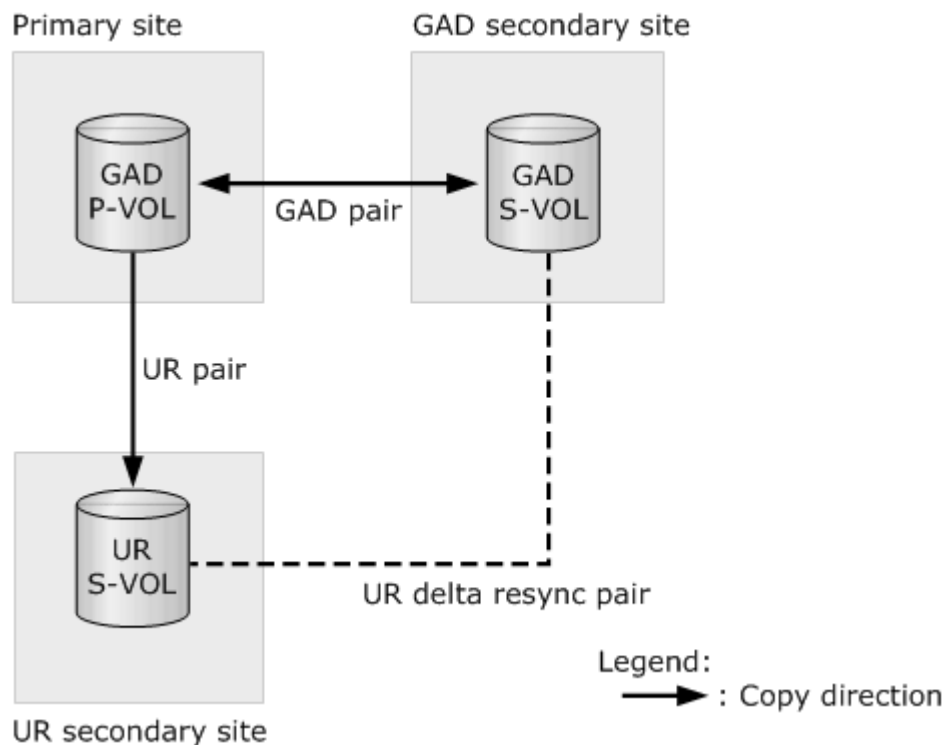

Recovering from primary site and P-VOL failures (GAD+UR)

This section describes the procedures for recovering from a primary site failure or a P-VOL failure (LDEV blockade) at the primary site using examples.

Recovering from a primary site failure (GAD+UR)

This subsection describes how to recover from a primary site failure. The example explains the case when a failure occurs in a storage system at the primary site.

When a failure occurs at a primary site, the status of the GAD pair changes to PSUE/SSWS. In this case, delta resync is automatically performed, and the pair statuses change as follows:

Before failure			After failure		
Pair type	Pair status		Pair type	Pair status	
	P-VOL	S-VOL		P-VOL	S-VOL
GAD pair	PAIR	PAIR	GAD pair	PSUE ¹	SSWS
UR pair	PAIR	PAIR	UR pair	PSUE ^{1, 2}	-
			UR delta resync pair	-	SSUS
UR delta resync pair	PSUS	SSUS	UR pair	From COPY to PAIR	From COPY to PAIR
Notes:					
1. Pair status after the primary site is turned on.					
2. PSUE status of the UR pair. The UR pair does not change to a UR delta resync pair.					

If a failure occurs, the UR delta resync pair changes to a UR pair, and copying from the GAD S-VOL to the UR S-VOL starts. When the UR pair copying is completed, the status of the P-VOL and the status of the S-VOL of the UR pair change to PAIR.

Overview of failure recovery

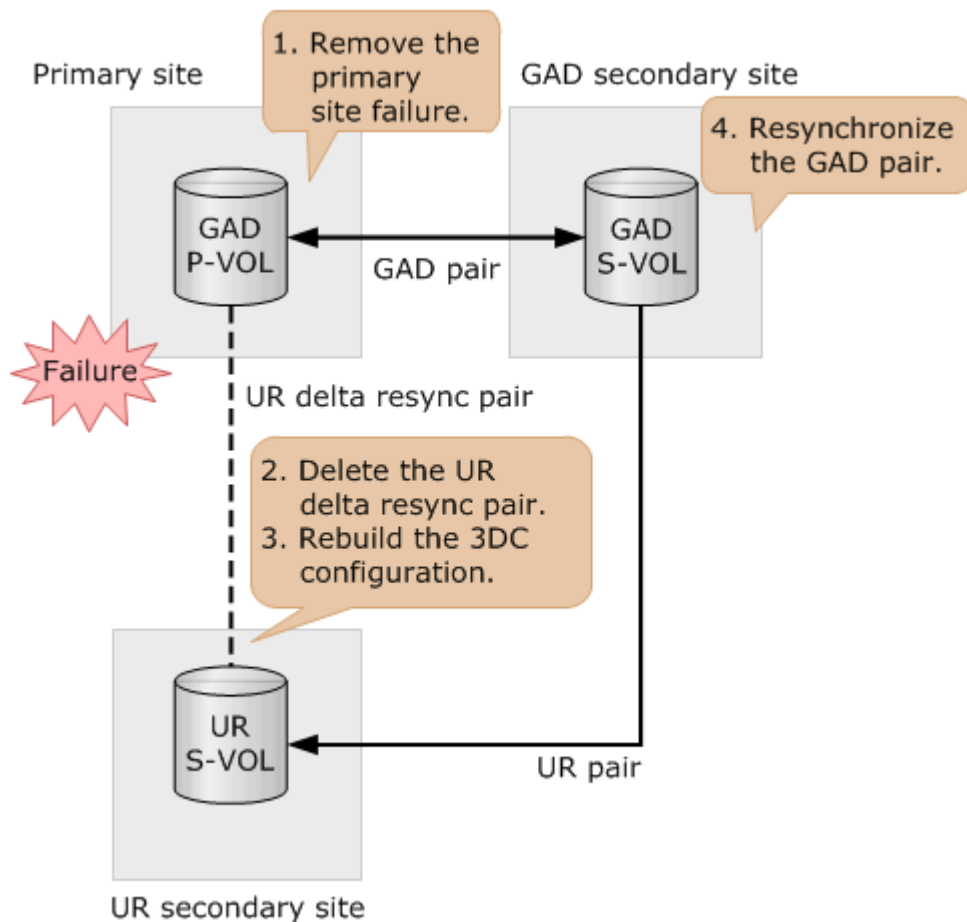

Procedure

1. Remove the failure on the P-VOL.
2. At the primary site for the UR delta resync pair, delete the UR delta resync pair.

Command example:

```
pairsplit -g oraREMOTE -S -IH0
```

3. At the primary site for the UR delta resync pair, create a UR delta resync pair to reconfigure a 3DC delta resync configuration.

Command example:

```
paircreate -g oraREMOTE -f async -vl -nocsus -jp 0 -js 0 -IH0
```

4. Reverse the P-VOL and the S-VOL, and then resynchronize the GAD pairs (swap resync) on the storage system at the GAD secondary site.

Command example:

```
pairresync -g oraHA -swaps -IH1
```

The volume on the primary storage system changes to an S-VOL, and the volume on the GAD secondary storage system changes to a P-VOL.

5. Confirm that the GAD P-VOL and S-VOL pair statuses change to PAIR.

Command example:

```
pairdisplay -g oraHA -fxce -IH0
```

```
Group PairVol(L/R) (Port#,TID, LU),Seq#,LDEV#.P/  
S,Status,Fence, %,P-LDEV# M CTG JID AP EM E-Seq# E-LDEV# R/W
```

```
oraHA dev1(L) (CL1-A-0, 0, 0)311111 2222.P-VOL PAIRNEVER ,  
100 4444 - - 0 - - - - L/M
```

```
oraHA dev1(R) (CL1-C-1, 0, 0)322222 4444.S-VOL PAIRNEVER ,  
100 2222 - - 0 - - - - L/M
```

```
pairdisplay -g oraHA -fxce -IH1
```

```
Group PairVol(L/R) (Port#,TID, LU),Seq#,LDEV#.P/  
S,Status,Fence, %,P-LDEV# M CTG JID AP EM E-Seq# E-LDEV# R/W
```

```
oraHA dev1(L) (CL1-C-1, 0, 0)322222 4444.S-VOL PAIRNEVER ,  
100 2222 - - 0 - - - - L/M
```

```
oraHA dev1(R) (CL1-A-0, 0, 0)311111 2222.P-VOL PAIRNEVER ,  
100 4444 - - 0 - - - - L/M
```

6. Keep updating I/O from the server to the P-VOL or S-VOL of the GAD pair for about two minutes.
7. Confirm that the delta UR P-VOL pair status is PSUS.

Command example:

```
pairdisplay -g oraREMOTE -fxce -IH0
```

```
Group PairVol(L/R) (Port#,TID, LU),Seq#, LDEV#.P/  
S,Status,Fence, %, P-LDEV# M CTG JID AP EM E-Seq# E-LDEV# R/W
```

```
oraDELTA dev2(L) (CL1-A-1, 0, 1) 311111 2222. P-VOLPSUS  
ASYNC ,0 6666 - 0 0 - - - - -/-
```

```
oraDELTA dev2(R) (CL1-A-1, 0, 1) 344444 6666. S-VOLSSUS  
ASYNC ,0 2222 - 0 0 - - - - -/-
```



Note: To check the status of a pair in Device Manager - Storage Navigator, select **Refresh All** in the **File** menu to update the information displayed on Device Manager - Storage Navigator, and then view the pair status. The status of the UR delta resync pairs changes from HOLDING to HOLD.

- Confirm that the mirror status of the journal of the UR delta resync pair is PJNS.

Command example:

```
pairdisplay -g oraREMOTE -v jnl -IH0
```

```
JID MU CTG JNLS AP U(%) Q-Marker Q-CNT D-SZ(BLK) Seq#Num
LDEV#
```

```
000 1 1 PJNS 4 21 43216fde 30 512345 625001 39321
```

- Confirm that no failure SIMs are displayed.
- Reverse the GAD P-VOL and the S-VOL if necessary. For instructions, see [Reversing the GAD P-VOL and S-VOL \(GAD+UR\) on page 272](#).

Recovering from a P-VOL failure (LDEV blockade) at the primary site (GAD+UR)

When a failure (LDEV blockade) occurs on a P-VOL at the primary site, the status of the GAD pair changes to PSUE/SSWS. In this case, delta resync is automatically performed, and the pair statuses change as follows:

Before failure			After failure		
Pair type	Pair status		Pair type	Pair status	
	P-VOL	S-VOL		P-VOL	S-VOL
GAD pair	PAIR	PAIR	GAD pair	PSUE	SSWS
UR pair	PAIR	PAIR	UR delta resync pair	PSUE	SSUS
UR delta resync pair	PSUS	SSUS	UR pair	From COPY to PAIR	From COPY to PAIR

If a failure occurs, the UR delta resync pair changes to a UR pair, and copying from the GAD S-VOL to the UR S-VOL starts. When the UR pair copying is completed, the status of the P-VOL and the status of the S-VOL of the UR pair change to PAIR.

Overview of failure recovery

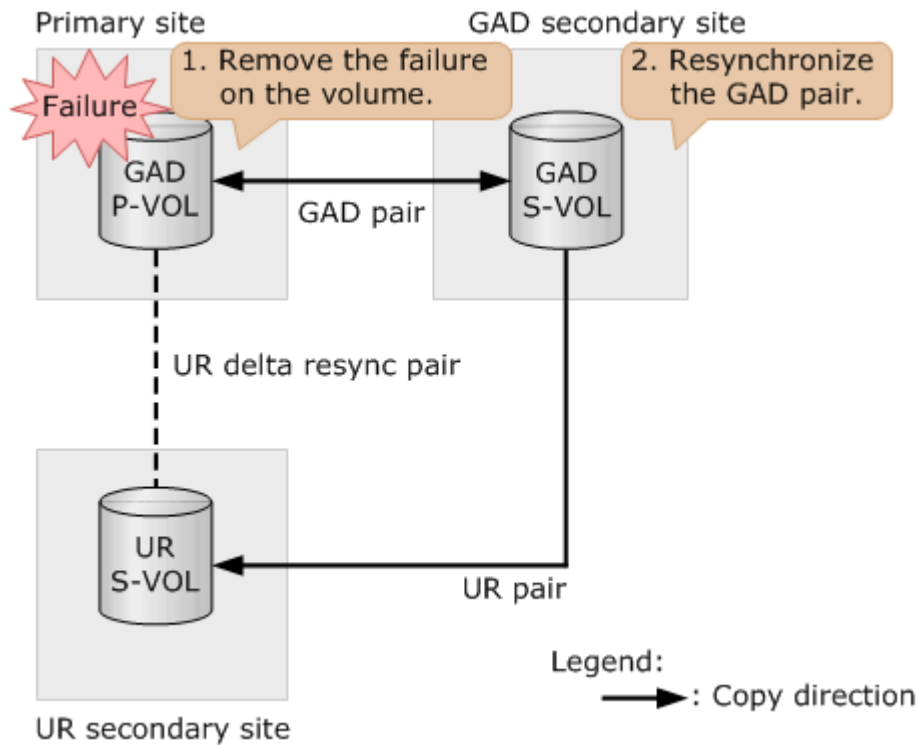

Procedure

1. Remove the failure (LDEV blockade) on the P-VOL.
2. Reverse the P-VOL and the S-VOL, and then resynchronize the GAD pairs (swap resync) on the storage system at the GAD secondary site.

Command example: `pairresync -g oraHA -swaps -IH1`

The volume on the primary storage system changes to an S-VOL, and the volume on the GAD secondary storage system changes to a P-VOL.

3. Confirm that the GAD P-VOL and S-VOL pair statuses change to PAIR.

Command example:

```
pairdisplay -g oraHA -fxce -IH0
Group  PairVol(L/R) (Port#,TID, LU),Seq#,LDEV#.P/S,Status,
Fence,  %,P-LDEV# M CTG JID AP EM          E-Seq# E-LDEV# R/W
oraHA  dev1(L)      (CL1-A-0, 0, 0)311111 2222.P-VOL PAIR
NEVER , 100 4444 - - 0 - -          - - L/M
oraHA  dev1(R)      (CL1-C-1, 0, 0)322222 4444.S-VOL PAIR
NEVER , 100 2222 - - 0 - -          - - L/M
```

```
pairdisplay -g oraHA -fxce -IH1
Group  PairVol(L/R) (Port#,TID, LU),Seq#,LDEV#.P/S,Status,
Fence,  %,P-LDEV# M CTG JID AP EM          E-Seq# E-LDEV# R/W
oraHA  dev1(L)      (CL1-C-1, 0, 0)322222 4444.S-VOL PAIR
NEVER , 100 2222 - - 0 - -          - - L/M
```

```
oraHA dev1(R) (CL1-A-0, 0, 0) 311111 2222.P-VOL PAIR
NEVER , 100 4444 - - 0 - - - - L/M
```

4. Keep updating I/O from the server to the P-VOL or S-VOL of the GAD pair for about two minutes.
5. Confirm that the delta UR P-VOL pair status is PSUS.

Command example:

```
pairdisplay -g oraREMOTE -fxce -IH0
Group      PairVol (L/R) (Port#,TID, LU),Seq#, LDEV#.P/S,
Status,Fence, %, P-LDEV# M CTG JID AP EM E-Seq# E-
LDEV# R/W
oraDELTA dev2(L) (CL1-A-1, 0, 1) 311111 2222. P-VOL
PSUS ASYNC ,0 6666 - 0 0 - - -
- -/-
oraDELTA dev2(R) (CL1-A-1, 0, 1) 344444 6666. S-VOL
SSUS ASYNC ,0 2222 - 0 0 - - -
- -/-
```



Note: To check the status of a pair in Device Manager - Storage Navigator, select **Refresh All** in the **File** menu, update the information displayed on Device Manager - Storage Navigator, and then view the pair status. The status of the UR delta resync pairs changes from HOLDING to HOLD.

6. Confirm that the mirror status of the journal of the UR delta resync pair is PJNS.

Command example:

```
pairdisplay -g oraREMOTE -v jnl -IH0
JID MU CTG JNLS AP U(%) Q-Marker Q-CNT D-SZ (BLK)
Seq# Num LDEV#
000 1 1 PJNS 4 21 43216fde 30 512345
62500 1 39321
```

7. Confirm that no failure SIMs are displayed.
8. Reverse the GAD P-VOL and the S-VOL if necessary. For instructions, see [Reversing the GAD P-VOL and S-VOL \(GAD+UR\) on page 272](#).

Reversing the GAD P-VOL and S-VOL (GAD+UR)

Use the following procedure to reverse the GAD P-VOL and S-VOL when sharing GAD volumes with UR in a GAD 3DC delta resync (GAD+UR) configuration.

Procedure

1. Suspend the GAD pair by specifying the S-VOL (swap suspend).

Command example: `pairsplit -g oraHA -RS -IH0`

2. Resynchronize the GAD pair by specifying the S-VOL (swap resync).

Command example: `pairresync -g oraHA -swaps -IH0`

The volume on the primary storage system changes to a P-VOL, and the volume on the GAD secondary storage system changes to an S-VOL.

3. Keep updating I/O from the server to the P-VOL or S-VOL of the GAD pair for about two minutes.
4. Confirm that the delta UR P-VOL pair status is PSUS.

Command example:

```
pairdisplay -g oraDELTA -fxce -IH0
Group      PairVol (L/R) (Port#,TID, LU),Seq#, LDEV#.P/S,
Status,Fence, %, P-LDEV# M CTG JID AP EM E-Seq# E-
LDEV# R/W
oraDELTA dev2 (L) (CL1-A-1, 0, 1) 311111 2222. P-VOL
PSUS ASYNC ,0 6666 - 0 0 - - -
- -/-
oraDELTA dev2 (R) (CL1-A-1, 0, 1) 344444 6666. S-VOL
SSUS ASYNC ,0 2222 - 0 0 - - -
- -/-
```



Note: To check the status of a pair in Device Manager - Storage Navigator, select **Refresh All** in the **File** menu, update the information displayed on Device Manager - Storage Navigator, and then view the pair status. The status of the UR delta resync pairs changes from HOLDING to HOLD.

5. Confirm that the mirror status of the journal of the UR delta resync pair is PJNS.

Command example:

```
pairdisplay -g oraDELTA -v jnl -IH0
JID MU CTG JNLS AP U(%) Q-Marker Q-CNT D-SZ (BLK)
Seq# Num LDEV#
000 1 1 PJNS 4 21 43216fde 30 512345
62500 1 39321
```

6. Confirm that no failure SIMs are displayed.

Recovering from secondary site and S-VOL failures (GAD +UR)

This section describes the procedure for recovering from secondary site failures and failures (LDEV blockade) on an S-VOL at the secondary site using examples.

Recovering from a secondary site failure (GAD+UR)

This subsection describes how to recover from a failure in a storage system at the secondary site. When a failure occurs at the secondary site, the GAD pair statuses at the primary site and the secondary site change to PSUE.

Overview of failure recovery

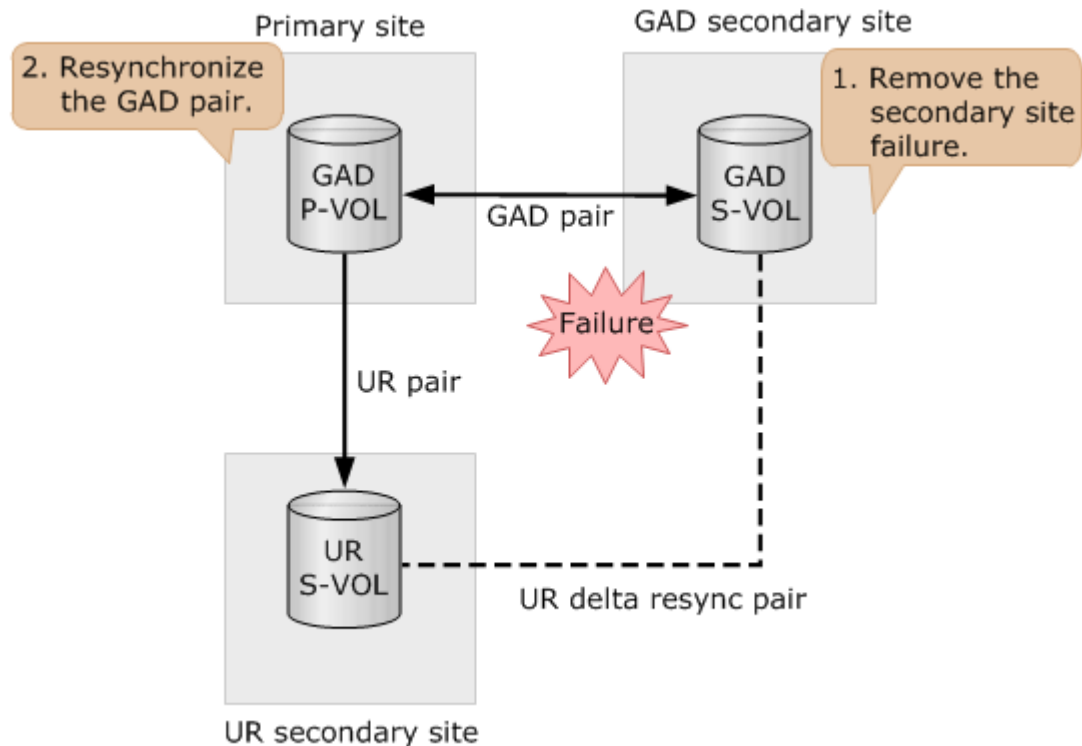

Procedure

1. Remove the failure on the S-VOL.
2. Resynchronize the GAD pair at the primary storage system.

Command example:

```
pairresync -g oraHA -IH0
```

3. Confirm that the GAD P-VOL and S-VOL pair statuses change to PAIR.

Command example:

```
pairdisplay -g oraHA -fxce -IH0
```

```
Group PairVol(L/R) (Port#,TID, LU),Seq#,LDEV#.P/  
S,Status,Fence, %,P-LDEV# M CTG JID AP EM E-Seq# E-LDEV# R/W
```

```
oraHA dev1(L) (CL1-A-0, 0, 0)311111 2222.P-VOL PAIRNEVER ,  
100 4444 - - 0 - - - - L/M
```

```
oraHA dev1(R) (CL1-C-1, 0, 0)322222 4444.S-VOL PAIRNEVER ,  
100 2222 - - 0 - - - - L/M
```

```
pairdisplay -g oraHA -fxce -IH1
```

```
Group PairVol(L/R) (Port#,TID, LU),Seq#,LDEV#.P/  
S,Status,Fence, %,P-LDEV# M CTG JID AP EM E-Seq# E-LDEV# R/W
```

```
oraHA dev1(L) (CL1-C-1, 0, 0)322222 4444.S-VOL PAIRNEVER ,  
100 2222 - - 0 - - - - L/M
```

```
oraHA dev1(R) (CL1-A-0, 0, 0)311111 2222.P-VOL PAIRNEVER ,  
100 4444 - - 0 - - - - L/M
```

4. Keep updating I/O from the server to the P-VOL or S-VOL of the GAD pair for about two minutes.
5. Confirm that the pair status of the delta UR P-VOL is PSUS.

Command example:

```
pairdisplay -g oraDELTA -fxce -IH1
```

```
Group PairVol(L/R) (Port#,TID, LU),Seq#, LDEV#.P/  
S,Status,Fence, %, P-LDEV# M CTG JID AP EM E-Seq# E-LDEV# R/W
```

```
oraDELTA dev3(L) (CL1-A-1, 0, 1) 322222 4444. P-VOLPSUS  
ASYNC ,0 6666 - 0 0 - - - - -/-
```

```
oraDELTA dev3(R) (CL1-A-1, 0, 1) 344444 6666. S-VOLSSUS  
ASYNC ,0 4444 - 0 0 - - - - -/-
```



Note: To check the status of a pair in Device Manager - Storage Navigator, select **Refresh All** in the **File** menu, update the information displayed on Device Manager - Storage Navigator, and then view the pair status. The status of the UR delta resync pairs changes from HOLDING to HOLD.

- Confirm that the mirror status of the journal of the UR delta resync pair is PJNS using the CCI instance for managing the GAD secondary storage system.

Command example:

```
pairedisplay -g oraDELTA -v jnl -IH1
```

```
JID MU CTG JNLS AP U(%) Q-Marker Q-CNT D-SZ(BLK) Seq# Num
LDEV#
```

```
000 1 1 PJNS 4 21 43216fde 30 512345 62500 1 39321
```

- Confirm that no failure SIMs are displayed.

Recovering from a failure (LDEV blockade) on an S-VOL at the secondary site (GAD+UR)

When a failure (LDEV blockade) occurs on an S-VOL at the secondary site, the GAD pair statuses of the P-VOL and S-VOL change to PSUE.

Overview of failure recovery

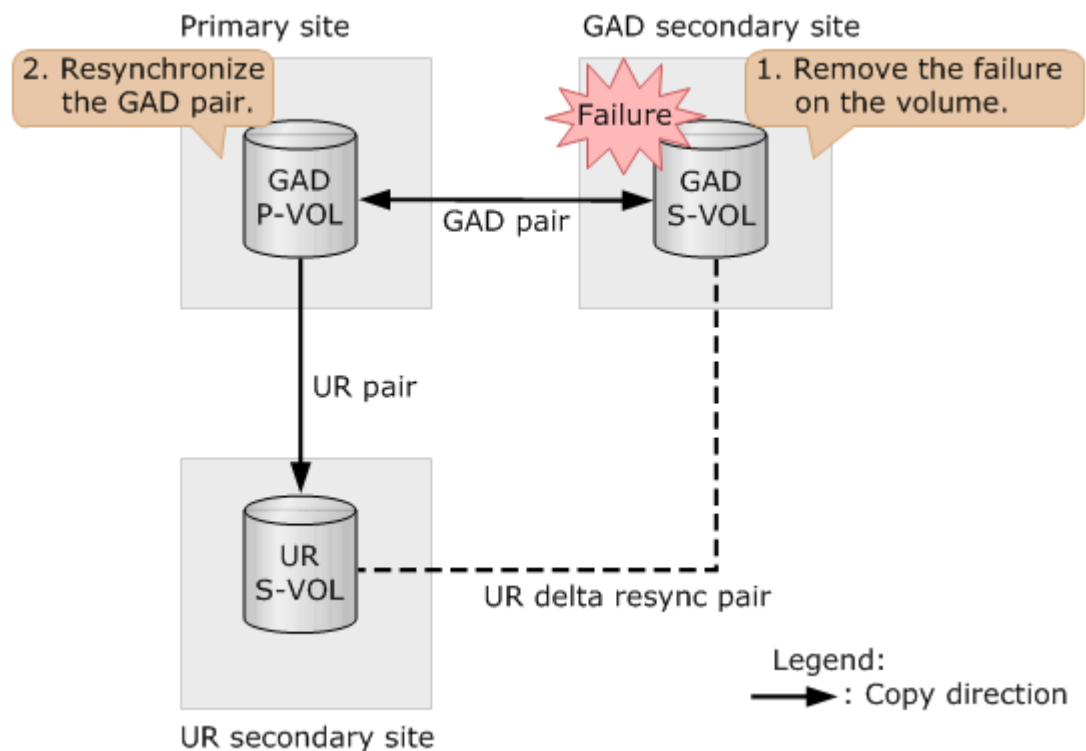

Procedure

1. Remove the failure (LDEV blockade) on the S-VOL.
2. Resynchronize the GAD pair at the primary storage system.

Command example: `pairresync -g oraHA -IH0`

3. Confirm that the GAD P-VOL and S-VOL pair statuses change to PAIR.

Command example:

```
pairdisplay -g oraHA -fxce -IH0
Group   PairVol(L/R) (Port#,TID, LU),Seq#,LDEV#.P/S,Status,
Fence,   %,P-LDEV# M CTG JID AP EM           E-Seq# E-LDEV# R/W
oraHA   dev1(L)      (CL1-A-0, 0, 0)311111 2222.P-VOL PAIR
NEVER , 100 4444 - - 0 - - - - - -
oraHA   dev1(R)      (CL1-C-1, 0, 0)322222 4444.S-VOL PAIR
NEVER , 100 2222 - - 0 - - - - - -
```

```
pairdisplay -g oraHA -fxce -IH1
Group   PairVol(L/R) (Port#,TID, LU),Seq#,LDEV#.P/S,Status,
Fence,   %,P-LDEV# M CTG JID AP EM           E-Seq# E-LDEV# R/W
oraHA   dev1(L)      (CL1-C-1, 0, 0)322222 4444.S-VOL PAIR
NEVER , 100 2222 - - 0 - - - - - -
oraHA   dev1(R)      (CL1-A-0, 0, 0)311111 2222.P-VOL PAIR
NEVER , 100 4444 - - 0 - - - - - -
```

4. Keep updating I/O from the server to the P-VOL or S-VOL of the GAD pair for about two minutes.
5. Confirm that the pair status of the delta UR P-VOL is PSUS.

Command example:

```
pairdisplay -g oraDELTA -fxce -IH1
Group   PairVol(L/R) (Port#,TID, LU),Seq#, LDEV#.P/S,
Status,Fence, %, P-LDEV# M CTG JID AP EM E-Seq# E-
LDEV# R/W
oraDELTA dev3(L)      (CL1-A-1, 0, 1) 322222 4444. P-VOL
PSUS ASYNC ,0 6666 - 0 0 - - - -
- -/-
oraDELTA dev3(R)      (CL1-A-1, 0, 1) 344444 6666. S-VOL
SSUS ASYNC ,0 4444 - 0 0 - - - -
- -/-
```



Note: To check the status of a pair in Device Manager - Storage Navigator, select **Refresh All** in the **File** menu, update the information displayed on Device Manager - Storage Navigator, and then view the pair status. The status of the UR delta resync pairs changes from HOLDING to HOLD.

6. Confirm that the mirror status of the journal of the UR delta resync pair is PJNS using the CCI instance for managing the GAD secondary storage system.

Command example:

```
pairdisplay -g oraDELTA -v jnl -IH1
JID MU CTG JNLS AP U(%) Q-Marker Q-CNT D-SZ (BLK)
Seq# Num LDEV#
000 1 1 PJNS 4 21 43216fde 30 512345
62500 1 39321
```

7. Confirm that no failure SIMs are displayed.

Recovering from a failure at the primary and secondary sites (GAD+UR)

Use the following procedure to recover from a failure at the primary and secondary sites when sharing GAD volumes with UR in a GAD 3DC delta resync (GAD+UR) configuration. You need to delete and re-create all pairs.

Procedure

1. Suspend the UR pair by specifying the S-VOL (swap suspend).

Command example: `pairsplit -g oraREMOTE -RS -IH2`

You can resume operations at this point by using the S-VOL at the UR secondary site.

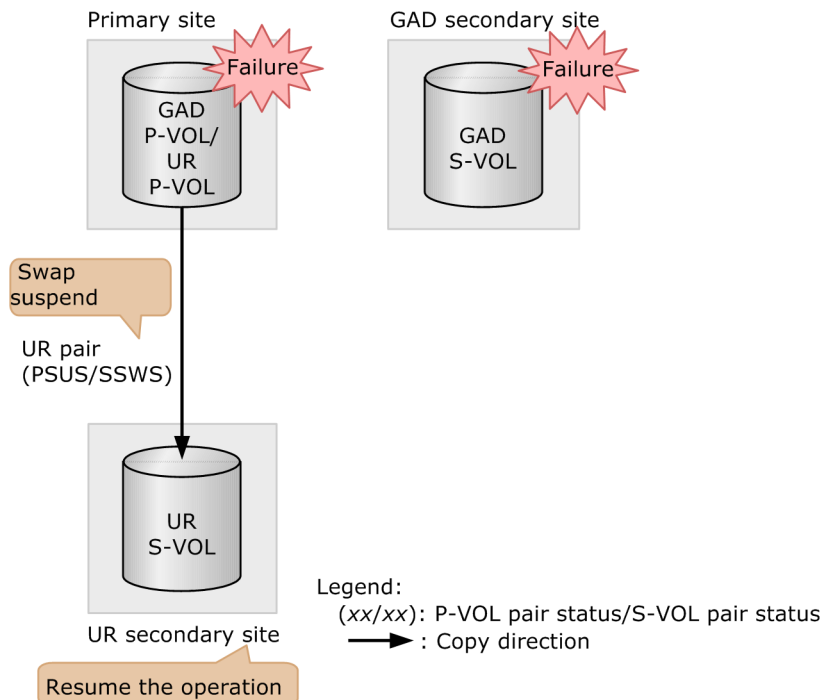

2. Remove the failure at the primary and secondary sites.

3. Delete the UR pair.
4. Delete the UR delta resync pair.
5. Delete the GAD pair.

When the I/O mode of both the primary and secondary volumes is Block, forcibly delete the pair, as follows:

- If you specify the S-VOL, delete the virtual LDEV ID at the same time.
Command example: `pairsplit -g oraHA -RF -IH1`
- If you specify the P-VOL, do not delete the virtual LDEV ID this time.
Command example: `pairsplit -g oraHA -SFV -IH0`

To forcibly delete a pair when the I/O mode is not Block, call Hitachi Data Systems Corporation customer support.



Caution: When you delete a GAD pair forcibly in Device Manager - Storage Navigator, select **Force** in **Delete Mode** in the **Delete Pairs** window.

6. Create a UR pair between the UR secondary and primary sites.

Command example: `paircreate -g oraREMOTE -f async -vl -jp 0 -js 0 -IH2`

7. Suspend the UR pair by specifying the S-VOL (swap suspend).

Command example: `pairsplit -g oraREMOTE -RS -IH0`

You can resume operations at this point by using the S-VOL at the primary site.

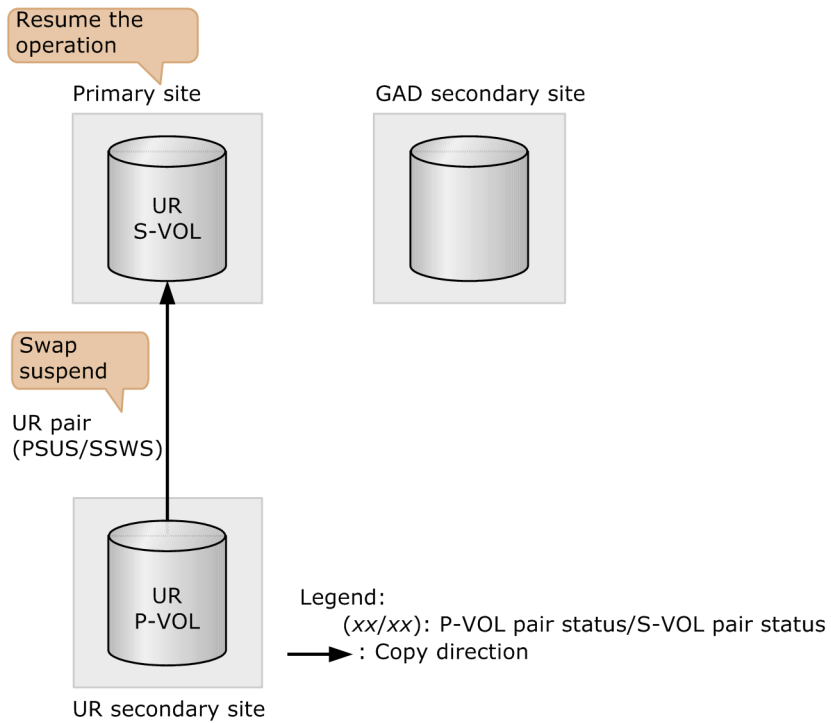

8. Resynchronize the UR pair by specifying the S-VOL (swap resync).

Command example: `pairresync -g oraREMOTE -swaps -IH0`

The volume on the primary storage system changes to a P-VOL, and the volume on the UR secondary storage system changes to an S-VOL.

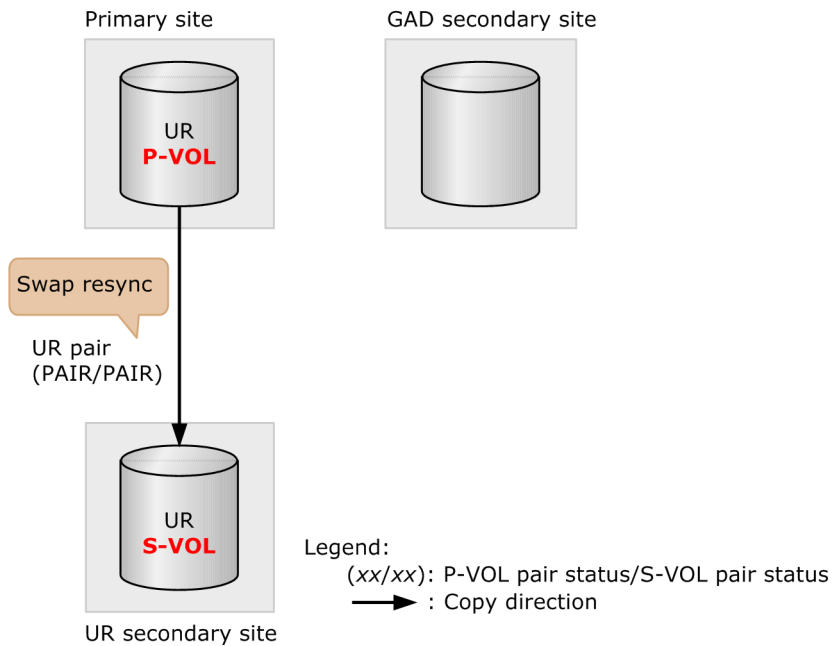

9. Delete the UR pair.

Command example: `pairsplit -g oraREMOTE -S -IH0`

10. Re-create the GAD pair.

Command example: `paircreate -g oraHA -fg never 2 -vl -jq 0 -IH0`

11. Re-create the UR delta resync pair.

Command example: `paircreate -g oraDELTA -f async -vl -jp 0 -js 0 -nocsus -IH1`

12. Re-create the UR pair.

Command example: `paircreate -g oraREMOTE -f async -vl -jp 0 -js 0 -IH0`

Recovering from a failure on the UR delta resync pair

Use the following procedure to recover from a failure on the UR delta resync pair due to a journal full condition on the storage system at the GAD secondary site.

When a failure occurs on the UR delta resync pair, a SIM is displayed.

Overview of failure recovery

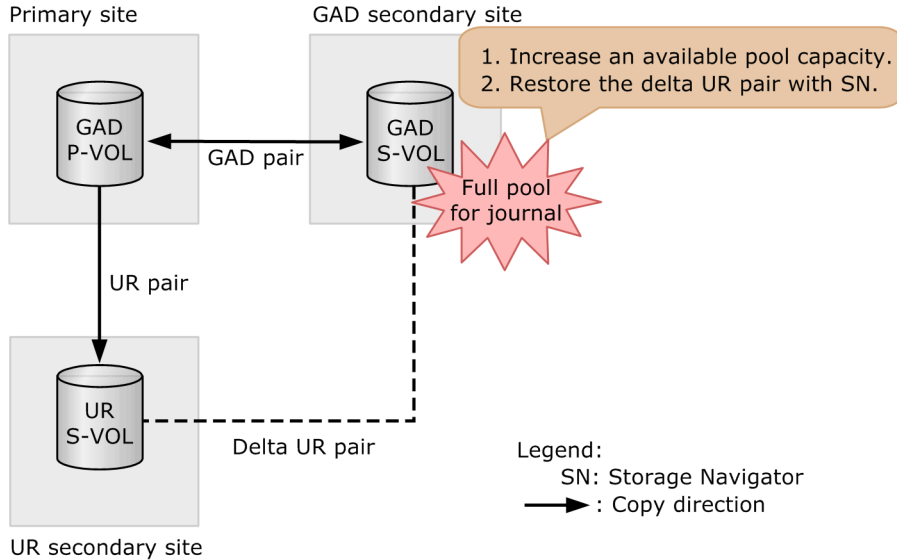

Procedure

1. Increase the available capacity of the pool used by the journal at the GAD secondary storage system.

2. Restore the UR delta resync pair.

Specify **Return to standby** in **Resync Mode** of the **Resync Mirrors** window of Device Manager - Storage Navigator.



Note: You cannot do this using CCI.

3. Confirm that the pair status of the delta UR P-VOL is PSUS.

Command example:

```
pairdisplay -g oraDELTA -fxce -IH1
Group      PairVol(L/R) (Port#,TID, LU), Seq#, LDEV#.P/S,
Status, Fence, %, P-LDEV# M CTG JID AP EM E-Seq# E-
LDEV# R/W
oraDELTA dev3(L) (CL1-A-1, 0, 1) 322222 4444. P-VOL
PSUS ASYNC ,0 6666 - 0 0 - - -
- -/-
oraDELTA dev3(R) (CL1-A-1, 0, 1) 344444 6666. S-VOL
SSUS ASYNC ,0 4444 - 0 0 - - -
- -/-
```

4. Confirm that the mirror status of the journal of the UR delta resync pair is PJNS using the CCI instance for managing the GAD secondary storage system.

Command example:

```
pairdisplay -g oraDELTA -v jnl -IH1
JID MU CTG JNLS AP U(%) Q-Marker Q-CNT D-SZ (BLK)
Seq# Num LDEV#
000 1 1 PJNS 4 21 43216fde 30 512345
62500 1 39321
```

5. Confirm that no failure SIMs are displayed.

Recovering from a quorum disk failure (GAD+UR)

You can recover from a quorum disk failure when sharing GAD volumes with UR in a GAD 3DC delta resync (GAD+UR) configuration.

You can use a volume in an external storage system or a disk in a server for a quorum disk. Procedures are based on the assumption that a volume in an external storage system is used as the quorum disk and depend on either of the following statuses:

- Able to access either volume of the GAD pair from the server
- Not able to access either volume of the GAD pair from the server

To check whether you can access the volumes of a GAD pair from the server, use I/O mode for the GAD pair.

Command example

```
pairdisplay -g oraHA -fxce -IH0
Group   PairVol (L/R) (Port#,TID, LU),Seq#,LDEV#.P/S,Status,
Fence,  %,P-LDEV# M CTG JID AP EM          E-Seq# E-LDEV# R/W
oraHA   dev1 (L)      (CL1-A-0, 0, 0)311111 2222.S-VOL PSUS
NEVER , 100 4444 - - 0 - -          - - L/L
oraHA   dev1 (R)      (CL1-C-1, 0, 0)322222 4444.P-VOL PAIR
NEVER , 100 2222 - - 0 - -          - - B/B
```

The server can access a volume whose I/O mode (R/W) is L/L (Local), and cannot access a volume whose I/O mode (R/W) is B/B (Block).

Related tasks

- [Recovering from a quorum disk failure when one GAD volume is accessible](#) on page 283
- [Recovering from a quorum disk failure when neither GAD volume is accessible](#) on page 284

Recovering from a quorum disk failure when one GAD volume is accessible

Use the following procedure to recover a failure on the quorum disk when you can access either volume of a GAD pair from the server.

Overview of failure recovery

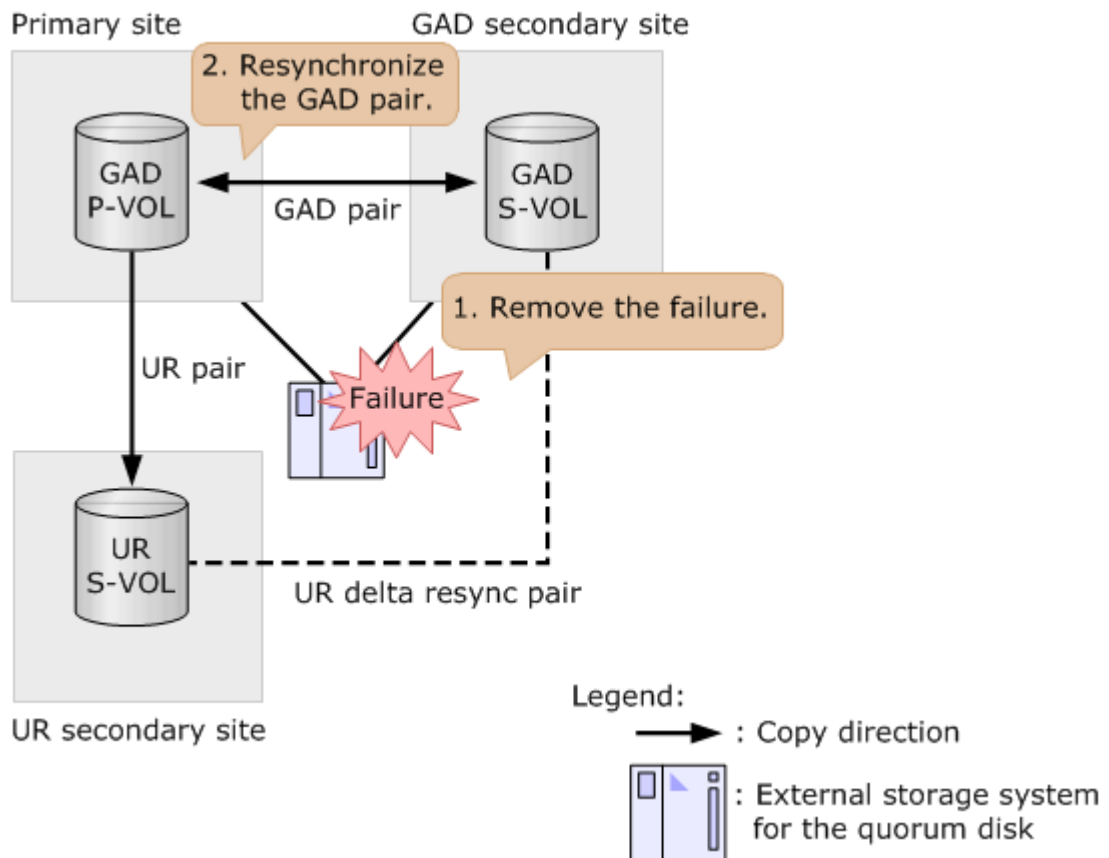

Procedure

1. Remove the failure on the quorum disk.
2. Resynchronize GAD pairs if they are suspended by a failure.

Recovering from a quorum disk failure when neither GAD volume is accessible

When a failure occurs on the quorum disk and you cannot access either volume of a GAD pair from the server, you need to delete the UR and GAD pairs, then recover from the failure by using the volume at the UR secondary site, and then re-create the pairs.

Procedure

1. Delete the UR pair.
Command example: `pairsplit -g oraREMOTE -S -IH0`
2. Delete the UR delta resync pair.
Command example: `pairsplit -g oraDELTA -S -IH1`
3. Delete the GAD pair.

When the I/O mode of both the primary and secondary volumes is Block, you can forcibly delete the pair, as follows:

- If you specify the S-VOL, delete the virtual LDEV ID at the same time.
Command example: `pairsplit -g oraHA -RF -IH1`
- If you specify the P-VOL, do not delete the virtual LDEV ID this time.
Command example: `pairsplit -g oraHA -SFV -IH0`

To forcibly delete a pair when the I/O mode is not Block, call Hitachi Data Systems Corporation customer support.

! Caution: When you delete a GAD pair forcibly in Device Manager - Storage Navigator, select **Force** in **Delete Mode** in the **Delete Pairs** window.

4. Create a UR pair between the UR secondary and primary sites.

Command example: `paircreate -g oraREMOTE -f async -vl -jp 0 -js 0 -IH2`

You can resume operations at this point by using the P-VOL at the UR secondary site.

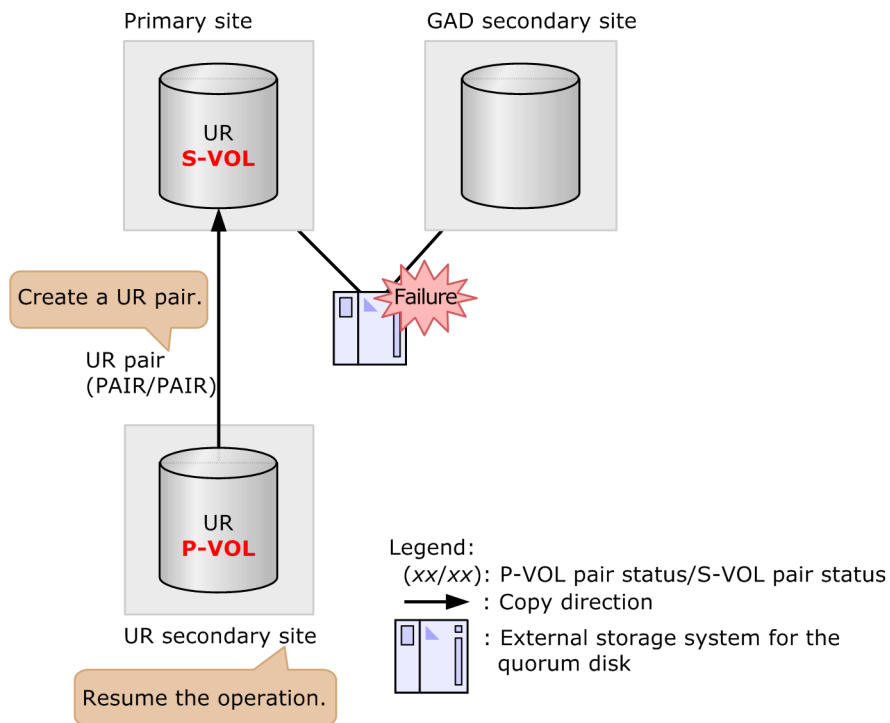

- 5.** Remove the failure on the quorum disk.
- 6.** Suspend the UR pair by specifying the S-VOL (swap suspend).

Command example: `pairsplit -g oraREMOTE -RS -IH0`

You can resume operations at this point by using the S-VOL at the primary site.

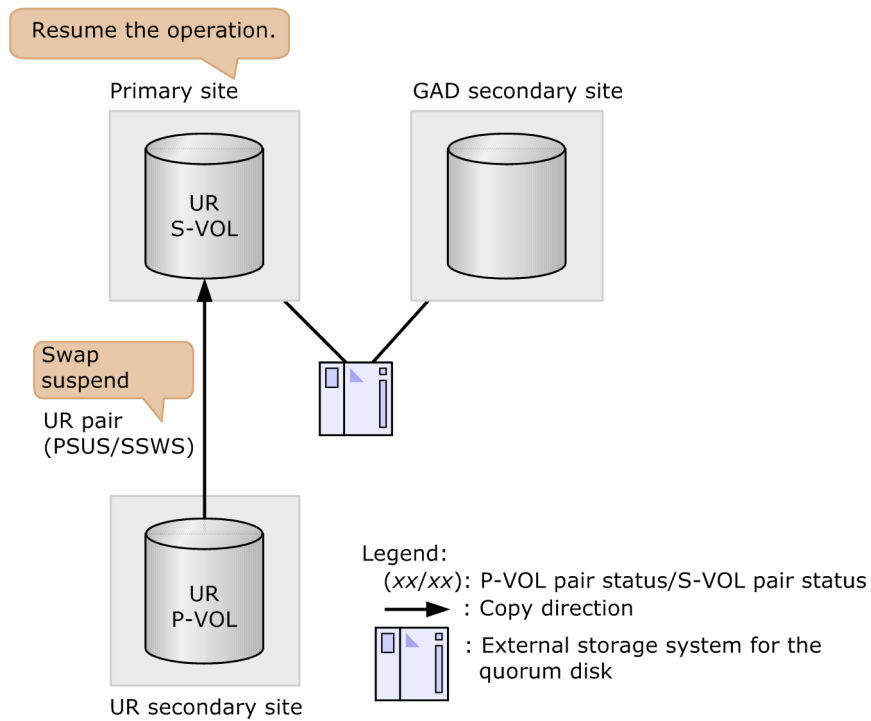

7. Resynchronize the UR pair by specifying the S-VOL (swap resync).

Command example: `pairresync -g oraREMOTE -swaps -IH0`

The volume on the primary storage system changes to a P-VOL, and the volume on the UR secondary storage system changes to an S-VOL.

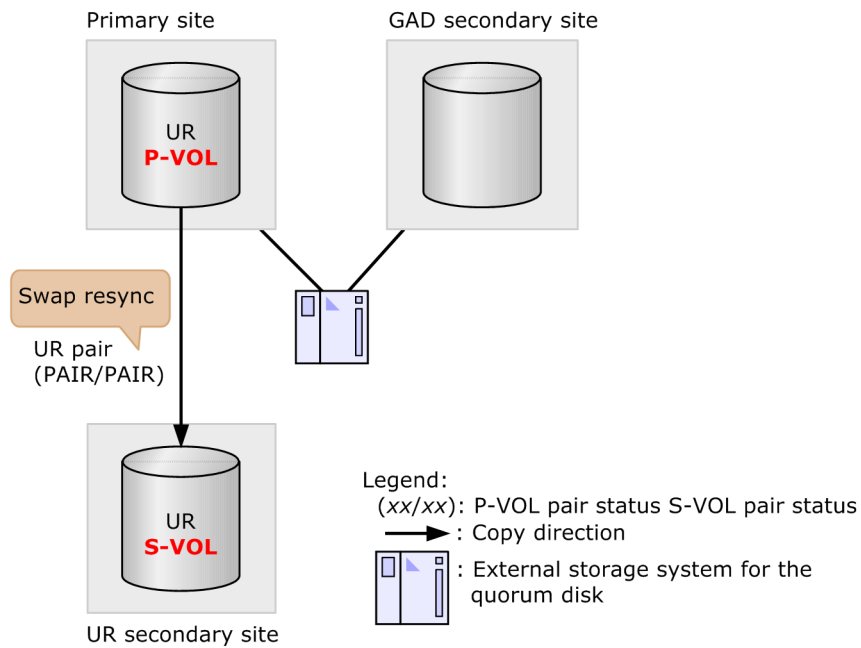

8. Delete the UR pair.

Command example: `pairsplit -g oraREMOTE -S -IH0`

9. Re-create the GAD pair.

Command example: `paircreate -g oraHA -fg never 2 -vl -jq 0 -IH0`

10. Re-create the UR delta resync pair.

Command example: `paircreate -g oraDELTA -f async -vl -jp 0 -js 0 -nocsus -IH1`

11. Re-create the UR pair.

Command example: `paircreate -g oraREMOTE -f async -vl -jp 0 -js 0 -IH0`

Troubleshooting

This chapter provides troubleshooting information for Universal Replicator operations.

- [General troubleshooting](#)
- [Remote path status problems](#)
- [Troubleshooting by suspend type](#)
- [Troubleshooting hardware problems affecting pairs](#)
- [Troubleshooting with CCI](#)
- [Service information messages \(SIMs\)](#)
- [Calling customer support](#)

General troubleshooting

When an error occurs in a Universal Replicator pair operation with Device Manager - Storage Navigator, an error message with a four-digit error code and description is displayed. An SVP error code might also be included. See the Hitachi Device Manager - Storage Navigator Messages for details about error codes.

You can download Device Manager - Storage Navigator dump files using the Dump tool. If you are unable to resolve an error, use the tool to copy the dump files to a file, and then contact customer support for assistance.

The following table lists error conditions and provides recommended action to resolve the condition.

Error	Recommended action
Device Manager - Storage Navigator hangs, or UR operations do not function properly.	<p>Make sure that the problem is not being caused by the computer or Ethernet hardware or software, and restart the computer. Restarting the Device Manager - Storage Navigator computer does not affect UR operations in progress.</p> <p>Make sure that UR requirements are met.</p> <p>Make sure that the primary and secondary storage systems and remote copy connections are powered on, and that NVS and cache are fully operational.</p> <p>Check all the entered values and parameters to make sure that you entered the correct information on the Device Manager - Storage Navigator computer (for example, secondary storage system serial number, path parameters, P-VOL and S-VOL IDs).</p> <p>If you are using Performance Monitor, refrain from using it.</p>
An initiator channel-enable LED indicator (on the control window) is off or flashing.	Call customer support for assistance.
Status of pairs and/or remote paths is not displayed correctly.	Check whether you selected correct items and options in UR Device Manager - Storage Navigator windows.
A UR error message appears on the Device Manager - Storage Navigator computer.	Remove the error cause, and then retry the UR operation.
The status of a remote path is not normal.	Check the path status in the View Remote Connection Properties window, and see Remote path status problems on page 292 .
The pair status is suspended.	Check the pair status in the View Pair Properties window, and see Troubleshooting by suspend type on page 294 for suspend types and corrective action.
The pair create or pair resync operation resulted in a timeout error.	<ul style="list-style-type: none"> If the timeout error was caused by a hardware failure, a SIM is generated. See Service information messages (SIMs) on page 314. If necessary, call customer support, and retry UR operations after the problem is solved. If no SIM was generated, wait for a while (5 or 6 minutes), and then check the pair status of the pairs being created or resynchronized. If the pair status changed correctly, the failed operation completed after the timeout message was issued. If

Error	Recommended action
	<p>the pair status did not change as expected, heavy workload might have prevented the UR operation from being completed. In this case, retry the UR operation when the system has a lighter workload.</p> <ul style="list-style-type: none"> • If a time-out error occurs during the paircreate operation, the copy operation might not have been executed correctly in the order specified in the Priority field. A time-out error may be caused by the CU configuration or a remote copy path error. Review the error, release the pair with the error, and then retry the paircreate operation.
A communication error between Device Manager - Storage Navigator and the SVP occurred.	For instructions see the <i>System Administrator Guide</i> for your storage system.
Journal volumes are not registered in the journal.	The error caused the delete journal operation to suspend. Re-register the journal volumes that belong to the journal, and then delete the journal again.
The pairresync operation suspends with a warning message.	<p>This is caused when the following two conditions exist:</p> <ul style="list-style-type: none"> • The Preview list contains two or more pairs belonging to the same mirror. • Mirror is defined in the Range column for at least one of these pairs. <p>To continue processing, do either of the following:</p> <ul style="list-style-type: none"> • Ensure that the Range column displays LU for all pairs in the same mirror. • In the Preview list, delete all but one pair in the same mirror.
An error occurs when Apply is clicked for a pair operation.	The error code appears in the right-most column of the Preview list. To view detailed information about the error, right click the error code and select Error Detail.
The pairs cannot be deleted after the pair operations because the pair status changed to Suspending or Deleting.	See Deleting pairs in a mirror on page 144 and specify Force for Delete Mode.
The status of a delta resync pair does not change after you perform the delta resync operation.	One or more of the requirements and prerequisites might not be met (for example, SOM 506 must be enabled). First check the status of all pairs including the delta resync pair for information about the problem, and then review the prerequisite material in Delta resync configuration on page 327 .
All of the journals in a consistency group are suspended.	<p>All of the journals in a consistency group can be suspended when an error occurs in one of the journals in the consistency group. This takes place under the following conditions:</p> <ul style="list-style-type: none"> • The communications lines between CCI and all primary storage systems are normal. • The status of the failed journal is PJSE or PJSF. • At least one journal in the consistency group is in normal status. <p>When these conditions are present, you should be aware of the following information:</p> <ul style="list-style-type: none"> • When an error occurs, the status of the journal changes from normal to PJSE (suspended by error). • For an error caused by overflowing capacity, the status changes to PJSF. • When the status of one journal becomes PJSE or PJSF, all other normal journals in PJNN status also change to the PJSE status.

Error	Recommended action
	<ul style="list-style-type: none"> If you use CCI and if a journal is in the normal status, it will be shown as PJNN. <p>If some pairs in the journal become suspended by error but the whole journal does not become suspended, the status of other journals does not change.</p>

Remote path status problems

There are corrective actions you can take given the status of remote paths between the storage systems.

The following table provides troubleshooting information for the remote paths between the storage systems. If the remote path status is not normal, a hardware failure might occur over the network. A hardware failure can include a port failure between the local storage system and a remote storage system or a network relay device failure. In such cases, resolve the hardware failure first, and then perform the corrective actions described in the table.

Path status	Description	Corrective action
Normal	This path has been successfully established and can be used for UR copy activities.	None required.
Initialization Failed	The link initialization procedure to the remote storage system failed because the physical path connection was missing between the local and remote storage systems.	<ul style="list-style-type: none"> Make sure that the local and remote storage systems are physically and correctly connected. Make sure that you entered the correct remote storage system serial number, model, and local and remote storage system port numbers. Make sure the local and remote storage system ports are configured correctly.
Communication Time Out	Communication between the local and remote storage system timed out.	<ul style="list-style-type: none"> Make sure the remote storage system is powered on and fully functional. Make sure that the network relay devices are properly configured and functional, including cables, connectors, switches, extender devices, communication lines, and all other devices connected to the extenders.
Port Rejected	The local storage system rejected the logical path link control function because all logical path resources in the local storage system are being used for other connections.	<ul style="list-style-type: none"> Delete all remote paths not in use in the Remove Remote Paths window. Make sure that all local and remote storage system ports are properly configured: ordinary RCU target ports for remote storage systems, initiator ports for local storage systems. If necessary, connect to the remote storage system to delete paths. Reconfigure the ports, and then add the paths and configure the remote storage systems to the local storage systems again.

Path status	Description	Corrective action
Pair-Port Rejected	The remote storage system rejected the logical path link control function because all logical path resources in the remote storage system are being used for other connections.	Follow the same corrective actions in Port Rejected.
Serial Number Mismatch	The remote storage system's serial number does not match the specified serial number.	<ul style="list-style-type: none"> • Make sure that you entered the correct remote storage system serial number and model, and local and remote storage system port numbers. • Make sure the local and remote storage system ports are configured correctly. • Make sure that data path relay equipment is properly configured and functional. This includes cables, connectors, switches, extender devices, communication lines, and all other devices connected to the extenders.
Invalid Port Mode	The specified port is not configured as an initiator port, or this path already exists.	<ul style="list-style-type: none"> • Make sure the correct port on the local storage system is configured as an initiator port. • Make sure that no two paths between local and remote storage system ports have the same settings. • Make sure that you entered the correct remote storage system serial number and model, and local and remote storage system port numbers. • Make sure that the local and remote storage system ports are configured correctly. • Make sure that data path relay equipment is properly configured and functional. This includes cables, connectors, switches, extender devices, communication lines, and all other devices connected to the extenders.
Pair-Port Number Mismatch	The specified port in the remote storage system is physically disconnected from the local storage system.	<ul style="list-style-type: none"> • Make sure that you specified the correct remote storage system port number. Correct the port number if necessary. • Make sure that the cables between the local and remote storage system ports and between the local and remote storage system switches are connected correctly. • Make sure that the topology settings of the local and remote storage system ports are correct.
Pair-Port Type Mismatch	The specified remote storage system port is not configured as an RCU target port.	Make sure that the remote storage system port is configured as an RCU target port.
Communication Failed	The local storage system connected to the remote storage system successfully, but logical communication timeout occurred.	<ul style="list-style-type: none"> • Make sure that the remote storage system port and the relay equipment are configured correctly. • Make sure that data path relay equipment is properly configured and functional. This includes cables, connectors, switches, extender devices, communication lines, and all other devices connected to the extenders.

Path status	Description	Corrective action
In Progress	Paths are being created or deleted, or the port attribute is being changed.	Wait until processing is completed.
Logical Blockade	Logical blockade was detected.	Remove the remote connections and remote paths you set, and then restore the remote paths.*
Program Error	A program error is detected.	Restore the path.*
<p>* If you use Device Manager - Storage Navigator, restore remote paths by either of the following methods:</p> <ul style="list-style-type: none"> • In the Remove Remote Connections window, delete the remote connection, and then register a remote connection again in the Add Remote Connection window. • In the Remove Remote Paths window, remove the remote path, and then create a remote path again in the Add Remote Paths window. <p>When using CCI, use the <code>raidcom delete rcu_path</code> command to delete the remote path, and then use the <code>raidcom add rcu_path</code> command to create a remote path again. Using this method, you can restore a remote path.</p> <p>If you cannot restore the path after deleting the remote storage system or deleting the remote path or re-registering by configuring the primary and secondary storage systems, contact HDS for assistance.</p>		

Related tasks

- [Deleting the UR relationship](#) on page 222
- [Deleting remote paths](#) on page 221
- [Configuring primary and secondary storage systems for UR](#) on page 117

Troubleshooting by suspend type

The following table provides troubleshooting information for suspended pairs by suspend type.

Suspend type	Applies to	Description	Corrective action
By RCU	P-VOL	The primary storage system suspended a pair because it detected an error condition in the secondary storage system. The suspend type for the S-VOL is by MCU.	Clear the error condition at the secondary storage system or S-VOL. If you need to access the S-VOL, release the pair from the primary storage system. If data in the S-VOL has been changed, release the pair from the primary storage system and then re-create the pair by using the Create UR Pairs dialog box. If data in the S-VOL has not been changed, resynchronize the pair from the primary storage system.
S-VOL Failure	P-VOL	The primary storage system detected an error during communication with the secondary storage system or	Check the path status on the DKC Status dialog box (see Remote path status problems on page 292). Clear

Suspend type	Applies to	Description	Corrective action
		detected an I/O error during update copy. In this case, the suspend type for the S-VOL is usually by MCU.	any error conditions at the secondary storage system and the S-VOL. If you need to access the S-VOL, release the pair from the secondary storage system. If data in the S-VOL has been changed, release the pair from the primary storage system and then re-create the pair by using the Create UR Pairs dialog box. If data in the S-VOL has not been changed, resynchronize the pair from the primary storage system.
MCU IMPL	P-VOL, S-VOL	The primary storage system could not find valid control information in its nonvolatile memory during the IMPL procedure. This error occurs only if the primary storage system is without power for more than 48 hours (power failure and fully discharged batteries).	Resynchronize the pair (pairresync) from the primary storage system. The primary storage system performs an initial copy operation in response to the pairresync request, so that the entire P-VOL is copied to the S-VOL.
Initial Copy Failed	P-VOL, S-VOL	The primary storage system suspended this pair during the initial copy operation. The data on the S-VOL is not identical to the data on the P-VOL.	Release the pair from the primary storage system. Clear all error conditions at the primary storage system, P-VOL, secondary storage system, and S-VOL. Restart the initial copy operation by using the Create UR Pairs dialog box.
MCU P/S OFF	S-VOL	The primary storage system suspended all UR pairs because the primary storage system was powered off.	None. The primary storage system automatically resynchronizes these UR pairs when the primary storage system is powered on.

Troubleshooting hardware problems affecting pairs

The following table provides troubleshooting information for hardware failures affecting Universal Replicator operations. In addition to the following conditions, hardware failures that affect cache memory or shared memory can cause UR pairs to be suspended.

Classification	Causes of suspension	SIM	Recovery procedure
Primary or secondary storage system hardware	Hardware redundancy has been lost due to some blockade condition. As a result, one of the following could not complete: primary-secondary storage system communication, journal creation, copy operation, resynchronize operation, staging process, or de-staging process. Journals cannot be retained because some portion of the cache memory or shared memory has been blocked due to hardware failure.	dc0x dc1x dc2x	Depending on the SIM, remove the hardware blockade or failure. Resynchronize the failed volume pairs (pairresync). If a failure occurs during execution of the CCI horctakeover command, S-VOLs in SSWS pair status may remain in the master journal. If these volumes remain, execute the pairresync -swaps command on the S-VOLs whose pair status is SSWS (pairresync is the CCI command for

Classification	Causes of suspension	SIM	Recovery procedure
	<p>The primary storage system failed to create and transfer journals due to unrecoverable hardware failure.</p> <p>The secondary storage system failed to receive and restore journals due to unrecoverable hardware failure.</p> <p>The drive parity group was in correction-access status while the URpair was in COPY status.</p>		resynchronizing pair and -swaps is a swap option). This operation changes all volumes in the master journal to primary volumes. After this operation, resynchronize the pairs.
Communication between the primary and secondary storage systems	<p>Communication between the systems failed because the secondary storage system or network relay devices were not running.</p> <p>Journal volumes remained full even after the timeout period had elapsed.</p>	dc0x dc1x	<p>Remove the failure from the primary and secondary storage systems or the network relay devices.</p> <p>If necessary, increase resources as needed (for example, the amount of cache, the number of paths between primary and secondary storage systems, the parity groups for journal volumes, etc.).</p> <p>Resynchronize the failed pairs.</p>
RIO overload or RIO failure	An unrecoverable RIO (remote I/O) timeout occurred because the system or network relay devices were overloaded. Or, RIO could not be finished due to a failure in the system.	dc2x	<p>Release failed pairs (pairsplit-S).</p> <p>If necessary, increase resources as needed (for example, the amount of cache, the number of paths between primary and secondary storage system, the parity groups for journal volumes, etc.).</p> <p>Re-create failed pairs.</p>
Planned power outage to the primary storage system	The UR pairs were temporarily suspended due to a planned power outage to the primary storage system.	dc8x	No recovery procedure is required. The primary storage system automatically removes the suspension condition when the system is powered on.

Troubleshooting with CCI

When an error has occurred in Universal Replicator pair operation when using CCI, you can identify the cause of the error by referring to the CCI operation log file. The file is stored in the following directory by default:

```
/HORCM/log*/curlog/horcmlog_HOST/horcm.log
```

Where:

* is the instance number.

HOST is the host name.

To identify the error code in the log file, open the CCI log file, and find the error code.

Example: 11:06:03-37897-10413- SSB = 2E31, 3703

Error codes appear on the right of the equal symbol (=). The alphanumeric characters on the left of the comma(,) indicates SSB1 (for example, 2E31), and on the right of the comma (,) indicates SSB2 (for example, 3703).

The following tables describe the CCI error codes for Universal Replicator.

CCI error codes for UR: SSB1 = 2E31, B901, B9E0, B9E1, B9E2, B9E4, D004

Error code (SSB2)	Description
3703	A request of UR Pairresync to change the pair status from HLDE to HOLD was rejected because the PIN data was existed in the journal volume.
3704	A request of UR Paircreate was rejected because the emulation types of the specified master journal and of the restore journal were different.
3705	A request of UR Paircreate or UR Pairresync for delta resync was rejected because the version of the secondary storage system did not support the corresponding command.
3706	A request of UR Paircreate for delta resync was rejected because the specified P-VOL was used as the S-VOL of TrueCopy, and the pair status was not PAIR.
3707	<p>A request of UR Pairresync for delta resync was rejected because of the one of following reasons.</p> <ul style="list-style-type: none"> • The specified P-VOL was the P-VOL of TrueCopy, and the UR pair status was not PAIR. • The specified P-VOL was the S-VOL of TrueCopy, and the UR pair status was not SSWS.
3708	The UR pair cannot be created because the specified P-VOL was being shredded.
3709	A request of UR Paircreate or UR Pairresync for delta resync was rejected because the specifying of the restore journal was incorrect.
370B	The UR pair cannot be resynchronized (DELTAJNL parameter specifying), because the specified P-VOL is not in the either of HOLD or HOLDTRNS status. Or, the UR pair cannot be resynchronized (ALLJNL parameter specifying), because the specified P-VOL is not in the either of HOLD, HOLDTRANS, or NODELTA status.
370C	A request of Paircreate or Pairresync for UR pair or UR delta resync pair was rejected because the status of the specified master journal or restore journal could not be transited, or the status transition was in progress.
371C	A request for a UR Paircreate or UR Pairresync was rejected because the TrueCopy pair was either in the status other than suspending or was not used in the 2DC configuration.
3722	The Paircreate command was rejected because the emulation type of the selected volume is unsupported.
3726 (VSP G1000, G1500, and VSP F1500)	The pair cannot be created because the volume specified as the P-VOL was the system disk.
3728	The Paircreate command was rejected because it was connected with the old model and the specified volume was unsupported.
3729	A request for UR Paircreate was received. However, the pair could not share the volume with TrueCopy because the Disaster Recovery Extended program product was not installed in the primary storage system.

Error code (SSB2)	Description
372B	A pair cannot be created because the secondary storage system does not support the combination of multiple primary and secondary storage systems.
372C	The volume is inaccessible because the P-VOL is blocked.
372D (VSP G1000, G1500, and VSP F1500)	The specified volume is used in the system that consists of multiple primary and secondary storage systems. Therefore the command was rejected because the delta resync operation cannot be executed.
372E	A request to create or resynchronize a pair in the system that consists of multiple primary and secondary storage systems was rejected because the Disaster Recovery Extended program product was not installed in the primary storage system.
3737	The UR pair operation failed because the status of the pair of the other mirror is not settled in the configuration where three UR sites are combined.
3738	A request for pair creation was rejected because the Disaster Recovery Extended program product was not installed in the primary storage system.
3739	The command was rejected because the journal to which the specified S-VOL belongs does not allow the configuration where three UR sites are combined.
373D	<p>A UR pair or a UR pair for delta resync cannot be created. The P-VOL for the pair must meet the following conditions:</p> <ul style="list-style-type: none"> • A consistency group is not shared among multiple local storage systems and remote storage systems. • The volume is not combined with TrueCopy. • The volume is not combined with global-active device. • The volume is not combined with Volume Migration.
373E	The pair operation failed because the status of a mirror in the journal in which the specified S-VOL belongs is other than Initial or Stopped.
3744	<p>A UR pair or a UR pair for delta resync cannot be created. The S-VOL for the pair must meet the following conditions:</p> <ul style="list-style-type: none"> • A consistency group is not shared among multiple local storage systems and remote storage systems. • The volume is not combined with TrueCopy. • The volume is not combined with global-active device. • The volume is not combined with Volume Migration.
3745	A request to create a UR pair between the primary site and the intermediate site in a cascade configuration where three UR sites are combined was received. However, the command was rejected since the journal to which the P-VOL belongs does not allow the configuration.
3747	In the configuration where three UR sites are combined, a request of UR pair resync (journal resync mode) was received. However, since the volume status was being changed, the command was rejected.
3748	The delta resync pair was not created because the status of the pair with the delta resync P-VOL is not PAIR.
3749	<p>The delta resync pair was not created because the status of the pair with the delta resync P-VOL does not meet the following requirements.</p> <ul style="list-style-type: none"> • The volume is the UR P-VOL and the pair status is PAIR, PSUS, PSUE, or SSWS. • The volume is UR S-VOL and the pair status is SSWS.
374B	The pair cannot be created because the volume specified as the P-VOL is used as an external volume for nondisruptive migration and Cache Through is set as the cache mode.

Error code (SSB2)	Description
374D	The pair cannot be created because the volume specified as the P-VOL is used as an external volume for nondisruptive migration and also used as a volume for a Volume Migration pair.
3752	The pair cannot be created because of one of the following: <ul style="list-style-type: none"> • The secondary storage system's microcode version does not support connection with the primary storage system. • The specified S-VOL is being used by TrueCopy.
3754 (VSP G1000, G1500, and VSP F1500)	The pair cannot be created because one of the storage systems does not support the 2DC or 3DC UR function.
3755	The command was rejected because the specified S-VOL is used as an S-VOL in another mirror, and the pair status is not in SSWS status.
3756	The pair cannot be created because the secondary storage system does not support the Path Group ID, which was specified as other than 0.
3759	UR or UR delta resync pair creation failed because the remote storage system does not support the combined configuration of GAD function and UR function.
375A	The specified secondary storage system does not support global storage virtualization.
375B	The specified primary storage system does not support global storage virtualization.
375C	The pair cannot be created because no virtual LDEV ID is set for the volume specified as the P-VOL.
375D	The pair cannot be created because no virtual LDEV ID is set for the volume specified as the S-VOL.
3766	The pair cannot be created because the P-VOL is used by the GAD pair.
3767	The pair cannot be created because the S-VOL is used by the GAD pair.
3768	The pair cannot be created because the P-VOL is a GAD reserve volume.
3769	The pair cannot be created because the S-VOL is a GAD reserve volume.
376A	The internal process to secure tier memory difference has timed out. Wait 5 minutes, and then retry the operation. If this error occurs again, use Performance Monitor to find and resolve the specific problem. If retrying does not work, contact customer support.
376B	The pair cannot be created or resynchronized because the differential bitmap area is not available due to one of the following reasons: <ul style="list-style-type: none"> • Free area for shared memory in the primary storage system is insufficient. • Free area for Dynamic Provisioning pool specified as the P-VOL is insufficient.
37AF (VSP G1000, G1500, and VSP F1500)	Pair creation failed because the volume specified as the P-VOL is a pool volume.
37B2 (VSP G1000, G1500, and VSP F1500)	Pair creation failed because the volume specified as the P-VOL is an external volume of which Data Direct Mapping attribute is enabled.
37B3 (VSP G1000, G1500, and VSP F1500)	Pair creation failed because the attribute of the volume specified as the P-VOL is invalid.

Error code (SSB2)	Description
37B6 (VSP G1000, G1500, and VSP F1500)	Pair creation failed because the Data Direct Mapping attribute of the volume specified as the P-VOL is enabled, and the function of the R-DKC microcode version for mapping external volumes larger than 4 TB is not supported.
37B7 (VSP G1000, G1500, and VSP F1500)	UR pair creation failed because the T10 PI attribute is different between P-VOL and S-VOL.
377B	UR pair creation failed. The P-VOL of the specified UR pair must meet both of the following conditions: <ul style="list-style-type: none"> • The P-VOL of the specified UR pair is the P-VOL of a GAD pair. • The status of the GAD pair to which the P-VOL of the specified UR pair belongs is PAIR.
377C	UR pair creation or UR delta resync pair creation failed because the specified mirror ID is used for a GAD pair.
377D	UR pair creation or UR delta resync pair creation failed because of one of the following: <ul style="list-style-type: none"> • The GAD pair that is combined with the specified P-VOL does not belong to a consistency group. • Another delta resync pair that uses the specified journal or the GAD pair that is combined with UR pair belongs to another CTG.
377E	UR pair creation or UR delta resync pair creation failed because the specified journal is combined with another GAD consistency group.
377F	The UR delta resync pair could not be created, or the UR pair waiting for delta resync could not be resynchronized.
3789	UR delta resync pair creation failed. The P-VOL and S-VOL of the specified UR delta resync pair must meet both of the following conditions: <ul style="list-style-type: none"> • When changing the configuration to use Universal Replicator and global-active device, <ul style="list-style-type: none"> ◦ The P-VOL of the UR delta resync pair is also used as the S-VOL of a GAD pair. ◦ The S-VOL of the UR delta resync pair is not used as the UR pair that is created in another mirror. • When recovering from a failure in a configuration using UR and GAD, <ul style="list-style-type: none"> ◦ The P-VOL of the UR delta resync pair is also used as the P-VOL of a GAD pair. ◦ The S-VOL of the UR delta resync pair is also used as the UR pair that is created in another mirror.
378A	UR pair creation failed. The following two volumes that are combined with the P-VOL and S-VOL of the specified UR pair must match: <ul style="list-style-type: none"> • The S-VOL of the GAD pair that is combined with the P-VOL of the specified UR pair. • The P-VOL of the UR delta resync pair that is combined with the S-VOL of the specified UR pair.
378B	Delta resync failed because the number of UR pairs and UR delta resync pairs are different in the restore journal. Due to this failure, the UR delta resync pairs that are not combined with UR pairs are deleted automatically.
378C	Delta resync failed because the status of the GAD pair that is combined with the specified P-VOL is not SSWS.
378D	Resynchronization failed because of one of the following: <ul style="list-style-type: none"> • The GAD pair status is not PAIR, COPY, PSUS, PSUE, or SSWS. • The status of the UR delta resync pair is not HLDE.

Error code (SSB2)	Description
37A0	UR delta resync pair creation failed. The P-VOL of the specified UR delta resync pair must meet one of the following conditions: <ul style="list-style-type: none"> The specified P-VOL is the S-VOL of the GAD pair, and the pair status is PAIR. The specified P-VOL is the P-VOL of the GAD pair, and the I/O mode is Block.
37A1	UR delta resync pair creation failed. The following two volumes that are combined with the P-VOL and S-VOL of the specified UR delta resync pair must match: <ul style="list-style-type: none"> The S-VOL of the GAD pair that is combined with the P-VOL of the specified UR delta resync pair. The P-VOL of the UR pair that is combined with the S-VOL of the specified UR delta resync pair.
37AE	In a cascade configuration where the three UR sites are combined, the request to create a UR pair between the primary and intermediate sites was received. However, the command was rejected because another mirror to which the intermediate site belongs in the journal is used as the P-VOL for the UR pair between the intermediate and secondary sites and also the volume between the primary and intermediate sites is DP-VOL.
37AF (VSP Gx00 models and VSP Fx00 models)	Pair creation failed because the volume specified as the P-VOL is a pool volume.
37B2 (VSP Gx00 models and VSP Fx00 models)	Pair creation failed because the volume specified as the P-VOL is an external volume of which data direct mapping attribute is enabled.
37B3 (VSP Gx00 models and VSP Fx00 models)	Pair creation failed because the attribute of the volume specified as the P-VOL is invalid.
37B6 (VSP Gx00 models and VSP Fx00 models)	Pair creation failed because the data direct mapping attribute of the volume specified as the P-VOL is enabled, and the function of the R-DKC firmware version for mapping external volumes larger than 4 TB is not supported.
37B7 (VSP Gx00 models and VSP Fx00 models)	UR pair operation failed. T10 PI attribute settings of the P-VOL and of the S-VOL are different.
8C13 (VSP G1000, G1500, and VSP F1500)	Paircreate or Pairresync is not available, because the specified journal is dedicated to a UR-TC combination (2DC), and the MU# is 0.
8C19	The pair cannot be created because the specified CTG ID is out of range of supporting.
8C1A	The pair cannot be created or resynchronized because the specified journal ID is incorrect.
8C1B	The pair cannot be created because the specified journal ID is out of range of supporting.
8C1E	The pair cannot be created because of the one of following reasons: <ul style="list-style-type: none"> The microcode version of the specified primary storage system does not support connection with the specified secondary storage system. The specified primary storage system does not support connection with the specified secondary storage system.

Error code (SSB2)	Description
8C1F	The pair cannot be created because the virtual ID is not set for the specified S-VOL.
8C20	The request to update options was rejected because the specified journal ID or mirror ID is incorrect.
8F00	The pair cannot be created because the specified volume was an external volume.
8F04	The command was rejected because an internal logical error occurred.
8F10	The pair operation failed because the specified P-VOL is one of the following: <ul style="list-style-type: none"> • An SI S-VOL that is not in PSUS status • An SI volume in Reverse Copy status
8F11	The pair cannot be created. The processing of volume migration could not be stopped because the P-VOL was being migrated by Volume Migration.
8F17	The pair cannot be created because the specified volume was in the state of online from the host.
8F18	The pair cannot be created because the specified volume was used in a pair on another program product.
8F19	The pair cannot be created because the emulation type of the specified volume was unusable.
8F1B	The pair cannot be created because the specified P-VOL is already paired.
8F1C	The pair cannot be created because the specified P-VOL is not in the PSUS status.
8F1E (VSP Gx00 models and VSP Fx00 models)	The Universal Replicator pair cannot be created because cache or shared memory is undergoing restoration.
8F1F (VSP Gx00 models and VSP Fx00 models)	The Universal Replicator pair cannot be created because cache or shared memory is blocking.
8F21	The pair cannot be created or resynchronized due to one of the following reasons. <ul style="list-style-type: none"> • The specified volume was a TC P-VOL. • The specified volume was a TC S-VOL belonging to a consistency group consisting of multiple primary and secondary storage systems. • Unavailable configuration of the status transition.
8F24	The pair cannot be created because a path between the devices was not created.
8F25	The pair cannot be created or resynchronized because PIN was existed in the specified volume.
8F28	The pair cannot be created or resynchronized because it could not access to the specified P-VOL or S-VOL.
8F29	The pair cannot be created because the specified master journal was unusable.
8F2A (VSP G1000, G1500, and VSP F1500)	The pair cannot be created because the specified P-VOL is a Flash Copy S-VOL.
8F2B	The pair cannot be created because the protect attribute of the Data Retention Utility was set for the specified P-VOL.
8F33	The pair cannot be created because the specified volume was used in a pair on the TrueCopy or the ShadowImage.

Error code (SSB2)	Description
8F35	The command was rejected because the physical volume with the specified P-VOL is blocked.
8F38	The following programs for OPEN systems might not be installed, or the licenses of them might be expired. Confirm settings for: <ul style="list-style-type: none"> • TrueCopy • Universal Replicator
8F39	The pair cannot be created because the program product of UR was not installed.
8F46	The pair cannot be created because cache CL2 is in abnormal status.
8F47	The pair cannot be created because cache CL1 is in abnormal status.
8F4D	The pair cannot be created or resynchronized due to the following contributing factors: <ul style="list-style-type: none"> • A journal is not registered in the secondary storage system. • A volume in the journal which is registered in the secondary storage system is blocked.
8F50	The pair cannot be created or resynchronized because the load of the processing was high. Wait about 5 minutes, and then retry the operation.
8F53	The pair cannot be created because the status of the configuration could not be transited.
8F58	The pair cannot be created or resynchronized because of the one of following reasons. <ul style="list-style-type: none"> • The pair status of the specified S-VOL differed from the one of P-VOL. • The state of restore journal differed from the state of master journal.
8F67	The pair cannot be created because the specified secondary storage system did not support the external volume.
8F6D	The pair cannot be created because the specified volume was a command device.
8FEA	The pair cannot be created because the P-VOL is used for Thin Image.
8FEC	The pair cannot be created because the P-VOL is used for Thin Image.
9100	The command cannot be executed because user authentication is not performed.
B91B	The required shared memory for operating UR is not installed.
B992	The information of the consistency group cannot be retrieved, because Universal Replicator was not installed.
B9C0	The source of command device has run out. Set to OFF the command device and to ON again from the LUN Manager.

CCI error codes for UR: SSB1 = B9E1

Error code (SSB2)	Description
B901	The command was rejected because the specified device is a command device.

CCI error codes for UR: SSB1 = B9E2

Error code (SSB2)	Description
B901	The pair cannot be deleted because the mirror ID is invalid.

CCI error codes for UR: SSB1 = B901, B9E0, B9E1, B9E2, B9E4, D004

Error code (SSB2)	Description
B900	A status of UR pair was acquired at the time of unavailable to use the UR during the power-on. Retry the operation.
B902	The command was rejected because the mirror ID is invalid.
B907	The command was rejected because the volume was unpaired.
B909	The command was rejected because the mirror ID is invalid.
B90A	The S-VOL hide mode is not supported.
B90D	The command was rejected because the UR program product is not installed.
B90E	The command was rejected because the path is not set between the systems.
B910	The settings of the journal option could not be updated.
B912	The command was rejected because no journal was registered.
B913	The command was rejected because the system configuration does not allow these operations.
B920	The pair cannot be created because the system identifier is not correct (left-most number in the 6-digit serial number).
B94B	The command was rejected because the UR configuration was changed. Check the status of the UR pair.
B9F8	The command was rejected because no journal was registered.
DB02	A request for status change was rejected because the status could not be changed (for example, the pair volumes were not unpaired when the Paircreate was requested, or were in a status other than PSUS when the Pairresync was requested).
DB03	A request of UR Pair status transition was rejected because the pair was in the state of Suspending or Deleting.
DB07	UR pair status cannot be transited during the power-on processing.
DB08	UR pair status cannot be transited during the power-off processing.
DB0C	The command was rejected because the specification was volume instead of group.
E843	The command was rejected because the CLPR ID of the specified volume differed from the CLPR ID of the journal.
E846 (VSP G1000, G1500, and VSP F1500)	The command was rejected because the specified volume belongs to the journal that is contained in the UR-TrueCopy combination (2DC) configuration in the intermediate site.
E847 (VSP G1000, G1500, and VSP F1500)	An operation request for the journal, which was used in the system that consists of single primary and secondary storage system, was rejected because the specified volume is defined to be used in the system that consists of multiple primary and secondary storage systems.

Error code (SSB2)	Description
E848 (VSP G1000, G1500, and VSP F1500)	An operation request for the journal, which was used in the system that consists of multiple primary and secondary storage systems, was rejected because the specified volume is defined to be used in the system that consists of single primary and secondary storage system.
E866	The specified consistency group ID is already used.
E869	The operation cannot be performed because the specified restore journal was used in another mirror and the mirror status was Halting or Stopping. Retry the operation after the mirror status is changed to a status other than Halting or Stopping.
E86E (VSP Gx00 models and VSP Fx00 models)	You cannot use as data volume because shared memory is not implemented for specified LDEV number.
E871	The command was rejected because the path between the storage devices for the both-way was not defined. Check whether the bidirectional normal path was defined or not.
E878	The command was rejected because the data volumes of 3390-9A and other than 3390-9A coexist in the specified journal.
E87B	The command was rejected because the specified journal was unregistered.
E87C	Journal volume is not registered in the specified journal.
E87D	The command was rejected because the specified volume was not for the UR pair.
E87E	The command was rejected because the specified P-VOL or S-VOL was a journal volume.
E880	The command was rejected because the emulation type was different between the specified P-VOL or S-VOL and the journal volume.
E881	The command was rejected because of the power-on processing.
E882	The command was rejected because the emulation type of the specified master journal or the restore journal was invalid.
E883	The specified mirror ID number or the CTG ID differs from the registered mirror ID number or the CTG ID.
E888	The command was rejected because a volume in the specified journal was used for maintenance.
E889	The command was rejected because the specified journal was already used in another UR's mirror ID.
E890	<p>The command was rejected because of one of following:</p> <ul style="list-style-type: none"> • The specified volume is registered in another journal. • The specified volume is registered in the same mirror of the same journal. • The volume specified as the S-VOL is registered in another mirror of the same journal. • When creating a pair using the journal which is not supported in the system of the configuration combined where three UR sites are combined, a pair creation command for another mirror was received in the same journal.
E891	The command was rejected because the number of pairs that are registered in the specified master journal or restore journal was already reached the maximum number.
E894 (VSP G1000, G1500, and VSP F1500)	When creating a pair using journal in the configuration where three UR sites are combined, a request of pair creation of the third mirror was received in the same journal, so the command was rejected.

Error code (SSB2)	Description
E897	A pair creation request was received, but the command was rejected because of one of the following reasons: <ul style="list-style-type: none"> The specified primary and secondary journals do not permit the configuration combining three UR sites. The specified restore journal is already used as a restore journal of another mirror. The paired journal of the specified mirror is already used by another mirror.
E898	The command was rejected because the specified secondary journal is already a secondary journal in another mirror.
E89A	The command was rejected because the path between the storage devices for the both-way was not defined. Check whether the bidirectional normal path was defined or not.
E89B	The command was rejected because the specified master journal or the restore journal remembered the state of connection with another system in the past. Specify another journal, or delete the journal once, and then retry the registration again.
E8A2	The command was rejected because the Serial Number, model, or Path Group ID of the specified secondary storage system is wrong.
E8A6	The specified journal ID is unregistered.
E8A7	Journal volume is unregistered on the specified journal.
E8A8	The command was rejected because the specified volume was not for a UR pair or was a volume of another journal.
E8A9	UR copy pair cannot be suspended because of the power-on processing.
E8B6 (VSP G1000, G1500, and VSP F1500)	The command was rejected because the mirror ID of the specified restore journal was already used.
E8B8	The command was rejected because the volume in the specified journal was used for maintenance.
E8F7	The command was rejected because there are multiple journals in the specified consistency group.
E8FB	A logic error occurred in the system, and the command was rejected.
EA00	The command was rejected because the specified P-VOL was already used as an S-VOL.
EA01	The command was rejected because the specified P-VOL was already used by another UR pair.
EA02	The command was rejected because the specified S-VOL was used as the P-VOL.
EA03	The command was rejected because the specified P-VOL was already used by another UR pair.
EA07	The command was rejected because the number of the UR pair registrations in the primary journal exceeds the upper limit.
EA08	The command was rejected because the number of UR pair registrations in the secondary journal exceeds the upper limit.
EA09	The command was rejected because the state of master journal was other than Initial, Active, or Stopped.
EA0A	The command was rejected because the state of restore journal was invalid.
EA12	The command was rejected because the specified S-VOL was not in SSWS status.

Error code (SSB2)	Description
EA13	The command was rejected because the request was received for the S-VOL as the P-VOL.
EA15	The command was rejected because the request was received for the P-VOL as the S-VOL.
EA18	The command was rejected because the pair status was not PSUS.
EA19	The command was rejected because the state of journal was not Stopped.
EA1B (VSP G1000, G1500, and VSP F1500)	The command was rejected because the journal could not execute the suspend transition, that is, the journal was in HLDE or PSUE status.
EA1C	The command was rejected because the specified secondary journal was not in the Stopped status.
EA1E	The command was rejected because the request was received for the S-VOL as the P-VOL.
EA20	The command was rejected because the request was received for the P-VOL as the S-VOL.
EA22	The command was rejected because the state of journal was not Stopped.
EA25	The command was rejected because the state of S-VOL was not SSWS.
EA29	The command was rejected because the state of master journal was other than Active or Stopped.
EA2C	The command was rejected because the state of restore journal was other than Active or Stopped.
EA33	The command was rejected because the state of mater journal was other than Active.
EA36	The command was rejected because the state of restore journal was other than Active.
EA37	The pair suspend request was received but was rejected because the restore journal status was other than Active or Stopped.
EA3A	The command was rejected because the specified S-VOL was in the state of status transition.
EA3B	The command was rejected because the specified S-VOL was in the state of Suspending.
EA40	The command was rejected because the desired capacity exceeded the charging capacity of the primary storage system's program product.
EA41	The command was rejected because the desired capacity exceeded the charging capacity of the secondary storage system's program product.
EA46 (VSP G1000, G1500, and VSP F1500)	In the intermediate site of the cascade configuration where three UR sites are combined, the UR pair deletion and suspend command were rejected because the status of the specified journal which is connected to the mirror of the specified journal is Active.
EA89	The command was rejected because the paircreate or pairresync cannot run with the journal's attribute or mirror status.
EA8A	The command was rejected because the pair status could not be changed during the power-on or power-off processing.
EA8B	The command was rejected because the specified volume is used in the system that consists of multiple primary and secondary storage systems.

Error code (SSB2)	Description
EA92 (VSP G1000, G1500, and VSP F1500)	The command was rejected because the microcode was being replaced.
EA95	The command was rejected because the volume specified for the P-VOL was initializing the pool of Dynamic Provisioning.
EA9F (VSP G1000, G1500, and VSP F1500)	In the configuration where three UR sites are combined, a request of UR pair resync (journal resync mode) was received. However, since the specified journal did not exist, or no pair existed in the specified journal, the command was rejected.
EAA2	The command was rejected because the desired capacity exceeded the charging capacity of the primary storage system's UR. Check the license capacity as well as the related program product.
EAA3	The command was rejected because the desired capacity exceeded the charging capacity of the secondary storage system's TrueCopy. Check the License capacity as well as the related Program product.
EAA5	The command was rejected because the desired capacity exceeded the charging capacity of the secondary storage system's UR. Check the license capacity as well as the related program product.
EAA6	The command was rejected because the desired capacity exceeded the charging capacity of the primary storage system's TrueCopy. Check the license capacity as well as the related program product.
EAAB (VSP G1000, G1500, and VSP F1500)	In the configuration where three UR sites are combined, a request of UR pair resync (journal resync mode) was received. However, the command was rejected because the specified option is incorrect.
EAB6	The pair cannot be created or resynchronized because the differential bitmap area is not available due to one of the following reasons: <ul style="list-style-type: none"> • Free area for shared memory in the primary system is insufficient. • Free area for Dynamic Provisioning pool specified as the P-VOL is insufficient.
EAB7	The paircreate operation failed because no extended shared memory is installed in the primary storage system. Install extended shared memory in the primary storage system and then repeat the operation.
EAB8	The pair cannot be created or resynchronized because the differential bitmap area is not available due to one of the following reasons: <ul style="list-style-type: none"> • Free area for shared memory in the secondary system is insufficient. • Free area for Dynamic Provisioning pool specified as the S-VOL is insufficient.
EAB9	The paircreate operation failed because no extended shared memory is installed in the secondary storage system. Install extended shared memory in the secondary storage system and then repeat the operation.
EABC	The pair operation failed because shared memory is not installed in the specified LDEV number.
EAD0 (VSP G1000, G1500, and VSP F1500)	The command was rejected because the delta resync function was unsupported.
EAE5	The command was rejected because the specified P-VOL or S-VOL is in the process of having the capacity changed by Dynamic Provisioning.
EAF6	The command was rejected because the pair was in the state that was unavailable to transit.
EB24	The UR delta resync pair cannot be created because the specified UR S-VOL is in either one of the following statuses:

Error code (SSB2)	Description
	<ul style="list-style-type: none"> The volume cannot be used as the UR volume for the delta resync operation. The status of the UR pair is other than PAIR.
EB25	<p>The UR delta resync pair cannot be created because the specified UR S-VOL is in either one of the following statuses:</p> <ul style="list-style-type: none"> The volume cannot be used as the UR volume for the delta resync operation. The status of the UR pair is the status other than PAIR or SUSPEND.
EB27	UR pair creation failed because the GAD S-VOL that is combined with the specified P-VOL is not combined with the UR delta resync pair.
EB28	The command was rejected because the Disaster Recovery Extended program product was not installed in the secondary storage system.
EB29	The command was rejected because the delta resync settings are configured to the primary and secondary storage systems.
EB2D	The command was rejected because shared memory for operating UR is not installed.
EB2F (VSP G1000, G1500, and VSP F1500)	The command was rejected because the specified UR pair was used in the system that consists of multiple primary and secondary storage systems.
EB30	The command was rejected because the specified mirror ID was invalid.
EB37	The command was rejected because the microcode is being exchanged or the micro program exchange operation is suspended.
EB45 (VSP G1000, G1500, and VSP F1500)	The specified UR pair cannot execute the takeover because the specified UR pair belongs to the journal that dedicated UR and TrueCopy combination (2DC configuration).
EB48	<p>The UR delta resync pair cannot be created due to one of the following reasons:</p> <ul style="list-style-type: none"> The P-VOL of the UR pair is different from the P-VOL of the TrueCopy pair. The serial number of the primary storage system that is recognized by the P-VOL and S-VOL is different.
EB49 (VSP G1000, G1500, and VSP F1500)	The command was rejected because the secondary storage system did not support the delta resync function.
EB4C	A pair cannot be created because the restore journal was not registered.
EB4D	A pair cannot be created because the master journal was not registered.
EB4F (VSP G1000, G1500, and VSP F1500)	The UR pair cannot be created because the timer type of master journal and restore journal is different.
EB50	<p>The command was rejected because the specified S-VOL is in one of the following conditions:</p> <ul style="list-style-type: none"> Protected Cannot be used A ShadowImage S-VOL A ShadowImage reserved volume A Volume Migration reserved volume Used by Universal Replicator
EB51	The command was rejected because PIN data existed in the specified S-VOL.
EB52	The command was rejected because the specified S-VOL cannot be accessed.
EB53	The command was rejected because the physical volume with the specified S-VOL is blocked.

Error code (SSB2)	Description
EB54	The pair cannot be created because the specified S-VOL is used as an external volume mapped for online data migration.
EB57	The command was rejected because the specified S-VOL was online from the host.
EB58	The command was rejected because the specified journal volume or S-VOL was reserved or being used in the storage system. Check the status of the volume.
EB59	The command was rejected because the specified S-VOL was being migrated by Volume Migration. Check the status of the volume.
EB5B	The command was rejected because the access attribute was set to the specified P-VOL or S-VOL by the Data Retention Utility.
EB5C	The command was rejected because an internal logical error occurred.
EB5E	The command was rejected because the S-VOL was already paired.
EB5F	The command was rejected because the program product of UR was not installed in the secondary storage system.
EB60	The command was rejected because the P-VOL capacity is not the same as the S-VOL's.
EB61	The command was rejected because the path between the primary and the secondary storage systems was not valid.
EB62	The command was rejected because the specified P-VOL was a command device.
EB63	The command was rejected because the restore journal was already linked with another journal.
EB64	The command was rejected because the desired capacity exceeded the charging capacity of the program product.
EB65	The command was rejected because of the abnormal end which is related to the charging capacity of the program product.
EB66	The command was rejected and the retry processing was ordered because P-VOL SUSPENDING was detected when the CCI horctakeover (resync) command was executed.
EB6B (VSP G1000, G1500, and VSP F1500)	The command was rejected because a pair is already created with the specified S-VOL by using Compatible FlashCopy® V2.
EB6C	<p>The UR pair create processing was doubly executed:</p> <ul style="list-style-type: none"> • There are no problems if the initial copy operation is restarted when the primary storage system is powered off. • There are no problems if a UR pair is created when the primary storage system is reset.
EB6E	The command was rejected because the UR program product was not installed in the primary storage system.
EB70	The command was rejected because the specified S-VOL is assigned to a copy pair of other program products.
EB73	The command was rejected because the specified S-VOL is the system disk.
EB74 (VSP G1000, G1500, and VSP F1500)	The command was rejected because all mainframe connection CHAs are blockaded.
EB78	The command was rejected because the specified data volume is a command device.

Error code (SSB2)	Description
EB79	The command was rejected because the specified data volume is online.
EB7A	The command was rejected because the journal cache of the restore journal was remained.
EB7D	The command was rejected because the specified S-VOL is an external volume.
EB7E	<p>The pair operation failed because the specified S-VOL is in one of the following statuses.</p> <ul style="list-style-type: none"> • The specified S-VOL is being used for a ShadowImage pair. • The specified S-VOL is a reserved volume. • UR P-VOL and S-VOL are DP-VOL, and the specified S-VOL is being used as ShadowImage P-VOL. • UR P-VOL and S-VOL are DP-VOL, and the specified S-VOL is the source volume of Volume Migration. • UR P-VOL and S-VOL are DP-VOL, and the specified S-VOL is being used as Thin Image P-VOL.
EB7F	The command was rejected because the emulation type of the specified S-VOL was unsupported.
EB80	The command was rejected because the specified volume was the V-VOL or the pool-VOL. Check the status of the volume.
EB87	The command was rejected because the path from the secondary storage system to the primary storage system is not set, or the volume used as the S-VOL is not paired.
EB88	<p>The command was rejected because of one of the following:</p> <ul style="list-style-type: none"> • The specified S-VOL was being used as a ShadowImage S-VOL. • The specified S-VOL was Not Ready, which means that the data drive cannot be used.
EB89	The command was rejected because the emulation types of the specified P-VOL and S-VOL were not the same.
EB8A	<p>The UR pair could not be created because of one of the following statuses:</p> <ul style="list-style-type: none"> • The emulation type of the master journal and restore journal you specified is different. • If you are changing the configuration to use both UR and global-active device, the P-VOL of the UR pair for delta resync and the S-VOL of the global-active device pair do not match.
EB8E	The pair cannot be created because the S-VOL is in a LUSE configuration.
EB94	The command was rejected because the specified pair could not transit the status.
EB9F	The command was rejected because the specified S-VOL was not mounted on the secondary storage system.
EBA0	The command was rejected because the specified S-VOL was not mounted on the secondary storage system.
EBA7	<p>The command was rejected because the volume specified for the secondary volume was in either one of the following status.</p> <ul style="list-style-type: none"> • Increasing the capacity by Dynamic Provisioning. • Releasing the page of Dynamic Provisioning. • Initializing the pool of Dynamic Provisioning. • The Data Direct Mapping attribute of Dynamic Provisioning which is not supported by a storage system in the primary site is enabled.

Error code (SSB2)	Description
EBAF	The command was rejected because the license capacity of the Data Retention Utility in the secondary storage system exceeds the setting value. Check the license capacity setting for Data Retention Utility in the secondary storage system.
EBC6 (VSP G1000, G1500, and VSP F1500)	The command was rejected because the specified UR S-VOL was used by either ShadowImage or Compatible FlashCopy® V2.
EBCA	<p>The command was rejected because the journal restore operation is in progress in the UR pair through another mirror ID.</p> <ul style="list-style-type: none"> • If the UR pair with another mirror ID is in Suspending status, re-issue the request when the pair status is changed to the Suspend status. • If the UR pair with another mirror ID is in the PAIR status, reissue the request after a while.
EBCE (VSP G1000, G1500, and VSP F1500)	The command was rejected because un-updated differential data exists in the specified S-VOL.
EBCF	The UR Pairresync (journal resync mode that forcibly copies all data) was received because of the UR Pairresync (delta resync) failed. The command was rejected because the UR pair was not in HOLD status.
EBD9	The command was rejected because the desired capacity exceeded the charging capacity of the secondary storage system's TrueCopy. Check the license capacity as well as the related program product.
EBDB	The command was rejected because the desired capacity exceeded the charging capacity of the secondary storage system's UR. Check the license capacity as well as the related program product.
EBDC	The command was rejected because the processing load of the storage system is heavy. Execute the command again after a while.
EBE0	The command was rejected because the specified S-VOL is already used in a UR delta resync pair.
EBE1	The command was rejected because the all S-VOLs of the specified restore journal were not the another UR's S-VOLs.
EBE2	<p>The resynchronization of the UR delta resync pair was rejected due to one of the reasons. Perform UR Pairresync (journal resync mode that forcibly copies all data):</p> <ul style="list-style-type: none"> • Update data of TrueCopy (master journal of the UR delta resync pair operation) is inconsistent with the update data of the restore journal of the UR pair. • Host I/O is updated for the UR S-VOL.
EBE5	The command was rejected because the journal volume of specified restore journal was blocked.
EBF3 (VSP G1000, G1500, and VSP F1500)	The command was rejected because the split time of the ATTIME Suspend function is restored.
EBFD	The command was rejected because the specified restore journal was not registered.
F908	<p>The pair cannot be created because of one of the following conditions regarding the specified P-VOL or S-VOL:</p> <ul style="list-style-type: none"> • Virtual access mode is disabled for the volume registered in the mirror, but is enabled for the specified volume.

Error code (SSB2)	Description
	<ul style="list-style-type: none"> Virtual access mode is enabled for the volume registered in the mirror, but is disabled for the specified volume. The specified volume whose virtual access mode is enabled has an incorrect virtual system serial number or model.
F909	<p>The pair cannot be created because of one of the following conditions regarding the specified P-VOL or S-VOL:</p> <ul style="list-style-type: none"> Virtual access mode is disabled for the volume registered in the journal group, but is enabled for the specified volume. Virtual access mode is enabled for the volume registered in the journal group, but is disabled for the specified volume. The specified volume whose virtual access mode is enabled has an incorrect virtual system serial number or model.
F90A	The pair cannot be created because the virtual LDEV ID is not set for the volume specified as the P-VOL.
F90C	The pair or delta resync pair cannot be created because the specified journal does not match the journal associated with the GAD CTG.

CCI error codes for Universal Replicator: SSB1 = B9E2

Error code (SSB2)	Description
B9E0	The command was rejected because the function for deleting pairs forcibly is not supported.

CCI error codes for UR: SSB1 = B9FE

Error code (SSB2)	Description
B902	Journal volumes are not registered in the specified journal.

CCI error codes for UR: SSB1 = B912

Error code (SSB2)	Description
B96D	The command was rejected because the volume status is SMPL.

CCI error codes for UR: SSB1 = B980

Error code (SSB2)	Description
B901 (VSP Gx00 models and VSP Fx00 models)	The command was rejected because the specified port is for NAS Platform (system LU).

Error code (SSB2)	Description
B903 (VSP Gx00 models and VSP Fx00 models)	The command was rejected because the selected resource belongs to NAS_Platform_System_RSG.

Service information messages (SIMs)

When service is required, storage systems generate service information message (SIMs). SIMs are generated by the channel and storage path microprocessors and by the SVP. All SIMs related to Universal Replicator processing are reported by the SVP. SIMs are classified according to the following severity levels: service, moderate, serious, or acute.

The following figure shows a typical 32-byte SIM. The six-digit reference code consists of bytes 22, 23, and 13. The reference code identifies the possible error and the severity level. The SIM type (byte 28) indicates the component that experienced the error. When the value of byte 22 is 21, the SIM is a control unit SIM. When the value of byte 22 is dx (where x is an arbitrary character), the SIM is a device SIM.

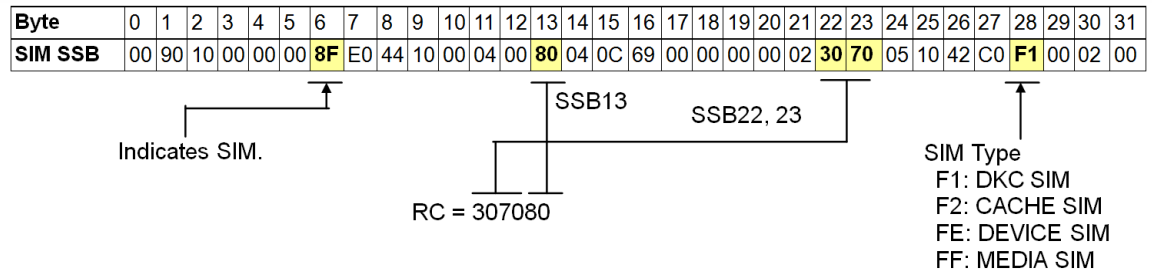

The SIMs are displayed in the Alert tab of the Storage System window of Device Manager - Storage Navigator. If SNMP is installed and operational, each SIM results in an SNMP trap being sent to the appropriate hosts. Each time a SIM is generated, the amber Message LED on the control window (under the Ready and Alarm LEDs) turns on as an additional alert for the user.

For details about SNMP operations, see the *System Administrator Guide* for your storage system. For details about SIM reporting, see the *Hardware Guide* for your storage system.

When a UR pair is split by the user or suspended due to an error condition, a SIM is issued by the primary storage system, secondary storage system, or both.

- SIMs generated by the UR primary storage system include the device ID of the P-VOL (byte 13).
- SIMs generated by the UR secondary storage system include the device ID of the S-VOL (byte 13).

SIM reference code tables

The following tables list the SIM reference codes related to Universal Replicator operations. To clear UR-related SIMs from the SVP, contact customer support.

The following table lists and describes the SIMs that require intervention.

Table 5 SIMs requiring intervention

Reference code		Severity	Description	System generating the SIM	SVP log file
Byte 22	Byte 23				
21	80	Moderate	A remote path is blocked due to failure.	Primary, Secondary	SIM log
dc	0x	Serious	The P-VOL has been suspended. Path recovery is impossible.	Primary	SIM log
dc	1x	Serious	The P-VOL has been suspended. A failure has been detected in the primary storage system.	Primary	SIM log
dc	2x	Serious	The P-VOL has been suspended. A failure has been detected in the secondary storage system.	Primary	SIM log
dc	4x	Serious	The P-VOL has been suspended. The pair has been suspended at the secondary storage system.	Primary	SIM log
dc	5x	Serious	The P-VOL has been suspended. A pair has been released at the secondary storage system.	Primary	SIM log
dc	6x	Serious	The S-VOL has been suspended. Path recovery is impossible.	Primary	SIM log
dc	7x	Serious	The S-VOL has been suspended. A failure has been detected in the secondary storage system.	Secondary	SIM log
dc	9x	Serious	A delta resync P-VOL has been suspended. A failure has been detected in the primary storage system.	Primary	SIM log
dc	ax	Serious	A volume used in a P-VOL that is configured in a multiple primary and secondary storage system combination has been suspended.	Primary	SIM log

Reference code		Severity	Description	System generating the SIM	SVP log file
Byte 22	Byte 23				
			A failure has been detected in other primary and secondary storage systems.		
dc	f1	Serious	The UR Read JNL was interrupted for five minutes. (A failure in the MCU was detected.)	Secondary	SIM log
dc	f3	Serious	The UR Read JNL was interrupted for five minutes. (A failure in the RCU was detected.)	Secondary	SIM log

The following table lists and describes SIMs that do not need immediate intervention but might require intervention later.

Table 6 SIMs for expected status change, no intervention

Reference code		Severity	Description	System generating the SIM	SVP log file
Byte 22	Byte 23				
dc	e0	Moderate	UR M-JNL Meta overflow warning	Primary	SIM log
dc	e1	Moderate	UR M-JNL Data overflow warning	Primary	SIM log
dc	e2	Moderate	UR R-JNL Meta overflow warning	Secondary	SIM log
dc	e3	Moderate	UR R-JNL Data overflow warning	Secondary	SIM log
dc	f0	Moderate	The UR Read JNL was interrupted for one minute. (A failure in the MCU was detected.)	Secondary	SIM log
dc	f2	Moderate	The UR Read JNL was interrupted for one minute. (A failure in the RCU was detected.)	Secondary	SIM log
dc	f4	Moderate	UR M-JNL Meta overflow warning in URxUR multi-target configuration	Primary	SIM log
dc	f5	Moderate	UR M-JNL Data overflow warning in URxUR multi-target configuration	Primary	SIM log

The following table lists and describes service-level SIMs that report expected status changes and require no user intervention.

Table 7 Service SIMs for expected status changes, no intervention required

Reference code		Severity	Description	System generating the SIM	SVP log file
Byte 22	Byte 23				
21	81	Service	The remote path is restored.	Primary, Secondary	SSB log
d8	0x	Service	A volume to be used by UR was defined.	Primary, Secondary	SIM log
d8	1x	Service	A volume used by UR began copying.	Primary, Secondary	SIM log

Reference code		Severity	Description	System generating the SIM	SVP log file
Byte 22	Byte 23				
d8	2x	Service	A volume used by UR completed copying.	Primary, Secondary	SIM log
d8	3x	Service	A volume used by UR received a request for suspension.	Primary, Secondary	SIM log
d8	4x	Service	A volume used by UR completed a suspension transaction.	Primary, Secondary	SIM log
d8	5x	Service	A volume used by UR received a request for deletion.	Primary, Secondary	SIM log
d8	6x	Service	A volume used by UR completed a deletion transaction.	Primary, Secondary	SIM log
d8	7x	Service	A volume to be used by UR was defined (placed in PSUS immediately).	Primary, Secondary	SIM log
d8	8x	Service	A delta resync volume to be used by UR was defined.	Primary	SIM log
d8	9x	Service	A delta resync volume used by UR was redefined.	Primary	SIM log
d9	zx	Service	A change to an S-VOL was received from the MCU.	Secondary	SIM log
da	zx	Service	A change to an S-VOL was received from the RCU.	Secondary	SIM log
dc	8x	Service	A volume used by an S-VOL was suspended (PS OFF on the MCU was detected).	Secondary	SIM log

Completing SIMs

When the cause of the SIMs has been resolved, you need to complete the SIMs to change the SIM status to Completed.



Note: Performing this task completes all uncompleted SIMs for both UR and URz operations. If the cause of any of the SIMs has not been resolved, new SIMs will be issued.

Before you begin

- Required role: Storage Administrator (System Resource Management)

Procedure

1. Resolve the cause of the SIM.
2. Open the **Complete SIMs (UR)** window.
In Device Manager - Storage Navigator:
 - a. From the Device Manager - Storage Navigator menu, click **Actions**.
 - b. Click **Remote Replication > Complete SIMs (UR)**.

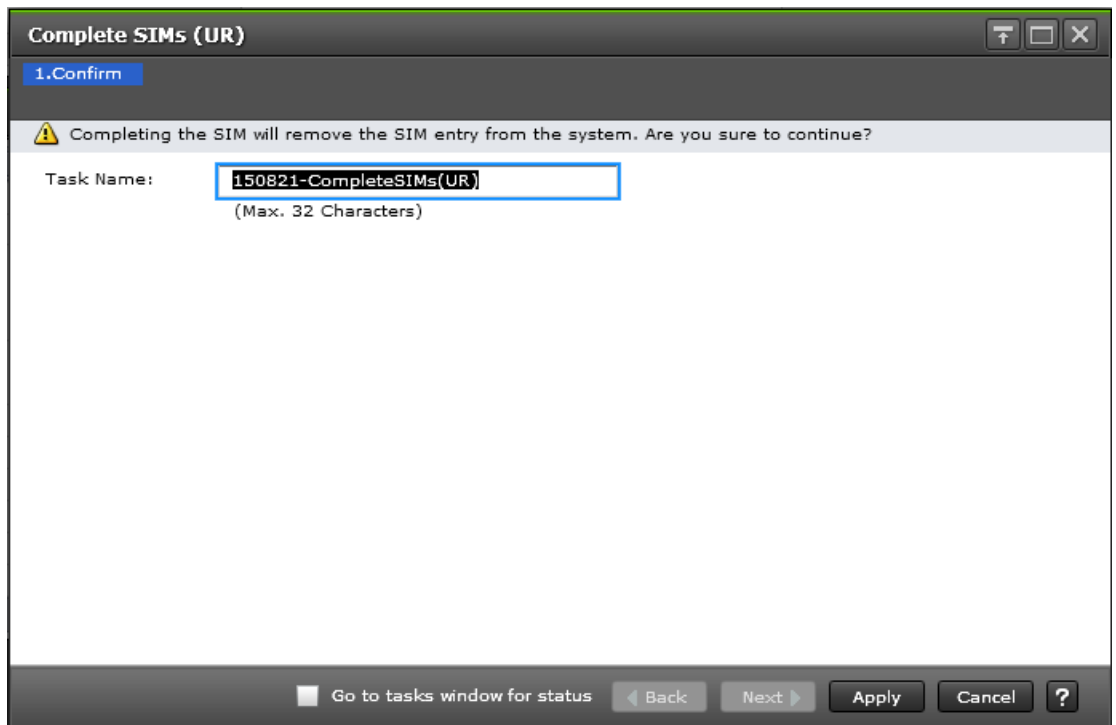

3. If desired, select **Go to tasks window for status**.

4. Click **Apply**.

If you selected **Go to tasks window for status**, the **Tasks** window is displayed.

Notification of suspension due to an error (multiple primary and secondary systems)

When multiple primary systems and secondary systems are combined, an error in one of the journals affects other journals, and pairs are suspended by the error. A time stamp is issued to all journals, and the error in one of the journals is notified to the other journals as long as data consistency is maintained in the system.

To notify all journals of a failure, the following conditions must be met:

- The line between CCI and all primary systems is operating correctly.
- The status of the failed journal is PJSE or PJSF.
- At least one journal in the CCI consistency group is in normal status.

When all the above conditions are met, an error occurred in a journal is notified to the other journals. The following explains journal statuses:

- Normal journals are displayed as PJNN in CCI.
- When an error occurs, the journal status changes from PJNN (normal) to PJSE (suspended by error).
- For errors caused by capacity overflow, the status changes to PJSF.

- When one journal changes to PJSE or PJSF, all other normal journals in the PJNN status also change to the PJSE status (suspended by error).



Note: When an error occurs in a pair in a journal, if the entire journal is not suspended by the error, the status of the other journals does not change.

Calling customer support

If you need to contact customer support, provide as much information about the problem as possible, including:

- The circumstances surrounding the error or failure.
- The content of any error messages displayed on the host systems.
- The content of any error messages displayed by Device Manager - Storage Navigator.
- The Device Manager - Storage Navigator configuration information (use the Dump Tool).
- The service information messages (SIMs), including reference codes and severity levels, displayed by Device Manager - Storage Navigator.

The Hitachi Data Systems customer support staff is available 24 hours a day, seven days a week. If you need technical support, log on to Hitachi Data Systems Support Connect for contact information: https://support.hds.com/en_us/contact-us.html.

Configurations with TrueCopy

This appendix provides information about combining Universal Replicator and TrueCopy operations. For details about TrueCopy, see the *Hitachi TrueCopy® User Guide*.

- [Overview of UR/TC configurations](#)
- [Sharing volumes with TrueCopy](#)
- [3DC cascade configuration](#)
- [3DC multi-target configuration](#)
- [Delta resync configuration](#)

Overview of UR/TC configurations

Universal Replicator (UR) and TrueCopy (TC) can share the same data volumes. By combining UR and TC you can extend disaster recovery options to a third data center.

The terms "P-VOL" (primary volume) and "S-VOL" (secondary volume) are used for TC pair volumes as well as UR pair volumes.

Sharing volumes with TrueCopy

Like UR, the TC remote replication function provides copies of production volumes in a second location. However, unlike UR, the TC S-VOLs are synchronous copies of the P-VOLs, and the secondary storage system is located in the same general region as the primary storage system.

Creating a UR backup and a TC backup ensures that a copy in a third location is available in the event that both the primary and secondary sites fail.

You can combine UR and TC operations in a variety of ways. The following configurations are described in this appendix:

- **3DC cascade:** In a 3-data-center cascade configuration (3DC cascade), three data centers are used: the TC production site, the TrueCopy/Universal Replicator intermediate site, and the distant UR secondary site. The figure in the [3DC cascade configuration on page 323](#) provides an illustration. With this configuration, you can locate the TC synchronous site near the primary site to lower I/O response time, while the UR backup provides a disaster recovery solution at a secondary site. For details, see [3DC cascade configuration on page 323](#).
- **3DC multi-target:** In a 3-data-center multi-target configuration (3DC multi-target), the production volume is shared by the TC and UR. This volume is the primary volume (P-VOL) for both at the primary site. The targets of each system are located at different secondary sites. They provide the TC solution and the UR asynchronous disaster recovery solution. The TC secondary site is at an intermediate location, the UR secondary site is at a distant location. For details, see [3DC multi-target configuration on page 325](#).
- **Delta resync:** Another application of the 3DC multi-target configuration is the UR delta resync configuration, which provides a quick way to regain a long-distance copy after disaster in the event that the TrueCopy/Universal Replicator P-VOL becomes unusable. In this case, the host continues I/O operations at the intermediate TC S-VOL site. With a second UR pair previously configured between the TC S-VOL and the UR S-VOL, only differential data needs to be copied to the UR S-VOL. For details, see [Delta resync configuration on page 327](#).

Note: You can combine UR and TC using the following storage system models: VSP G800, VSP F800, VSP G1000, VSP G1500, VSP F1500, and HUS VM (3DC multi-target only).

Related references

- [System requirements](#) on page 44

3DC cascade configuration

In a multi-target configuration, data is copied from the primary site to two secondary sites. As shown in the following illustration, the TC P-VOL is the primary production volume in a 3DC cascade configuration. The TC S-VOL is located at an intermediate site that is near the primary site.

The host issues an update to the TC primary volume (P-VOL), which is copied synchronously to the S-VOL. The UR system copies the synchronous S-VOL data to the UR secondary site.

Data in the UR S-VOL is an asynchronous copy of the TC P-VOL. Depending on RPO and bandwidth, UR S-VOL data can be very close to P-VOL data. As always with UR, data consistency is ensured.

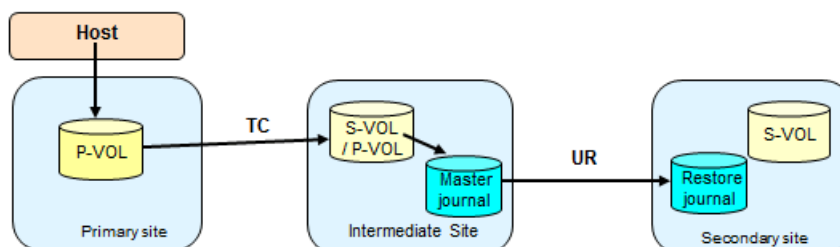

Failure recovery occurs as follows:

- If a failure occurs at the TC P-VOL, business continues because data in the UR S-VOL is restored to the primary storage system using the intermediate volume, if needed. Update sequence integrity is ensured.
- If a failure occurs at both TC P-VOL and S-VOL, an implemented disaster recovery plan would re-direct host activities to the UR S-VOL.

For recovery information and procedures, see [Recovery for 3DC UR/TC cascade configuration on page 256](#).

Prerequisites for 3DC cascade

- (VSP G1000, G1500, and VSP F1500) The VSP G1000, VSP G1500, VSP F1500, VSP, USP V/VM, and VSP G800 can be used at the primary, intermediate, and secondary sites.

- (VSP Gx00 models and VSP Fx00 models) One VSP G800, VSP F800, VSP G1000, VSP G1500, or VSP F1500 is required for each site. HUS VM is not supported in 3DC cascade configurations.
- If a site has multiple storage system, 3DC cascade cannot be configured.
- CCI is recommended at all the sites.
- Device Manager - Storage Navigator is required at all sites.
- The primary site requires the following:
 - Host application
 - TC
 - TC primary volume (P-VOL), the primary production volume
 - The TC P-VOL fence level (Primary Volume Fence Level) must be Data or Secondary Volume Data.
- The intermediate site requires the following:
 - TC
 - UR
 - TC S-VOL = UR P-VOL
 - UR master journal volume
- The secondary site requires the following:
 - UR
 - UR S-VOL
 - UR restore journal volume
- Differential data is used to resynchronize a suspended TC or UR pair.
- When the TC pair is resynchronized, the UR pair in PAIR or COPY status is automatically split by the system.
- (VSP G1000, G1500, and VSP F1500) 3DC cascade is not supported for multiple primary and secondary storage systems. The UR or TC pair in this configuration would be suspended when the status became PAIR or COPY.
- (VSP G1000, G1500, and VSP F1500) The response time for host I/Os will be the response time for TC operation plus the creation time of journal data in the intermediate site.
- (VSP G1000, G1500, and VSP F1500) The utilization rate on the primary site with a 3DC cascade configuration is higher than if UR and a TC systems are used independently.

Setting up the 3DC cascade configuration

Use the following procedure to set up a 3DC cascade configuration.

Procedure

1. Install and set up TC and UR on the required systems.
2. Create the TC pair on the primary storage system. See *Hitachi TrueCopy® User Guide* for instructions.
3. When TC pair status is PAIR, create the UR pair on the secondary storage system using the TC S-VOL as the UR P-VOL.
Mirror ID must be set between 1 and 3.

 **Note:** The UR operation is rejected by the system if TC pair status is not already PAIR.

3DC multi-target configuration

In a multi-target configuration, data is copied from the primary site to two secondary sites. As shown in the following illustration, the P-VOL is paired with the TC secondary volume and the UR S-VOL at separate secondary sites in a 3DC multi-target configuration. The TC site is at an intermediate distance; the UR site is located at a greater distance.

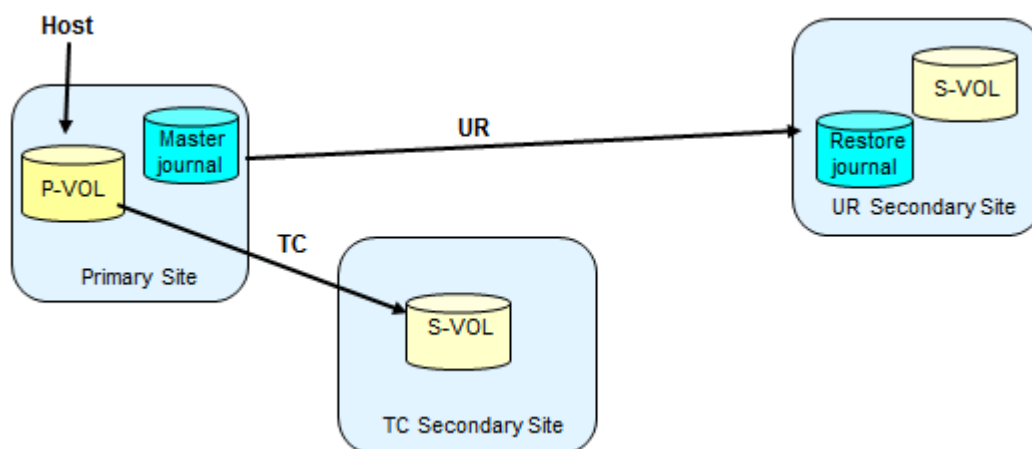

The host issues an update to the production volume and, synchronously, to the TC S-VOL. As with a standalone UR system, the update data is asynchronously written from the primary volume (P-VOL) to the UR S-VOL.

The benefit of this configuration is that it provides a third copy of the data, helping to ensure that business can continue in the event of a failure at the other two sites.

Failure recovery occurs as follows:

- If a failure occurs in the P-VOL, business is resumed using the TC S-VOL. When the failure is corrected at the primary site, business tasks are transferred back to the primary site. In addition, a quick disaster recovery solution can be put in place while the primary site is being restored, using a UR delta resync pair. In this configuration, the TC S-VOL is paired with the UR S-VOL. See [Delta resync configuration on page 327](#) for more information.
- If a failure occurs in the TC system (P-VOL and S-VOL), business is resumed using the UR S-VOL. When the failure is corrected, business tasks are transferred back to the primary site.

- If a failure occurs in the UR system (P-VOL and S-VOL), business is resumed using the TC S-VOL.

For recovery information and procedures, see [Recovery for 3DC UR/TC multi-target configuration on page 256](#).

Prerequisites for 3DC multi-target

- (VSP Gx00 models and VSP Fx00 models) At least one storage system at the primary site, TC secondary site, and UR secondary site.
- Any combination of VSP G1000, VSP G1500, VSP F1500, VSP, USP V/VM, and VSP G800 can be used at the primary and secondary sites.
- (VSP Gx00 models and VSP Fx00 models) Any combination of VSP G800, VSP F800, VSP G1000, VSP G1500, VSP F1500, or HUS VM can be used at the primary and secondary sites.
- CCI is recommended at all sites.
- Device Manager - Storage Navigator is required at all sites.
- The primary site requires the following:
 - TC
 - UR
 - TC P-VOL = UR P-VOL. This is the primary production volume.
 - UR master journal volume
- (VSP G1000, G1500, and VSP F1500) The intermediate site requires the following:
 - TC
 - UR
 - TC S-VOL
- (VSP Gx00 models and VSP Fx00 models) The TC secondary site requires the following:
 - TrueCopy
 - TC S-VOL
- (VSP Gx00 models and VSP Fx00 models) The UR secondary site requires the following:
 - UR
 - UR S-VOL
 - UR restore journal volume
- 3DC multi-target can be used in configurations with multiple primary and secondary storage systems. However, delta resync configurations are not supported in configurations with multiple primary and secondary storage systems.

Setting up 3DC multi-target configuration

Use the following procedure to set up a 3DC multi-target configuration.

Procedure

1. Install and set up TC and UR on the required systems.
2. Create a TC pair on the primary storage system. For instructions, see the *Hitachi TrueCopy® User Guide*.
3. When TC pair status is PAIR, create the UR pair on the primary storage system. The mirror ID must be set between 1 and 3.

Delta resync configuration

With the delta resync configuration, you bring the S-VOL to a consistent state more quickly after failure because only missing differential data must be copied.

You create the delta resync configuration by adding a second UR pair to the 3DC multi-target configuration, using the TC S-VOL and the UR S-VOL, as illustrated in the following figure. The delta resync operation is performed when the primary site fails.

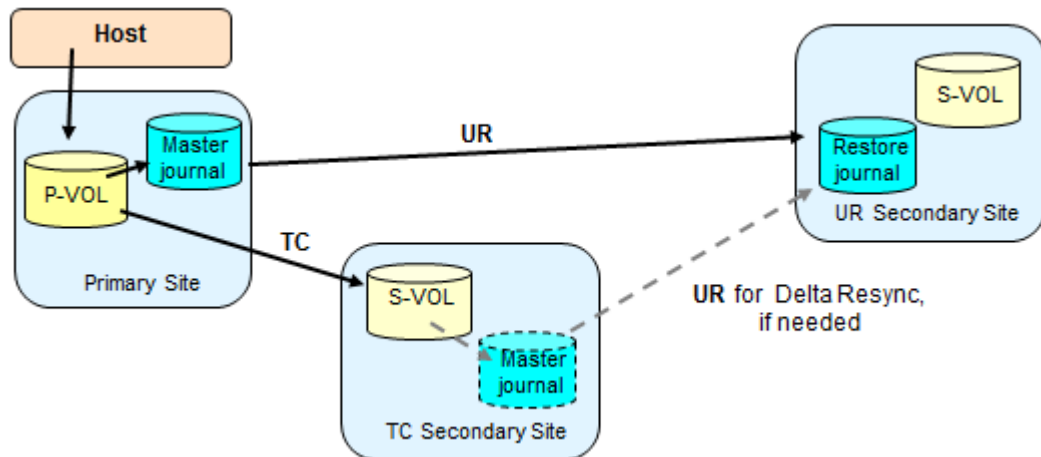

Procedure

1. Create the UR delta resync pair. See [Creating the delta resync pair on page 329](#).
2. Set up and map remote command devices and external ports in each site. With remote command devices, sites automatically connect with each other. See [Setting up remote command devices for use with CCI on page 330](#).
3. Assign mirror IDs to remote command devices. See [Assigning mirrors to remote command devices for delta resync operations on page 334](#).
4. In a recovery situation, run the delta resync operation. See [Performing the delta resync operation on page 338](#).

Additional task for the 3DC multi-target configuration using delta resync

To use delta resync, you need to perform an additional task after setting up 3DC multi-target configuration.

Procedure

1. Create the UR delta resync pair.
2. Set up and map remote command devices and external ports in each site.

The delta resync configuration will fail if the remote command devices for the delta resync are not set up. For setting up the remote command devices, see the *Hitachi Universal Volume Manager User Guide*.

3. Assign mirror IDs to remote command devices. Delta resync configuration will also fail when mirror IDs are not assigned to remote command devices. For assigning mirror IDs to remote command devices, see the related topics. With remote command devices, the TC and UR secondary sites automatically connect with each other, and delta resync is ready. The following figure shows how remote command devices and mirror IDs respond.

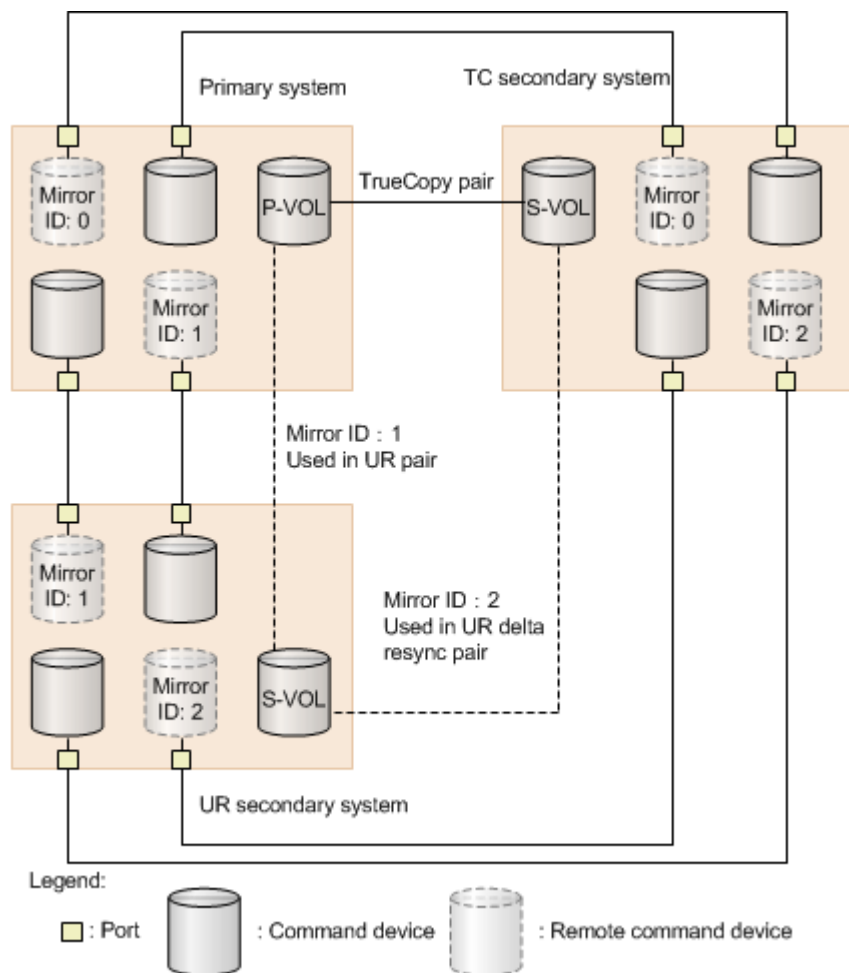

Creating the delta resync pair

The delta resync configuration is created after setting up the main TC and UR pairs in the multi-target configuration.

- Data is not copied at the time you set up the delta resync pair. The P-VOL and S-VOL in this system contain data from their respective TC and UR systems
- If a failure on the primary site occurs, the TC S-VOL is made the primary production volume using the CCI `horctakeover` command. Differential data stored in the journal volumes is used to synchronize the S-VOL using the resync operation.

Before you begin

- A UR delta resync pair can be created in a 3DC multi-target configuration only. To create the multi-target configuration, see [3DC multi-target configuration on page 325](#).

- A 3DC multi-target configuration with multiple primary and secondary storage systems cannot be used for delta resync.
- The TC S-VOL is used as the delta resync P-VOL. It must be in PAIR status.
- The UR S-VOL is used as the delta resync S-VOL. It must be in PAIR status.
- The mirror ID must be between 1 and 3; however, make sure it is not the same as the mirror ID assigned to the UR pair in the 3DC multi-target configuration.
- The consistency group you use for the delta resync configuration cannot be used by another UR pair.
- Follow volume combinations shown in [Volume types that can be shared with Universal Replicator on page 49](#).
- System option mode 506 must be ON for delta resync.
- If you create more than one delta resync pair, the delta resync P-VOLs in the same master journal must use the same mirror ID.
- (VSP G1000, G1500, and VSP F1500) If you plan to create in-system pairs on the secondary site sharing the delta resync S-VOL, make sure to perform the delta resync create-pair operation first, and then create in-system pairs.
- (VSP G1000, G1500, and VSP F1500) You can set a back-up option in the event that the delta resync operation fails. This is done on the Change Mirror Options window (see the Delta Resync Failure step in [Changing options used by mirrors on page 213](#)).

Procedure

1. Install and set up TC and UR on the required systems.
2. Create a 3DC multi-target configuration.
 - a. Create a TC pair from the primary storage system to the TC secondary site.
 - b. When the TC pair's status is PAIR, create the UR pair from the primary storage system to the UR secondary site.
3. Create a second UR pair from the TC S-VOL to the UR S-VOL. Specify the Initial Copy option as Delta.

When creating UR delta resync pair, select different mirror ID (Mirror ID 1 to 3) than the mirror ID which was used in step 2.

Setting up remote command devices for use with CCI

This procedure explains how to configure open system command devices for use with CCI. If you are using BCM, CCI command devices are not needed. Refer to the *Business Continuity Manager User Guide* for information about how to set up command devices and a 3DC environment using BCM.

With remote command devices, communications between each pair of sites is performed automatically, allowing the delta resync operation to be run.

Before you begin

To set up the remote command devices, the following conditions must be met:

- Two command devices and two remote command devices must be set up on each site: the primary site, the TC secondary site, and the UR secondary site, as shown in the figure below. See *Provisioning Guide*.
- External paths must be set up on all sites for communications between command devices and remote command devices. See *Hitachi Universal Volume Manager User Guide* for setting up external paths and remote command devices.

To allocate mirror IDs to remote command devices, the following conditions must be met:

- Create a 3DC multi-target configuration and UR delta resync pairs.
- Remote command devices are set up between each site. For more information about setting up the remote command devices, see the *Hitachi Universal Volume Manager User Guide*.

Procedure

1. Set up four command devices each on the primary site and at the two secondary sites.
2. Set up and dedicate two external ports and two target ports on each site. Configure paths between external ports and target ports.
For details about external ports, see the *Hitachi Universal Volume Manager User Guide*. For details about port and LU path settings, see the *Provisioning Guide*.
3. On each site, map a command device through a target port to a device on one of the other sites. You must map to the device on the other site as a remote command device, using an external port on that system. See *Hitachi Universal Volume Manager User Guide* for information about mapping the remote command devices.
4. Repeat the previous step so that two command devices on each site are mapped to a remote command device on each of the other two sites.
5. Assign mirror IDs to the remote command devices. This is required to enable communication for delta resync operations.

Result

Thus:

- Each site must have two command devices mapped through two target ports to the other two sites.
- Each site must also have two remote command devices mapped-to through external ports from the other two sites.

The following illustration shows this command/remote command device configuration with port configuration.

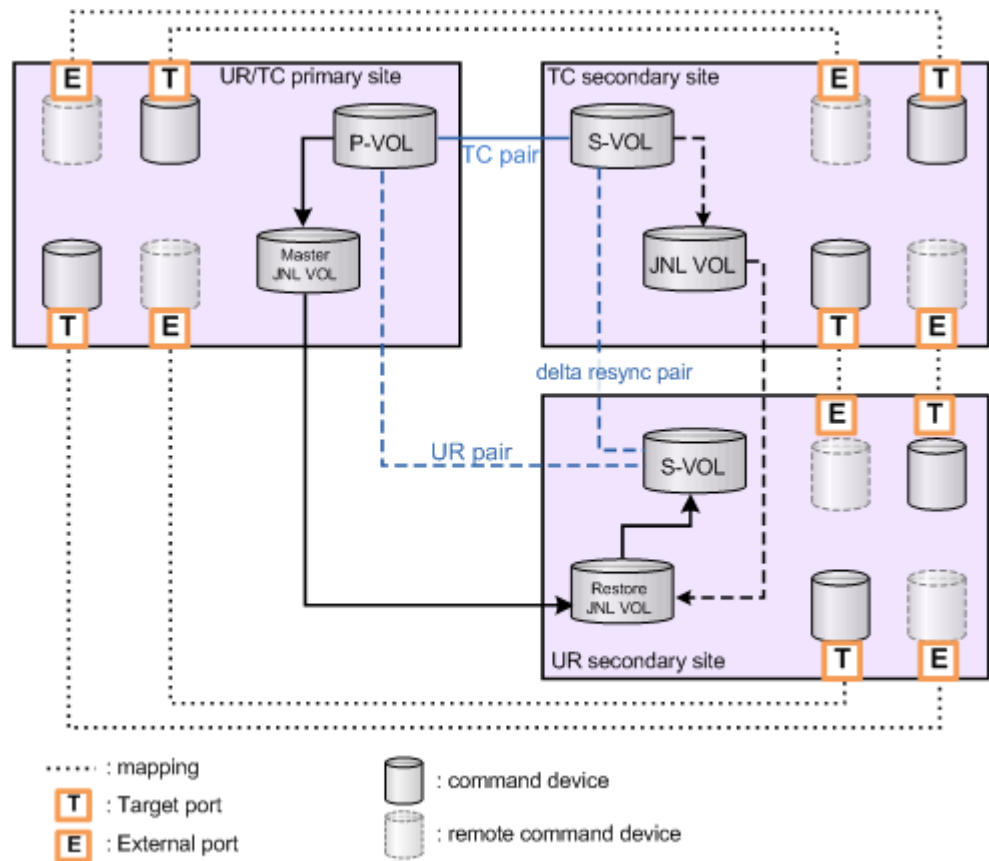

Figure 4 Remote command devices in a delta resync configuration

Mapping remote command devices for delta resync operations

For information about command device and remote command device configurations, see [Setting up remote command devices for use with CCI on page 330](#).

Procedure

1. Set a path for the external port and target port of each site.
For details about the external port, see the *Hitachi Universal Volume Manager User Guide*. For details about port and LU path settings, see the *Provisioning Guide* for your storage system.
2. Set command devices for all sites.
For details about setting command devices, see the *Provisioning Guide* for your storage system.
3. In the site in which you are creating a pair, map command devices in all sites as remote command devices.
For details about mapping remote command devices, see the *Hitachi Universal Volume Manager User Guide*.

Result

When the above procedure is performed, the status of each site changes as follows:

- Each site has two command devices mapped to the other two sites through two target ports.
- Each site has two remote command devices mapped from the other two sites through an external port.

In the Logical Devices window, logical devices that are command devices or remote command devices are displayed as Command Device or Remote Command Device (in the Attribute column). For details about the Logical Devices window, see the *Provisioning Guide* for your storage system.

The following figure shows a configuration of command devices and remote command devices.

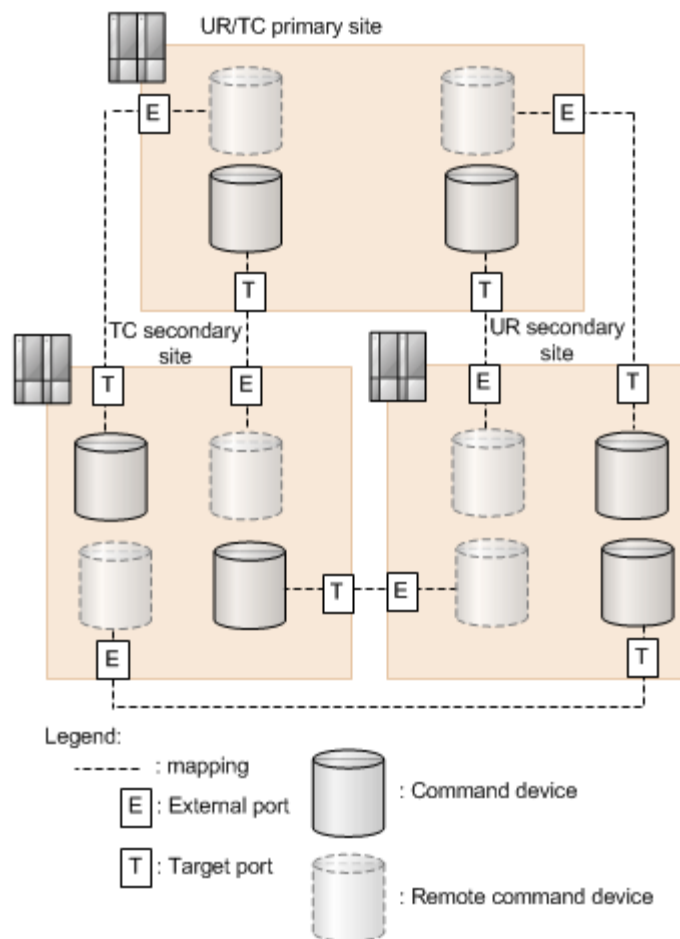

When mapping of remote command devices to each site is complete, you must assign mirror IDs to the remote command devices. This operation is required for delta resync operations.

Assigning mirrors to remote command devices for delta resync operations

You assign the mirror IDs used by the configuration's journals to the remote command devices. This enables UR control information regarding the delta resync to be transferred and then read at the secondary sites. This is necessary for the delta resync operation.

Before you begin

- Required role: Storage Administrator (Remote Backup Management)
- To assign a mirror to a remote command device, the mirror's status must be one of the following:
Initial, Active, Halt, Stopped, Hold, Holding, or Holding(Failure)
To use a mirror in Initial status, it must have mirror ID 0.
- Perform this operation for each journal.
- In a journal, you can assign multiple mirrors to two remote command devices in one operation.
- A maximum of 16 mirrors can be shared with a remote command device. When a remote command device is shared, you can use it to do the following:
 - Assign it to other mirrors
 - Use it with CCI

When performing these functions with a remote command device, the number of registered journals and instances used by CCI are subtracted from the number of mirrors that can be shared.

- A maximum of 16 remote command devices can be used for the delta resync operation per storage system.



Note: A remote command device allocated to a mirror is removed when all pairs in the 3DC delta resync configuration are deleted.

Procedure

1. In the **Explorer** pane, expand the **Storage Systems** tree.
2. Expand the target storage system tree, expand **Replication**, and click **Remote Replication**.
3. Select the **Mirrors** tab, and then select the mirror to which you will assign the remote command device.
4. From the **Actions** menu, click **Remote Replication > Assign Remote Command Devices**.
5. In the **Available Mirrors** table, select a mirror.

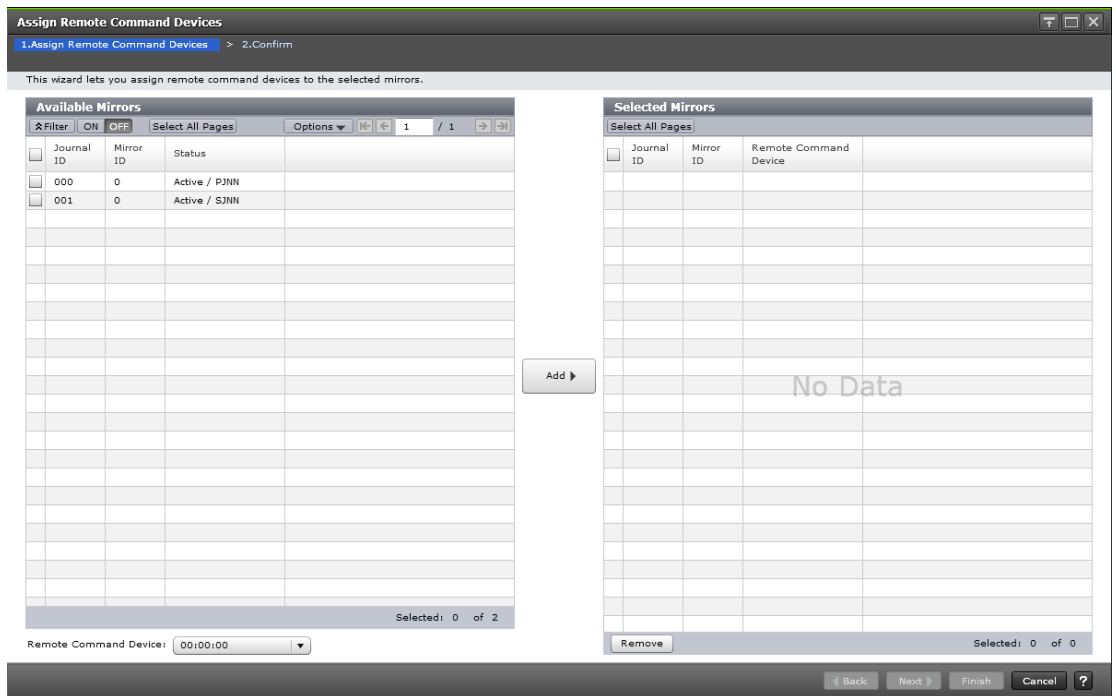

- On primary site:
 - Assign mirror ID 0 to the remote command device that is mapped to the TC secondary site.
 - Assign the mirror ID used for the UR 3DC multi-target pair to the remote command device that is mapped to the secondary site.
- On the TC secondary site:
 - Assign mirror ID 0 to the remote command device that is mapped to the primary site.
 - Assign the mirror ID used for the UR delta resync pair to the remote command device that is mapped to the UR secondary site.
- On the UR secondary site:
 - Assign the mirror ID used for the UR 3DC multi-target configuration to the remote command device that is mapped to the primary site.
 - Assign the mirror ID used for the UR delta resync pair to the remote command device that is mapped to the TC secondary site.

When selecting mirror IDs and remote command devices, observe the following:

- Though two mirrors can be assigned to each remote command device, it is not required. **Mirror 2** is optional.
 - The same mirror ID cannot be specified from both Mirror ID lists.
6. Select the remote command device to be assigned from **Remote Command Device**.
 7. Click **Add**. The mirror to which the remote command device is assigned, is added to the **Selected Mirrors** table. If you want to remove the

added mirror from the **Selected Mirrors** table, select the mirror and then click **Remove**.

8. Click **Finish**.
9. In the **Confirm** window, review the settings and enter a task name in the **Task Name** box.
10. Click **Apply** to save your settings to the system.
11. To check newly assigned remote command devices, see **Remote Command Device** in the **Journal Volumes** window.
 - If a remote command device is assigned to the mirror, the LDEV number is displayed.
 - If a remote command device is not assigned to the mirror, the field is blank.
 - If a remote command device cannot be assigned to the mirror, a hyphen is displayed.

Releasing a remote command device for delta resync operations assigned to a mirror

This operation is performed on the mirror when releasing the assigned remote command device.

Before you begin

Required role: Storage Administrator (Remote Backup Management)

Procedure

1. In the **Explorer** pane, expand the **Storage Systems** tree.
2. Expand the target storage system tree, expand **Replication**, and click **Remote Replication**.
3. Select the **Mirrors** tab, and then select the mirror with the remote command device to be deleted.
4. From the **Actions** menu, click **Remote Replication > Release Remote Command Devices**.
5. In the **Release Remote Command Devices** window, review your selection in the **Selected Mirrors** table. If you need to make a change, select **Cancel**.



6. When ready, click **Finish**.
7. In the **Confirm** window, review the settings and enter a task name in the **Task Name** box.
8. Click **Apply** to save your settings to the system.

Relationship between deleted associated pairs and assigned remote command devices

You can change a 3DC configuration that uses the delta resync function to a configuration that does not use it by deleting pairs. At this time, along with the deleted pairs, associated pairs are also deleted automatically, and the assignment of remote command devices is released automatically.

If you delete pairs when you cannot communicate with remote command devices, the assignment of remote command devices is not released automatically. In this case, refer to information about releasing a remote command device assigned to a mirror.

If you delete pairs after a hardware failure has occurred or after a pair is suspended by error, the assignment of remote command devices you do not want to delete might be released. In this case, check if the necessary remote command devices are still assigned after the deletion. If the assignment is released, reassign the remote command devices.

Related tasks

- [Releasing a remote command device for delta resync operations assigned to a mirror](#) on page 336

Automatically deleted pairs that are automatically released

There are configurations in which pairs that are automatically deleted and remote command devices that are automatically released along with the pairs you have deleted.

When all the TC pairs linked to the UR pairs are deleted, the following pairs are also deleted automatically, and the assignment of the following remote command devices is released. The configuration changes to the UR only configuration.

- UR delta resync pair
- Remote command devices set for the UR mirror for delta resync
- Remote command devices set for the mirror between the primary site and the TC secondary site

The assignment of remote command devices set for the UR mirror is not released.

When all the UR pairs between the primary site and the UR secondary site are deleted, the following pairs are also deleted automatically and the assignment of the following remote command devices is released. The configuration changes to the TC only configuration.

- UR delta resync pair
- Remote command devices set for the UR mirror for delta resync
- Remote command devices set for the UR mirror
- Remote command devices set for the mirror between the primary site and the TC secondary site

All the remote command device assignments are released.

When all the UR pairs for delta resync are deleted, the assignment of the following remote command devices is released automatically. The configuration changes to the 3DC multi-target configuration that does not use the delta resync function.

- Remote command devices set for the UR mirror for delta resync
- Remote command devices belonging to the TC secondary site, and set for the mirror between the primary site and the TC secondary site

The assignment of the following remote command devices is not released:

- Remote command devices set for the UR mirror
- Remote command devices belonging to the primary site, and set for the mirror between the primary site and the TC secondary site

Performing the delta resync operation

You perform the delta resync operation using the resynchronize mirrors operation. When the delta resync operation is performed, the differential data will be copied from the TC S-VOL to the UR S-VOL. Review the following important prerequisite information, and then follow the procedure in [Resynchronizing a mirror on page 140](#).

- Note the following:
 - The delta resync pair must be created.
 - Remote command devices must be set up.
 - External ports must be set.

- Mirror IDs must be assigned to remote command devices.

For details, see [Delta resync configuration on page 327](#).

- Required pair and volume statuses:
 - The TC volume used as the 3DC multi-target P-VOL: PAIR
 - The TC S-VOL used as the delta resync P-VOL: SSWS.
Check this status after executing the CCI horctakeover command
 - The UR delta resync pair: HOLD or HOLDING. If the pair status is HLDE, change to HOLD by performing the pairresync operation.
This applies to all pairs in the journal in which the UR delta resync pair resides.
 - The UR volume used as the 3DC multi-target and the delta resync pair S-VOL and uses two mirror IDs, one for the 3DC multi-target pair and one for the delta resync pair:
 - 3DC multi-target S-VOL: PAIR, PSUS, or PSUE
 - Delta resync S-VOL: HOLD.



Note: The UR S-VOL uses two mirror IDs because of its dual use in the 3DC multi-target and delta resync configurations. The statuses shown above are required for the two mirrors as well as for the journal in which the UR delta resync pair resides.

- If the delta resync S-VOL has been backed up on the secondary site using SI or TI, make sure to review the information for the Delta Resync Failure step in ([Changing options used by mirrors on page 213](#)).
- Differential data is stored in the master journal but may not be completely present after a failure at the primary site when the pair was being resynchronized (or after creating the delta resync pair configuration).
- When a UR pair has not been suspended and not resynchronized for a long time, the data in the restore journal might exceed 70% of capacity and old journal data is automatically deleted. In this case, the P-VOL and S-VOL are not synchronized completely by just copying the data, and delta resync will fail. In case of delta resync failure, based on Delta Resync Failure settings, the entire P-VOL data will be copied to the S-VOL or pair status becomes HLDE with no processing and delta resync ends abnormally.
- Journal data may also be destroyed in the following cases:
 - When you restore the TC or UR pair in the multi-target configuration, and then also update the delta resync pair.
 - When retry-processing occurs because of a delay of the P-VOL update.
 - When the update of a TC S-VOL is delayed.
- The UR pair status in a delta resync configuration could become PSUS or PSUE if you split the pair, or if there is a failure when copying all data from the P-VOL to the S-VOL. If you then run the delta resync operation, all data might be copied from P-VOL to S-VOL regardless of journal option settings.

- If the pair's mirror is in Halting or Stopping status, the **resynchronization** command is rejected.

Problems that can occur in the delta resync operation

Journal data will not exist, and therefore the delta resync operation will fail, in the following cases:

- After creating the UR pair, the primary delta resync P-VOL is updated but not the UR P-VOL.
- When the multi-target P-VOL is resynchronized after the TC pair was split.
- When the UR S-VOL is resynchronized after it was split.
- When the UR pair is resynchronized after being split and then the journal volume at the TC secondary site exceeds 70%.
- When the delta resync P-VOL is updated, and then the journal volume at the TC secondary site exceeds 70%.
- When the delta resync pair is created and no volumes (including volumes after failover or failback) in the primary site are updated.
- When the status of the UR delta resync pair becomes HLDE, the journal data necessary for the delta resync operation might be discarded. In this case, all data in the delta resync P-VOL would be copied to the delta resync S-VOL.
- Do not assign the P-VOL of an SI pair that uses a DP-VOL to the S-VOL of the UR delta resync pair.

Delta resync failure error prevention

If you specify Entire Copy for the Delta Resync Failure option (**Edit Mirror Options** window) in advance, you can prevent errors from occurring by copying the entire P-VOL data to the secondary volume when the necessary journal data for delta resync is not available. However, the P-VOL data will not be copied to the S-VOL in case of error even if you specify Entire Copy for the Delta Resync Failure option in the following case:

- The UR delta resync S-VOL is assigned to the SI P-VOL or HTI P-VOL.

In the following case, entire data might be copied from the UR delta resync P-VOL to the S-VOL:

- Before performing delta resync, the pair status is changed to PSUS by pair split or PSUE by failure while copying the entire data from the P-VOL to the S-VOL as a UR pair.

Configurations with ShadowImage

Universal Replicator (UR) and ShadowImage (SI) can share the same data volumes to provide multiple copies of data at both the primary and secondary sites. This appendix provides information about combining Universal Replicator and ShadowImage operations. For details about ShadowImage, see the *Hitachi ShadowImage® User Guide*.

- [Overview of UR/SI configurations](#)
- [Configurations with SI primary volumes](#)
- [Configurations with SI secondary volumes](#)
- [Pair status and data currency](#)

Overview of UR/SI configurations

The main function of Universal Replicator is to provide copies of production volumes in a remote location.

Using SI to back up the UR volumes or using UR to back up the SI volumes provides additional advantages.

- When the UR primary volume is shared with SI:
 - On-site data backup is provided in case of a UR failure.
 - Multiple copies of production data are provided at the primary site for secondary purposes such as data analysis and testing.
- Sharing the SI secondary volume with the UR primary volume at the primary site provides a remote copy.
- When SI is cascaded at the secondary site, data in the SI secondary volume can be used for testing the UR system and for recovery purposes.
 - The SI secondary volume is available for continuous replication during a test.
 - If a UR problem is encountered during an actual recovery procedure, the SI secondary volume provides a golden copy of the UR secondary volume, which can be used to restore the UR secondary volume.



Note:

- To split the SI pairs in a consistency group whose volumes are also used in UR pairs, the UR pairs must be in PAIR, PSUS, or PSUE status.
 - (VSP Gx00 models and VSP Fx00 models) An SI pair volume can be used with UR volumes if extended.
-

The following shared UR/SI configurations are described in this appendix:

- [Configurations with SI primary volumes on page 342](#)
- [Configurations with SI secondary volumes on page 345](#)

Configurations with SI primary volumes

An SI P-VOL can be shared with a UR P-VOL or S-VOL.

- An SI P-VOL shared with the UR P-VOL is illustrated below. This configuration allows you to use SI for on-site data backup in case of a UR failure, and to use UR to provide a secondary backup of the SI P-VOL in case of an SI failure.

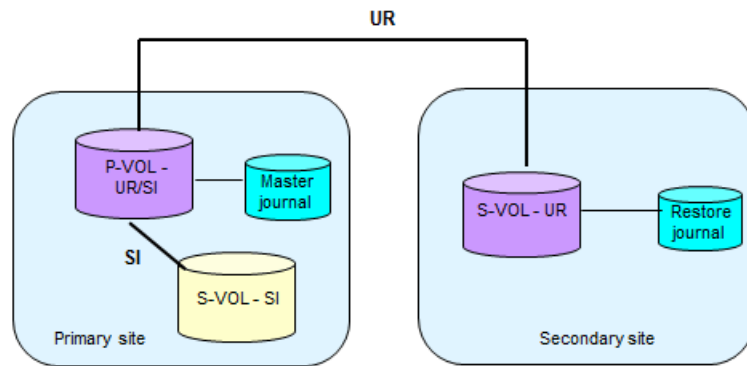

- A UR S-VOL shared with an SI P-VOL is illustrated below. With this configuration, multiple backup copies of the UR P-VOL can be made on the secondary storage system.

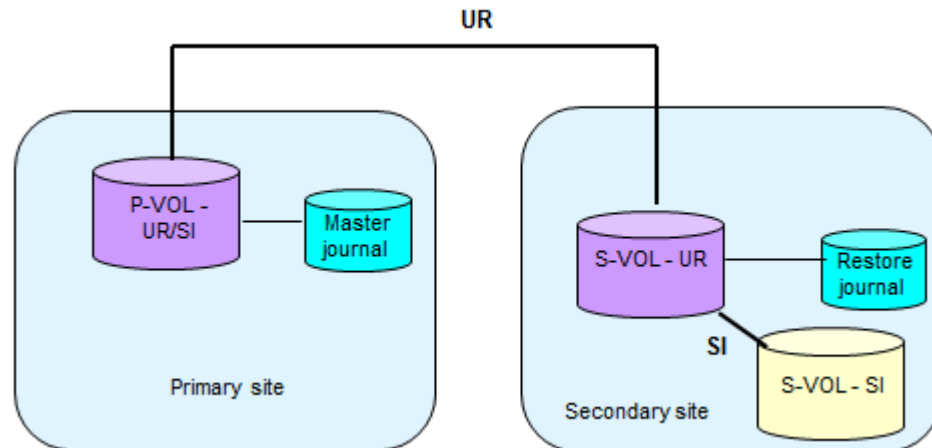

Caution: When you share a UR S-VOL with an SI P-VOL as shown in the following figure, the restore operation to the UR S-VOL takes time. This is especially the case when the SI pair is in the PSUS(SP)/PSUS status because of the time needed to copy the SI pair.

Because of the extra time that might be needed, make sure the UR journal volume is sized with enough capacity to handle the possible increase in I/O. If journal volume capacity is insufficient, the pair will be suspended because of failure.

- UR primary and secondary volumes shared with SI primary volumes is illustrated below. This configuration provides multiple copies of the source volume at the primary and secondary sites.

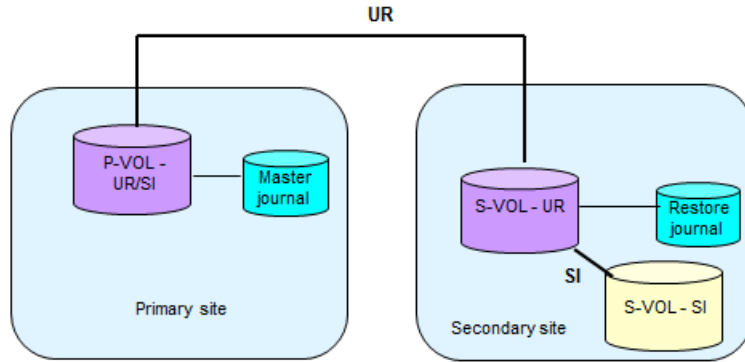

In the above configurations in which the SI P-VOL is shared, you can only delete UR pairs when the SI P-VOL status is COPY(RS-R)/RCPY. The following table shows possibilities of UR pair operations according to the SI P-VOL status.

SI P-VOL status	UR pair operations				
	Create	Split	Resync	Delete	Switch operations between the primary and secondary sites (horctakeover)
(VSP G1000, G1500, and VSP F1500) COPY(PD)/ COPY COPY(SP)/ COPY COPY(RS)/ COPY (VSP Gx00 models and VSP Fx00 models)COPY	Yes *	Yes	Yes	Yes	Yes
PAIR	Yes*	Yes	Yes	Yes	Yes
(VSP G1000, G1500, and VSP F1500) PSUS(SP)/ PSUS (VSP Gx00 models and VSP Fx00 models) PSUS (SP)	Yes*	Yes	Yes	Yes	Yes

SI P-VOL status	UR pair operations				
	Create	Split	Resync	Delete	Switch operations between the primary and secondary sites (horctakeover)
PSUS PSUE	Yes*	Yes	Yes	Yes	Yes
(VSP G1000, G1500, and VSP F1500) COPY(RS-R)/RCPY (VSP Gx00 models and VSP Fx00 models) RCPY	No	No	No	Yes	No
(VSP Gx00 models and VSP Fx00 models)* If the UR P-VOL and UR S-VOL are DP-VOLs, the UR S-VOL cannot be used as the SI P-VOL.					

Configurations with SI secondary volumes

The following figure shows an SI primary volume used as the production volume. A remote UR backup copy is made of the SI secondary volume. The SI pair must be in PSUS status to perform the UR operation.

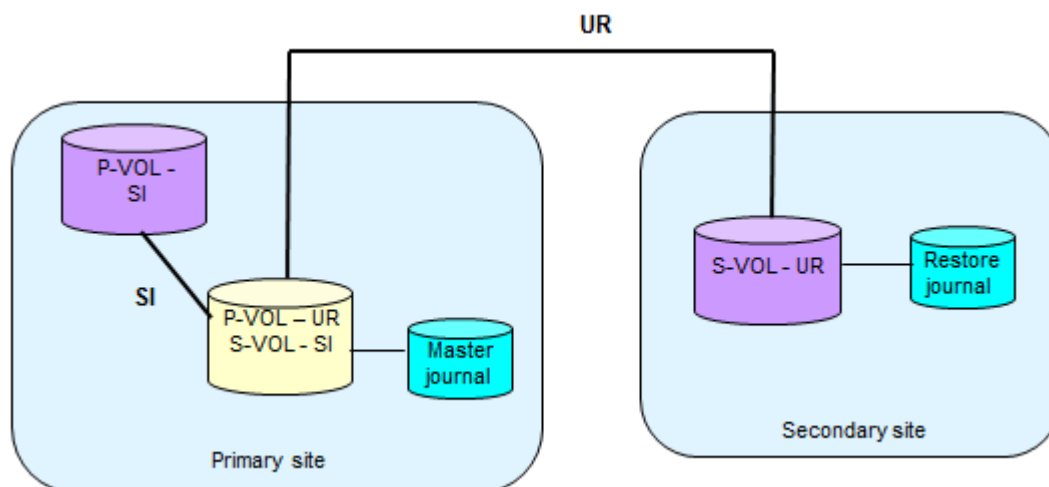

In this configuration, before creating a UR pair, you must set the SI pair in the PAIR status, split the SI pair, and then set it in the PSUS status. The following table shows possibilities of UR pair operations according to the SI S-VOL status.

SI S-VOL status	UR pair operations				
	Create	Split	Resync	Delete	Switch operations between the primary and secondary sites (horctakeover)
(VSP G1000, G1500, and VSP F1500) COPY(PD)/ COPY COPY(SP)/ COPY COPY(RS)/ COPY (VSP Gx00 models and VSP Fx00 models)COPY	No	No	No	Yes	No
PAIR	No	No	No	Yes	No
PSUS(SP)/ PSUS	No	No	No	Yes	No
PSUS PSUE	Yes	Yes	Yes	Yes	No
(VSP G1000, G1500, and VSP F1500) COPY(RS-R)/ RCPY (VSP Gx00 models and VSP Fx00 models) RCPY	No	No	No	Yes	No

Pair status and data currency

The following table shows whether the data in a shared volume is current, given the combined status.

UR pair status	SI pair status					
	COPY(PD)/ COPY	PAIR	COPY(SP)/ COPY	PSUS	COPY(RS/COPY, COPY(RS-R)/COPY	PSUE
COPY	Not Current	Not Current	Not Current	Current	Not Current	Not Current
PAIR	Not Current	Not Current	Not Current	Current	Not Current	Not Current
PSUS/PSUE	Not Current	Current	Current	Current	Current	Not Current

Check pair status for shared volumes as follows:

- For UR, check status of the primary volume or secondary volume.

- For SI, check status of the primary volume.

SI supports multiple secondary volumes for each primary volume. When you check pair status, the system returns status for only one pair: the pair whose secondary volume has the lowest LDEV ID. To see status for the pairs with a different secondary volume, direct a host query to the specific secondary volume using the secondary volume's LDEV ID in the `host` command.



UR CLI reference

This appendix lists the Universal Replicator operations and provides the corresponding CLI commands (CCI) for the operations. For details about the CLI commands and options, see the documentation for the product (for example, the *Command Control Interface Command Reference*).

- [Configuration operations](#)
- [Pair operations](#)
- [Monitoring operations](#)
- [Maintenance operations](#)
- [Consistency group operations](#)

Configuration operations

The following table lists the UR configuration operations and provides the corresponding CCI commands.

Operation	Options	In HDvM - SN?	CCI command and options
Edit Ports (VSP G1000, G1500, and VSP F1500)	Port Attribute	Yes	raidcom modify port -port_attribute <i>port attribute</i>
Add Remote Connection	Connection Type (VSP G1000, G1500, and VSP F1500)	Yes	None
	Remote Storage System	Yes	raidcom add rcu -rcu serial# mcu# rcu# id
	Remote Paths	Yes	raidcom add rcu -cu_free serial# id pid
	RIO MIH Time	Yes	raidcom modify rcu -rcu_option mpth rto rtt[fzd fze]
Create Journals (VSP G1000, G1500, and VSP F1500)	System Type	Yes	raidcom add journal [-timer_type <i>timer_type</i>] ¹
	Journal ID	Yes	raidcom add journal -journal_id <i>journal ID#</i>
	Journal Type Options ² : Data Overflow Watch, Cache Mode, and Timer Type	Yes	raidcom modify journal [-data_overflow_watchtime] [-cache_mode {y n}][-timer_type <i>timer type</i>]
	Journal Type Options ² : Path Blockade Watch	Yes	raidcom modify journal -path_blocked_watchtime [-mirror_id <i>mu#</i>]
	Journal Type Options ² : Specifies MP Blade	Yes	raidcom modify journal -mp_blade_id <i>mp#</i>
Create Journal(VSP Gx00 models and VSP Fx00 models)	Journal ID	Yes	raidcom add journal -journal_id <i>journal ID#</i>
	MP Unit ID ²	Yes	raidcom modify journal -mp_blade_id <i>mp#</i>
	Data Overflow Watch ²	Yes	raidcom modify journal -data_overflow_watch <i>time</i>
	Cache Mode ²	Yes	raidcom modify journal -cache_mode {y n}

Operation	Options	In HDvM - SN?	CCI command and options
Edit Journal Options(VSP Gx00 models and VSP Fx00 models)	Data Overflow Watch ²	Yes	raidcom modify journal -data_overflow_watch <i>time</i>
	Cache Mode ²	Yes	raidcom modify journal -cache_mode {y n}
Assign Journal Volume	None	Yes	raidcom add journal -journal_id <i>journalID#</i>
Add Reserve Journal Volume (VSP G1000, G1500, and VSP F1500)	None	Yes	raidcom add journal -journal_id <i>journalID#</i> -ldev_id <i>ldev#</i>
Assign MP Blade ID or MP Unit ID	MP Blade ID or MP Unit ID	Yes	raidcom add journal [-mp_blade_id <i>mp#</i>]
Edit Remote Replica Options	Copy Type	Yes	None
	Maximum Initial Copy Activities	Yes	None
Notes:			
<ol style="list-style-type: none"> (VSP G1000, G1500, and VSP F1500) The journal will be created as an open system journal if you do not specify the -timer_type option. If you specify -timer_type, the journal will be created for mainframe systems. Data Overflow Watch, Cache Mode, Timer Type, Path Blockade Watch, and MP Blade ID or MP Unit ID can only be specified all at once during the create journal operation using Device Manager - Storage Navigator. You can only specify them one-by-one with CCI and also you can modify the journal type options. For details, see the <i>Command Control Interface User and Reference Guide</i>. 			

Pair operations

The following table lists the UR pair operations and provides the corresponding CCI commands.

Operation	Options	In HDvM - SN?	CCI command and options
Create UR Pairs	Copy Type (VSP G1000, G1500, and VSP F1500)	Yes	paircreate None
	LU Selection	Yes	paircreate None ¹
	Base Secondary Volume	Yes	paircreate None ²
	Mirror Selection	Yes	paircreate None ¹
	CTG ID	Yes	paircreate

Operation	Options	In HDvM - SN?	CCI command and options
			-f[g] fence [CTG ID]
	Initial Copy Type	Yes	paircreate [-nocopy -nocsus]
	Initial Copy Priority	Yes	paircreate None
	Error Level	Yes	paircreate -nomsg
Split Pairs	Secondary Volume Write	Yes	pairsplit -rw
Split Mirrors	Secondary Volume Write	Yes	None
	Split Mode	Yes	None
Resync Pairs	Copy Priority	Yes	pairresync None
	Error Level	Yes	pairresync -nomsg
Resync Mirrors	None	Yes	None
Delete Pairs (VSP G1000, G1500, and VSP F1500)	None	Yes	pairsplit -S
Delete Mirrors	Delete Mode	Yes	None
(VSP G1000, G1500, and VSP F1500)			
Notes:			
<ol style="list-style-type: none"> 1. The LU and Mirror options cannot be specified with the paircreate command. Instead, you must specify them in the configuration definition file, in advance, and then run the pair create command. 2. The Base Secondary volume and the Secondary volumes options cannot be specified with the paircreate command. Instead, you must specify them in the configuration definition file, in advance, and then run the pair create command. 			

Monitoring operations

The following table lists the UR monitoring operations and provides the corresponding CCI commands.

Operation	Options	In HDvM - SN?	CCI command and options
View Pair Properties	None	Yes	pairdisplay -m mode

Operation	Options	In HDvM - SN?	CCI command and options
View Pair Synchronization Rate	None	Yes	pairdisplay -fc
View Remote Connection Properties	None	Yes	pairdisplay -m <i>mode</i>

Maintenance operations

The following table lists the UR maintenance operations and provides the corresponding CCI commands.

Operation	Options	In HDvM - SN?	CCI command and options
Edit Pair Options	Error Level	Yes	None
Force Delete Pairs (UR Pairs)	None	Yes	None
Edit Journal Options	None	Yes	raidcom modify journal None
Edit Mirror Options	None	Yes	None
Assign Journal Volumes	None	Yes	raidcom add journal -journal_id <i>journal ID#</i>
Delete Journals	None	Yes	raidcom delete journal -journal_id <i>journal ID#</i>
Edit Remote Connection Options	RIO MIH Time	Yes	None
Add Remote Paths	None	Yes	None
Remove Remote Paths	None	Yes	None
Remove Remote Connections	None	Yes	None
Assign Remote Command Devices	None	Yes	None
Release Remote Command Devices	None	Yes	None

Consistency group operations

The following table lists the UR consistency group operations and provides the corresponding CCI commands.



Note: Consistency group commands and options are not available from HDvM - SN.

Operation	CCI command and options
Reserve CTGs	paircreate -f[g] <i>fence</i> [CTG ID]
Release reserved CTGs	None
Add pair to the CTG	paircreate -f[g] <i>fence</i> [CTG ID]
Split pairs in the CTG (no reservation time)	pairsplit -S
Resync pairs in the CTG	pairresync -f[g] <i>fence</i> [CTG ID]
Delete pairs in the CTG	pairsplit -S



UR GUI reference

This appendix describes the Universal Replicator windows, dialog boxes, fields, and behaviors in the Device Manager - Storage Navigator GUI.

- [Journals window](#)
- [Journal Volumes window](#)
- [Journal Properties window](#)
- [Create Journals wizard](#)
- [Assign Journal Volumes wizard](#)
- [Delete Journals window](#)
- [Edit Journal Options wizard](#)
- [Assign MP Blade ID or MP Unit ID wizard](#)
- [Edit Mirror Options wizard](#)
- [Assign Remote Command Devices wizard](#)
- [Release Remote Command Devices window](#)
- [View Pair Synchronization Rate window](#)
- [Create UR Pairs wizard](#)
- [View Pair Properties window](#)
- [Split Pairs wizard](#)

- [Split Mirrors wizard](#)
- [Resync Pairs wizard](#)
- [Resync Mirrors wizard](#)
- [Delete Pairs wizard](#)
- [Force Delete Pairs window](#)
- [Delete Mirrors wizard](#)
- [Edit Pair Options wizard](#)
- [Complete SIMs \(UR\) window \(VSP G1000, G1500, and VSP F1500\)](#)
- [Replication window](#)
- [Remote Replication window](#)
- [Remote Connections window](#)
- [View Remote Connection Properties window](#)
- [History window](#)
- [Add Remote Connection window](#)
- [Add Remote Connection confirmation window](#)
- [Edit Remote Replica Options window](#)
- [Edit Remote Replica Options confirmation window](#)
- [Add Remote Paths window](#)
- [Add Remote Paths confirmation window](#)
- [Remove Remote Paths window](#)
- [Remove Remote Paths confirmation window](#)
- [Edit Remote Connection Options window](#)

- [Edit Remote Connection Options confirmation window](#)
- [Remove Remote Connections window](#)
- [Edit Ports window](#)
- [Edit Ports confirmation window](#)

Journals window

Use this window to view details about journals and their properties.

Journal ID	Journal Type	Attribute	Number of Journal VOLS	Journal Capacity	Number of Data VOLS	Data Capacity
000	UR	Master	1	10.00 GB	1	10.00 GB
001	UR	Restore	1	10.00 GB	1	10.00 GB
002	UR	Initial	1	10.00 GB	0	0.00 GB
003	UR	Initial	1	10.00 GB	0	0.00 GB

Summary

Item	Description
Number of Journals	Total number of journals, with the maximum number in parentheses.
Number of EXCTGs (VSP G1000, VSP G1500, and VSP F1500)	Number of the EXCTGs in use.

Journals tab

Item	Description
Journal ID	Journal identifier. Clicking the link displays more information about the journal and assigned mirrors and journal volumes.
Journal Type (VSP G1000, VSP G1500, and VSP F1500)	Journal copy type, UR or URMF.
Attribute	Whether the journal is Master, Restore, Master/Restore, or Initial.
Number of Journal VOLS	Number of journal volumes registered in the journal.
Journal Capacity	Capacity of the journal volume registered in the journal. If two journal volumes are registered, the capacity of the reserve journal volume is subtracted from the total capacity.
Number of Data VOLS	Number of volumes associated with the journal. (VSP G1000, VSP G1500, and VSP F1500) If the journal uses multiple mirror IDs, volumes in mirrors with Hold, Holding, or Hold(Failure) status are not included.

Item	Description
	(VSP Gx00 models and VSP Fx00 models) With the delta resync configuration, the number of data volumes registered to the journal of the mirrors not for delta resync is displayed. The number of volumes registered to the journal of the delta resync mirrors (whose status is Hold, Holding, or Hold(Failure)) is not displayed.
Data Capacity	<p>Total capacity of all the associated volumes.</p> <p>(VSP G1000, VSP G1500, and VSP F1500) If the journal uses multiple mirror IDs, the capacity of volumes in mirrors with Hold, Holding, or Hold(Failure) status is not included.</p> <p>(VSP Gx00 models and VSP Fx00 models) With the delta resync configuration, the number of data volumes registered to the journal of the mirrors not for delta resync is displayed. The number of volumes registered to the journal of the delta resync mirrors (whose status is Hold, Holding, or Hold(Failure)) is not displayed.</p>
MP Blade ID or MP Unit ID*	MP Blade ID or MP Unit ID identifier.
Encryption*	<p>Journal's encryption information:</p> <ul style="list-style-type: none"> • Enabled: The journal contains only encrypted volumes. • Disabled: The journal contains only unencrypted volumes. • Mixed: The pool to which the journal volume belongs contains two or more of the following: <ul style="list-style-type: none"> ○ Volume for which encryption is enabled ○ Volume for which encryption is disabled ○ External volume <p>Note: Encryption of data is not ensured in an LDEV with the Mixed encryption status. To manage data encryption, use an LDEV in which Encryption is Enabled or Disabled.</p> <ul style="list-style-type: none"> • Hyphen (-): The pool to which the journal volume belongs is an external volume, created in a migration volume (VSP G1000, VSP G1500, and VSP F1500), or blocked.
Inflow Control*	Whether the flow of update data to the journal volume is restricted by slowing the response to hosts.
Data Overflow Watch*	Number of seconds the system monitors metadata and journal data when the journal volume is full (100%). If Inflow Control is disabled, a hyphen (-) is displayed.
Cache Mode*	<p>Whether journal data is stored in cache memory in the restore journal.</p> <ul style="list-style-type: none"> • Enable: Journal data is stored in cache memory. When the available cache memory becomes insufficient, the journal data is also stored in a journal volume. • Disable: Journal data is stored in a journal volume instead of cache memory. This setting is disabled in the master journal. However, this setting is enabled if you use the <code>horctakeover</code> command of CCI (for Universal Replicator) or the <code>YKRESYNC REVERSE</code> command of Business Continuity Manager (for Universal Replicator for Mainframe) to change the master journal to the restore journal.
Timer Type* (VSP G1000, VSP G1500, and VSP F1500)	<p>Type of clock used for consistency time. A hyphen (-) is displayed for UR pairs.</p> <ul style="list-style-type: none"> • System: Mainframe system clock • Local: System clock is not used • None: Mainframe system clock
Create Journals	Opens the Create Journals window

Item	Description
Edit Journal Options	Opens the Edit Journal Options window
Delete Journals	Opens the Delete Journals window
More Actions	When clicked, opens menu for accessing: <ul style="list-style-type: none"> Assign MP Blade ID or MP Unit ID window Force Remove Journals from EXCTG window (VSP G1000, VSP G1500, and VSP F1500) Export window
*These items do not appear in the table by default. To display these items, you must change the column settings for the table (click Column Settings).	

EXCTGs tab (VSP G1000, VSP G1500, and VSP F1500)

EXCTG ID	Attribute	Number of Storage Systems	Number of Journals	Assigned Mirror ID
00	Free	0	0	-
01	Free	0	0	-
02	Free	0	0	-
03	Free	0	0	-

Item	Description
Add Journals	Clicking opens the Add Journal window, which is used to register journals in an EXCTG.
Remove Journals	Clicking opens the Remove Journal window, which is used to remove journals from an EXCTG.
Initialize EXCTGs	Clicking the link opens the Initialize EXCTGs window, which is used to remove all journals from an EXCTG.
Export	Clicking opens a window for exporting information about the EXCTG.
EXCTG ID	EXCTG identifier. Clicking the link opens the EXCTG Properties window.
Attribute	EXCTG attributes, which can be: <ul style="list-style-type: none"> Master: Primary storage system EXCTG Restore: Secondary storage system EXCTG Initializing: Journal deletion is in progress.

Item	Description
	<ul style="list-style-type: none"> Free: No journal is registered in the EXCTG. Updating: Registering journals is in process.
Number of Storage Systems	Number of storage systems registered in the EXCTG.
Number of Journals	Number of journals registered in the EXCTG.
Assigned Mirror ID	EXCTG's mirror identifier.

Journal Volumes window

Use this window to view detailed information about individual journals, including the mirrors and journal volumes assigned to it.

The screenshot shows the 'Journal Volumes' window for journal ID 000. At the top, there is a summary table with the following data:

Journal ID	000	MP Blade ID	MPB0
Journal Type	UR	Encryption	Enabled
Attribute	Master	Inflow Control	Enabled
Number of Journal Volumes	1 (Max Allowed: 2)	Data Overflow Watch	60 Second(s)
Journal Capacity	20.00 GB	Cache Mode	Enabled
Number of Data Volumes	1 (Max Allowed: 8192)	Timer Type	-
Data Capacity	51.25 MB		

Below the summary table is a detailed table of mirrors and journal volumes. The table has the following columns: Mirror ID, Attribute, Status, Remote Storage System (Model / Serial Number, Journal ID), Path Group ID, Number of Data VOLS, Data Capacity, and Remote Command Device. The data is as follows:

Mirror ID	Attribute	Status	Remote Storage System		Path Group ID	Number of Data VOLS	Data Capacity	Remote Command Device
			Model / Serial Number	Journal ID				
0	Master	Active / ...	VSP G1000 / 02606	001	00	1	0.05 GB	
1	Initial	Initial / ...	-	-	-	0	0.00 GB	-
2	Initial	Initial / ...	-	-	-	0	0.00 GB	-
3	Initial	Initial / ...	-	-	-	0	0.00 GB	-

Summary section

Item	Description
Journal ID	Journal identifier.
Journal Type (VSP G1000, VSP G1500, and VSP F1500)	Journal copy type, UR or URMF.
Attribute	Whether the journal is Master, Restore, Master/Restore, or Initial (registered but no pair volumes assigned).
Number of Journal VOLs	Number of journal volumes registered in the journal, with the maximum number allowed in parentheses.
Journal Capacity	Capacity of the journal volume registered in the journal. If two journal volumes are registered, the capacity of the reserve journal volume is subtracted from the total capacity.
Number of Data VOLs	<p>Number of volumes associated with the journal.</p> <p>(VSP G1000, VSP G1500, and VSP F1500) If the journal uses multiple mirror IDs, volumes in mirrors with Hold, Holding, or Hold(Failure) status are not included.</p> <p>(VSP Gx00 models and VSP Fx00 models) With the delta resync configuration, the number of data volumes registered to the journal of the mirrors not for delta resync is displayed. The number of volumes registered to the journal of the delta resync mirrors (whose status is Hold, Holding, or Hold(Failure)) is not displayed.</p>
Data Capacity	<p>Total capacity of all the associated volumes.</p> <p>(VSP G1000, VSP G1500, and VSP F1500) If the journal uses multiple mirror IDs, volumes in mirrors with Hold, Holding, or Hold(Failure) status are not included.</p> <p>(VSP Gx00 models and VSP Fx00 models)With the delta resync configuration, the number of data volumes registered to the journal of the mirrors not for delta resync is displayed. The number of volumes registered to the journal of the delta resync mirrors (whose status is Hold, Holding, or Hold(Failure)) is not displayed.</p>
MP Blade IDor MP Unit ID	MP blade or unit identifier
Encryption	<p>Journal's encryption information:</p> <ul style="list-style-type: none"> • Enabled: The journal contains only encrypted volumes. • Disabled: The journal contains only unencrypted volumes. • Mixed: The pool to which the journal volume belongs contains two or more of the following: <ul style="list-style-type: none"> ○ Volume for which encryption is enabled ○ Volume for which encryption is disabled ○ External volume <p>Note: Encryption of data is not ensured in an LDEV with the Mixed encryption status. To manage data encryption, use an LDEV in which Encryption is Enabled or Disabled.</p> <ul style="list-style-type: none"> • Hyphen (-): The pool to which the journal volume belongs is an external volume, created in a migration volume (VSP G1000, VSP G1500, and VSP F1500), or blocked.

Item	Description
Inflow Control	Whether flow of update data to the journal volume is restricted by slowing the response to hosts.
Data Overflow Watch	Number of seconds the system monitors metadata and journal data when the journal volume is full (100%). A hyphen (-) displays if Inflow Control is disabled.
Cache Mode	Whether journal data is stored in cache memory on the remote side (restore journal). <ul style="list-style-type: none"> • Enable: Journal data is stored in cache memory. When the available cache memory becomes insufficient, the journal data is also stored in a journal volume. • Disable: Journal data is stored in a journal volume instead of cache memory. This setting is disabled in the master journal. However, this setting is enabled if you use the <code>horctakeover</code> command of CCI (for Universal Replicator) or the <code>YKRESYNC REVERSE</code> command of Business Continuity Manager (for Universal Replicator for Mainframe) to change the master journal to the restore journal.
Timer Type (VSP G1000, VSP G1500, and VSP F1500)	Type of clock used for consistency time. A hyphen (-) is displayed for UR pairs. <ul style="list-style-type: none"> • System: Mainframe system clock • Local: System clock is not used • None: Mainframe system clock

Mirrors tab

This tab displays information about the selected journal's mirrors.

Mirror ID	Attribute	Status	Remote Storage System		Path Group ID	Number of Data VOLs	Data Capacity	Remote Command...
			Model / Serial Number	Journal ID				
0	Restore	Active / ...	VSP G1000 / 12345	0FC	00	1	0.00 GB	
1	Master	Active / ...	VSP G1000 / 12345	001	00	1	0.05 GB	
2	Initial	Initial / ...	-	-	-	0	0.00 GB	-
3	Initial	Initial / ...	-	-	-	0	0.00 GB	-

Item	Description
Mirror ID	Mirror identifier.
Attribute	Whether the journal is Master, Restore, or Initial (registered but no pair volumes assigned).
Status	Mirror's status. For definitions, see Monitoring journal (mirror) status on page 202 .
Remote Storage System	Displays the following information about the system connected to the system you accessed.: <ul style="list-style-type: none"> • Model/Serial Number: Storage system model and serial number. A hyphen displays if the mirror attribute is Initial. • Journal ID: Journal identifier. A hyphen displays if the mirror attribute is Initial.

Item	Description
Path Group ID	Path group identifier specified during pair creation.
Number of Data VOLs	<p>Number of volumes associated with the journal.</p> <p>(VSP G1000, VSP G1500, and VSP F1500) If the journal uses multiple mirror IDs, volumes in mirrors with Hold, Holding, or Hold(Failure) status are not included.</p> <p>(VSP Gx00 models and VSP Fx00 models) With the delta resync configuration, the number of data volumes registered to the journal of the mirrors not for delta resync is displayed. The number of volumes registered to the journal of the delta resync mirrors (whose status is Hold, Holding, or Hold(Failure)) is not displayed.</p>
Data Capacity	<p>Total capacity of all the associated volumes.</p> <p>(VSP G1000, VSP G1500, and VSP F1500) If the journal uses multiple mirror IDs, volumes in mirrors with Hold, Holding, or Hold(Failure) status are not included.</p> <p>(VSP Gx00 models and VSP Fx00 models) With the delta resync configuration, the number of data volumes registered to the journal of the mirrors not for delta resync is displayed. The number of volumes registered to the journal of the delta resync mirrors (whose status is Hold, Holding, or Hold(Failure)) is not displayed.</p>
Remote Command Device	<p>LDEV number of the remote command device if it is assigned to the mirror.</p> <ul style="list-style-type: none"> • The column is blank if the remote command device is not assigned to the mirror. • A hyphen (-) indicates the remote command device cannot be assigned to the mirror.
CTG ID*	Mirror's consistency group identifier. A hyphen indicates there is no consistency group.
CTG Utilization*	<p>Whether the consistency group is shared by multiple storage systems.</p> <ul style="list-style-type: none"> • Single: The consistency group consists of a single pair of primary and secondary storage systems. • Multi: The consistency group consists of multiple storage systems.
EXCTG Setting* (VSP G1000, VSP G1500, and VSP F1500)	<p>Displays the EXCTG ID and Super DKC (device name and serial number).</p> <p>A hyphen (-) displays when no journal is registered in the EXCTG.</p>
Path Watch Time*	Interval from the time a path becomes blocked to the time when the mirror is suspended. A hyphen indicates if the status of the secondary mirror on the primary storage system is Hold, Holding or Hold(Failure).
Path Watch Time Transfer*	<p>Whether to assign the master journal's Path Watch Time value to the restore journal.</p> <p>When transferred, the Path Watch Time values of the mirror's primary side (MCU) and the secondary side (RCU) will be consistent.</p> <ul style="list-style-type: none"> • Yes: Path Watch Time value will be transferred to the mirror's secondary side (RCU). • No: Path Watch Time value will not be transferred to the mirror's secondary side (RCU).
Copy Pace*	Pace for copying data during initial copy: Slower (default), Medium, Faster. A hyphen indicates that the journal is a restore journal.
Transfer Speed*	Data transfer line speed in Mbps (megabits per second): 3, 10, 100, or 256.

Item	Description
Delta Resync Failure*	Processing that takes place in the event of delta resync operation failure Entire Copy, No Copy. <ul style="list-style-type: none"> Entire Copy: The entire P-VOL is copied to the S-VOL. No Copy: No processing occurs. The S-VOL is not updated.
Split Mirrors	Opens the Split Mirrors window.
Resync Mirrors	Opens the Resync Mirrors window.
Create UR Pairs	Opens the Create UR Pairs window
More Actions	When clicked, opens a menu for accessing: <ul style="list-style-type: none"> Edit Mirror Options window View Remote Connection Properties window Delete Mirrors window Assign Remote Command Devices window Release Remote Command Devices window Export window
*These items do not appear in the table by default. To display these items, you must change the column settings for the table (click Column Settings).	

Journal Volumes tab

This tab displays information about the selected journal's journal volumes.

Item	Description
LDEV ID	Journal volume's identifier consisting of the LDKC number, CU number, and LDEV number. Clicking the link opens the LDEV Properties window.
LDEV Name	Name of the journal volume's LDEV.
Pool Name (ID)	Identifier consisting of the pool name and the pool ID. Clicking the link opens a window with pool information.
RAID Level	Type of RAID implementation for the journal volume.
Capacity	Journal volume's capacity.
CLPR	Journal volume's CLPR. The CLPR ID is displayed before the colon, and the CLPR name is displayed after the colon.
Encryption*	Encryption information: <ul style="list-style-type: none"> Enabled: Encryption of the parity group to which the LDEV belongs is enabled, or a V-VOL is associated with a pool in which a pool volume has encryption enabled.

Item	Description
	<ul style="list-style-type: none"> • Disabled: Encryption of the parity group to which the LDEV belongs is disabled, or a V-VOL is associated with a pool in which a pool volume has encryption disabled. • Mixed: The pool to which the LDEV belongs contains two or more of the following: <ul style="list-style-type: none"> ○ Volume for which encryption is enabled ○ Volume for which encryption is disabled ○ External volume <p>Note: Encryption of data is not ensured in an LDEV with the Mixed encryption status. To manage data encryption, use an LDEV in which Encryption is Enabled or Disabled.</p> <ul style="list-style-type: none"> • Hyphen (-): The LDEV is an external volume. For DP-VOL or DP-VOL for Mainframe, the pool to which the LDEV belongs is either an external volume or blocked.
Resource Group Name (ID)	LDEV's resource group name and identifier. The ID is enclosed in parentheses.
Type	Type of journal volume: <ul style="list-style-type: none"> • Journal: Journal volume • Reserve Journal: Reserve journal volume
Assign Journal Volumes	Opens the Assign Journal Volumes window.
Export	Opens the window for exporting table information
*This item does not appear in the table by default. To display this item, you must change the column settings for the table (click Column Settings).	

Journal Properties window

Use this window to view information about the selected journal.

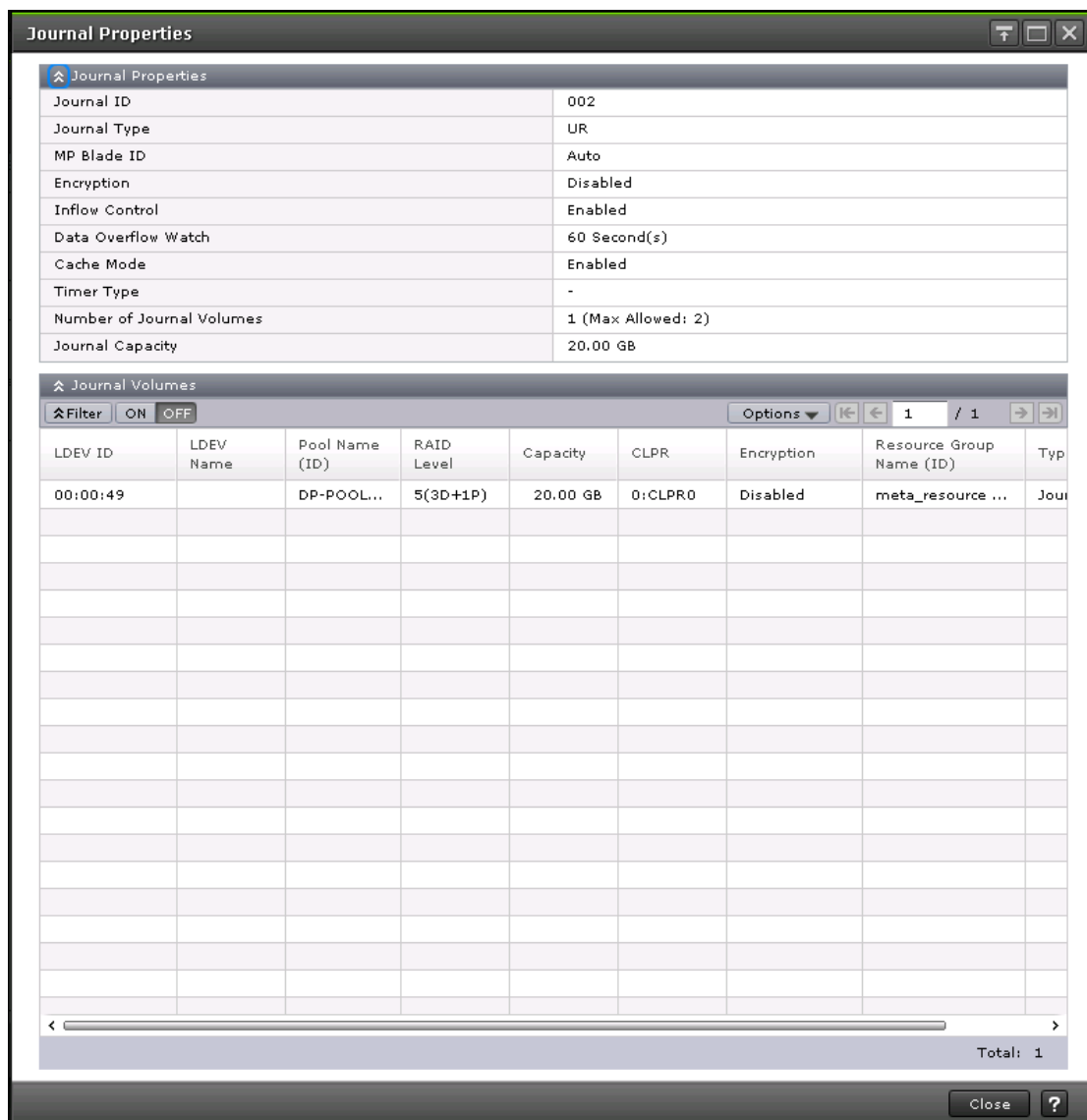

Journal Properties table

Item	Description
Journal ID	Journal identifier.
Journal Type (VSP G1000, VSP G1500, and VSP F1500)	Journal copy type, UR or URMF.
MP Blade ID or MP Unit ID	MP blade or unit identifier
Encryption	Journal's encryption information: <ul style="list-style-type: none"> • Enabled: The journal contains only encrypted volumes. • Disabled: The journal contains only unencrypted volumes.

Item	Description
	<ul style="list-style-type: none"> Mixed: The pool to which the journal volume belongs contains two or more of the following: <ul style="list-style-type: none"> Volume for which encryption is enabled Volume for which encryption is disabled External volume <p>Note: Encryption of data is not ensured in an LDEV with the Mixed encryption status. To manage data encryption, use an LDEV in which Encryption is Enabled or Disabled.</p> <ul style="list-style-type: none"> Hyphen (-): The pool to which the journal volume belongs is an external volume, created in a migration volume (VSP G1000, VSP G1500, and VSP F1500), or blocked.
Inflow Control	Indicates whether the flow of update data to the journal volume is restricted by slowing the response to hosts.
Data Overflow Watch	Number of seconds the system monitors metadata and journal data when the journal volume is full (100%). A hyphen (-) displays if Inflow Control is disabled.
Cache Mode	Whether journal data is stored in cache memory on the remote side (restore journal). <ul style="list-style-type: none"> Enable: Journal data is stored in cache memory. When the available cache memory becomes insufficient, the journal data is also stored in a journal volume. Disable: Journal data is stored in a journal volume instead of cache memory. This setting is disabled in the master journal. However, this setting is enabled if you use the <code>horctakeover</code> command of CCI (for Universal Replicator) or the <code>YKRESYNC REVERSE</code> command of Business Continuity Manager (for Universal Replicator for Mainframe) to change the master journal to the restore journal.
Timer Type (VSP G1000, VSP G1500, and VSP F1500)	URz only. Type of clock used for consistency time. A hyphen (-) is displayed when Copy Type is UR. <ul style="list-style-type: none"> System: Mainframe system clock Local: System clock is not used None: Mainframe system clock
Number of Journal VOLs	Number of journal volumes registered in the journal, with the maximum number allowed in parentheses.
Journal Capacity	Capacity of the journal volume registered in the journal. If two journal volumes are registered, the capacity of the reserve journal volume is subtracted from the total capacity.

Journal Volumes table

Item	Description
LDEV ID	Journal volume's identifier consisting of the LDKC number, CU number, and LDEV number. Clicking the link opens the LDEV Properties window.
LDEV Name	Name of the journal volume's LDEV.
Pool Name (ID)	Identifier consisting of the pool name and the pool ID. Clicking the link opens a window with pool information.
RAID Level	Type of RAID implementation for the journal volume.

Item	Description
Capacity	Journal volume's capacity.
CLPR	Journal volume's CLPR. The CLPR ID is displayed before the colon, and the CLPR name is displayed after the colon.
Encryption	<p>Encryption information:</p> <ul style="list-style-type: none"> • Enabled: Encryption of the parity group to which the LDEV belongs is enabled, or a V-VOL is associated with a pool in which a pool volume has encryption enabled. • Disabled: Encryption of the parity group to which the LDEV belongs is disabled, or a V-VOL is associated with a pool in which a pool volume has encryption disabled. • Mixed: The pool to which the LDEV belongs contains two or more of the following: <ul style="list-style-type: none"> ○ Volume for which encryption is enabled ○ Volume for which encryption is disabled ○ External volume <p>Note: Encryption of data is not ensured in an LDEV with the Mixed encryption status. To manage data encryption, use an LDEV in which Encryption is Enabled or Disabled.</p> <ul style="list-style-type: none"> • Hyphen (-): The LDEV is an external volume. For DP-VOL or DP-VOL for Mainframe, the pool to which the LDEV belongs is either an external volume or blocked.
Resource Group Name (ID)	LDEV's resource group name and identifier. The ID is enclosed in parentheses.
Type	<p>Type of journal volume:</p> <ul style="list-style-type: none"> • Journal: Journal volume • Reserve Journal: Reserve journal volume

Create Journals wizard

Use this wizard to create journals and add journal volumes.

Create Journals window

Use this window to create journals and add journal volumes.

For instructions, see the procedure in [Creating journals and adding journal volumes on page 120](#).

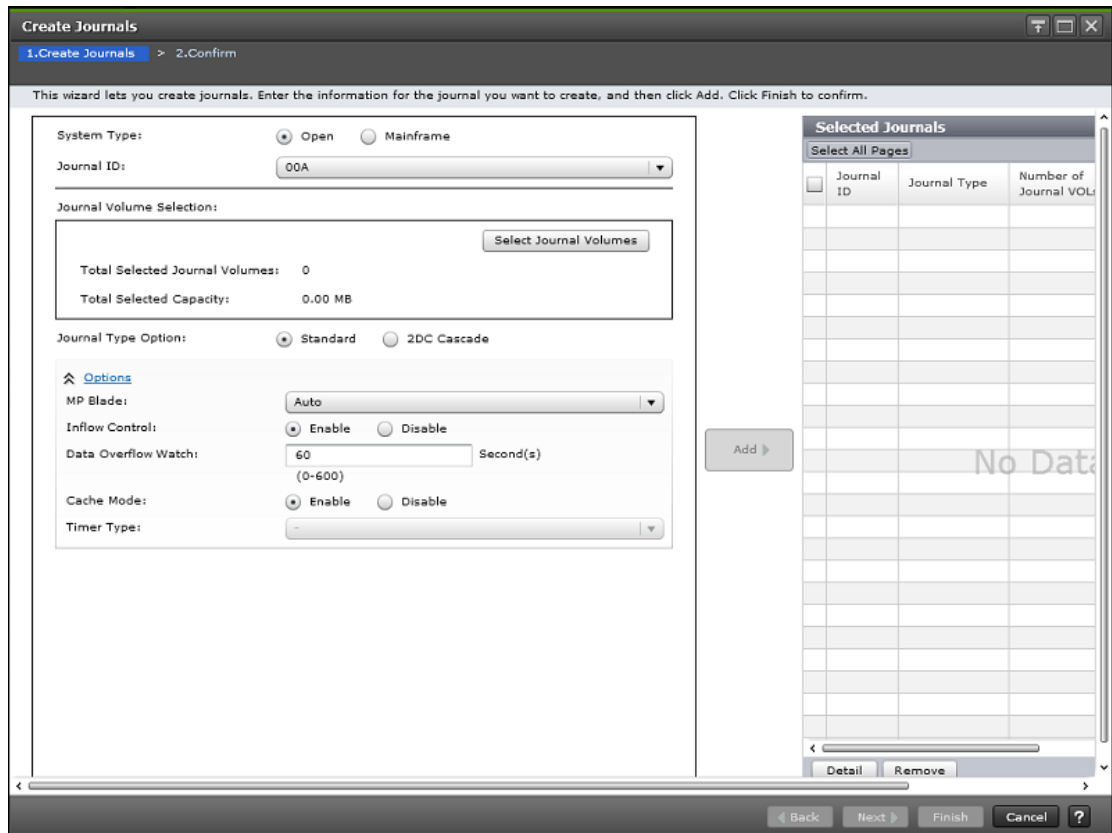

Settings

Item	Description
System Type (VSP G1000, VSP G1500, and VSP F1500)	Storage system type: Open or Mainframe.
Journal ID	Identifier for the journal, displayed in ascending order. Blank if no number is available.
Journal Volume Selection	<ul style="list-style-type: none"> Select Journal Volumes: When clicked, opens the Select Journal Volumes dialog box. Total Selected Journal Volumes: Number of selected journal volumes. Total Selected Capacity: Capacity of selected journal volumes.
Total Selected Journal Volumes	Number of journal volumes selected in the Select Journal Volumes dialog box.
Total Selected Capacity	Total capacity of the journal volume selected in the Select Journal Volumes dialog box.
Journal Type Option (VSP G1000, VSP G1500, and VSP F1500)	Types of journal options that can be specified. <ul style="list-style-type: none"> Standard (default): The journal is used in the following configurations: <ul style="list-style-type: none"> UR or URMF pair The following 3DC multi-target or 3DC cascade configurations: <ul style="list-style-type: none"> Universal Replicator and TrueCopy

Item	Description
	<ul style="list-style-type: none"> - Universal Replicator and Universal Replicator - Universal Replicator and global-active device - Universal Replicator for Mainframe and TrueCopy for Mainframe - Universal Replicator for Mainframe and Universal Replicator for Mainframe <ul style="list-style-type: none"> • 2DC Cascade: Journals used in a 2DC cascade configuration of Universal Replicator and TrueCopy. This item can be selected only when Open is selected for System Type.
MP Blade ID or MP Unit ID	<p>Journal MP blade or unit. Options are:</p> <ul style="list-style-type: none"> • (VSP G1000, VSP G1500, and VSP F1500) MPB0-MPB7. • Auto: The default. Available when one or more MP blade or units can be assigned automatically. If Auto cannot be selected, the default is the MP blade or unit with the lowest number.
Inflow Control	<p>Controls the flow of update data to the journal volume by slowing the response to hosts.</p> <ul style="list-style-type: none"> • Enable: The flow of update data is restricted. • Disable: The flow of update data is not restricted.
Data Overflow Watch	<p>Number of seconds the system will monitor metadata and journal data when the journal volume is full (100%). When the metadata area or journal data area is full and no more data can be stored, the system regards this as an error and suspends the pairs in the journal. Range is 0-600 seconds. The UR default is 60; the URz default is 20.</p> <p>In a 3DC multi-target configuration in which three UR sites are combined, if the status of the two mirrors in the primary site is Active and the free space in the journal data area or metadata area is less than a certain amount, one of the mirrors in the journal will be suspended by error, regardless of the value in Data Overflow Watch.</p>
Cache Mode	<p>Whether to store journal data in cache memory on the restore journal.</p> <ul style="list-style-type: none"> • Enable: Journal data is stored in cache memory. When the available cache memory becomes insufficient, the journal data is also stored in a journal volume. • Disable: Journal data is stored in a journal volume instead of cache memory. This setting is disabled in the master journal. However, this setting is enabled if you use the <code>horctakeover</code> command of CCI (for Universal Replicator) or the <code>YKRESYNC REVERSE</code> command of Business Continuity Manager (for Universal Replicator for Mainframe) to change the master journal to the restore journal.
Timer Type (VSP G1000, VSP G1500, and VSP F1500)	<p>Type of clock used for consistency time. Values must be the same on primary and secondary storage systems. Displayed only when Mainframe is selected for System Type.</p> <ul style="list-style-type: none"> • System: The local storage system acquires the time-stamp information for each journal data. <p>When a URz pair is created, the local storage system reports state-change-interrupt (SCI) to all hosts. The host then issues a series of sense group commands to determine the device status change. The local storage system returns the same response as if the device was added to an XRC session to activate I/O time-stamping for the device. When I/O time-stamping is activated, the MVS IOS routine adds the time stamp information (contents of time-of-day (TOD) clock) to each write I/O instruction for the device. A time stamp indicates the time when an update was made on the main host during start sub-channel (SSCH). Time stamps are transferred to the local storage system at each start I/O instruction.</p> <ul style="list-style-type: none"> • Local: The local storage system does not obtain time stamp information from host I/O time stamp.

Item	Description
	<ul style="list-style-type: none"> None: The local storage system obtains time stamp information from host I/O time stamp. Available only when copy direction is reversed, S-VOL to P-VOL.
Add	The journal setting in left hand side window is added to the Selected Journals table.

Selected Journals table

Item	Description
Journal ID	Identifier for the journal LDEV, displayed in ascending order. Blank if no number is available.
Journal Type (VSP G1000, VSP G1500, and VSP F1500)	Journal copy type, UR or URMF.
Number of Journal VOLS	Number of journal volumes registered in the journal.
Journal Capacity	Capacity of the journal volume registered in the journal. If two journal volumes are registered, the capacity of the reserve journal volume is subtracted from the total capacity.
MP Blade ID or MP Unit ID	MP blade or unit identifier
Encryption	<p>Journal's encryption information:</p> <ul style="list-style-type: none"> Enabled: The journal contains only encrypted volumes. Disabled: The journal contains only unencrypted volumes. Mixed: The pool to which the journal volume belongs contains two or more of the following: <ul style="list-style-type: none"> Volume for which encryption is enabled Volume for which encryption is disabled External volume <p>Note: Encryption of data is not ensured in an LDEV with the Mixed encryption status. To manage data encryption, use an LDEV in which Encryption is Enabled or Disabled.</p> <ul style="list-style-type: none"> Hyphen (-): The pool to which the journal volume belongs is an external volume, created by migration (VSP G1000, VSP G1500, and VSP F1500), or blocked.
Inflow Control	Whether flow of update data to the journal volume is restricted by slowing the response to hosts.
Data Overflow Watch (sec)	Number of seconds the system monitors metadata and journal data when the journal volume is full (100%). A hyphen (-) displays if Inflow Control is disabled.
Cache Mode	<p>Indicates whether journal data is stored in cache memory on the restore journal.</p> <ul style="list-style-type: none"> Enable: Journal data is stored in cache memory. When the available cache memory becomes insufficient, the journal data is also stored in a journal volume. Disable: Journal data is stored in a journal volume instead of cache memory. This setting is disabled in the master journal. However, this setting is enabled if you use the <code>horctakeover</code> command of CCI (for Universal

Item	Description
	Replicator) or the YKRESYNC REVERSE command of Business Continuity Manager (for Universal Replicator for Mainframe) to change the master journal to the restore journal.
Timer Type (VSP G1000, VSP G1500, and VSP F1500)	Type of clock used for consistency time. A hyphen (-) is displayed when UR is selected for Copy Type. <ul style="list-style-type: none"> System: Mainframe system clock Local: System clock is not used None: Mainframe system clock
Detail	Opens the Journal Properties window for the selected journal.
Remove	Removes the selected journal from the list.

Select Journal Volumes dialog box

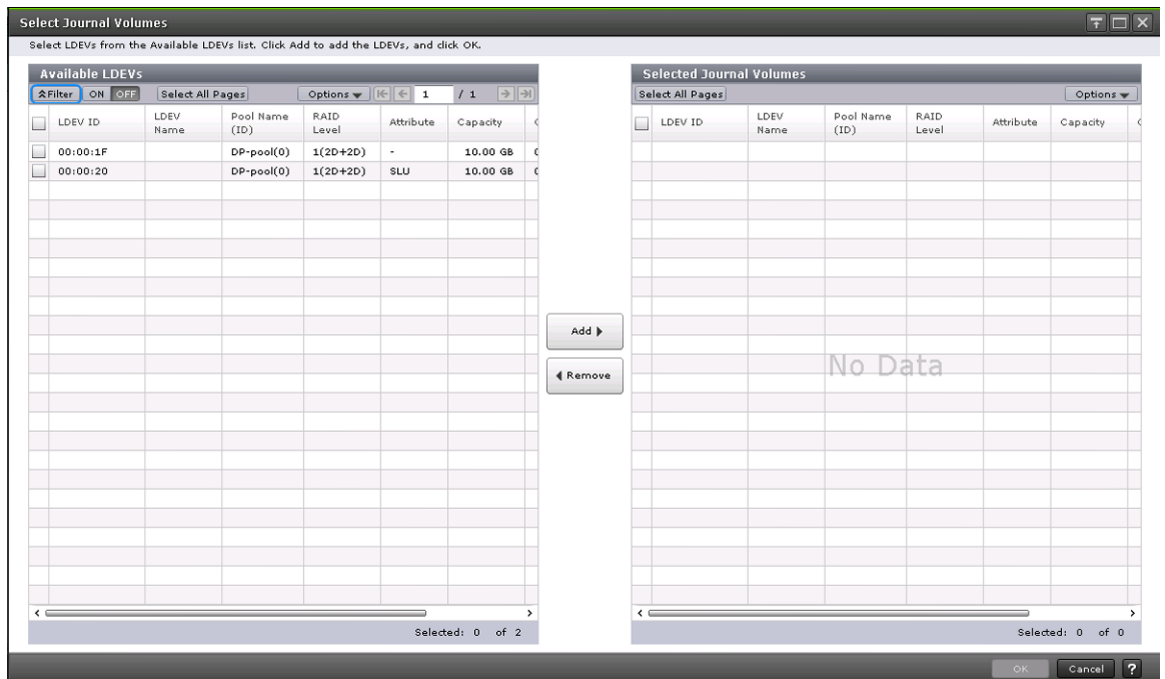

Available LDEVs table

Item	Description
LDEV ID	Journal volume's identifier consisting of the LDKC number, CU number, and LDEV number.
LDEV Name	Name of the journal volume's LDEV.
Pool Name (ID)	Identifier consisting of the pool name and the pool ID. Clicking the link opens a window with pool information.
RAID Level	Type of RAID implementation for the journal volume.

Item	Description
Attribute	Journal volume's attribute. <ul style="list-style-type: none"> • SLU: Volume with SLU attribute. • - (hyphen): The attribute is not set.
Capacity	Journal volume's capacity.
CLPR	Journal volume's CLPR. The CLPR ID is displayed before the colon, and the CLPR name is displayed after the colon.
Encryption	Encryption information: <ul style="list-style-type: none"> • Enabled: Encryption of the parity group to which the LDEV belongs is enabled, or a V-VOL is associated with a pool in which a pool volume has encryption enabled. • Disabled: Encryption of the parity group to which the LDEV belongs is disabled, or a V-VOL is associated with a pool in which a pool volume has encryption disabled. • Mixed: The pool to which the LDEV belongs contains two or more of the following: <ul style="list-style-type: none"> ○ Volume for which encryption is enabled ○ Volume for which encryption is disabled ○ External volume <p>Note: Encryption of data is not ensured in an LDEV with the Mixed encryption status. To manage data encryption, use an LDEV of which Encryption is Enabled or Disabled.</p> <ul style="list-style-type: none"> • Hyphen (-) : The LDEV is an external volume. For DP-VOL or DP-VOL for Mainframe, the pool to which the LDEV belongs is either an external volume or blocked.
Resource Group Name (ID)	LDEV's resource group name and identifier. The ID is enclosed in parentheses.
Add	The LDEV selected from the Available LDEVs table is added to the Selected Journal Volumes table.
Remove	The selected journal volume is removed from the Selected Journal Volumes table.

Selected Journal Volumes table

Item	Description
LDEV ID	Journal volume's identifier consisting of the LDKC number, CU number, and LDEV number.
LDEV Name	Name of the journal volume's LDEV.
Pool Name (ID)	Identifier consisting of the pool name and the pool ID. Clicking the link opens a window with pool information.
RAID Level	Type of RAID implementation for the journal volume.
Attribute	Journal volume's attribute. <ul style="list-style-type: none"> • SLU: Volume with SLU attribute. • - (hyphen): The attribute is not set.
Capacity	Journal volume's capacity.
CLPR	Journal volume's CLPR. The CLPR ID is displayed before the colon, and the CLPR name is displayed after the colon.
Encryption	Encryption information:

Item	Description
	<ul style="list-style-type: none"> Enabled: Encryption of the parity group to which the LDEV belongs is enabled, or a V-VOL is associated with a pool in which a pool volume has encryption enabled. Disabled: Encryption of the parity group to which the LDEV belongs is disabled, or a V-VOL is associated with a pool in which a pool volume has encryption disabled. Mixed: The pool to which the LDEV belongs contains two or more of the following: <ul style="list-style-type: none"> Volume for which encryption is enabled Volume for which encryption is disabled External volume <p>Note: Encryption of data is not ensured in an LDEV with the Mixed encryption status. To manage data encryption, use an LDEV of which Encryption is Enabled or Disabled.</p> <ul style="list-style-type: none"> Hyphen (-) : The LDEV is an external volume. For DP-VOL or DP-VOL for Mainframe, the pool to which the LDEV belongs is either an external volume or blocked.
Resource Group Name (ID)	LDEV's resource group name and identifier. The ID is enclosed in parentheses.

Create Journals confirmation window

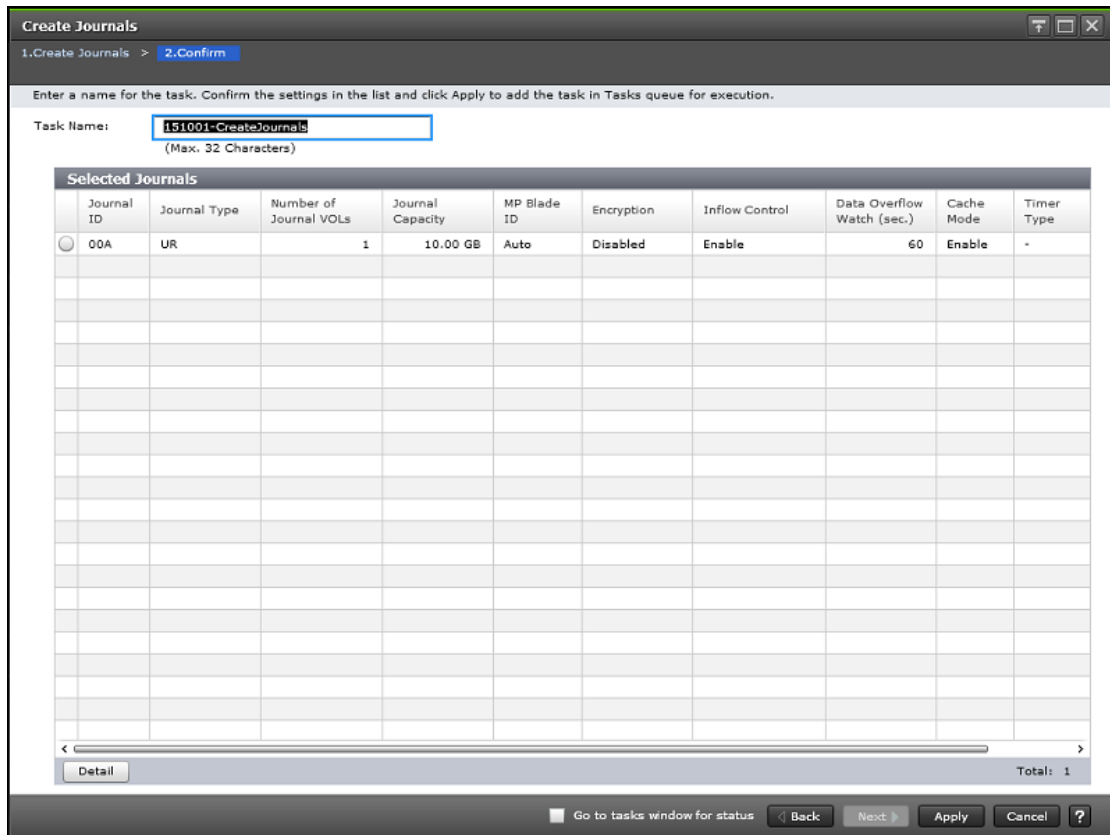

Item	Description
Journal ID	Identifier for the journal LDEV, displayed in ascending order. Blank if no number is available.
Journal Type (VSP G1000, VSP G1500, and VSP F1500)	Journal copy type, UR or URMF.
Number of Journal VOLs	Number of journal volumes registered in the journal.
Journal Capacity	Capacity of the journal volume registered in the journal. If two journal volumes are registered, the capacity of the reserve journal volume is subtracted from the total capacity.
MP Blade ID or MP Unit ID	MP blade or unit identifier
Encryption	<p>Journal's encryption information:</p> <ul style="list-style-type: none"> • Enabled: The journal contains only encrypted volumes. • Disabled: The journal contains only unencrypted volumes. • Mixed: The pool to which the journal volume belongs contains two or more of the following: <ul style="list-style-type: none"> ○ Volume for which encryption is enabled ○ Volume for which encryption is disabled ○ External volume <p>Note: Encryption of data is not ensured in an LDEV with the Mixed encryption status. To manage data encryption, use an LDEV in which Encryption is Enabled or Disabled.</p> <ul style="list-style-type: none"> • Hyphen (-): The pool to which the journal volume belongs is an external volume, created in a migration volume (VSP G1000, VSP G1500, and VSP F1500), or blocked.
Inflow Control	Whether flow of update data to the journal volume is restricted by slowing the response to hosts.
Data Overflow Watch (sec)	Number of seconds the system monitors metadata and journal data when the journal volume is full (100%). A hyphen (-) displays if Inflow Control is disabled.
Cache Mode	<p>Indicates whether journal data is stored in cache memory on the restore journal.</p> <ul style="list-style-type: none"> • Enable: Journal data is stored in cache memory. When the available cache memory becomes insufficient, the journal data is also stored in a journal volume. • Disable: Journal data is stored in a journal volume instead of cache memory. This setting is disabled in the master journal. However, this setting is enabled if you use the <code>horctakeover</code> command of CCI (for Universal Replicator) or the <code>YKRESYNC REVERSE</code> command of Business Continuity Manager (for Universal Replicator for Mainframe) to change the master journal to the restore journal.
Timer Type (VSP G1000, VSP G1500, and VSP F1500)	<p>URz only.</p> <p>Type of clock used for consistency time. A hyphen (-) is displayed for UR pairs.</p> <ul style="list-style-type: none"> • System: Mainframe system clock • Local: System clock is not used • None: Mainframe system clock
Detail	Opens the Journal Properties window for the selected journal.

Assign Journal Volumes wizard

Use this wizard to assign journal volumes to a journal.

Assign Journal Volumes window

Use this window to assign journal volumes to a journal.

For instructions, see [Creating journals and adding journal volumes on page 120](#) and [Adding an additional journal volume to an existing journal on page 215](#).

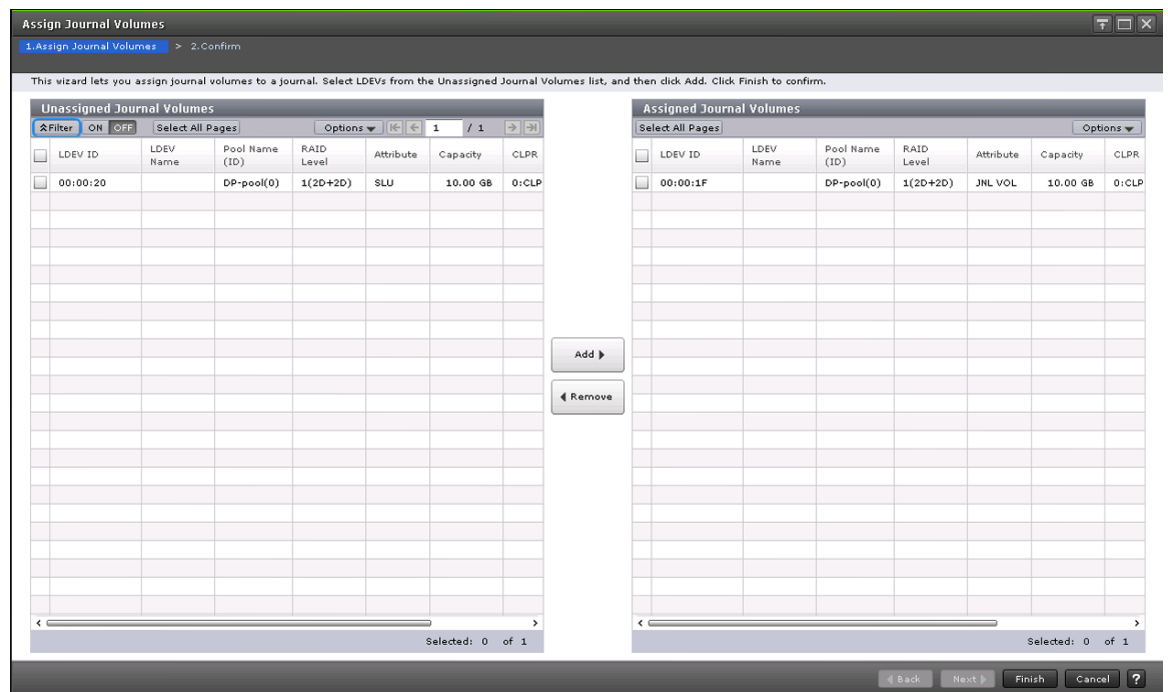

Unassigned Journal Volumes table

Item	Description
LDEV ID	Journal volume's LDEV identifier: LDKC number, CU number and LDEV number.
LDEV Name	Journal volume's LDEV name.
Pool Name (ID)	Journal volume's pool name and ID.
RAID Level	Journal volume's RAID level.
Attribute	Journal volume's attribute: <ul style="list-style-type: none"> JNL VOL: Journal volume SLU: Volume with SLU attribute. - (hyphen): The attribute is not set.

Item	Description
Capacity	Journal volume capacity.
CLPR	Journal volume's CLPR ID and name.
Encryption	<p>Encryption information:</p> <ul style="list-style-type: none"> • Enabled: Encryption of the parity group to which the LDEV belongs is enabled, or a V-VOL is associated with a pool in which a pool volume has encryption enabled. • Disabled: Encryption of the parity group to which the LDEV belongs is disabled, or a V-VOL is associated with a pool in which a pool volume has encryption disabled. • Mixed: The pool to which the LDEV belongs contains two or more of the following: <ul style="list-style-type: none"> ○ Volume for which encryption is enabled ○ Volume for which encryption is disabled ○ External volume <p>Note: Encryption of data is not ensured in an LDEV with the Mixed encryption status. To manage data encryption, use an LDEV in which Encryption is Enabled or Disabled.</p> <ul style="list-style-type: none"> • Hyphen (-) : The LDEV is an external volume. For DP-VOL or DP-VOL for Mainframe, the pool to which the LDEV belongs is either an external volume or blocked.
Resource Group Name (ID)	LDEV's resource group name and ID (in parentheses).
Add	The journal volume selected from the Unassigned Journal Volumes table is added to the Assigned Journal Volumes table.
Remove	The selected journal volume is removed from the Assigned Journal Volumes table.

Assigned Journal Volumes table

Item	Description
LDEV ID	Journal volume's LDEV identifier: LDKC number, CU number and LDEV number.
LDEV Name	Journal volume's LDEV name.
Pool Name (ID)	Journal volume's pool name and ID.
RAID Level	Journal volume's RAID level.
Attribute	<p>Journal volume's attribute:</p> <ul style="list-style-type: none"> • JNL VOL: The volume is a journal volume. • SLU: Volume with SLU attribute. • - (hyphen): The attribute is not set.
Capacity	Journal volume capacity.
CLPR	Journal volume's CLPR ID and name.
Encryption	<p>Encryption information:</p> <ul style="list-style-type: none"> • Enabled: Encryption of the parity group to which the LDEV belongs is enabled, or a V-VOL is associated with a pool in which a pool volume has encryption enabled. • Disabled: Encryption of the parity group to which the LDEV belongs is disabled, or a V-VOL is associated with a pool in which a pool volume has encryption disabled.

Item	Description
	<ul style="list-style-type: none"> Mixed: The pool to which the LDEV belongs contains two or more of the following: <ul style="list-style-type: none"> Volume for which encryption is enabled Volume for which encryption is disabled External volume <p>Note: Encryption of data is not ensured in an LDEV with the Mixed encryption status. To manage data encryption, use an LDEV in which Encryption is Enabled or Disabled.</p> Hyphen (-) : The LDEV is an external volume. For DP-VOL or DP-VOL for Mainframe, the pool to which the LDEV belongs is either an external volume or blocked.
Resource Group Name (ID)	LDEV's resource group name and ID (in parentheses).
Removable	Whether the journal volumes can be removed (Yes or No). If the mirror status to which the journals belong is Active, the journal volumes cannot be removed.

Assign Journal Volumes confirmation window

Assign Journal Volumes

1.Assign Journal Volumes > 2.Confirm

⚠ Enter a name for the task. Confirm the settings in the list and click Apply to add task in Tasks queue for execution.

Task Name: (Max. 32 Characters)

Selected Journal

Journal ID
000

Assigned Journal Volumes

LDEV ID	LDEV Name	Type	Pool Name (ID)	RAID Level	Capacity	CLPR	Encryption	Resource Group Name (ID)
00:00:05	DP	Journal	DP_PL(0)	1(2D+2D)	10.00 GB	0:CLPR0	Disabled	meta_resource(0)
Total: 1								

Unassigned Journal Volumes

LDEV ID	LDEV Name	Type	Pool Name (ID)	RAID Level	Capacity	CLPR	Encryption	Resource Group Name (ID)
00:00:03	DP	Journal	DP_PL(0)	1(2D+2D)	10.00 GB	0:CLPR0	Disabled	meta_resource(0)
Total: 1								

Go to tasks window for status

Back Next Apply Cancel ?

Selected Journal table

Item	Description
Journal ID	Journal identifier.

Assigned Journal Volumes table

Item	Description
LDEV ID	Journal volume's LDEV identifier: LDKC number, CU number and LDEV number.
LDEV Name	Journal volume's LDEV name.
Type	Type of journal volume: <ul style="list-style-type: none"> • Journal: Journal volume • Reserve Journal: Reserve journal volume
Pool Name (ID)	Journal volume's pool name and ID.
RAID Level	Journal volume's RAID level.
Capacity	Journal volume capacity.
CLPR	Journal volume's CLPR ID and name.
Encryption	<p>Encryption information:</p> <ul style="list-style-type: none"> • Enabled: Encryption of the parity group to which the LDEV belongs is enabled, or a V-VOL is associated with a pool in which a pool volume has encryption enabled. • Disabled: Encryption of the parity group to which the LDEV belongs is disabled, or a V-VOL is associated with a pool in which a pool volume has encryption disabled. • Mixed: The pool to which the LDEV belongs contains two or more of the following: <ul style="list-style-type: none"> ○ Volume for which encryption is enabled ○ Volume for which encryption is disabled ○ External volume <p>Note: Encryption of data is not ensured in an LDEV with the Mixed encryption status. To manage data encryption, use an LDEV in which Encryption is Enabled or Disabled.</p> <ul style="list-style-type: none"> • Hyphen (-) : The LDEV is an external volume. For DP-VOL or DP-VOL for Mainframe, the pool to which the LDEV belongs is either an external volume or blocked.
Resource Group Name (ID)	LDEV's resource group name and ID (in parentheses).

Unassigned Journal Volumes table

Item	Description
LDEV ID	Journal volume's LDEV identifier: LDKC number, CU number and LDEV number.
LDEV Name	Journal volume's LDEV name.
Type	Type of journal volume: <ul style="list-style-type: none"> • Journal: Journal volume • Reserve Journal: Reserve journal volume
Pool Name (ID)	Journal volume's pool name and ID.

Item	Description
RAID Level	Journal volume's RAID level.
Capacity	Journal volume capacity.
CLPR	Journal volume's CLPR ID and name.
Encryption	<p>Encryption information:</p> <ul style="list-style-type: none"> Enabled: Encryption of the parity group to which the LDEV belongs is enabled, or a V-VOL is associated with a pool in which a pool volume has encryption enabled. Disabled: Encryption of the parity group to which the LDEV belongs is disabled, or a V-VOL is associated with a pool in which a pool volume has encryption disabled. Mixed: The pool to which the LDEV belongs contains two or more of the following: <ul style="list-style-type: none"> Volume for which encryption is enabled Volume for which encryption is disabled External volume <p>Note: Encryption of data is not ensured in an LDEV with the Mixed encryption status. To manage data encryption, use an LDEV in which Encryption is Enabled or Disabled.</p> <ul style="list-style-type: none"> Hyphen (-) : The LDEV is an external volume. For DP-VOL or DP-VOL for Mainframe, the pool to which the LDEV belongs is either an external volume or blocked.
Resource Group Name (ID)	LDEV's resource group name and ID (in parentheses).

Delete Journals window

Use this window to delete journals.

For instructions, see the procedure in [Deleting journals on page 219](#).

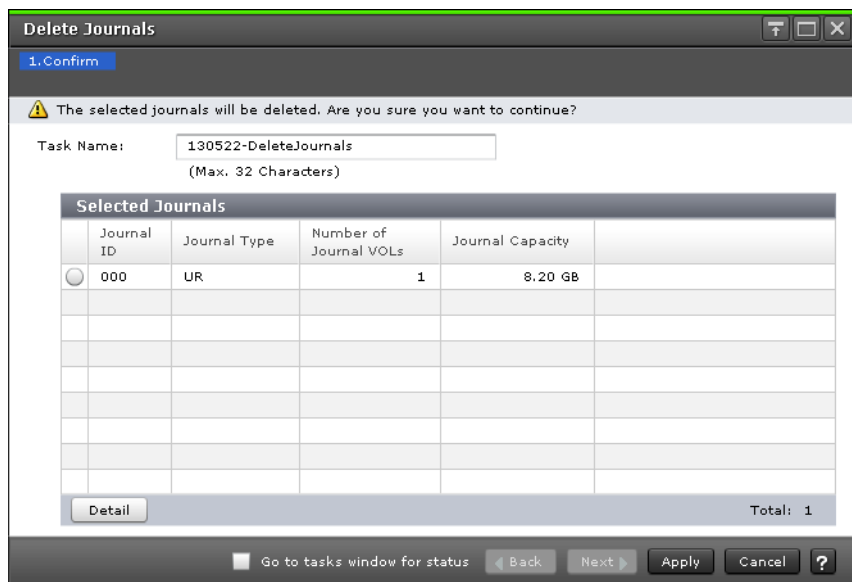

Item	Description
Journal ID	Journal identifier.
Journal Type (VSP G1000, VSP G1500, and VSP F1500)	Journal copy type, UR or URMF.
Number of Journal VOLs	Number of journal volumes registered in the journal.
Journal Capacity	Capacity of the journal volume registered in the journal. If two journal volumes are registered, the capacity of the reserve journal volume is subtracted from the total capacity.
Detail	Opens the Journal Properties window for the selected journal.

Edit Journal Options wizard

Use this wizard to change journal options.

Edit Journal Options window

Use this window to change journal options.

For instructions, see the procedure in [Changing options used by journals on page 211](#).

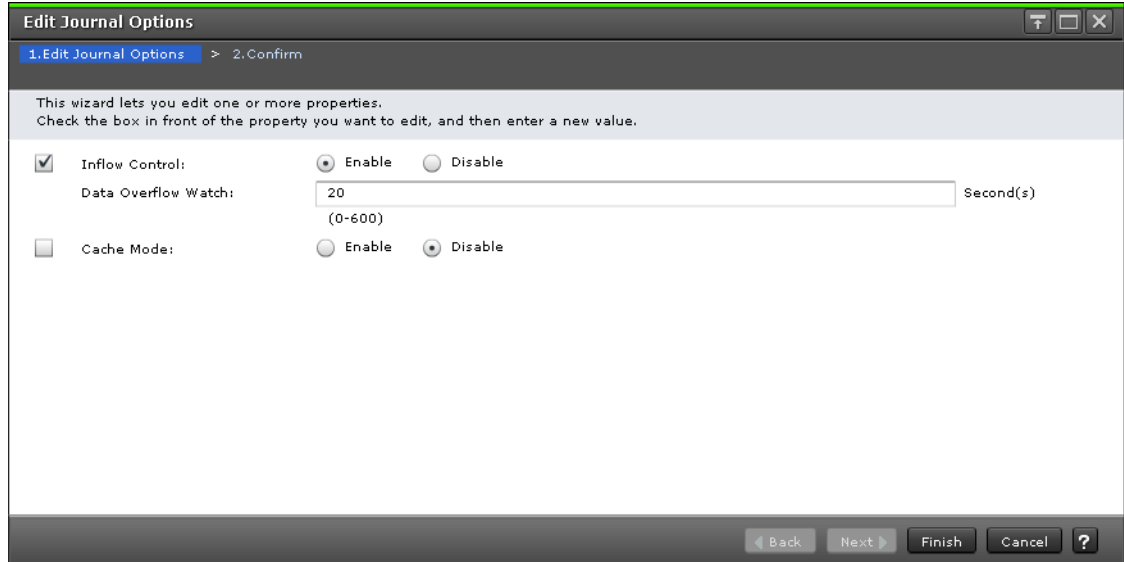

Item	Description
Inflow Control	Whether flow of update data to the journal volume is restricted by slowing the response to hosts.
Data Overflow Watch	<p>Number of seconds the system will monitor metadata and journal data to the journal volume when the journal volume is full (100%). The field is blank if Inflow Control is disabled.</p> <p>When the metadata area or journal data area are full and no more data can be stored, the system regards this as an error and suspends the pairs in the journal.</p> <p>The range is between 0 and 600, and the default is the value set when the journal was created.</p> <p>In a 3DC multi-target configuration in which three UR sites are combined, if the status of the two mirrors in the primary site is Active and the free space in the journal data area or metadata area is less than a certain amount, one of the mirrors in the journal will be suspended by error, regardless of the value in Data Overflow Watch.</p>
Cache Mode	<p>Indicates whether journal data is stored in cache memory on the restore journal.</p> <ul style="list-style-type: none"> • Enable: Journal data is stored in cache memory. When the available cache memory becomes insufficient, the journal data is also stored in a journal volume. • Disable: Journal data is stored in a journal volume instead of cache memory. This setting is disabled in the master journal. However, this setting is enabled if you use the <code>horctakeover</code> command of CCI (for Universal Replicator) or the <code>YKRESYNC REVERSE</code> command of Business Continuity Manager (for Universal Replicator for Mainframe) to change the master journal to the restore journal.
Timer Type (VSP G1000, VSP G1500, and VSP F1500)	<p>Type of clock used for consistency time. Values must be the same on primary and secondary storage systems. Displayed only when Mainframe is selected for System Type. Not displayed for UR journals.</p> <ul style="list-style-type: none"> • System: The local storage system acquires the time-stamp information for each journal data. <p>When a URz pair is created, the local storage system reports state-change-interrupt (SCI) to all hosts. The host then issues a series of sense group commands to determine the device status change. The local storage system returns the same response as if the device was added to an XRC session to activate I/O time-stamping for the device. When I/O time-stamping is activated, the MVS IOS routine adds the time stamp information (contents of time-of-day (TOD) clock) to each write I/O instruction for the device. A time stamp indicates the time when an update was made on the main host during start sub-channel (SSCH). Time stamps are transferred to the local storage system at each start I/O instruction.</p> <ul style="list-style-type: none"> • Local: The local storage system does not obtain time stamp information from host I/O time stamp. • None: The local storage system obtains time stamp information from host I/O time stamp. Available only when copy direction is reversed, S-VOL to P-VOL.

Edit Journal Options confirmation window

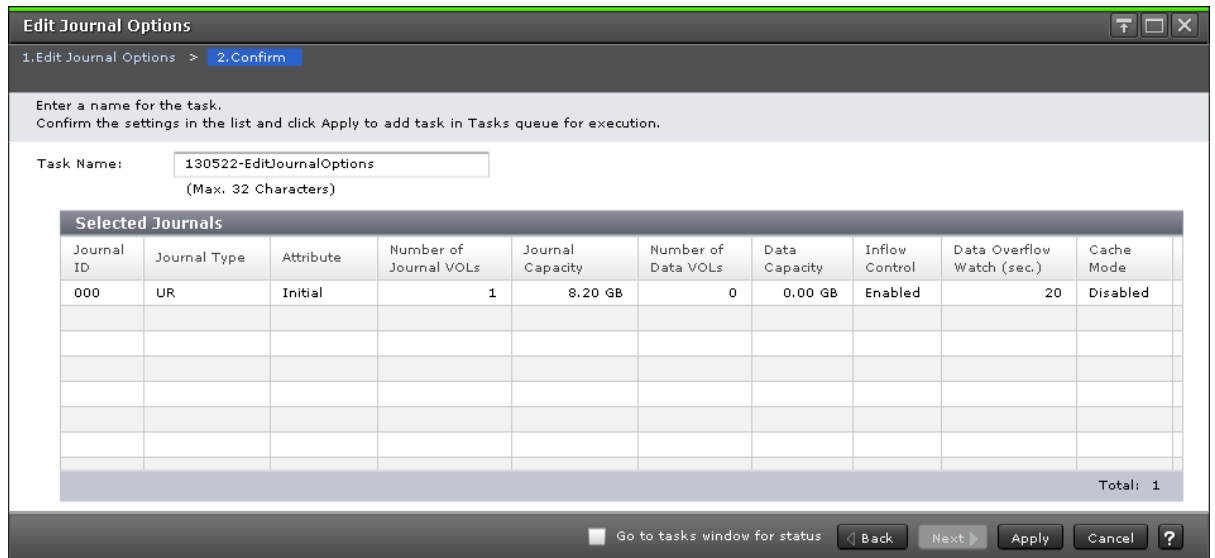

Item	Description
Journal ID	Journal identifier.
Journal Type (VSP G1000, VSP G1500, and VSP F1500)	Journal copy type, UR or URMF.
Attribute	Master, Restore, Master/Restore or Initial (registered but no pair volumes assigned).
Number of Journal VOLs	Number of journal volumes registered in the journal.
Journal Capacity	Capacity of the journal volume registered in the journal. If two journal volumes are registered, the capacity of the reserve journal volume is subtracted from the total capacity.
Number of Data VOLs	Number of volumes associated with the journal. (VSP G1000, VSP G1500, and VSP F1500) If the journal uses multiple mirror IDs, volumes in mirrors with Hold, Holding, or Hold(Failure) status are not included. (VSP Gx00 models and VSP Fx00 models) With the delta resync configuration, the number of data volumes registered to the journal of the mirrors not for delta resync is displayed. The number of volumes registered to the journal of the delta resync mirrors (whose status is Hold, Holding, or Hold(Failure)) is not displayed.
Data Capacity	Total capacity of all the associated volumes. (VSP G1000, VSP G1500, and VSP F1500) If the journal uses multiple mirror IDs, the capacity of volumes in mirrors with Hold, Holding, or Hold(Failure) status is not included. (VSP Gx00 models and VSP Fx00 models) With the delta resync configuration, the number of data volumes registered to the journal of the mirrors not for delta resync is displayed. The number of volumes registered to the journal of

Item	Description
	the delta resync mirrors (whose status is Hold, Holding, or Hold(Failure)) is not displayed.
Inflow Control	Whether flow of update data to the journal volume is restricted by slowing the response to hosts.
Data Overflow Watch	Number of seconds the system monitors metadata and journal data when the journal volume is full (100%). A hyphen (-) displays if Inflow Control is disabled.
Cache Mode	Indicates whether journal data is stored in cache memory on the restore journal. <ul style="list-style-type: none"> • Enable: Journal data is stored in cache memory. When the available cache memory becomes insufficient, the journal data is also stored in a journal volume. • Disable: Journal data is stored in a journal volume instead of cache memory. This setting is disabled in the master journal. However, this setting is enabled if you use the <code>horctakeover</code> command of CCI (for Universal Replicator) or the <code>YKRESYNC REVERSE</code> command of Business Continuity Manager (for Universal Replicator for Mainframe) to change the master journal to the restore journal.
Timer Type (VSP G1000, VSP G1500, and VSP F1500)	URz only. Type of clock used for consistency time. Not displayed for UR journals. <ul style="list-style-type: none"> • System: Mainframe system clock. • Local: System clock is not used. • None: Mainframe system clock.

Assign MP Blade ID or MP Unit ID wizard

Use this wizard to assign a MP blade or unit to a journal.

Assign MP Blade ID or MP Unit ID window

Use this window to assign a MP blade or unit to a journal.

For instructions, see the procedure in [Assigning an MP blade to a journal on page 123](#).

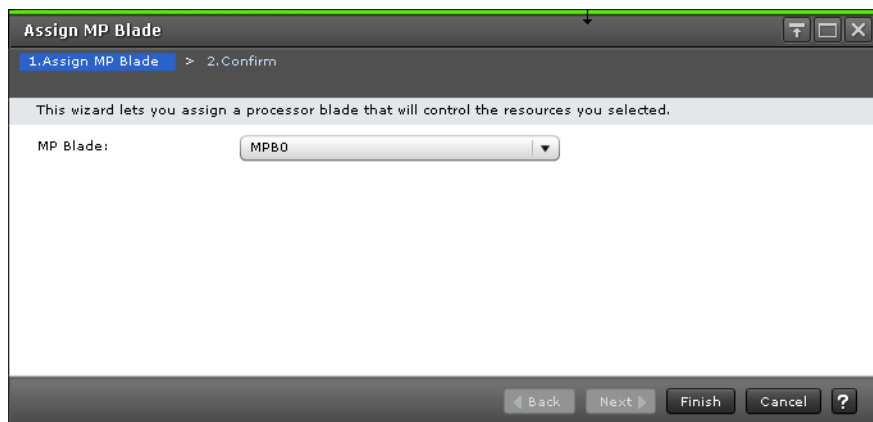

Item	Description
MP Blade ID or MP Unit ID	Options for selecting an MP blade or unit. MP Blade ID ranges from MPB0 thru MPB7. Availability depends on system configuration. Default is the current MP blade (VSP G1000, VSP G1500, and VSP F1500) or unit (VSP Gx00 models, VSP Fx00 models) number. Blank if the MP blade or unit numbers in the selected row are mixed.

Assign MP Blade ID or MP Unit ID confirmation window

Assign MP Blade

1. Assign MP Blade > 2. Confirm

Enter a name for the task.
Confirm the settings in the list and click Apply to add the task in the Tasks queue for execution.

Task Name:
(Max. 32 Characters)

Selected Journals							
Journal ID	Journal Type	Attribute	Number of Journal VOLs	Journal Capacity	Number of Data VOLs	Data Capacity	MP Blade ID
002	UR	Master	1	8.20 GB	0	0.00 GB	MPB0
Total:							1

Go to tasks window for status < Back Next > Apply Cancel ?

Item	Description
Journal ID	Journal identifier.
Journal Type (VSP G1000, VSP G1500, and VSP F1500)	Journal copy type, UR or URMF.
Attribute	Whether the journal is Master, Restore, Master/Restore, or Initial (registered but no pair volumes assigned).
Number of Journal VOLs	Number of journal volumes registered in the journal.
Journal Capacity	Capacity of the journal volume registered in the journal. If two journal volumes are registered, the capacity of the reserve journal volume is subtracted from the total capacity.
Number of Data VOLs	Number of volumes associated with the journal.

Item	Description
	<p>(VSP G1000, VSP G1500, and VSP F1500) If the journal uses multiple mirror IDs, volumes in mirrors with Hold, Holding, or Hold(Failure) status are not included.</p> <p>(VSP Gx00 models and VSP Fx00 models) With the delta resync configuration, the number of data volumes registered to the journal of the mirrors not for delta resync is displayed. The number of volumes registered to the journal of the delta resync mirrors (whose status is Hold, Holding, or Hold(Failure)) is not displayed.</p>
Data Capacity	<p>Total capacity of all the associated volumes.</p> <p>(VSP G1000, VSP G1500, and VSP F1500) If the journal uses multiple mirror IDs, volumes in mirrors with Hold, Holding, or Hold(Failure) status are not included.</p> <p>(VSP Gx00 models and VSP Fx00 models) With the delta resync configuration, the number of data volumes registered to the journal of the mirrors not for delta resync is displayed. The number of volumes registered to the journal of the delta resync mirrors (whose status is Hold, Holding, or Hold(Failure)) is not displayed.</p>
MP Blade IDor MP Unit ID	MP blade or unit identifier.

Edit Mirror Options wizard

Use this wizard to change a mirror's options.

Edit Mirror Options window

Use this window to change a mirror's options.

For instructions, see the procedure in [Changing options used by mirrors on page 213](#).

Edit Mirror Options

1. Edit Mirror Options > 2. Confirm

This wizard lets you edit one or more properties.
Check the box in front of the property you want to edit, and then enter a new value.

Path Watch Time: Minute Hour Day
 mins
 (1-59)

Path Watch Time Transfer: Yes No

Copy Pace: Slower

Transfer Speed: 100 Mbps

Delta Resync Failure: No Copy

Back Next Finish Cancel ?

Item	Description
Path Watch Time	Interval from the time a path becomes blocked to the time when the mirror is suspended. The Path Watch Time value can be specified using Minutes, Hours, or Days. The range is 1 to 59 minutes, 1 to 23 hours, or 1 to 30 days.
Path Watch Time Transfer	Indicates whether to transfer the master journal's Path Watch Time value to the mirror's secondary side (RCU). When transferred, the Path Watch Time values of the mirror's primary side (MCU) and the secondary side (RCU) will be consistent. <ul style="list-style-type: none"> • Yes: Path Watch Time value will be transferred to the mirror's secondary side (RCU). • No: Path Watch Time value will not be transferred to the mirror's secondary side (RCU). Default value is No.
Copy Pace	Pace for copying data during initial copy: Slower is the default, Medium, Faster.
Transfer Speed	Data transfer line speed in Mbps (megabits per second): 3, 10, 100, or 256.
Delta Resync Failure	Processing that takes place in the event of delta resync operation failure. <ul style="list-style-type: none"> • Entire Copy: The entire P-VOL is copied to the S-VOL. • No Copy: No processing occurs. The S-VOL is not updated. <p>Delta Resync Failure cannot be set at the secondary site. Use Entire Copy if your journals are part of a multiple-journal configuration in a CCI consistency group.</p> <p>When you use UR with GAD, NO COPY applies regardless of the setting. If delta resync processing fails, no processing is performed and the S-VOL is not updated. In that case, resync the UR pair.</p>

Edit Mirror Options confirmation window

1. Edit Mirror Options > 2. Confirm

Enter a name for the task.
Confirm the settings in the list and click Apply to add task in Tasks queue for execution.

Task Name: (Max. 32 Characters)

Selected Mirrors															
Journal ID	Mirror ID	Journal Type	Attribute	Status	Path Watch Time	Path Watch Time Transfer	Copy Pace	Transfer Speed	Delta Resync Failure	Remote Storage System Model / Serial Number	Journal ID	Path Group ID	Number of Data VOLS	Data Capacity	Remote Command Device
002	0	UR	Master	Active / PJNN	5 mins	No	Slower	100 Mbps	No Copy	VSP / 01000	000	00	1	0.00 GB	
Total: 1															

Go to tasks window for status

Item	Description
Journal ID	Journal identifier.
Mirror ID	Mirror identifier.

Item	Description
Journal Type (VSP G1000, VSP G1500, and VSP F1500)	Journal copy type, UR or URMF.
Attribute	Whether the journal is Master, Restore, or Initial (registered but no pair volumes assigned).
Status	Mirror's status.
Path Watch Time	Interval from the time a path becomes blocked to the time when the mirror is suspended. When the status of the mirror's secondary side (RCU) is Hold, Holding, or Hold(Failure), a hyphen (-) is displayed.
Path Watch Time Transfer	Indicates whether to transfer the master journal's Path Watch Time value to the mirror's secondary side (RCU). When transferred, the Path Watch Time values of the mirror's primary side (MCU) and the secondary side (RCU) will be consistent. <ul style="list-style-type: none"> • Yes: Path Watch Time value will be transferred to the mirror's secondary side (RCU). • No: Path Watch Time value will not be transferred to the mirror's secondary side (RCU).
Copy Pace	Pace for copying data during initial copy: Slower is the default, Medium, Faster. If the selected journal is a restore journal, a hyphen is displayed.
Transfer Speed	Data transfer line speed in Mbps (megabits per second): 3, 10, 100, or 256.
Delta Resync Failure	Processing that takes place in the event of delta resync operation failure. <ul style="list-style-type: none"> • Entire Copy: The entire P-VOL is copied to the S-VOL. • No Copy: No processing occurs. The S-VOL is not updated.
Remote Storage System	Displays the following information about the system connected to the system you accessed: <ul style="list-style-type: none"> • Model/Serial Number: Storage system's model and serial number. A hyphen displays if the mirror attribute is Initial. • Journal ID: Journal identifier. A hyphen displays if the mirror attribute is Initial.
Path Group ID	Path group identifier specified at DKC registration.
Number of Data VOLS	Number of volumes associated with the journal. (VSP G1000, VSP G1500, and VSP F1500) If the journal uses multiple mirror IDs, volumes in mirrors with Hold, Holding, or Hold(Failure) status are not included. (VSP Gx00 models and VSP Fx00 models) With the delta resync configuration, the number of data volumes registered to the journal of the mirrors not for delta resync is displayed. The number of volumes registered to the journal of the delta resync mirrors (whose status is Hold, Holding, or Hold(Failure)) is not displayed.
Data Capacity	Total capacity of all the associated volumes. (VSP G1000, VSP G1500, and VSP F1500) If the journal uses multiple mirror IDs, volumes in mirrors with Hold, Holding, or Hold(Failure) status are not included. (VSP Gx00 models and VSP Fx00 models) With the delta resync configuration, the total capacity of the data volumes registered to the journal of the mirrors

Item	Description
	not for delta resync is displayed. The total capacity of the data volumes registered to the journal of the delta resync mirrors (whose status is Hold, Holding, or Hold(Failure)) is not displayed.
Remote Command Device	LDEV number of the remote command device if it is assigned to the mirror. <ul style="list-style-type: none"> The column is blank if the remote command device is not assigned to the mirror. A hyphen (-) indicates the remote command device cannot be assigned to the mirror.

Assign Remote Command Devices wizard

Use this wizard to assign remote command devices.

Assign Remote Command Devices window

Use this window to assign mirrors to remote command devices.

For details, see [Assigning mirrors to remote command devices for delta resync operations on page 334](#).

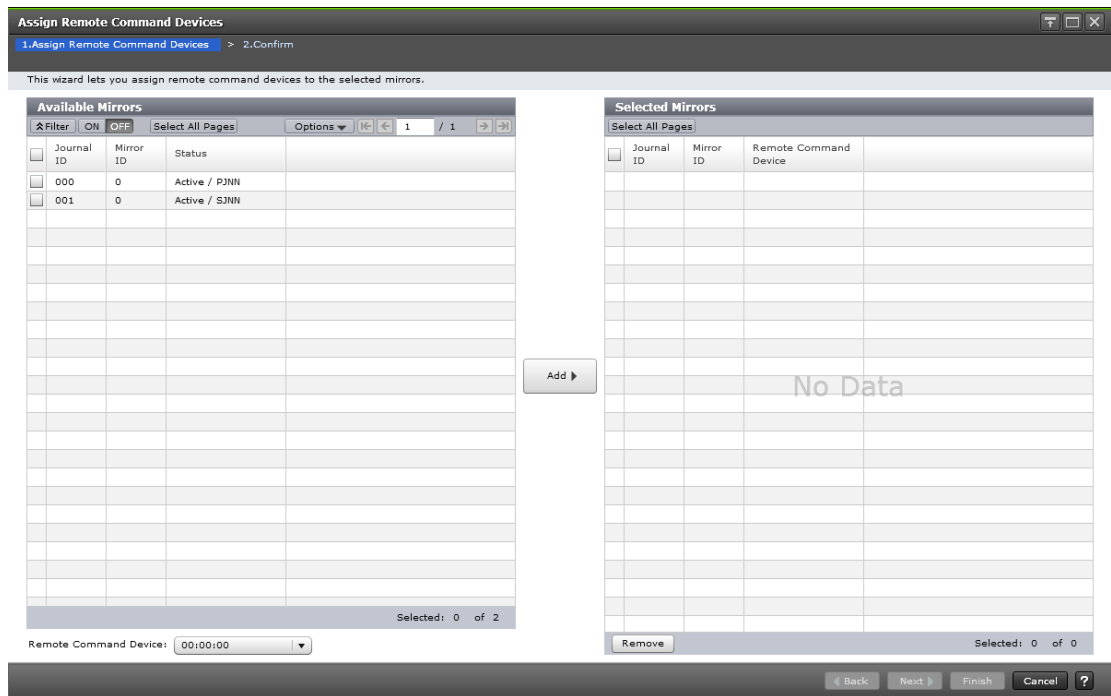

Available Mirrors table

Item	Description
Journal ID	Journal identifier.
Mirror ID	Mirror identifier.
Status	Mirror status.

Information Settings area

Item	Description
Remote Command Device	Select the remote command device (LDKC, CU, and LDEV numbers) you want to assign to the mirror
Add	Adds the mirror selected in Available Mirrors table and the remote command device selected in Remote Command Device to the Selected Mirrors table.

Selected Mirrors table

Item	Description
Journal ID	Journal identifier.
Mirror ID	Mirror identifier.
Remote Command Device	Displays the LDKC, CU, and LDEV numbers of the remote command device selected in the Remote Command Device.
Remove	Removes the mirror selected in the Selected Mirrors table.

Assign Remote Command Devices confirmation window

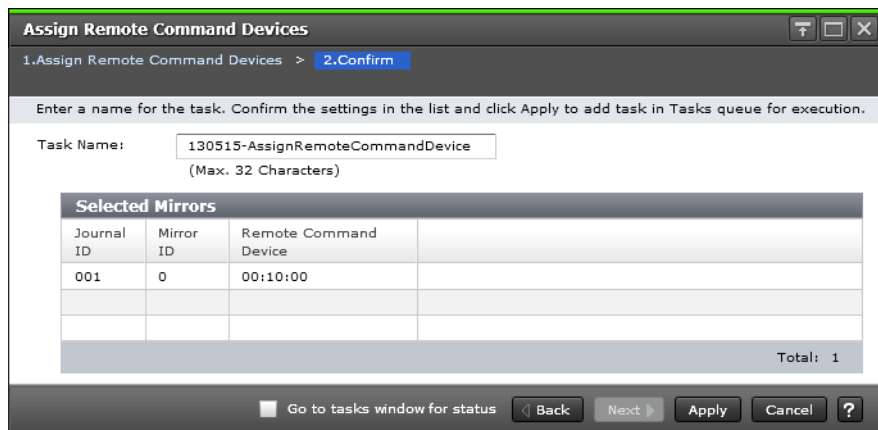

Item	Description
Journal ID	Journal identifier.

Item	Description
Mirror ID	Mirror identifier.
Remote Command Device	LDKC, CU, and LDEV numbers of the remote command device.

Release Remote Command Devices window

Use this window to release a remote command device from a mirror.

For details, see the procedure in [Releasing a remote command device for delta resync operations assigned to a mirror on page 336](#)

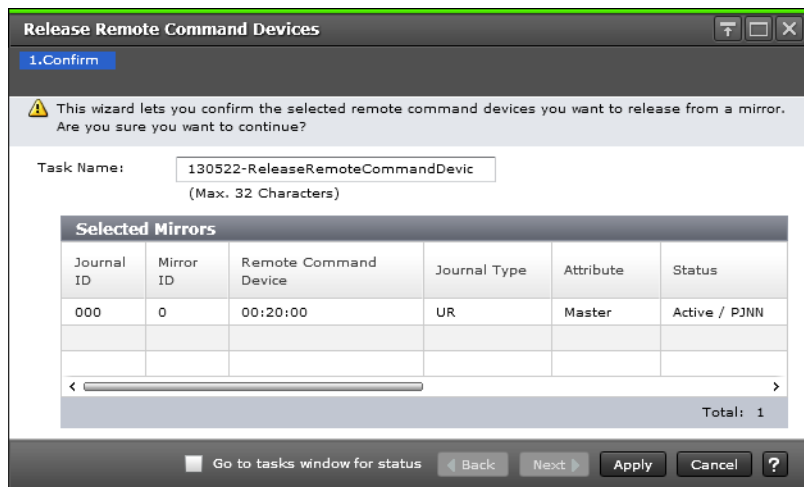

Selected Mirrors table

Item	Description
Journal ID	Journal identifier.
Mirror ID	Mirror identifier.
Remote Command Device	LDKC, CU, and LDEV numbers of the remote command device assigned to the mirror.
Journal Type (VSP G1000, VSP G1500, and VSP F1500)	Journal copy type, UR or URMF.
Attribute	Whether the journal is Master, Restore, or Initial (registered but no pair volumes assigned).
Status	Mirror's status.
Remote Storage System	Displays the following information about the Remote Storage System. <ul style="list-style-type: none"> Model/Serial Number: Storage system model and serial number. A hyphen displays if the mirror attribute is Initial.

Item	Description
	<ul style="list-style-type: none"> Journal ID: Journal identifier. A hyphen displays if the mirror attribute is Initial.
Path group ID	Path group's identifier.
Number of Data VOLS	<p>Number of volumes associated with the journal.</p> <p>(VSP G1000, VSP G1500, and VSP F1500) If the journal uses multiple mirror IDs, volumes in mirrors with Hold, Holding, or Hold(Failure) status are not included.</p> <p>(VSP Gx00 models and VSP Fx00 models) With the delta resync configuration, the number of data volumes registered to the journal of the mirrors not for delta resync is displayed. The number of volumes registered to the journal of the delta resync mirrors (whose status is Hold, Holding, or Hold(Failure)) is not displayed.</p>
Data Capacity	<p>Total capacity of all the associated volumes.</p> <p>(VSP G1000, VSP G1500, and VSP F1500) If the journal uses multiple mirror IDs, the capacity of volumes in mirrors with Hold, Holding, or Hold(Failure) status is not included.</p> <p>(VSP Gx00 models and VSP Fx00 models) With the delta resync configuration, the total capacity of the data volumes registered to the journal of the mirrors not for delta resync is displayed. The total capacity of the data volumes registered to the journal of the delta resync mirrors (whose status is Hold, Holding, or Hold(Failure)) is not displayed.</p>

View Pair Synchronization Rate window

Use this window to view the percentage of synchronized data between P-VOL and S-VOL.

For detailed information, see [Monitoring UR pair synchronization rate on page 196](#).

The screenshot shows a window titled "View Pair Synchronization Rate" with a "Pairs" section. It includes a filter toggle (ON/OFF), an "Options" dropdown, and a table with the following data:

LDEV ID	LDEV Name	Pair Position	Journal ID	Mirror ID	CLPR	Virtual Storage Machine	Virtual LDEV ID	Virtual Device Name	Virtual SSID	Copy Ty
00:00:00		Primary	004	2	0:CLPR0	VSP G1000 / 00002	00:00:00			UR

At the bottom of the window, there is a "Refresh" button, a "Total: 1" indicator, and "Close" and "?" buttons.

Item	Description
Local Storage System	<p>Displays the following information about pair volumes in the Local Storage System.</p> <ul style="list-style-type: none"> • LDEV ID: LDEV identifier. • LDEV Name: LDEV name. • Pair Position: Identifies the volume as primary or secondary. • Journal ID: Journal identifier. • Mirror ID: Pair's mirror ID • CLPR: CLPR ID • Virtual storage machine: Virtual storage machine's model type and serial number. • Virtual LDEV ID: Volume's virtual LDEV identifier. • Virtual Device Name: Volume's virtual device name, in the format: virtual emulation type/number of virtual LUSE volumes/virtual CVS attribute <ul style="list-style-type: none"> - Only attributes that are specified display. - "CVS" displays at the end of the device name, if the virtual CVS attribute is specified. - A blank indicates no values are specified. • Virtual SSID: Volume's virtual SSID. A blank indicates that no virtual SSID is specified.
Copy Type	<p>Type of pair:</p> <ul style="list-style-type: none"> • UR: Universal Replicator • (VSP G1000, VSP G1500, and VSP F1500) URMF: Universal Replicator for Mainframe • (VSP Gx00 models and VSP Fx00 models) TC: TrueCopy
Status	<p>Pair's status. For more information, see Pair status definitions on page 33.</p>
Sub Status (VSP G1000, VSP G1500, and VSP F1500)	<p>S-VOL's consistency status. For URz, the SEQCHK status is displayed if there is no consistency in the update sequence between the S-VOL and other S-VOLs in the journal.</p>
Synchronization Rate (%)	<p>Displayed as follows:</p> <ul style="list-style-type: none"> • When the volume on the local storage system is a P-VOL: Initial copy progress is displayed. • When the volume on the local storage system is an S-VOL: The synchronization rate depends on whether the pair is split: <ul style="list-style-type: none"> ◦ If the pair is not split, a hyphen (-) is displayed. ◦ If the pair is split, the S-VOL synchronization rate between before and after the split is displayed. For example, if the S-VOL content before and after the split is the same, 100 is displayed. <p>Caution: If the pair is split due to initial copy failure, a hyphen (-) is displayed. If initial copy fails, the status Initial copy failed is displayed in the View Pair Properties window.</p> • If processing has not started, "(Queuing)" is displayed. • For the following cases, a hyphen (-) is displayed: <ul style="list-style-type: none"> ◦ When the volume in the local storage system is neither a P-VOL nor an S-VOL. ◦ When the volume in the local storage system has one of the following pair statuses: HOLD, HOLDING, HLDE for Universal Replicator pairs, and Hold, Holding, Hlde for Universal Replicator for Mainframe pairs.
Remote Storage System	<p>Displays the following information about pair volumes in the Remote Storage System.</p> <ul style="list-style-type: none"> • Model/Serial Number: Storage system model name and serial number. • LDEV ID: LDEV identifier. • Journal ID: Journal identifier. • Virtual storage machine: Virtual storage machine's model type and serial number. • Virtual LDEV ID: Volume's virtual LDEV identifier.
Path Group ID	<p>Path group identifier</p>
Refresh	<p>When clicked, updates information in the window.</p>

Create UR Pairs wizard

Use this wizard to create UR pairs.

Create UR pairs window

Use this window to create pairs.

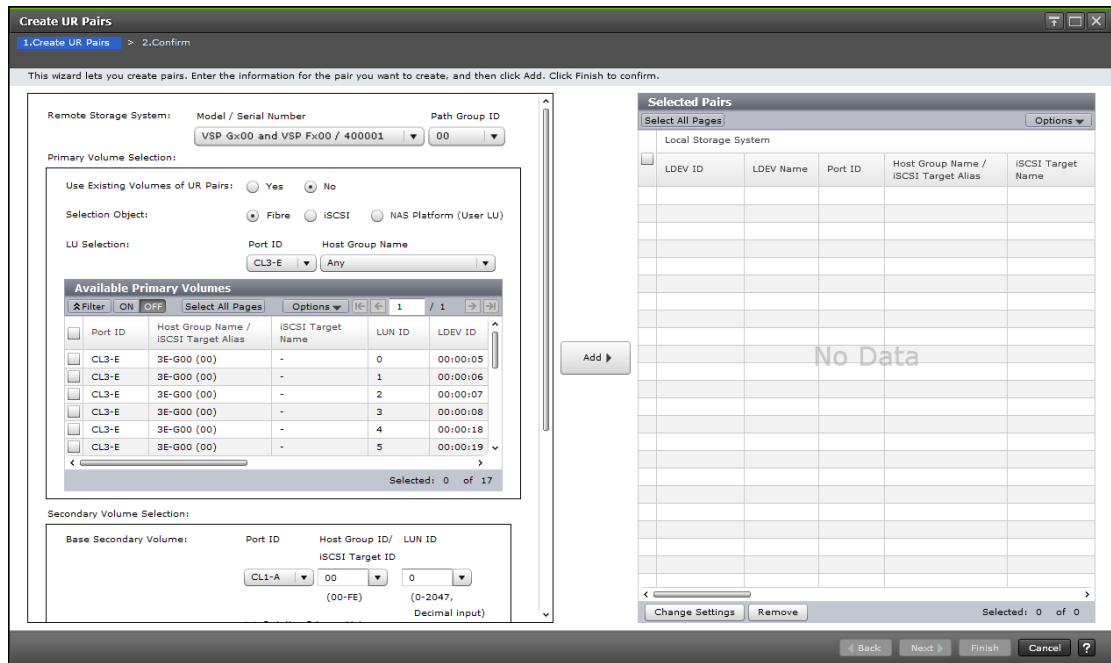

Settings

Item	Description
Copy Type	Type of pair: <ul style="list-style-type: none"> Universal Replicator Universal Replicator for Mainframe
Remote Storage System	Selections in the remote system. <ul style="list-style-type: none"> Model / Serial Number: Select the model and serial number. Path Group ID: Select the ID of the path group.

Primary Volume Selection

Item	Description
Use Existing Volumes of UR Pairs	UR only. <ul style="list-style-type: none"> • Yes: Create a pair using the existing volumes of UR pairs. Select this item when creating a pair with 3DC multi-target by 3 UR sites or with cascade configuration. • No: Create a pair without using the existing volumes of UR pairs. Select this item when not creating a pair with 3DC multi-target by 3 UR sites or with cascade configuration.
Use Existing Volumes of URMF Pairs (VSP G1000, G1500, and VSP F1500)	URz only. <ul style="list-style-type: none"> • Yes: Create a pair using the existing volumes of URz pairs. Select this item when creating a pair with 3DC multi-target by 3 URz sites or with cascade configuration. • No: Create a pair without using the existing volumes of URz pairs. Select this item when not creating a pair with 3DC multi-target by 3 URz sites or with cascade configuration.
Selection Object (VSP Gx00 models, VSP Fx00 models)	Select a port in the local storage system. <ul style="list-style-type: none"> • Fibre: Select when specifying LU for Fibre port. • iSCSI: Select when specifying LU for iSCSI port. • NAS Platform (User LU): Select when specifying LU for NAS port. Displayed only when NAS modules are installed. This option is not displayed for VSP G100 and VSP G200. <p>Ports without LUs cannot be selected. If only one port type (Fibre, iSCSI, or NAS platform) has an LU, the port type is selected automatically.</p>
LU Selection	Select an LU in the local storage system. <ul style="list-style-type: none"> • Port ID: Local system's port identifier. • Host Group Name: Host group name. Displays only when Fibre port is selected in Port Name. • iSCSI Target Alias: Selections for iSCSI target alias. All of the LUNs in the indicated port for Available LDEVs if Any is selected. Displays when iSCSI port is selected for Port Name.
Available Primary Volumes	Information about P-VOLs. Displayed when Fibre port is selected in Port ID for LU Selection. <ul style="list-style-type: none"> • Port ID: Port identifier. • Host Group Name / iSCSI Target Alias: Host group name or iSCSI target alias. • iSCSI Target Name: Volume's iSCSI target name. • LUN ID: LUN identifier. • LDEV ID: LDEV identifier. • LDEV Name: LDEV name. • Pair Position: Identifies the volume as primary or secondary. A blank is displayed if the volume is not used by a pair. • Journal ID: Journal identifier. A blank is displayed if the volume is not used by a pair. • Mirror ID: Mirror ID. A blank is displayed if the volume is not used by a pair. • Provisioning Type: Whether the volume is Basic (internal) or External. • Attribute <ul style="list-style-type: none"> ○ ALU: Volume with ALU attribute. ○ SLU: Volume with SLU attribute. ○ Data Direct Mapping: Volume with the data direct mapping attribute.

Item	Description
	<ul style="list-style-type: none"> ○ NAS Platform (User LU): User LU for NAS. <p>If the attribute is not set, a hyphen (-) is displayed.</p> <ul style="list-style-type: none"> • Emulation Type: Emulation type (VSP G1000, VSP G1500, and VSP F1500) • Capacity: LDEV's capacity. • CLPR: CLPR ID. • Encryption: Encryption information. <ul style="list-style-type: none"> ○ Enabled: The parity group encryption to which LDEV belongs is enabled, or a V-VOL is associated with a pool in which a pool volume has encryption enabled. ○ Disabled: The parity group encryption to which LDEV belongs is disabled, or a V-VOL is associated with a pool in which a pool volume has encryption disabled. ○ Mixed: The pool to which the LDEV belongs contains two or more of the following: <ul style="list-style-type: none"> - Volume for which encryption is enabled - Volume for which encryption is disabled - External volume <p>Note: Encryption of data is not ensured in an LDEV with the Mixed encryption status. To manage data encryption, use an LDEV for which Encryption is Enabled or Disabled.</p> <p>A hyphen (-) is displayed for an external volume. For DP-VOLs, the pool to which the LDEV belongs is either an external volume or blocked.</p> <ul style="list-style-type: none"> • Capacity Saving: Information on the capacity saving function. <ul style="list-style-type: none"> ○ Compression: The compression function is used. ○ Deduplication and Compression: The deduplication function and the compression function are used. ○ Disabled: The capacity saving function is not used. • (VSP G1000, VSP G1500, and VSP F1500) T10 PI: T10 PI attribute of the volume. <ul style="list-style-type: none"> ○ Enabled: T10 PI attribute of the volume is enabled. ○ Disabled: T10 PI attribute of the volume is disabled. <p>A hyphen (-) is displayed if the emulation type is other than OPEN-V.</p> <ul style="list-style-type: none"> • Paired Volume: Paired volume information. A blank is displayed if the volume is not used by a pair. <ul style="list-style-type: none"> ○ Model / Serial Number: Model and serial number. ○ LDEV ID: LDEV identifier. ○ Port ID: Port identifier of the volume. ○ Host Group ID / iSCSI Target ID: Host group ID or iSCSI target ID. ○ LUN ID: LUN identifier of the volume.

Secondary Volume Selection

Item	Description
Base Secondary Volume	<p>Information about Base Secondary Volume.</p> <p>UR only.</p> <ul style="list-style-type: none"> • Port ID: Port identifier.

Item	Description
	<ul style="list-style-type: none"> Host Group ID/iSCSI Target ID: Host group identifier or iSCSI target identifier. LUN ID: LUN identifier. <p>URz only.</p> <ul style="list-style-type: none"> LDKC: "00" is displayed, cannot be changed. CU: the CU number of the remote system, ranging from 00 to FE. LDEV: LDEV number, ranging from 00 to FF.
Selection Type	<p>Default is Interval.</p> <ul style="list-style-type: none"> Interval: Interval for allocating S-VOLs. Relative Primary Volume: S-VOLs paired with P-VOLs relative to LUN or LDEV numbers.

Mirror Selection

Item	Description
Master Journal	Select the master journal to which you allocate the primary volume. Registered journal IDs (except for those of restore journals) are displayed.
Mirror ID	Mirror's identifier.
Restore Journal	Select the restore journal to which you allocate secondary volumes. All journal IDs (000 to 0FF) are displayed.
Current Number of Master Journal Mirrors	Number of mirrors in the master journal.
Total Number of Master Journal Mirrors	Displays the following: <ul style="list-style-type: none"> Number of mirrors in the master journal. Number of mirrors added during the Create UR Pairs operation. Number of mirrors for the selected volume in Selected Pairs table.
CTG ID	Displays consistency groups registered in the storage system. An asterisk indicates it is assigned to a pair in the Select Pairs table. Displayed for UR pairs only.

Options

Item	Description
Initial Copy Type	Indicates whether data is copied to the S-VOL during this operation. <ul style="list-style-type: none"> Entire Volume: Data is copied. The default. None: Data is not copied. Delta: Data is not copied.
Initial Copy Priority	Scheduling order for the initial copy operation. Range is 1 to 256; default is 32. (VSP Gx00 models and VSP Fx00 models) For GAD pairs this is not displayed.
Error Level	Whether to split all pairs in the mirror if a failure occurs during this operation: <ul style="list-style-type: none"> Mirror: Pairs in the mirror are split. LU: Only the failed pair is split.

Item	Description
	<ul style="list-style-type: none"> (VSP G1000, G1500, and VSP F1500) Volume (URz): Only the failed pair is split.
CFW (VSP G1000, G1500, and VSP F1500)	<p>URz only.</p> <p>Whether to copy cache fast write (CFW) data to the S-VOL.</p> <ul style="list-style-type: none"> Primary Volume Only: Does not copy. Default. Secondary Volume Copy: Copies.
Add	The pair specified in left hand side window is added to the Selected Pairs table.

Selected Pairs table

Item	Description
Local Storage System	<p>Information about volumes in the accessed system.</p> <ul style="list-style-type: none"> LDEV ID: LDEV identifier. LDEV Name: LDEV name. Port ID: Port identifier. Host Group Name / iSCSI Target Alias: Host group name or iSCSI target alias. iSCSI Target Name: Volume's iSCSI target name. LUN ID: LUN identifier. Pair Position: Indicates whether the volume is the P-VOL or S-VOL of the pair. Attribute: <ul style="list-style-type: none"> ALU: The volume has the ALU attribute. SLU: The volume has the SLU attribute. Data Direct Mapping: The volume has the data direct mapping attribute. <p>If the attribute is not set, a hyphen (-) is displayed.</p> <ul style="list-style-type: none"> Emulation Type: Emulation type of the volume. Journal ID: Journal's identifier. Mirror ID: Mirror identifier. Capacity: Volume's capacity. CLPR: Volume's CLPR. Encryption: Encryption information: <ul style="list-style-type: none"> Enabled: Encryption of the parity group to which the LDEV belongs is enabled, or a V-VOL is associated with a pool in which a pool volume has encryption enabled. Disabled: Encryption of the parity group to which the LDEV belongs is disabled, or a V-VOL is associated with a pool in which a pool volume has encryption disabled. Mixed: The pool to which the LDEV belongs contains two or more of the following: <ul style="list-style-type: none"> Volume for which encryption is enabled Volume for which encryption is disabled External volume <p>Note: Encryption of data is not ensured in an LDEV with the Mixed encryption status. To manage data encryption, use an LDEV in which Encryption is Enabled or Disabled.</p> <p>For an external volume, a hyphen (-) is displayed.</p>

Item	Description
	<p>For V-VOLs of Dynamic Provisioning or Dynamic Provisioning for Mainframe, the pool to which the LDEV belongs is an external volume or blocked.</p> <ul style="list-style-type: none"> • Journal Encryption: Journal's encryption status. UR or URz only. <ul style="list-style-type: none"> ○ Enabled: The journal contains encrypted volumes. ○ Disabled: The journal contains unencrypted volumes. ○ Mixed: The pool to which the journal volume belongs contains two or more of the following: <ul style="list-style-type: none"> - Volume for which encryption is enabled - Volume for which encryption is disabled - External volume <p>Note: Encryption of data is not ensured in an LDEV with the Mixed encryption status. To manage data encryption, use an LDEV in which Encryption is Enabled or Disabled.</p> <p>A hyphen (-) is displayed if the pool to which the journal volume belongs is an external volume, created by migration, or blocked.</p> <ul style="list-style-type: none"> • Capacity Saving: Information on the capacity saving function. <ul style="list-style-type: none"> ○ Compression: The compression function is used. ○ Deduplication and Compression: The deduplication function and the compression function are used. ○ Disabled: The capacity saving function is not used. • T10 PI: T10 PI attribute of the volume. UR only. <ul style="list-style-type: none"> ○ Enabled: T10 PI attribute of the volume is enabled. ○ Disabled: T10 PI attribute of the volume is disabled.
Remote Storage System	<p>Information about the remote system.</p> <ul style="list-style-type: none"> • Model / Serial Number: Model and serial number. • Port ID: Port identifier. UR only. • Host Group ID / iSCSI Target ID: Host group or iSCSI target identifier. UR only. • LUN ID: LUN identifier. UR only. • LDEV ID: LDEV identifier. URz pairs only. • Journal ID: Journal's identifier. URz pairs only.
Path Group ID	Path group ID.
CTG ID	Consistency group identifier.
Initial Copy Type	Type of the pair create operation.
Initial Copy Priority	Scheduling order for pair create operation by using a decimal number from 0 to 255.
Error Level	Indicates whether all pairs in the mirror are split if a failure occurs during this operation.
CFW	Whether CFW data is copied to the S-VOL. URz pairs only.
Change Settings	Opens the Change Settings window.
Remove	Removes the specified pair from the table.

Change Settings window

Use this window in the pair creation wizard to change options that affect how the pair is created.

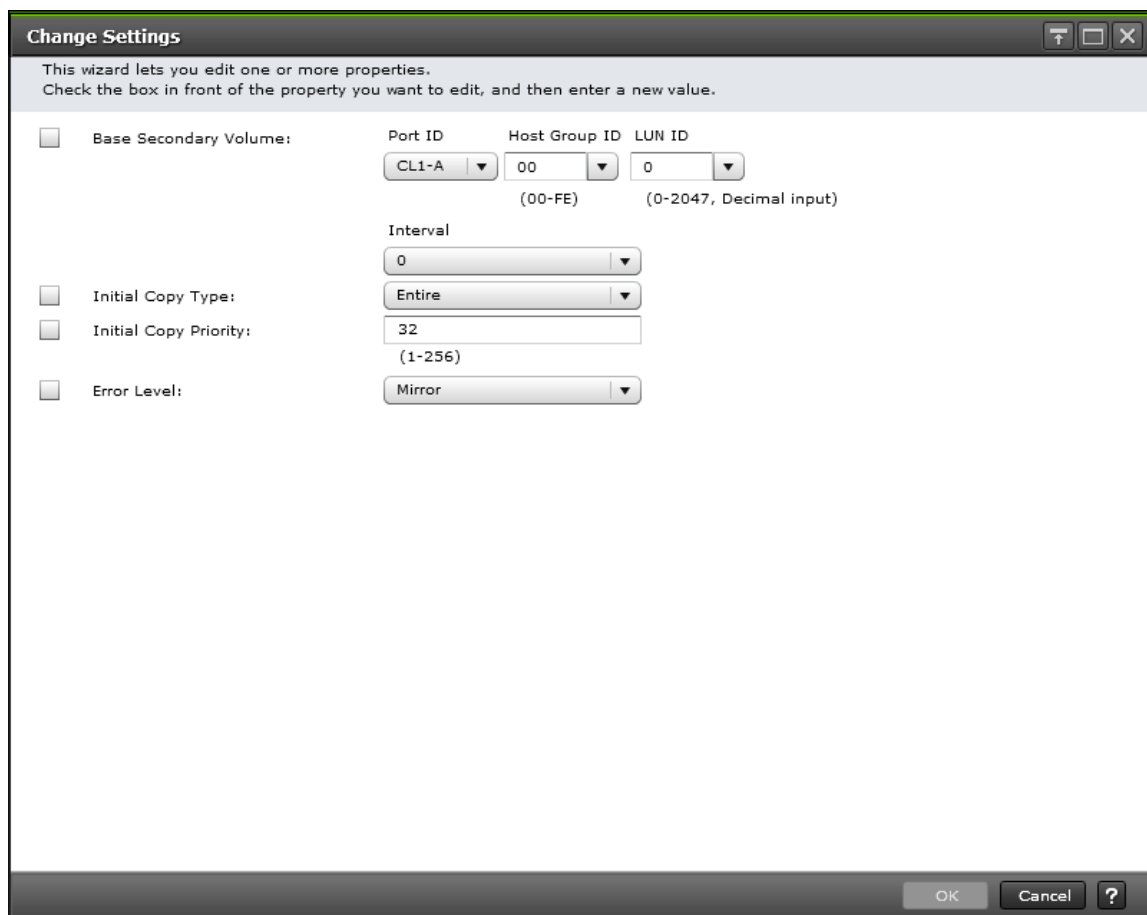

Item	Description
Base Secondary Volume	Select when changing Base Secondary Volume setting. <ul style="list-style-type: none"> • For UR pairs: <ul style="list-style-type: none"> ○ Port ID: Port identifier. ○ Host Group ID/iSCSI Target ID: Host group or iSCSI target identifier. ○ LUN ID: LUN identifier. • For URz pairs: <ul style="list-style-type: none"> ○ LDKC: "00" is displayed, cannot be changed. ○ CU: For TCz: the CU number of the volume. For URz: the CU number of the remote system, ranging from 00 to FF. ○ LDEV: LDEV number, ranging from 00 to FF. • Interval: The interval for allocating S-VOLs to P-VOLs. For UR and URz pairs.
Initial Copy Type	Indicates whether data is copied to the S-VOL when the pair is created. <ul style="list-style-type: none"> • Entire Volume: Data is copied. The default. • None: Data is not copied. If you choose this option, you should confirm the data be equal between the P-VOL and S-VOL. • Delta: Data is not copied.

Item	Description
	For Universal Replicator delta resync pairs, the status will be changed to HOLD or HOLDING. For Universal Replicator for Mainframe delta resync pairs, the status will be changed to Hold or Holding.
Initial Copy Priority	Scheduling order for the initial copy operation. Range is 1 to 256; default is 32.
Error Level	Indicates whether to split all pairs in the mirror if a failure occurs during this operation: <ul style="list-style-type: none"> • LU: Only the failed pair is split. • Mirror: Pairs in the mirror are split. • Volume: Only the failed pair is split. URz pairs only.
CFW (VSP G1000, G1500, and VSP F1500)	Whether to copy cache fast write (CFW) data to the S-VOL. URz pairs only. <ul style="list-style-type: none"> • Primary Volume Only: Does not copy. Default. • Secondary Volume Copy: Copies.

Create UR Pairs confirmation window

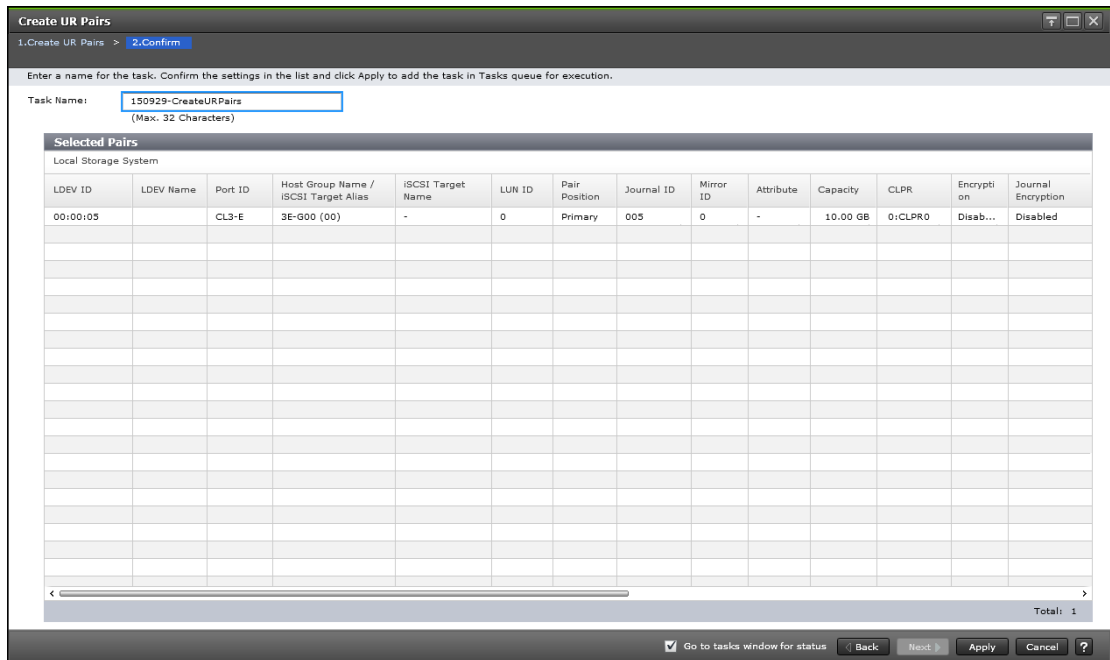

Selected Pairs table

Item	Description
Local Storage System	Information about volumes in the accessed system. <ul style="list-style-type: none"> • LDEV ID: LDEV identifier. • LDEV Name: LDEV name.

Item	Description
	<ul style="list-style-type: none"> • Port ID: Port identifier. • Host Group Name / iSCSI Target Alias: Host group name or iSCSI target alias. • iSCSI Target Name: Volume's iSCSI target name. • LUN ID: LUN identifier. • Pair Position: Identifies the volume as primary or secondary. A blank is displayed if the volume is not used by a pair. • (VSP G1000, G1500, and VSP F1500) Emulation Type: Emulation type of the volume. TCz/TC/URz only. • Journal ID: Journal's identifier. • Mirror ID: Mirror identifier. • Attribute: <ul style="list-style-type: none"> ○ ALU: The volume has the ALU attribute. ○ SLU: The volume has the SLU attribute. ○ Data Direct Mapping: The volume has the data direct mapping attribute. <p>If the attribute is not set, a hyphen (-) is displayed.</p> <ul style="list-style-type: none"> • Capacity: Volume's capacity. • CLPR: Volume's CLPR. • Encryption: Encryption information: <ul style="list-style-type: none"> ○ Enabled: Encryption of the parity group to which the LDEV belongs is enabled, or a V-VOL is associated with a pool in which a pool volume has encryption enabled. ○ Disabled: Encryption of the parity group to which the LDEV belongs is disabled, or a V-VOL is associated with a pool in which a pool volume has encryption disabled. ○ Mixed: The pool to which the LDEV belongs contains two or more of the following: <ul style="list-style-type: none"> - Volume for which encryption is enabled - Volume for which encryption is disabled - External volume <p>Note: Encryption of data is not ensured in an LDEV with the Mixed encryption status. To manage data encryption, use an LDEV in which Encryption is Enabled or Disabled.</p> <p>For an external volume, a hyphen (-) is displayed. For V-VOLs of Dynamic Provisioning or Dynamic Provisioning for Mainframe, the pool to which the LDEV belongs is an external volume or blocked.</p> <ul style="list-style-type: none"> • Journal Encryption: Journal's encryption status. UR or URz only. <ul style="list-style-type: none"> ○ Enabled: The journal contains encrypted volumes. ○ Disabled: The journal contains unencrypted volumes. ○ Mixed: The pool to which the journal volume belongs contains two or more of the following: <ul style="list-style-type: none"> - Volume for which encryption is enabled - Volume for which encryption is disabled - External volume <p>Note: Encryption of data is not ensured in an LDEV with the Mixed encryption status. To manage data encryption, use an LDEV in which Encryption is Enabled or Disabled. A hyphen (-) is displayed if the pool to which the journal volume belongs is an external volume, created by migration, or blocked.</p>

Item	Description
	<ul style="list-style-type: none"> Capacity Saving: Information on the capacity saving function. <ul style="list-style-type: none"> Compression: The compression function is used. Deduplication and Compression: The deduplication function and the compression function are used. Disabled: The capacity saving function is not used. T10 PI: T10 PI attribute of the volume. UR only. <ul style="list-style-type: none"> Enabled: T10 PI attribute of the volume is enabled. Disabled: T10 PI attribute of the volume is disabled.
Copy Type (VSP G1000, G1500, and VSP F1500)	Type of pair: <ul style="list-style-type: none"> UR: Universal Replicator URMF: Universal Replicator for Mainframe
Remote Storage System	Information about volumes in the system connected to the system you accessed. <ul style="list-style-type: none"> Model / Serial Number: Model and serial number. Port ID: Port identifier. UR only. Host Group Name / iSCSI Target Alias: Host group name or iSCSI target alias. UR only. LUN ID: LUN identifier. UR only. (VSP G1000, G1500, and VSP F1500) LDEV ID: LDEV identifier. TCz/URz only. Journal ID: Journal's identifier.
Path Group ID	Path group identifier.
CTG ID	Consistency group identifier. UR only.
Initial Copy Type	Type of initial copy operation.
Initial Copy Priority	Scheduling order for the initial copy operation. Range is 1 to 256; default is 32.
Error Level	Indicates whether to split all pairs in the mirror if a failure occurs during this operation: <ul style="list-style-type: none"> Mirror: Pairs in the mirror are split. Volume: Only the failed pair is split.
CFW (VSP G1000, G1500, and VSP F1500)	URz only. Whether to copy cache fast write (CFW) data to the S-VOL. <ul style="list-style-type: none"> Primary Volume Only: Does not copy. Default. Secondary Volume Copy: Copies.

View Pair Properties window

Use this window to view the data related to pairs and their volumes.

For instructions, see [Monitoring pair activity, status, license capacity on page 194](#).

View Pair Properties

Pair Properties

Local Storage System	Remote Storage System
00:02:10{}	00:02:11
Number of Paths: 1	CL1-A / 00 / 1
DP	OPEN-V , 99.99 GB
OPEN-V , 99.99 GB	Journal ID: 001
Journal ID: 000	VSP G1000 / 12345
VSP G1000 / 2654 , 0:CLPR0	

Pair Detail		
Status		PAIR
CTG ID		000
Sub Status		-
Reverse Resync		-
Error Level		Mirror
Secondary Volume Write		Disabled
Initial Copy Priority		32
Paired Time		2008/04/12 09:19:12
Last Update Time		2008/04/12 09:19:12
Pair Copy Time		000:05:00
Consistency Time		-
Timer Type		-
CFW		-
Local Storage System	Virtual Storage Machine	VSP G1000 / 02654
	Virtual LDEV ID	00:02:10
	Virtual Device Name	
	Virtual SSID	
Remote Storage System	Virtual Storage Machine	VSP G1000 / 12345
	Virtual LDEV ID	00:02:11

1 / 1

Back Next Close ?

Pair Properties

Item	Description
Local Storage System box	<p>Displays the following information about the volume on the local storage system.</p> <ul style="list-style-type: none"> LDEV ID (LDEV name): LDEV identifier and name. "---" displays for long names. Hover the mouse over it to display the complete name. Number of paths: Number of data paths between primary and secondary storage systems. Clicking the number displays the path list (UR only (VSP G1000, G1500, and VSP F1500)). Provisioning Type, Encryption status, T10 PI: Provisioning type, encryption status, and T10 PI attribute of the local storage system's volume. Encryption status is displayed only when the volume's encryption is Enabled or Mixed. If ... is displayed, move the cursor over ... to display the hidden contents as a tooltip. T10 PI attribute information is displayed only if the T10 PI attribute is enabled. (VSP G1000, G1500, and VSP F1500) Emulation Type, Capacity: System's emulation type and capacity. (VSP Gx00 models and VSP Fx00 models) Attribute, capacity: Local storage system's volume attribute and capacity. If the volume does not have an attribute, only the capacity is displayed.

Item	Description
	<ul style="list-style-type: none"> Journal ID (Encrypted): Journal identifier and encryption status. The encryption status is displayed only when the volume's encryption is Enabled or Mixed. If an elipsis (...) is displayed, move the cursor over the elipsis to display the hidden contents as a tooltip. Model/Serial number, CLPR ID:CLPR name: Local storage system's model, serial number, CLPR ID, and CLPR name.
Copy type (VSP G1000, G1500, and VSP F1500)	Pair's copy type.
Status	Pair's status.
Path Group	Pair's path group. Clicking the path group number displays the remote path list if the P-VOL is in the Local Storage System..
Mirror ID	Pair's mirror identifier
Remote Storage System box	<p>Displays the information about the Remote Storage System.</p> <ul style="list-style-type: none"> LDEV ID: LDEV identifier and name, which displays when you hover the mouse over it. Port name/Host group ID or iSCSI target ID/LUN ID: System's port name, host group ID or iSCSI target ID and LUN ID. This information is useful when specifying an LDEV ID at pair creation. It does not change, even if you change path settings. (VSP G1000, G1500, and VSP F1500) Emulation type, Capacity: System's volume emulation type and capacity. Journal ID: Journal identifier. (VSP Gx00 models and VSP Fx00 models) Capacity: Remote system's volume capacity Model/Serial number: System's model, serial number.

Pair Detail

Item	Description
Status	The pair's status
CTG ID	Consistency group identifier
Sub Status (VSP G1000, G1500, and VSP F1500)	S-VOL's consistency status. For URz, the SEQCHK status is displayed if there is no consistency in the update sequence between the S-VOL and other S-VOLs in the journal.
Reverse Resync (VSP G1000, G1500, and VSP F1500)	Indicates that a reverse resync has changed the copy direction.
Error Level	Whether pairs are split if an error occurs. Specified during the create pair procedure.
Secondary Volume Write	<p>Indicates whether data can be written (Enabled) or not written (Disabled) to the S-VOL. The pair must be split for Enabled to display.</p> <p>If the volume accessed is an S-VOL and can be written to, Enabled/Received or Enabled/Not Received is displayed. Indicates whether a write operation is received from the host or not.</p>

Item	Description
	In a 3DC multi-target and 3DC cascade configuration in which three UR sites are combined, if one of the mirrors set for the S-VOL is for delta resync, data cannot be written to the S-VOL, even if Enabled is set.
Initial Copy Priority	Initial copy scheduling order. The range is from 1 to 256 for UR in decimal. (VSP G1000, G1500, and VSP F1500) The range is from 0 to 256 for URz in decimal.
Paired Time	Date and time pair-creation completed.
Last Update Time	Date and time that the last update was run.
Pair Copy Time	Time used to copy the P-VOL.
Consistency Time (VSP G1000, G1500, and VSP F1500)	Time when data consistency is guaranteed.
Timer Type (VSP G1000, G1500, and VSP F1500)	URz only. Type of clock used for consistency time, specified during journal creation. A hyphen (-) is displayed for UR pairs. <ul style="list-style-type: none"> System: Mainframe system clock. Local: System clock is not used. None: Mainframe system clock.
Local Storage System	<ul style="list-style-type: none"> Virtual storage machine: Virtual storage machine's model type and serial number. Virtual LDEV ID: Volume's virtual LDEV identifier. Device Name: Volume's virtual device name, in the format: virtual emulation type/number of virtual LUSE volumes/virtual CVS attribute <ul style="list-style-type: none"> - Only attributes that are specified display. - "CVS" displays at the end of the device name, if the virtual CVS attribute is specified. - A blank indicates no values are specified. Virtual SSID: Volume's virtual SSID. A blank indicates that no virtual SSID is specified.
Remote Storage System	<ul style="list-style-type: none"> Virtual storage machine: Virtual storage machine's model type and serial number. Virtual LDEV ID: Volume's virtual LDEV identifier.
CFW (VSP G1000, G1500, and VSP F1500)	URz only. Whether CFW data is copied to the S-VOL; specified during pair creation.
Page Number	Current/Selected

Split Pairs wizard

Use this wizard to split pairs.

Split Pairs window

Use this window to split pairs.

For instructions, see the procedure in [Splitting a UR pair on page 134](#).

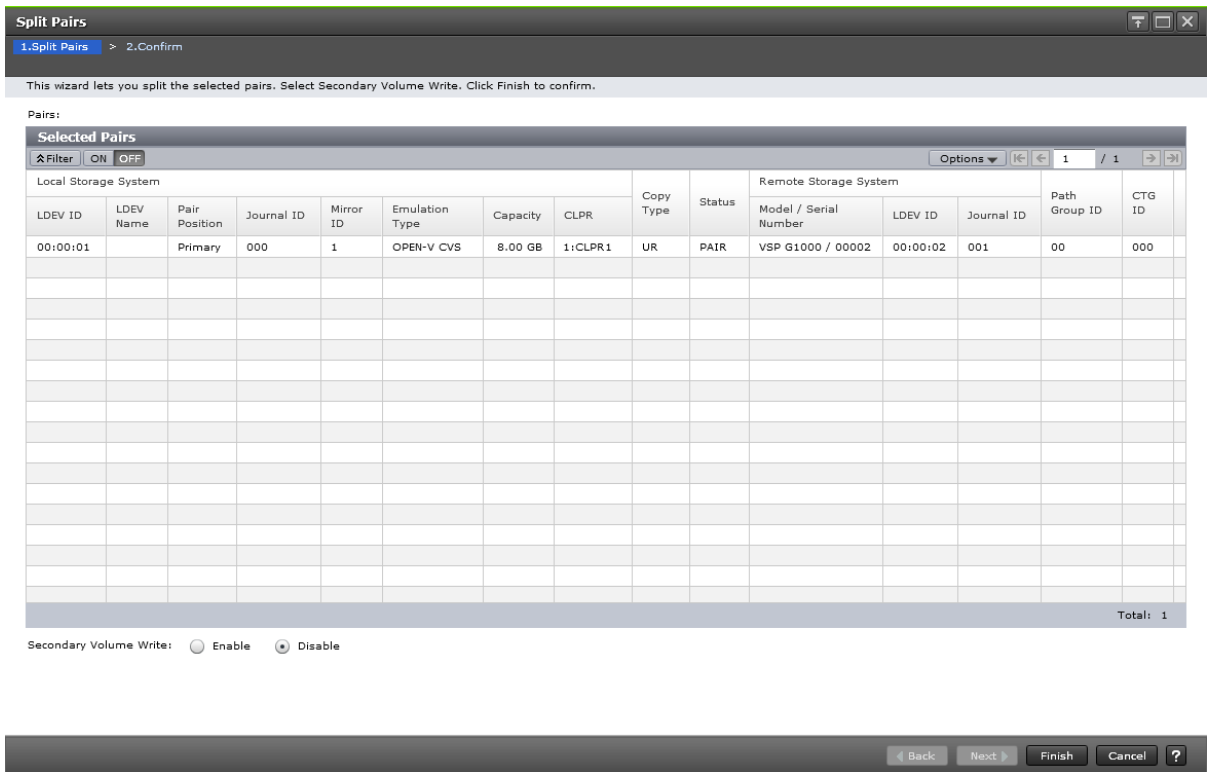

Selected Pairs table

Item	Description
Local Storage System	<p>Displays the following information about pair volumes in the Local Storage System.</p> <ul style="list-style-type: none"> • LDEV ID: Pair volume LDEV identifier. • LDEV Name: Pair volume LDEV name. • Pair Position: Identifies the volume as primary or secondary. • Journal ID: Journal identifier. • Mirror ID: Mirror identifier • (VSP G1000, G1500, and VSP F1500) Emulation Type: Pair volume emulation type. • (VSP Gx00 models and VSP Fx00 models) Attribute: LDEV attribute. • Capacity: Pair volume capacity • CLPR: CLPR ID
Copy Type	<p>Type of pair:</p> <ul style="list-style-type: none"> • UR: Universal Replicator • (VSP G1000, G1500, and VSP F1500) URMF: Universal Replicator for Mainframe • (VSP Gx00 models and VSP Fx00 models) TC: TrueCopy
Status	<p>Pair status.</p>
Remote Storage System	<p>Displays the following information about pair volumes in the Remote Storage System.</p> <ul style="list-style-type: none"> • Model/Serial Number: Storage system model name and serial number. • LDEV ID: Pair volume LDEV identifier.

Item	Description
	<ul style="list-style-type: none"> Journal ID: Journal identifier.
Path Group ID	Path group identifier.
CTG ID	Pair's consistency group identifier

Settings

Item	Description
Secondary Volume Write	<p>Indicates whether data can be written to the S-VOL while the pair is split.</p> <ul style="list-style-type: none"> Enable: Data can be written to the S-VOL. Available only when the selected mirror's Attribute is Master. If Restore, Disable is used automatically. Disable: The default. Data cannot be written to the S-VOL.

Split Pairs confirmation window

Split Pairs

1.Split Pairs > 2.Confirm

Enter a name for the task. Confirm the settings in the list and click Apply to add task in Tasks queue for execution

Task Name: (Max. 32 Characters)

Selected Pairs										Remote Storage System						
Local Storage System																
LDEV ID	LDEV Name	Pair Position	Journal ID	Mirror ID	Emulation Type	Capacity	CLPR	Copy Type	Status	Secondary Volume Write	Split Mode	Model / Serial Number	LDEV ID	Journal ID	Path Group ID	CTG ID
00:00:01		Primary	000	1	OPEN-V CVS	8.00 GB	1:CLPR1	UR	PAIR	Disabled	Flush	VSP G1000 / 00002	00:00:02	001	00	000
Total: 1																

Go to tasks window for status Back Next Apply Cancel ?

Selected Pairs table

Item	Description
Local Storage System	<p>Displays the following information about pair volumes in the Local Storage System.</p> <ul style="list-style-type: none"> LDEV ID: Pair volume LDEV identifier. LDEV Name: Pair volume LDEV name. Pair Position: Identifies the volume as primary or secondary.

Item	Description
	<ul style="list-style-type: none"> Journal ID: Journal identifier. Mirror ID: Mirror identifier (VSP G1000, G1500, and VSP F1500) Emulation Type: Pair volume emulation type. (VSP Gx00 models and VSP Fx00 models) Attribute: LDEV attribute. Capacity: Pair volume capacity CLPR: CLPR ID
Copy Type	Type of pair: <ul style="list-style-type: none"> UR: Universal Replicator (VSP G1000, G1500, and VSP F1500) URMF: Universal Replicator for Mainframe (VSP Gx00 models and VSP Fx00 models) TC: TrueCopy
Status	Pair status.
Secondary Volume Write	Indicates whether data can be written to the S-VOL when the pair is split. A hyphen displays if performing the split operation from the secondary storage system, regardless of the option selected.
Split Mode	Indicates whether update data is written to S-VOLs in the mirror before the split operation. <ul style="list-style-type: none"> Flush: Data is copied to S-VOLs. Purge: Data is not copied to S-VOLs until resynchronization.
Remote Storage System	Displays the following information about pair volumes in the Remote Storage System. <ul style="list-style-type: none"> Model/Serial Number: Storage system model name and serial number. LDEV ID: Pair volume LDEV identifier Journal ID: Journal identifier.
Path Group ID	Path group identifier.
CTG ID	Pair's consistency group identifier

Split Mirrors wizard

Use this wizard to split mirrors.

Split Mirrors window

Use this window to split pairs.

For instructions, see the procedure in [Splitting a mirror on page 136](#).

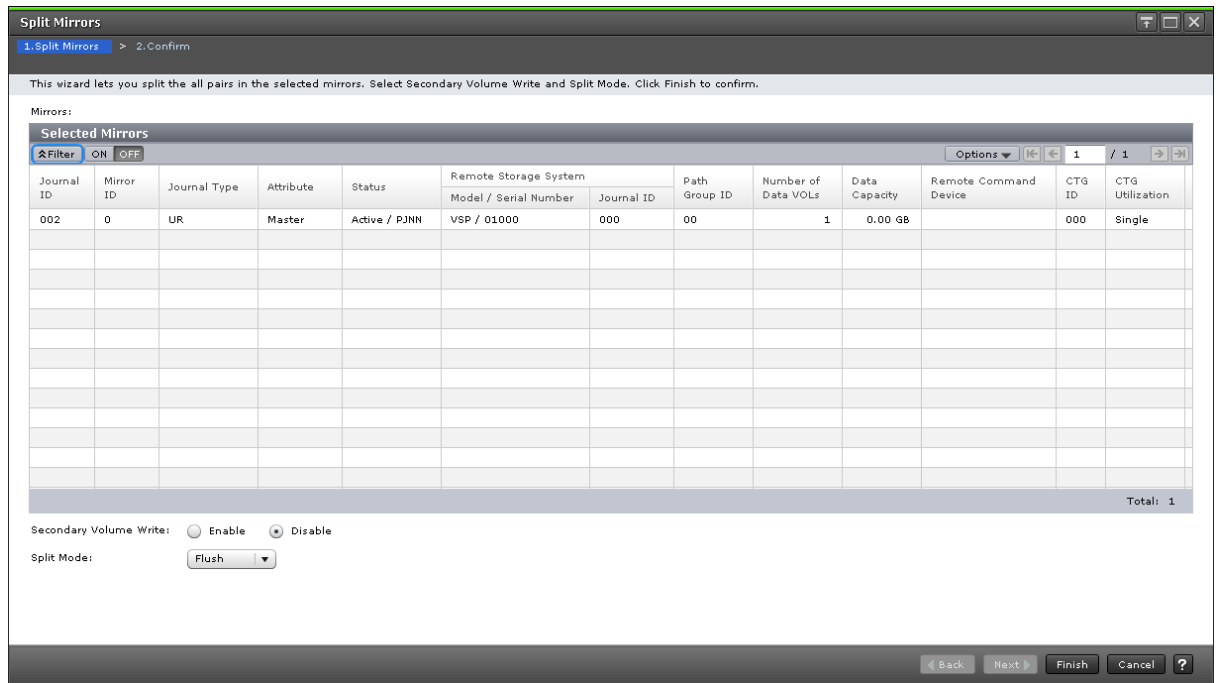

Selected Mirrors table

Item	Description
Journal ID	Journal identifier.
Mirror ID	Mirror's identifier
Journal Type (VSP G1000, G1500, and VSP F1500)	Journal copy type, UR or URMF, plus the following journal type option: <ul style="list-style-type: none"> Standard, a normal pair <p>If Standard is the journal type option, then only the copy type is displayed.</p> <p>Journal type options are defined in the Create Journals window.</p>
Attribute	Mirror's attribute: Master, Restore, or Initial. <ul style="list-style-type: none"> Master is displayed when the P-VOL is paired (initial copy performed). Restore is displayed when the S-VOL is paired (initial copy performed). Initial is displayed when neither data volume is paired yet (initial copy not performed).
Status	Mirror's status.
Remote Storage System	Displays the following information about pair volumes in the Remote Storage System. <ul style="list-style-type: none"> Model/Serial Number: Storage system model name and serial number. Journal ID: Journal identifier.
Path Group ID	Path group identifier.
Number of Data VOLs	Number of volumes associated with the journal. <p>(VSP Gx00 models and VSP Fx00 models) With the delta resync configuration, the number of data volumes registered to the journal of the mirrors not for delta resync is displayed. The number of volumes registered to the journal of</p>

Item	Description
	the delta resync mirrors (whose status is Hold, Holding, or Hold(Failure)) is not displayed.
Data Capacity	Total capacity of all the data volumes. (VSP G1000, G1500, and VSP F1500) If the journal uses multiple mirror IDs, the capacity of volumes in mirrors with Hold, Holding, or Hold(Failure) status is not included. (VSP Gx00 models and VSP Fx00 models) With the delta resync configuration, the total capacity of the data volumes registered to the journal of the mirrors not for delta resync is displayed. The total capacity of the data volumes registered to the journal of the delta resync mirrors (whose status is Hold, Holding, or Hold(Failure)) is not displayed.
Remote Command Device	LDEV number of the remote command device if it is assigned to the mirror. <ul style="list-style-type: none"> The column is blank if the remote command device is not assigned to the mirror. A hyphen (-) indicates the remote command device cannot be assigned to the mirror.
CTG ID	Consistency group identifier.
CTG Utilization	Whether the consistency group is shared by multiple storage systems. <ul style="list-style-type: none"> Single: The consistency group consists of a single pair of primary and secondary storage systems. Multi: The consistency group consists of multiple storage systems.

Settings

Item	Description
Secondary Volume Write	Whether data can be written to the S-VOL while the pair is split. <ul style="list-style-type: none"> Enable: Data can be written to the S-VOL. Available only when the selected mirror's Attribute is Master. If Restore, Disable is used automatically. Disable: Data cannot be written to the S-VOL (default).
Split Mode	Whether update data is written to S-VOLs in the mirror before the split operation. <ul style="list-style-type: none"> Flush: Data is copied to S-VOLs. Purge: Data is not copied to S-VOLs until resynchronization.

Split Mirrors confirmation window

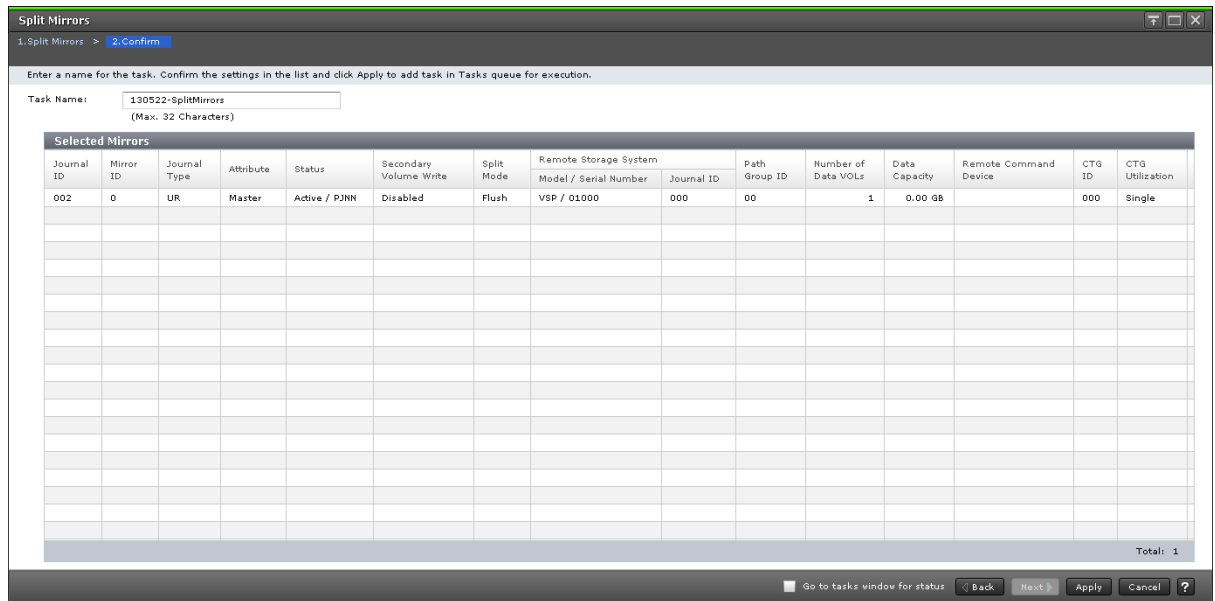

Selected Mirrors table

Item	Description
Journal ID	Journal identifier.
Mirror ID	Mirror's identifier
Journal Type (VSP G1000, G1500, and VSP F1500)	Journal copy type, UR or URMF, plus the following journal type option: <ul style="list-style-type: none"> Standard, a normal pair If Standard is the journal type option, then only the copy type is displayed. Journal type options are defined in the Create Journals window.
Attribute	Mirror's attribute: Master, Restore, or Initial. <ul style="list-style-type: none"> Master is displayed when the P-VOL is paired (initial copy performed). Restore is displayed when the S-VOL is paired (initial copy performed). Initial is displayed when neither data volume is paired yet (initial copy not performed).
Status	Mirror's status.
Secondary Volume Write	Indicates whether data can be written to the S-VOL while the pair is split. <ul style="list-style-type: none"> Enable: Data can be written to the S-VOL. Disable: Data cannot be written to the S-VOL. A hyphen displays if performing the split operation from the secondary storage system, regardless of the option selected.
Split Mode	Whether update data is written to S-VOLs in the mirror before the split operation. <ul style="list-style-type: none"> Flush: Data is copied to S-VOLs. Purge: Data is not copied to S-VOLs until resynchronization.
Remote Storage System	Displays the following information about pair volumes in the Remote Storage System. <ul style="list-style-type: none"> Model/Serial Number: Storage system model name and serial number.

Item	Description
	<ul style="list-style-type: none"> LDEV ID: Pair volume LDEV identifier Journal ID: Journal identifier.
Path Group ID	Path group's identifier.
Number of Data VOLS	<p>Number of volumes associated with the journal.</p> <p>(VSP Gx00 models and VSP Fx00 models) With the delta resync configuration, the number of data volumes registered to the journal of the mirrors not for delta resync is displayed. The number of volumes registered to the journal of the delta resync mirrors (whose status is Hold, Holding, or Hold(Failure)) is not displayed.</p>
Data Capacity	<p>Total capacity of all the data volumes.</p> <p>(VSP G1000, G1500, and VSP F1500) If the journal uses multiple mirror IDs, the capacity of volumes in mirrors with Hold, Holding, or Hold(Failure) status is not included.</p> <p>(VSP Gx00 models and VSP Fx00 models) With the delta resync configuration, the total capacity of the data volumes registered to the journal of the mirrors not for delta resync is displayed. The total capacity of the data volumes registered to the journal of the delta resync mirrors (whose status is Hold, Holding, or Hold(Failure)) is not displayed.</p>
Remote Command Device	<p>LDEV number of the remote command device if it is assigned to the mirror.</p> <ul style="list-style-type: none"> The column is blank if the remote command device is not assigned to the mirror. A hyphen (-) indicates the remote command device cannot be assigned to the mirror.
CTG ID	Consistency group identifier.
CTG Utilization	<p>Whether the consistency group is shared by multiple storage systems.</p> <ul style="list-style-type: none"> Single: The consistency group consists of a single pair of primary and secondary storage systems. Multi: The consistency group consists of multiple storage systems.

Resync Pairs wizard

Use this wizard to resynchronize pairs.

Resync Pairs window

Use this window to resynchronize pairs.

For instructions, see the procedure in [Resynchronizing a UR pair on page 138](#).

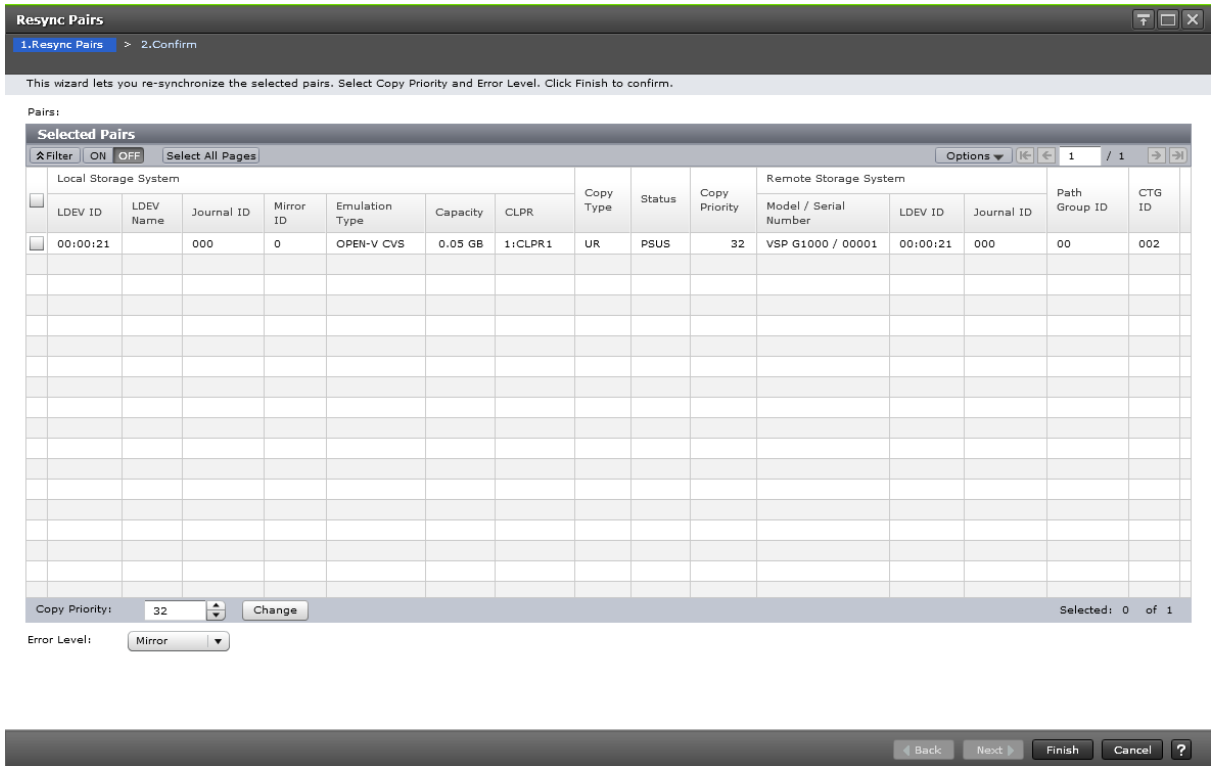

Selected Pairs table

Item	Description
Local Storage System	Displays the following information about pair volumes in the accessed system. <ul style="list-style-type: none"> LDEV ID: Pair volume LDEV identifier. LDEV Name: Pair volume LDEV name. Journal ID: Journal identifier. Mirror ID: Mirror identifier. (VSP G1000, G1500, and VSP F1500) Emulation Type: Pair volume emulation type. (VSP Gx00 models and VSP Fx00 models) Attribute: LDEV attribute. Capacity: Pair volume capacity. CLPR: CLPR ID.
Copy Type	Type of pair: <ul style="list-style-type: none"> UR: Universal Replicator (VSP G1000, G1500, and VSP F1500) URMF: Universal Replicator for Mainframe (VSP Gx00 models and VSP Fx00 models) TC: TrueCopy.
Status	Pair status.
Copy Priority	Scheduling order for resync operations. The range is from 1 to 256 for UR. (VSP G1000, G1500, and VSP F1500) 0-256 for URz.

Item	Description
Remote Storage System	Displays the following information about pair volumes in the Remote Storage System. <ul style="list-style-type: none"> Model/Serial Number: Storage system model name and serial number. LDEV ID: Pair volume LDEV identifier Journal ID: Journal identifier.
Path Group ID	Path group identifier.
CTG ID	Pair's consistency group identifier
Copy Priority button	Scheduling order for resync operations. The range is from 1 to 256 for UR. (VSP G1000, G1500, and VSP F1500) 0-256 for URz.

Settings

Item	Description
Error Level	Used to select which pairs are split if an error occurs. <ul style="list-style-type: none"> Mirror: All pairs in the mirror are split. LU: Only the failed pair is split. UR only. (VSP G1000, G1500, and VSP F1500) Volume: Only the failed pair is split. URz only.

Resync Pairs confirmation window

Resync Pairs

1. Resync Pairs > 2. Confirm

Enter a name for the task. Confirm the settings in the list and click Apply to add task in Tasks queue for execution.

Task Name: (Max. 32 Characters)

Local Storage System							Remote Storage System								
LDEV ID	LDEV Name	Journal ID	Mirror ID	Emulation Type	Capacity	CLPR	Copy Type	Status	Copy Priority	Error Level	Model / Serial Number	LDEV ID	Journal ID	Path Group ID	CTG ID
00:00:21		000	0	OPEN-V CVS	0.05 GB	1:CLPR1	UR	PSUS	32	Mirror	VSP G1000 / 00001	00:00:21	000	00	002
Total: 1															

Go to tasks window for status | Back | Next | Apply | Cancel | ?

Item	Description
Local Storage System	Displays the following information about pair volumes in the accessed system. <ul style="list-style-type: none"> • LDEV ID: Pair volume LDEV identifier. • LDEV Name: Pair volume LDEV name. • Journal ID: Journal identifier. • Mirror ID: Mirror identifier. • (VSP G1000, G1500, and VSP F1500) Emulation Type: Pair volume emulation type. • (VSP Gx00 models and VSP Fx00 models) Attribute: LDEV attribute. • Capacity: Pair volume capacity. • CLPR: CLPR ID.
Copy Type	Type of pair: <ul style="list-style-type: none"> • UR: Universal Replicator • (VSP G1000, G1500, and VSP F1500) URMF: Universal Replicator for Mainframe • (VSP Gx00 models and VSP Fx00 models) TC: TrueCopy.
Status	Pair status.
Copy Priority	Scheduling order for resync operations. The range is from 1 to 256 for UR. (VSP G1000, G1500, and VSP F1500) 0-256 for URz.
Error Level	Which pairs are split if an error occurs. <ul style="list-style-type: none"> • Mirror: All pairs in the mirror are split. • (Open systems) LU: Only failed pair is split. • (Mainframe systems) Volume: Only failed pair is split.
Remote Storage System	Displays the following information about pair volumes in the system connected to the system you accessed. <ul style="list-style-type: none"> • Model/Serial Number: Storage system model name and serial number. • LDEV ID: Pair volume LDEV identifier • Journal ID: Journal identifier.
Path Group ID	Path group identifier.
CTG ID	Pair's consistency group identifier

Resync Mirrors wizard

Use this wizard to resynchronize mirrors.

Resync Mirrors window

Use this window to resynchronize mirrors.

For instructions, see the procedure in [Resynchronizing a mirror on page 140](#).

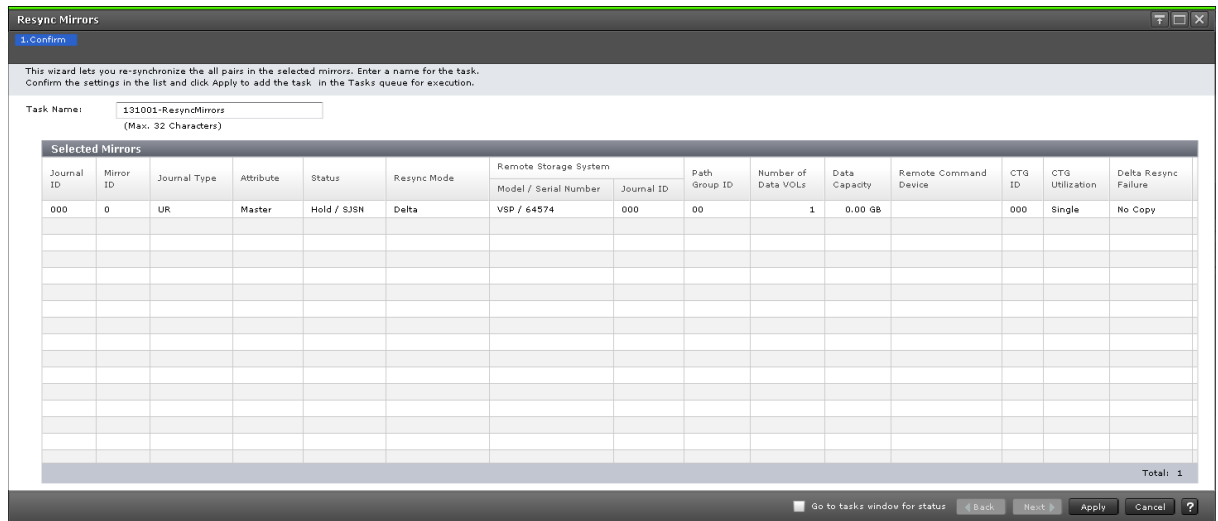

Selected Mirrors table

Item	Description
Journal ID	Journal identifier.
Mirror ID	Mirror's identifier
Journal Type (VSP G1000, G1500, and VSP F1500)	Journal copy type, UR or URMF, plus the following journal type option: <ul style="list-style-type: none"> Standard, a normal pair <p>If Standard is the journal type option, then only the copy type is displayed.</p> <p>Journal type options are defined in the Create Journals window.</p>
Attribute	Attribute of the mirror: Master, Restore, or Initial. <ul style="list-style-type: none"> Master is displayed when the P-VOL is paired (initial copy performed). Restore is displayed when the S-VOL is paired (initial copy performed). Initial is displayed when neither data volume is paired yet (initial copy not performed).
Status	Status of the mirror.
Resync Mode	The type of mirror resynchronization to be performed. <ul style="list-style-type: none"> Normal: Resynchronizes split pairs in the mirror that are in PSUS or PSUE status (open systems) or Suspend status (mainframe systems). Delta: Runs the delta resync operation for all pairs in the mirror. Return to standby: Recovers the status of pairs in the mirror from HLDE to HOLD for open systems (Hlde to Hold for mainframe).
Remote Storage System	Displays the following information about pair volumes in the Remote Storage System. <ul style="list-style-type: none"> Model/Serial Number: Storage system model name and serial number. Journal ID: Journal identifier.
Path Group ID	Path group identifier.
Number of Data VOLS	Number of volumes associated with the journal. <p>(VSP Gx00 models and VSP Fx00 models) With the delta resync configuration, the number of data volumes registered to the journal of the mirrors not for delta resync is displayed. The number of volumes registered to the journal of</p>

Item	Description
	the delta resync mirrors (whose status is Hold, Holding, or Hold(Failure)) is not displayed.
Data Capacity	<p>Total capacity of all the data volumes.</p> <p>(VSP G1000, G1500, and VSP F1500) If the journal uses multiple mirror IDs, the capacity of volumes in mirrors with Hold, Holding, or Hold(Failure) status is not included.</p> <p>(VSP Gx00 models and VSP Fx00 models) With the delta resync configuration, the total capacity of the data volumes registered to the journal of the mirrors not for delta resync is displayed. The total capacity of the data volumes registered to the journal of the delta resync mirrors (whose status is Hold, Holding, or Hold(Failure)) is not displayed.</p>
Remote Command Device	<p>LDEV number of the remote command device if it is assigned to the mirror.</p> <ul style="list-style-type: none"> • The column is blank if the remote command device is not assigned to the mirror. • A hyphen (-) indicates the remote command device cannot be assigned to the mirror.
CTG ID	Consistency group identifier.
CTG Utilization	<p>Whether the consistency group is shared by multiple storage systems.</p> <ul style="list-style-type: none"> • Single: The consistency group consists of a single pair of primary and secondary storage systems. • Multi: The consistency group consists of multiple storage systems.
Delta Resync Failure	<p>Processing to take place if delta resync cannot be performed.</p> <ul style="list-style-type: none"> • Entire Copy: All data in the P-VOL is copied to the S-VOL. • No Copy: No data is copied to the S-VOL.

Delete Pairs wizard

Use this wizard to delete pairs.

Delete Pairs window

Use this window to delete pairs.

For instructions, see the procedure in [Deleting a UR pair on page 141](#).

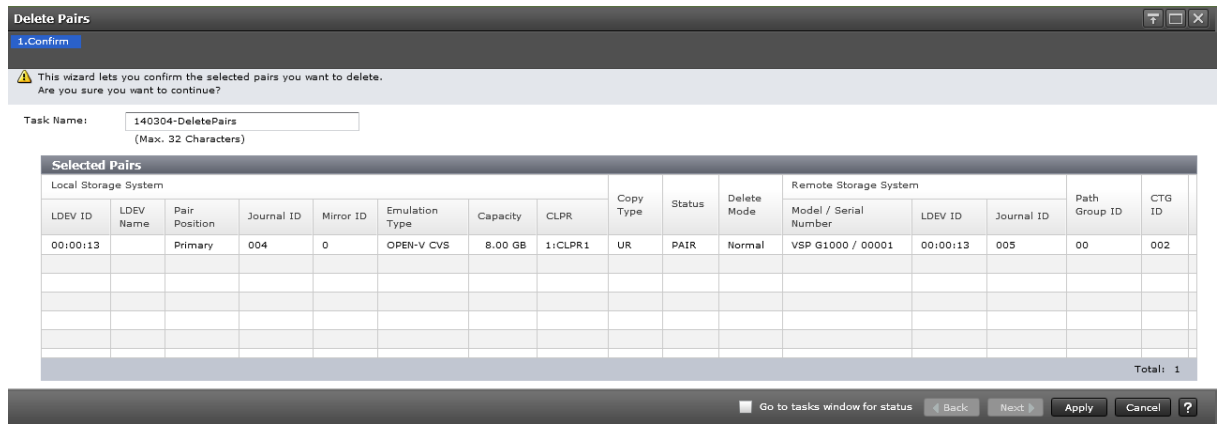

Item	Description
Local Storage System	Displays the following information about pair volumes in the Local Storage System. <ul style="list-style-type: none"> LDEV ID: Pair volume LDEV identifier. LDEV Name: Pair volume LDEV name. Pair Position: Whether the volume is a primary or secondary volume Journal ID: Journal identifier. Mirror ID: Mirror identifier. (VSP G1000, G1500, and VSP F1500) Emulation Type: Pair volume emulation type. (VSP Gx00 models and VSP Fx00 models) Attribute: LDEV attribute. Capacity: Pair volume capacity. CLPR: CLPR ID.
Copy Type	Type of pair: <ul style="list-style-type: none"> UR: Universal Replicator (VSP G1000, G1500, and VSP F1500) URMF: Universal Replicator for Mainframe (VSP Gx00 models and VSP Fx00 models) TC: TrueCopy.
Status	Pair status.
Delete Mode	Options for deleting pairs. Only Normal is available.
Remote Storage System	Displays the following information about pair volumes in the Remote Storage System. <ul style="list-style-type: none"> Model/Serial Number: Storage system model name and serial number. LDEV ID: Pair volume LDEV identifier Journal ID: Journal identifier.
Path Group ID	Path group identifier.
CTG ID	Pair's consistency group identifier

Delete Pairs confirmation window

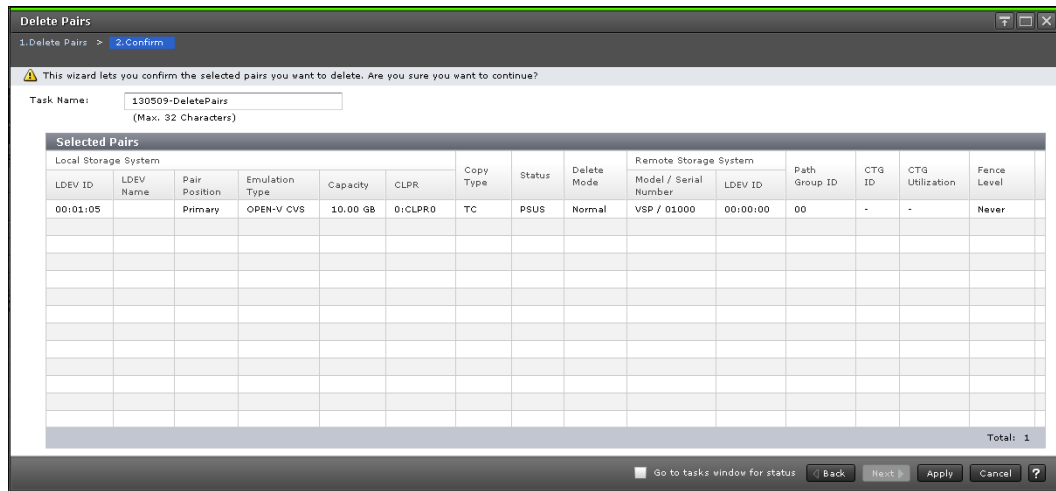

Selected Pairs table

Item	Description
Local Storage System	Information about volumes in the accessed system. <ul style="list-style-type: none"> LDEV ID: LDEV identifier. LDEV Name: LDEV name. Pair Position: Whether volume is a P-VOL or S-VOL. (VSP G1000, G1500, and VSP F1500) Emulation Type: Emulation type of the volume. (VSP Gx00 models and VSP Fx00 models) Attribute: LDEV attribute. Capacity: Capacity of the volume. CLPR: CLPR ID of the volume.
Copy Type	Type of pair: <ul style="list-style-type: none"> TC: TrueCopy (VSP G1000, G1500, and VSP F1500) TCMF: TrueCopy for Mainframe
Status	Pair status.
Delete Mode	How the pair is deleted.
Remote Storage System	Information about the remote system. <ul style="list-style-type: none"> Model / Serial Number: Model and serial number. (VSP G1000, G1500, and VSP F1500) SSID: SSID number. TCz only. LDEV ID: LDEV identifier.
Path Group ID	TC only. Path group identifier.
CTG ID	Pair's consistency group identifier.
CTG Utilization	Whether the consistency group is shared by multiple storage systems. <ul style="list-style-type: none"> Single: The consistency group consists of a single pair of primary and secondary storage systems.

Item	Description
	<ul style="list-style-type: none"> Multi: The consistency group consists of multiple storage systems.
Preserve Mirror Status (VSP G1000, G1500, and VSP F1500)	TCz only. <ul style="list-style-type: none"> Blank: Indicates that it is a Preserve Mirror status without any problem or it is not a Preserve Mirror pair. Withdrawn: Indicates that pair volume data does not match due to suspending copy of Compatible FlashCopy® V2.
Fence Level	P-VOL fence level.

Force Delete Pairs window

Use this window to forcibly delete pairs.

For instructions, see the procedure in [Forcibly deleting pairs on page 208](#).

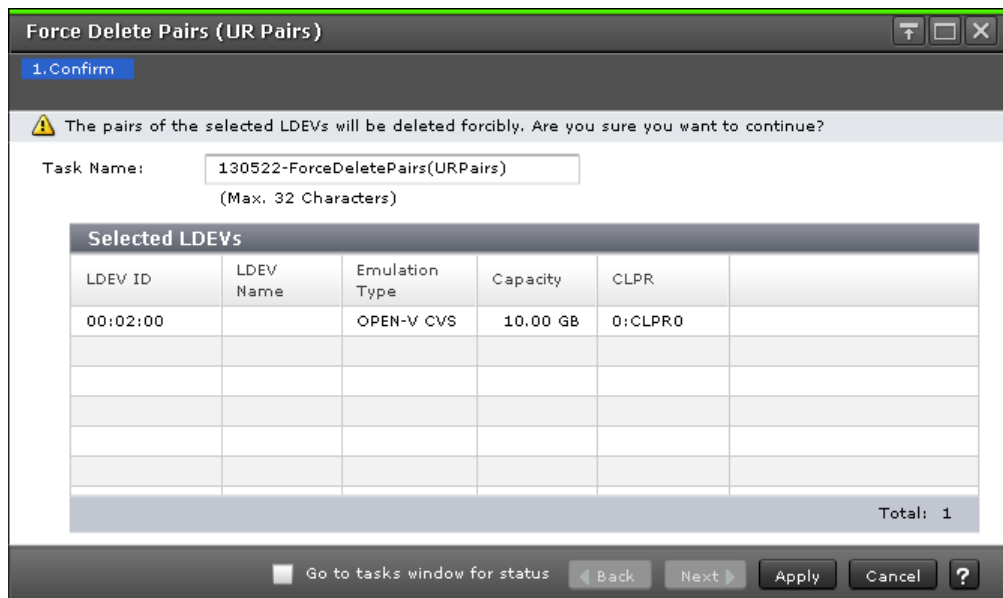

Item	Description
LDEV ID	The Pair volume LDEV identifier
LDEV Name	Name of the pair volume LDEV.
Emulation Type (VSP G1000, G1500, and VSP F1500)	The volume's emulation type.
Capacity	The volume's Capacity.
CLPR	The volume's CLPR ID.

Delete Mirrors wizard

Use this wizard to delete mirrors.

Delete Mirrors window

Use this window to delete mirrors.

For instructions, see the procedure in [Deleting pairs in a mirror on page 144](#).

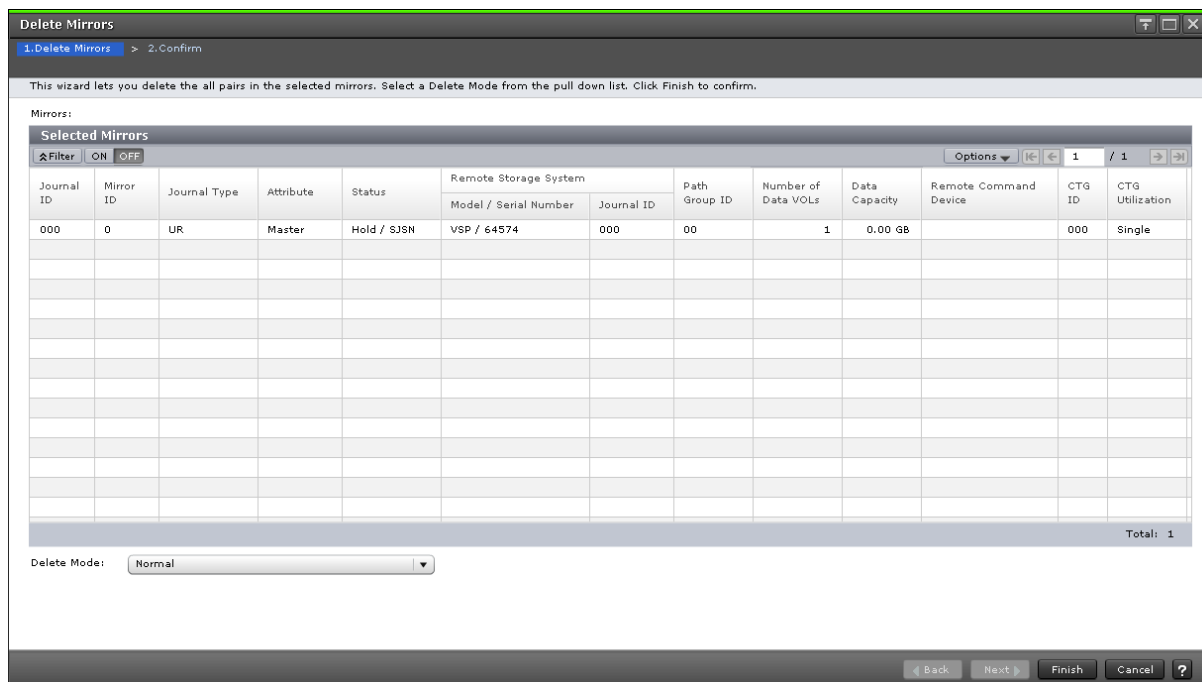

Item	Description
Journal ID	Journal identifier.
Mirror ID	Mirror's identifier
Journal Type (VSP G1000, G1500, and VSP F1500)	Journal copy type, UR or URMF, plus the following journal type option: <ul style="list-style-type: none"> Standard, a normal pair If Standard is the journal type option, then only the copy type is displayed. Journal type options are defined in the Create Journals window.
Attribute	Mirror's attribute: Master, Restore, or Initial. <ul style="list-style-type: none"> Master is displayed when the P-VOL is paired (initial copy performed). Restore is displayed when the S-VOL is paired (initial copy performed). Initial is displayed when neither data volume is paired yet (initial copy not performed).
Status	Mirror's status.

Item	Description
Remote Storage System	Displays the following information about pair volumes in the Remote Storage System. <ul style="list-style-type: none"> Model/Serial Number: Storage system model name and serial number. Journal ID: Journal identifier.
Path Group ID	Path group identifier.
Number of Data VOLS	Number of volumes associated with the journal. (VSP Gx00 models and VSP Fx00 models) With the delta resync configuration, the number of data volumes registered to the journal of the mirrors not for delta resync is displayed. The number of volumes registered to the journal of the delta resync mirrors (whose status is Hold, Holding, or Hold(Failure)) is not displayed.
Data Capacity	Total capacity of all the data volumes. (VSP G1000, G1500, and VSP F1500) If the journal uses multiple mirror IDs, the capacity of volumes in mirrors with Hold, Holding, or Hold(Failure) status is not included. (VSP Gx00 models and VSP Fx00 models) With the delta resync configuration, the total capacity of the data volumes registered to the journal of the mirrors not for delta resync is displayed. The total capacity of the data volumes registered to the journal of the delta resync mirrors (whose status is Hold, Holding, or Hold(Failure)) is not displayed.
Remote Command Device	LDEV number of the remote command device if it is assigned to the mirror. <ul style="list-style-type: none"> The column is blank if the remote command device is not assigned to the mirror. A hyphen (-) indicates the remote command device cannot be assigned to the mirror.
CTG ID	Consistency group identifier.
CTG Utilization	Indicates whether the consistency group is shared by multiple storage systems. <ul style="list-style-type: none"> Single: The consistency group consists of a single pair of primary and secondary storage systems. Multi: The consistency group consists of multiple storage systems.
Delete Mode	Options for deleting pairs <ul style="list-style-type: none"> Normal: Delete pairs only when the primary storage system can change both the P-VOL and S-VOL to unpaired volumes. Force: Forcibly deletes pairs regardless of primary storage system's ability to change both volumes to unpaired. Force allows host operations to continue.

Delete Mirrors confirmation window

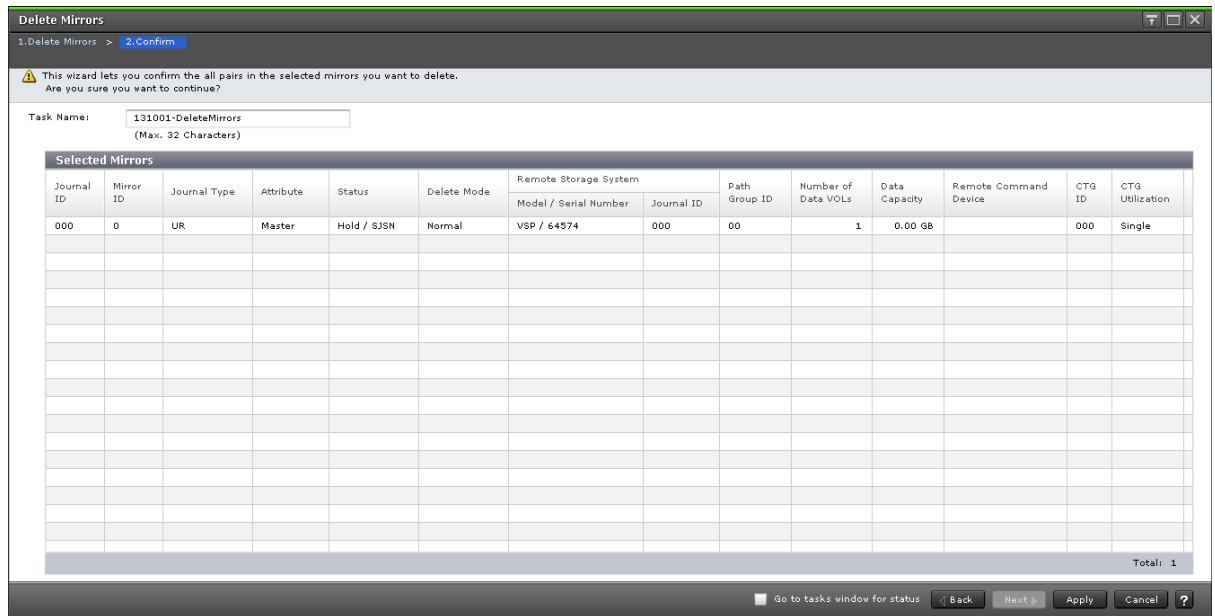

Item	Description
Journal ID	Journal identifier.
Mirror ID	Mirror's identifier
Journal Type (VSP G1000, G1500, and VSP F1500)	Journal copy type, UR or URMF, plus the following journal type option: <ul style="list-style-type: none"> Standard, a normal pair If Standard is the journal type option, then only the copy type is displayed. Journal type options are defined in the Create Journals window.
Attribute	Mirror's attribute: Master, Restore, or Initial. <ul style="list-style-type: none"> Master is displayed when the P-VOL is paired (initial copy performed). Restore is displayed when the S-VOL is paired (initial copy performed). Initial is displayed when neither data volume is paired yet (initial copy not performed).
Status	Mirror's status.
Delete Mode	Shows whether mirrors are deleted forcibly or not.
Remote Storage System	Displays the following information about pair volumes in the Remote Storage System. <ul style="list-style-type: none"> Model/Serial Number: Storage system model name and serial number. Journal ID: Journal identifier.
Path Group ID	Path group identifier.
Number of Data VOLS	Number of volumes associated with the journal. (VSP Gx00 models and VSP Fx00 models) With the delta resync configuration, the number of data volumes registered to the journal of the mirrors not for delta resync is displayed. The number of volumes registered to the journal of the delta resync mirrors (whose status is Hold, Holding, or Hold(Failure)) is not displayed.
Data Capacity	Total capacity of all the data volumes.

Item	Description
	<p>(VSP G1000, G1500, and VSP F1500) If the journal uses multiple mirror IDs, the capacity of volumes in mirrors with Hold, Holding, or Hold(Failure) status is not included.</p> <p>(VSP Gx00 models and VSP Fx00 models) With the delta resync configuration, the total capacity of the data volumes registered to the journal of the mirrors not for delta resync is displayed. The total capacity of the data volumes registered to the journal of the delta resync mirrors (whose status is Hold, Holding, or Hold(Failure)) is not displayed.</p>
Remote Command Device	<p>LDEV number of the remote command device if it is assigned to the mirror.</p> <ul style="list-style-type: none"> The column is blank if the remote command device is not assigned to the mirror. A hyphen (-) indicates the remote command device cannot be assigned to the mirror.
CTG ID	Consistency group identifier.
CTG Utilization	<p>Whether the consistency group is shared by multiple storage systems.</p> <ul style="list-style-type: none"> Single: The consistency group consists of a single pair of primary and secondary storage systems. Multi: The consistency group consists of multiple storage systems.

Edit Pair Options wizard

Use this wizard to change pair options.

Edit Pair Options window

Use this window to change pair options.

For instructions, see the procedure in [Changing the pair options on page 207](#).

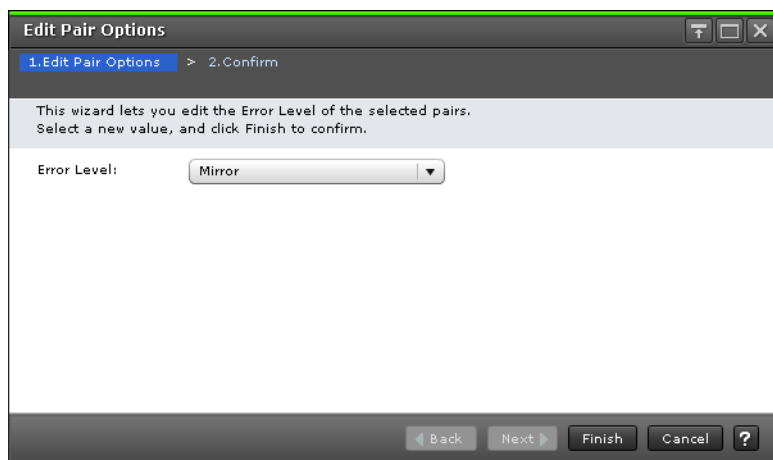

Item	Description
Error Level	The pairs that are split if an error occurs. <ul style="list-style-type: none"> • Mirror: All pairs in the mirror are split. • LU (UR): Only the failed pair is split. • (VSP G1000, G1500, and VSP F1500) Volume (URz): Only the failed pair is split.
CFW (VSP G1000, G1500, and VSP F1500)	URz only. Whether CFW data is copied to the S-VOL or not. <ul style="list-style-type: none"> • Primary Volume Only: Data is not copied to the S-VOL. • Secondary Volume Copy: Data is copied to the S-VOL.

Edit Pair Options confirmation window

Enter a name for the task.
Confirm the settings in the list and click Apply to add task in Tasks queue for execution.

Task Name: (Max. 32 Characters)

Local Storage System								Remote Storage System				Path Group ID	
LDEV ID	LDEV Name	Pair Position	Journal ID	Mirror ID	Emulation Type	Capacity	CLPR	Copy Type	Error Level	Model / Serial Number	LDEV ID	Journal ID	Path Group ID
00:01:00		Primary	002	0	OPEN-V CVS	10.00 GB	0:CLPR0	UR	Mirror	VSP / 01000	00:01:00	000	00
Total: 1													

Go to tasks window for status

Item	Description
Local Storage System	Displays the following information about pair volumes in the accessed system. <ul style="list-style-type: none"> • LDEV ID: Pair volume LDEV identifier. • LDEV Name: Pair volume LDEV name. • Pair Position: Whether the volume is a primary or secondary volume • Journal ID: Journal identifier. • Mirror ID: Mirror identifier. • (VSP G1000, G1500, and VSP F1500) Emulation Type: Pair volume emulation type. • (VSP Gx00 models and VSP Fx00 models) Attribute: LDEV attribute. • Capacity: Pair volume capacity. • CLPR: CLPR ID.
Copy Type	Type of pair: <ul style="list-style-type: none"> • UR: Universal Replicator • (VSP G1000, G1500, and VSP F1500) URMF: Universal Replicator for Mainframe • (VSP Gx00 models and VSP Fx00 models) TC: TrueCopy
Error Level	The pairs that are split if an error occurs:

Item	Description
	<ul style="list-style-type: none"> • Mirror: All pairs in the mirror are split. • LU (UR): Only the failed pair is split. • (VSP G1000, G1500, and VSP F1500) Volume (URz): Only the failed pair is split.
CFW (VSP G1000, G1500, and VSP F1500)	URz only. Whether CFW data is copied to the S-VOL or not. <ul style="list-style-type: none"> • P-VOL Only: Data is not copied to the S-VOL. • Copy to S-VOL: Data is copied to the S-VOL.
Remote Storage System	Displays the following information about pair volumes in the Remote Storage System. <ul style="list-style-type: none"> • Model/Serial Number: Storage system model name and serial number. • LDEV ID: Pair volume LDEV identifier • Journal ID: Journal identifier.
Path Group ID	Path group identifier.

Complete SIMs (UR) window (VSP G1000, G1500, and VSP F1500)

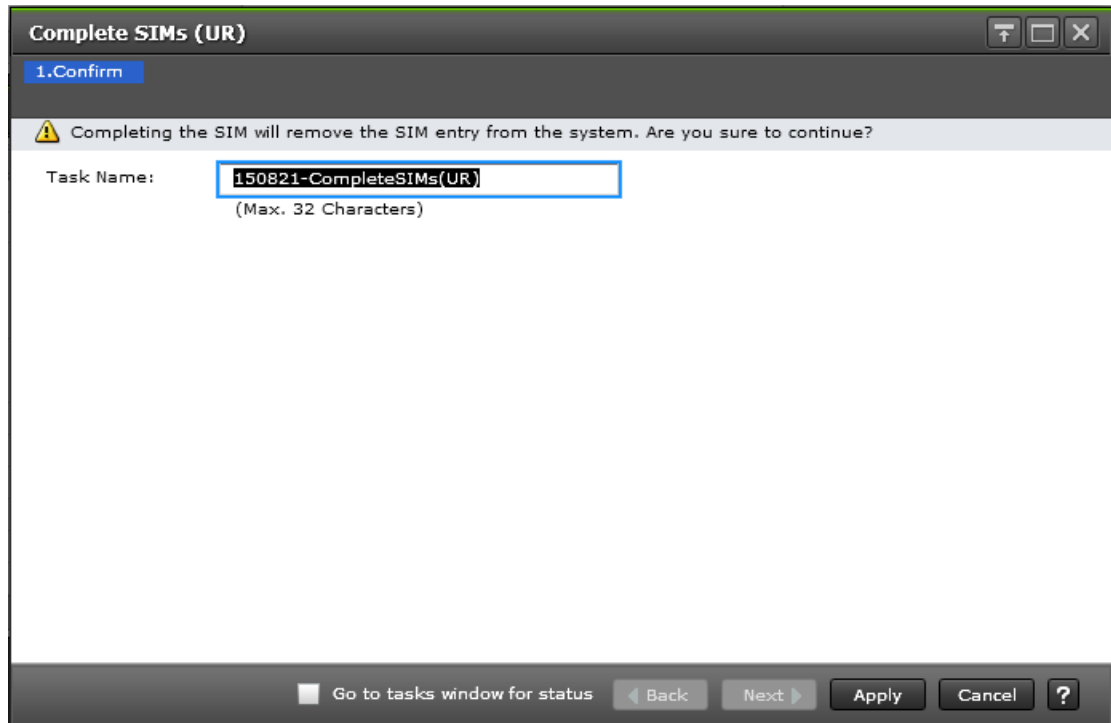

Item	Description
Task Name	Displays the default name of the task (date in the format <i>yymmdd</i> and description) and allows you to enter a different task name (maximum 32 characters, case sensitive).
Go to tasks window for status	When selected, the Tasks window opens automatically after you click Apply.

Replication window

Use this window to view information about pairs and pair volumes.

In this topic, you can view the following tables.

- Summary section
- Replica LDEVs tab

Summary section

Item	Description
Licensed Capacity (Used/Licensed)	Used capacity and licensed capacity for each local and remote replication program product.
Number of Replica LDEVs	Number of LDEVs used in replication.

Item	Description
Number of FCv2/FCSE relationships (VSP G1000, G1500, and VSP F1500)	Number of Compatible FlashCopy® V2 and Compatible FlashCopy® SE relationships.
Number of differential tables	<p>The number and the maximum number of differential tables that are already used in local replication.</p> <p>The number of differential tables that are already used in remote replication is not included.</p> <p>Differential tables will not be used for the following operations. Therefore, number of differential tables will not change when you execute the following operations.</p> <ul style="list-style-type: none"> • SI pair operations for a DP-VOL that exceeds 4 TB. • TI pair operations. • (VSP G1000, G1500, and VSP F1500) Siz pair operations for a DP-VOL that exceeds 262,668 cylinders. • (VSP G1000, G1500, and VSP F1500) Compatible FlashCopy® V2 or Compatible FlashCopy® SE relationship operations.
View History - Local Replication	Opens the History window for local replication.
View History - Remote Replication	Opens the History window for remote replication.
Edit Options - Local Replication	Opens the Edit Local Replica Options window.
Edit Options - Remote Replication	Opens the Edit Remote Replica Options window.
Edit Options - SCP Time (VSP G1000, G1500, and VSP F1500)	Opens the Edit SCP Time window.

Replica LDEVs tab

Item	Description
LDEV ID	LDEV identifier. Clicking the link opens the LDEV Properties window.
LDEV Name	LDEV name.
Emulation Type (VSP G1000, G1500, and VSP F1500)	LDEV's emulation type.
Capacity	LDEV's capacity.
Copy Type	<p>Copy and volume type of the pair.</p> <ul style="list-style-type: none"> • SI-L1: ShadowImage L1 pair • SI-L2: ShadowImage L2 pair • (VSP G1000, G1500, and VSP F1500) SIMF: ShadowImage for Mainframe pair • TI: Thin Image • (VSP G1000, G1500, and VSP F1500) FCv2: Compatible FlashCopy® V2 relationship • (VSP G1000, G1500, and VSP F1500) FCSE: Compatible FlashCopy® SE relationship • TC: TrueCopy pair

Item	Description
	<ul style="list-style-type: none"> • (VSP G1000, G1500, and VSP F1500) TCMF: TrueCopy for Mainframe pair • UR: Universal Replicator pair • (VSP G1000, G1500, and VSP F1500) URMF: Universal Replicator for Mainframe pair • GAD: global-active device pair <p>Volume types (SI, TI, SIMF, TC, UR, TCMF, URMF, GAD)</p> <ul style="list-style-type: none"> • Primary: Primary volume • Secondary: Secondary volume <p>Volume types (FCv2, FCSE)</p> <p>S indicates the source volume and T indicates the target volume:</p> <ul style="list-style-type: none"> • S-Normal: Normal source volume • T-Normal: Normal target volume • ST-Normal: Normal volumes set for both the source and target volumes • S-Failed, S-Full, S-Full & Failed: Abnormal source volume • T-Failed, T-Full, T-Full & Failed: Abnormal target volume • ST-Failed, ST-Full, ST-Full & Failed: Abnormal volume set for both the source and target volumes. <p>A hyphen (-) is displayed if no pair is set.</p>
Virtual Storage Machine*	<p>Information about the LDEV's virtual storage machine and about the LDEV.</p> <ul style="list-style-type: none"> • Model type/Serial number: Model type and serial number. • LDEV ID: Virtual LDEV identifier of the volume. • Device Name: Virtual device name of the volume, in the format: virtual emulation type/number of virtual LUSE volumes/virtual CVS attribute <ul style="list-style-type: none"> ○ Only attributes that are specified are displayed. ○ If the virtual CVS attribute is specified, "CVS" is displayed at the end of the device name. ○ A blank indicates that no values are specified. • SSID: Virtual SSID of the volume. A blank indicates that no virtual SSID is specified.
Export	Opens the window for exporting the table information.
* This item does not appear in the window by default. To display this item, change the Column Settings option for the table.	

Remote Replication window

Use this window to view information about remote replication pairs and mirrors UR / URz only.

Remote Replication Last Updated : 2015/08/20 10:22

storage(S/N:50) > Replication > Remote Replication

Number of Pairs		Number of Mirrors	
TrueCopy	2	Open	8
TrueCopy for Mainframe	2	Mainframe	0
Universal Replicator	0	Total	8
Universal Replicator for Mainframe	0		
Global-Active Device	6		
Total	10		

TC Pairs | UR Pairs | Mirrors | GAD Pairs | GAD Consistency Groups

Create TC Pairs | Split Pairs | Resync Pairs | More Actions

Selected: 0 of 4

Filter ON OFF | Select All Pages | Column Settings | Options

Local Storage System									
LDEV ID	LDEV Name	Port ID	Host Group Name / iSCSI Target Alias	iSCSI Target Name	LUN ID	Pair Position	Copy Type	Status	Remote Storage Sy Model / Serial Numl
00:00:37		-	-	-	-	Primary	TCMF	DUPLICATE ...	VSP G1000 / 00050
00:00:38		-	-	-	-	Secondary	TCMF	DUPLICATE ...	VSP G1000 / 00050
00:0A:00	DDMDP	CL3-B	3B-G00 (00)	-	0	Primary	TC	PSUE	VSP G1000 / 00050
00:0A:01	DDMDP	CL3-B	3B-G00 (00)	-	1	Secondary	TC	PSUE	VSP G1000 / 00050

Summary section

Item	Description
Number of Pairs	Number of pairs for each remote replication product and the total of all pairs.
Number of Mirrors	(VSP G1000, G1500, and VSP F1500) Open: Number of mirrors for open systems Mainframe: Number of mirrors for mainframe systems Total: Total number of mirrors

TC Pairs tab

Only the pairs to which the volumes of the local storage system are allocated for each user are displayed.

Item	Description
Local Storage System	Information about volumes in the accessed storage system.

Item	Description
	<ul style="list-style-type: none"> • LDEV ID: LDEV identifier. Click to open the LDEV Properties window. • LDEV Name: LDEV name. • Port ID: Port identifier. TC only. A hyphen (-) is displayed for TrueCopy for Mainframe pairs. • Host Group Name/iSCSI Target Alias: Host group name or iSCSI target alias. TC only. A hyphen (-) is displayed for TrueCopy for Mainframe pairs. • iSCSI Target Name: Volume's iSCSI target name. TC only. A hyphen (-) is displayed for TrueCopy for Mainframe pairs. • LUN ID: LUN identifier. TC only. A hyphen (-) is displayed for TrueCopy for Mainframe pairs. • Pair Position: Whether the volume is a primary or secondary volume. • Provisioning Type¹: Provisioning type of the volume. • (VSP G1000, G1500, and VSP F1500) Emulation Type¹: Emulation type of the volume. • (VSP Gx00 models and VSP Fx00 models) Attribute¹: Volume's LDEV attribute. • Capacity¹: Capacity of the volume. • CLPR¹: CLPR ID of the volume. • Encryption¹: Encryption information <ul style="list-style-type: none"> ○ Enabled: Encryption of the parity group to which the LDEV belongs is enabled, or a V-VOL is associated with a pool in which a pool volume has encryption enabled. ○ Disabled: Encryption of the parity group to which the LDEV belongs is disabled, or a V-VOL is associated with a pool in which a pool volume has encryption disabled. ○ Mixed: The pool to which the LDEV belongs contains two or more of the following: <ul style="list-style-type: none"> - Volume for which encryption is enabled - Volume for which encryption is disabled - External volume <p>Note: Encryption of data is not ensured in an LDEV with the Mixed encryption status. To manage data encryption, use an LDEV in which Encryption is Enabled or Disabled.</p> <p>For an external volume or migration volume, a hyphen (-) is displayed.</p> <p>For DP-VOL's, the pool to which the LDEV belongs is an external volume or blocked.</p> <ul style="list-style-type: none"> • Capacity Saving¹: Information on the capacity saving function. <ul style="list-style-type: none"> ○ Compression: The compression function is used. ○ Deduplication and Compression: The deduplication function and the compression function are used. ○ Disabled: The capacity saving function is not used. • T10 PI¹: T10 PI attribute of the volume. <ul style="list-style-type: none"> ○ Enabled: T10 PI attribute of the volume is enabled. ○ Disabled: T10 PI attribute of the volume is disabled. <p>A hyphen (-) is displayed if the emulation type is other than OPEN-V.</p> <ul style="list-style-type: none"> • Virtual storage machine¹: Virtual storage machine's model type and serial number. • Virtual LDEV ID¹: Virtual LDEV identifier of the volume.

Item	Description
	<ul style="list-style-type: none"> • Virtual Device Name¹: Virtual device name of the volume, in the format: virtual emulation type/number of virtual LUSE volumes/virtual CVS attribute <ul style="list-style-type: none"> ○ Only attributes that are specified are displayed. ○ If the virtual CVS attribute is specified, "CVS" is displayed at the end of the device name. ○ A blank indicates no values are specified. • Virtual SSID¹: Virtual SSID of the volume. A blank indicates that no virtual SSID is specified.
Copy Type (VSP G1000, G1500, and VSP F1500)	<ul style="list-style-type: none"> • TC: TrueCopy • TCMF: TrueCopy for Mainframe
Status	Pair status. In Storage Navigator, the pair status is displayed as pair-status-in-Storage-Navigator/pair-status-in-CCI-or-Business-Continuity-Manager. If the pair status in Device Manager - Storage Navigator and the pair status in CCI or Business Continuity Manager are the same, the pair status in CCI or Business Continuity Manager is not displayed.
Remote Storage System	<p>Information about volumes in the storage system connected to the accessed system.</p> <ul style="list-style-type: none"> • Model / Serial Number: Remote system's model and serial number. • (VSP G1000, G1500, and VSP F1500) SSID: Remote system's SSID number. TCz only. • LDEV ID: LDEV identifier. • Port ID: Port identifier when specifying an LDEV ID at pair creation. Note that this field does not change if the remote system path settings are changed. TC only. A hyphen (-) is displayed for TrueCopy for Mainframe pairs. • Host Group ID/iSCSI Target ID: Host group identifier or iSCSI target identifier when specifying an LDEV ID at pair creation. Note that this field does not change even if the remote system path settings are changed. TC only. A hyphen (-) is displayed for TrueCopy for Mainframe pairs. • LUN ID: LUN identifier. TC only. A hyphen (-) is displayed for TrueCopy for Mainframe pairs. • Virtual storage machine¹: Virtual storage machine's model type and serial number. • Virtual LDEV ID¹: Virtual LDEV identifier of the volume.
Path Group ID	Path group identifier.
Update Type ¹	<p>One of the following:</p> <ul style="list-style-type: none"> • Sync: It is a TC or TCMF pair which is not assigned to consistency group. • Sync (Specified CTG): It is a TC or TCMF pair created by specifying consistency group.
CTG ID ¹	Pair's consistency group identifier.
CTG Utilization ¹	<p>Whether the consistency group is shared by multiple storage systems.</p> <ul style="list-style-type: none"> • Single: The consistency group consists of a single pair of primary and secondary storage systems. • Multi: The consistency group consists of multiple storage systems.

Item	Description
Preserve Mirror Status ¹ (VSP G1000, G1500, and VSP F1500)	<ul style="list-style-type: none"> - (hyphen): Indicates that it is a Preserve Mirror status without any problem or it is not a Preserve Mirror pair. Withdrawn: Indicates that pair volume data does not match due to suspending copy of Compatible FlashCopy® V2.
Fence Level ¹	Specified P-VOL fence level.
Host I/O Time Stamp Transfer ¹ (VSP G1000, G1500, and VSP F1500)	Whether the host time stamp is transferred to an S-VOL.
Create TC Pairs	Opens the Create TC Pairs window.
Split Pairs	Opens the Split Pairs window.
Resync Pairs	Opens the Resync Pairs window.
View Pair Synchronization Rate ²	Opens the View Pair Synchronization Rate window when the pair's primary system is accessed.
View Pair Properties ²	Opens the View Pair Properties window.
View Remote Connection Properties ²	Opens the View Remote Connection Properties window.
Edit Pair Options ²	Opens the Edit Pair Options window.
Delete Pairs ²	Opens the Delete Pairs window.
Export ²	Opens the window for exporting the table information.
Notes: <ol style="list-style-type: none"> This item does not appear in the window by default. To display this item, change the Column Settings option for the table. This item is displayed when you select More Actions. 	

UR Pairs tab

Only the pairs to which the volumes of the local storage system are allocated for each user are displayed.

The screenshot shows the 'Remote Replication' GUI. At the top, it displays 'Storage(S/N:1) > Replication > Remote Replication' and 'Last Updated : 2015/09/16 22:03'. Below this is a summary table:

Number of Pairs		Number of Mirrors	
TrueCopy	4	Open	0
TrueCopy for Mainframe	0	Mainframe	0
Universal Replicator	0	Total	0
Universal Replicator for Mainframe	0		
Global-Active Device	0		
Total	4		

Below the summary table are tabs for 'TC Pairs', 'UR Pairs', 'Mirrors', 'GAD Pairs', and 'GAD Consistency Groups'. The 'UR Pairs' tab is active. It features a toolbar with 'Create UR Pairs', 'Split Pairs', 'Resync Pairs', and 'More Actions'. Below the toolbar is a table with the following columns: LDEV ID, LDEV Name, Port ID, Host Group Name / iSCSI Target Alias, iSCSI Target Name, LUN ID, Pair Position, Journal ID, Mirror ID, and Copy Type. The table is currently empty.

Item	Description
Local Storage System	<p>Information about volumes in the accessed storage system.</p> <ul style="list-style-type: none"> • LDEV ID: LDEV identifier. Clicking the link opens the LDEV Properties window. • LDEV Name: LDEV name. • Port ID: Port identifier. UR only. A hyphen (-) is displayed for URz pairs. • Host Group Name/iSCSI Target Alias: Host group name or iSCSI target alias. UR only. A hyphen (-) is displayed for URz pairs. • iSCSI Target Name: iSCSI target name. UR only. A hyphen (-) is displayed for URz pairs. • LUN ID: LUN identifier. UR only. A hyphen (-) is displayed for URz pairs. • Pair Position: Whether the volume is a primary or secondary volume. • Journal ID: Journal identifier. • Mirror ID: Mirror identifier. • Provisioning Type¹: Provisioning type of the volume. • (VSP G1000, G1500, and VSP F1500) Emulation Type¹: Emulation type of the volume. • (VSP Gx00 models and VSP Fx00 models) Attribute¹: Volume's LDEV attribute. • Capacity¹: Capacity of the volume. • CLPR¹: CLPR ID of the volume. • Encryption¹: Encryption information <ul style="list-style-type: none"> ◦ Enabled: Encryption of the parity group to which the LDEV belongs is enabled, or a V-VOL is associated with a pool in which a pool volume has encryption enabled. ◦ Disabled: Encryption of the parity group to which the LDEV belongs is disabled, or a V-VOL is associated with a pool in which a pool volume has encryption disabled. ◦ Mixed: The pool to which the LDEV belongs contains two or more of the following: <ul style="list-style-type: none"> - Volume for which encryption is enabled - Volume for which encryption is disabled - External volume <p>Note: Encryption of data is not ensured in an LDEV with the Mixed encryption status. To manage data encryption, use an LDEV in which Encryption is Enabled or Disabled.</p> <p>For an external volume or migration volume, a hyphen (-) is displayed.</p> <p>For Dynamic Provisioning or Dynamic Provisioning for Mainframe virtual volumes, the pool to which the LDEV belongs is an external volume or blocked.</p> <ul style="list-style-type: none"> • Journal Encryption¹: Journal's encryption status. <ul style="list-style-type: none"> ◦ Enabled: The journal contains encrypted volumes. ◦ Disabled: The journal contains unencrypted volumes. ◦ Mixed: The pool to which the journal volume belongs contains two or more of the following: <ul style="list-style-type: none"> - Volume for which encryption is enabled - Volume for which encryption is disabled - External volume

Item	Description
	<p>Note: Encryption of data is not ensured in an LDEV with the Mixed encryption status. To manage data encryption, use an LDEV in which Encryption is Enabled or Disabled.</p> <p>A hyphen (-) is displayed if the pool to which the journal volume belongs is an external volume, created by migration, or blocked.</p> <ul style="list-style-type: none"> • Capacity Saving¹: Information on the capacity saving function. <ul style="list-style-type: none"> ○ Compression: The compression function is used. ○ Deduplication and Compression: The deduplication function and the compression function are used. ○ Disabled: The capacity saving function is not used. • T10 PI¹: T10 PI attribute of the volume. <ul style="list-style-type: none"> ○ Enabled: T10 PI attribute of the volume is enabled. ○ Disabled: T10 PI attribute of the volume is disabled. <p>A hyphen (-) is displayed if the emulation type is other than OPEN-V.</p> <ul style="list-style-type: none"> • Virtual storage machine¹: Virtual storage machine's model type and serial number. • Virtual LDEV ID¹: Virtual LDEV identifier of the volume. When the virtual LDEV ID is not assigned, this item is blank. • Virtual Device Name¹: Virtual device name of the volume, in the format: virtual emulation type/number of virtual LUSE volumes/virtual CVS attribute <ul style="list-style-type: none"> ○ Only attributes that are specified are displayed. ○ If the virtual CVS attribute is specified, "CVS" is displayed at the end of the device name. ○ A blank indicates no values are specified. • Virtual SSID¹: Virtual SSID of the volume. A blank indicates that no virtual SSID is specified.
Copy Type (VSP G1000, G1500, and VSP F1500)	<ul style="list-style-type: none"> • UR: Universal Replicator • URMF: Universal Replicator for Mainframe
Status	Pair status.
Remote Storage System	<p>Information about volumes in the system connected to the system you accessed.</p> <ul style="list-style-type: none"> • Model / Serial Number: Remote system's model and serial number. • LDEV ID: LDEV identifier. • Port ID: Port identifier. UR only. A hyphen (-) is displayed for URz pairs. • Host Group ID/iSCSI Target ID: Host group identifier or iSCSI target identifier when specifying an LDEV ID at pair creation. Note that this field does not change even if the remote system path settings are changed. UR only. A hyphen (-) is displayed for URz pairs. • LUN ID: LUN identifier. UR only. A hyphen (-) is displayed for URz pairs. • Journal ID: Journal's identifier. • Virtual storage machine¹: Virtual storage machine's model type and serial number. • Virtual LDEV ID¹: Virtual LDEV identifier of the volume.
Path Group ID	Path group identifier.
CTG ID ¹	Consistency group identifier.

Item	Description
Error Level ¹	The error level.
Create UR Pairs	Opens the Create UR Pairs window.
Split Pairs	Opens the Split Pairs window.
Resync Pairs	Opens the Resync Pairs window.
View Pair Synchronization Rate ²	Opens the View Pair Synchronization Rate window when the pair's primary system is accessed.
View Pair Properties ²	Opens the View Pair Properties window.
View Remote Connection Properties ²	Opens the View Remote Connection Properties window. Displays only if Pair Position is Primary.
Edit Pair Options ²	Opens the Edit Pair Options window.
Delete Pairs ²	Opens the Delete Pairs window.
Split Mirrors ²	Opens the Split Mirrors window.
Resync Mirrors ²	Opens the Resync Mirrors window.
Delete Mirrors ²	Opens the Delete Mirrors window.
Export ²	Opens the window for exporting the table information.
Notes:	
1. This item does not appear in the window by default. To display this item, change the Column Settings option for the table.	
2. This item is displayed when you select More Actions.	

Mirrors tab

UR / URz only. Only the mirrors to which all volumes are allocated for each user are displayed.

The screenshot displays the 'Remote Replication' window with the 'Mirrors' tab selected. At the top, it shows 'Storage(S/N:30180) > Replication > Remote Replication' and 'Last Updated: 2014/10/21 15:09'. Below this is a summary table:

Number of Pairs		Number of Mirrors	
TrueCopy	0	Open	8
TrueCopy for Mainframe	0	Mainframe	0
Universal Replicator	0	Total	8
Universal Replicator for Mainframe	0		
Global-Active Device	13		
Total	13		

Below the summary table are tabs for 'TC Pairs', 'UR Pairs', 'Mirrors', 'GAD Pairs', and 'GAD Consistency Groups'. The 'Mirrors' tab is active, showing a table with the following columns: Journal ID, Mirror ID, Journal Type, Attribute, Status, Remote Storage System (Model / Serial Number, Journal ID), Path Group ID, Number of Data VOLS, Data Capacity, and Remote Device. The table contains 8 rows of data, with the first two rows selected.

Journal ID	Mirror ID	Journal Type	Attribute	Status	Remote Storage System	Path Group ID	Number of Data VOLS	Data Capacity	Remote Device
000	0	UR	Master	Active / ...	VSP G1000 / 30110	000	64	512.06 GB	-
000	1	UR	Initial	Initial / ...	-	-	0	0.00 GB	-
000	2	UR	Initial	Initial / ...	-	-	0	0.00 GB	-
000	3	UR	Initial	Initial / ...	-	-	0	0.00 GB	-
001	0	UR	Master	Active / ...	VSP G1000 / 30110	001	64	512.06 GB	-
001	1	UR	Initial	Initial / ...	-	-	0	0.00 GB	-
001	2	UR	Initial	Initial / ...	-	-	0	0.00 GB	-
001	3	UR	Initial	Initial / ...	-	-	0	0.00 GB	-

Item	Description
Journal ID	Journal identifier. Clicking opens the Journal Volumes window.
Mirror ID	Mirror identifier.
Journal Type (VSP G1000, G1500, and VSP F1500)	The journal's copy type and journal type option are displayed. If the journal type is standard, only the copy type is displayed.
Attribute	Whether the journal is Master, Restore, or Initial-registered but with no pair volumes assigned to it.
Status	Mirror status. For mirror descriptions, see <i>Hitachi Universal Replicator User Guide</i> .
Remote Storage System	<ul style="list-style-type: none"> • Model / Serial Number: Remote system model and serial number. • Journal ID: Remote system journal identifier
Path Group ID	Path group identifier.
Number of Data VOLs	Number of volumes associated with the mirror.
Data Capacity	Total capacity of all the associated volumes.
Remote Command Device	LDEV ID of the remote command device if it is assigned to the mirror. <ul style="list-style-type: none"> • The column is blank if the remote command device is not assigned to the mirror. • A hyphen (-) indicates the remote command device cannot be assigned to the mirror.
CTG ID ¹	Displays the consistency group ID.
CTG Utilization ¹	Whether the consistency group is shared by multiple storage systems. <ul style="list-style-type: none"> • Single: The consistency group consists of a single pair of primary and secondary storage systems. • Multi: The consistency group consists of multiple storage systems.
EXCTG Setting ¹ (VSP G1000, G1500, and VSP F1500)	Displays the EXCTG ID and Super DKC (device name and serial number) if the journal belongs to the EXCTG. A hyphen (-) is displayed when no journal is registered in the EXCTG.
Path Watch Time ¹	Displays the path watch time.
Path Watch Time Transfer ¹	Specifies whether to forward the Path Watch Time value of the master journal to the secondary mirror. If the Path Watch Time value is forwarded from the master journal to the secondary mirror, both the primary and secondary mirrors will have the same Path Watch Time value. <ul style="list-style-type: none"> • Yes: The Path Watch Time value will be forwarded to the secondary mirror. • No: The Path Watch Time value will not be forwarded to the secondary mirror.
Copy Pace ¹	Indicates the speed of initial copy of a volume. Slower, Medium, or Faster is displayed. A hyphen is displayed if the journal is a restore journal.
Transfer Speed ¹	Specifies the transfer speed (in Mbps (megabits per second)). Specify one of the following: 256, 100, 10, or 3.

Item	Description
Delta Resync Failure ¹	Indicates the processing that must be performed if delta resync cannot be performed. <ul style="list-style-type: none"> Entire Copy: Copies all data in the primary volume to the secondary volume if delta resync cannot be performed. No Copy: Does not perform any processing if delta resync cannot be performed. Does not update the secondary volume.
Split Mirrors	Opens the Split Mirrors window.
Resync Mirrors	Opens the Resync Mirrors window.
Create UR Pairs	Opens the Create UR Pairs window.
Edit Mirror Options ²	Opens the Edit Mirror Options window.
View Remote Connection Properties ²	Opens the View Remote Connection Properties window when the value for Attribute is "Master".
Delete Mirrors ²	Opens the Delete Mirrors window.
Assign Remote Command Devices ²	Opens the Assign Remote Command Devices window.
Release Remote Command Devices ²	Opens the Release Remote Command Devices window.
Export ²	Opens the window for exporting the table information.
Notes:	
<ol style="list-style-type: none"> This item does not appear in the window by default. To display this item, change the Column Settings option for the table. This item is displayed when you select More Actions. 	

GAD Pairs tab

Only the pairs to which the volumes of the local storage system are allocated for each user are displayed.

LDEV ID	LDEV Name	Port ID	Host Group Name / ISCSI Target Alias	ISCSI Target Name	LUN ID	Pair Position	Provisioning Type	Capacity	CLPR	Encryption	I/
00:10:A0		CL1-B	1B-G00 (00)	-	32	Primary	DP	2.00 GB	0:CLPRO	Disabled	Mi
00:10:A1		CL1-B	1B-G00 (00)	-	33	Primary	DP	2.00 GB	0:CLPRO	Disabled	Mi
00:10:A3		CL1-B	1B-G00 (00)	-	35	Secondary	DP	2.00 GB	0:CLPRO	Disabled	Mi

Item	Description
Local Storage System	<p>Information about volumes in the Local Storage System.</p> <ul style="list-style-type: none"> • LDEV ID: LDEV identifier. Click to open the LDEV Properties window. • LDEV Name: LDEV name. • Port ID: Port identifier. • Host Group Name/iSCSI Target Alias: Host group name or iSCSI target alias. • iSCSI Target Name: iSCSI target name of the volume. • LUN ID: LUN identifier. • Pair Position: Whether the volume is a primary or secondary volume. • (VSP Gx00 models and VSP Fx00 models) Attribute¹: Volume's LDEV attribute. • Provisioning Type¹: Provisioning type of the volume. • Capacity¹: Capacity of the volume. • CLPR¹: CLPR ID of the volume. • Encryption¹: Encryption information. <ul style="list-style-type: none"> ○ Enabled: Encryption of the parity group to which the LDEV belongs is enabled, or a V-VOL is associated with a pool in which a pool volume has encryption enabled. ○ Disabled: Encryption of the parity group to which the LDEV belongs is disabled, or a V-VOL is associated with a pool in which a pool volume has encryption disabled. ○ Mixed: The pool to which the LDEV belongs contains two or more of the following: <ul style="list-style-type: none"> – Volume for which encryption is enabled – Volume for which encryption is disabled – External volume <p>Note: Encryption of data is not ensured in an LDEV with the Mixed encryption status. To manage data encryption, use an LDEV in which Encryption is Enabled or Disabled.</p> <p>For an external volume or migration volume, a hyphen (-) is displayed. For DP-VOLs, the pool to which the LDEV belongs is an external volume or blocked.</p> <ul style="list-style-type: none"> • I/O Mode: I/O Mode of the volume. • ALUA Mode: Information about the ALUA mode. • Capacity Saving¹: Information on the capacity saving function. <ul style="list-style-type: none"> ○ Compression: The compression function is used. ○ Deduplication and Compression: The deduplication function and the compression function are used. ○ Disabled: The capacity saving function is not used. • T10 PI¹: T10 PI attribute of the volume. <ul style="list-style-type: none"> ○ Enabled: T10 PI attribute of the volume is enabled. ○ Disabled: T10 PI attribute of the volume is disabled.
Status	Pair status.
Failure Factor ¹	<p>Failure Factor.</p> <p>To check the failure factors, see the Failure Factors on page 443 for more details.</p>
Remote Storage System	<p>Information about volumes in the Remote Storage System.</p> <ul style="list-style-type: none"> • Model / Serial Number: Remote system's model and serial number. • LDEV ID: LDEV identifier.

Item	Description
	<ul style="list-style-type: none"> • Port ID: Port ID when specifying an LDEV ID at pair creation. Note that this field does not change if the remote system path settings are changed. • Host Group ID/iSCSI Target ID: Host group identifier or iSCSI target ID when specifying an LDEV ID at pair creation. Note that this field does not change even if the remote system path settings are changed. • LUN ID: LUN identifier when specifying an LDEV ID at pair creation. Note that this field does not change even if the remote system path settings are changed.
Path Group ID	Path group identifier.
Mirror ID	Mirror identifier.
Quorum Disk ID	Quorum Disk identifier.
CTG ID	Consistency group identifier.
Pair Operating Mode When Quorum Disk Blocked	<p>Displays the pair operating mode when the quorum disk is blocked.</p> <ul style="list-style-type: none"> • Pair Retained (both Primary and Secondary Accessible): The server can access both the P-VOL and the S-VOL. • Pair Retained (Primary Accessible and Secondary Inaccessible): The server can access the P-VOL. The data written to the P-VOL is written to the S-VOL. • Pair Suspension: The server can access the P-VOL. The data written to the P-VOL is not written to the S-VOL.
Virtual Storage Machine	<p>Information about the LDEV's virtual storage machine.</p> <ul style="list-style-type: none"> • Model type/Serial number: Model type and serial number. • LDEV ID: Virtual LDEV identifier of the volume. • Device Name: Virtual device name of the volume, in the format: virtual emulation type/number of virtual LUSE volumes/virtual CVS attribute. <ul style="list-style-type: none"> ○ Only attributes that are specified are displayed. ○ If the virtual CVS attribute is specified, "CVS" is displayed at the end of the device name. ○ A blank indicates no values are specified. • SSID: Virtual SSID of the volume. A blank indicates that no virtual SSID is specified.
Create GAD Pairs	Opens the Create GAD Pairs window.
Suspend Pairs	Opens the Suspend Pairs window.
Resync Pairs	Opens the Resync Pairs window.
View Pair Synchronization Rate ²	Opens the View Pair Synchronization Rate window when the pair's primary system is accessed.
View Pair Properties ²	Opens the View Pair Properties window.
View Remote Connection Properties ²	Opens the View Remote Connection Properties window.
Delete Pairs ²	Opens the Delete Pairs window.
Export ²	Opens the window for exporting the table information.
<p>Notes:</p> <ol style="list-style-type: none"> 1. This item does not appear in the window by default. To display this item, change the Column Settings option for the table. 2. This item is displayed when you select More Actions. 	

GAD Consistency Groups tab

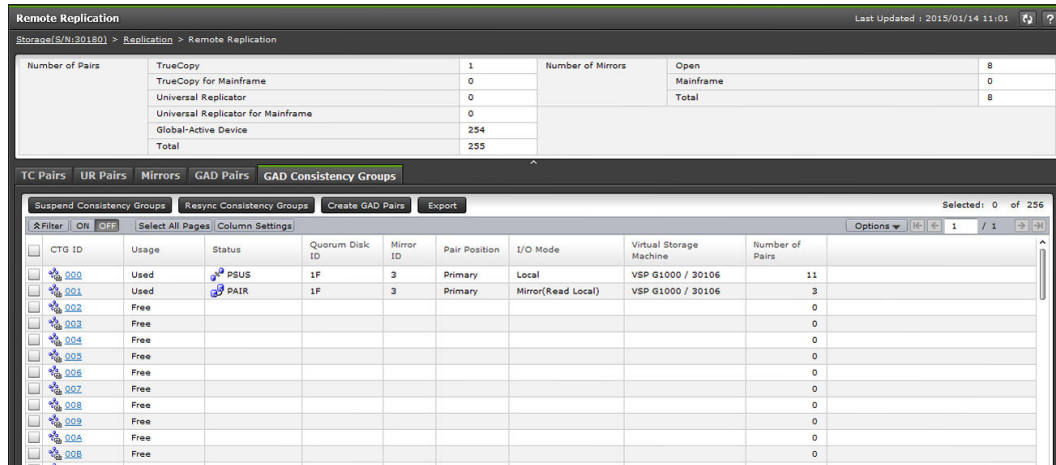

Item	Description
CTG ID	Consistency group identifier.
Usage	Displays whether a consistency group is used. <ul style="list-style-type: none"> Used Free
Status	Consistency group status. See the <i>Global-Active Device User Guide</i> for status descriptions.
Quorum Disk ID	Quorum Disk identifier.
Mirror ID	Mirror identifier.
Pair Position	Displays whether the GAD pair volume registered to the consistency group is a primary or secondary volume.
I/O Mode	Displays the I/O mode of the GAD pair that is registered to the consistency group.
Virtual Storage Machine	Displays the model type/serial number of the virtual storage machine.
Number of Pairs	Number of pairs registered to the consistency group.
Suspend Consistency Groups	Opens the Suspend Consistency Groups window.
Resync Consistency Groups	Opens the Resync Consistency Groups window.
Create GAD Pairs	Opens the Create GAD Pairs window.
Export	Opens the window for exporting the table information.

Failure Factors

The following table shows failure factors displayed in the Failure Factor column and their meanings.

Failure Factor	Meanings
Local Volume Failure	A failure is detected on a volume in the local storage system.
Remote Path Failure	A failure is detected on the remote path.
Quorum Disk Failure	A failure is detected on the quorum disk.
Internal Error	An internal error is detected.
Not Failure	No failure is detected. The pair is suspended when the local storage system is turned on.
Remote Volume Failure	A failure is detected on a volume in the remote storage system.
Remote Side Unidentified Failure	A failure due to an unidentified factor is detected on a volume in the remote storage system.
blank cell	No failure is detected.

Remote Connections window

Use this window to view information about remote connections and paths, and add additional remote connections and paths.

In this topic you can review the following tables:

- [Remote connections window on page 444](#)
- [Connections \(To\) tab on page 445](#)
- [Connections \(From\) tab on page 446](#)
- [Quorum Disks tab on page 447](#)

Remote connections window

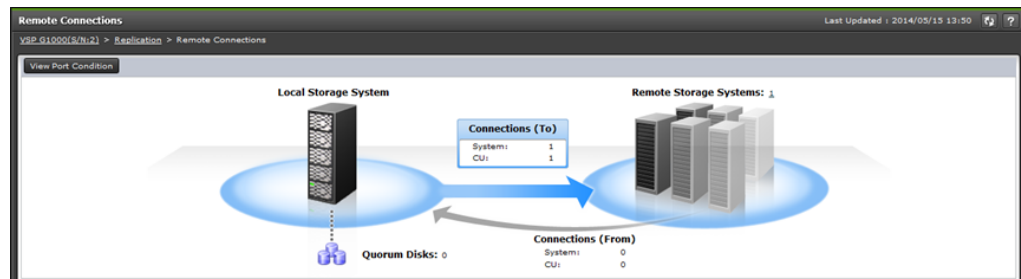

Item	Description
View Port Condition	Opens the View Port Condition window.
Connections (To)	<ul style="list-style-type: none"> • System: Number of system-to-system connections from local to remote system. • (VSP G1000, G1500, and VSP F1500) CU: Number of CU-to-CU connections from local to remote system.

Item	Description
Remote Storage System	Number of remote systems connected to the local system.
Connections (From)	<ul style="list-style-type: none"> System: Number of system-to-system connections from remote to local system. (VSP G1000, G1500, and VSP F1500) CU: Number of CU-to-CU connections from remote to local system. <p>Only the number of remote connections used for TC/TCz pairs is displayed as the number of connections.</p>
Quorum Disks	The number of quorum disks.
View Port Location	Opens the View Port Location window.

Connections (To) tab

Connection Type	Local CU	Remote Storage System	Path Group ID	Status	Number of Remote Paths
		Model / Serial Number	CU	SSID	
System	-	VSP G1000 / 00020	-	00	1
CU	20	VSP G1000 / 00020	00	0820	1

Use this tab to view information about the remote system.

Item	Description
Connection Type (VSP G1000, G1500, and VSP F1500)	<ul style="list-style-type: none"> System: system-to-system connection (local to remote). CU: CU-to-CU connections (local to remote).
Local CU (VSP G1000, G1500, and VSP F1500)	Local system CU number.
Remote Storage System	<ul style="list-style-type: none"> (VSP Gx00 models and VSP Fx00 models) Model and serial number. (VSP G1000, G1500, and VSP F1500) Model / Serial Number: Model and serial number. (VSP G1000, G1500, and VSP F1500) CU: Remote Storage System's CU number. (VSP G1000, G1500, and VSP F1500) SSID: Remote Storage System's SSID number.
Path Group ID	Path group identifier.
Status	<p>Remote connection status.</p> <ul style="list-style-type: none"> Normal: All remote paths are normal. Failed: All remote paths are abnormal. Warning: Some remote paths are abnormal.

Item	Description
Number of Remote Paths	Number of remote paths.
Minimum Number of Paths ¹	The specified minimum number of paths.
RIO MIH Time (sec.) ¹	The specified RIO MIH time in seconds.
Roundtrip Time (msec.) ¹	The specified roundtrip time in milliseconds.
FREEZE Option ¹ (VSP G1000, G1500, and VSP F1500)	The specified the FREEZE option.
Add Remote Connection	Opens the Add Remote Connection window.
Edit Remote Connection Options	Opens the Edit Remote Connection Options window.
View Remote Connection Properties	Opens the View Remote Connection Properties window.
Add Remote Paths ²	Opens the Add Remote Paths window.
Remove Remote Paths ²	Opens the Remove Remote Paths window.
Add SSIDs ² (VSP G1000, G1500, and VSP F1500)	Opens the Add SSIDs window.
Delete SSIDs ² (VSP G1000, G1500, and VSP F1500)	Opens the Delete SSIDs window.
Remove Remote Connections ²	Opens the Remove Remote Connections window.
Export ²	Opens the window for exporting the table information.
Notes:	
<ol style="list-style-type: none"> This item does not appear in the window by default. To display this item, change the Column Settings option for the table. This item is displayed when More Actions is clicked. 	

Connections (From) tab

Use this tab to view information about the remote storage system. This information is displayed only when remote connections are used for TC and TCz pairs.

Connection Type	Local CU	Remote Storage System			Path Group ID
		Model / Serial Number	CU	SSID	

Item	Description
Connection Type (VSP G1000, G1500, and VSP F1500)	<ul style="list-style-type: none"> System: system-to-system connection from remote to local. CU: CU-to-CU connections from remote to local.











Item	Description
Local CU (VSP G1000, G1500, and VSP F1500)	Local system CU number.
Remote Storage System	<ul style="list-style-type: none"> (VSP Gx00 models and VSP Fx00 models) Model and serial number. (VSP G1000, G1500, and VSP F1500) Model / Serial Number: Model and serial number. (VSP G1000, G1500, and VSP F1500) CU: CU number. (VSP G1000, G1500, and VSP F1500) SSID: SSID number.
Path Group ID	Path group identifier.
Export	Opens the window for exporting the table information.

Quorum Disks tab

Use this tab to view information about quorum disks allocated to users.

Quorum Disk ID	LDEV ID	LDEV Name	Status	CLPR	Capacity	Remote Storage System	Read Response Guaranteed Time When Quorum Disk Blocked (sec)
00	00:00:56	QuorumDisk	Normal	0:CLPR0	20.00 GB	VSP G1000 / 00001	40
01	00:00:55	QuorumDisk	Normal	0:CLPR0	20.00 GB	VSP G1000 / 00001	40
02	00:00:54	QuorumDisk	Normal	0:CLPR0	20.00 GB	VSP G1000 / 00001	40
03	00:00:53	QuorumDisk	Normal	0:CLPR0	20.00 GB	VSP G1000 / 00001	40
04	00:00:52	QuorumDisk	Normal	0:CLPR0	20.00 GB	VSP G1000 / 00001	40
05	00:00:51	QuorumDisk	Normal	0:CLPR0	20.00 GB	VSP G1000 / 00001	40
06	00:00:50	QuorumDisk	Normal	0:CLPR0	20.00 GB	VSP G1000 / 00001	40
07	00:00:4F	QuorumDisk	Normal	0:CLPR0	20.00 GB	VSP G1000 / 00001	40
08	00:00:4E	QuorumDisk	Normal	0:CLPR0	20.00 GB	VSP G1000 / 00001	40
09	00:00:4C	QuorumDisk	Normal	0:CLPR0	20.00 GB	VSP G1000 / 00001	40
0A	00:00:4D	QuorumDisk	Normal	0:CLPR0	20.00 GB	VSP G1000 / 00001	40
0B	00:00:4B	QuorumDisk	Normal	0:CLPR0	20.00 GB	VSP G1000 / 00001	40

Item	Description
Quorum Disk ID	Quorum disk identifier.
Quorum Disk	<p>Below is some information about quorum disks.</p> <ul style="list-style-type: none"> LDEV ID: Virtual LDEV identifier of the volume. Click to open the LDEV Properties window. LDEV Name: LDEV Name of the volume.

Item	Description
	<ul style="list-style-type: none"> • Status: Displays the status of the volume: <ul style="list-style-type: none"> ○  Normal: Volume is in normal status. ○  Blocked: Volume is blocked. Access cannot be made from the host. ○  Warning: Volume has a problem. ○  Formatting: Volume is being formatted. ○  Preparing Quick Format: Preparation for quick formatting is in progress. ○  Quick Formatting: Volume is under quick formatting. ○  Correction Access: Access attribute is being corrected. ○  Copying: Volume data is being copied. ○  Read Only: Volume is in Read Only status. Data cannot be written. ○  Shredding: Volume is being shredded. ○  - : Volume is in a status other than the above. • CLPR: CLPR ID of the volume. • Capacity: Capacity of the volume.
Remote Storage System	Model/Serial number of Remote Storage System.
Read Response Guaranteed Time When Quorum Disk Blocked (sec)	Displays the time elapses until the S-VOL pair status changes to PSUE (Block), if a remote path disconnection is detected after a quorum disk is blocked.
Add Quorum Disk	Opens the window to add quorum disks.
Remove Quorum Disk	Opens the window to remove quorum disks.
Edit Quorum Disks	Opens the window to edit quorum disks.
Export	Opens the window to export the table information.

View Remote Connection Properties window

Use this window to view information about remote connections and paths.

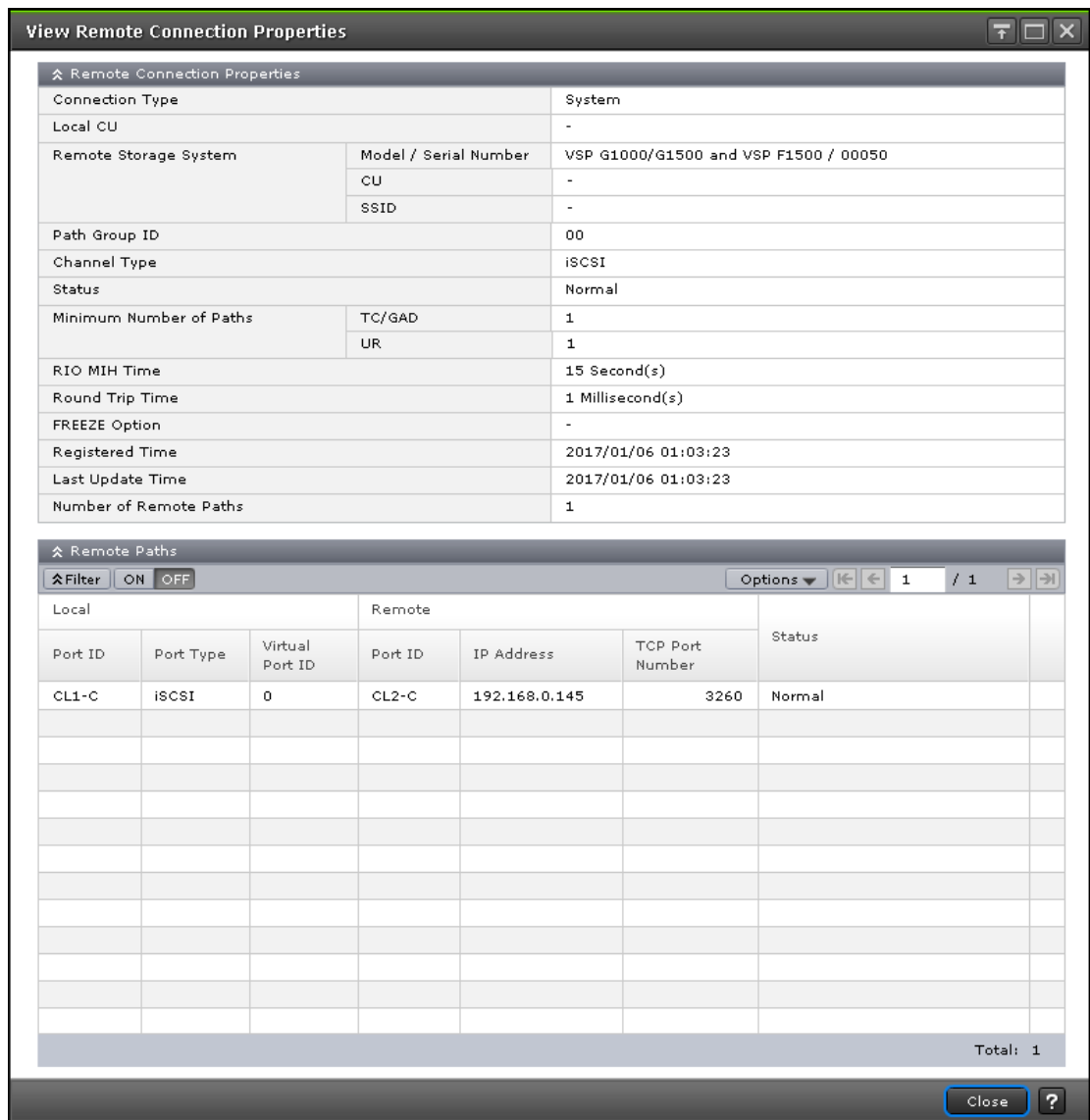

In this topic, you can view the following tables.

- [Remote Connection Properties table on page 449](#)
- [Remote Paths table on page 450](#)

Remote Connection Properties table

Item	Description
Connection Type (VSP G1000, G1500, and VSP F1500)	<ul style="list-style-type: none"> • System: system-to-system connection. • CU: CU-to-CU connections.
Local CU (VSP G1000, G1500, and VSP F1500)	Local system CU number.

Item	Description
Remote Storage System	<ul style="list-style-type: none"> (VSP Gx00 models and VSP Fx00 models) Model and serial number. (VSP G1000, G1500, and VSP F1500) Model / Serial Number: Model and serial number. (VSP G1000, G1500, and VSP F1500) CU: CU number. (VSP G1000, G1500, and VSP F1500) SSID: SSID.
Path Group ID	Path group identifier.
Channel Type	<p>Displays the channel type or type of data path.</p> <ul style="list-style-type: none"> Fibre: Local port type of all remote paths in the remote connection is Fibre. (VSP G1000, G1500, and VSP F1500) FCoE: Local port type of all remote paths in the remote connection is FCoE. iSCSI: Local port type of all remote paths in the remote connection is iSCSI. Mixed: Local port type of at least two remote paths in the remote connection is not the same.
Status	<p>Remote connection status.</p> <ul style="list-style-type: none"> Normal: All remote path within remote connection are fine. Failed: All remote path within remote connection has problem. Warning: Some remote path within remote connection has problem.
Minimum Number of Paths	The specified minimum number of remote paths.
RIO MIH Time	The specified RIO MIH time in seconds.
Roundtrip Time	The specified roundtrip time in milliseconds.
FREEZE Option (VSP G1000, G1500, and VSP F1500)	Whether the FREEZE option is enabled or disabled.
Registered Time	Date and time the connection was established.
Last Update Date	Date and time of the last update.
Number of Remote Paths	Number of paths specified in the remote connection.

Remote Paths table

Item	Description
Local	<p>Information about ports on local storage systems.</p> <ul style="list-style-type: none"> Port ID: Port identifier Port Type: Port type (Fibre, iSCSI, or (VSP G1000, G1500, and VSP F1500) FCoE) Virtual Port ID: Virtual port ID. Displayed when the port type is iSCSI.
Remote	<p>Information about ports on remote storage systems.</p> <ul style="list-style-type: none"> Port ID: Port identifier IP Address: IP address of the port. Displayed when the port type is iSCSI. TCP Port Number: TCP port number of the port. Displayed when the port type is iSCSI.
Status	Remote path status.

History window

Use this window to review the operations that have been performed on a pair.

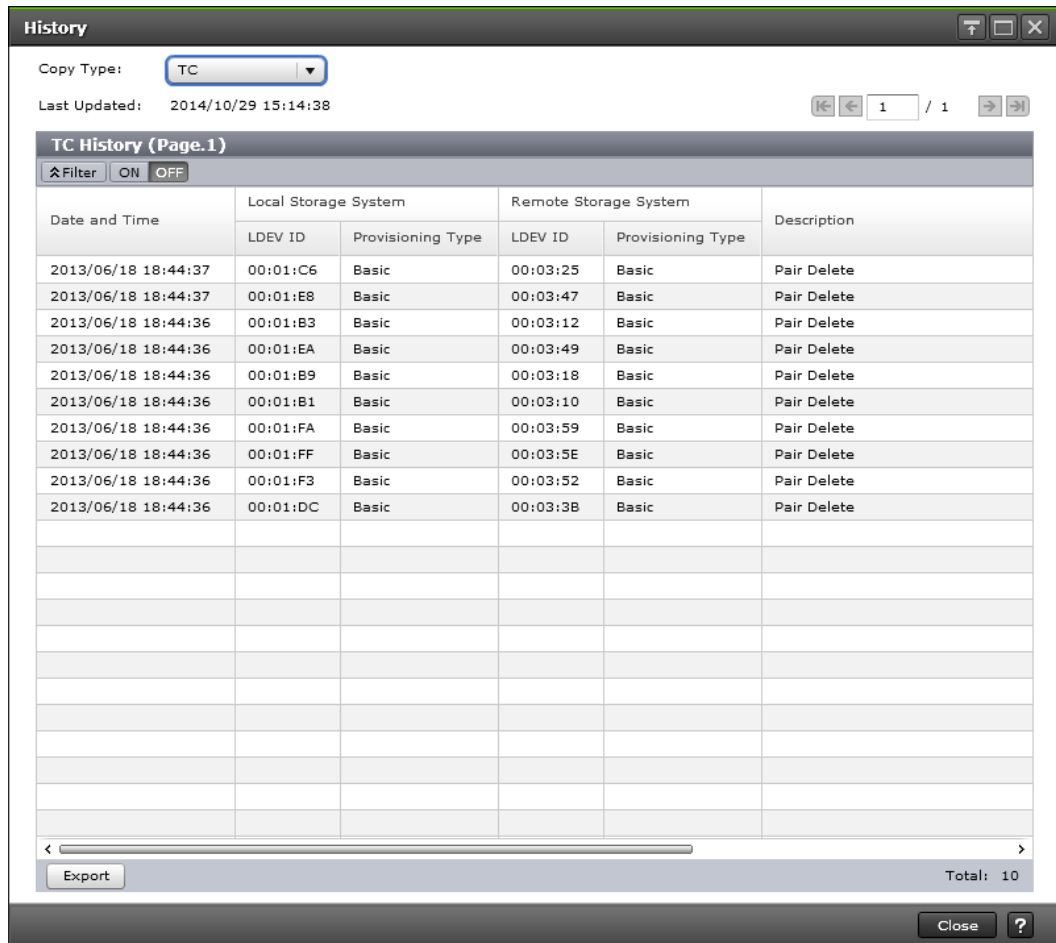

In this topic, you can view the following tables.

- [Settings on page 451](#)
- [History table \(when Copy Type is TC or TCMF\) on page 452](#)

Settings

Item	Description
Copy Type	Type of pair: <ul style="list-style-type: none"> • TC: TrueCopy • UR: Universal Replicator • (VSP G1000, G1500, and VSP F1500) TCMF: TrueCopy for Mainframe

Item	Description
	<ul style="list-style-type: none"> (VSP G1000, G1500, and VSP F1500) URMF: Universal Replicator for Mainframe GAD: global-active device
Last Updated (VSP G1000, G1500, and VSP F1500)	Date and time of the last update. Displayed after Copy Type is specified.
Page Number (VSP G1000, G1500, and VSP F1500)	Page number. Click the button, turn over the page. Displayed after Copy Type is specified.

History table (when Copy Type is TC or TCMF)

Item	Description
Date and Time	Date and time of the operation.
Local Storage System	Information about volumes in the accessed system. <ul style="list-style-type: none"> LDEV ID: LDEV identifier. Provisioning Type: Provisioning type of the volume. Pair Position: Whether the volume is a primary or secondary volume. GAD only. Journal ID: Journal's identifier. UR or URz only. Mirror ID: Mirror's identifier. UR or URz only.
Remote Storage System	Information about volumes in the system connected to the system you accessed. <ul style="list-style-type: none"> LDEV ID: LDEV identifier. Model / Serial Number: Remote storage system's model and serial number. GAD only. Provisioning Type: Provisioning type of the volume.
EXCTG ID (VSP G1000, G1500, and VSP F1500)	EXCTG identifier. URz only.
Mirror ID	Mirror identifier. GAD only.
Quorum Disk ID	Quorum disk identifier. GAD only.
CTG ID (VSP G1000, G1500, and VSP F1500)	Consistency group identifier. GAD only.
Virtual Storage Machine	Information about volumes in the virtual storage machine. GAD only. <ul style="list-style-type: none"> Model / Serial Number: Virtual storage system's model and serial number. LDEV ID: LDEV identifier of the volume.
Description Code	Description code. GAD only.
Description	Describes the operation.
Copy Time	Elapsed time for create or resync pairs operation. When the Description is other than Pair Add Complete or Pair Resync Complete, a hyphen is displayed.
Started	Start time of create or resync pairs operation. When the Description is other than Pair Add Complete or Pair Resync Complete, a hyphen is displayed.
Export	Opens the window for exporting table information.

Add Remote Connection window

Use this window to connect storage systems for remote replication.

For complete UR or URz information, see the section on configuring primary and secondary systems in the *Hitachi Universal Replicator User Guide* or *Hitachi Universal Replicator for Mainframe User Guide*.

When Select Type is Fibre:

The screenshot shows the 'Add Remote Connection' wizard window. The title bar reads 'Add Remote Connection' and the progress bar shows '1. Add Remote Connection' and '2. Confirm'. Below the progress bar, a message states: 'This wizard lets you add a remote connection. Enter the remote connection settings. Click the items of Options to set the details of remote connection. Click Finish to confirm.'

The 'Connection Type' is set to 'System' (selected) and 'CU'. The window is divided into three main sections:

- Local Storage System:** Model: VSP F1500, Serial Number: 10057, Local CU: (-).
- Remote Storage System:** Model: VSP G1000/G1500 and VSP F1500 (7) (5-255), Serial Number: (1-99999), Remote CU: (-), SSID: (-). There is a '+ Add SSID' button.
- Remote Paths:** Path Group ID: 00, Minimum Number of Paths: 1 (Fixed 1 on UR/URMF). The 'Select Type' is set to 'Fibre' (selected) and 'iSCSI'. There are two 'Port ID' fields, each with a dropdown menu and a '-' button. There is a '+ Add Path' button.

At the bottom left, there is an 'Options' button. At the bottom right, there are 'Back', 'Next', 'Finish', and 'Cancel' buttons, along with a help icon.

When Select Type is iSCSI:

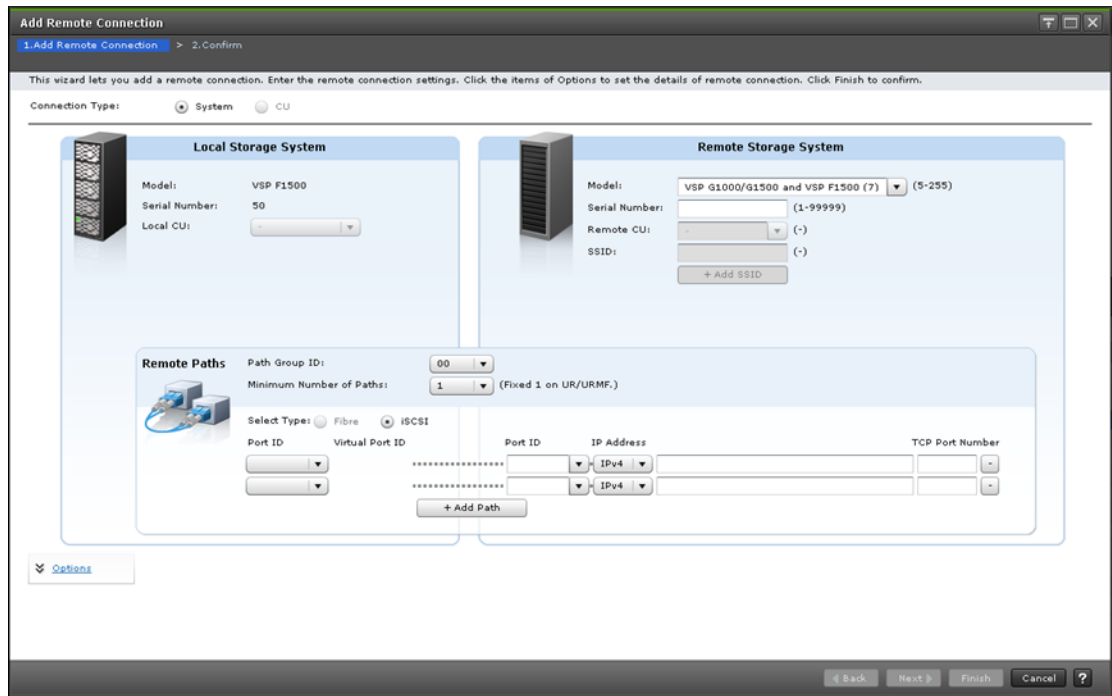

Item	Description
Connection Type (VSP G1000, G1500, and VSP F1500)	<ul style="list-style-type: none"> System: system-to-system connection. TC/UR/URz/GAD. CU: CU-to-CU connections. TCz only. By default, System is selected.

Local Storage System

Item	Description
Model	Local model.
Serial Number	Local serial number.
Local CU (VSP G1000, G1500, and VSP F1500)	Local system CU number (00 to FE), displayed when Connection Type is CU. A hyphen (-) is displayed when Connection Type is System.

Remote Storage System

Item	Description
Model	Remote system's model. <ul style="list-style-type: none"> VSP G1000 and G1500, and VSP F1500 (7) VSP (6) USP V/USP VM (5) HUS VM (19) VSP Gx00 models and VSP Fx00 models (18)

Item	Description
	<p>Specify the same value for VSP Gx00 models and VSP Fx00 models.</p> <p>HUS VM (19) and VSP Gx00 models and VSP Fx00 models (18) can be selected only when System is selected for Connection Type.</p> <p>If a value other than the above is specified, it is regarded as a storage system that will be supported in the future. In this case, in the Remote Connections window, the specified value will be enclosed by parentheses, such as (255), is displayed.</p>
Serial Number	<p>Last five or six digits of the remote system serial number, as follows:</p> <ul style="list-style-type: none"> • VSP G1000 and G1500, and VSP F1500: 1 to 99999 (5 digits) • VSP or USP V/VM: 1 to 99999 (5 digits) • HUS VM: 200001 to 265535 (6 digits) (TC/UR only) • VSP Gx00 models and VSP Fx00 models: 400001 to 499999 (6 digits) • Future storage systems: 0 to 99999 <p>(VSP Gx00 models and VSP Fx00 models) Note: When using virtual storage machine volumes, specify the serial number of the storage system. Do not specify the serial number of the virtual storage machine.</p>
Remote CU (VSP G1000, G1500, and VSP F1500)	Remote system CU number, displayed when Connection Type is CU.
SSID (VSP G1000, G1500, and VSP F1500)	Remote system SSID in hexadecimal (0004 to FFFE). Can be selected when Connection Type is CU. If there are two or more SSID numbers, clicking the minus (-) button deletes the SSID text box.
Add SSIDs (VSP G1000, G1500, and VSP F1500)	Clicking adds the SSID to the remote system. The maximum is four. This button is not displayed if four SSID numbers are already added.

Remote Paths

Item	Description
Path Group ID	Path group identifier (00 to FF). Up to 64 path group IDs can be registered per storage system. Path group IDs can be selected when Connection Type is System.
Minimum Number of Paths	<p>Minimum number of remote paths.</p> <ul style="list-style-type: none"> • TC and TCz: The range is from 1 to 8, and the default is 1. • UR and URz: The minimum number is set to 1, regardless of the number entered.
Select Type	<p>Select the port type.</p> <ul style="list-style-type: none"> • Fibre: Fibre Channel port • iSCSI: iSCSI port
Port ID (for local storage systems)	Select the port identifier of the local storage system.
Virtual Port ID (for local storage systems)	Virtual port ID of the local storage system. Displayed when iSCSI is selected as the port type.

Item	Description
Port ID (for remote storage systems)	Select the port identifier of a remote storage system. A hyphen (-) is displayed if the number of valid paths is greater than the minimum number of paths. Clicking the hyphen deletes the text box of the port for the local and remote storage systems.
IP address	Select the IP type (IPv4 or IPv6) for the port of the remote storage system to enter the IP address. Displayed only when iSCSI is selected as the port type.
TCP Port Number	Enter the TCP port number of the remote storage system. Displayed only when iSCSI is selected as the port type.
Add Paths	Opens a dialog box for creating additional paths (maximum of eight).

Options

Item	Description
RIO MIH Time	Time limit between 10 and 100 seconds for the data-transfer operation to complete (15 is the default).
Roundtrip Time (msec.)	TC, TCz and GAD only. Time limit between 1 and 500 milliseconds for data copy from P-VOL to S-VOL (1 is the default).
FREEZE Option (Mainframe systems)	Enables or disables support for the CGROUP (FREEZE/RUN) PPRC TSO command. Can be selected when Connection Type is CU.

Add Remote Connection confirmation window

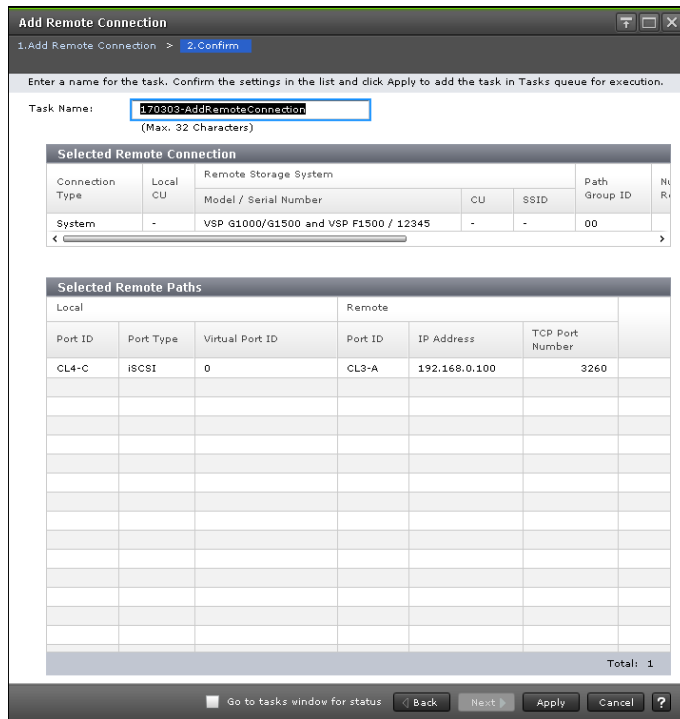

In this topic, you can view the following tables.

- [Selected Remote Connection table on page 457](#)
- [Selected Remote Paths table on page 458](#)

Selected Remote Connection table

Item	Description
Connection Type (VSP G1000, G1500, and VSP F1500)	System or CU.
Local CU (VSP G1000, G1500, and VSP F1500)	TCz only. Specified local system CU number, displayed when Connection Type is CU.
Remote Storage System	<ul style="list-style-type: none"> • (VSP Gx00 models and VSP Fx00 models) Model and serial number. • (VSP G1000, G1500, and VSP F1500) Model / Serial Number: Model and serial number. • (VSP G1000, G1500, and VSP F1500) CU: CU number. • (VSP G1000, G1500, and VSP F1500) SSID: SSID.
Path Group ID	Specified path group identifier.
Number of Remote Paths	Specified number of remote paths.
Minimum Number of Paths	Specified minimum number of remote paths.
RIO MIH Time (sec.)	Specified RIO MIH time.
Roundtrip Time (msec.)	Specified roundtrip time.

Item	Description
FREEZE Option (VSP G1000, G1500, and VSP F1500)	Specified FREEZE option.

Selected Remote Paths table

Item	Description
Local	Information about ports on the local storage system. <ul style="list-style-type: none"> Port ID: Port identifier Port Type: Port type can be Fibre, iSCSI, or (VSP G1000, G1500, and VSP F1500)FCoE Virtual Port ID: Virtual port ID. Displayed when the port type is iSCSI.
Remote	Information about ports on the remote storage system. <ul style="list-style-type: none"> Port ID: Port identifier IP Address (displayed only when the port type is iSCSI) TCP Port Number (displayed only when the port type is iSCSI)

Edit Remote Replica Options window

Use this window to change options that affect the replication system.

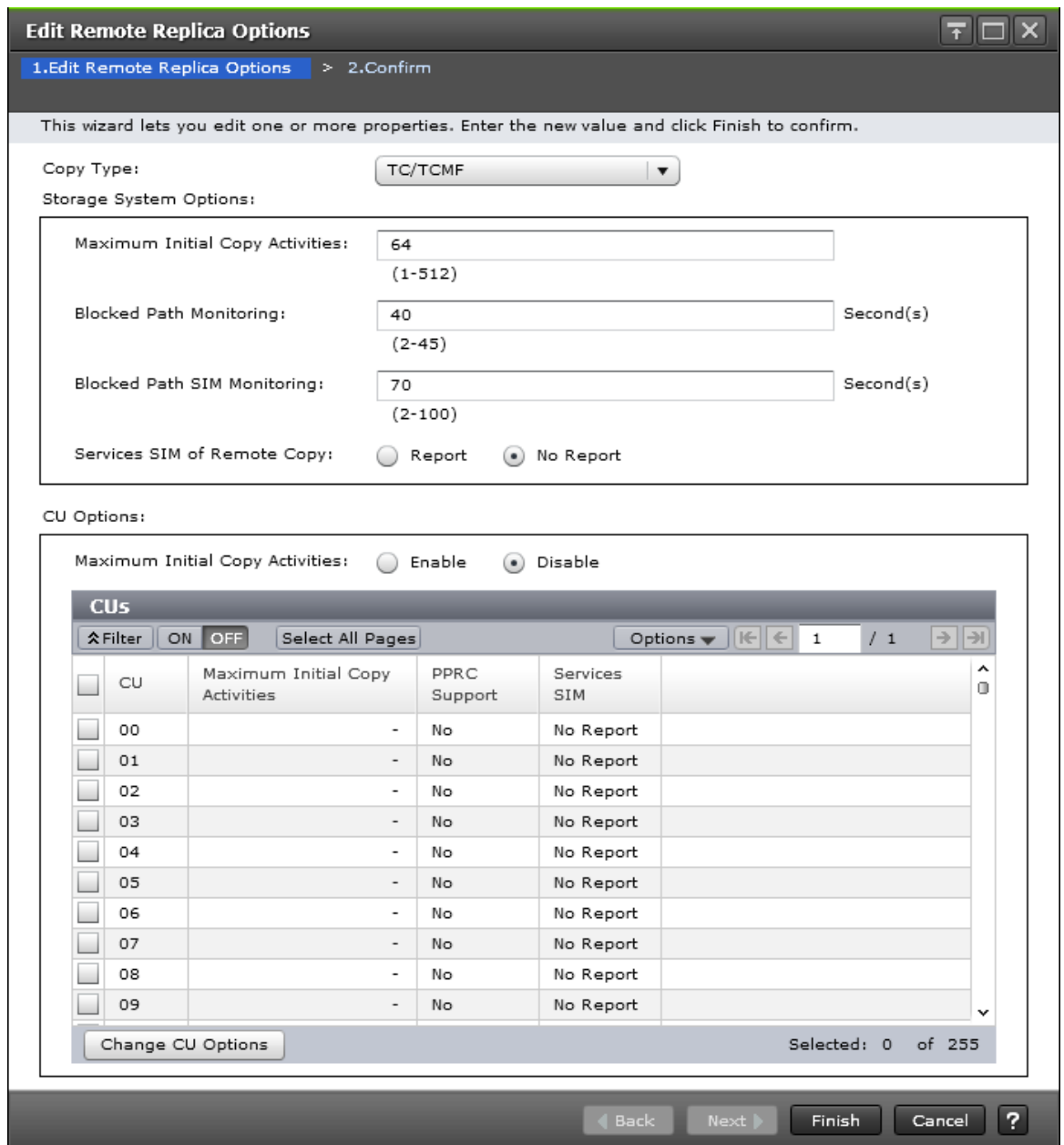

In this topic, you can view the following tables.

- [Setting Fields on page 459](#)
- [Storage System Options on page 460](#)
- [CU Options on page 460](#)

Setting Fields

Item	Description
Copy Type	Type of pair:

Item	Description
	<ul style="list-style-type: none"> (VSP G1000, G1500, and VSP F1500) TC/TCMF: TrueCopy or TrueCopy for Mainframe (VSP G1000, G1500, and VSP F1500) UR/URMF: Universal Replicator or Universal Replicator for Mainframe (VSP Gx00 models and VSP Fx00 models) TC: TrueCopy (VSP Gx00 models and VSP Fx00 models) UR: Universal Replicator GAD: global-active device
Maximum Initial Copy Activities (VSP Gx00 models and VSP Fx00 models)	Number of volumes that can be copied per initial copy operation (1 to 512). Displayed only when GAD is selected for Copy Type.

Storage System Options

This area is not displayed when GAD is selected for Copy Type.

Item	Description
Maximum Initial Copy Activities	<p>Number of volumes that can be copied per initial copy operation.</p> <p>When the selected Copy Type is TC/TCMF or GAD: 1 to 512 (default = 64)</p> <p>When the selected Copy Type is UR/URMF: 1 to 128 (default = 64)</p>
Blocked Path Monitoring*	Number of seconds for the system to monitor blocked paths. Displayed for TC or TCz pairs.
Blocked Path SIM Monitoring*	Number of seconds for the system to monitor SIMs reported for blocked paths. Displayed for TC or TCz pairs.
Services SIM of Remote Copy* (VSP G1000, G1500, and VSP F1500)	Whether services SIMs in the remote CU are reported to the host. Displayed for TC or TCz pairs.
* These options are displayed only when the selected Copy Type is TC/TCMF. This setting also applies when you are monitoring the path blockade or the SIM reported by path blockade in UR or GAD.	

CU Options

The CU options are not displayed when the selected Copy Type is GAD.

Item	Description
Maximum Initial Copy Activities ¹	<ul style="list-style-type: none"> Enable: Allows you to change the maximum initial copy activities setting for the selected CUs. Disable (default): The maximum initial copy activities setting applies to all CUs and cannot be changed per CU.
CU	CU number.
Maximum Initial Copy Activities*	Maximum initial copy activities setting for the CU. A hyphen is displayed if Disable is selected in Maximum Initial Copy Activities.
PPRC Support* (VSP G1000, G1500, and VSP F1500)	Whether PPRC is supported by the host (default = No).

Item	Description
Services SIM (VSP G1000, G1500, and VSP F1500)	Whether remote copy service SIMs are reported to the host (default = No Report).
Change CU Options	Opens the Change CU Options window to allow you to change the CU options for the selected CUs. This button cannot be used if the Disable radio button is selected for Maximum Initial Copy Activities.
* These items are displayed only when the selected Copy Type is TC/TCMF.	

Edit Remote Replica Options confirmation window

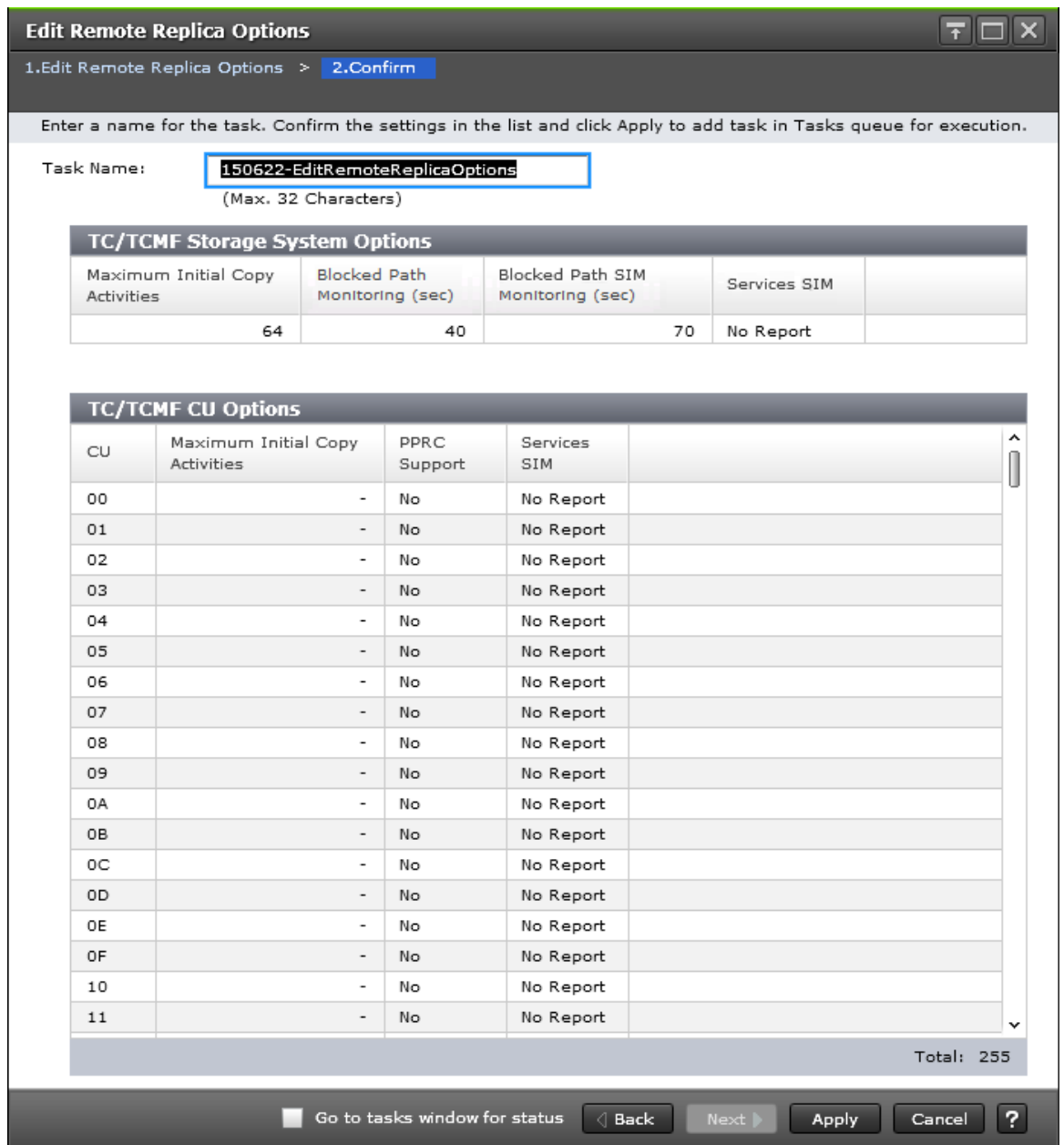

In this topic, you can view the following tables.

- [Storage System Options on page 462](#)
- [CU Options on page 463](#)

Storage System Options

Item	Description
Maximum Initial Copy Activities	Number of volumes that can be copied per initial copy operation.

Item	Description
Blocked Path Monitoring (sec)	TC/TCz only. Number of seconds for the system to monitor blocked paths
Blocked Path SIM Monitoring (sec)	TC/TCz only. Number of seconds for the system to monitor SIMs reported for blocked paths
Services SIM (VSP G1000, G1500, and VSP F1500)	TC/TCz only. Whether services SIMs are reported to the host.

CU Options

Following will not be displayed if selecting GAD for Copy Type.

Item	Description
CU	CU number.
Maximum Initial Copy Activities	TC/TCz only. Number of volumes that can be copied per initial copy operation.
PPRC support by host (VSP G1000, G1500, and VSP F1500)	TC/TCz only. Whether PPRC is supported by the host.
Services SIM (VSP G1000, G1500, and VSP F1500)	Whether services SIMs are reported.

Add Remote Paths window

Use this window to add remote paths to a remote connection.

When Select Type is Fibre:

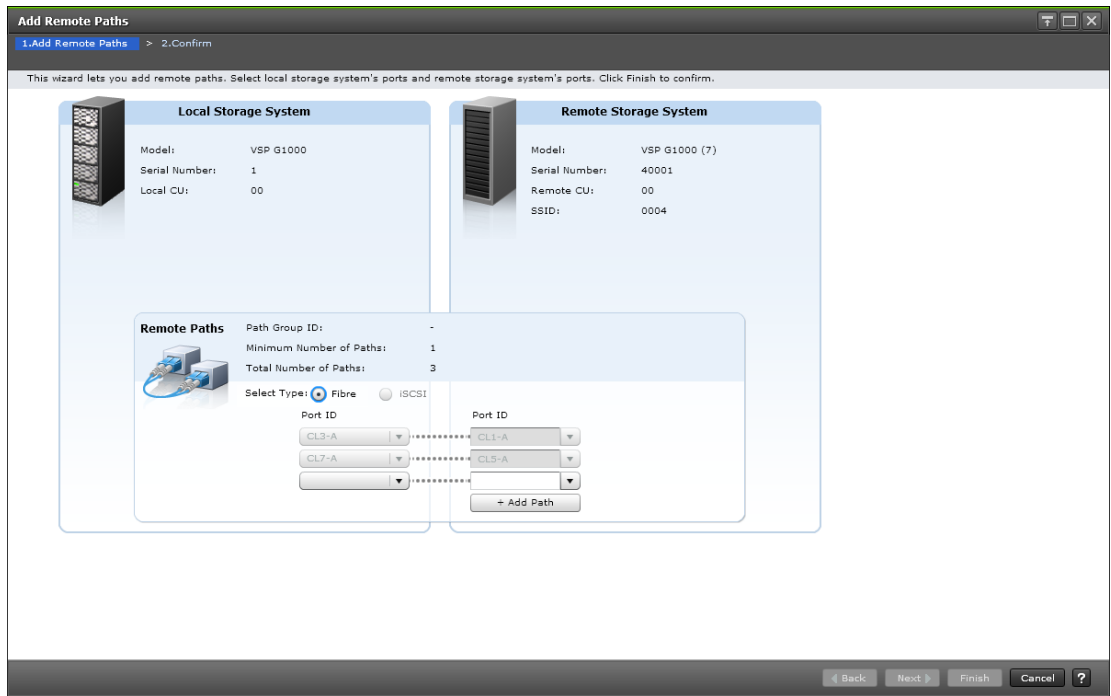

When Select Type is iSCSI:

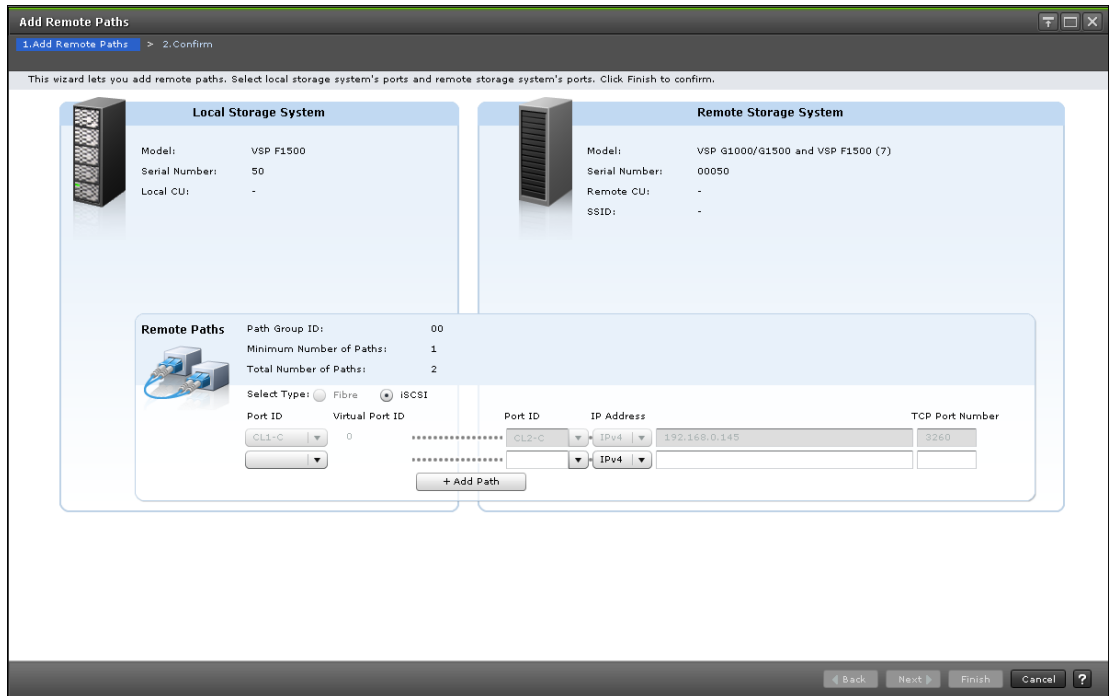

Local Storage System

Item	Description
Model	Local system model.
Serial Number	Local system serial number.
Local CU (VSP G1000, G1500, and VSP F1500)	Local system CU number. A hyphen is displayed in case of system connection.

Remote Storage System

Item	Description
Model	Remote system model.
Serial Number	Remote system serial number.
Remote CU (VSP G1000, G1500, and VSP F1500)	Remote system CU number. A hyphen is displayed in case of system connection.
SSID (VSP G1000, G1500, and VSP F1500)	Remote system SSID. A hyphen is displayed in case of system connection.

Remote Paths

Item	Description
Path Group ID	Path group identifier. A hyphen is displayed for CU connection.
Minimum Number of Paths	Specified minimum number of remote paths.
Total Number of Paths	Total number of paths. Total of the number of paths registered for remote connections and the number of paths to be added (including blank lines).
Select Type	Select the port type. <ul style="list-style-type: none"> Fibre: Fibre Channel port iSCSI: iSCSI port (VSP G1000, G1500, and VSP F1500) For TCz and URz, Fibre is selected automatically because connections using iSCSI ports are not supported.
Port ID (for local storage systems)	Select the port identifier of the local storage system.
Virtual Port ID (for local storage systems)	Virtual port ID of the local storage system. Displayed when iSCSI is selected as the port type.
Port ID (for remote storage systems)	Select the port identifier of a remote storage system. A minus button is displayed if the number of valid paths is greater than the minimum number of paths. Clicking the minus button deletes the text box of the port for the local and remote storage systems.
IP address	Select the IP type (IPv4 or IPv6) for the port of the remote storage system to enter the IP address.

Selected Remote Connection table

Item	Description
Connection Type (VSP G1000, G1500, and VSP F1500)	<ul style="list-style-type: none"> System: system-to-system connection. CU: CU-to-CU connections.
Local CU (VSP G1000, G1500, and VSP F1500)	Local system CU number.
Remote Storage System	<ul style="list-style-type: none"> (VSP Gx00 models and VSP Fx00 models) Model and serial number. (VSP G1000, G1500, and VSP F1500) Model / Serial Number: Model and serial number. (VSP G1000, G1500, and VSP F1500) CU: CU number. (VSP G1000, G1500, and VSP F1500) SSID: SSID number. TCz only.
Path Group ID	Path group identifier.
Channel Type	Channel type for remote connections. <ul style="list-style-type: none"> Fibre: Port type of all remote paths in the remote connection is Fibre. (VSP G1000, G1500, and VSP F1500) FCoE: Port type of all remote paths in the remote connection is FCoE. iSCSI: Port type of all remote paths in the remote connection is iSCSI. Mixed: Port type of at least two remote paths in the remote connection is not the same.
Number of Remote Paths	Number of remote paths including those being added.
Minimum Number of Paths	Specified minimum number of remote paths.

Selected Remote Paths table

Item	Description
Local	Information about ports on the local storage system. <ul style="list-style-type: none"> Port ID: Port identifier Port Type: Port type (Fibre, iSCSI, or (VSP G1000, G1500, and VSP F1500) FCoE) Virtual Port ID: Virtual port ID. Displayed when iSCSI is selected for Port Type.
Remote	Information about ports on the remote storage system. <ul style="list-style-type: none"> Port ID: Port identifier IP Address: IP address of the port. Displayed when iSCSI is selected for Port Type. TCP Port Number: TCP port number of the port. Displayed when iSCSI is selected for Port Type.

Remove Remote Paths window

Use this window to remove paths from a remote connection.

When Select Type is Fibre:

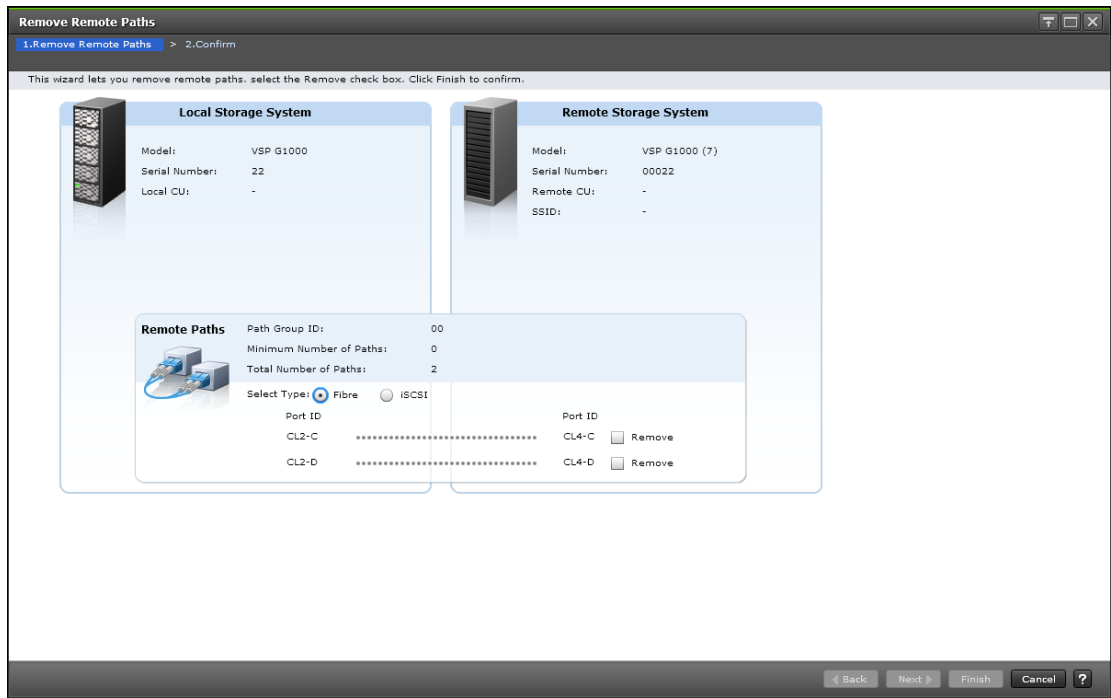

When Select Type is iSCSI:

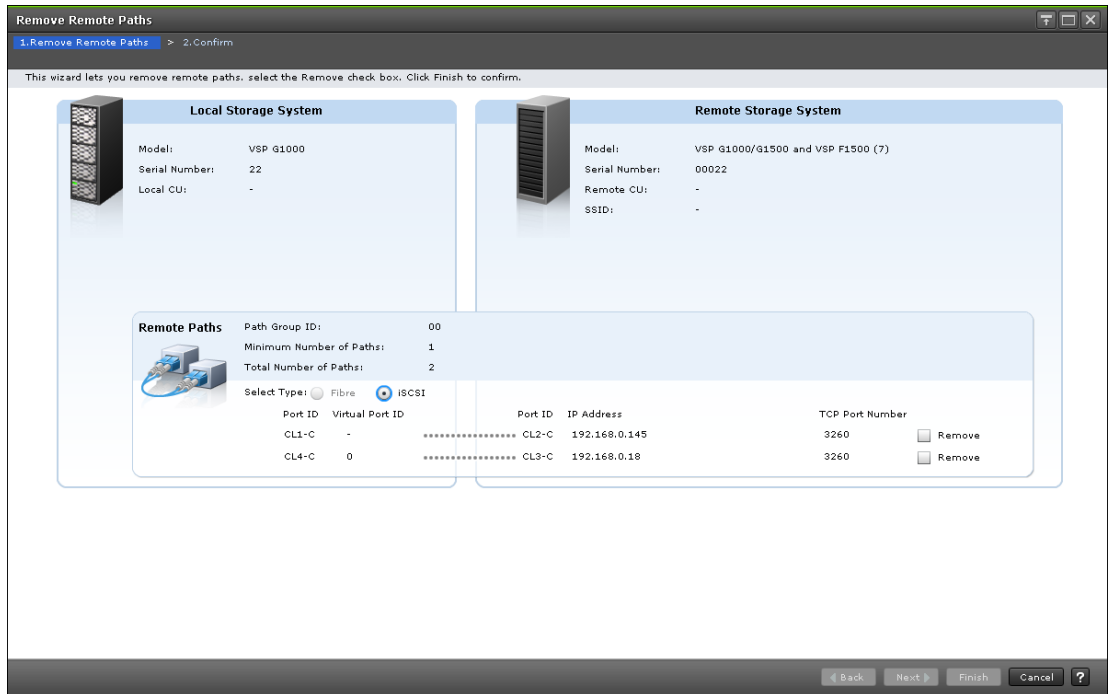

Local Storage System

Item	Description
Model	Local system model.
Serial Number	Local system serial number.
Local CU (VSP G1000, G1500, and VSP F1500)	Local system CU number. A hyphen (-) is displayed in the case of system connection.

Remote Storage System

Item	Description
Model	Remote system model.
Serial Number	Remote system serial number.
Remote CU (VSP G1000, G1500, and VSP F1500)	Remote system CU number. A hyphen (-) is displayed for system connection.
SSID (VSP G1000, G1500, and VSP F1500)	Remote system SSID. A hyphen (-) is displayed for system connection.

Remote Paths

Item	Description
Path Group ID	Path group identifier. A hyphen is displayed for CU connection.
Minimum Number of Paths	Specified minimum number of remote paths.
Total Number of Paths	Total number of paths. Displays the total number of path registered to remote connection and path to be added (includes blank line).
Select Type	Select the port type. <ul style="list-style-type: none"> Fibre: Fibre Channel port iSCSI: iSCSI port (VSP G1000, G1500, and VSP F1500) For TCz and URz, Fibre is selected automatically because connections using iSCSI ports are not supported.
Port ID (for local storage systems)	Port identifier of the local storage system. Information of the added paths.
Virtual Port ID (for local storage systems)	Virtual port ID of the local storage system. Displayed only when iSCSI is selected as the port type.
Port ID (for remote storage systems)	Port identifier of a remote storage system. Information of the added paths.
IP address	IP address of a port on a remote storage system. Displayed only when iSCSI is selected as the port type.
TCP Port Number	TCP port number of a port on a remote storage system. Displayed only when iSCSI is selected as the port type.

Item	Description
Remove	Check box for deleting the path from the remote connection.

Remove Remote Paths confirmation window

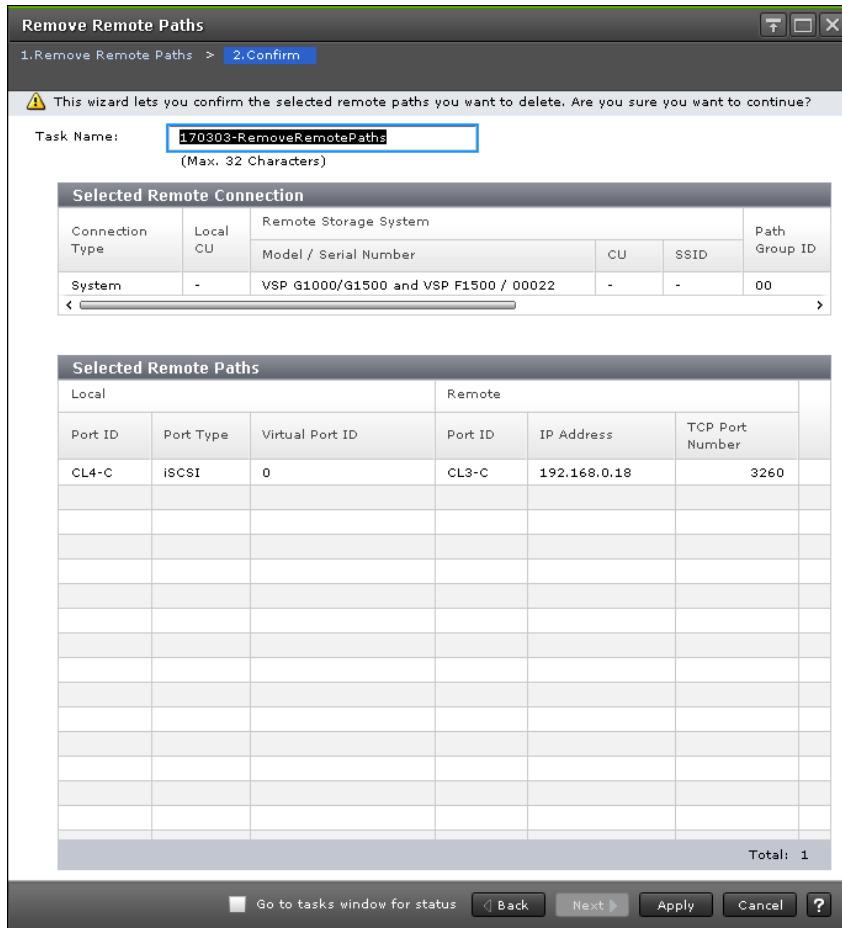

In this topic, you can view the following tables.

- [Selected Remote Connection table on page 470](#)
- [Selected Remote Paths table on page 471](#)

Selected Remote Connection table

Item	Description
Connection Type (VSP G1000, G1500, and VSP F1500)	<ul style="list-style-type: none"> • System: system-to-system connection. • CU: CU-to-CU connections.

Item	Description
Local CU (VSP G1000, G1500, and VSP F1500)	Local system CU number.
Remote Storage System	<ul style="list-style-type: none"> (VSP Gx00 models and VSP Fx00 models) Model and serial number. (VSP G1000, G1500, and VSP F1500) Model / Serial Number: Model and serial number. (VSP G1000, G1500, and VSP F1500) CU: CU number. (VSP G1000, G1500, and VSP F1500) SSID: SSID number. TCz only.
Path Group ID	Path group identifier.
Channel Type	Channel type for remote connections. <ul style="list-style-type: none"> Fibre: Port type of all remote paths in the remote connection is Fibre. (VSP G1000, G1500, and VSP F1500) FCoE: Port type of all remote paths in the remote connection is FCoE. iSCSI: Port type of all remote paths in the remote connection is iSCSI. Mixed: Port type of all remote paths in the remote connection is not the same (at least two are different).
Number of Remote Paths	Number of remote paths including those being added.
Minimum Number of Paths	Specified minimum number of remote paths.

Selected Remote Paths table

Item	Description
Local	Information about ports on the local storage system. <ul style="list-style-type: none"> Port ID: Port identifier Port Type: Port type (Fibre, iSCSI, or (VSP G1000, G1500, and VSP F1500) FCoE) Virtual Port ID: Virtual port ID. Displayed when iSCSI is selected for Port Type.
Remote	Information about ports on the remote storage system. <ul style="list-style-type: none"> Port ID: Port identifier IP Address: IP address of the port. Displayed when iSCSI is selected for Port Type. TCP Port Number: TCP port number of the port. Displayed when iSCSI is selected for Port Type.

Edit Remote Connection Options window

Use this window to edit remote connection options, such as minimum paths and round trip time.

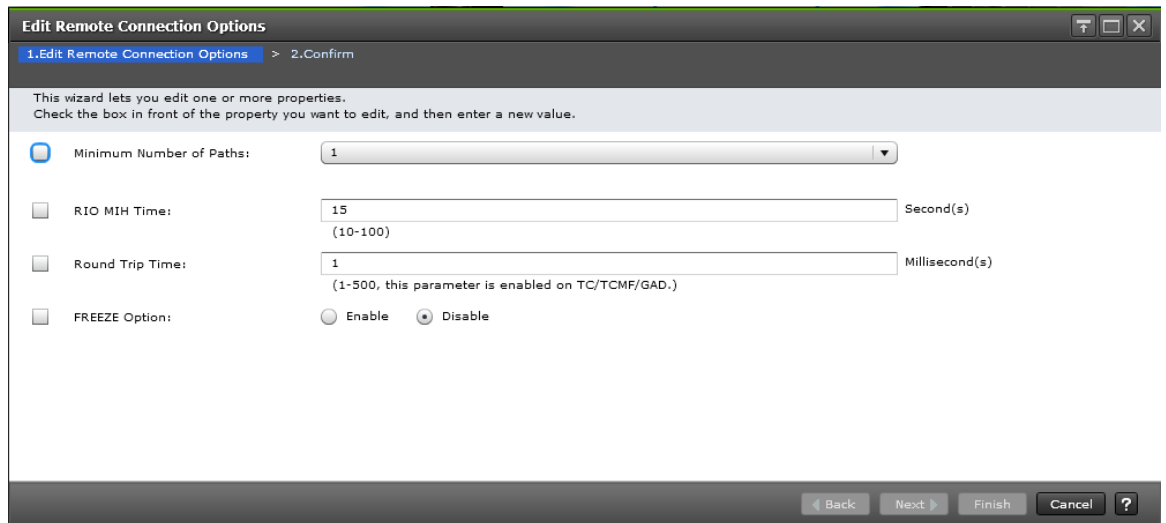

Selected Remote Connection table

Item	Description
Minimum Number of Paths	Minimum number of remote paths. <ul style="list-style-type: none"> TC and TCz: The range is from 1 to 8, and the default is 1. UR and URz: The minimum number is set to 1, regardless of the number entered.
RIO MIH Time	Time limit between 10 and 100 seconds (default = 15) for the data-transfer operation to complete.
Round Trip Time	TC, TCz, and GAD only. Time limit between 1 and 500 milliseconds for data copy from P-VOL to S-VOL (1 is the default).
FREEZE Option (VSP G1000, G1500, and VSP F1500)	TCz only. Enables or disables support for the CGROUP (FREEZE/RUN) PPRC TSO command. Displayed only when Connection Type is CU.

Edit Remote Connection Options confirmation window

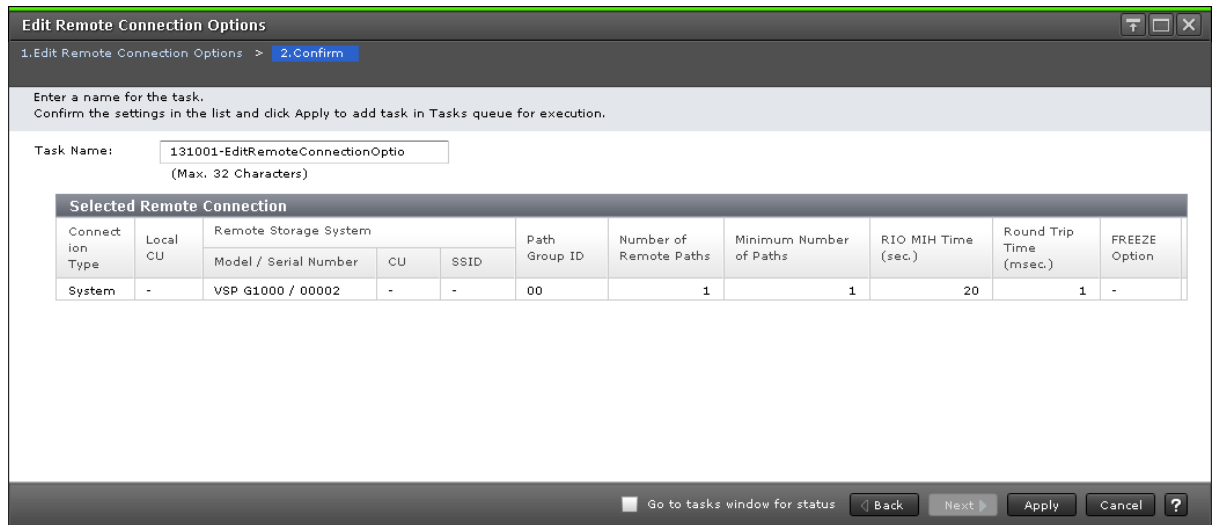

Selected Remote Connection table

Item	Description
Connection Type (VSP G1000, G1500, and VSP F1500)	<ul style="list-style-type: none"> System: system-to-system connection. CU: CU-to-CU connections.
Local CU (VSP G1000, G1500, and VSP F1500)	Local system CU number.
Remote Storage System	<ul style="list-style-type: none"> (VSP Gx00 models and VSP Fx00 models) Model and serial number. (VSP G1000, G1500, and VSP F1500) Model / Serial Number: Model and serial number. (VSP G1000, G1500, and VSP F1500) CU: Remote Storage System's CU number. (VSP G1000, G1500, and VSP F1500) SSID: Remote Storage System's SSID number. TCz only.
Path Group ID	Path group identifier.
Number of Remote Paths	Number of remote paths including those being added.
Minimum Number of Paths	Minimum number of remote paths. <ul style="list-style-type: none"> TC and TCz: The range is from 1 to 8, and the default is 1. UR and URz: The minimum number is set to 1, regardless of the number entered.
RIO MIH Time	Time limit between 10 and 100 seconds (default = 15) for the data-transfer operation to complete.
Round Trip Time (msec.)	TC, TCz, and GAD only. Time limit between 1 and 500 milliseconds for data copy from P-VOL to S-VOL (1 is the default).
FREEZE Option (VSP G1000, G1500, and VSP F1500)	TCz only. Enables or disables support for the CGROUP (FREEZE/RUN) PPRC TSO command.

Remove Remote Connections window

Use this window to remove remote connections.

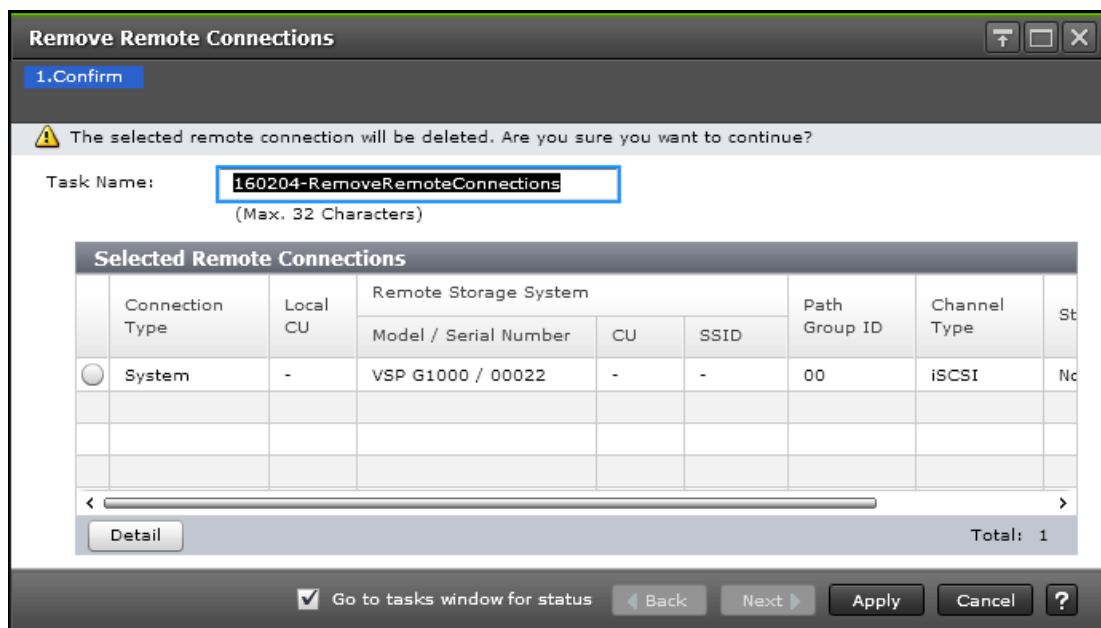

Selected Remote Connections table

Item	Description
Connection Type (VSP G1000, G1500, and VSP F1500)	<ul style="list-style-type: none"> System: system-to-system connection. CU: CU-to-CU connections.
Local CU (VSP G1000, G1500, and VSP F1500)	Local system CU number.
Remote Storage System	<ul style="list-style-type: none"> (VSP Gx00 models and VSP Fx00 models) Model and serial number. (VSP G1000, G1500, and VSP F1500) Model / Serial Number: Model and serial number. (VSP G1000, G1500, and VSP F1500) CU: CU number. (VSP G1000, G1500, and VSP F1500) SSID: SSID number. TCz only.
Path Group ID	TC only. Path group identifier.
Channel Type	Channel type for remote connections. <ul style="list-style-type: none"> Fibre: Port type of all remote paths in the remote connection is Fibre. (VSP G1000, G1500, and VSP F1500) FCoE: Port type of all remote paths in the remote connection is FCoE.

Item	Description
	<ul style="list-style-type: none"> iSCSI: Port type of all remote paths in the remote connection is iSCSI. Mixed: Port type of all remote paths in the remote connection is not the same (at least two are different).
Status	Path status.
Number of Remote Paths	Number of remote paths including those being added.
Detail	Opens the View Remote Connection Properties window.

Edit Ports window

Fibre Channel

For Fibre Channel ports

Item	Description
Port Attribute (VSP G1000, G1500, and VSP F1500)	<p>Select the attribute of the port indicating I/O flow.</p> <ul style="list-style-type: none"> Initiator: Issues I/O commands to a target port when I/O is executed between storage systems with TrueCopy, and so on. Target: Receives I/O commands from a host. RCU Target: Receives I/O commands from an initiator when I/O is executed between storage systems with TrueCopy, and so on. External: Issues I/O commands to a target port of an external storage system with Universal Volume Manager.

Item	Description
	<p>If this port attribute is changed from Target or RCU Target to Initiator or to External, the host group of this port belongs to meta_resource.</p> <p>Therefore, the host group of this port is not displayed in windows.</p>
Port Security	Select whether LUN security is Enabled or Disabled.
Port Speed	<p>Select the data transfer speed, in Gbps, for the selected Fibre Channel port.</p> <p>If Auto is selected, the storage system automatically sets the data transfer speed to 2, 4, 8, 10, or 16 Gbps for VSP G1000, VSP G1500, and VSP F1500, or 2, 4, 8, 10, 16, or 32 Gbps for VSP Gx00 models and VSP Fx00 models.</p> <p>Caution: If you are using 2-Gbps HBA and switch, set the transfer speed of the CHF (Fibre Channel adapter) port for VSP G1000, VSP G1500, and VSP F1500, or CHB(FC) (Fibre Channel board) for VSP Gx00 models and VSP Fx00 models as 2 Gbps. If you are using 4-Gbps HBA and switch, set the transfer speed of the CHF or CHB(FC) port as 4 Gbps. If you are using 8-Gbps HBA and switch, set the transfer speed of the CHF or CHB(FC) port as 8 Gbps. If you are using 16-Gbps HBA and switch, set the transfer speed of the CHF or CHB(FC) port as 16-Gbps. If you are using a 32-Gbps HBA and switch, set the transfer speed of the CHB(FC) port to 32 Gbps. If the Auto Negotiation setting is required, the linkup might become improper at server restart. Check a channel lamp, and if it is blinking, remove and re-insert the cable to perform the signal synchronization and linkup.</p> <p>When the transfer speed of the CHF port is set to Auto, the data might not be transferred at the maximum speed depending on the connected device. Confirm the transfer speed appearing in Speed in the Ports list when you start up the storage system, HBA, or switch. When the transfer speed is not the maximum speed, select the maximum speed from the list on the right or remove and reinsert the cable.</p> <p>(VSP G1000, G1500, and VSP F1500) Only 10 Gbps can be specified for the FCoE port. Auto cannot be specified for the FCoE port.</p>
Address (Loop ID)	Select the address of the selected port. Do not set the address to the FCoE port for VSP G1000, VSP G1500, and VSP F1500.
Fabric	Select whether a fabric switch is set to ON or OFF. Only ON can be specified for the FCoE port for VSP G1000, VSP G1500, and VSP F1500.
Connection Type	<p>Select the topology:</p> <ul style="list-style-type: none"> • FC-AL: Fibre Channel arbitrated loop • P-to-P (point-to-point). Only P-to-P can be specified for the FCoE port. <p>Caution: Some fabric switches require that you specify point-to-point topology. If you enable a fabric switch, check the documentation for the fabric switch to determine whether your switch requires point-to-point topology.</p>

iSCSI

⏏
✖
⏏
⏏

1. Edit Ports > 2. Confirm

This wizard lets you edit one or more properties. Check the box in front of the property you want to edit, and then enter the new value.

⤴ [IPv4 Settings](#)

IP Address:

Subnet Mask:

Default Gateway:

IPv6 Mode: Enable Disable

⤴ [IPv6 Settings](#)

Link Local Address: Auto Manual

FE80:0000:0000:0000:

Global Address: Auto Manual

Global Address:

Global Address 2:

Default Gateway:

Port Attribute :

Port Security : Enable Disable

Port Speed :

TCP Port Number:
(1-65535)

Selective ACK: Enable Disable

Delayed ACK: Enable Disable

Maximum Window Size:

Ethernet MTU Size:

Keep Alive Timer: Seconds

⏪ Back
Next ⏩
Finish
Cancel
?

For iSCSI ports

Item	Description
IPv4 Settings	<p>Information about IPv4. If the iSCSI virtual port mode is enabled for the port, this item cannot be selected.</p> <ul style="list-style-type: none"> IP Address: IP address of the port. If 2 or more ports are selected, this information cannot be specified. Subnet Mask: Subnet mask of the port. Default Gateway: Default gateway of the port.
IPv6 Mode	<p>Specify this information if IPV6 is used or not used. If the iSCSI virtual port mode is enabled for the port, this item cannot be selected.</p>

Item	Description
	<ul style="list-style-type: none"> • Enable: IPv6 mode is enabled. If Enable is selected, the IPv6 Settings can be specified. • Disable: IPv6 mode is disabled.
IPv6 Settings	<p>Information about IPv6. If the iSCSI virtual port mode is enabled for the port, this item cannot be selected.</p> <ul style="list-style-type: none"> • Link Local Address: Link local address for the port. <ul style="list-style-type: none"> Auto: Sets the link local address automatically. Manual: Sets the link local address manually. Specify the link local address in the text box. • Global Address: Global address for the port. <ul style="list-style-type: none"> Global Address: If Manual is selected, enter the address for the global address. Global Address 2: If Manual is selected, enter the address for the global address 2. • Default Gateway: Default gateway address for the port.
Port Attribute (VSP G1000, G1500, and VSP F1500)	Specify the attribute of the port: Initiator, Target, RCU Target, or External. If the port attribute is changed from Target or RCU Target to Initiator or External, iSCSI targets that belong to this port are included in meta_resource. iSCSI targets that belong to this port are not displayed in the window.
Port Security	Specify whether to use LUN security on the port. <ul style="list-style-type: none"> • Enable: Use LUN security on the port. • Disable: Do not use LUN security on the port.
Port Speed	<p>(VSP G1000, G1500, and VSP F1500) The data transfer speed is fixed to 10 Gbps.</p> <p>(VSP Gx00 models and VSP Fx00 models) Select the data transfer speed for the selected port: 1 Gbps, 10 Gbps, or Auto.</p>
TCP Port Number	Specify the TCP port number. If the iSCSI virtual port mode is enabled for the port, this item cannot be selected.
Selective ACK	Specify this information if the selective ACK is used or not used. If the iSCSI virtual port mode is enabled for the port, this item cannot be selected. <ul style="list-style-type: none"> • Enable: The selective ACK is enabled. • Disable: The selective ACK is disabled.
Delayed ACK	Specify this information if the delayed ACK is used or not used. If the iSCSI virtual port mode is enabled for the port, this item cannot be selected. <ul style="list-style-type: none"> • Enable: The delayed ACK is enabled. • Disable: The delayed ACK is disabled.
Maximum Window Size	Select the maximum window size from 64 KB, 128 KB, 256 KB, 512 KB, or 1024 KB. If the iSCSI virtual port mode is enabled for the port, this item cannot be selected.
Ethernet MTU Size	Select Ethernet MTU size from 1500 bytes, 4500 bytes, or 9000 bytes. If the iSCSI virtual port mode is enabled for the port, this item cannot be selected.
Keep Alive Timer	Specify the interval time to perform the keep alive timer option. If the iSCSI virtual port mode is enabled for the port, this item cannot be selected.
VLAN Tagging Mode	Specify this information if the VLAN tagging mode is used or not used. If the iSCSI virtual port mode is enabled for the port, this item cannot be selected.

Item	Description
	<ul style="list-style-type: none"> • Enable: The VLAN tagging mode is enabled and specify the VLAN ID in the text box. • Disable: The VLAN tagging mode is disabled.
iSNS Server	<p>Specify this information if the iSNS server is used or not used. If the iSCSI virtual port mode is enabled for the port, this item cannot be selected.</p> <ul style="list-style-type: none"> • Enable: The iSNS server mode is enabled. And specify the IP Address and TCP Port Number of the following. • Disable: The iSNS server mode is disabled.
IP Address	Specify the IP address for IPv4 or IPv6. If the iSCSI virtual port mode is enabled for the port, this item cannot be selected.
TCP Port Number	Specify the TCP port number. If the iSCSI virtual port mode is enabled for the port, this item cannot be selected.
CHAP User Name	Specify the CHAP user name.
Secret	Specify the secret to be used for host authentication.
Re-enter Secret	Specify the secret again for confirmation.

Edit Ports confirmation window

Fibre Channel

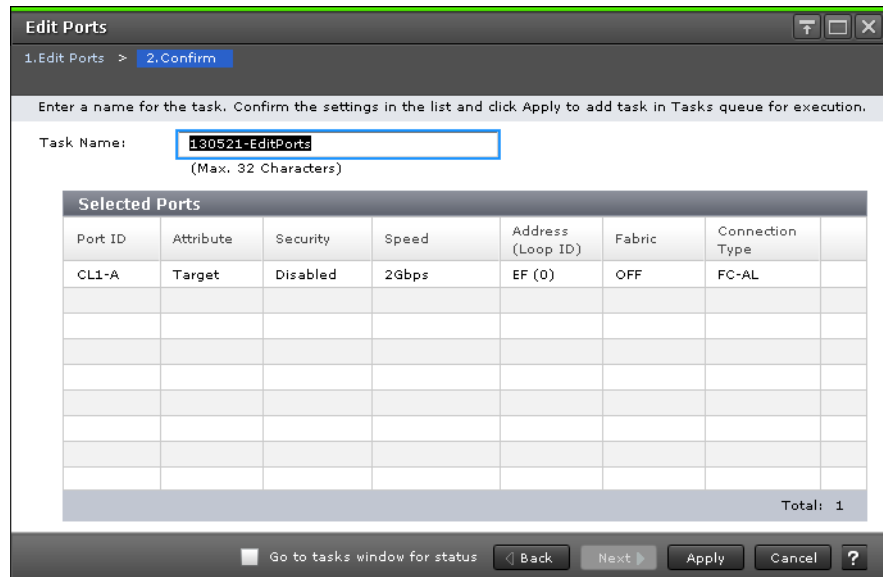

Selected Ports table for Fibre Channel ports

Item	Description
Port ID	Identifier of the port.

Selected Ports table for iSCSI ports

Item	Description
Port ID	Identifier of the port.
IPv4	Information about IPv4. <ul style="list-style-type: none"> IP Address: IP address of the port. Subnet Mask: Subnet mask of the port. Default Gateway: Default gateway of the port.
IPv6	Information about IPv6. <ul style="list-style-type: none"> Mode: IPv6 setting (Enabled or Disabled) for the port. Link Local Address: Link local address for the port. Global Address: Global address for the port. Global Address 2: Global address for the port. Default Gateway: Default gateway address for the port.
Port Security	Specify this information if the LUN security is used or not used. <ul style="list-style-type: none"> Enable: The LUN security is enabled. Disable: The LUN security is disabled.
Port Speed	Select the data transfer speed for the selected port. 1 Gbps, 10 Gbps, or Auto can be selected.
TCP Port Number	Select the address of the selected port. Do not set the address to an FCoE port. Specify the TCP port number.
Selective ACK	Specify this information whether the selective ACK is used or not used. <ul style="list-style-type: none"> Enable: The selective ACK is enabled. Disable: The selective ACK is disabled.
Delayed ACK	Select the topology. <ul style="list-style-type: none"> FC-AL: Fibre Channel arbitrated loop P-to-P (point-to-point). Only P-to-P can be specified for an FCoE port. <p>Caution: Some fabric switches require that you specify point-to-point topology. If you enable a fabric switch, check the documentation for the fabric switch to determine whether your switch requires point-to-point topology.</p>
Delayed ACK	Appears with enabled or disabled for the delayed ACK.
Maximum Window Size	Select the maximum window size from 64 KB, 128 KB, 256 KB, 512 KB, or 1024 KB.
Ethernet MTU Size	Select Ethernet MTU size from 1500 bytes, 4500 bytes, or 9000 bytes.
MTU	Ethernet MTU size.
Keep Alive Timer	Specify the interval time to perform the keep alive timer option.
VLAN	<ul style="list-style-type: none"> Tagging Mode: Appears with enabled or disabled for VLAN. ID: Identifier of VLAN.
iSNS Server	<ul style="list-style-type: none"> Mode: iSNS server setting (Enabled or Disabled). IP Address: IP address of the iSNS server. TCP Port Number: TCP port number of the iSNS server.
CHAP Authentication	Information for the host authentication. <ul style="list-style-type: none"> User Name: User name appears.

Item	Description
	<ul style="list-style-type: none">• Secret: If the secret is specified, a character string of six asterisks (*) appears.



Glossary

#

2DC

two-data-center. Refers to the local and remote sites, or data centers, in which TrueCopy (TC) and Universal Replicator (UR) combine to form a remote replication configuration.

In a 2DC configuration, data is copied from a TC primary volume at the local site to the UR master journal volume at an intermediate site, then replicated to the UR secondary volume at the remote site. Since this configuration side-steps the TC secondary volume at the intermediate site, the intermediate site is not considered a data center.

A

administrative logical unit (ALU)

An LU used for the conglomerate LUN structure, a SCSI architecture model. In the conglomerate LUN structure, all host access is through the ALU, which functions as a gateway to sort the I/Os for the subsidiary logical units (SLUs) grouped under the ALU.

The host requests I/Os by using SCSI commands to specify the ALU and the SLUs grouped under the ALU. An ALU is called a Protocol Endpoint (PE) in vSphere. See also *subsidiary logical unit (SLU)*.

alternate path

A secondary path (for example, port, target ID, or LUN) to a logical volume, in addition to the primary path, that is used as a backup in case the primary path fails.

asymmetric access

A method of defining a preferred path for sending and receiving data when multiple alternate paths are used between a server and storage

systems, such as a cross-path configuration for global-active device. To use, ALUA must be enabled.

audit log

Files that store a history of the operations performed from Device Manager - Storage Navigator and the commands that the storage system received from hosts, and data encryption operations.

C

cache logical partition (CLPR)

Virtual cache memory that is set up to be allocated to hosts that are in contention for cache memory. CLPRs can be used to segment storage system cache that is assigned to parity groups.

cascade configuration

In a 3DC cascade configuration for remote replication, data is copied from a local site to an intermediate site and then to a remote site using TrueCopy and Universal Replicator. See also *3DC*.

In a ShadowImage cascade configuration, two layers of secondary volumes can be defined for a single primary volume. Pairs created in the first and second layer are called cascaded pairs.

CCI

See Command Control Interface.

channel adapter (CHA)

The hardware component that processes channel commands from hosts and manages host access to cache.

channel path

The communication path between a channel and a control unit. A channel path consists of the physical channel path and the logical path.

CLI

command line interface

CLPR

See cache logical partition.

consistency group (CTG)

A group of copy relationships between virtual disks that are managed as a single entity. A group of pairs on which copy operations are performed simultaneously. When a CTG ID is specified for a specific operation, the operation is performed simultaneously on all pairs belonging to the CTG while keeping data consistency.

consistency time (C/T)

A replication policy or threshold that indicates the amount of time that a replication target (volume, journal group, or extended consistency group, for example) is allowed to lag behind replication of the master, or source, volume.

control unit (CU)

Created in an enterprise-class storage system. Also called a CU image. The LDEVs created in a storage system are connected to a single CU, and a number is assigned to each CU for identifying its LDEVs. Therefore, volumes (LDEVs) in a storage system are specified by the CU number (CU#) and LDEV number.

copy pair

A primary and secondary volume pair linked by the volume replication functionality of a storage system. The primary volume contains original data, and the secondary volume contains the copy of the original.

Copy operations can be synchronous or asynchronous, and the volumes of the copy pair can be located in the same storage system (local copy) or in different storage systems (remote copy).

CSV

comma-separated values

D**data consistency**

When the data on the secondary volume is identical to the data on the primary volume.

data path

The physical paths used by primary storage systems to communicate with secondary storage systems in a remote replication environment.

data pool

One or more logical volumes designated to temporarily store original data. When a snapshot is taken of a primary volume, the data pool is used if a data block in the primary volume is to be updated. The original snapshot of the volume is maintained by storing the changeable data blocks in the data pool.

device emulation

Indicates the type of logical volume. Mainframe device emulation types provide logical volumes of fixed size, called logical volume images (LVIs), which contain EBCDIC data in CKD format. Typical mainframe device emulation types include 3390-9 and 3390-M. Open-systems device emulation types provide logical volumes of variable size, called logical units (LUs), that contain ASCII data in FBA format. The typical open-systems device emulation type is OPEN-V.

differential data

Changed data in the primary volume not yet reflected in the secondary volume of a copy pair.

DKCMAIN

disk controller main. Refers to the microcode or software for the storage system.

DP-VOL

Dynamic Provisioning virtual volume. A virtual volume that has no memory space that is used by Dynamic Provisioning.

E**extended consistency group (EXCTG)**

Universal Replicator for Mainframe journals in which data consistency is ensured. Journal registration in an EXCTG is required if you are performing copy operations between multiple primary and secondary systems.

external path

A path from a storage port of a storage system to a volume on a connected external storage system.

external volume

A logical volume whose data resides on drives that are physically located in an externally connected storage system.

F

failback

The process of restoring a system, component, or service in a state of failover back to its original state (before failure).

failback

The process of restoring a system, component, or service in a state of failover back to its original state (before failure).

H

host

One or more host bus adapter (HBA) world wide names (WWN).

host failover

The process of switching operations from one host to another host when the primary host fails.

host group

Custom grouping of hosts that segregates hosts in a meaningful way, for example, a group of hosts that is segregated by operating system. A host group can be shared with another virtual port or another physical port for alternate path support.

host mode

Operational modes that provide enhanced compatibility with supported host platforms. Used with Fibre Channel ports on RAID storage systems.

host mode option

Operational modes that provide enhanced compatibility with supported host platforms. Used with Fibre Channel ports on RAID storage systems.

HSD

Host storage domain. A group used to strengthen the security of volumes in storage systems. By associating and grouping hosts and volumes by storage system port, host storage domains can be used to restrict access from hosts to volumes.

Device Manager defines the host groups set up with the storage system LUN security function as host storage domains. Host storage domains for

storage systems that do not have host groups are defined in the same manner as if they had been set with the LUN security function.

I

initial copy

An initial copy operation is performed when a copy pair is created. Data on the primary volume is copied to the secondary volume before any updates are processed.

iSCSI

Internet Small Computer Systems Interface

J

journal volume

A volume that records and stores a log of all events that take place in another volume. In the event of a system crash, the journal volume logs are used to restore lost data and maintain data integrity.

In Universal Replicator, differential data is held in journal volumes until you copy it to the S-VOL.

L

layer-1 (L1) pair

In a ShadowImage cascade configuration, a layer-1 pair consists of a primary volume and secondary volume in the first cascade layer. You can pair an L1 primary volume with up to three L1 secondary volumes. See also *cascade configuration*.

layer-2 (L2) pair

In a ShadowImage cascade configuration, a layer-2 (L2) pair consists of a primary volume and secondary volume in the second cascade layer. You can pair an L2 primary volume with up to two L2 secondary volumes. See also *cascade configuration*.

LDKC

Logical disk controller

local storage system

A storage system connected to the management client.

logical device (LDEV)

A volume created in a storage system. See also LU.

logical disk controller (LDKC)

A group of 255 control unit (CU) images in the RAID storage system that is controlled by a virtual (logical) storage system within the single physical storage system. For example, the Hitachi Universal Storage Platform V storage system supports two LDKCs, LDKC 00 and LDKC 01.

logical group

A user-defined collection of managed resources (hosts and volumes) that are grouped according to business operations, geographic locations, or other organizational divisions. Logical groups can be *public* or *private*:

- Public logical groups are accessible by any HCS user.
- Private logical groups are accessible only by HCS users who belong to user groups that are associated with the logical group.

logical unit (LU)

A volume, or LDEV, created in an open storage system, or configured for use by an open-systems host, for example, OPEN-V.

logical unit number (LUN)

A unique management number that identifies a logical unit (LU) in a storage system. A logical unit can be an end user, a file, a disk drive, a port, a host group that is assigned to a port, an application, or virtual partitions (or volumes) of a RAID set.

Logical unit numbers (LUNs) are used in SCSI protocols to differentiate disk drives in a common SCSI target device, such as a storage system. An open-systems host uses a LUN to access a particular LU.

LU

See logical unit.

LUN

See logical unit number.

LUSE volume

A combined LU composed of multiple OPEN-x devices. A LUSE device can be from 2 to 36 times larger than a fixed-size OPEN-x LU. LUSE lets the host access the data on the storage system using fewer LU numbers.

M

main control unit (MCU)

A storage system at a primary, or main, site that contains primary volumes of remote replication pairs. The main control unit (MCU) is configured to send remote I/O instructions to one or more storage systems at the secondary, or remote, site, called remote control units (RCUs). RCUs contain the secondary volumes of the remote replication pairs. See also remote control unit (RCU).

master journal (M-JNL)

The primary, or main, journal volume. A master journal holds differential data on the primary replication system until the data is copied to the restore journal (R-JNL) on the secondary system. See also restore journal.

mirror

In Universal Replicator, each pair relationship in and between journal groups is called a "mirror." Each pair is assigned a mirror ID when it is created. The mirror ID identifies individual pair relationships between journal groups.

N

node volume

A layer-2 primary volume in a ShadowImage cascade configuration. The secondary volume of a layer-2 pair is called a leaf volume. See also *cascade configuration*.

P

pair

Two logical volumes in a replication relationship in which one volume contains original data to be copied and the other volume contains the copy of the original data. The copy operations can be synchronous or asynchronous, and the pair volumes can be located in the same storage system (in-system replication) or in different storage systems (remote replication).

pair status

Indicates the condition of a copy pair. A pair must have a specific status for specific operations. When a pair operation completes, the status of the pair changes to a different status determined by the type of operation.

pool

A set of volumes that are reserved for storing Hitachi Thin Image data or Dynamic Provisioning write data.

pool volume (pool-VOL)

A logical volume that is reserved for storing Copy-on-Write Snapshot data or Dynamic Provisioning write data.

primary site

The physical location of a storage system that contains original data to be replicated and that is connected to one or more storage systems at a remote or secondary site via remote copy connections. A primary site can also be called a "main site" or "local site".

The term "primary site" is also used for host failover operations. In that case, the primary site is the location of the host on which the production applications are running, and the secondary site is the location of the host on which the backup applications that run when the applications at the primary site have failed.

primary volume (P-VOL)

In a volume pair, the source volume that is copied to another volume using the volume replication functionality of a storage system. The data on the P-VOL is duplicated synchronously or asynchronously on the secondary volume (S-VOL).

R**remote control unit (RCU)**

A storage system at a secondary, or remote, site that is configured to receive remote I/O instructions from one or more storage systems at the primary, or main, site. See also main control unit.

restore journal (R-JNL)

The secondary, or remote, journal volume. A restore journal holds differential data on the secondary replication system until the data is copied to the secondary volume (S-VOL). See also master journal (M-JNL).

RPO

See recovery point objective.

RTO

recovery time objective

S

secondary site

The physical location of the storage system that contains the primary volumes of remote replication pairs at the primary site. The storage system at the secondary site is connected to the storage system at the primary site via remote copy connections. The secondary site can also be called the "remote site". See also *primary site*.

secondary volume (S-VOL)

After a backup, the volume in a copy pair that is the copy of the original data on the primary volume (P-VOL). Recurring differential data updates keep the data in the S-VOL consistent with the data in the P-VOL.

service information message (SIM)

A message generated by the storage system when it detects an error or a service requirement.

service processor (SVP)

The computer inside a RAID storage system that hosts the Device Manager - Storage Navigator software and is used by service personnel for configuration and maintenance of the storage system.

shared volume

A volume that is being used by more than one replication function. For example, a volume that is the primary volume of a TrueCopy pair and the primary volume of a ShadowImage pair is a shared volume.

snapshot

A point-in-time virtual copy of a Hitachi Thin Image primary volume (P-VOL). The snapshot is maintained when the P-VOL is updated by storing pre-updated data (snapshot data) in a data pool.

system option mode (SOM)

Additional operational parameters for the RAID storage systems that enable the storage system to be tailored to unique customer operating requirements. SOMs are set on the service processor.

T

tiered storage

A layered structure of performance levels, or tiers, that matches data access requirements with the appropriate performance tiers.

U

unallocated volume

A volume (LDEV) for which no host paths are assigned.

update copy

An operation that copies differential data on the primary volume of a copy pair to the secondary volume. Update copy operations are performed in response to write I/Os on the primary volume after the initial copy operation is completed.

user group

A collection of users who have access to the same resources and have the same permissions for those resources. Permissions for users are determined by the user groups to which they belong. Users and resource groups can be assigned to multiple user groups.

V

virtual device (VDEV)

A group of logical devices (LDEVs) in a RAID group. A VDEV typically consists of some fixed volumes (FVs) and some free space. The number of fixed volumes is determined by the RAID level and device emulation type.

virtual volume (V-VOL)

A logical volume in a storage system that has no physical storage space. Hitachi Thin Image uses V-VOLs as secondary volumes of copy pairs. In Hitachi Dynamic Provisioning, V-VOLs are referred to as DP-VOLs.

volume (vol or VOL)

A name for the logical device (LDEV), or logical unit (LU), or concatenated LDEVs, that are created in a storage system that have been defined to one or more hosts as a single data storage unit.

W

write order

The order of write I/Os to the primary volume (P-VOL) of a copy pair. The data on the secondary volume (S-VOL) is updated in the same order as on the P-VOL, particularly when there are multiple write operations in one update cycle. This feature maintains data consistency at the secondary volume. Update records are sorted in the cache at the remote system to ensure proper write sequencing.

Index

Numerics

3 data center configurations 322

B

blocked path monitoring, setting 125
blocked path SIM monitoring, setting 125
business requirements, assessing 64

C

cables and switches 107
Cache and Nonvolatile Storage (NVS) 48
Cache Residency Manager 52
Cache Residency Manager volumes 49
cache-fast-write, options for 207
calculating bandwidth 100
cascade configuration with TC 323
CCI error codes 296
collecting write-workload data 64
command device, remote 330
components 22
Concurrent Copy volumes 49
configuration workflow 114
consistency group with multiple systems 48
consistency status 37, 38
copy operations, overview 29
creating
 a journal 120
 a pair 128
Cross-OS File Exchange 49

D

data consistency, how maintained in S-VOL 77
data path 105
 description 28
 planning workflow 98
Data Retention Utility 52
Data Retention Utility volumes 49
data transfer speed, planning for 65
data transfer threshold, changing 221
defining a remote path 117

deleting

a journal 219
a pair 141
a pair forcibly 208
a remote path 221
pairs from a mirror 144
UR relationship 222
delta resync 146
 configuration 327
 no differential data 36
 remote command devices 330
delta resync failure 148
differential data
 managing in shared memory 31
disaster recovery
 general procedures 239
 in 3DC cascade config 256
 switching host oper. to S-VOL 239
 when using multiple storage systems 239
Dynamic Provisioning 53
Dynamic Provisioning volumes 49
Dynamic Tiering volumes 49

E

error code 290
exporting pair information 199
extender graphic 105
external port 105

F

Fibre Channel, additional switches 108
file recovery, database recovery 239
filtering a list 194
forcibly deleting pairs 208

G

guidelines for preparing systems 83

- H**
 - hardware problems 295
 - HOLDING status and delta resync operation 36
 - host failover software 74
 - hosts supported 45
- I**
 - initial copy overview 29
 - initiator port 105
 - interoperability table 49
- J**
 - journal copy 21
 - journal obtain 21
 - journal restore 22
 - journal status definitions 202
 - journal volumes
 - adding to a journal 215
 - deleting from a journal 218
 - description 24
 - planning considerations 67
 - sizing 66
 - journals
 - assigning MP blade to 123
 - changing options 211
 - creating 120
 - deleting 219
 - description 24
 - maintenance 211
 - monitoring 202
 - planning 67
 - specifications 47
- L**
 - latency 103
 - license capacity exceeded 45
 - license capacity, displaying 194
 - license expired 45
 - local vs remote storage systems 29
 - LUN Manager 56
 - LUN Manager volumes 49
- M**
 - maximum initial copy activities, setting 124
 - measuring write-workload 65
 - mirror ID explained 24
 - mirrors
 - changing options 213
 - splitting 136
 - monitoring
 - journals 202
 - operations history 197
 - pairs 193
 - remote connections, paths 203
 - synchronization rate 196
 - moving operations to S-VOL 239
 - MP blade, assigning 123
 - multi-target configuration with TC 325
 - multiple storage systems, disaster recovery for 239
 - multiple systems in a consistency group 77
- N**
 - network relay devices, powering off 226
- O**
 - overview 20
- P**
 - packet loss 104
 - pair
 - creating 128
 - deleting 141
 - deleting forcibly 208
 - maintenance 206
 - operations history 197
 - operations workflow 128
 - options for system response to failure 207
 - resynchronizing 138
 - split option, changing 207
 - splitting 134
 - status and changing cache or shared memory 48
 - status definitions 33
 - troubleshooting 294
 - pair volumes
 - description 24
 - planning considerations 69
 - path group 46
 - point-in-time copy 137
 - ports
 - defining attributes 116
 - planning 104
 - power off, managing 223
 - prerequisites for
 - adding journal vols to a journal 215
 - deleting a pair 141
 - deleting pairs from a mirror 144
 - resynchronizing a mirror 140
 - resynchronizing a pair 138
 - splitting a mirror 136
 - splitting a pair 134
 - primary site recovery
 - resuming operations 240
 - PSUE types 38
 - PSUS types 37

R

- RAID groups, planning 65
- RAID levels supported 48
- RCU target port 105
- Recovering from failures 248
- remote command device
 - and delta resync 330
 - assigning mirrors 334
- remote path status, troubleshooting 292
- remote paths
 - additional 119
 - deleting 221
 - monitoring 203
 - troubleshooting 292
- remote replica options, setting 124
- required licenses 45
- requirements 44
- resynchronizing
 - a mirror 140
 - a pair 138
- resynchronizing journals
 - between primary and intermediate sites 253
 - between primary and secondary sites 253
- reverse copy direction to primary site 240
- RIO MIH 117
- role required for operations 114
- rolling averages and cycle time 101
- RPO 64

S

- S-VOL, taking over host operations 239
- saving pair information 199
- Service Information Messages 314
- ShadowImage volumes 342
- shared memory changes, and pair status 48
- sharing secondary volumes 345
- sharing volumes 341
- SIMs 314
- sizing bandwidth 98
- splitting a pair 134
- storage systems
 - using an earlier model 79
- strategies for sizing bandwidth 99
- supervisor DKC 77
- suspended journals 291
- switch connection graphic 105
- switches 108
- system option modes 83
- system requirements 44

T

- target port 105
- technical support 319
- Thin Image 56
- ThinImage volumes 49
- tracking journal data 37
- troubleshooting remote paths 292

TrueCopy volumes 322

U

- update consistency during failure when multiple systems used 239
- UR
 - removing pair relationship 222
 - set up 117

V

- Virtual LUN 59
- Virtual LUN volumes 49
- Volume Migration 60
- Volume Migration volumes 49
- volume types 49

Hitachi Data Systems

Corporate Headquarters

2845 Lafayette Street
Santa Clara, California 95050-2639
U.S.A.
www.hds.com

Regional Contact Information

Americas

+1 408 970 1000
info@hds.com

Europe, Middle East, and Africa

+44 (0) 1753 618000
info.emea@hds.com

Asia Pacific

+852 3189 7900
hds.marketing.apac@hds.com

Contact Us

www.hds.com/en-us/contact.html



MK-92RD8023-14

May 2017